

ck-12

flexbook
next generation textbooks

CK-12 Engineering

An Introduction for High School

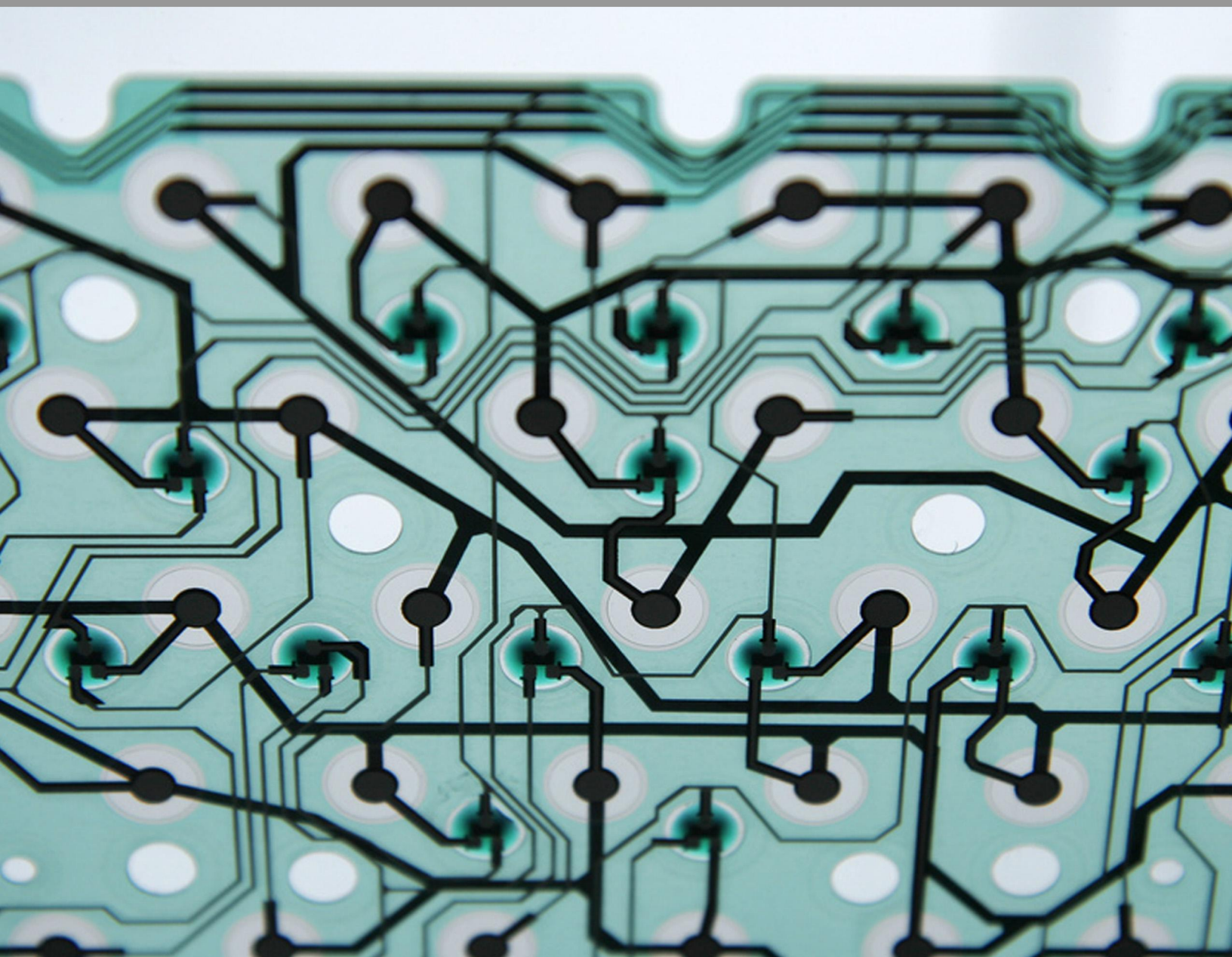

Engineering: An Introduction for High School

Dale Baker
Janel White-Taylor
Annapurna Ganesh
Tirupalavanam G. Ganesh
Stephen Krause
Chell Roberts
Darryl Morrell
Janel White-Taylor, (JanelW)
Chell Roberts, (ChellR)
Darryl Morrell, (DarrylM)
Tirupalavanam G. Ganesh,
(TirupalavanamG)
Stephen Krause, (StephenK)
Annapurna Ganesh, (AnnapurnaG)

Say Thanks to the Authors

Click <http://www.ck12.org/saythanks>

(No sign in required)

To access a customizable version of this book, as well as other interactive content, visit www.ck12.org

CK-12 Foundation is a non-profit organization with a mission to reduce the cost of textbook materials for the K-12 market both in the U.S. and worldwide. Using an open-content, web-based collaborative model termed the **FlexBook®**, CK-12 intends to pioneer the generation and distribution of high-quality educational content that will serve both as core text as well as provide an adaptive environment for learning, powered through the **FlexBook Platform®**.

Copyright © 2013 CK-12 Foundation, www.ck12.org

The names “CK-12” and “CK12” and associated logos and the terms “**FlexBook®**” and “**FlexBook Platform®**” (collectively “CK-12 Marks”) are trademarks and service marks of CK-12 Foundation and are protected by federal, state, and international laws.

Any form of reproduction of this book in any format or medium, in whole or in sections must include the referral attribution link <http://www.ck12.org/saythanks> (placed in a visible location) in addition to the following terms.

Except as otherwise noted, all CK-12 Content (including CK-12 Curriculum Material) is made available to Users in accordance with the Creative Commons Attribution/Non-Commercial/Share Alike 3.0 Unported (CC BY-NC-SA) License (<http://creativecommons.org/licenses/by-nc-sa/3.0/>), as amended and updated by Creative Commons from time to time (the “CC License”), which is incorporated herein by this reference.

Complete terms can be found at <http://www.ck12.org/terms>.

Printed: May 28, 2013

flexbook
next generation textbooks



AUTHORS

Dale Baker
Janel White-Taylor
Annapurna Ganesh
Tirupalavanam G. Ganesh
Stephen Krause
Chell Roberts
Darryl Morrell
Janel White-Taylor, (JanelW)
Chell Roberts, (ChellR)
Darryl Morrell, (DarrylM)
Tirupalavanam G. Ganesh,
(TirupalavanamG)
Stephen Krause, (StephenK)
Annapurna Ganesh,
(AnnapurnaG)

Contents

1	Introduction to Engineering	1
2	Nature of Engineering	2
2.1	About This Chapter	3
2.2	Discovering Engineering	4
2.3	What Makes an Engineer?	10
2.4	The Global and Societal Impact of Engineering	20
2.5	Conclusion	31
2.6	Vocabulary	32
2.7	References	33
2.8	Student Supplemental Resources	34
2.9	Instructor Supplemental Resources	40
2.10	References	41
3	Engineering & Society	42
3.1	About This Chapter	43
3.2	To Engineer Is Human	44
3.3	Water and Disease: A Case Study	50
3.4	Water and Engineering	55
3.5	Vocabulary	63
3.6	References	64
3.7	Instructor Supplemental Resources	65
3.8	References	73
4	Introduction to Engineering Design	74
4.1	About This Chapter	75
4.2	The Design Process	76
4.3	The Design Process in Action	82
4.4	Vocabulary	98
4.5	References	101
4.6	Instructor Supplemental Resources	102
4.7	References	109
5	Connecting Science and Mathematics to Engineering	110
5.1	About This Chapter	111
5.2	Case History: How Math, Science, and Engineering Led to the First Pocket Radio	112
5.3	What Is the Role of Science and Mathematics in Engineering?	114
5.4	How Do Math and Science Connect with Engineering in High School and College?	119
5.5	Connecting Engineering Career Fields with Science and Engineering	123
5.6	Connecting Mathematics and Science to the Engineering Design Process	127
5.7	Vocabulary	132
5.8	References	134

5.9	Instructor Supplemental Resources	135
5.10	References	137
6	A Brief History of Engineering	138
6.1	About This Chapter	139
6.2	Historical Themes	141
6.3	Engineering in Ancient Civilizations	142
6.4	Engineering in Medieval and Renaissance Europe	144
6.5	The Industrial Revolution	151
6.6	Rise of the Corporation	159
6.7	The Early Twentieth Century	165
6.8	The Computer Age	169
6.9	Potable Water (Possible Sidebar)	176
6.10	Conclusions	183
6.11	Vocabulary	184
6.12	References	187
6.13	Instructor Supplemental Resources	188
6.14	References	190

CHAPTER 1 Introduction to Engineering

Much of our modern society depends on engineered artifacts to function, but many members of modern society are not aware of the engineering techniques and practices that have developed the technology and infrastructure on which we rely. iPods, cell phones, airplanes, bridges, buildings, vehicles, computers, etc. are designed and created by engineers. This textbook introduces engineering techniques and practices to high school students. The goals of this book are to help students gain an appreciation for engineering and its role throughout human history, understand what engineers do, understand the skills and processes engineers bring to their work, and appreciate how the work of engineers shapes and is shaped by their society. The authors hope that this book may inspire students to pursue a career in engineering.

This book is a Flexbook—an open-source book developed with the support of and within the context of CK-12’s mission; the Flexbook format allows the book to be customized for multiple audiences. This engineering text is a living document that can be updated, expanded, and repurposed as necessary to support specific standards and classroom needs.

The text is written to meet draft ASEE K-12 standards for engineering. Each chapter corresponds to an outcome in the draft standard. While the standards have not yet been finalized and formally adopted, the Flexbook format allows the text to evolve in response to changes in the standards, so that the text’s content and structure will fully support them.

The text was collaboratively written by university engineering and education faculty members at Arizona State University. The text currently has four content chapters that cover the nature of engineering, engineering and society, engineering design, and the connection between engineering, science, and mathematics.

The authors are grateful to CK-12 for providing the infrastructure and support that has made this textbook possible. We see this book as a seed, and hope that it becomes a starting point on which others can build.

CHAPTER **2**

Nature of Engineering

Chapter Outline

- 2.1 ABOUT THIS CHAPTER**
 - 2.2 DISCOVERING ENGINEERING**
 - 2.3 WHAT MAKES AN ENGINEER?**
 - 2.4 THE GLOBAL AND SOCIETAL IMPACT OF ENGINEERING**
 - 2.5 CONCLUSION**
 - 2.6 VOCABULARY**
 - 2.7 REFERENCES**
 - 2.8 STUDENT SUPPLEMENTAL RESOURCES**
 - 2.9 INSTRUCTOR SUPPLEMENTAL RESOURCES**
 - 2.10 REFERENCES**
-

2.1 About This Chapter

This chapter explores the nature of engineering. As you read this chapter, you will discover: what engineers do; some of the skills needed to be an engineer; various types of engineering careers and specializations; the educational requirements to be an engineer; licensure of engineers; the impact engineering has had on society; and some possible scenarios for the future of engineering.

Chapter Learning Objectives

After working through this chapter, you should be able to

- describe what engineers do,
- describe the education and skills necessary for engineering,
- describe the impact of engineering on society.

2.2 Discovering Engineering

Who are engineers and what do they do? Why are the activities of engineers important? In this section, we will begin to discover some answers to these questions.

Some Practicing Engineers

Activity

What do you already know about engineering and engineers? Imagine an engineer at work. (You might want to get out a paper and something to write with.) What does the engineer look like? What is the engineering wearing? Where is the engineer working, and what are they doing? What does the engineer spend most of the day doing? What sorts of tools is the engineer using to help with their work? Is the engineer working alone or with others?

Capture your ideas by making a list of your answers to the questions above, or by drawing a picture of the engineer that you are imagining. When you are finished share your drawing or list with someone else. How are your lists or pictures similar? How are they different?

Continue imagining your engineer and add to your drawing or list. What sort of education does your engineer have? What sorts of classes did they take in college? What does the engineer do very well, and what does the engineer not do well? Does your engineer have an area of specialization? If so, what? How much money does your engineer make in a given year? Now share the expanded version of your engineer with someone else, and once again discuss the similarities and differences.

As we progress through the chapter, we will check to see if your ideas change.

Now that you have envisioned an engineer, let us look at some real-life profiles of practicing engineers. As you read each profile, note the attributes that you included in your picture or list and make a new list of the attributes that differ from your picture or list.

Profile 1. Ashley is in charge of product development and support for a large **electronics** product company in the Pacific Northwest. She manages two engineering teams. She is 39 years old and likes living in the Pacific Northwest because of the outdoor activities such as hiking and camping. The members of her engineering teams live in other cities and most of them live outside the United States in countries that include India, China, Sri Lanka, and Malaysia. Each location has some particular engineering advantage. For example, the United States is the best place to design products and manage product development and support; India has a very good system to support technology development and it is less expensive to develop software there; China was selected as the best place to manufacture computer chips; and Malaysia and Sri Lanka were selected to manufacture and assemble the rest of the products.

Most days Ashley works out of her home. Because her engineering team members are located all over the world, she must be available to communicate with them 24 hours a day or whenever a problem arises. To aid this global communication, Ashley's computer sounds a bell any time one of her team members sends important email or needs to talk with her directly. Since she is available 24 hours a day, her daily routine is very flexible. Ashley can usually choose her own work schedule, except when she has scheduled meetings or urgent communication demands, which might be only two or three times each week. Sometimes she spends the morning working in her garden after handling some of her morning communication (the bell also rings outside), and she also takes a break to paint most afternoons. Ashley travels to each of the team member locations one or two times each year.

**FIGURE 2.1**

One of Ashley's projects might include developing components that will be part of a satellite antenna system such as this one at the Cryptologic Operations Center in Misawa, Japan.

Ashley's most important tools are her computer and her mobile phone. She has excellent communication skills and knows how to relate to the different cultures of her team members. Ashley also has a broad knowledge of electronic product systems. Although she is not an expert in any of the individual components, she understands how each of the components works together (Figure 1).

Ashley was in college for four and one-half years studying for her engineering degree. She spent the first year at a community college before transferring to a university. Ashley liked math in high school but did not settle on an engineering major until she was in her junior year of college and had to use math to analyze and design an electronics project. Her favorite courses were those that explained how electronic devices worked. Ashley earned \$90,000 in 2006.

Profile 2. Tyson loved cars and motorcycles since he was very young; he began working on them while he was still too young to drive. His dream has always been to design cars and motorcycles. When he graduated from high school he found that his high school grades, and especially his math background, were not good enough to be admitted to a university engineering program. He worked while taking evening courses at a community college for two years before transferring into a university engineering program. Tyson found his physics courses interesting, but struggled with math. Tyson studied engineering for another four years before he graduated with an engineering degree. In school, he learned that there were very few job opportunities to actually design cars and motorcycles. However, Tyson had done a senior project using a **rapid prototyping** (RP) machine. The RP machine could automatically build almost any part that Tyson could design on a computer. He learned to create many different types of part designs on the computer using what is called computer-aided design (CAD) software. With this software Tyson could make dimensional drawings, and he spent many extra hours in the lab designing and using the RP machine to make his designs (Figure 2). After graduation, he took a job in Texas with a rapid prototyping company. Soon Tyson found that the rapid prototyping technology could be used to make expensive specialty parts, and he began working with motorcycle designers in Italy and Spain. He also found a NASCAR racing team that needed custom parts and worked with their designers.

After eight years, Tyson decided to start his own company designing and producing high-end custom motorcycle and car parts. He now lives in California and owns two sports cars and a motorcycle. Tyson, 43, earned \$285,000 in 2006. He travels out of town and out of the country two or three times a month. His most important tools are his computer that has very good CAD software and his mobile communication system. Tyson enjoys listening to his music collection while he works.

Profile 3. Raji's childhood dream was to be a dolphin trainer. She really loved biology and chemistry classes in high school, but was undecided about her college major. A guest speaker in her high school biology class described how

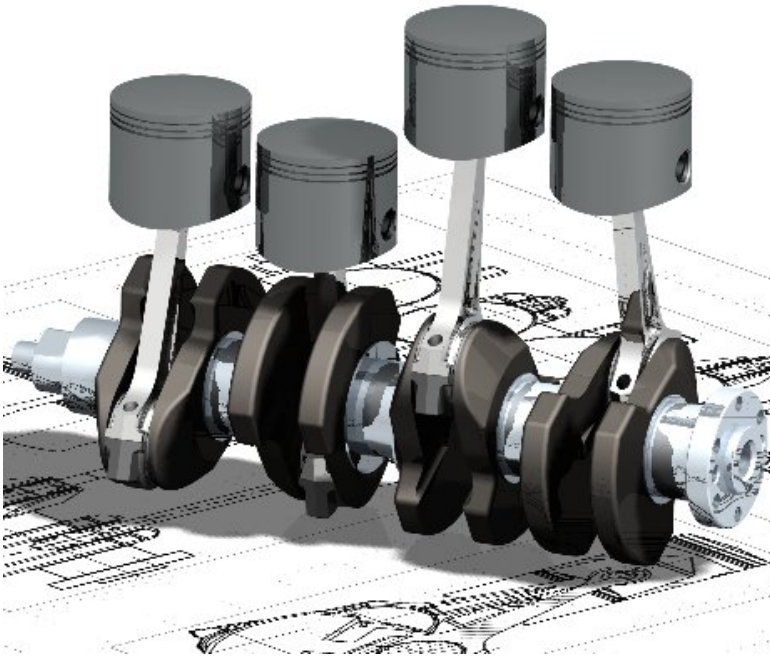
**FIGURE 2.2**

This piston assembly was designed using CAD software similar to the one Tyson used.

engineers were combining biology and technology to develop new technologies that could one day help blind people see; the speaker encouraged Raji to consider an engineering career. With her good grades, she received a college scholarship that paid for her tuition, room and board.

**FIGURE 2.3**

Bioengineers help design prosthetic limbs that allow amputees to live a more active life.

Raji earned a bioengineering degree in four years, and her favorite courses were those that included time in the bioengineering labs. In her junior year of college, because of her good grades and careful lab work, she received an invitation to work with a team of students and professors on a research project designing prosthetic limbs for amputees (Figure 3). Raji found that she really liked research. After graduating with a bachelor's degree, she decided to go to graduate school for a PhD. Raji, now 28, will complete her PhD degree next year and hopes to work

for a bioengineering company as a research engineer. She has also considered teaching at a university. Raji likes to ski and plans to begin scuba diving. Maybe Raji will finally get to swim with the dolphins.

Profile 4. Xaio grew up in Taiwan and studied many hours every day while in high school so he would be accepted into a regional college. He was very interested in how computers work and wanted to learn to design them, so he studied computer engineering in college. Xaio knew that he would be able to find a job when he finished school, but most of the jobs for computer engineers in his home region did not pay as well as similar jobs in other countries. In fact, some of the job opportunities in other countries paid more money in one year than Xaio's family made in ten years. However, such a high paying job would require a master's degree from a good school in another country, and that would be expensive. Xaio applied to schools in the United States and in Great Britain and was accepted to a good school in the United States, where he finished a master's degree in computer engineering in two years.

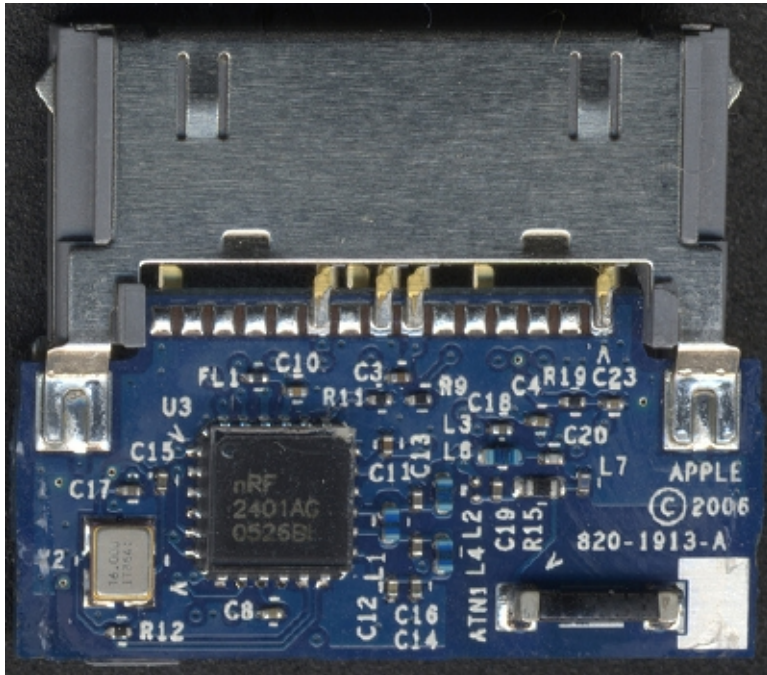

FIGURE 2.4

Designing one of the integrated circuits on this circuit board for an Apple iPod Sport is a project that Xaio might work on

Xaio has been working for an electronics design company in the United States for five years. Because of his knowledge of Taiwanese culture and language, and his knowledge of electronics design, the design company trained him in **microelectronics** manufacturing and testing. Now Xaio is a team leader for manufacturing some of the company's designs that are being made in Taiwan (Figure 4). He travels to Taiwan about four times a year. His hobbies include tennis and ballroom dancing. Xaio made \$85,000 in 2006.

Profile 5. Glenn had many interests growing up; he played on a soccer team for several years, and played trumpet in his grade school and junior high bands. In high school, he was good at math and science, but he also enjoyed playing trumpet in the marching band and competing on the swim team. As a junior in high school, he had a very difficult time deciding what his college major should be; he liked many different things, and was not sure which he wanted to pursue. Several of his teachers suggested that he consider engineering, and after visits to several colleges, he decided electrical engineering appealed to him. He started as a college freshman in electrical engineering. One year later, he decided that mechanical engineering was a better fit for his interests; he switched to mechanical engineering and graduated with a *B+* grade average three and one-half years later.

After graduation, he was hired by a large aerospace company whose primary business is Department of Defense contracts. The company provided a one-year training period in which he rotated through several different divisions of the company and became familiar with the different product lines within the company. Now he works as a member of a large team updating engine and transmission designs for a military helicopter. He enjoys the technical

challenges of his job. He plans to improve his technical expertise by starting a masters program in the next few years. He believes that this will help him move into a team leadership position.

Engineering Is Diverse and Global

Now that you have read the profiles of several different engineers and made a list of their attributes, have any of your original ideas about engineers changed? What have you discovered about engineers and engineering?

Hopefully, you have noticed that engineers are as diverse as the types of careers they pursue. They are women and men, young and old. They are **consultants**, teachers, and technical sales representatives. They work for small companies and large companies. Many start their own companies. They work in industrial plants and research labs. Some engineers work in an office; some work in production and manufacturing facilities; others spend most of their time working outdoors. And some engineers do a great deal of travel.

Engineers need a college degree, and many choose to acquire advanced specialization by pursuing a master's or PhD degree. Others choose to pursue an engineering degree because it provides them with both a solid technical background and strong critical thinking skills that support them in other fields such as law, medicine, business, and public service.

You may have also noticed that engineers can make a good income, that they often work in teams, and that those teams are composed of people from around the world. In the past ten years engineering has become a global career.

Activity

(For this exercise you need access to the Internet or a library.) Approximately 75,000 students graduated from engineering colleges in the United States following the 2005–2006 academic year. See if you can find out how many engineering graduates there were from other countries. Which countries have the most engineering graduates? Can you guess why?

Review Questions

The following questions will help you assess your understanding of the Discovering Engineering Section. There may be one, two, three or even four correct answers to each question. To demonstrate your understanding, you should find all of the correct answers.

1. Communication skills
 - a. are as important for engineers as technical skills
 - b. are not important or necessary for engineers
 - c. will help you manage your team
 - d. none of the above
2. An engineering degree
 - a. limits your career choices to specialized engineering fields
 - b. provides technical background for careers in many fields
 - c. allows you to work in a variety of settings and around the world
 - d. provides both a general technical background and a specialization
3. Engineering work is performed
 - a. mainly in the United States

- b. mainly in Europe
 - c. in countries around the world
 - d. by teams of engineers distributed in many countries
4. Engineers
- a. have no interests outside of engineering
 - b. have many interests outside of engineering
 - c. all love nature and being outdoors
 - d. drive fast cars

Review Answers

Discovering Engineering

- 1. a,c
- 2. b,c,d
- 3. c,d
- 4. b

2.3 What Makes an Engineer?

Engineers solve problems using math, science, and technology. They also design products that are useful for humans. To become an engineer you need a degree in engineering that will provide you with a broad background in math, science, and technology, as engineers use these skills to solve problems on a daily basis. Besides the broad background, engineering students also choose a specialization in some branch of engineering. Engineers in each branch have knowledge and skills that can be applied to many fields and can contribute to solving many different types of problems. Since many engineering projects encompass multiple problems to solve, engineers in one field often work closely with specialists in other fields, including scientists, other engineers, and business leaders.

Engineering Specialization

Most engineering specializations have emerged over the past 200 years as scientific knowledge in various fields has grown. Prior to that, engineering focused primarily on the construction of roads, bridges, canals, or military structures and devices.

Activity

To better understand the breadth of engineering specializations it is time to make another list. This time you do not need to do any research. Simply make a list of all of the engineering specializations or types of engineers you can think of, and write a brief description of one of those specializations. Refer to the list of engineering societies that represent different engineering specializations at the end of this chapter. How many were you able to name? Are there others that you did not write down? Was your description of the engineering specialization similar to the description listed? You may want to spend some time reading all of the descriptions to better understand the various engineering specializations.

Activity

Now that you are familiar with some of the different engineering specializations and the major societies that represent engineering, let us see if you can match an engineering design project with an engineering specialization.

An aircraft manufacturer wants to design and manufacture the world's largest airplane. What type of engineer(s) should they hire?

From reading the description of engineering specializations at the end of the chapter, your first response might be an aerospace engineer. However, did you know that there are miles of electrical wiring and thousands of electronic devices inside of an airplane such as the Airbus A380 shown in Figure 5? Therefore, it might be a good idea to hire an engineer with some knowledge of electrical systems (perhaps an electrical engineer). We probably do not want the aircraft to break into pieces under the weight of the hundreds of people or thousands of pounds of cargo inside the aircraft, so it might be a good idea to hire structural engineers or civil engineers. Today there are thousands of different materials that can be used to manufacture products so we might want to hire engineers with specialized knowledge of materials (materials engineer). Pilots need to be able to operate the very specialized equipment that controls an airplane, so you might want to hire engineers who specialize in human-computer interaction (industrial engineer). It might also be a good idea to hire systems engineers who have specialized knowledge of how the different parts of the aircraft (mechanical, electrical, structural, materials, human-computer interaction) fit and work together.

Enrichment Activity (Quick)

**FIGURE 2.5**

The Airbus A380 is the largest commercial jetliner in the world. It can carry up to 850 passengers in two passenger decks in the fuselage.

Select one of the engineer profiles in the beginning of the chapter. Write a brief report that explains what type of engineering specialization, if any, you think the engineer has.

Enrichment Activity (Medium)

To better understand the engineering specializations, go to the websites of one or more of the professional societies and read about the specialization. Write a report that describes the engineering specialization you selected.

Engineering Skills

Many employers hire engineers because of particular skills, and not because of a particular discipline, degree, or specialization. Let us explore the range of engineering skills and educational degrees that employers look for in their employees. Job advertisements usually describe a position and list the skills, experience, and education required or desired for the position. Engineering skills can be highly technical, and may include the ability to use certain types of math and science, the ability to use certain types of instruments, the ability to operate certain types of computer programs, or the ability to apply certain areas of specialized engineering knowledge.

Activity

At the end of the chapter you will find several engineering job advertisements that were posted on the Internet in 2007. As you read them, you may notice terms that are new or unfamiliar to you, particularly if the ad is describing a specialized technical skill. You may also see terms that you do understand. Read each of the job descriptions and requirements carefully. Make a list of the degree requirements for each position, the experience required for each position, and the skill requirements that you understand. Did you notice that an engineering degree was listed as a requirement in all three ads? You might have also noticed that none of the positions required a specific engineering specialization.

About half of all engineering job advertisements today do not require a discipline-specific engineering degree. Rather they require an engineering degree coupled with a set of specific skills or experience.

Two of the ads list a desired number of years of experience, and all of the ads list specific types of experience. Below you will find one example from each of the ads.

- **Ad 1:** Experience in managing complex, high-profile projects.

- **Ad 2:** Familiarity or experience in one or more of the following areas: product development, program management, imaging and printing.
- **Ad 3:** Experience in injection molding plastics

Experience is a very important qualification for most engineering jobs. Many engineering students gain experience while they are in school through internships and/or through part-time employment. Others gain employment experience after school and progress to new positions as they gain more experience.

Let us now look at some of the engineering skills with which you are probably more familiar. Did you notice that all three ads require good communication skills?

- **Ad 1:** Demonstrates strong communication skills by clearly documenting activities and presenting information, technical content and ideas through spoken and written words; listens well.
- **Ad 2:** Good communication skills
- **Ad 3:** Strong communication skills with the ability to initiate establish and maintain positive relationships with internal and external customers. Clean, accurate, precise work and documentation.

Engineers must be able to communicate their ideas to others. Engineers often make presentations, write technical reports, and interact with customers and other technical experts.

One of the ads uses the following words: “clean, accurate, precise work and documentation.” Many engineers keep detailed notebooks of their work. This helps them remember how they solved a problem, or why they chose to design a product a certain way. Do you think the Wright Brothers kept good notes while they were trying to design the world’s first airplane? They recorded every experiment, every failure, and every success. Sometimes engineering notes are used to apply for **patents** that can be quite valuable. Sometimes engineers must defend their designs when problems occur. Why do you think it would be important to have engineering notes and documentation in the case of an engineering failure, such as the collapse of a bridge or a building? One answer is that notes and documentation help engineers find the causes of failure, which ultimately leads to improved designs. Another answer is that good documentation can protect engineers against lawsuits.

All three ads also required good organizational skills.

- **Ad 1:** Defines and prioritizes realistic, specific goals; able to complete scheduled tasks in the face of changing priorities.
- **Ad 2:** Good organizational skills, multitask ability, teamwork ability a must, self-directed
- **Ad 3:** Detail-oriented, strong organization skills, time management (time lines), and deadline driven. Self-starter, motivated, and proactive.

Engineers frequently work on multiple projects simultaneously (multitasking), and most of those projects have different tasks and corresponding deadlines. Engineers also usually work with one or more teams simultaneously, where each team member has different skills and responsibilities. Task deadlines are critical to the success of most projects. Sometimes missing a deadline can cause an entire project to be cancelled, or may result in the loss of significant revenue. For example, imagine that you are on a team designing a new video game controller. If you do not finish the design, testing and manufacture of the product, your company may miss the holiday season in which the majority of product sales will occur. Or perhaps your company knows that another firm is also designing a new video game controller and that the first company to get their product to market is likely to acquire the most customers.

Enrichment Activity (Medium)

Look at five engineering job openings on a job posting website or in the newspaper and list the specific qualifications of those five positions. Are there qualifications that they all have in common?

Enrichment Activity (Medium)

Identify one or two engineering skills from the advertisements below that interest you, and do some research to explain the nature and details of that skill.

One ad listed the following requirement:

- **Ad 1:** Uses a logical, systematic approach to solving problems through analysis and evaluation of alternate solutions.

Engineers learn to solve problems using a careful systematic problem-solving approach. Note that the requirement also states, “. . . and evaluation of alternative solutions.” Usually, there is more than one solution to a problem.

Activity

A fire has been burning in a coal mine for several years in the northeastern United States. As shown in Figures 6 and 7, the fire is completely underground; smoke rises through cracks in the ground in some areas and the ground has collapsed in several locations. There are many potential solutions to this problem: we could fill the mine with water; we could try to smother the fire by cutting off oxygen; or we could just let it burn.

There are many possible solutions to most problems, and in order to ensure the best solution is selected it is important that engineers evaluate each and every alternative. In the situation above, which of the solution to the mine fire do you think would cost the most? Which solution would cause the most harm to the environment or to the people that live in the area? Which solution is most likely to actually put out the fire? These are the sorts of questions engineers must answer to arrive at an optimal solution. The solution that was actually chosen for the mine fire was to let the fire continue to burn.



FIGURE 2.6

A fire in an underground coal mine in Centralia, Pennsylvania, has been burning since 1962.

**FIGURE 2.7**

Smoke rising up through cracks in the pavement caused by the intense heat of the fire burning below.

Engineering Education

In 2006 there were approximately 350 engineering colleges or schools in the United States and Canada. There are hundreds more in other countries. Most engineering colleges or schools have multiple engineering programs that offer degrees in different engineering specializations. For example, Arizona State University (ASU) in Tempe and Mesa, Arizona, offers the following 12 engineering and engineering technology degrees. In addition, within many of these degrees are specialized concentrations or focus areas.

- Aerospace Engineering
- Bioengineering
- Chemical Engineering
- Civil and Environmental Engineering
- Computer Engineering
- Electrical Engineering
- Electronics Engineering Technology
- Engineering (multidisciplinary)
- Industrial Engineering
- Manufacturing Engineering Technology
- Mechanical Engineering
- Mechanical Engineering Technology

Engineering programs are usually accredited by an organization outside of the university. Accreditation is like a stamp of approval, indicating that the engineering program has been evaluated, and that it meets standards for a quality process, adequate resources, and an appropriate engineering curriculum. The largest accreditation organization for engineering programs is ABET. In 2007, ABET accredited more than 2,700 different programs in engineering, technology, applied science, and computing.

ABET requires that all engineering programs demonstrate that their students attain the outcomes shown in Table 1. These outcomes are quite general, and are needed by almost any engineer. In addition to these outcomes, there are specific outcomes required by each engineering discipline. Thus, electrical engineering students must demonstrate the ability to design complex electrical and electronic systems; mechanical engineering students must demonstrate

the ability to design and realize thermal and mechanical systems. Finally, each engineering program may have outcomes that are specific to the program; for example, these outcomes may address the needs of companies or industries that hire the program's graduates. If you study engineering in an ABET-accredited program, you will spend part of your time pursuing each of these different outcomes.

TABLE 2.1: Student outcomes required by ABET of every engineering program.

- an ability to apply knowledge of mathematics, science, and engineering;
 - an ability to design and conduct experiments, as well as to analyze and interpret data;
 - an ability to design a system, component, or process to meet desired needs within realistic constraints such as economic, environmental, social, political, ethical, health and safety, manufacturability, and sustainability;
 - an ability to function on multidisciplinary teams;
 - an ability to identify, formulate, and solve engineering problems;
 - an understanding of professional and ethical responsibility;
 - an ability to communicate effectively;
 - the broad education necessary to understand the impact of engineering solutions in a global, economic, environmental, and societal context;
 - a recognition of the need for, and an ability to engage in life-long learning;
 - a knowledge of contemporary issues;
 - an ability to use the techniques, skills, and modern engineering tools necessary for engineering practice.
-

To prepare to study engineering in college, you should get a good foundation in high school in math and science. Look at Outcome (a) in Table 1 (an ability to apply knowledge of mathematics, science, and engineering). In most college engineering programs, students study chemistry, physics, higher math (either calculus or discrete mathematics), and possibly biology; so you need to be prepared to enter into college-level study in these areas. You will be best prepared if you take high school courses in all of these areas. In addition, it is helpful if you are ready to start calculus while in your first year in college.

Completing an engineering curriculum can be challenging and will probably require many hours of study outside of the classroom. Most undergraduate engineering programs are designed so that you can complete a bachelor's degree in four years. Because they were not well prepared in high school or do not stay on track as a full-time student, many students, however, take five or more years to complete their degrees.

Completing an engineering degree with good grades opens up many possible gratifying career paths. A engineering degree provides the foundation for the types of careers discussed in the profiles in the section "Some Practicing Engineers." Many graduates of engineering programs also move into technical sales or engineering management positions within the first ten years of their careers. In addition, an engineering degree provides an excellent starting point for graduate education. Many people with a bachelor's degree in engineering choose to pursue a master's degree in an engineering specialization to gain advanced and deep knowledge. A bachelors degree in engineering also provides a good foundation for an advanced degree in law, business, or even medicine.

Enrichment Activity (Long)

Identify two different university engineering programs, preferably at different schools. Research the admission requirements and the classes you would be expected to take in the first two years of the program. How many of these courses are math, science, and engineering courses? See if you can identify the courses in each of these areas.

Engineering Licensure

Many engineers choose to become licensed as a professional engineer (PE). While licensure is not required for the majority of engineering careers, only licensed professionals are allowed to offer their services to the public and sign and seal plans for the public. Some engineers who are not required to hold a professional license choose to do so for other reasons; for example, some do it to demonstrate that they have accomplished a recognized standard. It may also be advantageous when seeking or changing employment opportunities, as the PE certification sets a candidate apart from other nonlicensed engineers.

The requirements for engineering licensure are determined by each state, and therefore vary somewhat from state to state. Despite the variations, there is a standard process. The first step is to graduate from an ABET-accredited engineering program. The second step is to take the engineering fundamentals exam (FE) that covers the fundamental engineering sciences that are studied in engineering school. The third step is to acquire experience through employment, the criteria for which varies from state to state. The final step is to take the engineering professional examination.

Review Questions

The following questions will help you assess your understanding of the Discovering Engineering section. There may be one, two, three, or even four correct answers to each question. To demonstrate your understanding, you should find all of the correct answers.

1. Engineers often work closely with

- a. other engineers
 - b. business people
 - c. teachers
 - d. the public
2. In the past 200 years, engineers have specialized because
 - a. there were too many people in one field of engineering
 - b. the space program needed more inventions
 - c. knowledge of science and technology has increased
 - d. they could make more money as a specialist
 3. If you were an aircraft manufacturer which engineers would you need to hire?
 - a. Structural
 - b. Electrical
 - c. Aerospace
 - d. Material
 4. An engineering skill is
 - a. the same as an engineering specialty or discipline
 - b. the ability to use certain kinds of instruments
 - c. the degrees you have earned such as a master's degree
 - d. the number of years you have worked at an engineering firm
 5. Engineering experience can be gained by
 - a. taking extra courses
 - b. reading outside of class
 - c. taking things apart at home
 - d. internships
 6. Engineers use their communication skills to
 - a. apply for jobs
 - b. make presentations
 - c. interact with customers
 - d. ask for a raise
 7. Engineers keep a notebook to document their work so that they have
 - a. data to gain a patent
 - b. data for lawsuit
 - c. information to review their designs when problems occur
 - d. data to prove hours worked
 8. Engineers work
 - a. only in very large companies
 - b. only with other engineers
 - c. almost always alone
 - d. in one or more teams
 9. Engineering teams consist of engineers with different
 - a. responsibilities
 - b. skills
 - c. designs
 - d. deadlines
 10. Engineering problems have

- a. one best solution
 - b. partial solutions
 - c. more than one solution
 - d. complex solutions
11. Engineering programs are accredited by an organization called
- a. ENGG
 - b. ASU
 - c. NSF
 - d. ABET
12. Students in engineering programs must have
- a. an understanding of professional and ethical responsibility
 - b. knowledge of contemporary issues
 - c. a broad education
 - d. ability to engage in lifelong learning
13. Most engineering societies
- a. help engineers find employment
 - b. have a strong educational component
 - c. require advanced degrees for membership
 - d. are sponsored by businesses
14. A well-prepared student who studies engineering full time will take
- a. as little as two years to complete a degree
 - b. five plus years to complete a degree
 - c. six years to complete a degree
 - d. four to five years to complete a degree
15. Calculus is important to engineering. Students who do not take calculus in high school
- a. can never become an engineer
 - b. should take calculus in their first year of college
 - c. can skip calculus if they have taken algebra
 - d. can substitute physics for calculus
16. Courses in an engineering major may include
- a. calculus
 - b. physics
 - c. chemistry
 - d. biology

Review Answers

What Makes an Engineer?

1. a,b
2. c
3. a,b,c,d
4. b
5. d
6. b,c

7. a,c
8. d
9. a,b
10. c
11. d
12. a,b,c,d
13. b
14. d
15. b
16. a,b,c,d

2.4 The Global and Societal Impact of Engineering

Engineering has had an impact on all aspects of society. Look around you and notice all of the things that have been made by humans. Through designing, manufacturing, testing, or selling, an engineer probably had something to do with most of these human-made items.

Great Engineering Achievements

Activity

Can you think of some great engineering achievements? Take a few moments to make a list of some of the most important things engineers have developed. It might help to think of things that have changed the way that people live. For example, a century ago people relied on candles and lanterns for light. How has this changed? When you are finished making a list, share it with someone else and find out what they think are the most important engineering accomplishments.

Now that you have a list of great engineering achievements, see what others have identified as the most important accomplishments of this century. In the following, you will find several figures, each representing a significant engineering accomplishment of the twentieth century. Look at each figure carefully and try to determine what engineering accomplishment it represents. Check to see if you have the accomplishment on your list. If it is not there, add it. Each accomplishment is briefly discussed after the figure.

The National Academy of Engineering (NAE) has identified the top twenty engineering achievements of the twentieth century. The NAE has created a webpage (<http://www.greatachievements.org/>) which describes these achievements and the impacts that these achievements have in the everyday lives of people. Many of these achievements are so commonly used in our society that we take them for granted. We describe ten of the twenty achievements; the other ten achievements can be found at the NAE webpage.



FIGURE 2.8

The skyline of the Pudong New Area in Shanghai, China at night.

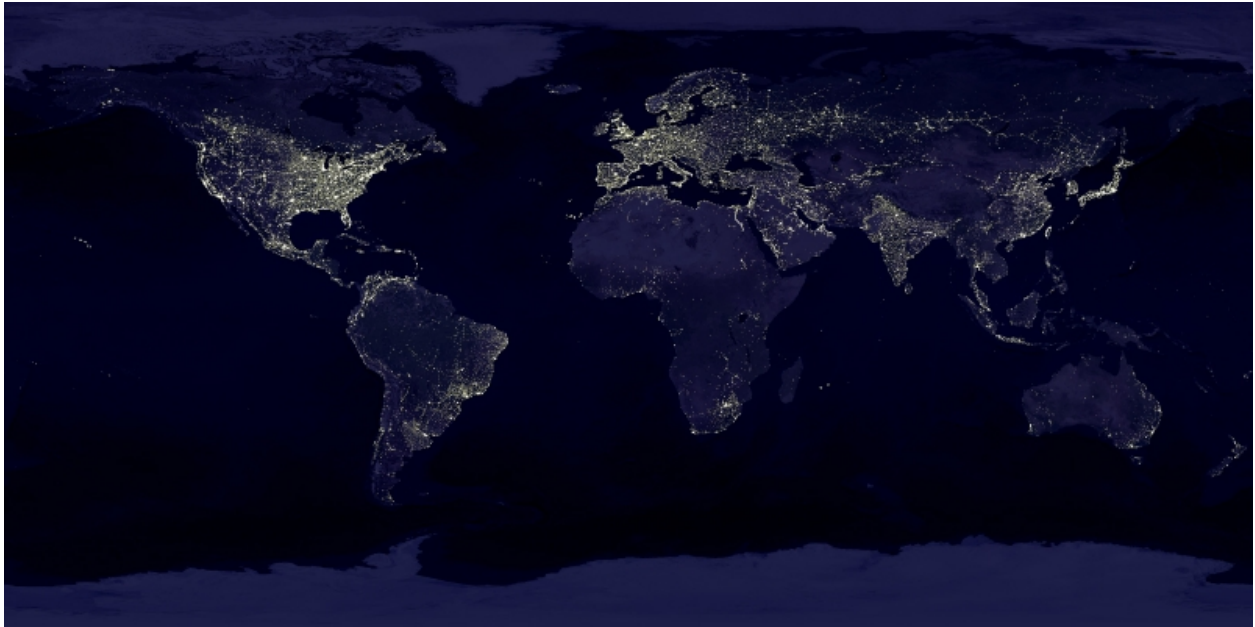
**FIGURE 2.9**

The lights of major cities around the world are visible from space at night.

Figure 8, showing the bright lights of the Pudong New Area in Shanghai, China, and Figure 9, showing lights visible from space at night, represent electrification. Electrification is the process of making electricity available to large numbers of people. We use electricity not only for light, but also to power machinery, instruments, and appliances. How many electric or battery powered devices do you use in a day? Without electrification, we would not have any of these devices today.

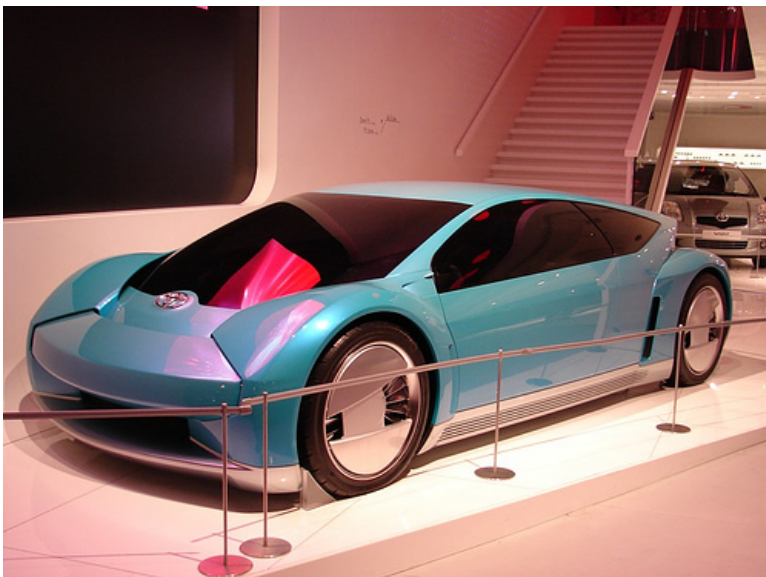
**FIGURE 2.10**

A Toyota concept car.

Figure 10 shows a rather high-tech looking automobile. The first cars produced in the United States were sold in 1901, primarily as novelties to the wealthy. However, by 1920 automobiles were mass-produced. Prior to the automobile people worked close to where they lived; one had to live in the city in order to work in the city, as the largest distance that it was practical to travel regularly was only a few miles. A farm or a factory that was not close to a city could not easily transport goods to market. Thus the automobile is credited with freeing people from the limitations of geography and with greatly contributing to raising incomes and wealth.

**FIGURE 2.11**

A high flying jet aircraft leaves contrails in the sky. A contrail is the white streak (or cloud) formed behind a high-flying aircraft's engines.

Figure 11 shows a jet aircraft and its contrails as it flies high in the sky. Airplanes further freed people from the constraints of geography by making rapid long-distance travel possible. Airplanes are also responsible for advancing a global economy.

Figure 12 shows a water faucet, and represents the supply and distribution of clean water. Clean water has had a significant impact on human life. During the 1700s and 1800s, thousands of people died from diseases including cholera, typhus, and waterborne typhoid fever, and thousands upon thousands became ill. A clean water supply and good distribution not only improved health, but also contributed to the growth of new cities, the development of hydropower, the improvement of crop growth, and the availability of water recreation.

Figure 13 shows an electronics workshop. Our world is filled with electronic devices, including computers, mobile phones, music players, cameras, calculators, ATMs, and televisions to name a few. We use electronics for communication, entertainment, manufacturing, to diagnose disease, to help us drive our cars, and for thousands of everyday activities.

Figure 14 shows an early television, manufactured in 1953. Radio and television are electronic devices that deserve special attention because of their impact on the way news and information are communicated. Prior to the development of these technologies, news and information traveled slowly, through written forms of communication. Today, the television allows people to view world events in real time. With its hundreds of channels, people can also experience other lands and cultures and be entertained.

Figure 15 shows an irrigation system for a large farm, and represents agricultural mechanization (the development of machines that help farmers produce crops). Prior to the development of farm equipment, farmers relied on animals to help them plow their fields. The planting, watering, and harvesting of crops was all done by hand. The amount of work required to produce crops limited the crops that individual farmers could grow. This also meant that many people were employed in farming and many families grew their own produce. Machines made it possible for a single farmer to produce larger quantities of crops, as well as a more consistent quality of crops. This, in turn, provided

**FIGURE 2.12**

Clean drinking water flowing from a faucet.

greater supplies of food for society, and reduced its cost.

Figure 16 shows an early computer. Computers change the way we communicate. Computers help us write; this chapter has been written, formatted, and distributed by computer. In engineering and science they perform complex computations; there are many problems, such as weather prediction, that require billions of computations. Without computers, we could not do these complex calculations. Computers are also used to control machines. Computers help guide and fly airplanes; they control the engine in your car. Computers can store vast amounts of information that is readily available, and they connect us to the world through the Internet. Computers facilitate learning, and provide us with a great source of entertainment.

Figure 17 shows a woman drinking water through a filtration straw, and represents an example of healthcare technology. The specialized straw is capable of filtering harmful bacteria and parasites from polluted water supplies. In the past decades, there have been numerous healthcare technologies developed that have decreased **mortality rates**, increased life spans, and contributed to a better quality of life. These technologies include advanced surgical techniques, artificial organs, instruments that can diagnose ailments, and preventive healthcare devices.

Figure 18 may be the most difficult to discern. The picture shows the side of a large building with air-conditioning

**FIGURE 2.13**

An electronics workbench.

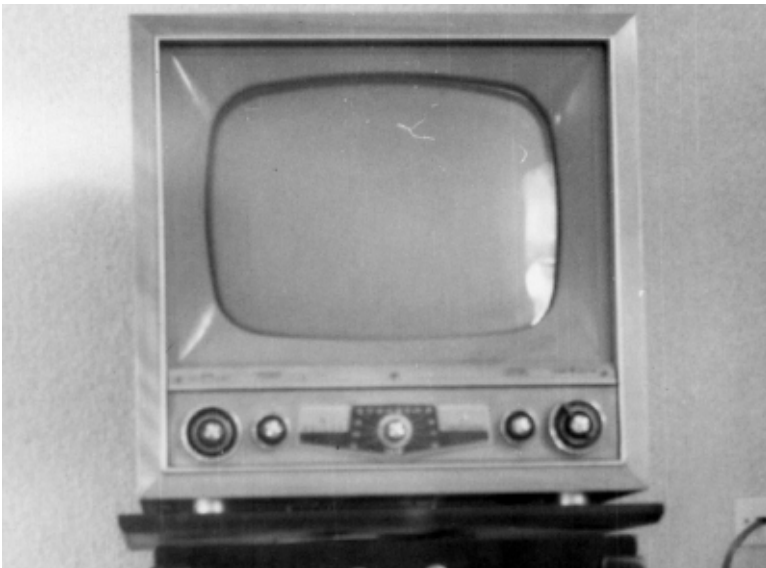
**FIGURE 2.14**

A television that was manufactured in 1953.

units on many windows. Air-conditioning was originally developed to help cool manufacturing processes. In the mid-1900s, home air-conditioning was developed, fueling an explosive growth in Sunbelt cities such as Las Vegas, Houston, and Phoenix. Air-conditioning has changed our work environments, permitting us to work in greater comfort. It has also shifted the patterns of seasonal work and play.

The ten other great engineering accomplishments of the twentieth century identified by the NAE include highways, spacecraft, the Internet, imaging, household appliances, health technologies, petroleum and petrochemical technologies, laser and fiber optics, nuclear technologies, and high-performance materials.

Enrichment Activity (Medium)

Write a brief report about one of the great engineering achievements of the twentieth century from the list earlier in this chapter. Give some specific examples of how the achievement has changed the way that people live and explain

**FIGURE 2.15**

An irrigation system waters growing cotton plants.

**FIGURE 2.16**

An HB85B computer, manufactured in the early 1980s.

why the achievement is important.

The Impact of Engineering

To understand the impact of engineering on society we can imagine how people lived 100 years ago before these technologies existed. For example, how did people communicate without telephones and the Internet? The primary method of long-distance communication was letters. While letters are a wonderful means of communication, they take time to write and even more time to be delivered. If the distance between sender and recipient was great, it may have taken months to deliver a letter via Pony Express (Figure 19).

Advancements in communication have also helped change the way many companies work today. Remember the profile of Ashley, our first engineer? Ashley works at home managing two engineering teams from across the world. That would not have been possible with letters. Engineering solutions have continually improved the quality of life,

**FIGURE 2.17**

The LifeStraw is a water purification device designed to filter bacteria out of water and is powered by suction. Water is passed through an iodine-coated bead chamber that kills bacteria and parasites. It costs around \$3.75 and can last for a total of 700 liters of water.

added business value, and significantly influenced the **global economy**.

Engineering has both intended and unintended consequences. For example, air-conditioning makes comfortable life possible in much of southern United States. However, sometimes the unintended consequences of new technologies can be negative. About a decade ago, scientists discovered that Freon and similar gasses used in air conditioners were contributing to damage to the Earth's protective ozone layer. As a result, new gasses and technology had to be developed. Consider as well the impact on culture from air conditioners. Prior to air-conditioning, many people sat on their front porch in the evenings, in part because their homes were too hot. Also, people often had very high ceilings—a design intended to help with home cooling.

Another example of unintended consequences is several years ago a company developed corn seeds that were highly resistant to weed killers and insects so that farmers would not need to spray poisons on their fields. An unintended consequence was that the new type of corn seed, after it had been growing for several years, started growing in fields where it had not been planted. Farmers tried to kill the unwanted corn plants but were unable to do it because the corn was resistant to the poisons.

The Future of Engineering

It is very difficult to predict the future of engineering, but engineers attempt this whenever they design new products. Engineers try to determine what people will want and need—both now and in the future—and then they design



FIGURE 2.18

Walls of apartment buildings.

things to fulfill those wants and needs.

While we do not know exactly what will happen in the future, we can examine some possible scenarios. Consider natural catastrophes. There have been many significant catastrophes in the past decade including powerful hurricanes, earthquakes, and tsunamis that have killed hundreds of thousands of people and destroyed a great deal of property. If we go back further in the history of the world we also find that major volcanic eruptions and rare collisions with meteorites have impacted the entire planet. Engineers are working on ways to protect people and property from these disasters as well as ways to predict and respond rapidly to these types of disasters.

Another threat to people's well being comes from disease. Between 1300 and 1500, the bubonic plague killed between one-third and one-half of Europe's population. Later, cholera killed large numbers as well. Today, these diseases have been largely eradicated in the developed world through engineering of clean water and sanitation systems. However, the world currently faces an AIDS epidemic (Figure 20), and there are likely to be new disease threats in the future. Engineers will work with scientists, governments, and health workers to develop and implement technologies that will prevent and respond to these threats.

Another certain need that will be met by engineering is energy. Because all people in the world need energy, the



FIGURE 2.19

Before the telegraph, telephone and automobile, messages were sent by horseback. This figure shows the official seal of the Post Office Department, the predecessor of the United States Postal Service.

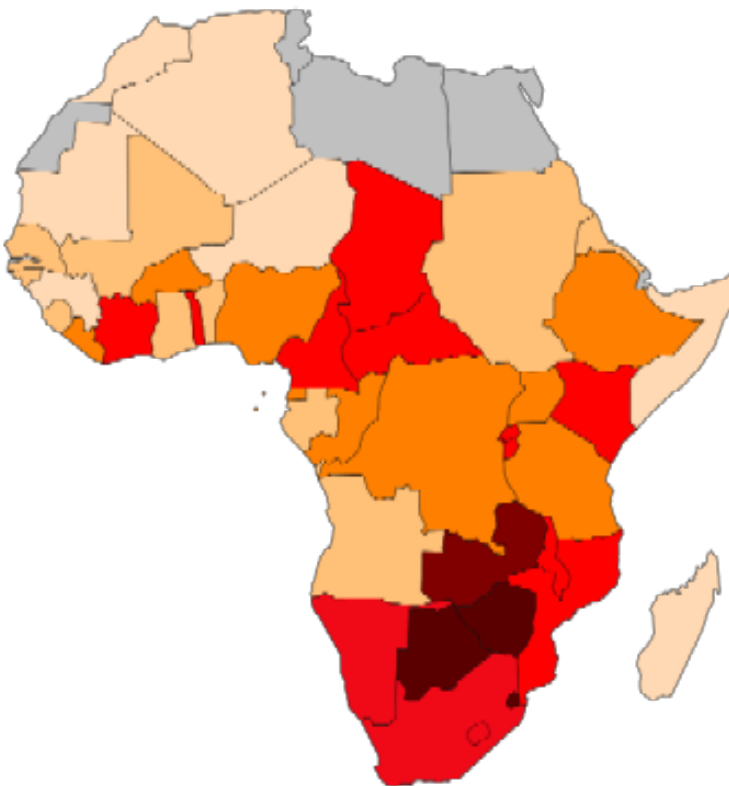

FIGURE 2.20

Percentage of adults (ages 15-49) in Africa infected with the HIV/AIDS virus in 1999. Percentage of adults (ages 15-49) in Africa infected with the HIV/AIDS virus in 1999. The countries highlighted in light colors had less than 2% infected, while the countries highlighted in dark colors had over 20% and up to 30% infected. Grey countries had no data available.

world production and use of energy is growing at a rapid pace. You might recall that both electrification and the automobile were listed as great engineering achievements of the twentieth century. Fossil fuels, the source of energy used most often to produce electricity and to power automobiles, also causes pollution and contributes to global warming. Also, supplies of fossil fuels are limited and becoming more expensive. Some wonder if the world can sustain the current energy growth and consumption patterns. With only a few countries owning the majority of energy resources, there is further concern about the supply of energy at prices that most people can afford. Engineers and scientists are working on developing new energy technologies for the future.

Some emerging trends in engineering are in the areas of biotechnology and nanotechnology. In the area of biotechnology, engineers are working on designs that impact the human body, animals, and plant life. Engineers and scientist are working on technologies to help the blind to see, the hearing impaired to hear, and the disabled to walk. Biotechnology has also opened the possibility of controversial areas such as cloning. Engineers are also working with scientist to develop crops and processes that can be used as fuels for energy.

Nanotechnology refers to the development of products and components that are very small, typically between 1 and 100 nanometers. A nanometer is 1×10^{-9} meters. A nanometer is so small that it takes a very powerful microscope to see an object of that size. While the area of nanotechnology is very new, it shows promise to provide new technologies ranging from lighter and stronger materials to nanorobots that can repair individual cells to new treatments for cancer.

Enrichment Activity (Long)

Envision the future by designing and drawing a picture of a new product. Explain what need or purpose the new design is fulfilling. Ask others to review your design and give you some feedback. Then use the feedback to redesign your product.

Review Questions

The following questions will help you assess your understanding of the Discovering Engineering Section. There may be one, two, three or even four correct answers to each question. To demonstrate your understanding, you should find all of the correct answers.

1. An emerging area of engineering is
 - a. nanotechnology
 - b. geotechnology
 - c. aerotechnology
 - d. retrotechnology
2. Electrification is
 - a. generating and distributing electricity to many different users
 - b. being shocked by electricity
 - c. powering machinery, instruments, and appliances with electricity
 - d. not an important engineering accomplishment
3. The automobile and jet airliner
 - a. have freed people from the limitations of geography
 - b. are both important engineering accomplishments
 - c. have the same type of engines
 - d. are dangerous and should be abandoned
4. Computers

- a. provide us with entertainment
 - b. control machines
 - c. perform complex computations
 - d. store vast amounts of information
5. Air-conditioning
- a. has not had any unanticipated negative consequences
 - b. contributed to damage of the Earth's ozone layer
 - c. was originally developed for use in automobiles
 - d. makes life comfortable in the southern United States
6. The future of engineering is
- a. easy to predict
 - b. determined by engineers trying to design things to fulfill people's wants and needs
 - c. tied to energy production
 - d. not affected by natural disasters

Review Answers

The Global and Societal Impact of Engineering

1. a
2. a,c
3. a,b
4. a,b,c,d
5. b,d
6. b,c

2.5 Conclusion

In this chapter we have explored the nature of engineering through the profiles of several practicing engineers, through engineering job advertisements, and through some of the great accomplishments of engineers. We have explored some of the very broad sets of engineering careers and tasks. We have also discussed the most common engineering specializations of today. These activities establish a foundation for understanding the impact of engineering on our society. We have also examined several trends to help us understand the future of engineering. And finally, we have explored the educational requirements and licensure of engineering.

2.6 Vocabulary

Consultant

A person who gives professional or expert advice.

Electronics

The development and application of devices and systems involving electricity.

Global economy

The international spread of trade and commerce across national boundaries with minimal restrictions from governments.

Microelectronics

The design, development, and construction of electronic systems from extremely small components.

Mortality rate

A measure of the number of deaths in a population during a given time period in general or due to a specific cause.

Patent

The exclusive rights granted by a government to an inventor to manufacture, use, or sell an invention for a certain number of years.

Rapid prototyping (RP)

The automated construction of physical objects under computer control using specialized equipment.

2.7 References

- ABET, Inc. “ABET.” Downloaded July 2008. Available on the web at <http://www.ABET.org>.
- ABET, Inc. “ABET History.” Downloaded July 2008. Available on the web at <http://www.abet.org/History/>
- Josh Brancheau, Abi Wharton, and Firuz Kamalov. “The History of the Automobile.” New Vista High School. Downloaded July 2008. Available on the web at <http://13d.cs.colorado.edu/systems/agentsheets/New-Vista/automobile/history.html>
- National Academy of Engineering. “Greatest Engineering Accomplishments of the 20th Century.” Downloaded July 2008. Available on the web at <http://www.greatachievements.org/>.
- National Council for Engineering Examiners. “Licensure for Engineers.” Downloaded July 2008. Available on the web at <http://www.ncees.org/Licensure.php>
- Sunny Auyang. “History of Engineering.” Harvard University Press. Downloaded July 2008. Available on the web at <http://www.creatingtechnology.org/history.htm>
- Wikimedia Foundation, Inc. “Bubonic Plague.” Wikipedia, The Free Encyclopedia. Downloaded July 20, 2008. Available on the web at http://en.wikipedia.org/w/index.php?title=Bubonic_plague&oldid=226844485

2.8 Student Supplemental Resources

Engineering Job Opportunities from the Internet August 2007

Each of the following engineering job opportunities was posted on the Internet in August 2007.

Job Description 1

Engineer, Manufacturing

SPECIFIC DUTIES:

- Develops, implements and maintains methods, operation sequence and processes in the manufacture or fabrication of parts, components, subassemblies and final assemblies.
- Interfaces with design engineering in coordinating the release of new products.
- Estimates manufacturing cost, determines time standards and makes recommendations for tooling and process requirements of new or existing product lines.
- Maintains records and reporting systems for coordination of manufacturing operations.

OTHER REQUIREMENTS:

- Uses a logical, systematic approach to solving problems through analysis and evaluation of alternate solutions.
- Acts in a professional manner even when dealing with time demands and/or interpersonal conflict.
- Maintains a flexible approach toward task scheduling.
- Demonstrates strong communication skills by clearly documenting activities and presenting information, technical content and ideas through spoken and written words; listens well.
- Follows through on tasks to completion.
- Defines and prioritizes realistic, specific goals; able to complete scheduled tasks in the face of changing priorities.

QUALIFICATIONS:

- BS in Engineering plus related experience; two years for Eng; four years for Sr. Eng.
- Sound knowledge of manufacturing techniques and process control.
- Familiarity with the process of integrating technical designs into a production environment.
- LEAN Six Sigma implementation experience.
- Experience in managing complex, high profile projects.
- Knowledge of SAP applications is a plus.

Job Description 2

Media RD Engineer (Electronics Industry)

JOB DESCRIPTION

- Technical position specializing in large format printing LF Media development and testing. This person will be responsible for RD deliverables during the New Product development process and also be in charge of the Large Format Image Permanence Activity.

- New Product Development is driven by cross-functional teams and requires the ability to work cooperatively and coordinate activities across the organization. This position will interact often with marketing, sales, manufacturing, Printer development teams, strategic manufacturing sites, and customers, as well as other internal personnel in conducting product and application training.
- Max. 25% travel.

REQUIREMENTS/QUALIFICATIONS

Musts:

- A self-motivated, success oriented, and the will to deliver against goals.
- Strong team interaction ability
- Strong technical skills
- Familiarity or Experience in one or more of the following areas:
 - Product Development
 - Program Management
 - Imaging and Printing
 - Image Permanence (Fade and Durability Testing)
 - Imaging materials manufacturing and testing
- BS degree in an Engineering discipline.
- Large Format printing experience - large format printing, graphic production processes, applications testing and materials selection.
- Demonstrated test development, specification establishment and troubleshooting experience.
- Intermediate computer/digital workflow skills
- Good communication skills
- Good organizational skills
- Multi-task ability
- Self-directed
- High energy
- Teamwork ability a must

Strongly Desired:

- Ability to operate large format printers is desired. Ability to develop application relevant test methods and make recommendations for improvements is a plus.
- Demonstrated ability to work well across cultural boundaries as well as multiple geographical sites and time-zones.

Job Description 3

Eyewear Test and Development Engineer

DESCRIPTION

- Interface with Designers, Research Engineers, Manufacturing Engineers and Quality in testing raw materials, prototypes and pre-production samples for manufacturing process implementation and production hand-off.
- Define, track and execute testing deliverables to ensure timely test results based on product timelines.
- Support the field-testing program which provides detailed, meaningful feedback from real-world testing.
- Be able to identify and troubleshoot processes of experimentation, redesign experiments accordingly, and design valid experiments to ensure 'killer' data.
- Identify and solve problems found through materials, product and process testing.
- Research on materials and material specifications, process technology, concepts, and new testing equipment and methods.

- Support the research, testing and implementation of manufacturing processes and parameters with appropriate work instructions and documentation.
- Identify critical process variables and parameters to develop and design experiments accordingly.
- Work in RD lab on designing and/or implementing tests on mechanical and physical properties as well as performance properties on all related raw materials. Raw materials include: polymers, coatings and metal alloys.
- Document all testing, results, and other information pertinent to product development.
- Responsible for Design of Experiment (DOE)
- Collect data.
- Set-up test methods.
- Take ownership and manage project from beginning to end under the direction of the RD manager.
- Responsible for full product testing.

REQUIREMENTS

- Degree in technical field (i.e. mechanical engineering, physics, chemistry, polymer/materials science) and 3–5 years of related work experience OR 6–10 years related work experience with formal technical training/certification.
- Strong communication skills with the ability to initiate, establish, and maintain positive relationships with internal and external customers.
- Experience in researching, developing and manufacturing plastics, coatings, and metal alloys.
- Experience in injection molding plastics.
- Experience with forming, casting, injecting, coating and testing metal alloys.
- Experience in mechanical and physical testing procedures to apply results to final decision making.
- Experience in executing field-testing during product development for 'real world' feedback.
- Requires minimal direction in executing test, experiments, test parameters, and collection of data and research.
- Detail oriented, strong organization skills, time management (timelines), and deadline driven.
- Clean, accurate, precise work and documentation.
- Self-starter, motivated and proactive.
- Natural inclination to think outside the box.
- Knowledge of statistics, mathematics, physics, and critical thinking skills.

Major Engineering Societies

TABLE 2.2:

Society

Aerospace Engineering:

<http://www.aiaa.org/>

American Institute of Aeronautics and Astronautics (AIAA)

Society Information

AIAA is a leading advocate for aerospace among government decision-makers—and a trusted information resource for the media on all subjects relating to aerospace technology. Since 1972, AIAA has contributed extensive technical expertise and policy guidance to Congress and the Executive Branch. We testify before the House and Senate on the full spectrum of aerospace issues.

TABLE 2.2: (continued)*Society***Agricultural Engineering:**<http://www.asabe.org/>

American Society of Agricultural and Biological Engineers (ASABE)

Architectural Engineering:<http://content.aeinsteinstitute.org/inside/intro.html>

Architectural Engineering Institute (AEI, part of ASCE)

Automotive Engineering:<http://www.sae.org/servlets/index>

Society of Automotive Engineers (SAE)

Biomedical Engineering:<http://www.bmes.org/>

Biomedical Engineering Society (BMES)

Chemical Engineering:<http://www.aiche.org/>

American Institute of Chemical Engineers (AIChE)

Society Information

ASABE is an educational and scientific organization dedicated to the advancement of engineering applicable to agricultural, food, and biological systems. Agricultural, food, and biological engineers develop efficient and environmentally sensitive methods of producing food, fiber, timber, and renewable energy sources for an ever-increasing world population.

AEI is the home for all professionals in the building industry. They provide a multidisciplinary national forum for members of but not limited to the architectural engineering, structural, mechanical, electrical, and architectural communities. Recognizing the necessity for a place to examine issues and exchange views and information with one another. AEI works to facilitate the crucial communication among members of the building team, both on a technical basis and in the professional arena.

SAE was founded for the purpose of advancing mobility on land, sea, air, and space. Many years ago, SAE noticed that graduating engineers were well versed in textbook knowledge and engineering theory. Surprisingly, however, college engineering curricula provided no ways for students to gain practical experience with manufacturing and production of their designs. Since this type of experience is vital for success on the job, SAE began to organize and sponsor competitions which emphasize a hands-on approach to the engineering.

In response to a manifest need to provide a society that gave equal status to representatives of both biomedical and engineering interests, BMES was incorporated in Illinois on February 1, 1968. The purpose of the Society is to promote the increase of biomedical engineering knowledge and its utilization.

AIChE is a nonprofit professional association that provides leadership in advancing the chemical engineering profession. Through its many programs and services, AIChE helps its members access and apply the latest and most accurate technical information; offers concise, targeted award-winning technical publications; conducts annual conferences to promote information sharing and the advancement of the field; provides opportunities for its members to gain leadership experience and network with their peers in industry, academia, and government; and offers members attractive and affordable insurance programs.

TABLE 2.2: (continued)*Society***Civil Engineering:**<http://www.asce.org/asce.cfm>

American Society of Civil Engineers (ASCE)

Computer Engineering:<http://www.computer.org/portal/site/ieeecs/index.jsp>

IEEE Computer Society

Electrical Engineering:<http://www.ieee.org/portal/site>

Institute of Electrical and Electronics Engineers (IEEE)

Environmental Engineering:<http://www.aeee.net/>

American Academy of Environmental Engineers (AAEE)

Geological Engineering:<http://rock.geosociety.org/egd/index.html>

Geological Society of American, Engineering Geology Division

Industrial Engineering: <http://www.iienet2.org/Default.aspx>

Institute of Industrial Engineers (IIE)

Society Information

Today's civil engineer uses every advantage to meet the demands of their profession. That is why ASCE pioneers new programs, policies, educational activities, and professional resources to help them successfully compete in their business. That is why today's civil engineer has a home at ASCE.

The IEEE Computer Society's vision is to be the leading provider of technical information, community services, and personalized services to the world's computing professionals. The Society is dedicated to advancing the theory, practice, and application of computer and information processing technology.

Through its global membership, the IEEE is a leading authority on areas ranging from aerospace systems, computers and telecommunications to biomedical engineering, electric power, and consumer electronics among others. Members rely on the IEEE as a source of technical and professional information, resources, and services. To foster an interest in the engineering profession, the IEEE also serves student members in colleges and universities around the world.

AAEE is dedicated to excellence in the practice of environmental engineering to ensure the public health, safety, and welfare to enable humans to coexist in harmony with nature.

The Engineering Geology Division promotes education, research, outreach, and application of engineering geologic knowledge toward betterment of human society by adopting sound design of buildings, structures, and facilities that assure public safety and a healthy environment.

IIE is the world's largest professional society dedicated solely to the support of the industrial engineering profession and individuals involved with improving quality and productivity. IIE is an international, nonprofit association that provides leadership for the application, education, training, research, and development of industrial engineering. IIE's primary mission is to meet the ever-changing needs of industrial engineers, which includes undergraduate and graduate students, engineering practitioners and consultants in all industries, engineering managers, and engineers in education, research, and government.

TABLE 2.2: (continued)*Society***Marine Engineering:**<http://www.sname.org/>

Society of Naval Architects and Marine Engineers (SNAME)

Mechanical Engineering:<http://www.asme.org/>

American Society of Mechanical Engineers (ASME)

Mining Engineering:<http://www.aimeny.org/>

American Institute of Mining, Metallurgical, and Petroleum Engineers (AIME)

Nuclear Engineering:<http://www.ans.org/>

American Nuclear Society (ANS)

Petroleum Engineering:<http://www.spe.org/>

Society of Petroleum Engineers (SPE)

Systems Engineering:<http://www.incose.org/>

International Council on Systems Engineering (INCOSE)

Society Information

SNAME is an internationally recognized nonprofit, technical, professional society of individual members serving the maritime and offshore industries and their suppliers. SNAME is dedicated to advancing the art, science, and practice of naval architecture, shipbuilding, and marine engineering, encouraging the exchange and recording of information, sponsoring applied research, offering career guidance and supporting education, and enhancing the professional status and integrity of its membership.

Today's ASME promotes the art, science and practice of mechanical and multidisciplinary engineering and allied sciences around the globe. ASME codes and standards strive to be the world leader in mechanical and multidisciplinary engineering codes, standards, conformity assessment programs, and related products and services.

The goal of AIME today is to advance the knowledge of engineering and the arts and sciences involved in the production and use of minerals, metals, materials, and energy resources, while disseminating significant developments in these areas of technology.

ANS is a not-for-profit, international, scientific and educational organization. The core purpose of ANS is to promote the awareness and understanding of the application of nuclear science and technology.

The mission of SPE is to collect, disseminate, and exchange technical knowledge concerning the exploration, development and production of oil and gas resources, and related technologies for the public benefit; and to provide opportunities for professionals to enhance their technical and professional competence. The vision is to be a society of professional excellence, providing its members the highest quality lifelong learning, and continuous personal and professional growth. INCOSE is a not-for-profit membership organization.. Its mission is to advance the state-of-the-art and practice of systems engineering in industry, academia, and government by promoting interdisciplinary, scaleable approaches to produce technologically appropriate solutions that meet societal needs.

2.9 Instructor Supplemental Resources

Standards

ASEE Draft Engineering Standards. This chapter is focused on “Dimension 3: The Nature of Engineering” of the ASEE Corporate Members Council Draft Engineering Standards; these draft standards will serve as input to the National Academy of Engineering process of considering engineering standards for K-12 education. This dimension includes the following outcomes:

- Students will develop an understanding of the characteristics and broad scope of engineering.
- Students will be able to be creative and innovative in their thought process and actions.

Massachusetts State Technology/Engineering High School Standards This chapter addresses standard 1.2: “Understand that the engineering design process is used in the solution of problems and the advancement of society. Identify examples of technologies, objects, and processes that have been modified to advance society, and explain why and how they were modified.”

Common Preconceptions

The following are common student preconceptions about engineering:

- Students have little to no knowledge about what engineers do, or the range of engineering careers open to them.
- Students rarely know anyone who is an engineer unless that person is a relative.
- Student typically view engineering as limited to planning, designing, building, fixing and repairing things. Engineers are typically perceived as male, but rarely female.
- All engineers are viewed as lacking social qualities.
- Most people in the United States do not recognize the role of engineers in developing new forms of energy or drugs, or even working in space. These activities are seen as the work of scientists.
- Most people do not realize that engineers work with scientists to create new technologies.

2.10 References

1. . <http://en.wikipedia.org/wiki/Image:Navy-Radome.jpg>. Public Domain
2. . http://en.wikipedia.org/wiki/Image:Cad_crank.jpg. GNU Free Documentation License, Version 1.2
3. . http://commons.wikimedia.org/wiki/Image:Army_prosthetic.jpg. Public Domain
4. . <http://www.flickr.com/photos/synthesisstudios/194274298/>. CC-BY-SA 2.0 Generic
5. . <http://flickr.com/photos/terencecong/2056778032/>. CC-BY-SA 2.0
6. . <http://en.wikipedia.org/wiki/Image:Censign.jpg>. Public Domain
7. . http://en.wikipedia.org/wiki/Image:Pdr_1647.jpg. Public Domain
8. . <http://flickr.com/photos/yakobusan/273595866/>. CC-BY 2.0 Generic
9. . http://visibleearth.nasa.gov/view_rec.php?id=1438. Public Domain
10. . [A Toyotaconceptcar..](#) Attribution 2.0 Generic.
11. . <http://flickr.com/photos/peterkaminski/70278808/>. Public Domain
12. . [Clean drinking waterflowingfrom a faucet..](#) GNU-FDL 1.2
13. . [An electronics workbench..](#) CC-BY-SA 2.0 Generic
14. . [A televisionthat was manufactured in 1953..](#) CC-BY-SA 2.0 Generic
15. . [An irrigation systemwaters growing cotton plants..](#) Public domain
16. . [An HB85Bcomputer, manufactured in the early1980s..](#) GNU-FDL 1.2
17. . <http://lifestraw.wikispaces.com/>. CC-BY-SA
18. . [Walls ofapartment buildings..](#) CC-BY-SA 2.0 Generic
19. . <http://en.wikipedia.org/wiki/Image:PostOffice%21.PNG>. Public Domain
20. . http://commons.wikimedia.org/wiki/Image:Africa_HIV-AIDS.svg. GNU-FDL 1.2

Engineering & Society

Chapter Outline

- 3.1 ABOUT THIS CHAPTER**
 - 3.2 TO ENGINEER IS HUMAN**
 - 3.3 WATER AND DISEASE: A CASE STUDY**
 - 3.4 WATER AND ENGINEERING**
 - 3.5 VOCABULARY**
 - 3.6 REFERENCES**
 - 3.7 INSTRUCTOR SUPPLEMENTAL RESOURCES**
 - 3.8 REFERENCES**
-

3.1 About This Chapter

A characteristic of human beings is that we develop tools and technology to adapt our environment to meet our needs. Engineers contribute to the development of many innovations that improve life.

In this chapter, we will begin by investigating how engineers work to meet human needs; we will describe a few of the greatest engineering accomplishments of the past and consider needs that engineering must meet in the future. We then consider an example of how engineering has dramatically improved health and well-being for most of the developed world: providing clean drinking water as well as treatment for wastewater.

Chapter Learning Objectives

After working through this chapter, you should be able to

- explain the relationship between engineering and societal needs,
- explain how engineering has influenced water systems in our lives,
- describe the impact of an engineering solution related to water from an ethical viewpoint.

3.2 To Engineer Is Human



FIGURE 3.1

The ancient pyramids are an engineering marvel. The great pyramid was the tallest man-made structure in the world for almost four thousand years.

Engineering is a human endeavor. Humans have engaged in engineering to meet their needs as long as they have had needs. We invent and innovate when we are confronted with problems, needs, and desires. Inventions exist and continue to be created to meet our needs for daily life, such as access to water, energy, transportation, and entertainment. Petroski (2004) said, “Making things is an activity as old as civilization, and making ever new things is part of being human.” Our lives are permeated with technological inventions that humans have engineered (Figure 1). Yet, the fundamental nature of engineering or what engineers do is not everyday knowledge. For instance, many of us are unfamiliar with the basic principles used to build the systems that deliver water, gas, or electricity to our homes.

Engineering is the design, analysis, and creation of things that are practical and useful in our lives. At its core, engineering incorporates design. Design, simply put, is creating something that has not existed before. Engineers help design, create or change almost everything we encounter in our lives, including what we feel, eat, see, and hear.

In this section, we consider several different engineering achievements that have dramatically changed the way we live today. We then consider the impact of engineering on sustainability of natural resources, and focused briefly on one very important resource: water.

Human Needs Are Met By Engineering

To stay alive, humans and animals need only the basics of water, food, and shelter. In addition to these basics, animals, and at times humans, too, need protection from other animals that are predators. For the most part, however, humans today do not have to worry about becoming food for other animals. Although we need water, food, clothes, and shelter, not very many of us fetch water from a well or a river; grow or kill our own food; make our own fabric and sew clothes; or, build our own homes with our own hands. We do not do this on our own because people have invented products, tools and systems to do it for us, allowing us to spend productive time in other ways.

We prefer to do something other than figure out how to get clean water to our homes, grow crops, raise poultry,

make fabric and sew clothes, or construct homes. This is possible because of all the people before us who created inventions that met their and our needs. These inventions range from the basic technology of the plow or the wheel to today's advanced technologies that allow us to manage and sustain our natural resources or engage in space exploration. Human needs and wants have been met throughout time by engineering achievements that have significantly transformed and impacted our lives, especially over the past one hundred years.

The National Academy of Engineering (NAE) has identified the top twenty engineering achievements of the twentieth century; these achievements are documented in the book by Constable and Somerville (2003) and on the webpage (<http://www.greatachievements.org/>). These achievements are described in more detail in the chapter Nature of Engineering. These achievements include many of the technologies that we use every day and may take for granted.

One of these achievements that we will consider in more detail in this chapter is water supply and distribution. Water is vital for our lives. When we turn on our kitchen faucet and clean drinking water flows from the faucet, we seldom pause to think how that water got there (Figure 2). However, delivering clean water to your home or school or office requires an advanced system of treatment and distribution facilities. Imagine your life without indoor plumbing. Yet, even in today's world, there are many who live without access to running water, toilets, bathtubs, or showers. Maintaining water quality and distributing water to people where they live are timeless challenges. It is important to remember that water is not merely needed for our basic survival; in today's world water is used for many other purposes that sustain our way of life.



FIGURE 3.2

Most people in the United States are fortunate to have safe drinking water.

Engineering Sustainability for Our Future

Current projections predict that the earth's human population will be around 9 billion in 2050. By the year 3000 the world's population is predicted to be double that of today's 6.6 billion. Most of this expected increase is predicted to be concentrated in the developing nations of Africa, Asia, and Latin America. Meeting the most basic needs of this future population means an ever-growing stress on our environment and limited natural resources. This means increased production and consumption of goods and services and increased demand for land, energy, and materials (NRC, 1999). While the engineering achievements of the past century have increased the standard of living in developed countries, the challenge of the future is to alleviate poverty and raise the standard of living for all on this planet while also sustaining our natural resources.

As we consider the engineering achievements of the past, we also need to consider their unintended consequences on our lives and our planet. We must ask ourselves: What are the social, economic, and environmental impacts of our engineering achievements? Many engineering decisions cannot be made without consideration of nearby natural and man-made systems, because contemporary engineering systems can affect the environment far into the future. There is a strong need to reduce the risk and level of unwanted disturbances to natural resources and our man-made world associated with engineering systems.

According to the National Resource Council (NRC, 1999): “Sustainable development—the reconciliation of society’s developmental goals with its environmental limits over the long term—is the most recent conceptual focus linking the collective aspirations of the world’s peoples for peace, freedom, improved living conditions, and a healthy environment.” Engineers have an obligation to meet the basic needs of all humans for water, nutrition, energy, sanitation, and health, as well as the protection of the planet’s resources, including our cultural and natural diversity.

Water

The next section focuses on one of the basic human needs: water. Water is a common substance. Its chemical formula of H_2O is widely known. It is a life-giving natural resource. Seventy-one percent of the earth’s surface is covered in water, most of which is salt water (Figure 3). Water is essential to most organisms on Earth. For instance, 50 – 70% of a human body is made up of water.

Water is one of the few substances on the planet Earth that can be found occurring naturally in all three states: solid (ice), liquid (water), and gas (water vapor). A significant difference between these states is the density of each state. (Density here refers to how close the water molecules are to each other. The mass of water within a specific volume determines the density of water.) The vapor state is least dense, while the liquid state is most dense; the solid-state (ice) is less dense than the liquid state. Warm water is less dense than cold water. Therefore, heating and cooling water affects its density.

Water is a very good solvent for many compounds. Therefore, almost no pure water exists in nature; most water contains dissolved substances. After water falls to earth in the form of **precipitation**, it dissolves substances from soil and rocks. This leads, for example, to hard water, which is water that has magnesium and calcium dissolved in it. Next time you buy bottled water, read the label. You may discover, to your surprise, that your pure spring water is not merely H_2O , but also contains chemicals. In fact, the label on your bottled water may even list the chemicals and their amounts. Most water you drink has ions in it. Those ions in the water make it acidic or basic. The pH of water is a measure of its acidity or alkalinity; The pH index is related to the amount of free hydrogen ions in the water.

Water is a natural resource and sustaining it for future populations is a major challenge that will require creative engineering. Water is used by industry, agriculture, and homes. In many places in North America, people have access to all of the clean water they need. However, there are many places in the world where water supply is limited. Most uses of water actually decrease the quality of the water; this is true of water that is used in many industrial processes as well as water used by humans.

Our family, our community, our culture, our geographical area, and the prevailing economy often influence our values regarding water. For instance, if you are from an agricultural area, where your livelihood depends on the availability of water for your agricultural needs, you may rate the value or significance of water for your own life higher than someone whose livelihood is built around an entertainment industry such as running a cinema multiplex.

Activity

Take a few minutes to consider the various uses for water you have encountered in your life. Get out a pen and paper and list as many uses for water as you can. Compare your list to someone else’s list. How are they different? What

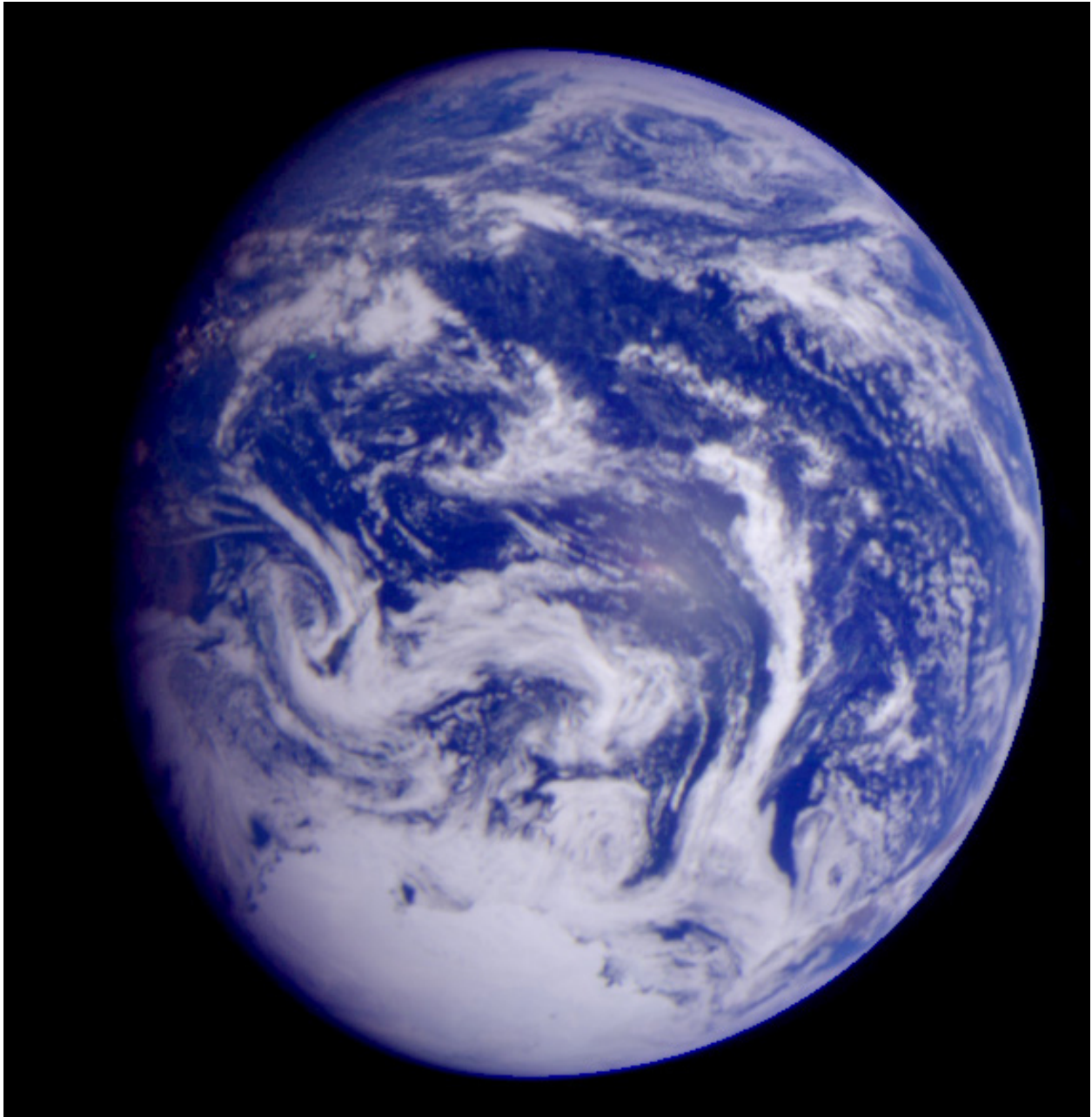

FIGURE 3.3

Water covers 71% of the Earth's surface. This photograph of Earth's polar ice and oceans was taken by the Galileo space probe.

do they have in common?

Review Questions

The following questions will help you assess your understanding of this section. There may be one, two, three, or even four correct answers to each question. To demonstrate your understanding, you should find all of the correct answers.

1. Technology refers to
 - a. computers, software, and computer peripherals
 - b. changing the natural world to satisfy needs
 - c. tools used by engineers to design systems
 - d. pre-engineering courses taken in high school
2. When looking at large-scale problems engineers should focus on
 - a. the scientific aspects
 - b. ethical aspects
 - c. economic aspects
 - d. legal aspects
3. Engineering
 - a. began as a twentieth-century invention
 - b. has always been a human activity
 - c. is a field first developed in Europe
 - d. began with Alexander Graham Bell
4. Engineers help design things that are
 - a. practical and useful in our lives
 - b. only useful to scientists
 - c. too specialized to be useful
 - d. not practical or economical
5. One of the biggest challenges of engineering is to
 - a. raise the standard of living while using natural resources
 - b. keep the standard of living the same while sustaining natural resources
 - c. keep the standard of living the same while using natural resources
 - d. raise the standard of living while sustaining natural resources
6. Engineering decisions must take into consideration
 - a. internal systems
 - b. natural systems
 - c. man-made systems
 - d. future systems
7. Sustainable development is linked to
 - a. basic needs
 - b. freedom
 - c. nutrition
 - d. world peace
8. Which of these influences our values regarding water
 - a. culture
 - b. cost
 - c. cleanliness

- d. family
9. Engineering achievements can have
- a. mistaken consequences
 - b. unrealistic consequences
 - c. no consequences
 - d. unintended consequences
10. When we use water we
- a. decrease its quality
 - b. increase its quality
 - c. do not affect its quality
 - d. improve its quality
-

Review Answers

To Engineer Is Human

- 1. b
- 2. a,b,c,d
- 3. b
- 4. a
- 5. d
- 6. b,c
- 7. a,b,c,d
- 8. a,d
- 9. d
- 10. a

3.3 Water and Disease: A Case Study

Do you ever wonder how diseases spread? Water serves as a carrier or transmitter of many diseases. In fact, many of the world's diseases are dependent on water for their transmission. These diseases often occur in large **epidemics** and can be quite catastrophic. A large part of water engineering is maintaining water quality so the water that we receive when we turn on our kitchen faucets is **potable**. In addition to making water safe for drinking, water engineering is also about transporting water from its source into our homes and to the areas where we live.

In this section we will investigate cholera, a waterborne disease; we will learn about the scientific problem solving that verified that cholera was transmitted by water. We will then begin to investigate how engineers help society manage our water supply. This topic will be expanded in later sections.

Background Information: Cholera

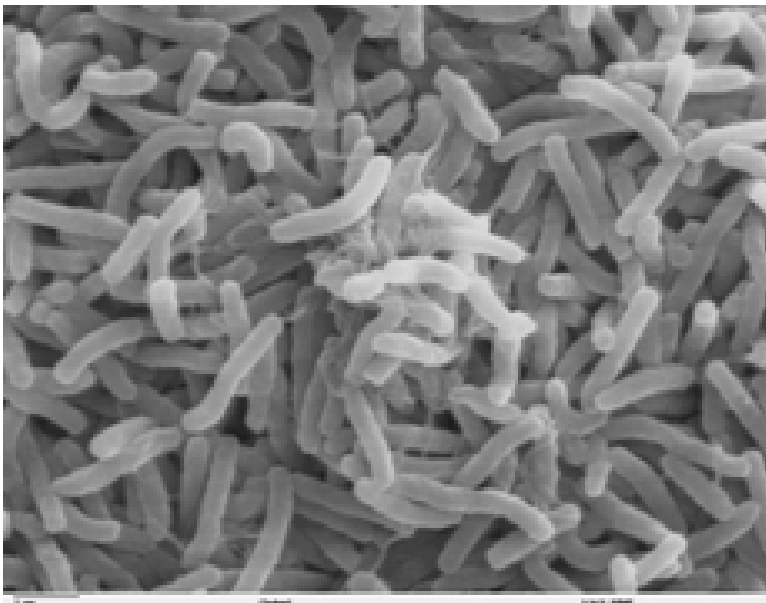

FIGURE 3.4

Microscopic view of cholera bacteria.

Cholera is an acute intestinal infection caused by ingestion of contaminated water or food. The infection is caused by the *Vibrio cholerae* bacterium (Figure 4). This bacterium typically travels through water that is contaminated by human or animal feces. Human beings can contract cholera by ingesting water or food contaminated by the *V. cholerae* bacterium. Symptoms of cholera include diarrhea, abdominal cramps, nausea, vomiting, and dehydration. As the human body does not produce lasting immunity against the cholera bacterium, it is possible that the disease can be contracted more than once. When people die from cholera, it is generally due to severe dehydration caused by the illness. When left untreated cholera generally has a high mortality rate. A cholera outbreak can be widespread, causing a large scale epidemic in which hundreds or thousands of people die.

Activity

Research and review resources on cholera epidemics on the World Wide Web. Refer to encyclopedias from your

school library or local library. Prepare a short list of answers that do not exceed 200 – 300 words for each of the following questions. You might use some of these suggested phrases for searching on the Internet: cholera, epidemics, cholera and water, water-borne diseases, water contamination sources, water quality, water purification.

- What were some of the major cholera epidemics of the past?
- What are some of the major cholera epidemics of the present?
- Where and under what conditions did the cholera epidemics occur?
- What role did water play in these cholera epidemics?
- How can the quality of water be maintained so the water does not get contaminated from bacteria such as the cholera bacterium?

The 1854 Case of Cholera in London

In 1854, hundreds of people living in London died during a cholera epidemic. At that time, very little was known about how the disease was transmitted. Many believed that people could contract diseases such as cholera by breathing bad or foul air. It is estimated that 616 people died during this epidemic. If not for the intervention of Dr. John Snow (b. 1813–d. 1858), who carefully mapped the number of deaths that occurred around water sources, primarily the Broad Street pump, and then worked with other officials to remove its handle, the cholera epidemic of 1854 in London would have been more widespread. It was later discovered that sewage was contaminating the water source for the Broad Street pump. Preventing people from using this pump stopped the use of water from that source. This action has been credited with greatly reducing the number of deaths during this epidemic.

Dr. Snow created the map in Figure 5. The Snow map depicted the area around the Broad Street pump where the number of deaths is indicated by dark blocks at the homes and establishments around the pump.

During an earlier cholera epidemic in London in 1848 and 1849, Snow had proposed the unusual idea that cholera was caused by something that was ingested orally, rather than by inhaling foul air. During the cholera epidemic of 1854 in London, Snow collected data by carefully interviewing people around Broad Street who had not been infected by the water they had been drinking. Others would cite, after Snow's death in 1858, that the data he had collected supporting his theory that cholera was primarily spread by sewage-contaminated water. Dr. Snow's research into the spread of cholera locally around the Broad Street pump is an important lesson taught even today to epidemiology students as a model of scientific reasoning. Dr. Snow authored a report about the cholera outbreak in the Parish of St. James, Westminster, during the Autumn of 1854; this as well as his other works are available online at the John Snow Archive and Research Companion website.

Today most of us know that unclean water carries bacteria that cause disease. We value clean water. However, in the 1800s, the idea that water could carry disease was frightening to many. During that time many people believed that catastrophic diseases such as cholera were visitation of retribution for sinful living of the poor. Dr. Snow had to work hard to convince the local authorities to remove the handle of the Broad Street pump. Now, people know that cholera infection can be avoided by drinking clean water. During the twentieth century, in the western hemisphere, incidences of cholera in the recent past are almost nonexistent. However, it is estimated by the World Health Organization (WHO) that in developing nations only 35% of the population have access to clean water.

According to the WHO, the current response to cholera outbreaks tends to mostly in the form of emergency response whenever there is an outbreak. While emergency response is very important and prevents many deaths, it does not help prevent causes of cholera. Therefore, one cannot emphasize enough the importance of long-term cholera prevention. Key to the prevention of cholera and other waterborne diseases is closely related to the prevention of water contamination and water purification. Separating sewage water from natural water sources, treatment of sewage water, treatment of water resources, and purification of water for storage and delivery for human consumption are key elements of such a strategy that involve engineering solutions. In addition, medical research, personal hygiene, and public health education will play a key role in the prevention of cholera epidemics.

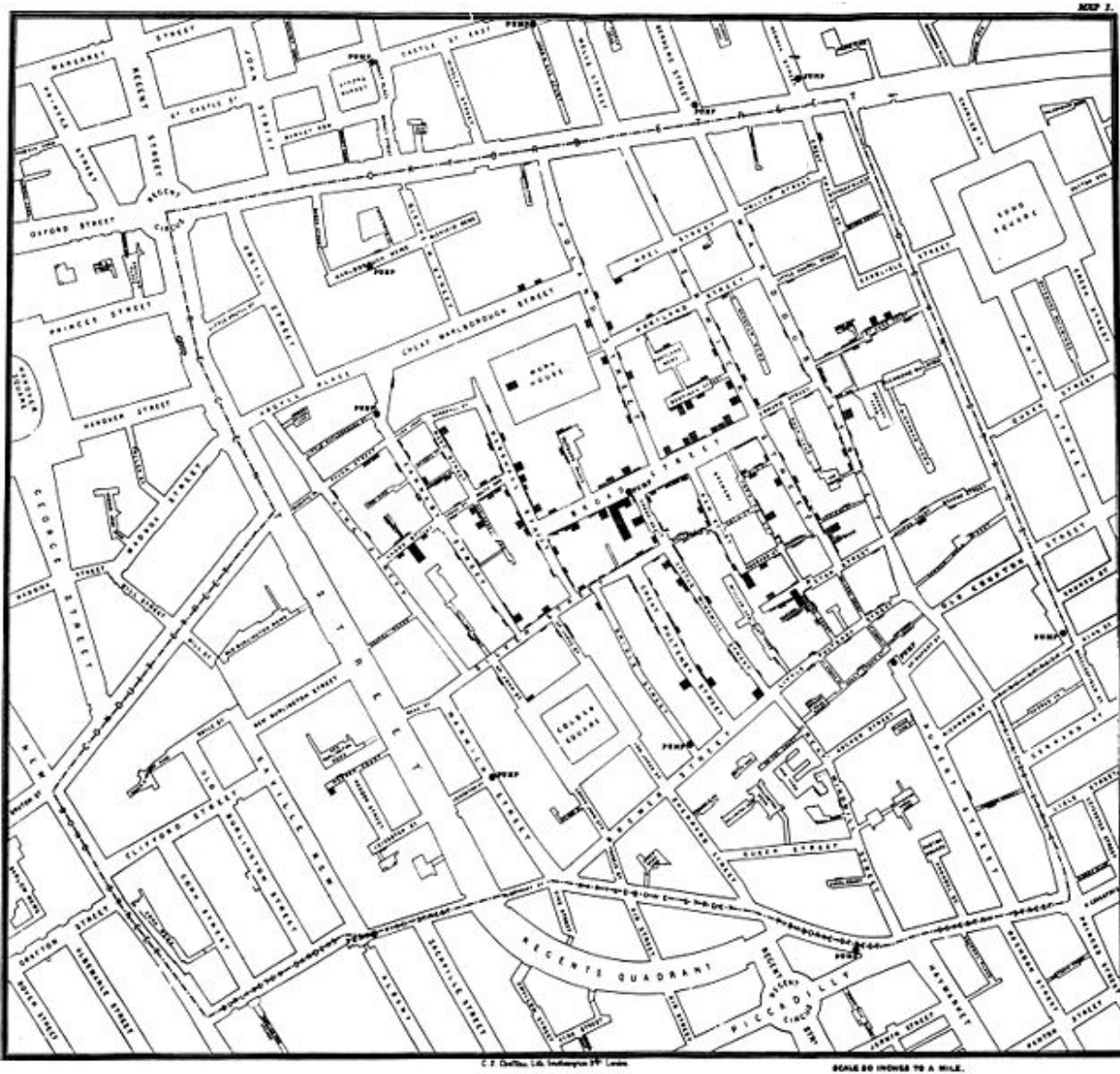
FIGURE 3.5

Number of deaths at 40 Broad Street. Deaths at homes are indicated by dark lines.

Water Engineering and Management

One of our significant challenges today is to obtain water for people and for food production, look after critical ecosystems and habitats, and deal with the variability and uncertainty of water on our earth. Water engineers and managers need to understand the complexity of water use and water resources management. Water for human consumption includes engineering solutions related to water supply and sanitation; management of water treatment and distribution systems (Figure 6); storm water, domestic wastewater, and urban drainage; and sustainable management of water for urban and rural areas. Water for food production includes the use of water for agricultural purposes

**FIGURE 3.6**

Water towers such as this one help distribute clean water to surrounding communities.

which necessitates engineering solutions related to planning, design, implementation, operation, and maintenance of irrigation and drainage projects. Water for energy production includes the use of engineering solutions such as dams for hydroelectric power. Water management is also related to engineering solutions for uncertain events such as flooding caused by natural and human activities.

Review Questions

The following questions will help you assess your understanding of this section. There may be one, two, three, or even four correct answers to each question. To demonstrate your understanding, you should find all of the correct answers.

1. Water engineers are concerned with

- a. ensuring that water is drinkable
 - b. drinking eight glasses of water a day
 - c. transporting water to our homes
 - d. marketing bottled water
2. An example of a disease caused by contaminated water is
 - a. a cold
 - b. colessus
 - c. Cholera
 - d. colitis
 3. We can prevent waterborne diseases by
 - a. washing our hands
 - b. public health education
 - c. vaccinations
 - d. visits to the doctor
 4. Water engineers look for solutions to mitigate
 - a. overfishing the oceans
 - b. natural flooding
 - c. building ships
 - d. human caused flooding

Review Answers

Water and Disease: A Case Study

1. a,c
2. c
3. b
4. b,d

Reflection Questions

- Why do North Americans not have to worry about cholera?
- When we travel abroad to some countries, we are advised to receive a cholera vaccination. Why is it necessary to receive a cholera vaccination?

Further Reading

- Johnson, Steven. *The Ghost Map (The Story of London's Most Terrifying Epidemic and How It Changed Science, Cities, and the Modern World)*. Riverhead Books, New York, 2006.
- Tuthill, Kathleen. "John Snow and the Broad Street Pump: On the Trail of an Epidemic." *Cricket*, 31 (2003): 23–31. Available on the web at
- <http://www.ph.ucla.edu/epi/snow/snowcricketarticle.html>

3.4 Water and Engineering

Many of the great engineering achievements beginning at the earliest times through the present have been associated with providing a reliable water supply and with disposing of wastewater. The Roman aqueducts that supplied Rome and other cities with drinking water between 300 BC and AD 300 are one example of this. The sewer system in London developed during the late 1800s is another example. Because of these engineering accomplishments, most people in the developed world have access to safe drinking water.

In this section, we investigate the relationship between engineering and water. We first describe the concept of water quality standards and how drinking water should meet these standards. We then describe the techniques engineers have developed to provide potable water and to treat wastewater so that it does not unduly **pollute** the environment.

Water Quality Standards

Most of us know that the water we receive from our local municipalities is treated. The treatment of water has to follow water quality standards. In the United States, the development of water quality standards began in the early twentieth century. Over time, these water quality standards have evolved and have become more rigorous. Laws and regulations such as the Clean Water Act govern water quality standards in the United States. The US Environmental Protection Agency (EPA) has the mission of protecting human health and the environment. The EPA has created water quality standards that define the goals for a **body of water** and specify its uses. They establish criteria to protect those water uses. They also establish requirements to protect water from pollutants.

In general, a water quality standard consists of four basic elements (EPA):

1. Designated uses of the water body (e.g., recreation, water supply, aquatic life, agriculture).
2. Water quality criteria to protect designated uses (numeric pollutant concentrations and narrative requirements).
3. An antidegradation policy to maintain and protect existing uses and high-quality waters.
4. General policies addressing implementation issues (e.g., low flows, variances, mixing zones).

State governments are required to identify the appropriate uses for water bodies. These uses are identified by taking into consideration the value of the water body for various uses. The uses for a water body can include any of the following: public water supply, protection of fish, shellfish, and wildlife, recreation, agriculture, industry, and navigation. In making these designations, the appropriate authorities must examine whether the water body is suitable for the intended use. This determination is made based on the physical, chemical, and biological characteristics of the water body, its geographical setting and scenic qualities, and economic considerations.

Drinking Water

The quality of drinking water differs from one location to another. Quality is dependent on the condition of the water source and the treatment. Each local community water supplier is required to provide an annual report, sometimes known as a “consumer confidence report” to the public. This report usually provides information on the quality of the local drinking water, its source, and the **contaminants** found in the water (Figure 7).

Scientists report the contaminants in water as contaminants in parts per million (ppm), parts per billion (ppb), and parts per trillion. When water contaminant measurements are reported in this manner, you may wonder: How can

**FIGURE 3.7**

The city of New York monitors its drinking water to ensure that it is safe. This sign marks the location of a station where the drinking water is sampled.

amounts of contaminants that seem so very small cause health problems? Scientific research has shown that, for example, lead concentrations as small as 15 ppb can be harmful to infants and children. The smell of petroleum products in water can be detected by humans even when the amount of petroleum in water is as low as 10 ppb.

It is very important to note that there is no such thing as naturally pure water. All water in nature contains some sort of impurities. Since water is a good solvent, as it flows through various layers of soil and over rocks, it dissolves minerals. These minerals in the water may get the taste (good or bad). However, if these minerals are above a certain level, they could be harmful.

Have you ever thought about where your drinking water comes from? Many of us take the drinking water we get when we turn on our kitchen faucet for granted. The water in many urban areas comes from surface sources such as lakes, rivers, and reservoirs. These sources can be near the urban areas or far away. Water suppliers procure and treat the water they provide. It is important to consider the entire watershed that provides the water. A watershed is the land from which precipitation (usually rain or snow) flows into the river, lake, or reservoir.

In many urban and rural areas, water also comes from ground water that is pumped from a well. Wells provide water from aquifers, which are natural water reservoirs under the earth's surface. Aquifers may lie under parts of several states or may only be a few miles wide. Thus, water quality is affected not only by the water source such as a river or well that we can see, but also by activities that occur many miles away.

Before the water is delivered to our homes, the water is treated. The treatment of drinking water that is most

common is disinfection. Water suppliers add chlorine or another disinfectant to kill bacteria and germs in the water. This commonplace drinking water treatment is considered to be one of the most important scientific advancements of the twentieth century.

Activity

Common water treatment methods: Before we examine a water treatment plant, list and describe some common ways to treat water or purify water for drinking that you can do at home or during emergencies.

Materials needed: Internet-accessible computer, science textbooks.

Suggested phrases for searching on the Internet: Water purification at home, Water purification during emergencies, Common water purification methods.

Directions: Working alone or in a group, brainstorm a list of ways in which drinking water might be bad. From your list, identify problems that might need to be treated. Brainstorm a second list of ways to obtain good drinking water in your home. Do any of these solve the problems identified on your first list?

Using the Internet, research news stories related to water supply and water problems in your local community. How do the results of your research compare to your first list of potential problems with water? Are there problems that you did not anticipate?

Research information on water purification techniques that can be used at home. Discuss in small groups what you learned from your research. Prepare a chart with a brief description of common water problems and the treatment/purification methods appropriate to each problem; include a list of materials you would need for each treatment method and illustrate each method by making your own drawing.

Hints: Filtration, Boiling, Distillation, Water Softeners, Reverse Osmosis

Extensions: What will be the cost of implementing these home-based water purification techniques if you were to need clean water for a family of four? How would you go about determining the amount of water that you will need? What is the most effective method in terms of removing impurities for the quantity of water you need for a family of four for drinking/food purposes?

Water Treatment Basics

Municipalities must perform two types of water treatment: treatment of water before it is used for drinking and other purposes, and treatment of wastewater such as sewage so that it is safe to return to the environment. Typically, drinking water is treated based on the quality of the source water. Ground water, for instance, usually requires less treatment than surface water from a river or a lake. Thus, the quality of the water that enters your community water treatment plant determines how the water will be treated prior to distribution.

Wastewater includes sewage as well as water used in industrial and agricultural processes. It flows out of homes and neighborhoods through sewage pipes to a wastewater treatment plant. Here, the wastewater is treated to remove solids and contaminants. The treated wastewater may be re-used for irrigation and landscaping. The treated wastewater is also returned to streams, rivers, and oceans, which can also be a source of pollution.

Treatment plants for drinking water and for wastewater have equipment and processes to remove or destroy harmful materials and organisms. A treatment plant uses tanks and mechanical parts such as valves and pumps to move the water through the different processes. These processes are designed and managed by water engineers. Other

engineering specialties, including mechanical and construction engineering, play a role in the construction and maintenance of water treatment plants.

Drinking Water Treatment

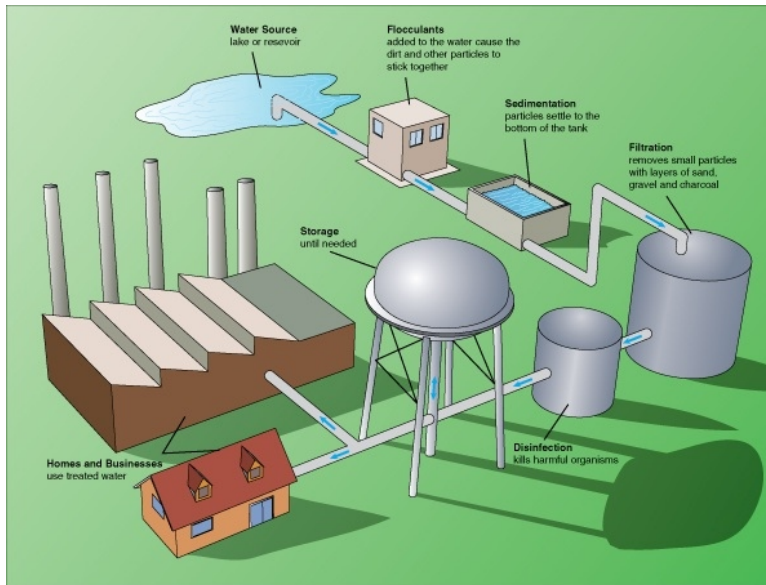

FIGURE 3.8

Illustration of a typical drinking water treatment process.

Water from rivers, lakes, and streams or ground water is pumped and transported to a drinking water treatment facility. Then the water is processed through various units to prepare the water for distribution to homes. The water treatment involves the steps shown in Figure 8 and described below.

Coagulation. First, dirt and other particles must be removed from the water. Flocculants are chemicals such as alum (aluminum potassium sulfate) that cause the dirt and other particles to stick together; flocculants are added to the water, which creates larger particles called floc.

Sedimentation. As the water moves through the sedimentation tanks, the floc particles settle to the bottom of the tank. The clear water then flows to a filtration unit.

Filtration. Filtration removes small particles from the water by passing it through layers of sand, gravel and charcoal. The water then moves to disinfection before storage.

Disinfection. Water is disinfected with chlorine or other chemicals, called disinfectants, to kill any bacteria and other harmful organisms. The amount of disinfectants added to the water has to be carefully adjusted, because too much may be harmful to humans, but too little will not kill the harmful organisms.

Storage. After disinfection, the water is stored in storage tanks until it is needed for distribution to homes, businesses, and other water users.

Activity

What are the mechanisms that maintain water pressure during peak water usage times in urban areas? You can easily imagine that in most urban cities, water usage will peak during certain times of the day. Have you wondered how the water flow rate and the pressure at which the water flows out of your home's faucets is maintained during the mornings when most people are preparing to leave for school or work? This is a time when water use is high as

people brush their teeth, shower, and use water for personal hygiene.

Materials needed: Internet-accessible computer, science textbooks.

Suggested phrases for searching on the Internet: Water pressure, water flow during peak water usage times

Directions: Research and review information on how water delivery systems or local municipalities or your city's water supply systems regulate water flow and water pressure during peak times. Discuss in small groups what you learned from your research. Prepare a brief essay that describes the mechanisms or techniques used by water suppliers to maintain water flow and pressure during peak times. Illustrate this technique by making your own drawing.

Hint: Have you seen water tower tanks in cities that are in flat areas? Research what purpose these water tower tanks serve. What do water pumps do? Research the various ways in which a city or municipal water supply system uses water pumps.

Wastewater Treatment

Before wastewater can be released into the environment, it is treated in a wastewater treatment plant. An aerial view of a wastewater treatment plant is shown in Figure 9. Figure 10 illustrates the steps involved in the treatment of wastewater. We describe the steps in more detail below.



FIGURE 3.9

An aerial view of a wastewater treatment plant in Dresden, Germany.

Pumping. Wastewater treatment facilities are usually located on low ground so that **gravity** will move sewage from homes to the treatment plant. Usually, pumps are needed to lift the sewage as it enters the treatment facility. The treatment facility uses gravity to move the wastewater through the treatment process.

Bar screen. As it enters the treatment plant, wastewater may contain large items such as plastic bottles, cans, sticks, rocks, and even dead animals. These items are removed by the bar screen and sent to a landfill. If they are not removed, they will damage equipment in the treatment plant.

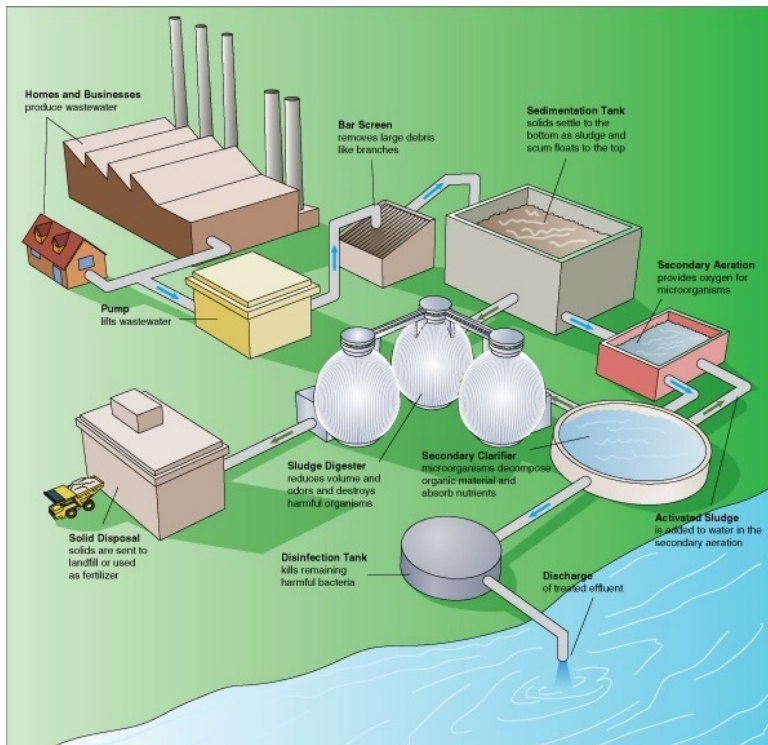

FIGURE 3.10

Steps in a typical wastewater treatment process.

Grit chamber. After screening, wastewater enters the grit chamber in which larger particles (such as sand or dirt) settle out of the water. Often, the water is aerated (air is bubbled through it) to keep smaller particles from settling out. Aeration causes some of the gases that are dissolved in the water (e.g. hydrogen sulfide that smells like rotten eggs) to be released.

Sedimentation tank. In the sedimentation tank (also known as the primary clarifier), solids settle to the bottom as sludge and scum floats to the top. The sludge is pumped out of the primary clarifier and sent to the solids processing facility. The scum is composed of lighter materials such as grease, oil, soap, and so forth. Slow-moving rakes are used to collect the scum from the surface of the wastewater.

Secondary aeration and clarifier. The wastewater is exposed to air in an aerator, which provides oxygen for microorganisms that help break down contaminants in the water. This may be done by spraying the wastewater into the air or by bubbling air through the wastewater. The aerated effluent is passed into a secondary clarifier, which is a large tank or pond; in the clarifier, microorganisms decompose organic material and absorb nutrients such as nitrogen and phosphorus. The microorganisms and remaining solids settle out of the effluent as activated sludge. Most of the activated sludge is pumped to the solids processing facility, while the remaining sludge is pumped into the wastewater entering the aerator. This introduces additional microorganisms to the wastewater to hasten the breakdown of organic matter.

Filtration. Filtration may be used to further reduce the organic matter in the water. The water is filtered through a substance, usually sand and rocks. During this filtration process, most bacteria are removed, turbidity and color in the wastewater are reduced, odors are removed, the amount of iron content in the wastewater is reduced, and any other solids that may have remained in the water are also removed. This water may subsequently be filtered again through a carbon filter such as charcoal to remove organic particles.

Disinfection. To kill remaining harmful bacteria and other **pathogens** in the processed wastewater, chlorine and other chemicals are added in a disinfection tank. The chlorine can be harmful if added in excess quantities. (You may have noticed the smell of chlorine or have had irritated eyes when you were exposed to chlorine in a swimming pool.) Therefore, in some cases, the chlorine must be neutralized with other chemicals after it has killed the bacteria

to protect marine organisms.

Solids processing. Solids include the sludge and scum removed in the sedimentation tank and the activated sludge removed from the secondary clarifier. These solids may be processed further in devices called digesters, which are heated and enclosed tanks. The solid wastes are kept in these tanks for 20–30 days to reduce the volume of the material, reduce odors, and also destroy any organisms that have the potential to cause disease. Depending on the source and composition of the wastewater, the digested solids are either sent to a landfill or used as fertilizer for crops. The use of the processed solid wastes as fertilizers is usually done only after careful testing for any potential dangerous contamination.

The treated water that is released by the plant is called effluent. The effluent is usually released into a local river or the ocean. In some places, this water may be used for landscaping (e.g. to water lawns or golf courses), but not for drinking purposes.

Review Questions

The following questions will help you assess your understanding of this section. There may be one, two, three, or even four correct answers to each question. To demonstrate your understanding, you should find all of the correct answers.

1. The United States government agency that is responsible for water quality standards is
 - a. the Environmental Protection Agency
 - b. the national air and space administration
 - c. the president of the United States
 - d. the forest service
2. Urban water supplies come from
 - a. fire hydrants
 - b. surface sources such as lakes, rivers, and reservoirs
 - c. the ocean
 - d. groundwater
3. Two types of water treatment are
 - a. treatment of wastewater
 - b. freezing and melting
 - c. adding a slice of lemon
 - d. treatment of drinking water
4. The design and management of processes in a water treatment plant involved these engineering specializations
 - a. water engineering
 - b. social engineering
 - c. mechanical engineering
 - d. construction engineering
5. The purpose of disinfection is to
 - a. further pollute water
 - b. kill fish and other marine animals
 - c. kill bacteria
 - d. make water taste good
6. The purpose of wastewater treatment is to
 - a. make the water clean enough to drink

- b. remove solid and organic matter from water
- c. kill harmful bacteria
- d. reduce pollution caused by wastewater

Review Answers

Water and Engineering

- 1. a
- 2. b,d
- 3. a,d
- 4. a,c,d
- 5. c
- 6. b,c,d

3.5 Vocabulary

Body of water

A significant amount of water either naturally (such as lakes, rivers, and oceans) or man-made (such as ponds, lakes, and harbors).

Contaminant

A substance that may be harmful to humans or other forms of life when released into the environment.

Epidemic

a widespread outbreak of a contagious disease.

Gravity

The force of attraction exerted between objects. Often, this is the force of attraction that the earth exerts on objects at its surface.

Pathogen

A disease-producing organism.

***pH* (potential of Hydrogen)**

A measure of the activity of hydrogen ions (H^+) in a solution. This is a measure of the solution's acidity or alkalinity. *pH* is the logarithm of the reciprocal of the effective hydrogen-ion concentration and is a number between 0 and 14; the number has no units. A *pH* of 7 indicates neutrality, that is, the solution is neither acidic nor alkaline. *pH* numbers lower than 7 indicate acidity, while *pH* numbers higher than 7 indicate alkalinity. Each change of 1 *pH* represents a tenfold change in acidity or alkalinity.

Pollute

To make something dirty, foul, or unclean.

Potable

Potable water is water that is clean enough to drink.

Precipitation Water that falls from the atmosphere to the earth's surface. The most common form of precipitation is rain. Snow, sleet, hail, and freezing rain are also forms of precipitation.

3.6 References

- Environmental Protection Agency. “Water Quality Standards.” Downloaded March 4, 2008. Available on the web at
<http://www.epa.gov/waterscience/standards/about/>
- George Constable and Bob Somerville. *A Century of Innovation: Twenty Engineering Achievements that Transformed Our Lives*. Joseph Henry Press, Washington, D.C., 2003.
- Henry Petroski. *Pushing the Limits: New Adventures in Engineering*. Knopf, New York, 2004.
- NRC (National Research Council). *Our Common Journey: A Transition Toward Sustainability*. National Academy Press, Washington, D.C., 1999.
- John Snow Archive and Research Companion. MATRIX: The Center for Humane Arts, Letters, and Social Sciences Online at Michigan State University. Downloaded May 28, 2008. Available on the web at
<http://matrix.msu.edu/johnsnow/>
- World Health Organization. “Cholera: Prevention and Control.” Downloaded July 2008. Available on the web at
<http://www.who.int/topics/cholera/control/en/>

3.7 Instructor Supplemental Resources

Standards

ASEE Draft Engineering Standards. This chapter is focused on “Dimension 5: Engineering and Society” of the ASEE Corporate Members Council Draft Engineering Standards; these draft standards will serve as input to the National Academy of Engineering process of considering engineering standards for K-12 education. This dimension includes the following outcomes:

- Students will develop an understanding that engineering is an ethical human endeavor that addresses the needs of a global society.
- Students will be able to investigate and analyze the impact of engineering on a global society.

Common Preconceptions

Students have a number of preconceptions about engineering, technology, and the topic of this unit—water—which can affect their understanding of the reading material and activities. There are preconceptions relating to *Dimension 5: Engineering and Society* in general and others related specifically to the standards subsumed by Dimension 5.

Engineering and Engineers

Students have little to no knowledge about what engineers do or to the range of engineering careers open to them. They rarely know anyone who is an engineer unless that person is a relative. Perceptions of what engineers do are limited to planning, designing, building, fixing and repairing things. Engineers are also perceived as male and never female. Engineers who work with computers are viewed as hackers. All engineers are viewed as lacking social qualities.

Technology

Students also have preconceptions of technology. They see technology as limited primarily to computers and related to electronic devices. They do not see such simple artifacts as zippers or forks as technological innovations that were groundbreaking in their time. Nor, do they see the built world as filled with engineering innovations that have served the needs of society.

Addressing the Needs of a Global Society

Among female students in particular, the strongest preconception is that engineering does not meet the needs of society and as a consequence students do not choose engineering careers. This naïve conception is strongly linked to the lack of knowledge about what engineers do and the range of engineering careers available to them. Furthermore, since conceptions of engineering are limited to building, fixing, and repairing things, as well as designing and planning, students’ views of engineering and its reach is local rather than global. Female students are also more

likely than males to describe the products of engineering as having just as many negative impacts on society, such as bombs, as positive impacts.

Investigate and Analyze the Impact of Engineering on a Global Society

Most people in the United States do not recognize the role of engineers in developing new forms of energy or drugs or even working in space. These activities are seen as the work of scientists. Furthermore, they do not understand that engineers work with scientists to create new technologies. In a survey of the International Technology Education Association, only 36% of respondents chose “changing the natural world to satisfy our needs” when asked to select what comes to mind when they hear the word technology.

When students look at large-scale problems such as those relating to the environment, they tend to focus their analysis on the scientific aspects of such problems and ignore the ethical, economic, legal, and social components. A narrow focus in analyzing problems that impact a global society, attributing the work of engineers to scientists and misunderstanding the role of technology must first be addressed before students can investigate and analyze the impact of engineering on a global society.

Water

When environmental problems such as water pollution are presented to students they make distinctions between local and global problems rather than seeing them as one and the same. Local problems are solved from an anthropocentric perspective based on personal views in contrast to global problems that are solved using scientific knowledge. Ethical, legal, and economic factors are rarely seen as important in solving environmental problems.

Furthermore, students do not understand that water is part of a complex dynamic system within which water is conserved. They do not understand the physical and chemical process of the water cycle. They do understand that the water system has an atmospheric component but not that it has a groundwater component. Nor, do they understand the water table. In addition, ground water is believed to be captured in impervious rock or to be contained in large static underground lakes.

Only 11% of students believe that industries play a role in water pollution by dumping industrial waste into streams. Students who live near polluted rivers had a limited sense of the extent of water pollution despite their proximity to polluted rivers. These students believed that rivers in rural areas were not polluted. And, because students do not see the connection between groundwater and atmospheric water they do not make connections between the hydrosphere and other components of various earth systems which limits their ability to once again think globally.

Bibliography and References

- Dale Baker, Steve Krause, Senay Yasar, Chell Roberts, and Sharon Robinson-Kurpius. “An Intervention on Tinkering and Technical Self-efficacy, and the Understanding of the Societal Relevance of Science and Technology.” *Journal of Engineering Education* 98 (2007): 213–26.
- Eneken Metsalu. “Students’ Environmental Knowledge and Decision-Choices in 6th and 9th Grade.” Downloaded July 2005. Available on the web at <http://www.ut.ee/biodida/e/metsalu.htm>
- Nir Orion and Orit Ben-zvi-Assarf. “A Study of Junior-High Students Perceptions of the Water Cycle.” *Journal of Geoscience Education* 53 (2005): 366–73.
- Renato Schibeci, A. Fetherstonhaugh, and S. Griffin. “Conceptions of Water Related Phenomena.” *Research in Science Education* 23 (1993): 259–65.
- University of Massachusetts, “Engineering for K-12 Students: Concept Papers.” July 2007. Available on the web at http://www.massachusetts.edu/stem/engineering_concept.html

Annotated Reading List

Stefanow, Jennifer. (2004). *Polluted waters*. Chicago, IL: Raintree. Pages: 48, Price: \$22.00 (USD), ISBN: 0739870165 (9780739870167)

This book is appropriate for students in grades 5-9+ (ages 11–15+). The book is one of the six titles in Raintree’s “Green Alert!” series. This nonfiction series examines the impact of modern life on our planet’s ecosystems. *Polluted Waters* focuses on the sources of water pollution and the need to conserve this important resource. The book includes six chapters. Beginning with an introduction to water pollution, its forms, and how to measure it, the book presents causes of water pollution and effects on plants, ecosystems, animals, and people. Real world case studies are introduced to the reader.

Bowden, Rob. (2003). *Water supply: Our impact on the planet*. Austin, TX: Steck-Vaugh Company. Pages: 64, Price: \$24 (USD), ISBN: 0739855069 (9780739855065)

Water Supply is appropriate for students in grades 6+ (age 12+) and above. Part of the “21st Century Debates” series, this easy to read book discusses the significance water has to our lives, the scarcity of fresh water and the ensuing problems. Over nine chapters, the reader is presented with the background knowledge needed to understand the issue of sustaining our water resources for the future.

Arato, Rona. (2005). *World of water: Essential to life*. New York: Crabtree. Pages: 32, Price: \$18.90 (USD), ISBN: 0778714160 (0778714489)

World of Water is appropriate for students in grade 4+ (age 10+). The book presents background knowledge on our biological need for water, the process of the water cycle, the distribution of water supply among rivers, geysers, springs, etc., and the water treatment necessary to make available potable water.

Dagleish, Sharon. (2003). *Saving water*. Broomall, PA: Chelsea House Publishers. Pages: 32, Price: Unknown, ISBN: 0791070166 (9780791070161)

Saving Water is appropriate for students in grade 4+ (age 10+) and above. The book presents elementary information about water and its properties, its uses at home, industry, and agriculture, and the relationship between water and disease.

McDonald, Bernadette Jehl, Douglas (Eds). (2003). *Whose water is it? The unquenchable thirst of a water-hungry world*. Washington, D.C.: National Geographic Society. Pages: 232, Price: \$25 (USD), ISBN: 0792262387

This book is appropriate for high school youth and young adults (age 15+). An edited volume, this book presents multiple perspectives about ownership, scarcity, conflict, and prospects for sustaining water for the future. In barely 20 years from now, it is predicted that one-half of the earth’s population may lack sufficient access to water for basic needs. Within such a context, the contributors of this volume carefully examine the question of “Whose water is it?” Readers should be provoked to think about and take action to sustain this important resource.

Water Use Activity

This activity can be used in conjunction with the section To Engineer Is Human. You may wish to select uses from those that students identify in the activity at the end of the section, or you may use those already in the table.

- First ask the students to rate the importance of each use individually by rank ordering the uses, 5 to 1, with 5 having the highest priority and 1 the least.
- Form small groups of five students and ask them to calculate the average ranking for each water use for their group. (Note: If there are 5 students in a team, then for each water use, the students have to total the rank given by each student for that group and divide the total by 5.) Give students time to discuss differences in

their rankings. Encourage students to express their feelings about the differences in their own ranking of the water uses with that of the group average.

- Compute the class average ranking for the listed water uses and plot a frequency chart for each water use ranking. This will create a water use index for the class and a visual representation of the whole group's value for different water uses.
- Extend this activity by asking students to discuss the water index developed by the class with their family and community members.
- Extend this activity by asking students to add to the list of water uses provided below. Have them discuss examples of each type of water use.

Water Use Chart

Rank the following water uses: 5 for the most important to 1 for the least important

TABLE 3.1:

Water use	Individual ranking	Small Group average <i>Number of students in small group: ____</i>	Class average <i>Number of students in class: ____</i>
Human Consumption: Drinking, Bathing	Cooking,		
Energy Generation: Hydroelectric, Nuclear, and Coal			
Irrigation for Agriculture: Wheat, Corn, Rice, Veg- etables			
Industrial Manufacturing: Computers, Automobiles			
Wildlife and Conserva- tion: Fish, Endangered Species, Habitats			

Project—Engineering Water: News Special Edition

Students will develop their own special edition of a newspaper that is exclusively focused on water and engineering.

Objectives

Students will (demonstrate that they)

- recognize that *water* is an important global resource,
- understand that *engineering* plays a significant role in sustaining our water resources.

Students will be able to (demonstrate by doing)

- examine the impact of engineering on water in their own lives as well as in a global context,
- analyze the knowledge they have gathered on engineering's impact on water,
- synthesize their knowledge and publish a newspaper edition on water and the role of engineering,

- critique and discuss their *Engineering Water: News Special Edition*.

Materials needed

Internet-accessible computer, newspapers, textbooks.

Engage

The teacher shows examples of drought and or water pollution around the world and engages the students in a discussion about what happens to people, animals, crops, and quality of life when water resources are limited or polluted. Examples could be Africa or a local waterway or the situations depicted in Figures 11 and 12.

The teacher presents the assignment for the explore section of the lesson. Students should decide on whether they wish to investigate the issue of drought or water pollution, and identify a country or part of the world to research. They may work in pairs or individually or even in small groups. They should also identify some of the engineering solutions being used to address the problems of water pollution and drought.

The teacher should also provide criteria for evaluating the accuracy and quality of the information students gather. Some criteria could include the qualifications of the writer (a scientist, engineer, newspaper reporter, private citizen) as well as the trustworthiness of the source (advocacy group, scientific organization, political organization, government, textbook, personal blog).

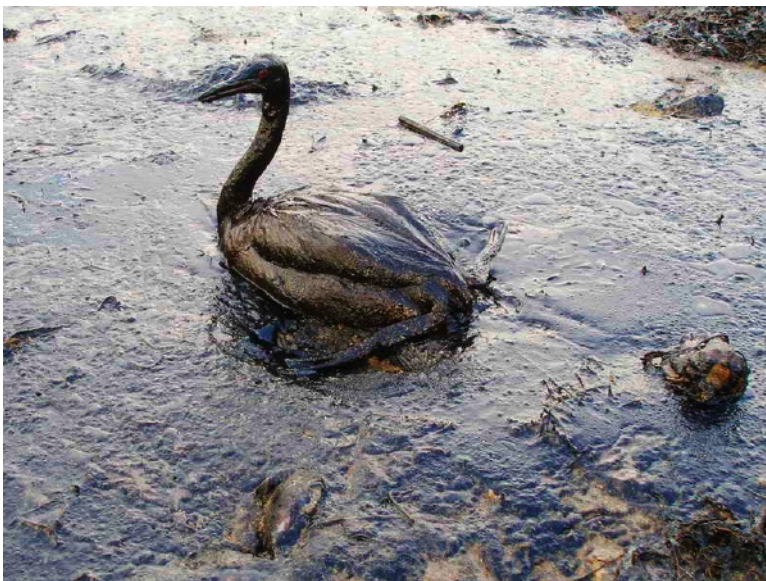

FIGURE 3.11

A Russian oil tanker broke in half in the Kerch Strait in November 2007 and released more than 2000 metric tons of fuel oil. This polluted a large stretch of shoreline, injuring many birds and fish.

Explore

Students use multiple resources (textbooks, newspapers, internet) to research their topic and organize the data in chart form. The students present their information to one another as a whole class activity. This data chart is a way to help students organize the information they find.



FIGURE 3.12

Because of a drought in South Australia in 2007 and 2008, a potential swimming hole is dried-up and the sign is no longer necessary.

TABLE 3.2:

Description of the topic (drought or water pollution)	Locations (area of the world, country or area of a country, local)	Impact on people	Impact on crops	Impact on animals	Impact on quality of life	Engineering solutions
---	--	------------------	-----------------	-------------------	---------------------------	-----------------------

- Example 1
 - Example 2
 - Example 3
 - Example 4
-

Explain

On the basis of the presentations, the teacher prepares and then provides background information or addresses aspects of the issue students may have overlooked. For example, a student might identify fewer crops in drought conditions but not see the impact on animals (less fodder) or quality of life (higher costs of food, fewer food choices). If students have confined their research to fresh water resources and overlooked the importance of the ocean as a global water resource, the teacher should explain the role of the ocean in providing food, employment and moderating climate. In a similar vein, students may have focused their research on large-scale engineering solutions and overlooked smaller

TABLE 3.3: (continued)

Student Outcomes	Strongly meets criteria	Adequately meets criteria	Minimally meets criteria	Does not meet criteria
<i>Understand that engineering plays a significant role in sustaining water resources</i>	Provides multiple examples of the role of engineering in sustaining water resources	Provides some examples of the role of engineering in sustaining water resources	Provides one example of the role of engineering in sustaining water resources	Does not provide examples of the role of engineering in sustaining water resources
<i>Examine the impact of engineering on water in their own lives</i>	Provides multiple examples of the impact of engineering on water in their own lives	Provides some examples of the impact of engineering on water in their own lives	Provides one example of the impact of engineering on water in their own lives	Does not provide examples of the impact of engineering on water in their own lives
<i>Examine the impact of engineering on water in a global context</i>	Provides multiple examples of the impact of engineering on water in a global context	Provides some examples of the impact of engineering on water in a global context	Provides one example of the impact of engineering on water in a global context	Does not provide examples of the impact of engineering on water in a global context
<i>Analyze the information gathered on engineering's impact on water</i>	Can determine the accuracy of information gathered and implications for a global society	Can determine the accuracy of some of the information gathered and identify some implications for a global society	Can determine the accuracy of information gathered but not the implications for a global society	Cannot determine the accuracy of information gathered nor the implications for a global society
<i>Synthesize their knowledge in the form of a newspaper article on water and the role of engineering</i>	Knowledge is synthesized in the form of a newspaper article	Knowledge is presented in the form of a newspaper article but is not synthesized	Some of the Knowledge is presented in the form of a newspaper article but is not synthesized	Cannot write a newspaper article
<i>Critique and discuss their Engineering Water: News Special Edition</i>	Applies the rubric to their own work and the work of peers and can identify how to make the News Edition better	Applies the rubric to their own work and the work of peers but cannot identify how to make the edition better	Applies the rubric to the work of their peers but cannot self-evaluate	Cannot apply the rubric to their own work or the work of peers

Coding

- Strongly meets criteria = 3 points
- Adequately meets criteria = 2 points
- Minimally meets criteria = 1 point
- Does not meet criteria = 0 points

Evaluation of Engineering Water: News Special Edition

Notes to the teacher

The following short answer questions are open ended. There are many correct answers to each of the questions. Consequently, the answers your students give to the questions will vary from student to student. However, you should look for an understanding that reflects the hands-on activity of writing news articles and creating a Special News Edition. Student answers should be linked to the data gathered, analyzed, synthesized, discussed, and written about in Engineering Water: News Special Edition.

Notes to the student

These are short answer questions. You should be able to answer these questions based on your work during the activity of preparing a News Special Edition.

1. Provide three reasons why water is an important global resource.
2. List three ways in which engineering plays a role in sustaining our water resources.
3. What impact does engineering have on water in your own life? Be specific and provide details.
4. What impact does engineering have on water globally (around the world)? Be specific and provide details.
5. How is the impact of engineering on water in your on life and globally the same? How is it different?

3.8 References

1. . <http://flickr.com/photos/liberato/171610084/>. CC-BY-SA 2.0 Generic
2. . <http://www.flickr.com/photos/darwinbell/286131360/>. CC-BY 2.0 Generic.
3. . <http://www-pm.larc.nasa.gov/triana/Earth.galileo.jpg>. Public Domain
4. . Microscopic view of cholera bacteria.. Public Domain
5. . <http://en.wikipedia.org/wiki/Image:Snow-cholera-map-1.jpg>. Public Domain
6. . <http://www.flickr.com/photos/imuttoo/1389979716/>. CC-BY-SA 2.0 Generic
7. . <http://flickr.com/photos/sararichards/199515354/>. CC-BY-SA 2.0 Generic
8. CK-12 Foundation. . CC-BY-SA
9. . http://commons.wikimedia.org/wiki/Image:Luftbild_Klaeranlage_Dresden_Kaditz.jpg. CC-BY-SA 2.0 Generic
10. CK-12 Foundation. Steps in a typical wastewater treatment process.. CC-BY-SA
11. . <http://flickr.com/photos/19378856@N04/2037098785/>. CC-BY 2.0 Generic
12. . http://commons.wikimedia.org/wiki/Image:Drought_Swimming_Hole.JPG. CC-BY-SA 2.0 Generic

CHAPTER **4** **Introduction to Engineering Design**

Chapter Outline

- 4.1 ABOUT THIS CHAPTER
 - 4.2 THE DESIGN PROCESS
 - 4.3 THE DESIGN PROCESS IN ACTION
 - 4.4 VOCABULARY
 - 4.5 REFERENCES
 - 4.6 INSTRUCTOR SUPPLEMENTAL RESOURCES
 - 4.7 REFERENCES
-

4.1 About This Chapter

Before beginning this chapter, look around you for a moment and notice how much of your environment has been designed by humans. Perhaps you are reading inside a building; people designed, engineered, and constructed it. This book has been designed; if you are reading it in a paper format, the paper, ink, and binding have been manufactured, while if you are reading it electronically, the computer on which you are reading has been designed and fabricated.

Almost every aspect of modern life depends on and is affected by technological **artifacts** such as bridges, buildings, vehicles, cell phones, computers, and so on. These technological artifacts are designed and created by engineers; the process by which engineers create is often called the engineering design process. ABET, the organization that accredits undergraduate university and college engineering programs, has developed the following definition of the engineering design process.

Engineering design is the process of devising a system, component, or process to meet desired needs. It is a decision-making process (often **iterative**), in which the basic sciences, mathematics, and the engineering sciences are applied to convert resources optimally to meet these stated needs.

Chapter Learning Objectives

After working through this chapter, you should be able to do the following:

- Explain what a design process is.
- Explain how engineering design differs from other design processes.
- Explain the different steps in the engineering design process.
- Apply each step of the engineering design process to design a product or process.
- Describe how the implementation the design process affects the quality of the resulting design.

4.2 The Design Process

The word *design* has several meanings. One meaning is a plan or drawing that shows the look and function of an object or structure before it is made. This is the meaning of design that we consider in this chapter. Examples of this meaning for design include

- a team of architects may develop the design of a building, specifying the building’s appearance and the layout of rooms, doors, and hallways;
- a team of engineers may develop the design for a new jet engine, specifying its structure and the materials from which it is built.

Figures 1 and 2 show examples of this type of design.

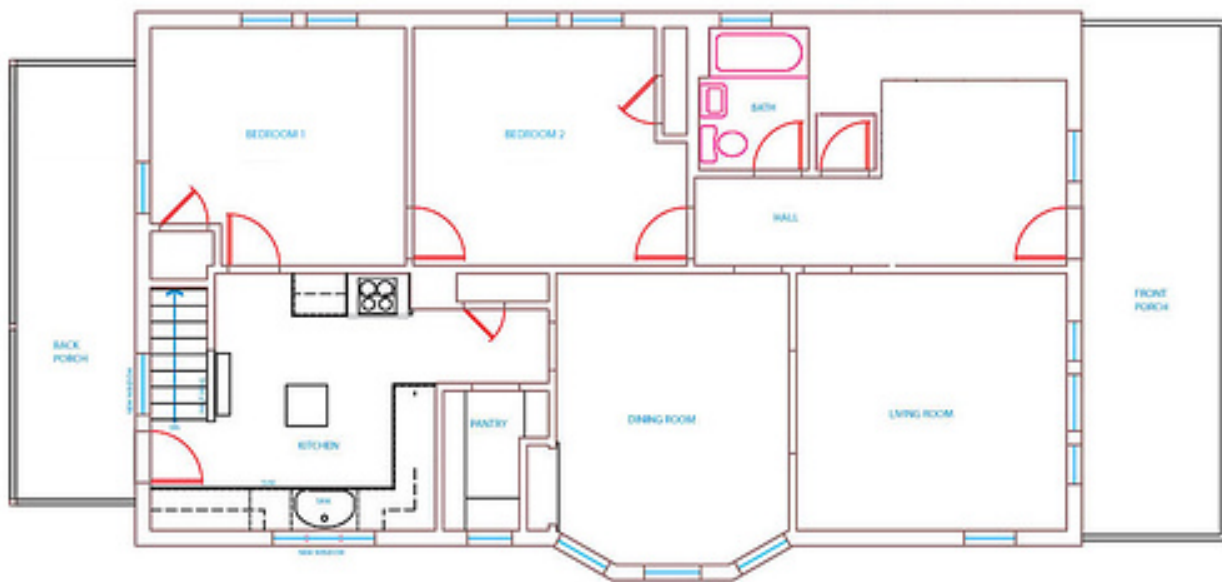

FIGURE 4.1

The floor plan of the first story of a house. Architects document their designs using such floor plans.

In general conversation, the word *design* is often used to mean “an arrangement of lines or shapes to form a pattern or decoration.” Figure 3 shows an example of this meaning for design; this is *not* the meaning that we are considering in this chapter.

A process by which a design for an object or a structure is created is called a *design process*. All design processes have similarities. They all involve creativity. They all involve making decisions. However, engineering design tends to require a more extensive and specialized knowledge of technology, math, and science than other types of design.

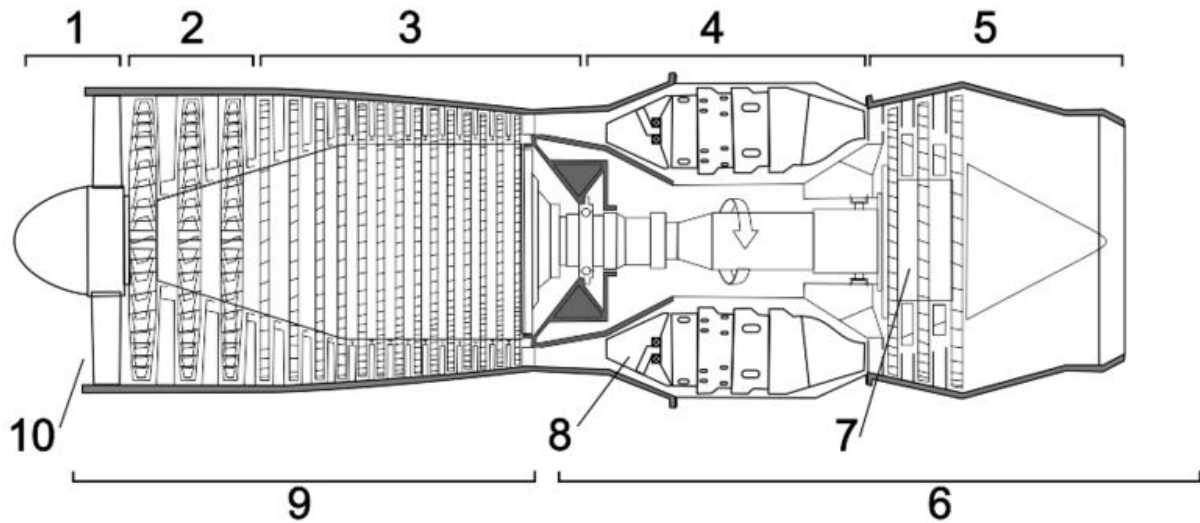

FIGURE 4.2

A design of a jet engine.

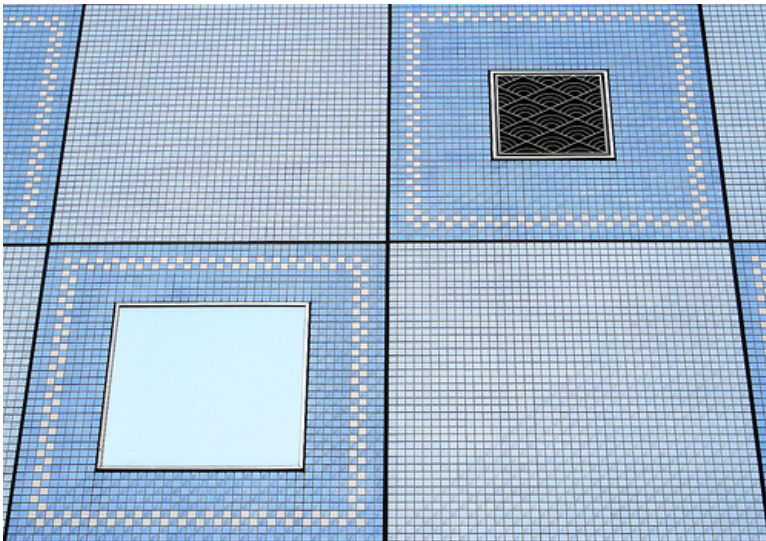

FIGURE 4.3

A design can be an arrangement of shapes and lines that forms a decorative pattern. This is *not* the type of design that we will consider in this chapter.

Engineering Design

Teams undertake several different types of engineering design projects. Most projects involve modifying or enhancing an existing product or process; these projects are described as **incremental design**. Sometimes a new product is developed from scratch. Such a project would be a new design. Both types of projects use the design process.

The purpose of most design projects is to develop an object, structure, or process that meets the needs of **customers** and **stakeholders**. A customer is someone who will use the designed object; customers usually pay for the product.

A stakeholder is someone who has an interest in the product. Customers are stakeholders; other stakeholders may include government agencies, companies, and individuals. For example, stakeholders for a new automobile design might include the individuals who will purchase it, the mechanics who will maintain and repair it, the Environmental Protection Agency that will monitor its emissions, and the oil companies that will supply its fuel.

Design problems are almost always open ended—they rarely have a single correct solution. Instead, there are usually several solutions that will satisfy the desired needs. One of the challenges of design is to choose from the vast number of possible solutions. Indeed, engineered products may be very complex, and the design of such products may require that a design team make hundreds or thousands of decisions. Without a clearly defined process to follow, the team may not develop designs that meet the needs of customers or other stakeholders; the team may make poor decisions or lose sight of the important attributes of the product. Thus, it is important to use a structured design process. Structured design processes offer several advantages. They provide a framework in which the team decision-making is made explicit and the decision process can be well documented. They also reduce the likelihood that important issues will be forgotten or overlooked.

In this section, we describe “the engineering design process,” which may give the impression that there is only one correct process. In reality, many processes have been successfully applied to engineering design. The design process discussed in this section may not always be the best for a given project or problem. The design process should not be applied blindly, but should be adapted to fit the circumstances of the design team and the particular project. The design process should also be subjected to a continuous improvement process so that the design team’s performance improves over time.

The engineering design process may not result in a **viable** design for several reasons:

- Incorrect or unrealistic assumptions.
- A lack of understanding of the desired needs or underlying problems to be solved.
- Errors in design specifications or representations (e.g. **models** and drawings).
- Inadequate testing of **prototypes**.
- Poor design choices.

Sometimes, poor design decisions made early in the process will make it impossible to develop a design that successfully meets customers’ needs.

A Design Process

In this section we present a typical engineering design process. Other descriptions of the design process may break the process into somewhat different steps and may use somewhat different terms to describe the steps, but most design processes are similar to this one. An example of how this design process could be applied is in The Design Process in Action section.

Our basic engineering design process includes the steps shown in Figure 4. Note that Figure 4 shows each step being completed before the next step begins; this process is sequential. In many real-life situations, the design team may revisit a step several times to create the final design. We now describe the steps in more detail.

Define the problem. In the problem definition step, the needs of potential customers are investigated; potential competitors are identified and their market positions are **characterized**; **constraints** imposed by government regulations or technological limitations are identified; and constraints on the design effort such as available personnel, time, and money are established. The problem definition process results in a clear understanding of the scope of the design project and the resources available to solve the design problem. This understanding is often expressed in a **problem statement**. This understanding is also expressed in the form of criteria and constraints.

Identify criteria and constraints. **Criteria** and **constraints** are used to evaluate the quality of a design. Constraints describe conditions that must be met by the design and design process; a design must meet all constraints. Criteria

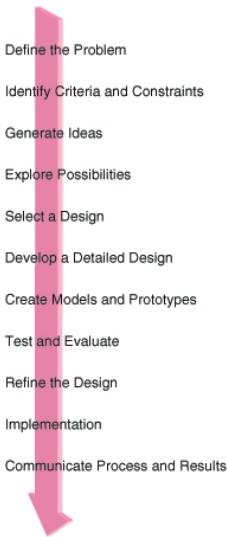
**FIGURE 4.4**

A design process.

are measurable values that can be used to compare several designs and determine which is better.

Generate ideas. Once criteria and constraints are identified, the design team generates ideas for designs. These ideas come from many different sources; these include existing products (including competitors’ products), brainstorming and other creative activities, and market and technical research. Ideas are combined to generate potential designs; at this stage, designs are concepts without a significant level of detail.

Explore possibilities. After potential designs are generated, they are explored to understand their characteristics and likely advantages and disadvantages.

Select a design concept. Potential designs are evaluated relative to the constraints and criteria, and one or more is selected to be designed in detail and prototyped. This selection is made using a structured process that requires the constraints to be met and chooses the best design according to the criteria.

Develop a detailed design. The selected design is developed in more detail. The **design architecture** is established by identifying physical and functional chunks. Shapes and **dimensions** are determined, materials and fabrication processes are selected, and product components are identified. The design is developed in enough detail that prototypes and models of the design can be made.

Create models and prototypes. One or more prototypes are typically implemented to characterize various aspects of the design. Prototypes may be physical models of the design in which dimensions, materials, and fabrication processes emulate important aspects of the design. Increasingly, prototypes are implemented using computer modeling software that simulates mechanical, electrical, and other characteristics of the product.

Test and evaluate. Prototypes are tested to see whether the design meets all constraints and performs acceptably relative to the criteria.

Refine the design. Testing and evaluation may reveal weaknesses of the design or indicate ways in which the design may be improved. At this point, the design may be refined to better meet the criteria and constraints. Sometimes, testing and evaluation show that a design will not work, so that a different design concept must be selected; in this case, the process goes back to the “Select a design concept” step.

Implementation. Depending on the context, the design is produced or constructed.

Communicate process and results. The activities and results of the design process are documented. This documentation is communicated to the appropriate stakeholders in the design.

The design process in Figure 4 is often called a sequential process because each step follows the previous one in direct sequence. This model does not account for the iterative nature of many actual design projects; as designs are developed, prototyped, and evaluated, their strengths and weaknesses are better understood and changes are made to the design on the basis of this improved understanding. After changing the design, the process of prototyping and evaluating is repeated. The design process in which the processes are iterated is often called a spiral design process. A spiral design process is illustrated in Figure 5.

**FIGURE 4.5**

A spiral design process. Changes are made in the design, and then the improved design is evaluated.

The advantage of using a spiral design process is that the end design is often much better than the initial design. The significant disadvantage of the spiral design process is that time and resources are required for each loop in the spiral; if these are not planned for, the project may easily be late and over budget.

Review Questions

Multiple Choice

The following questions will help you assess your understanding of the Discovering Engineering section. There may be one, two, three, or even four correct answers to each question. To demonstrate your understanding, you should find all of the correct answers.

1. Which attributes describe the engineering design process?
 - a. Creativity
 - b. Specialized knowledge of math and science
 - c. Decision making
 - d. Specialized knowledge of technology
2. Incremental design means that the
 - a. design process is slow
 - b. an existing product or process is modified
 - c. design is done in pieces
 - d. an existing product or process is enhanced
3. The design process may not produce a good product because

- a. the team was made up of different kinds of engineers
 - b. materials were delivered too late to use
 - c. the engineers focused on attributes of the product
 - d. prototypes were not tested adequately
4. Which of these is used to evaluate the quality of a design?
 - a. The number of prototypes tested
 - b. The spiral design process
 - c. Criteria and constraints
 - d. The size of the engineering firm
 5. What is the first step in the design process?
 - a. Explore possibilities
 - b. Define the problem
 - c. Select a design
 - d. Generate ideas
 6. What is the last step in the design process?
 - a. Communicate process and results
 - b. Test and evaluate
 - c. Refine the design
 - d. Implement
 7. A good design
 - a. does not have constraints
 - b. is not limited by criteria
 - c. meets constraints
 - d. develops criteria and constraints

Free Response Questions

8. Why are planning and evaluation as important as creativity in the design process?
9. What is the difference between engineering design and other types of design (architectural, fashion, etc.)?

Review Answers

The Design Process

1. a,b,c,d
2. b,d
3. d
4. c
5. b
6. a
7. c

4.3 The Design Process in Action

In this section, we go through an example of a team using the design process. This section provides more detail about the steps of the sequential design process.

Case Study

To provide concrete examples throughout this section, we will use a design case study. In this case study, we will follow the design process used by an intrepid team of engineers who work at a small manufacturing company to develop a product that solves some of the problems with current commuting options. At the beginning of their project, the team chose a suitable engineering name for their project: the **sustainable** commuter vehicle, or SCV for short.

According to the United States Department of Transportation, in 2000, over three-fourths of the trips made to and from work were made by individuals traveling alone in a car, sport utility vehicle, or truck. In some ways, jumping in the car and going is the hallmark of modern American life. Americans prize the convenience and comfort of the modern automobile, even though it creates some serious problems.

- Vehicles create 20% of **greenhouse gas** emissions in the United States and appear to be a significant contributor to future climate change. **Carbon dioxide** is one of the principle greenhouse gasses emitted by vehicles.
- A typical American household spends more money on driving costs than it spends on food.
- In most major metropolitan areas, “rush hour” (congested traffic conditions similar to those in Figure 6) now lasts six to seven hours a day.
- Traffic congestion costs \$63.1 billion per year. Each year, commuters stuck in traffic jams waste 2.3 billion gallons of fuel, not to mention their time or frustration.

Is there a way to solve some of these problems without completely giving up the comfort and convenience that we have come to expect?

Activity

To increase understanding of the issues faced by the engineering team, complete one or more of the following exercises that involve problems associated with commuting.

- Research the issues associated with commuting in your area. These issues might include traffic congestion, accidents, and pollution.
- Do you know anybody who commutes regularly to work alone in their automobile? Talk to them about the benefits and drawbacks associated with this.
- Find information on transportation planning in your area. How much money is spent developing new roadways? How much money is spent upgrading and maintaining existing roads? Is the current road network effective?
- What problems do environmental activists in your area see with the current commuting **infrastructure**?

With your understanding, write a paragraph describing the commuter problem from the perspectives of the commuter, the city planner, and the environmental activist.

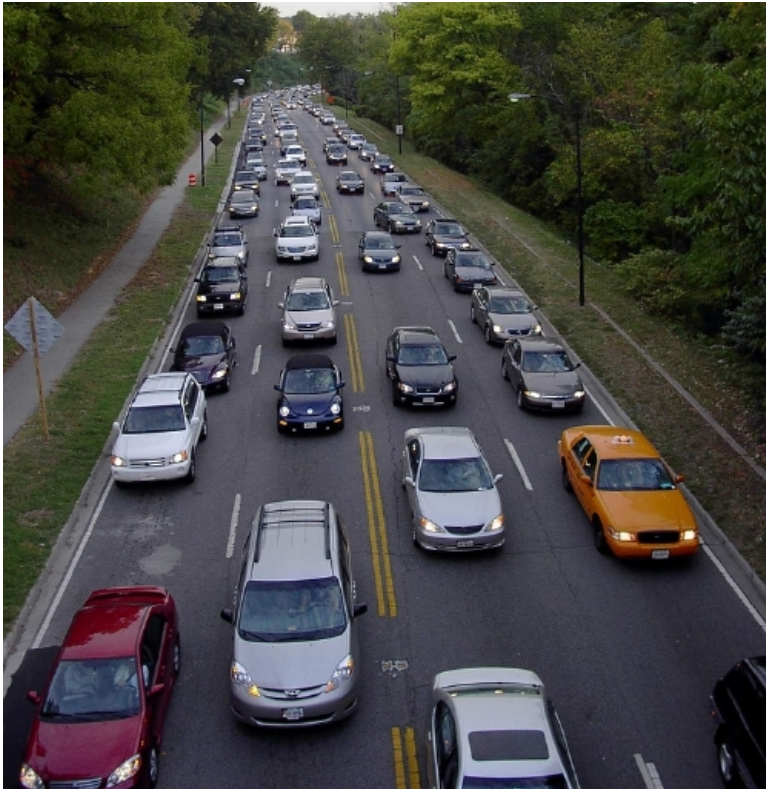
**FIGURE 4.6**

Rush hour traffic in Washington, D.C. Heavy traffic and long delays, as well as the associated air pollution and fuel consumption, are major problems for communities.

Activity

Spend an hour working with a team of classmates to develop a design solution to the commuter problem. Write a paragraph that describes what your team did during the hour. Then consider the following questions:

- Did your team find a solution? If not, why not?
- What processes did your team use to find solutions?
- How good is your solution? How do you know whether it is good or not?
- How well did you document your design process?

In this section, we will describe the (fictional) design process used by the SCV team to address the commuting problem.

Define the Problem

Problem definition is one of the most critical steps in the design process. Since the design team trying to solve this problem will expend a significant effort, it is very important that the problem being addressed is actually the problem that is important to potential customers. It is also important that the problem be clearly defined and understood by the design team.

Many techniques can be used to clearly define and understand the problem (see Fogler and LeBlanc, 1995). These techniques include

- gathering information from customers and other stakeholders,

- finding expert information (either in person or through books or other sources),
- doing a **root cause analysis** to identify what the real problem is.

The SCV design team began by gathering information about the issues associated with vehicular commuting and traffic congestion. They found and read several government reports. They interviewed various stakeholders in the commuting problem; these included people who commute to and from work in their car each day, officials from state and local departments of transportation, and representatives of environmental groups. They also used their own experience as commuters.

Activity

Using your understanding of the issues associated with commuting, develop a problem statement to describe the problem that the design team should solve.

On the basis of the research that they performed, the design team defined their design problem to be “Design a commuter vehicle that is environmentally friendly, acceptable to a typical commuter, and compatible with existing transportation infrastructure.”

The design team also expanded this problem statement to make it more informative as follows. Environmentally friendly means that the vehicle produces as little pollution and greenhouse gases as possible and uses sources of **renewable energy**. Acceptable to the commuter means that the vehicle is convenient (does not require the commuter to wait), comfortable, and affordable. Compatible with existing infrastructure means that the vehicle does not require changing roads, bridges, etc., and does not require the development of a new fuel distribution system.

Identify Criteria and Constraints

The problem statement is used as a starting point to develop an understanding of the characteristics of a good solution. These characteristics are described in terms of constraints and criteria. A constraint is a limitation or condition that must be satisfied by a design. A criterion is a standard or attribute of a design that can be measured. The constraints and criteria are used in subsequent steps of the design process to determine which of many possible designs should be implemented.

Activity

Using your problem statement or the one developed by the design team, develop criteria and constraints that could be applied to decide whether a potential commuter vehicle design is good or not.

From the problem statement, the SCV design team identified criteria and constraints that would apply to their design. They identified the following constraint:

- Does not require new transportation infrastructure.

They identified the following criteria:

- The amount of pollution and greenhouse gases emitted per mile traveled by a commuter.
- The percent of the energy used from renewable sources.
- The convenience for the commuter.
- The comfort of the commuter.
- The cost to use the vehicle for five years (includes the purchase price, maintenance, and fuel).

Activity

Compare your criteria and constraints with the ones developed by the design team. What are the strengths of your criteria when compared to the design team's? What are the weaknesses?

Are each of your criteria measurable? Does each accurately reflect the problem statement?

Generate Concepts

With criteria and constraints identified, the design team begins to **generate concepts** for the design. This is the step in which creativity plays a very important role—good designs are often very different from existing solutions to a problem. In addition to creativity, the design team must use discipline to ensure that they explore enough options and potential solutions to guarantee a good design. Therefore, it is important to use a structured process to generate concepts for a design. Many different processes could be used. The one presented here is adapted and simplified from *Product Design and Development* by Eppinger and Ulrich. It includes the steps of problem decomposition, searching externally and internally for ideas, and systematically exploring possibilities.

Decompose the Problem into Subproblems

When a design problem is complex, it can be very beneficial to **decompose** the problem into subproblems. Subproblems are smaller problems that must be solved in order to solve the overall problem.

Activity

Think of as many subproblems as you can for the SCV.

The SCV team broke the overall problem into subproblems as shown in Figure 7. Each of the subproblems is simpler to approach than the whole problem. The energy source is how the vehicle gets energy to move; for example, the energy source for a regular car is gasoline. The vehicle **configuration** is the number of wheels on the vehicle and where they are placed relative to the driver. The drive mechanism transforms energy into the locomotion of the vehicle.

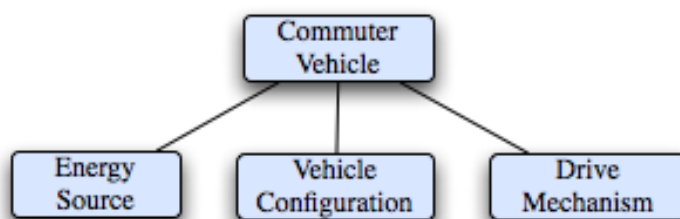

FIGURE 4.7

Decomposition of the commuter vehicle problem into three some problems: energy, configuration, and drive mechanism.

Search Externally for Ideas

Once the problem is decomposed into subproblems, the design team can begin to search for ideas to solve each subproblem. One source of ideas is to look at existing products and ideas to see whether there are already solutions to the overall problem or the identified subproblems. Sources of external information include interviews with potential customers or experts in the subproblem areas, patent and other technical databases, and existing products. Much of this information is now available on the World Wide Web.

Activity

Identify sources of information that you could use to find ideas for your subproblems. Use one these resources to develop a list of potential solutions to one of your subproblems.

The design team researched externally to find potential energy sources for their commuter vehicle. They discovered the following energy sources:

- Solar energy converted into electricity using **photovoltaic solar cells**. This is the power source used by the Mars rover Sojourner (Figure 8).
- Nuclear energy
- Wind Energy converted into electricity using a turbine and generator. This might be a smaller version of a wind turbine such as that shown in Figure 9.
- Human power.
- Gasoline, a nonrenewable fossil fuel.
- A fuel cell that converts hydrogen and oxygen into electricity. Figure 10 shows the fuel cell that provides power to the Toyota Fuel Cell Hybrid Vehicle (FCHV).
- Ethanol made from corn or other plants; ethanol can typically be used like gasoline with only slight modification to the car's fuel system.

After some reflection, the team discarded nuclear energy and a fuel cell as being **unfeasible** given the current state of technology.

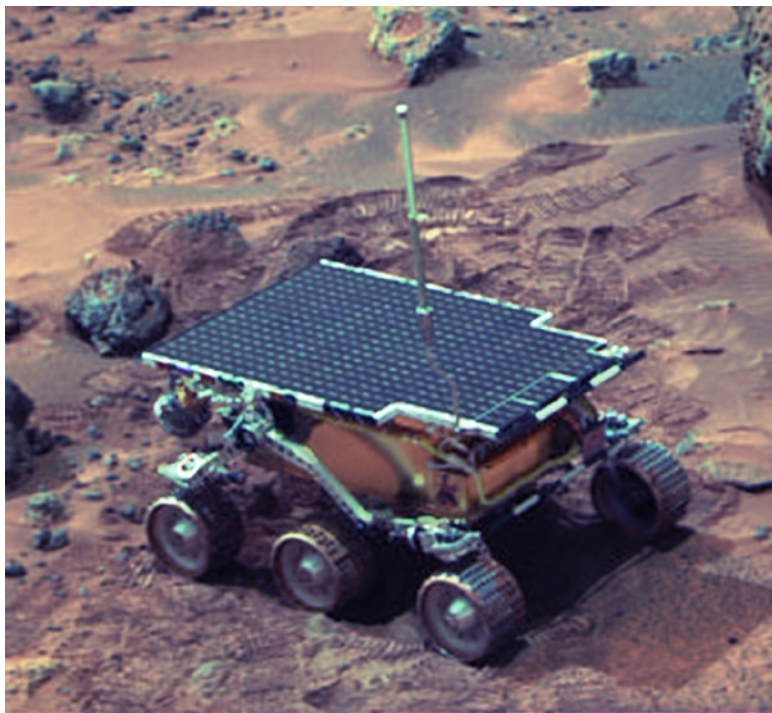

FIGURE 4.8

The rover Sojourner on the surface of Mars. The flat black panel on the rover's top is a panel of photovoltaic solar cells that provided power for 83 days.

The team also searched for possible drive mechanisms. They settled on three types:

- A clutch, gearbox, and drive shaft similar to the drive train used for most manual transmission, rear wheel drive automobiles.
- Electric motors that are located in the hubs of each wheel and drive each wheel directly. Figure 11 shows a bicycle hub that contains an electric motor; electric motors can also be put in the hubs of car wheels.

**FIGURE 4.9**

Large wind turbines on a wind farm in Iowa. These turbines use the wind's energy to generate electricity.

- A chain drive similar to that used in motorcycles and bicycles. Figure 12 shows a motorcycle chain drive.

Search Internally for Ideas

Searching internally for ideas is often called brainstorming; Figure 13 illustrates a group brainstorming. The goal of brainstorming is to develop as many ideas as possible without worrying whether they are feasible. Sketches are often good tools to capture ideas and to generate new ideas.

Activity

Brainstorm ideas that could solve one of your subproblems.

To solve the vehicle configuration subproblem, the design team brainstormed several possible configurations; a configuration is an arrangement of wheels around the passenger compartment. They brainstormed four different configurations, each have between one and four wheels. After brainstorming the configurations, they found photographs online to represent each configuration. These photographs are presented in Figure 14. After reflection, the team discarded the one wheel configuration as being unfeasible. They noted that both two-wheel configurations would require some method of balancing, but kept them both because there are existing vehicles that use each configuration.

Explore Systematically

Searching externally and internally will generate many possible solutions for each of the subproblems. To ensure that good solutions are not left out of the set of possible designs, it is important to use a structured process to examine possible combinations of subproblem solutions. A tool for systematic exploration is the concept combination table. In this table, solutions for each of the subproblems are combined; Figure 15 shows a concept combination table for the commuter vehicle.

To use the table, a solution for each subproblem is combined, and then a sketch or description of the resulting concept is created. For example, if the concepts are combined as shown in Figure 16, then the possible design in Figure 17

**FIGURE 4.10**

The Toyota Fuel Cell Hybrid Vehicle is powered by a fuel cell that generates electricity from hydrogen and oxygen. The fuel cell is still experimental technology that is currently extremely expensive, but shows promise for the future.

results. This design could be very similar to a standard bicycle with an added solar cell canopy that shades the driver. The pedals of the bicycle would be removed and replaced by an electric motor that drives the vehicle forward.

Note that the combination of design elements often does not provide a complete design concept; decisions must be made to fill in the gaps. For example, if solar cells are included as part of a design, they could be placed on the vehicle or they could be part of a fixed charging station that charges a battery on the vehicle; the design team must decide which configuration would make the most sense.

Activity

Using the solutions to subproblems that you have developed in previous activities, create a concept combination table for the problem. Use your concept combination table to generate five or six design concepts. Sketch each of your concepts.



FIGURE 4.11

This bicycle hub contains an electric motor that moves the bicycle.



FIGURE 4.12

This chain drive transmits power from the motorcycle engine to its rear wheel.

The design team used the concept combination table to develop six concepts.

Concept 1: The design in Figure 17.

Concept 2: The energy source is a combination of solar cells and wind energy; the solar cells and wind turbines are installed at centrally located municipal charging stations and used to charge batteries. The vehicle configuration is a small, three-wheeled car with an enclosed passenger cabin that seats two people. The drive mechanism is wheel hub motors installed in the three wheels, with energy supplied to the motors from the charged batteries; these motors use **regenerative braking** to recover energy as the vehicle slows down.

Concept 3: This concept combines a gas engine with a four-wheeled configuration and a clutch, gearbox and drive shaft to form a traditional automobile. To be attractive as an alternative commuter vehicle, this design would be a two-seater subcompact.

**FIGURE 4.13**

Students write their ideas on white boards during a brainstorming session.

Concept 4: This concept is the same as Concept 3, except that the engine is run on ethanol. Thus, Concept 4 is a small, two-seater alternative fuel vehicle.

Concept 5: The energy source is a combination of solar cells and human power. The vehicle configuration is three wheels, and the drive mechanism is a chain drive with gears. This is similar to a solar-assisted tricycle.

Concept 6: The energy source is a combination of solar cells mounted on the vehicle plus a battery; the battery can be charged at the user's home using a renewable energy source (wind or solar cells) or plugged into the user's home electricity system. The battery provides most of the energy, while the solar cells extend the life of the battery on sunny days. The configuration is two wheels side by side with room for a single passenger, and the drive mechanism is wheel hub motors. The motors are controlled to keep the vehicle balanced (similar to the Segway personal transport device in Figure 14).

Some combinations will not make sense or will result in a concept that is clearly unfeasible. For example, any concept that uses wheel hub motors must use an energy source that generates electricity.

Explore Possibilities and Select a Design

The design concepts are explored to understand their characteristics. For example, exploring Concept 1, the solar-powered bicycle in Figure 17, leads to the following conclusions:

- The design would use only renewable energy.
- The design would be relatively inexpensive to manufacture and would cost nothing to operate.
- The design may not be convenient for the commuter, since the motor will only run when sunlight falls on the solar array. This means that it is impossible to commute at night or on cloudy days.
- The design will not be particularly comfortable for the commuter, since they will be exposed to hot, cold, and rainy weather, and the seat appears to be uncomfortable.

Activity

Explore the possibilities of one of the concept combinations developed in the previous activity.

**FIGURE 4.14**

Possible solutions to the subproblem of configuring the wheels around the passenger.

When exploring the possibilities of a design concept, the team may discover ways in which the design can be improved. For example, Concept 1 might be improved by providing a more comfortable seat and by adding a battery that can store energy for use when it is dark or cloudy and the solar array does not generate electricity.

Once several design concepts have been developed and explored so that their advantages and disadvantages are understood, the design team must choose one concept that will be used to create the design for the product. It is usually best to choose the concept using a structured decision process. In a structured decision process, each of the concepts is evaluated to see whether it meets the constraints and is compared with the other concepts using the criteria; the best concept according to the criteria that meets the constraints is typically selected to implement the product.

Energy Source	Vehicle Configuration	Drive Mechanism
Solar cells (photovoltaic)	Four wheels	Clutch, gear box, and drive shaft
Human Power	Three wheels	Wheel hub motors
Wind Energy	Two wheels (bicycle)	Chain drive with gears
Gasoline (fossil fuel)	Two wheels (side to side)	
Ethanol		

FIGURE 4.15

The concept combination table for the commuter vehicle.

Energy Source	Vehicle Configuration	Drive Mechanism
Solar cells (photovoltaic)	Four wheels	Clutch, gear box, and drive shaft
Human Power	Three wheels	Wheel hub motors
Wind Energy	Two wheels (bicycle)	Chain drive with gears
Gasoline (fossil fuel)	Two wheels (side to side)	
Ethanol		

FIGURE 4.16

The concept combination table is used to generate a particular possible design.

In the case study, Concept 2 did not meet the constraint because it would require cities to build charging stations, so it was eliminated from consideration. Using the criteria as a guide, the design team determined that the two best designs were Concept 1 and Concept 5. They ranked high because of low pollution, using only renewable energy, and being low cost compared with other options. However, it is clear that these designs are the least comfortable for the consumer, and may therefore not be commercially successful. At this point, the design team could choose to use one of these designs and go forward in the design process; or, they may feel after seeing the outcome of the selection process that their criteria did not accurately capture their customers' desires. In this case, they may go back and improve their criteria, then repeat the decision process. Or, they may determine that better concepts may

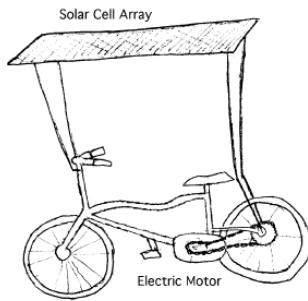
**FIGURE 4.17**

A sketch of the possible design obtained by from the concept combination table in Figure 16. Note that engineers often use rough, hand-drawn sketches at this point in the design process to understand design concepts and explore their strengths and weaknesses.

have been developed with different combinations of subproblem solutions or through different assumptions in the Explore Possibilities step, and thus repeat the Concept Generation and Explore Possibilities steps.

Sometimes, a design does not satisfy the constraints but could be easily modified to satisfy the constraints. For example, in Concept 2 if a battery charging station were to be built at each customer's house, the concept could be judged to meet the constraint. At other times, one design will score low because it has a particular flaw that can be corrected by combining it with characteristics of another design. Thus, the team should see if there are any designs that score low because of one aspect and can be corrected or if two designs can be combined to provide a better design.

Develop a Detailed Design

After concept selection, the team has a general design concept; they have decided how each subproblem will be addressed and have an overall understanding of the design. Before the design can be manufactured, the team needs to develop the details of the design. A detailed design includes

- The shapes and dimension of all physical components.
- An understanding of which components will be acquired from external vendors and which will be fabricated within the company and, if fabricated within the company, the materials and fabrication processes to be used.
- A detailed schematic diagram of any electrical subsystems and computer code for any embedded processors.
- Assembly processes.

The development of a detailed design from a design concept may occupy the majority of time allocated to a new product design project. This step will also have a significant impact on the success of the project; a poor detailed design can ruin a good design concept.

In the process of developing a detailed design, the team may use many or all of the subsequent design steps of prototyping, testing, and refinement. This process may require many iterations as the testing of prototypes reveals previously unknown characteristics of the design.

A major step in the process of going from a design concept to a detailed design is the development of the design architecture. The design architecture is “the assignment of the functional elements of the product to the physical building blocks of the product” (Eppinger and Ulrich, 2003).

For example, one architectural decision for the SCV design is how to incorporate the solar array into the design. Should the array be a separate physical block of the vehicle, for example creating the canopy structure in Figure 17, or should the array be created as an integral part of the frame? The first option represents a modular architecture, while the second option represents an integrated architecture.

Prototype, Test, and Refine

A prototype or model is a representation of some aspect of the design. The purpose of models and prototypes is to provide additional understanding of the design and its performance. A prototype may implement only a small portion of design or may be comprehensive and implement the whole design. For example, while developing a detailed design for Concept 1, the design team may initially wish to develop a prototype only of the electrical system (the solar cell array and the electric motor). Once the electrical system design is verified, they may implement a comprehensive prototype of the whole vehicle.

Prototypes may be physical or virtual. A physical prototype may be implemented out of materials that are very similar to those that will be used to manufacture the final design, or, to reduce cost or save time, the prototype may be implemented out of other materials. A virtual prototype may be created using a computer-aided design and drafting (**CADD**) program. Modern programs can simulate many aspects of a physical system, revealing flaws or promoting understanding of the design without the need to implement it physically.

One important function of a prototype is to test whether the design will work as expected. Understanding of the design and confidence that it will work is gained as prototypes are tested and evaluated relative to the constraints and criteria for the design. Testing procedures should be carefully planned to ensure that questions about the design are answered without requiring too much time and resources. The test results should be evaluated relative to specifications that reflect the constraints and criteria.

Testing and evaluation of the prototype may reveal weaknesses in the design or may provide information that can be used to improve the design. In this case, the design will often be refined, particularly if it does poorly with respect to some of the criteria or constraints. Sometimes, the chosen design concepts do not meet the criteria or constraints, and the design team must go back and perform more concept generation and then select another concept. This is an integral part of a spiral design process.

Communication and Implementation

As the design team has gone through the design process, they have kept records of the different processes that they used and results of these processes. Often, this information is used to create user manuals and maintenance manuals for the product. This information is important for team members who will be required to update or modify the design in the future. Lessons are learned in the design process that should be conveyed to other teams in the company or perhaps to external stakeholders in government or academia. An important part of the design process is to document these issues and communicate the results to the appropriate stakeholders.

As the design is completed, the effort to implement the design increases. If the design is of a product that is manufactured, a manufacturing system must be developed. For example, in the alternate commuter vehicle design, suppliers for components such as motors and solar cells must be located; facilities for manufacturing the frame are created; and a sales and marketing staff are identified.

Review Questions

Multiple Choice

The following questions will help you assess your understanding of the Discovering Engineering section. There may be one, two, three, or even four correct answers to each question. To demonstrate your understanding, you should find all of the correct answers.

1. Design problems are broken down into subproblems because
 - a. each design team member needs a specific problem to solve
 - b. the customer or stakeholders do not understand the overall problem
 - c. smaller problems must be solved in order to solve the overall problem
 - d. engineering companies make more money solving many smaller problems
2. When a design team searches externally for ideas they
 - a. interview customers
 - b. look at existing products
 - c. look at technical databases
 - d. talk to experts in the problem area
3. A concept combination table helps you to
 - a. explore design ideas systematically
 - b. see the complete design concept
 - c. identify the overall design problem
 - d. keep track of rejected designs
4. A concept screening matrix is used to
 - a. select a design
 - b. eliminate constraints
 - c. develop a design
 - d. eliminate criteria
5. A prototype can be
 - a. a physical representation
 - b. a scale model
 - c. a virtual representation
 - d. a final product
6. Implementation means that a
 - a. physical model is built
 - b. virtual model is built
 - c. prototype is built
 - d. product is manufactured
7. A design is refined because
 - a. it has met the constraints and criteria
 - b. testing has found weaknesses in the design
 - c. a product must go through the spiral design process
 - d. there are no further improvements to make
8. Communicating processes and results is done by
 - a. posting designs on a website
 - b. creating a users manual
 - c. text messaging team members
 - d. emailing manufacturers
9. A detailed design includes
 - a. a market analysis
 - b. shapes and dimensions of all physical components
 - c. computer code
 - d. assembly process

10. The step in the design process called Explore Possibilities is used to
 - a. make additional designs
 - b. improve the design
 - c. understand the design characteristics
 - d. test the prototype
11. Searching internally for ideas is called
 - a. mind searches
 - b. design sessions
 - c. idea dumps
 - d. brainstorming
12. When engineers generate ideas in the design process they
 - a. use an unstructured approach
 - b. use a step by step approach
 - c. use a mathematical approach
 - d. use a structured approach
13. Which techniques are used to define the design problem?
 - a. Find expert information
 - b. Try to identify the real problem
 - c. Gather information from customers
 - d. None of the above

Free Response Questions

14. How can you tell the difference between a good design and a bad design?
15. What is the difference between engineering design and other types of design (architectural, fashion, etc.)?
16. How do you know that your design team has considered enough ideas to ensure that they develop a good design?
17. What are the characteristics of a good problem definition statement?
18. What are the steps of the design process? Why are they not always completed in order?
19. How do you use team decision-making tools in the design process?
20. How do you create a detailed design from a design concept?

Review Answers

The Design Process in Action

1. c
2. a,b,c,d
3. a
4. a
5. a,b,c
6. d
7. b
8. b
9. b,c,d
10. b,c
11. d

12. d

13. a,b,c

4.4 Vocabulary

Artifact

An object made by a human being for a particular purpose.

CADD

CADD stands for computer-aided design and drafting. It is the practice of using computer software to represent the geometry of designed objects.

Carbon dioxide emissions

Carbon dioxide is a gas that results from burning fuels that contain carbon (e.g., coal and gasoline). Because carbon dioxide is a greenhouse gas that traps solar radiation, release of large amounts of carbon dioxide into the atmosphere by burning fossil fuels is believed to contribute to global warming.

Characterize

Something is characterized by discovering its distinctive features.

Concept generation

The process of developing ideas that may be used to create a design.

Configuration

An arrangement of the elements of a design in a particular form.

Constraint

A constraint is a limitation or condition that must be satisfied by a design. Constraints are either satisfied or they are not.

Criterion

A criterion is a measurable standard or attribute of a design; for example, weight and size are both criteria. Criteria are used to compare different possible designs and determine which better solve the design problem.

Customer

A person or organization that pays for the design either directly or through the purchase of a product.

Decompose

Decompose means to break down into simpler parts.

Design architecture

The design architecture is the assignment of the functions that the design performs to the physical building blocks of the design.

Dimension

A specification of height, width, depth, or length.

Greenhouse gas

A greenhouse gas is a gas in the atmosphere that traps solar radiation and re-radiates it as heat, leading to warming of the environment.

Incremental design

The incremental design process begins with an existing design that is modified.

Infrastructure

Infrastructure is the basic structures and organization needed for the operation of a society. For example, the automotive transportation infrastructure is the roads, bridges, traffic signals, traffic signs, etc. necessary to drive cars.

Iterative

An iterative process is one that may be repeated.

Model

A model is a purposeful abstract representation of some aspect of a design. Types of models include equations, physical representations, computer representations, and other representations.

Photovoltaic

Photovoltaic means that light energy is converted into electrical energy (see also solar cell).

Problem statement

A problem statement is a concise description of the problem or need a design will address.

Prototype

A prototype is a first or a preliminary model of the design or some aspect of the design. Prototypes are often physical models, but increasingly computer models are used as prototypes. Prototypes are used to evaluate designs and discover flaws and weaknesses.

Regenerative brakes

Brakes that slow a vehicle by converting its energy of motion into electrical energy that can be stored in a battery.

Renewable energy

Renewable energy is energy that comes from sources that are not permanently depleted by use. For example, solar and wind energy are renewable, while coal and oil are nonrenewable.

Root cause analysis

An analysis of a problem or situation to find the real cause (root cause) of the problem and deal with it; in the absence of a root cause analysis, people often deal only with the symptoms of the problem.

Solar cell

A solar cell is a device typically made of metal and semiconductors that converts light energy into electrical energy.

Stakeholder

A stakeholder is a person or organization who has a stake in (e.g. an interest in or one who may be affected by) a design project. Stakeholders often include users and customers, the design team, and the company that employs the design team.

Sustainability

A sustainable solution is one that can be continued without using up non-renewable resources.

Unfeasible

A design is unfeasible if it does not meet the constraints.

Viable

Viable means able to work successfully.

4.5 References

- ABET, Inc. “Criteria for Accrediting Engineering Programs 2007–2008.” Downloaded March 17, 2007. Available on the web at
- http://www.abet.org/uploadedFiles/Accreditation/Accreditation_Process/Accreditation_Documents/Archive/criteria-eac-2010-2011.pdf
- H. Scott Fogler and Steven E. LeBlanc. *Strategies for Creative Problem Solving*. Prentice-Hall, Upper Saddle River, NJ, 1995.
- Yousef Haik. *Engineering Design Process*. Thomson-Engineering, 2002.
- Gerhard Pahl and Wolfgang Beitz. *Engineering Design: A Systematic Approach*. Springer, 1999.
- Karl Ulrich and Steven Eppinger. *Product Design and Development*. McGraw-Hill/Irwin, 3rd edition, 2003.
- US Department of Transportation. “BCW: About the Program—Facts and Figures.” Downloaded October 2006. Available on the web at
- Joseph W. Walton. *Engineering Design: From Art to Practice*. West Publishing, St. Paul, MN, 1991.

4.6 Instructor Supplemental Resources

Standards

ASEE Draft Engineering Standards. This chapter is focused on “Dimension 1: Engineering Design” of the ASEE Corporate Members Council Draft Engineering Standards; these draft standards will serve as input to the National Academy of Engineering process of considering engineering standards for K-12 education. This dimension includes the following outcomes:

- Students will develop an understanding of engineering design.
- Students will apply the engineering design process, troubleshooting, research and development, invention and innovation, and experimentation in problem solving and engineering design.

Common Preconceptions

The following are preconceptions and tendencies that novice designers may exhibit:

- The novice designer tends to believe that design is primarily developing creative or novel ideas (e.g., brainstorming), and does not understand the role or importance of iteration, evaluation, and planning.
- Novice designers show an inability to evaluate and recognize quality ideas and to discriminate between effective and ineffective design processes.
- Novice designers often have difficulty clearly defining the problem in the context of the user’s environment and constraints.
- Novice designers often focus on a single idea without considering alternatives (often the first idea that comes to mind).
- Novice designers are often unaware of the difference between an abstract concept and a detailed design, and do not use appropriate tools and processes to go from the abstract concept to the detailed design.
- Novice designers often see design as a strictly serial process and do not recognize the need for iteration, revisiting past decisions, and evaluating alternatives.
- Novice design teams often exhibit poor team decision making.

The idea that a design is a decorative pattern may be a preconception. Students may not understand that another meaning of design is a representation of the appearance and function of an object before it is made.

Students may also have preconceptions about models. The most important are that models are always physical and that models have a one to one correspondence with reality. Students do not understand that models often leave out important aspects found in the real object or system.

Bibliography and References

- Clive L. Dym and Patrick Little. *Engineering Design: A Project-Based Introduction*. Wiley, 1999.
- Michael McCracken, Wendy Newstetter, and Jeff Chastine. “Misconceptions of Designing: A Descriptive Study.” Proceedings of the 4th annual SIGCSE/SIGCUE ITiCSE Conference on Innovation and Technology in Computer Science Education, Cracow, Poland, 1999.

Project—Design a Solar Cooker

Goal: students will engage in the engineering design process. To the extent possible, the emphasis in the activity should be on the process, and not on the designed artifact; students tend to focus on the object being designed and not see that the quality of the process determines the quality of the design. Novice designers should demonstrate awareness of their design process and see where they have or have not used elements of the design process. Experienced designers should follow a design process and be able to identify the strengths and weaknesses of their process.

This project activity is structured using the 5E Learning Cycle.

Objectives

Students will recognize that design is a process and understand that the quality of the process affects the quality of the resulting design. Students will be able to apply each step of the engineering design process to design a solar cooker.

Materials

The activity requires materials to build a simple solar cooker. Since the emphasis of the activity is on the design project, it would be helpful if there is a wide range of available materials. Possible materials could include

- Cardboard boxes (shoe box or larger size).
- Cardboard.
- White and black paint.
- Transparent materials such as plastic wrap, clear hard plastic, and glass.
- Reflective materials such as aluminum foil or unbreakable mirrors.
- Packing tape or duct tape.
- Stiff wires or skewers.

The following tools will be needed:

- Scissors
- A thermometer capable of measuring up to 250 degrees Fahrenheit.

Engage

The teacher engages the students in a discussion of how much of their environment has been designed by humans. For example, if the class is in a building, it is a building that people designed, engineered, and constructed. The teacher points out that almost every aspect of modern life depends on and is affected by technological artifacts such as bridges, buildings, vehicles, cell phones, computers, and so on. These technological artifacts are designed and created by engineers using the engineering design process.

Students complete the first two columns of the KWL chart (What I know, What I Want to Know) in Table 2, indicating what they know about the design process and what they want to learn.

TABLE 4.1: KWL Chart for engage activity.

What I Know	What I Want to Know	What I Learned
-------------	---------------------	----------------

The teacher then explains that the engineering design process is used to solve problems, and shows examples of deforestation caused by people collecting wood to be used in cooking fires. For example, Figure 18 shows a man carrying firewood in Mozambique. (Haiti is another source that provides a dramatic example of the problem.) The teacher engages the students in a discussion about alternative methods of cooking food in developing nations. Solar energy is one potential alternate energy source; Figures 19 and 20 show two devices that use solar energy to cook food.

**FIGURE 4.18**

A man carrying firewood in Mozambique. Firewood is the primary source of energy for cooking food; collection of firewood in many developing countries has led to severe deforestation.

**FIGURE 4.19**

A simple solar oven made out of a cardboard box, foil, and clear plastic.

Explore

Students are given the problem of designing a method of cooking food using solar energy as a feasible alternative to collecting fire wood. Working in teams, they use the Internet and other sources to collect information to understand the design characteristics necessary for a solar cooker to be useful in a developing country. They organize and report this material to the class.

Then students work in teams to develop a design concept and document the concept with a detailed drawing. The

**FIGURE 4.20**

A solar cooker and a solar water heater in India. The solar water heater is on the roof of the building. The solar cooker is the silver dish in front of the building.

idea here is that students will employ an ad hoc process that becomes the basis for discussion as they go through the Explain process.

Explain

The design process is explained to the students using the material in this chapter; the students are exposed to the steps of the design process. They compare and contrast the process they used in the explore activity with the design process covered by the teacher. They also complete the right column of their KWL chart.

Extend

Student teams go through a scaffolded design process to create and evaluate a prototype of a solar cooker. This process need not include all of the steps described in the *Introduction to Engineering Design* chapter, particularly for novice designers. As students work through each step in the design process, some scaffolding should be provided; for example, each team may report its work on each step to the class and receive formative feedback on their work before moving on to the next step. In addition, the way in which each step is performed may be tailored to the developmental levels of the students. Novice designers may be asked to concentrate on the outcome that should be produced, while more advanced designers may be asked to employ some or all of the tools identified in the

Introduction to Engineering Design chapter.

The following gives information on some of the design process steps that could be required of the students.

Identify Criteria and Constraints

Students develop criteria and constraints for the problem of designing a solar cooker. Examples of possible constraints include

- Cooker can be constructed from readily available materials.
- Cooker can be constructed using simple hand tools.

Examples of possible criteria include

- Maximum temperature reached inside the cooker when it is placed in direct sunlight.
- Volume of food that can be placed in the cooker.
- Time required to cook a typical meal.

A possible variation on this section of the activity would be to have student teams independently develop criteria and constraints, and then through class discussion create a single set of criteria and constraints for the whole class. This would allow different teams to evaluate their prototypes using a class-wide standard.

Generate Ideas

Students generate ideas for the design of their solar cooker. For novice designers, it may be sufficient to use an ad hoc process to come up with two different concepts. For more advanced students, the process and tools described in this chapter may be appropriate.

Examples of possible design concepts include

- A cardboard box with a clear plastic wrap top.
- A cardboard box with a clear plastic wrap top plus foil covered cardboard reflector is to direct more sunlight into the box.
- A cardboard box painted black inside with a clear hard plastic top.

Select a Design

Students use their constraints and criteria to select a design concept to use in creating their prototype. Advanced students should use the tools and process described in this chapter.

Build a Prototype

Students create a prototype of their selected design concept.

Test the Prototype

Students test their prototype to verify that it meets the constraints and perform the experiments necessary to determine how their design performs relative to the criteria.

Evaluate

Student teams present their designs *and their processes* to the class. Each student team's processes are evaluated according to the rubric in Table 3 by the teacher and by the other students in the class. This evaluation is the basis of formative feedback to each team.

To implement the learning cycle, students could use this feedback to revise their designs and build a second prototype. This would emphasize the iterative nature of the design process.

TABLE 4.2: Rubric to evaluate the overall design process as well as the steps in the design process.

Student Outcomes	Strongly meets criteria	Adequately meets criteria	Minimally meets criteria	Does not meet criteria
Recognize that design is a process.	Gives detailed description of processes.	Describe most steps of processes followed to design oven.	Describe some steps of processes followed to design oven.	Describes design without describing the design processes.
Quality of design process	Evaluates quality of all steps and relates this to the quality of the resulting design.	Evaluates quality of most steps and relates this to the quality of the resulting design.	Evaluates quality of some steps and relates this to the quality of the resulting design.	Does not evaluate the quality of any steps.
Apply each step: Criteria and constraints	Identifies several criteria and constraints; criteria and constraints are properly formed.	Identifies several criteria and constraints, most of which are properly formed.	Identifies several criteria and constraints; some of which are properly formed.	Does not identify several criteria and constraints; confuses criteria and constraints.
Apply each step: Generate ideas	Decomposes the overall design problem, finds solutions to subproblems, and uses concept combination techniques.	Uses one or two tools(brainstorming, decomposition, etc.) to develop several design concepts.	Uses ad hoc processes to develop several design concepts.	Only develops a single design concept.
Apply each step: Select a design	Selects between design concepts using a formal tool with criteria and constraints.	Uses a tool to select between concepts; selection reflects some criteria and constraints.	Uses ad hoc processes to select between concepts; selection reflects some criteria and constraints.	Does not use criteria and constraints to select between design concepts.
Apply each step:Prototype	Tests the prototype to determine whether it meets all constraints and how it performs relative to all criteria.	Tests the prototype to determine whether it meets most constraints and how it performs relative to most criteria.	Tests the prototype to determine whether it meets some constraints and how it performs relative to some criteria.	Test do not reflect criteria and constraints.

Solar Cooker Design Project Evaluation

The following exercise provides an assessment of students' learning of the design process.

Theresa and Jack are designing a purification system for water that can be used in parts of the world where there is frequent flooding. They have a deadline and must work quickly because many parts of the developing world are suffering from severe flooding and people are getting sick drinking contaminated water. Jack feels that their first design is good and wants to build and ship the prototype to people in need. He does not want to waste time when lives are at stake. Theresa wants to look at several designs and then build and test a prototype. She thinks that they

might even have to refine their prototype before it is ready for people to use. Jack argues that this process will take too much time. Use your knowledge of the design process to craft an argument that supports either Theresa or Jack.

4.7 References

1. . <http://www.flickr.com/photos/juhansonin/2147259806/>. CC-BY 2.0 Generic
2. . A designof a jet engine.. CC-BY-SA 2.0 Generic
3. . <http://www.flickr.com/photos/28481088@N00/1018539366/>. CC-BY 2.0 Generic
4. CK-12. A design process.. CC-BY-SA 2.0 Generic
5. Darryl Morrell. . CC-BY-SA 2.0 Generic
6. . <http://flickr.com/photos/haddencatalyst/2072627206/>. CC-BY 2.0 Generic
7. Darryl Morrell. . CC-BY-SA 2.0 Generic
8. . http://commons.wikimedia.org/wiki/Image:Sojourner_on_Mars_PIA01122.jpg. Public Domain
9. . <http://flickr.com/photos/brooke/41483921/>. CC-BY 2.0 Generic
10. . http://commons.wikimedia.org/wiki/Image:Toyota_FCHV.jpg. CC-BY 2.0 Generic
11. . <http://flickr.com/photos/33040/111482639/>. CC-BY 2.0 Generic
12. . <http://flickr.com/photos/hyku/277791374/>. CC-BY 2.0 Generic
13. . <http://flickr.com/photos/mountainash/410793434/>. CC-BY 2.0 Generic.
14. . <http://flickr.com/photos/mikeygottawa/2542216636/> <http://flickr.com/photos/bike/1449464782/> http://commons.wikimedia.org/wiki/Image:Pegeout_Bicycle.JPG <http://flickr.com/photos/livenature/247197874/> <http://commons.wikimedia.org/wiki/Image:Tricycle.yellow.arp.jpg>. Smartcar—CC-BY 2.0. Unicycle—CC-BY 2.0. Bicycle—CC-BY 2.0. Bicycle—CC-BY 2.0. Segway—CC-BY-SA. Tricycle—Public domain
15. Darryl Morrell. The concept combination table for the commuter vehicle.. CC-BY-SA 2.0 Generic
16. Darryl Morrell. . CC-BY-SA 2.0 Generic
17. Beth Morrell. . CC-BY-SA 2.0 Generic
18. . <http://flickr.com/photos/64749744@N00/49608328/>. CC-BY 2.0 Generic
19. . <http://flickr.com/photos/beluga/277212681/>. CC-BY 2.0 Generic
20. . <http://flickr.com/photos/90417577@N00/2151696526/>. CC-BY-SA 2.0 Generic

CHAPTER

5

Connecting Science and Mathematics to Engineering

Chapter Outline

- 5.1 ABOUT THIS CHAPTER
 - 5.2 CASE HISTORY: HOW MATH, SCIENCE, AND ENGINEERING LED TO THE FIRST POCKET RADIO
 - 5.3 WHAT IS THE ROLE OF SCIENCE AND MATHEMATICS IN ENGINEERING?
 - 5.4 HOW DO MATH AND SCIENCE CONNECT WITH ENGINEERING IN HIGH SCHOOL AND COLLEGE?
 - 5.5 CONNECTING ENGINEERING CAREER FIELDS WITH SCIENCE AND ENGINEERING
 - 5.6 CONNECTING MATHEMATICS AND SCIENCE TO THE ENGINEERING DESIGN PROCESS
 - 5.7 VOCABULARY
 - 5.8 REFERENCES
 - 5.9 INSTRUCTOR SUPPLEMENTAL RESOURCES
 - 5.10 REFERENCES
-

5.1 About This Chapter

Engineering is the application of the principles of *mathematics* and *science* to the creation or modification of components, systems, and processes (which are often referred to as a product or an **artifact**) for the benefit of society. **Engineers** use a series of logical steps (the **engineering design process**) to create such artifacts which represent a balance between quality, performance, and cost. This chapter explores and examines the role and connections of math and **science** to engineering and the need to succeed in the study of those subjects for a professional career in engineering.

Chapter Learning Objectives

After working through this chapter, you should be able to do the following:

- Explain the goals and the nature of the fields of science, mathematics, and engineering and the differences between them.
- Explain generally how the fields of math and science and engineering benefit from one another as well as need one another.
- Explain what engineers in different disciplines do and the math and science they use.
- Explain the role of science and math in each step of the engineering design process.
- Describe the types of science and math that might be used by engineers in the different engineering disciplines along with an example for the design of a product or a process.

5.2 Case History: How Math, Science, and Engineering Led to the First Pocket Radio

Imagine that it is November 1, 1954 and Dwight “Ike” Eisenhower is president and Leo Durocher’s Brooklyn Giants have just swept the World Series from the Cleveland Indians. Willie Mays has become a World Series legend after making “The Catch” in center field over his head with his back to the infield. Today, you have also just purchased a Regency TR-1 (Figure 1), the world’s first “pocket” radio. It cost \$49.95 (equivalent to \$400 in 2007 dollars) with its four transistors, and you are now listening to Elvis Presley’s first hit, “That’s All Right”. The radio is gray, weighs 12 ounces, and with a size of $3'' \times 5'' \times 1''$, you could slip it right into your pocket. This is a lot more convenient than the old vacuum tube portable radios which were bigger, bulkier, and heavier than the new transistor radio. One of these is an RCA 66BX, a six-tube portable radio that weighed 3 pounds and was $7'' \times 5'' \times 2''$ in size. Where did this incredible piece of shrinking technology come from? We shall see.

3.

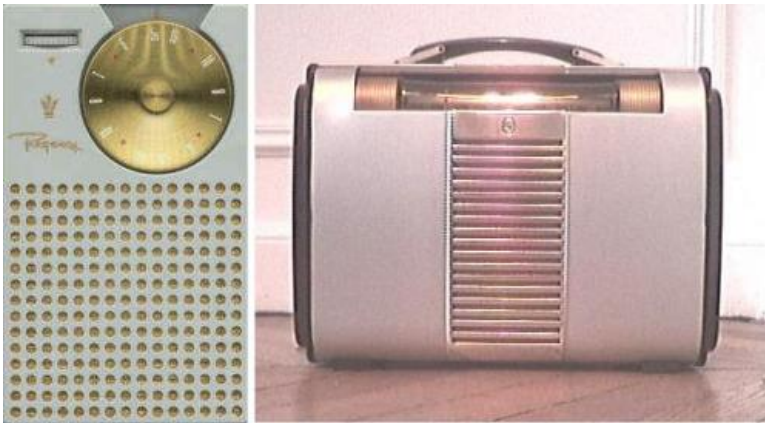

FIGURE 5.1

A portable transistor radio. The world’s first transistor radio, the Regency TR-1 weighed 12 ounces with dimensions of $3'' \times 5'' \times 1''$

The basic scientific knowledge necessary to develop a transistor radio started from the time when, on December 14, 1900, German physicist Max Planck explained to the world how an atom’s electrons behaved with a new theory called quantum mechanics. Over the next 20 years a **mathematical model** was developed for this theory, including an important equation called Schrödinger’s equation. From there, it was these basic principles of science and mathematics directed toward their practical application in electrical devices that led three researchers at Bell Labs on a race. The race was to **invent** a solid-state device that would replace bulky, unreliable, and energy-consuming vacuum tubes used in consumer electronics (such as radios) at the time. So it was that, on October 16, 1947, physicists John Bardeen, Walter Brattain and William Shockley, applied the mathematics and science of quantum physics to **semiconductors** to invent the world’s first transistor. They had created a device that could amplify a weak electronic signal 18 times over a wide range of frequencies. For their efforts they received the Nobel Prize in 1956.

Now that this new device existed, how would it be used? Texas Instruments used special materials processing techniques to make very pure semiconductor material necessary for transistors and started manufacturing them by 1952. Using those transistors, which cost \$2.50 each (\$2.50 will buy 100 million transistors on an **integrated circuit** today), engineers at the Regency Division of IDEA (Industrial Development Engineering Associates) of Indianapolis, Indiana, used the engineering design process to design, develop, and fabricate the world’s first pocket radio. The electrical engineers at Regency used their industrial experience and the knowledge from their education on physics, mathematics, engineering science and electrical engineering to design a small radio; 100,000 units were manufactured. The connections of science and math to engineering are clear. The understanding of a **phenomenon**

of the natural world, quantum physics, and the mathematical modeling of the phenomenon promoted the insights on the electrical behavior of semiconducting materials. It was the three researchers at Bell Labs who were searching for a solution to the well-defined problem of poor electrical behavior of vacuum tubes that led the team to invent the transistor. It was a very practical device indeed, since materials engineers at Texas Instruments were able to produce transistors in quantity so that another team of electrical engineers at IDEA could design, develop, and manufacture that first pocket radio.

The above case history of the first transistor radio illustrates the interplay of math, science, and engineering that occur in commercialization of a new device that later thrilled the country. And it did not take long for society to realize the benefits of quantum mechanics, Schrödinger's equation, and the invention of the transistor. You could see it on some playgrounds a year after the Regency TR-1 was first merchandized. A crowd gathered around kids that brought their dads' pocket radios to listen to the '55 World Series when the Brooklyn Dodgers beat the New Yankees in seven games. That miraculous little radio was a reflection of the "can do" spirit of the decade of the 1950s. Engineering could make science fiction reality. At the time cartoon detective character Dick Tracy had an imagined video-walkie-talkie-computer wrist watch, which he used to run down the city's criminals. Part of it became a reality but now, a half century later, today's high tech embodiment of Tracy's watch, the iPhone, can do everything Tracy's watch did and more. Next, let us consider the impact of technology in your own life from the exercise below.

**FIGURE 5.2**

An electric toothbrush and a microwave oven. The electric toothbrush was invented in 1939 but not popularized until the 1990s. The microwave oven was a spin-off of World War II radar technology and was invented in 1946.

Activity

How does technology affect you and your everyday life? Technology created by engineers affects everyone in their daily lives, usually in subtle understated ways. Try this exercise to explore the impact of technology with devices such as the electric toothbrush or the microwave, as shown in Figure 2.

- Write down a short list of three or four electronic devices or gadgets that you use everyday.
- Write a short description of how you use them, how they affect your life, and how your life would be affected if they had not yet been invented.
- Take a guess at what kinds of engineers were involved in helping create one of the devices. Select one type of engineer and think about how she/he how might have used math and science in making the device?

5.3 What Is the Role of Science and Mathematics in Engineering?

This chapter has already introduced some ways in which science and math are connected to engineering. The chapter will continue to explore these connections in **invention**, **innovation**, education, careers, and design, as well as the impact on our daily lives. It is also becoming clear why it is critical to prepare for engineering education in college by taking and doing well in science and math courses throughout elementary, middle, and high school. In fact, the single best indicator of success in graduating with a college degree in engineering, science or math is taking courses in high school that include four years of math (at least through trigonometry) and three years of lab science. In the remainder of this chapter, we will now expand, articulate, detail, and exercise the engineering–math–science connection. The techniques of mathematics and the phenomena of science are like the brushes and colors on an artist’s palette. Just as an artist creates a new reality with his/her painting, so does an engineer create a new reality for how individuals live in a society. We have seen an example of this not only with the creation of the first pocket radio, but also how the reality of our daily lives have been impacted by other artifacts such as the cell phone and the computer. The next section will examine in greater detail the nature of the connection between math, science, and engineering.

What Is Engineering?

Engineering creates valued products such as the pocket radio. This is done by analyzing the nature of a problem or a need and then applying knowledge of math and science while completing the engineering design process to develop a solution to the design problem. A knowledge of science (e.g., chemistry, physics, and biology) helps the engineer understand the **constraints** inherent in a problem and helps the engineer develop possible approaches for a solution. Math (e.g., algebra, geometry, calculus, computer computation) is used both as a tool to create mathematical models that describe physical phenomena and as a tool to evaluate the merit of different possible solutions.

The profession of engineering is more formally defined by ABET, an organization that **accredits** college engineering programs, as “Engineering design is the process of devising a **system**, **component**, or process to meet desired needs. It is a decision-making process (often **iterative**), in which the basic sciences, mathematics, and the engineering sciences are applied to convert resources optimally to meet these stated needs.” Within this definition, science and mathematics are described as an essential part of the entire engineering process. They do not act alone within this process. “Engineers apply the principles of science and math to develop economical solutions to technical problems. Their work is the link between perceived social needs and commercial application.” (US Department of Labor) The goals of math and of science in engineering differ from those within the field of mathematics (where the goal is to quantitatively represent functional relationships) or the field of science (where the goal is to understand the natural world). In engineering, math and science are tools used within the engineering design process. Using the design process to address a problem or an issue leads to the solution of the problem and a product which might be a component, a system, or a process that fulfills a need that will benefit society. All fields of engineering use the tools of both math and science throughout all steps of the engineering design process. Effective use of math and science are critical to creating a high-quality solution to a need and an associated product of the process.

It often occurs that a high-quality product that comes out of an effective design process (including math and science) is taken for granted, such as a bridge standing for decades or centuries with no problems. Such a situation is illustrated with the Golden Gate Bridge, which has stood for more than seven decades since it was opened on May 27, 1937 (Figure 3). When an inferior solution comes out of a flawed design process, catastrophe may result, and a bridge may collapse with possible loss of lives. Such an occurrence is illustrated below by the Tacoma Narrows Bridge Collapse (Figure 3). On November 11, 1940, this bridge, located at Puget Sound, Washington, began swaying strongly in the wind and eventually broke up due to the resonance of the bridge which twisted until it broke up. There

are mathematical tools available to analyze for waves and resonance of structures, but they were not applied in the design process of the bridge. This demonstrates the importance and need to broadly explore and utilize mathematics and science appropriate to the engineering design problem at hand.

**FIGURE 5.3**

The Golden Gate Bridge and the Tacoma Narrows Bridge. The Golden Gate Bridge, a signature landmark of San Francisco, had the world's longest span when opened May 27, 1937. The Tacoma Narrows Bridge, Puget Sound, Washington, broke up after in a strong wind on November 11, 1940.

Activity - Impact of disaster on an industry's design practice.

There have been many other disasters that occurred because of a flawed design process. One is the consecutive crashes of two British Comet jets in 1954. Go to the two web sites that describe the investigation and the resulting design changes: http://en.wikipedia.org/wiki/De_Havilland_Comet and http://en.wikipedia.org/wiki/TWA_Flight_800. How did the disasters cause engineers to change the airplane's design?

What Is Science?

The meaning of what science is can be debated and has changed over time. It is reasonable to think today of science as a process by which humans try to understand how the natural world works and how it came to be that way. The branches of science most frequently used by engineers include physics, chemistry, and biology. This is reflected by the fact that almost all undergraduate engineering programs require students to take foundational courses in those subjects. An example of how such science connects to engineering can be shown with the global problem of the lack of access to clean water by populations in some of the developing countries around the world. In developed countries turning on the bathroom faucet gives safe and drinkable water gushing from the tap. This safe and convenient water is actually a luxury that is not present everywhere. When it is not available, and water is not purified, people can become sick or even die from causes such as dehydration, cholera, dysentery, and cancer. So how have engineers figured out how to find, transport, purify, sanitize, and deliver water to those who need it? The following example should help answer that question as well as give a concrete example of how science connects with engineering.

Although more than half of the surface of the earth is covered with water, it is not accessible to plants, animals, or humans because of its 3 – 4% salt content. So, can we just remove the salt? No, because it is not so easy and can be costly. Science provides a variety of phenomena that can be used to desalinate water, and a few will be presented here. Chemistry tells us that there are many ways to desalinate water. One of the ways that water can be purified is by evaporation and condensation, which leaves the impurities in the original water. Another way is that, in freezing water the ice leaves the impurities behind in the unfrozen liquid. Another way is based on the fact that certain pore sizes of molecular membranes will allow water to diffuse through the membrane under pressure while leaving behind larger complexes of sodium and chlorine. Chemistry also has data on a variety of physical properties of water and salt water, including the thermodynamic data of heat of evaporation, heat of condensation, and heat of freezing. So what can be done with the different phenomena and all the data that are available?

The first question to answer is: Are there any types of engineering fields with individuals that work with such

phenomena and data with the goal of desalinating water? The answer is yes. Chemical engineers are trained to use such phenomena and data to design and build large-scale processing plants for producing products such as cosmetics, antibiotics, and gasoline as well as purified water. Today, millions of gallons of water are being desalinated by flash evaporation, which uses evaporation and condensation phenomena, and by reverse osmosis, which uses molecular membrane technology based on membrane diffusion principles. A nuclear driven flash evaporation plant located on the Caspian Sea is shown in Figure 4.

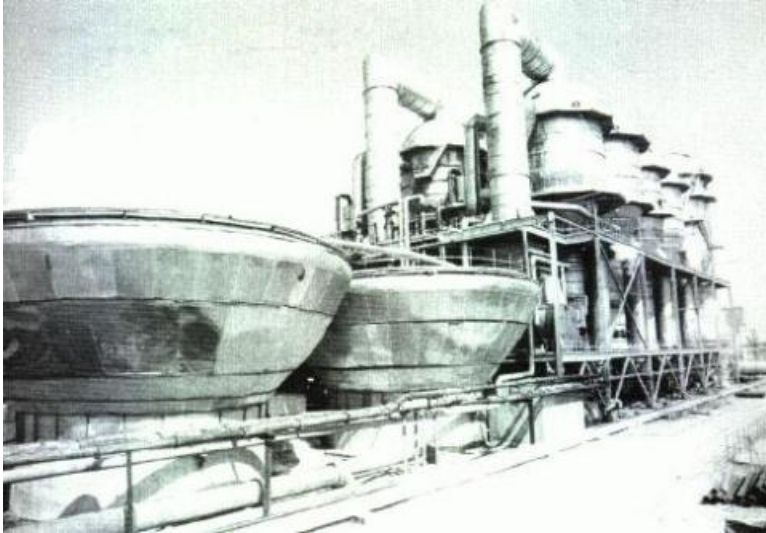
**FIGURE 5.4**

Nuclear powered flash distillation desalination equipment located on the Caspian Sea.

What Is Mathematics?

Math is utilized in a variety of ways within many fields of engineering. The most crucial aspects of math within this field involve cost–benefit–risk analysis and the use of mathematical models. “Mathematical models may include a set of rules and instructions that specifies precisely a series of steps to be taken, whether the steps are arithmetic, logical, or geometric. Sometimes even very simple rules and instructions can have consequences that are difficult to predict without actually carrying out the steps. . . . Often, it is fairly easy to find a mathematical model that fits a phenomenon over a small range of conditions . . . but it may not fit well over a wide range.” (AAAS) Given the importance of having an end result that not only works, but also is safe and dependable, it is easy to understand why the use of mathematical models is an invaluable aspect of the engineering design process, as well as how these models would be applied to various steps within this process. Nearly every aspect of mathematics can be, and is, applied to the engineering design process in some way. All fields within engineering require an advanced knowledge of, and the ability to properly use, many math skills, including (but not limited to) algebra, calculus, geometry, measurements, tables and graphic representations of results, mathematical formulas, and time lines.

Activity—What kinds of science and math do engineers need to address some of today’s global societal issues?

Consider the list of contemporary global societal issues shown in Table 1. From the list, select two or three global issues of interest to you and write them down. Think about them and then write about the math and science that might be used to address each of the particular issues.

TABLE 5.1: Contemporary global societal issues

- Drought in the Southwest United States.
 - Lack of drinkable water in many nations.
 - Aging bridges that are prone to collapse.
 - Lack of accessible and reliable public transportation.
 - Need for renewable energy sources.
 - Children and others disabled by landmines and other weapons.
 - Environmental pollution from oil and chemical spills (Figure 5).
 - Need for safer cars.
 - Global warming from carbon emissions from burning fossil fuels (Figure 5).
 - Unsafe and unpleasant airports around the world.
-
-

Review Questions

The following questions will help you assess your understanding of the What Is the Role of Science and Mathematics in Engineering? section. There may be one, two, three, or even four correct answers to each question. To demonstrate your understanding, you should find all of the correct answers.

1. Mathematical models
 - a. describe scientific phenomena
 - b. can evaluate cost

**FIGURE 5.5**

Icebergs breaking off glaciers and an oil spill.

- c. require a calculator
 - d. are easier to build than physical models
2. Engineers use mathematics and science to
 - a. understand the world
 - b. solve problems
 - c. build models
 - d. design a process
 3. An example of a mathematical model is
 - a. the budget for product development
 - b. drawings used to design a product
 - c. the engineering design process
 - d. rate of the flow of water through a hose

Review Answers

What Is the Role of Science and Mathematics in Engineering?

1. a,b
2. b,c,d
3. d

5.4 How Do Math and Science Connect with Engineering in High School and College?

Preparatory High School and College Courses

Many high school and college courses are needed to prepare for an engineering education.

Precollege Courses

If a student wants to consider the possibility of pursuing a college degree in engineering, what types of K-12 courses should he/she take? Before even entering high school, students should investigate the admittance requirements of the universities for a student's high school education. Universities set guidelines of **prerequisite** requirements upon applying. Most require a minimum of four years of high school mathematics, including at least the basic math courses (algebra one and two, geometry, trigonometry, and analytical geometry), and a minimum of four years of science, again covering at least the basic courses (chemistry, biology, and physics). Also, along with these set requirements for course work, most reputable engineering programs require submitting a placement exam (such as ACT or SAT) scores and show no deficiencies in either math or science.

College Courses

Once admitted into a college engineering program students will be required to complete a year of college math and physics (about 10 courses). This would include fundamental science courses (Chemistry, Biology, Physics) and basic math courses (Calculus I, II, III and Differential Equations). These are usually the minimum level required for engineers in general, but specific engineering disciplines may require more. Most programs also require about a semester (5 courses) of "engineering science courses" where the understandings of math and science are directed toward broad applied science and math courses. They might include courses such as Circuits, Statics, Dynamics, Fluids, Materials, Thermodynamics, and Statistics. The connections of math and science to engineering in these applied courses are quite obvious, for example, with the chemistry and differential equations used in Engineering Thermodynamics.

Science and Mathematics Courses Connected to Engineering

Basic math and science provide the tools of mathematical techniques and science phenomena that engineers use to address design problems related to phenomena of the natural world. They build on similar math and science foundational courses in high school that are introductory with a lower level of math that describe natural phenomena. The college level math and science courses provide a base for advanced math and science courses necessary to address more complex problems in a given engineering discipline. The basic math and science courses have also been utilized for a broad range of practical engineering applications to develop courses that are referred to as engineering science courses such as Thermodynamics, Circuits, and Fluids. For example, the Engineering Science course of Fluids is typically taken by Chemical, Mechanical, Aerospace, and Biomedical Engineering students. That is because the general principles of Fluids apply to fluid flow of air for airplanes as well as flow of gases in internal combustion engines while fluid flow of liquid is used to analyze blood flow in humans as well as flow of chemicals in chemical processing plants. Thus, the connection of basic math and science to engineering is shown directly and

unambiguously both as a base for advanced courses as well as being integrated into broadly subscribed Engineering Science courses. Brief descriptions of the basic math and science courses are presented here followed by short descriptions of the most widely subscribed Engineering Science courses.

Physics. Physics is the science of matter and the interaction of matter. It describes and predicts phenomena about matter, movement and forces, space and time, and other features of the natural world.

Chemistry. Chemistry is the science of the phenomena about composition, structure, and properties of matter, as well as the changes it undergoes during chemical reactions, especially as related to various atoms, molecules, crystals, and other aggregates of matter.

Biology and Biological Sciences. Biology is the science of living organisms that describes and predicts phenomena related to the structure, function, growth, origin, evolution, and distribution of living things as well as the interactions they have with each other and with the natural environment.

Calculus. Calculus is the mathematics of change which includes the study of limits, derivatives, integrals, and infinite series; many disciplines in engineering address problems that must be solved by differential calculus and integral calculus.

Differential Equations. Differential equations are equations with variables that relate the values of the function itself to its derivatives of various orders. Differential equations are used for engineering applications where changing quantities modeled by functions and their rates of change expressed as derivatives are known or postulated giving solutions that are dependent on boundary conditions.

Engineering Courses Connected to Science and Mathematics

As discussed previously, the basic math and science courses have been utilized for a broad range of practical engineering applications to develop courses that are referred to as engineering science courses such as Thermodynamics, Circuits, and Fluids. For example, the Engineering Science course of Fluids is typically taken by Chemical, Mechanical, Aerospace, and Biomedical Engineering students. That is because the general principles of Fluids apply to fluid flow of air for airplanes as well as flow of gases in internal combustion engines while fluid flow of liquid is used to analyze blood flow in humans as well as flow of chemicals in chemical processing plants. Thus, the connection of basic math and science to engineering is shown directly and unambiguously both as a base for advanced courses as well as being integrated into broadly subscribed Engineering Science courses. Brief descriptions of the basic math and science courses are presented here followed by short descriptions of the most widely subscribed Engineering Science courses. Similar arguments apply to other engineering science courses that are also broadly subscribed by many disciplines. The courses will be briefly described in this section.

Dynamics. The field of dynamics uses the knowledge of classical mechanics that is concerned with effects of forces on motion of objects. Engineers use the concepts in design of any moving parts, such as for engines, machinery and motors. For example, a mechanical engineer would have used Dynamics extensively in the design of the pneumatically powered, multirow seed planter that was invented in 1956.

Electric Circuits. The field of circuits applies physics of electrical phenomena to the design, analysis, and simulation of linear electric circuits and measurements of their properties. The principles are used in circuit designs for wide ranging applications such as motors, cell phones, and computers. For example, an electrical engineer would have used Circuits extensively in the design in 1980 of the first circuit board with built-in self-testing technology.

Fluids. The subject of fluid mechanics uses physics of fluids to understand and predict the behavior of gases and liquids at rest and in motion which are referred to as fluid statics and fluid dynamics. As described previously, there are a broad set of engineering applications including air flow for airplanes and in internal combustion engines as well as fluid flow of liquid blood in humans as well as flow of chemicals in chemical processing plants. For example, a chemical engineer would have used the subject of Fluids extensively in the design of deep-draft pumping of oil from a depth of 4800 feet in the Gulf of Mexico begun in 2000.

Materials Science and Engineering. This subject utilizes the synthesis techniques of chemistry and the characterization tools of physics, such as the atomic force microscope, to control and characterize the properties of the structure and properties of solid materials. The principles of materials science are broadly used by a variety of engineering disciplines including electronics, aerospace, telecommunications, information processing, nuclear power, and energy conversion. Applications vary from structural steels to computer microchips. A materials engineer would have applied the principles of Materials Science extensively in the design of synthetic skin which can act as a framework for live cells that grow into a layer of skin while the framework is absorbed by the body.

Mechanics of Solids. This subject uses concepts and knowledge of continuum mechanics emerging from physics and mathematics to understand and predict the behavior of solid matter under external actions, such as external forces, temperature changes, and displacement or strain. The principles are broadly used on a variety of topics for a number of engineering disciplines. It is part of a broader study known as continuum mechanics. Engineers use the principles to determine what happens when a stress is applied to a component. Concepts are useful anytime that a component departs away from the rest shape due to stress. The amount of departure from rest, which is initially elastic or proportional to stress, is safe as long as the material is below its yield strength. For example, an aerospace engineer would have used Mechanics of Solids extensively in the design of the Space Shuttle first launched on April 12, 1981.

Statics. This is the engineering application of a branch of physics called Mechanics. It describes bodies which are acted upon by balanced forces and torques so that they remain at rest or in uniform motion. In statics, the bodies being studied are in equilibrium. The equilibrium conditions are very similar in the planar, or two-dimensional, and the three-dimensional rigid body statics. These are that the vector sum of all forces acting upon the body must be zero; and the resultant of all torques about any point must be zero. Thus it is necessary to understand the vector sums of forces and torques. For example, a civil engineer would have used Statics extensively in the design of the Golden Gate Bridge in 1937.

Engineering Thermodynamics. This subject uses the concepts of science that deal with transfer of heat and work which are used to solve engineering problems. Engineers use thermodynamics to calculate energies in chemical processing, to calculate the fuel efficiency of engines, and to find ways to make more efficient systems, be they rockets, refineries, or nuclear reactors. For example, a mechanical engineer would have used “thermo” extensively in the design of an “alternative energy vehicle” that uses natural gas.

Activity—Differing educational focus of different engineering disciplines

Choose two or three types of engineers and describe and write down what you think are the typical math and science classes they might take that will provide a focus for their future professional activities.

Review Questions

The following questions will help you assess your understanding of the How Do Math and Science Connect with Engineering in High School and College? section. There may be one, two, three, or even four correct answers to each question. To demonstrate your understanding, you should find all of the correct answers.

1. College engineering programs require
 - a. ACT or SAT scores
 - b. letters or recommendation
 - c. four years of high school mathematics
 - d. an essay about engineering
2. Engineering students must be able to
 - a. apply math and science to problems

- b. remember math and science problems
 - c. major in a math or science field
 - d. use math and science as tools
3. If you want to become an engineer you should study
 - a. mostly mathematics
 - b. mostly science
 - c. mathematics and science
 - d. some history
 4. English is as important as mathematic and science because
 - a. engineers must be able to write
 - b. engineers must communicate with the public
 - c. engineers must communicate with coworkers
 - d. engineers must be well rounded
 5. Engineering requires that you understand
 - a. timelines
 - b. calculus
 - c. geometry
 - d. formulas
 6. The best indicator of success in an engineering major in college is
 - a. overall grade point average in high school
 - b. taking three years of metal shop in high school
 - c. taking two computer science courses in high school
 - d. successfully completing four years of math courses in high school

Review Answers

How Do Math and Science Connect with Engineering in High School and College?

1. a,c
2. a,d
3. c
4. a,b,c
5. a,b,c,d
6. b,d

5.5 Connecting Engineering Career Fields with Science and Engineering

This section discusses the nature of a variety of engineering disciplines: the background, engineering activities, and what is designed and built by engineers in the discipline.

Agricultural engineering involves the design of agricultural machinery and equipment, the development of ways to conserve water and improve the processing of agricultural foods, and the development of ways in which to conserve soil and water. None of this would be possible without an understanding of geology, chemistry, and biology.

Aerospace engineers use their knowledge of physics, math, and engineering to design and build airborne and space structures and the systems that support them. These include airplanes, helicopters, rockets, satellites, and the space shuttle. Examples of new human-related challenges are in designing safer and more comfortable commercial aircraft and in designing private airplanes for the elderly and physically challenged. Aerospace engineers typically work for organizations such as Lear, Boeing, and NASA.

Bioengineers design and develop devices and procedures that solve medical and health-related problems by combining a knowledge of physics, chemistry, biology, and medicine with engineering principles. They develop and evaluate systems and products such as artificial organs, **prostheses**, instruments, medical information systems, and health management and care delivery systems. They work with doctors and health care specialists to design and build components and systems that aid and improve the physical well being of humans. These include diagnostic devices (e.g. blood sugar sensors for diabetics) and body repair or replacement parts such as artificial hips or prosthetic legs. Examples of new challenges include developing organ replacements and sensors to monitor body chemistry. Bioengineers typically work for companies such as Medtronic, Baxter Healthcare, and Johnson and Johnson.

Chemical engineers apply the principles of chemistry to solve design and supervise facilities for the production and use of chemicals and biochemicals. They must be aware of all aspects of chemicals manufacturing and how the manufacturing process affects the environment and the safety of the workers and consumers. Examples include desalinization plants and semiconductor processing equipment. Examples of new human-related challenges are in designing and building equipment for large-scale production of artificial skin and bacteria-created antibiotics. They typically work for organizations such as Dow, DuPont, Motorola, and Monsanto.

Civil engineers design and supervise construction of structures and infrastructure such as roads, buildings, bridges, and water supply and sewage systems. Examples of new human-related challenges are in providing ready access and easy mobility for the elderly and physically challenged to all structures as well as infrastructure improvements for controlling and reducing urban environmental pollution of water and air. Civil engineers typically work as consultants and for architectural and city organizations such as Del Webb Houses and the City of Phoenix. They make use of mechanics from physics in the design of roads and structures, but also need the tools of chemistry and biology when addressing environmental issues related to water supply and sewage.

Computer scientists and engineers design computers and the instruction sets in computer programs that control systems and devices in the world around us. Examples are automobile engine controls or Internet information delivery. Examples of new human-related challenges are in developing programs that help physically challenged for controlling the motion of artificial limbs or for driving a car. Computer engineers work for companies such as Microsoft, Apple, and Hewlett Packard.

Electrical engineers design and fabricate electrical and electronic devices and systems. Examples include cell phones, televisions and skyscraper electrical delivery systems. Examples of new human-related challenges are in developing the sensors and electronics for bionic systems such as artificial eyes and ears. Electrical engineers typically work for organizations such as ATT, Motorola, Intel, and Medtronic.

Industrial engineers design and **implement** the most cost-effective organization of resources (people, information, energy, materials, and machines) for manufacturing and distributing engineering services and goods. Examples

of new human-related challenges are improving safety and ergonomic design of cars for average or physically challenged individuals. Industrial engineers typically work for a variety of manufacturing organizations such as Intel, Boeing, and Honeywell.

Materials engineers design, select and improve the materials used in a wide array of engineering applications. These include the alloys in jet engines, plastics in bicycles, ceramics in radar equipment, composites in golf clubs, and semiconductors in cell phones. Examples of human-related challenges are new and improved materials for leg, arm or hand prosthetics and implants for hips and other joints. Materials engineers typically work for a variety of organizations such as Motorola, Boeing, and Ford.

Mechanical engineers use physics principles of motion, energy and force as a basis for understanding, analyzing, designing, and building mechanical components and systems. Such systems could include bicycles, cars, engines, and solar energy systems. New human-related challenges could include robotically controlled artificial limbs and mechanical components for an artificial heart. Mechanical engineers often work for organizations such as Boeing, Intel, and Honeywell.

Nuclear engineers design and build the processes, instruments, and systems that include radioactive materials. They might design nuclear power plants to generate electricity or to power ships and submarines. They also might design medical devices and systems that use trace amounts of radioactive material for diagnostic imaging and radiation treatment. This field makes extensive use of chemistry, biology, and physics in designing for such applications.

Activity—What kinds of engineers are needed in a team to solve a specific problem.

For each of the global societal issues in Table 1 in the What Is the Role of Science and Mathematics in Engineering? section, decide the types of engineers that would be needed on a team to address these issues.

Activity—What do career resources say about engineering?

The purpose of this activity is to help you compare answers about various fields in engineering and the possible uses of math and science within these fields. Access the occupational outlook handbook on the web site <http://www.bls.gov/oco/>. On this site, click on the “A to Z Index,” and then click on the letter “E” in the index. Take a moment to note the numerous options listed within “Engineering” or that have “Engineering” in their title. Select the “engineers” option, and you will be directed to a page that lists all possible career paths for a student pursuing engineering, along with a brief description of each specialty. Examine these career paths and then answer the following questions:

- Did you learn about any different new engineering careers or activities?
- Give an example for a single engineering career about the nature of the work, working conditions, training requirements, employment, job outlook, and earnings.

Review Questions

The following questions will help you assess your understanding of the Connecting Engineering Career Fields with Science and Engineering section. There may be one, two, three, or even four correct answers to each question. To demonstrate your understanding, you should find all of the correct answers.

1. Aerospace engineers
 - a. train air traffic controllers to use up-to-date equipment
 - b. design airport runways and passenger lounges
 - c. teach at the Air force Academy in Colorado
 - d. design and build things such as airplanes and space shuttle

2. Agricultural engineering involves
 - a. designing the best layout for a farm
 - b. selecting the plants that will produce the largest crop
 - c. designing agricultural machinery and equipment
 - d. selecting the best way to transport products to market
3. The engineering field or fields that use a great deal of mathematics are
 - a. marine engineering
 - b. nuclear engineering
 - c. chemical engineer
 - d. industrial engineer
4. Bioengineers
 - a. work with doctors and health care specialists
 - b. develop devices to diagnose diseases
 - c. must have a medical degree
 - d. develop health management systems
5. Most chemical engineers
 - a. know how making chemicals affects the environment
 - b. typically work for the military creating weapons
 - c. are not responsible for their products' safety
 - d. transform gases and liquids into useful products
6. Electrical engineers
 - a. write computer programs
 - b. build solar energy systems
 - c. build sensors
 - d. design computers
7. Mechanical engineers
 - a. work on mechanical rather than human-related problems
 - b. use physics principles of energy, force, and motion
 - c. develop new materials for building mechanical devices
 - d. none of the above
8. Civil engineers
 - a. build bridges and water systems
 - b. work primarily for the federal government
 - c. do not need a background in biology
 - d. none of the above

Review Answers

Connecting Engineering Career Fields with Science and Engineering

1. d
2. c
3. a,b,c,d
4. a,b,d
5. a,d

- 6. c
- 7. b
- 8. a

5.6 Connecting Mathematics and Science to the Engineering Design Process

Who Is the Client or Customer for the Designed Artifact

There are many types of societal issues which extend beyond the borders of any single state or country that will impact the quality of many people's lives in the future. However, in order to address a given global issue, it has to be reconfigured into a local issue, whether it is at the city, county, state, region, or national level. Then local action can be taken to address a local problem, which then contributes to the solution of the global range of the problem. For example, for the issue of Drought in the Southwest, a way to address this as a local problem might be given by the question, "How can water be conserved in the city of Phoenix?" Thus, the design process for a product designated for the public good requires consideration of the scope of implementation. For example, will the designed artifact or process address an audience of one person or many people? Do they live locally on the block or in the town, or regionally in the county or state or contiguous states or possibly nationally or internationally one. These issues will be considered in the exercise below.

Activity—Who is client or sponsor for a designed societal issue solution?

Select three or four topic from the list of global issues in Table 1 in the What Is the Role of Science and Mathematics in Engineering? section that interest you. Describe and write down who the clients or customers might be for the three or four issues you selected.

A Streamlined Engineering Design Process

The design process begins when a client or customer has a problem or need and wants a designed solution resulting in a product that meets the need or solves the problem. Sometimes, a new product is developed from scratch which would require a new design and sometimes innovations are used to improve existing products, in which case some aspects of an already existed design would be modified. New products generally use an open-ended process that rarely has a single correct solution. Instead, there are several solutions that will satisfy desired needs with varying degrees of effectiveness. In this section, we will indicate how each step of the design process is connected to math and science. One of the challenges of design is to choose from a number of possible solutions. However, a clearly defined process flow is needed so that designs are developed to meet the needs of customer or client. We will demonstrate how math and science connect to engineering in the engineering design process with a simplified example to facilitate understanding. The process is usually iterative but a single cycle will be used here since the goal is to show the math and science connection to engineering (Figure 6). Briefly stated, the streamlined steps in the design process might consist of the following:

- Identify a problem or a need.
- Define requirements and constraints.
- Generate ideas or brainstorm for set possible solutions.
- Use requirements and constraints to evaluate possible solutions.
- Use the chosen solution to design and build a **prototype**.
- Test and evaluate the prototype and modify if necessary to finalize prototype.
- Communicate the results.

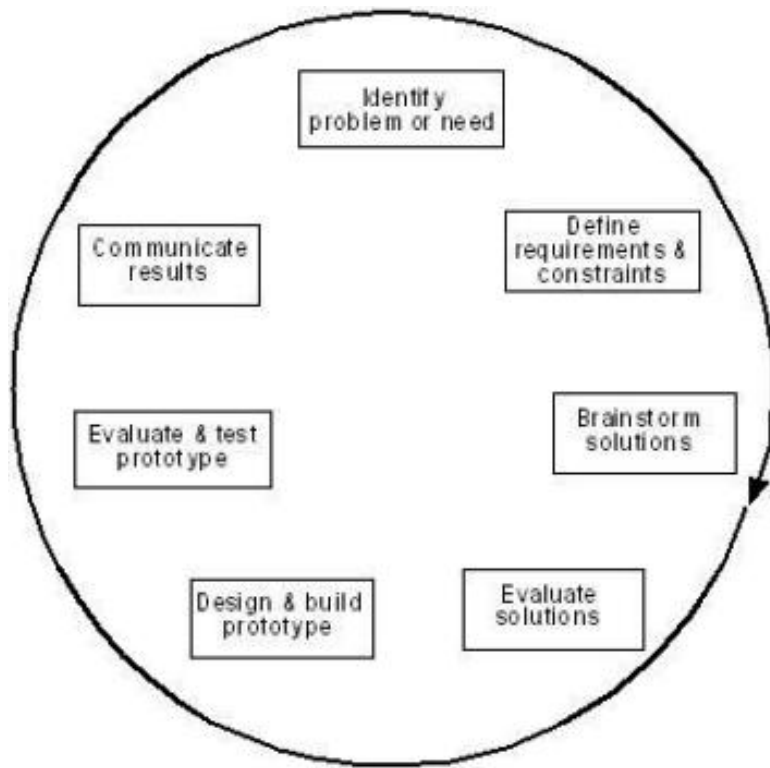

FIGURE 5.6

A simplified engineering design process.

Case Study—Water for a Small, Isolated Seaside Village in an Underdeveloped Country

Let us say that there is a small village of 50 people living in a tropical climate at the desert's edge by the sea and named Ecologia. It is connected to the next small village 150 miles away by a poor one-lane road that is sometimes impassable due to dust storms and bad repair. The town lives by fishing from the ocean and by farming a small patch of vegetables, but does have a few gasoline-powered generators to supply some electricity to the village. It is located in the underdeveloped country of Optimicia which does not have the resources to supply utilities such as electricity, water, and communication to the town. A single well has supplied water to the town, but the water level is dropping and it may go dry. The village would like to have another means of supply of water to supplement the current supply and assure sufficient quantities for the future.

This scenario will be used with the goal being to demonstrate math and science connections to engineering in the design process. As such, detailed numbers and calculations are not used, so decisions and details will not be rigorous in order to simplify the example. We now go through the steps of the design process, pointing out the connections to science and math.

Identify the Problem. An isolated village next to the ocean with 50 lower income people has no connection to government supported utilities, the nearest town 150 miles away on a poor road, and the village's deep well water source that is being depleted. A new source of water is needed.

Science connection. A civil engineer might use an instrument to monitor the well water level to measure the rate of depletion of water.

Math connection. Mathematics could be used to develop a model for cost and availability of current water sources (wells, monsoons, and trucked in water).

Define Requirements and Constraints. Requirements might include the purity of the water, the rate at which water is produced, the lifetime required from a designed system, and the fact that, since the village is off the electrical distribution grid, no utilities are available to support the system. Constraints might include various cost limitations such as for design, fabrication, operation, and maintenance of the system, as well as possible safety and environmental considerations. From the sets of requirements and constraints, as well as consideration of the context of the situation with the village, people, and environment, a problem statement could be developed and might read as follows: “A system for producing drinkable water will be developed which will supply the needs of 50 people such that the cost is no greater than \$2 per thousand gallons, including materials, construction, and operation over a period of 10 years.”

Science connection. A knowledge of the science underlying the various existing techniques is necessary so that the widest range of approaches to providing water is explored.

Math connection. Mathematical models may be used here to examine water costs for different systems so that a reasonable set of requirements and constraints are used in generating the problem statement. There are mathematical models that describe costs for existing techniques, but new models would need to be created if a new technology was devised.

Brainstorm Alternative Solutions. At this stage of the process the widest variety of ideas and/or possible solutions needs to be explored for the design problem. These ideas can come from many different sources: existing products, brainstormed ideas, ideas from scientific principles, and any other approaches possible. The body of these possibilities, or design concepts, needs to then be shaped into a component, system or process that could fulfill the set of requirements and constraints as possible problem solutions. Some approaches may be thrown out early if they have little potential (e.g., supplying pure water from icebergs to a village near the equator is probably not feasible).

Science connection. A variety of solutions could be generated based on scientific principles as shown with the following examples. Sea water can be purified by freezing, but this is not a good approach for a village near the equator. Purifying sea water by distillation (evaporation and condensation) could be used in a solar still or in a flash evaporation plant. Purifying seawater by removing salt with a membrane could be done with a reverse osmosis plant. Moving pure water to the town by new wells, by truck or by pipeline are other possible solutions without much science.

Math connection. Mathematical models to roughly estimate costs for the various approaches could be generated in the first portion of this step of the design process. They are also used to predict a cost for various alternative solutions that arise during idea generation phase and can help analyze the linkage between the science behind a technique and the cost of implementing it with materials, fabrication or manufacturing, operation, and maintenance. These costs then need to be normalized for the sake of comparison with other options to cost per thousand gallons of water.

Evaluate Solutions. Potential designs are evaluated relative to the constraints and **criteria**, and one or more are selected to be designed in detail and prototyped. The selection is made using a structured process that requires the requirements be met and chooses the best design according to the requirements and constraints. To continue to show math and science connections it will be assumed that the best design was a solar still for desalination (Figure 7). Using that choice other design steps will now be considered.

Design and Build Prototype. The selected design is developed in full detail and components’ specific shapes and dimensions determined. Materials are selected and components are fabricated and prototype assembled. Prototype operation and performance may be modeled on a computer. For the hypothetical design a prototype solar still is built.

Science connection. A more detailed knowledge of the science can be created with more accurate values of physical parameters which will also provide information that may affect various costs for the components of the prototype. The nature of the physical phenomena that are occurring within various components should be modeled from the viewpoint of the science-based ideal so that performance can be evaluated when the prototype is tested.

Math connection. Mathematical models of performance based on science phenomena will be generated to evaluate the prototype.

Test and Evaluate prototype. Prototypes are tested to see if the design meets all requirements and performs acceptably. The performance should be compared to the ideal performance determined from mathematical modeling of the prototype. Differences between the ideal and real performance should be analyzed and understood. The design process may be iterated and refined to improve performance until it is acceptable. Sometimes, testing and evaluation show that a design will not work, so that a different design concept must be selected by returning to evaluate alternative solutions. If the hypothetical solar still meets performance specifications and fulfills constraints then solution can be communicated

Science connection. The scientific model of operation should approximate the actual prototype performance; if not, then there may be science phenomena not correctly implemented in the model or there may be other issues in construction or operation that needs to be diagnosed to have a model that is a good predictor of performance.

Math connection. The mathematical model of operation should be tested to make certain that the model has been constructed properly using the appropriate science and mathematics.

Communicate results. The activities and results of the design process should be documented and communicated to the appropriate client or customer.

Science connection. All steps of the design process should be documented and justification for decisions should be made clear. The science behind the choice of the solution to the design problem should be made clear, including factors and weights of requirements and constraints used to select the solution.

Math connection. The mathematical model of operation should be well documented so that a basis for performance and effectiveness of the design is demonstrated. The model should also be documented so that the effectiveness of the design in fulfilling the client's needs is demonstrated.

Activity - Connecting Math and Science to the Engineering Design Process in Addressing a Global Societal Issue or Problem

Select one issue of your choice from the list of global issues in Table 1 of the What Is the Role of Science and Mathematics in Engineering? section. Specify and write down the problem scenario that describes the people and their situation who are the clients who will benefit from your design problem solution for the chosen Societal Issue. Now explain and write down what types of engineers are needed for the project team that will be working on the Societal Issue. Now, as was demonstrated for the Case Study previously, describe and write down for each step in the Simplified Design Process what is happening for the chosen Societal Issue along with what math and science is being used and how it is being used.

Review Questions

Multiple Choice

The following question will help you assess your understanding of the Connecting Mathematics and Science to the Engineering Design Process section. There may be one, two, three, or even four correct answers to each question. To demonstrate your understanding, you should find all of the correct answers.

1. An important use of mathematics in engineering is to determine
 - a. how much engineers should be paid for a design
 - b. the price of software needed to create a design
 - c. the cost of different designs of the same product
 - d. how much to charge a customer who wants a design

Free Response Questions

2. What role do math and science play in the creative process of engineering design?
3. What impact do science and math play in designing and developing a better artifact from the engineering design process?
4. How do math and science connect with engineering in the engineering design process compared to what happens in other types of design processes (architectural, fashion, etc.)?
5. How can you tell if an artifact created from a design process has considered enough ideas from engineering, science, and math connections, and the associated variety of possible problem solutions to ensure that a high-quality artifact has been created from an effective design process?
6. What is the role of math and science in connecting to engineering in developing characteristics of a good problem definition statement?
7. How are math and science connections to engineering used in the steps of the engineering design process? Why the steps are not always completed in order?
8. How does the connection of math and science to engineering affect the team decision making processes in the engineering design process?
9. What role does the connection of math and science to engineering play in creating a detailed design from implementing the major concept of the chosen solution to the design problem?

Review Answers

Connecting Mathematics and Science to the Engineering Design Process

1. c

5.7 Vocabulary

Accredited

To have been endorsed or approved officially. Undergraduate engineering programs are accredited when they meet the standards of a national board, Accreditation Board for Engineering and Technology (ABET).

Artifact

Something created or modified by humans usually for a practical purpose.

Component

A distinct part or element of a larger system.

Constraint

A constraint is a limitation or condition that must be satisfied by a design.

Criterion

A criterion is a measurable standard or attribute of a design; for example, weight and size are both criteria. Criteria are used to compare different possible designs and determine which better solve the design problem.

Engineer

someone who uses scientific and mathematical knowledge to solve practical problems and produce goods and processes for the benefit of society.

Engineering design process

“the process of devising a system, component, or process to meet desired needs. It is a decision-making process (often iterative), in which the basic sciences, mathematics, and the engineering sciences are applied to convert resources optimally to meet these stated needs.” (ABET)

Implement

To successfully put into action or carry out to completion.

Innovation

The process of incrementally or radically modifying an existing product, system, or process to improve it.

Integrated circuit

An electronic circuit of transistors etched onto a small piece of silicon which is sometimes referred to as a microchip.

Invent

To come up with a new, useful, and nonobvious idea, plan, explanation, theory, principle, novel device, material, or technique which is a creation of the mind.

Invention

A new and useful device, method, or process developed from study and experimentation.

Iterative

Repetitive or cyclical. The engineering design process involves the completion of project tasks or phases in repetitive cycles until a desired result is achieved.

Mathematical model

The quantitative general characterization of a process, object, or concept, in terms of mathematics, which enables relatively simple manipulation of variables in order to determine how a process, object, or concept would behave in different situations.

Prerequisite

Something required beforehand.

Phenomenon

An observable fact or event; an outward sign of working of a law of nature.

Prototype

A trial working model of a design that is built to test design decisions and identify potential problems.

Prosthesis

An artificial replacement for a missing body part.

Science

The observation, identification, description, experimental investigation, and theoretical explanation of natural or human-made phenomena.

Semiconductor

A substance that conducts electricity better than an insulator but not as well as a conductor. Silicon is a semiconductor used to make microchips.

System

A group of interacting, interrelated, or interdependent elements forming a complex whole.

5.8 References

- ABET, Inc. “Criteria for Accrediting Engineering Programs 2007–08”. March 17, 2002. Available on the web at
- <http://www.abet.org/Linked%20Documents-UPDATE/Criteria%20and%20PP/E001%2007-08%20EAC%20Criteria%2011-15-06.pdf>
- American Association for the Advancement of Science (AAAS). *Project 2061: Science for All Americans*. American Association for the Advancement of Science, Inc., Washington, D.C., 1989.
- US Department of Labor. “Occupational Outlook Handbook.” July 2008. Available on the web at
- <http://www.bls.gov/oco/>

5.9 Instructor Supplemental Resources

Standards

ASEE Draft Engineering Standards This chapter is focused on “Dimension 2: Connecting Science and Mathematics to Engineering” of the ASEE Corporate Members Council Draft Engineering Standards; these draft standards will serve as input to the National Academy of Engineering process of considering engineering standards for K-12 education. This dimension includes the following outcomes:

- Students will develop an understanding of the essential concepts and application of science and mathematics as they pertain to engineering design.
- Students will be able to apply concepts of science and mathematics in an engineering design process.

Student Preconceptions about Engineering and the Math and Science Connections

Students hold many preconceptions about who engineers are, what they do, and how science and math connect to their activities. These preconceptions may negatively affect precollege students’ decisions about considering engineering as a career, especially so for females and minorities. Some preconceptions are discipline specific and some are for engineering in general.

- **What do engineers do?** Some precollege students believe that engineers work mainly on technical hands-on activities such as repairing cars, installing wiring, driving machines, and constructing buildings but do not work on activities such as designing things, designing for clean water, and supervising construction.
- **Who can be an engineer?** Precollege students and their teachers often believe that females and minorities less likely to succeed when they intend to go into the engineering profession.
- **Chemical engineering preconceptions.** Precollege students believe that chemical engineers principally work in their own labs; work in dirty and unsafe places; and do not care about the environment.
- **Math and science ability.** Many middle and high school students believe that, in order to succeed in studying the subjects of engineering, mathematics, or science in college, a person must have to be very smart and/or have a talent for those subjects.
- **The nerd factor.** Students’ images of professionals are strongly influenced by media stereotypes, so they think of scientists and engineers as brainy, absentminded, unkempt, and wild-haired eccentrics. Many do not know any real scientists or engineers.
- **Financial aid.** Many middle school and high school students do not think there are resources to help support their higher education. Their lack of awareness of financial assistance may prevent them from enrolling in engineering where there are multiple resources such as scholarships, company internships, and undergraduate research.
- **Career opportunities.** In one middle school students had unrealistic career expectations. A survey revealed that three-quarters of them thought they could become scientists or engineers, but the same number also thought they could become professional athletes. With 4 million people in US STEM careers and 3,500 in professional athletics, the odds are about 1,000 to 1 in favor of a student having a STEM career compared

to becoming a professional athlete. This seems like a good reason to consider enrolling in math and science classes in precollege education.

5.10 References

1. . http://en.wikipedia.org/wiki/Image:Regency_transistor_radio.jpg. Gnu Free Documentation License 1.2
2. . http://en.wikipedia.org/wiki/Image:Electrical_toothbrush_20050717_001.jpg <http://en.wikipedia.org/wiki/Image:Microwave.750pix.jpg>. Toothbrush—Public domain, Microwave oven—Public domain
3. . <http://en.wikipedia.org/wiki/Image:GoldenGateBridge-001.jpg> http://en.wikipedia.org/wiki/Image:Tacoma_Narrows_Bridge_Falling.png. Golden Gate Bridge—CC-BY 2.5., Tacoma Narrows Bridge—Public Domain
4. . http://commons.wikimedia.org/wiki/Image:Shevchenko_BN350_desalinati.jpg. Public domain
5. . [Icebergsbreaking off glaciers and an oil spill.](#). Icebergs—CC-BY-SA 2.0. Oil Spill—Public Domain
6. Steve Krause. A simplified engineering design process.. CC-BY 2.0 Generic

CHAPTER **6**

A Brief History of Engineering

Chapter Outline

- 6.1 ABOUT THIS CHAPTER
 - 6.2 HISTORICAL THEMES
 - 6.3 ENGINEERING IN ANCIENT CIVILIZATIONS
 - 6.4 ENGINEERING IN MEDIEVAL AND RENAISSANCE EUROPE
 - 6.5 THE INDUSTRIAL REVOLUTION
 - 6.6 RISE OF THE CORPORATION
 - 6.7 THE EARLY TWENTIETH CENTURY
 - 6.8 THE COMPUTER AGE
 - 6.9 POTABLE WATER (POSSIBLE SIDEBAR)
 - 6.10 CONCLUSIONS
 - 6.11 VOCABULARY
 - 6.12 REFERENCES
 - 6.13 INSTRUCTOR SUPPLEMENTAL RESOURCES
 - 6.14 REFERENCES
-

6.1 About This Chapter

Today, much of the world's population lives in engineered environments. Most of us are surrounded by technological devices that dramatically affect how we live our lives. We live in houses whose structural, electrical, plumbing, and communications systems have been designed by engineers. We travel in cars, trucks, trains, and airplanes; we communicate with each other using televisions, computers, telephones, and cell phones. Engineers have played a key role in the development of all these devices.

It is not difficult to imagine life without many of these advances; in fact, some of the world's poorest people live today without the benefits that we take for granted, such as clean water and working sanitation systems, plentiful food, and electronic conveniences. Much of the history of engineering has been directed at such problems, and we are the beneficiaries of their solutions as well as the inheritors of unforeseen new problems that engineering solutions have created.

The work of engineers has dramatically affected the nature of our society today as well as the course of civilization throughout the centuries. Engineers are often seen as purely technical individuals whose only concern is the development of new devices or structures. However, this is far from the truth. Throughout history, engineers have worked within their societies and have been constrained by their societies; the success or failure of engineering endeavors often has less to do with technical issues than with nontechnical issues including economics, social conventions, and luck.

Most modern definitions of engineering emphasize the application of knowledge of science and math to develop useful objects, products, structures, and so forth. While this is certainly true of modern engineers, engineering practice has historically extended beyond the use of science and math to include the ingenuity required to make things work. Many engineering feats of the past are even more impressive because they were achieved without a complete understanding of important scientific principles. Thus, for example, medieval cathedral builders can be considered as engineers even though their scientific understanding of forces and loads in structures was limited. Even with today's rapid advances in knowledge, much modern engineering practice involves solving problems that are not necessarily rooted in math or science.

The history of the word "engineer" gives some understanding of what engineers have been in the past. The original meaning of the word was one who constructs military engines; military engines were devices such as catapults as well as fortifications, roadways, and bridges. This meaning was expanded to mean one who invents or designs. The meaning of engineers as those who plan and execute public works was established in the early 1600s.

In this chapter, we present just a small fraction of all of the historical events related to engineering. Throughout history, society has been affected by the technological advances created by engineers, and engineers and their technology have both been dramatically affected by the societies in which they occurred. Thus, a complete history of engineering would require a complete history of society, which is clearly beyond the scope of this chapter. Also, this chapter focuses primarily on engineering within the western world, including the Roman Empire, Europe, and later North America.

Chapter Learning Objectives

After working through this chapter, you should be able to do the following:

- Give examples of how engineers have used creativity and judgment in the application of math, science, and technology to solve societal problems.

- Explain why complex engineering problems are usually solved by teams working within broader social structures.
- Explain how engineering progress provides new human capabilities, which in turn increases engineering capabilities.
- Give examples of how engineering provides society with both intended and desirable consequences as well as unintended and undesirable consequences.

6.2 Historical Themes

In this chapter, four themes emerge repeatedly; they have been repeated throughout the history of engineering. Each is related to one of the Chapter learning objectives and will be illustrated several times in this chapter. We briefly introduce these themes before beginning the history.

Engineering requires creativity and judgment in applying math and science to solve problems. You will recognize this theme in almost all of the engineering developments discussed in this chapter. Specific examples of this include development of the steam engine and the electrical light system; in both cases, an understanding of the basic scientific principles associated with steam power and electricity was established before engineers used these principles to develop technology. However, understanding alone did not lead to immediate implementation of the technology; significant effort was often required to make things work.

Complex engineering problems are usually solved by teams working within the broader societal structures. For example, most of history's large construction projects such as the pyramids in ancient Egypt, the great cathedrals in Medieval Europe, or the large dams in the western United States required extensive materials, labor, and other resources. These resources were provided by governments, corporations, churches, or other organizations. Also, large projects require the organization of large numbers of people. All of this was done within a social structure.

Government is one societal structure that constantly influences engineering advances. Governments have often provided resources for engineering projects, and have spurred development of new technologies, including accurate clocks for measuring longitude, early computers, military aircraft, and rockets and technology for space travel. In addition to providing resources, governments have influenced technology through laws and policies. Some laws may be implemented to protect public safety; for example, explosions of boilers in steam engines in the late 1800s led to government regulation and safety standards. Patents represent another way in which governments use laws to influence technology; a patent gives its holder legal rights to stop others from using a particular technique or design.

As technology has progressed, it has grown more complex. Thus, many early engineering achievements can be attributed to single individuals or small groups. However, most recent engineering achievements have been made by multidisciplinary teams of engineers.

Engineering progress provides new human capabilities, which in turn increase engineering capabilities. Many technological advancements provide a foundation for further technological advancements. For example, the development of affordable printing methods (including movable type and the mechanical printing press) led to wider availability of books and promoted literacy; this in turn led to wide dissemination of scientific knowledge which formed the foundation of the Industrial Revolution. As another example, the development of computers enabled the subsequent development of computer-aided design software, which is now used to create even more powerful computers.

Engineering produces both intended and desirable consequences as well as unintended and undesirable consequences. For example, the development of trucks and cars has allowed people and goods to travel widely. However, these vehicles are a major source of air pollution, particularly in developing nations, and these vehicles have made urban sprawl a major issue in most major American metropolises. In today's world, engineered systems have become incredibly complex, and no one individual can understand all of the ramifications of a complex technical system; this complexity generates uncertainty, which can lead to problems and even disasters, particularly when circumstances or consequences cannot be foreseen by the engineers developing a system.

As you read this chapter, see if you can identify examples of each of these themes.

6.3 Engineering in Ancient Civilizations

This section focuses on major structures created by engineers in ancient civilizations. One of the greatest engineering accomplishments in the ancient world, and certainly one of the best-known, was the construction of the Egyptian pyramids. The Egyptian pyramids were built in the period from approximately 2700 to 2200 BC. Figure 1 shows the pyramids at Giza. Three factors were important to Egyptian engineering. The first was that the Egyptian pharaohs were willing to devote almost unlimited time and resources to the construction of the pyramids. There was an almost unlimited availability of skilled human labor (animals did not provide significant labor in the pyramid construction). Second was the ability to organize all of these workers in a very efficient way. Egyptian laborers worked under the absolute control of a single head engineer and his subordinates. The third was that there were sources of sandstone, limestone, and granite very close to the sites of the pyramids. The pyramids were probably constructed using earth ramps to raise the stones to the level necessary; the ramps were later removed. Egyptian engineers worked from plans drawn on papyrus. Egyptian engineers had an excellent knowledge of geometry and measurement, which is apparent from the accuracy with which the pyramids were constructed. In addition to the pyramids, Egyptian engineers built many temples and other buildings.



FIGURE 6.1

The Egyptian pyramids at Giza.

The Romans are also known for their engineering works. These works include road systems, aqueduct systems to provide drinking water, and monuments and buildings. By AD 200, the Roman road system included 44,000 miles of well-constructed roadway. Roman roads tended to follow a straight line up and down hills, rather than bending to follow level contours. This was because the roads were primarily designed for military use and marching soldiers, not for transportation of cargo.

The Roman aqueducts are famous engineering accomplishments as well. The Romans built aqueducts to move water from its source in springs or rivers to Roman cities. We are familiar with the arched bridges used to carry aqueducts across valleys; the aqueduct shown in Figure 2 is one such bridge.

One common theme that runs through these engineering accomplishments is that these projects were very large, especially for the ancient civilizations in which they were pursued. In addition to good engineering, their implementations required large commitments of resources by governments to support large groups of laborers and provide significant amounts of material. Thus, the engineers that led these projects needed skills far beyond technical ability. They needed to understand and be able to work within the social structures of their times to obtain the resources for



FIGURE 6.2

The Pont du Gard is an aqueduct in the south of France constructed by the Roman Empire.

their projects. They needed to understand the capabilities of the laborers who would work on the projects.

6.4 Engineering in Medieval and Renaissance Europe

The medieval and Renaissance periods in Europe span the time from approximately AD 500 to AD 1600. Life in medieval Europe has often been characterized as the “dark ages,” which gives the impression that there were no advances in technology or engineering. In some aspects, this characterization is correct. For example, the elaborate water works created by the Romans to supply their cities with potable water were not duplicated in medieval European cities. Neither were sanitary sewers. Thus, waterborne disease was a recurring problem in many of these cities. However, in other aspects this characterization is not correct. Several important engineering concepts and techniques were developed during this time which laid the foundation for rapid technological advance during the Industrial Revolution. Engineers developed techniques for constructing astounding buildings, including cathedrals and castles. Engineers also improved the designs of ships, making European exploration of the rest of the world possible. The development of the printing press and associated type technology, as well as the development of linear perspective and engineering drawing techniques, enabled literacy and communication of information. We consider these advances in this section.

Buildings

One area in which engineering made significant advances was the construction of cathedrals, castles, and other large structures. Cathedrals were built across Europe beginning in the fourth century and continuing into the present. In medieval Europe, cathedrals were built in the Romanesque style (in the tenth and eleventh centuries) and later in the Gothic style (in the twelfth through sixteenth centuries). Romanesque buildings are characterized by thick walls, round arches, and large towers. Gothic buildings are characterized by thinner walls with large windows, pointed arches, and flying buttresses. Several technological advances made the Gothic cathedral possible. Flying buttresses transfer the gravitational forces from roofs and upper stories to external pillars; this allowed walls to be thin with large windows. In addition, the use of pointed arches and ribbed vaults transfers forces to columns instead of the walls.

Figure 3 shows the west facade of the cathedral of Notre Dame de Paris. Note the pointed arches and the large windows. Figure 4 shows the flying buttresses that help support the roof of the cathedral. Construction on the cathedral was begun in 1163, and the building was not completed until 1345.

Master masons directed the construction of these cathedrals and other buildings. Master masons supervised large groups of workers. They were the structural engineers of their day, and, when working on military projects, were actually called engineers. They had a good understanding of geometry and arithmetic. However, they did not have the engineering theory used by structural engineers today (a mathematical understanding of how loads are transferred in structures as well as the characteristics and strengths of building materials). Instead, they often used rules of thumb, which had been developed from the experience gained by previous generations. Often, these rules of thumb led to mistakes, and plans were often altered to correct these mistakes.

Ships

Another aspect in which engineering made significant progress in medieval Europe was the design and construction of sailing vessels. In Scandinavia, the Viking longship reached the height of its development during the Middle Ages. These ships were very fast; they were used to carry cargo as well as transport Viking raiding expeditions over long distances. Longships had a single mast that was rigged with a square sail.



FIGURE 6.3

The west facade of the cathedral of Notre Dame de Paris.



FIGURE 6.4

Flying buttresses on the cathedral of Notre Dame de Paris.

Progress on sailing vessels in medieval Europe, particularly by Spain and Portugal, set the stage for European exploration and colonization in North and South America and Africa. The two types of sailing vessels that had the largest impact on this exploration were the caravel and the carrack. A caravel is a small, highly maneuverable ship with two or three masts as shown in Figure 5. A carrack is a larger ship with three or four masts and square sails; it was large enough to carry a significant amount of cargo and to be stable on long ocean voyages. Figure 6 shows a carrack. Christopher Columbus' (1451–1506) small fleet that sailed to the New World consisted of one carrack (the *Santa Maria*) and two caravels (*Pinta* and *Nina*).

**FIGURE 6.5**

A caravel is a small highly maneuverable ship with two or three masts.

Moveable Type

A third advance in the Middle Ages, which may not at first be recognized as engineering, was the development of a printing system that used movable type. The technology to print books and make them available at a price that a large segment of the population can afford is one of the most significant advances ever. The development of this technology has been called “the technical advance which facilitated every technological advance that followed it” (Derry and Williams, 1961). Johannes Gutenberg (about 1400–1468) is often credited with the development of movable type; however, this development, similar to many engineering advances before and after, was not made by a single person working in isolation. Rather, Gutenberg combined several processes that had already been developed in a novel way to print books; his methods were further improved by those who followed him. His genius was to combine type casting, ink, and a printing press into a system that could mass produce books.

Before the development of movable type in the fifteenth century, almost all books were copied by hand. A scribe toiled laboriously to create a copy of a book, often requiring a whole year to create one. These handwritten books were so expensive that only the very wealthy could afford them. Movable type was probably first invented in Asia. Bronze type was in use in Korea and China in the early fifteenth century. In Europe, copper plates were engraved to produce playing cards and illustrations; this practice was well established by the mid-fifteenth century. Wooden type was used in the 1420s in the Netherlands.

Johannes Gutenberg was a silversmith in Mainz, Germany. He was probably aware of these previous advances in printing and typography. In 1426, Gutenberg began printing with individually cast metal letters; each letter was on the surface of a block. He cast these letters using type metal, an alloy of lead, tin, and antimony. It has long been

**FIGURE 6.6**

The Santa Maria at Anchor, a painting of the Santa Maria by Andries van Eertvelt about 1628; the Santa Maria was a car-rack.

thought that letter blocks were formed using dies (molds) of soft metal, so that in all blocks of a given letter, the letter form would be identical. However, modern analysis suggests that the form for each letter was individually inscribed in clay and then cast, so that each block for a given letter was subtly different. To typeset a page of text, the letter blocks were arranged in rows of text, and the rows were then arranged into pages. This process is illustrated in Figure 7. Once the page was typeset (a laborious process that could take a whole day for a single page), it could be inked and printed as many times as necessary to create copies of a particular page in a book.

Note that the creation of books and other material required both technology for typesetting and technology for printing. Typesetting is the process of arranging letters and other content (e.g., illustrations and drawings) into the desired pattern, while printing is the process of getting the ink on the paper in the desired pattern.

In 1455, Gutenberg used this system to print the Bible. It is believed that he printed about 180 copies. Figures 8 and 9 and show this Bible.

Gutenberg's methods were immensely successful, and were widely copied and improved. By 1480, almost every large European city had at least one printing press. Venice emerged as the printing capital of Europe. These early printers designed many fonts that are very similar to those used today.



FIGURE 6.7

Type blocks arranged into rows.



FIGURE 6.8

A Gutenberg bible.

Perspective and Technical Drawing

One of the primary engineering advances of the Renaissance was the development of linear perspective and the invention of several methods of technical drawing, including cutaway drawings, exploded drawings, and rotated views. It may not be clear why these techniques are such significant advances. However, these drawing techniques made it possible for engineers to study mechanical systems and buildings without the need for three-dimensional models; since a two-dimensional drawing can typically be created much more quickly than a three-dimensional model, new drawing capabilities greatly accelerated the pace at which engineering work could be accomplished. These capabilities also improved the ability of engineers and scientists to communicate ideas and concepts. Thus, they helped drive the transformation of engineering from using rules of thumb and accumulated experience to a discipline based on scientific principles and theory.

Several Renaissance artist-engineers are credited with the development of perspective and technical drawing techniques. Filippo Brunelleschi (1377–1446) was a prominent architect of the Renaissance; he designed and super-

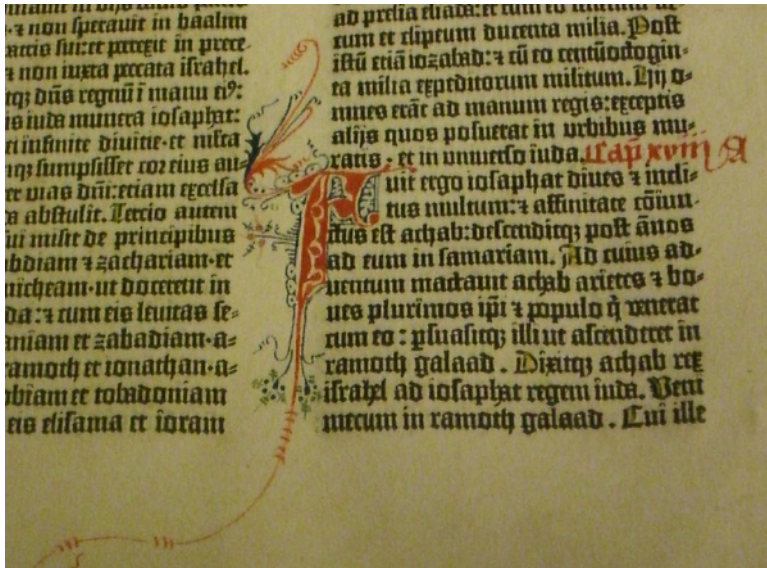

FIGURE 6.9

A close view of a page from the Gutenberg Bible. The black text was printed using the printing press; then, the red decorations were added by hand.

vised the construction of the dome of the Cathedral of Florence. He is credited with developing a geometrical understanding of perspective in about 1420; his understanding of perspective was rapidly adopted by Renaissance artists. He also invented several construction machines to help in the ambitious building construction projects that he supervised.

Mariano di Iacopo (1382–about 1458), known as Taccola (the crow), created two books of drawings of mechanical devices. He invented primitive forms of the cutaway and exploded views. In a cutaway view, portions of an object that block the view of the region of interest are cut away or removed so that the region of interest can be seen. In an exploded view, the components of an assembly are drawn separated from each other so that each component and its relationship with the others can be seen.

Leonardo da Vinci (1452–1519) is the best-known of these Renaissance artist-engineers. He used drawing and text together to perform thought experiments in many areas of engineering and science. These thought experiments include the design of a helicopter-like flying machine, a military tank, and a bridge. da Vinci developed the form of an engineering or scientific notebook that is used to support the process of engineering design or scientific inquiry. Figure 10 shows the design of a giant crossbow that da Vinci created.

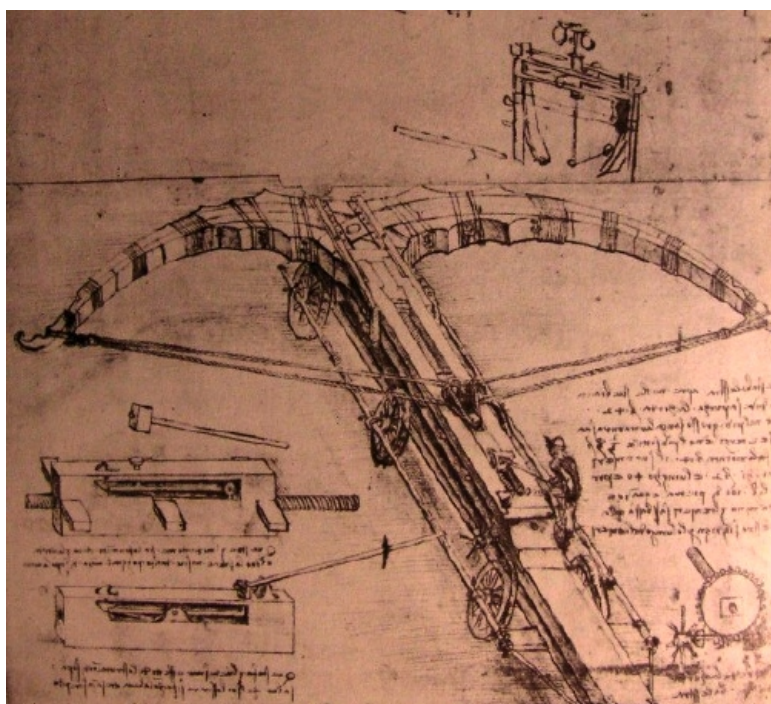

FIGURE 6.10

Drawing of the design of a giant crossbow created by Leonardo da Vinci.

6.5 The Industrial Revolution

The Industrial Revolution occupied the eighteenth and nineteenth centuries. It was a time of sweeping technological changes, most of them developed by engineers. A primary aspect of the Industrial Revolution is that machine power replaced human and animal power. For example, steam engines were developed to pump water from mines, replacing human or animal powered pumps. Also, during the Industrial Revolution, the field of engineering continued a transition from application of rules of thumb to application of the growing body of knowledge of science and math. During the Industrial Revolution, familiar engineering disciplines (particularly civil engineering and mechanical engineering) began to emerge as identifiable specializations.

There were many technical advances made during the Industrial Revolution. We briefly consider five advances in this section: the developments of an accurate clock to measure longitude, steam engines, automatic machinery for creating textiles, mechanical printing, and steam-powered transportation. While there were many other technological advances during the Industrial Revolution, these give an overview of the different processes and technologies that became important in this era.

Measuring Longitude

Longitude is the distance east or west of the prime meridian, an imaginary north-south line that passes through Greenwich, England. It is measured in degrees, with positive longitudes being east of the prime meridian and negative longitudes being west of the prime meridian. The measurement of longitude (along with the measurement of latitude) is an essential component of navigation. It was especially important in the 1700s as Europeans explored the rest of the world and attempted to make accurate maps and charts. It was also important for ships returning from long voyages; if a ship's captain did not correctly know the ship's position, the ship could be run aground on reefs or rocks; many shipwrecks occurred for this very reason.

Correctly determining longitude was a very difficult problem given the technological capabilities of the early 1700s. It was considered to be so difficult but so important that in 1714, the British Parliament passed legislation that created the Board of Longitude. The Board of Longitude offered a prize of 20,000 pounds sterling (a significant fortune at the time) to anyone who could develop an accurate method of determining longitude.

The simplest method of determining longitude is to determine the difference between the time at one's current location and the time at a known location (typically the prime meridian at Greenwich, England). In order to know the time at Greenwich, one must have a very accurate clock that has been set to Greenwich's time. Then, as one travels, the clock always tells the time at Greenwich. So one approach, and the one that was ultimately successful at winning the longitude prize, is to develop an extremely accurate clock.

John Harrison (1693–1776) was an English clockmaker, who in a series of five designs developed a clock accurate enough to win the Longitude Prize (although the full amount of the prize was actually never awarded to him). His clock had to maintain accurate time on long sea voyages on which temperature, atmospheric pressure, and humidity varied dramatically. He developed several different ingenious mechanisms as part of the clock. One was called a grasshopper escapement. The escapement is the mechanism that converts the swing of the pendulum into the turning of a gear by a specific amount for each swing; the gear in turn drives the mechanism that moves the clock hands. Another mechanism invented by Harrison was a gridiron pendulum; this was designed so that the length of the pendulum did not change as the metal rods from which the pendulum are made expand or contract due to changes in temperature.

John Harrison's development of his navel chronometer was motivated by the Longitude Prize. Because his early

designs showed promise, he received funding from a clockmaker and from the Board of Longitude to further develop them. He never received the full amount of the prize. On several voyages, his timepieces kept time accurately enough, but the Board of Longitude had concerns that the accuracy demonstrated by his chronometers was due to luck and was not repeatable. Figure 11 shows the last of the chronometers that Harrison developed.

The development of the maritime chronometer by John Harrison is an example of a single individual, working more or less independently, who was able to develop the technology necessary to solve a significant societal problem. Even though his technical accomplishments were primarily made as an individual, his work was significantly influenced by the society in which he lived. His inventions went on to dramatically affect the future of maritime navigation.

**FIGURE 6.11**

H5, the last in a series of maritime chronometers invented by John Harrison to measure time accurately enough to compute longitude.

Substantial prizes to motivate progress on a technological problem have been offered often in the recent past. In the early 1900s, the *Daily Mail* newspaper announced and awarded many prizes for first events in aviation; these included the first flight across the English Channel in 1909 and the first flight across the Atlantic Ocean in 1919. The Ansari X Prize offered \$10 million for the first nongovernment organization to launch a manned spacecraft into space; this prize was won on October 4, 2004, by SpaceShipOne. Since then, the X Prize Foundation has created several other prizes for genomics, automotive, and space accomplishments; these have yet to be won. The Defense Advanced Research Projects Agency (DARPA) created the grand challenge in 2004, in which vehicles without human drivers are required to navigate increasingly more difficult courses; winning teams in 2005 and 2007 have each received prizes of \$2 million.

Steam Engines

One of the major technological changes that began during the Industrial Revolution was replacing water, wind, human, and animal power by machine power. This first occurred in the development of the steam engine. The steam engine was originally developed to pump water out of coal and metal mines. (Water collected in mines when they were sunk below the water table of the surrounding rock.) Mechanical pumping of water could remove much more water from a mine than humans or animals powering the pump. This allowed mines to be made deeper. Steam

engines were also used to provide power for textile mills and other factories; this allowed mills to be located more conveniently to sources of raw materials and labor, rather than being located by streams and rivers.

The first commercially successful steam engine was developed by Thomas Newcomen (1664–1729) in England. His engine had a large cylinder in which a piston moved up and down. Steam was introduced into the cylinder and created a partial vacuum as it condensed; atmospheric pressure on the other side of the piston caused the piston to move. The piston was connected to a rocker arm; the movement of the rocker arm could be used to drive the pump. Figure 12 shows a cutaway drawing of the engine.

Newcomen and his partner John Calley had to reach an agreement with Thomas Savery (about 1650–1715), who had previously patented almost every imaginable use of steam power, before being able to commercially market their invention. The first Newcomen engine was installed in 1712. By the time the patent under which the machines were manufactured expired in 1733, about 100 of his steam engines had been built and installed. During this time, his design was improved so that it would run automatically. His design was very inefficient and required a large amount of fuel; it also had a limited height to which it could pump water. In spite of these drawbacks, it was widely adopted even after improved steam engines became available because of its mechanical simplicity.

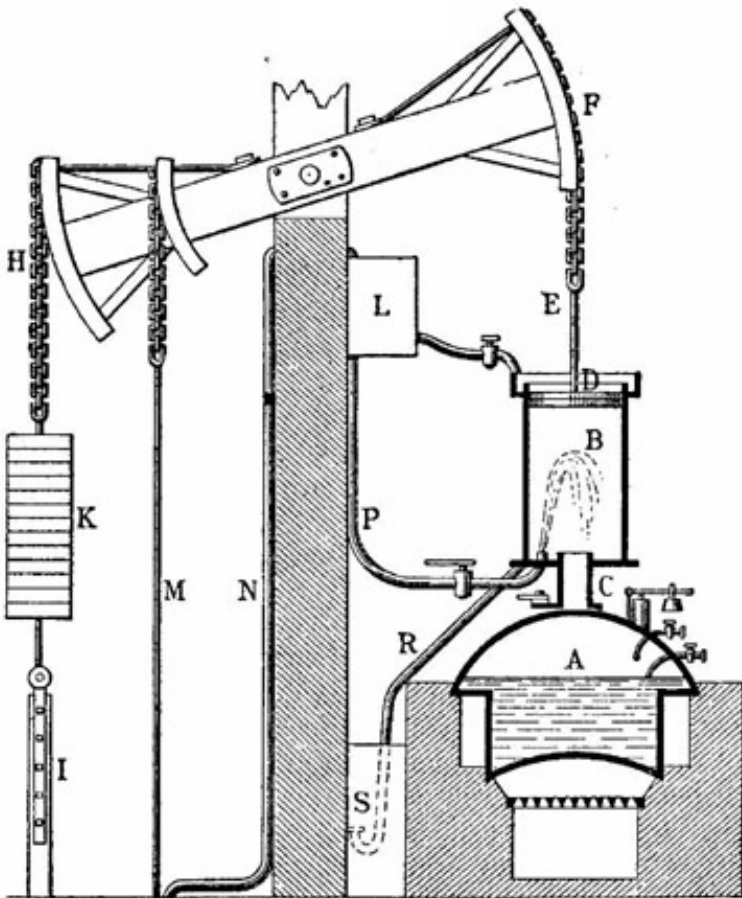

FIGURE 6.12

A drawing of the Newcomen steam engine. The letter "D" marks the piston that moves up and down in the cylinder.

James Watt (1736–1819) developed an improved version of the steam engine. His engine was much more efficient than Newcomen's, requiring only a quarter as much fuel, and thus was much less costly to run. He developed a working model of the engine in 1765, but required significant additional time to make the engine commercially successful. He received a patent on the engine design. He partnered with Michael Boulton (1728–1809), the owner of a successful iron factory, who provided the financial backing necessary to develop and market his engine. His

first commercial engine was installed in 1776. In 1781, he developed a version of the engine that provided rotating motion (rather than the rocking motion of his previous engine) that could drive factory machinery. Watt eventually became a very wealthy man on the basis of sales of his steam engine.

The development of the steam engine was pivotal in several different areas. One was the introduction of machines into manufacturing of textiles and other goods. In addition, the steam engine transformed transportation; in particular, the development of the steamship and the steam locomotive greatly increased the speed with which people could move and increase the amount of materials and goods that could be moved. The metric unit of power is named after Watt. Thus, one can talk about a “100 watt” lightbulb as a bulb that uses 100 watts of (electric) power.

Textiles

One industry that was transformed by the Industrial Revolution was the creation of textiles (cloth). Before the Industrial Revolution, textile manufacture was a cottage industry; cloth was made by people working in their homes or in small groups. After the Industrial Revolution, cloth was made in large factories using machinery powered by water or steam engines.

The creation of textiles involves two processes. The first, spinning, is the manufacturing of thread or yarn from fibers such as cotton or wool. The second is weaving the thread or yarn into fabric. Inventions in the textile industry occurred both in England and the United States.

The first cotton mill in England was opened in 1764. Prior to this time, the majority of cloth produced in England was wool. Cotton requires more extensive processing to create fabric and thus was better suited to an industrial approach. In 1769, Richard Arkwright (1733–1792) patented the water frame, a machine that used water power to spin cotton into thread. In 1771, Arkwright installed the water frame in his cotton mill; this created one of the first factories that was constructed to house machinery; previous factories were primarily designed to bring workers together into one place.

These and other technological developments in the 1770s and 1780s made the British textile industry possible and highly successful. This technology was carefully protected by the British government; export of textile machinery was forbidden, and textile workers were prohibited from sharing information or leaving Britain. Samuel Slater (1768–1835) was born in England and apprenticed in a cotton factory partly owned by Richard Arkwright; during his apprenticeship, he memorized the technical details of the factory’s machinery. He became aware that the United States was offering to pay for information on textile manufacturing, and in 1789 immigrated to the United States disguised as a farmer. With the financial backing of Moses Brown, a merchant, he built America’s first waterpowered spinning mill in Pawtucket, Rhode Island. Slater employed families, including women and children, in this and subsequent mills that he constructed.

Slater’s acquisition and use of technological information that its original owners wished to keep secret is an example of industrial espionage. Industrial espionage is a practice with a long history that continues today.

One of the most famous American engineering developments associated with textiles was the invention of the cotton gin by the inventor Eli Whitney (1765–1825) in 1792; the cotton gin is a machine that removes seeds from cotton after it is picked. Figure 13 shows the internal machinery of Whitney’s cotton gin. Prior to the invention of the cotton gin, this job was done by hand. In addition to the development of the cotton gin, Eli Whitney promoted the idea of interchangeable parts for mechanical devices. Before the development of interchangeable parts, each part of an object was manufactured individually and fit together in a painstaking process. Interchangeable parts are standardized; this allows, for example, one screw in a machine or a gun to be replaced by another screw without the need for reshaping any parts.

**FIGURE 6.13**

Internal workings of the original cotton gin developed by Eli Whitney.

Mechanical Printing

The process of setting type remained largely unchanged for 400 years after 1480. Letter molds were cast by hand, and these molds were hand assembled into rows and pages of text.

The industrial revolution in the nineteenth century brought changes, first to the printing processes, and then to typesetting. Friedrich Koenig (1774–1833) invented a steam-powered printing press; the first commercial unit was sold to the *London Times* in 1814. This press is shown in Figure 14. This press could make 1100 impressions per hour, which was much faster than hand-operated presses could print; this technology facilitated the emergence of a daily newspaper that was widely circulated and read. In 1835, the first commercial web press was introduced; a web press prints on a continuous roll (web) of paper. In 1844, Richard Hoe (1812–1886) in the United States developed the rotary printing press (Figure 15). This press could print over 20,000 copies per hour.

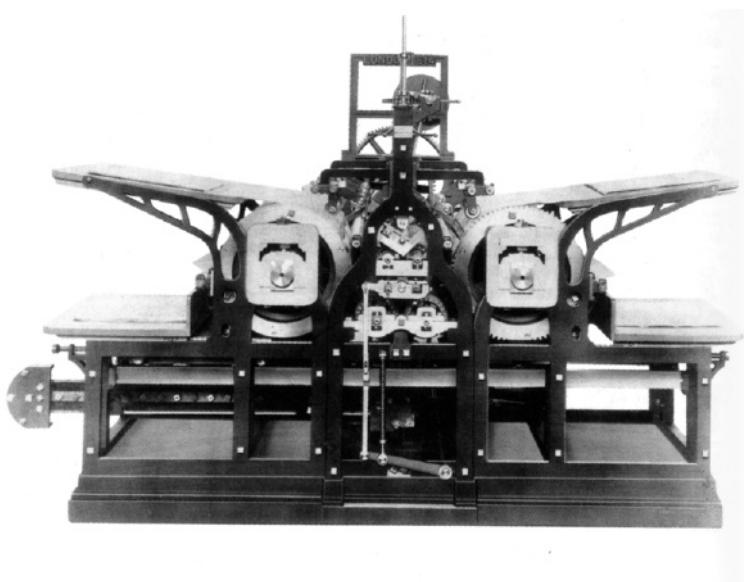
**FIGURE 6.14**

Steam press invented by Friedrich Koenig in 1814.

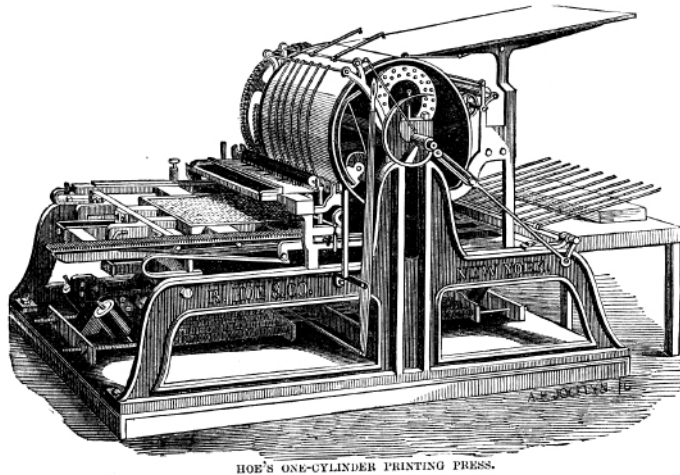
**FIGURE 6.15**

Rotary printing press invented by Richard Hoe.

Steam Powered Transportation

The development of the steam engine had a revolutionary effect on mining and manufacturing. As human and animal power were replaced by steam power, resources and manufactured goods could be acquired more efficiently. By the end of the eighteenth century, steam engines had become viable power sources for boats and trains. This in turn had a dramatic impact on society; the ability to transport people and goods over long distances provided significant opportunities for economic growth. It also made possible the westward expansion of settler populations in the United States.

In the late eighteenth century, there was a significant amount of experimentation with methods to power a ship using a steam engine. Various propulsion methods were tried; these included paddles suspended from the rear of the boat and the screw propeller. Robert Fulton (1765–1815) was the first to successfully develop a steamship in the United States. In 1807, he completed construction of 146 foot-long steamboat. The boat was powered by a 24 horse-power Boulton and Watt engine. It used wood for fuel. The boat transported passengers and cargo between New York City and Albany, New York, much more quickly than a sail-powered boat could. The steamboat service became very profitable for Fulton and his financial backer, Robert Livingston (1746–1813).

The United States has an extensive network of navigable rivers. In particular, the Mississippi River and its tributaries can be used to navigate much of the central United States. In 1811 and 1812, Fulton constructed a steamboat in Pittsburgh that traveled down the Ohio and Mississippi rivers to New Orleans. Livingston and Fulton had obtained a monopoly on steamboat travel in Louisiana; their steamboats were again very commercially successful. Their steamboats were the first of many that navigated the rivers of the United States. From 1815 through 1860, steamboats dominated transportation of goods and passengers on rivers. Throughout this time, there were significant improvements in engineering; by 1850, many steamboats could travel at 20 miles an hour. Figure 16 shows a painting of the steamboat Robert E. Lee; it was built in 1866, and set a record for the fastest trip between St. Louis and New Orleans. It was destroyed in 1882 when it caught fire 30 miles outside of New Orleans. (Boiler explosions and fires were fairly common occurrences on steamboats, which made them a somewhat dangerous mode of transportation and led to government safety regulations.)

As important as was the development of steam-powered ships, the development of steam-powered railroads had a much greater effect on the United States economy in the later half of the nineteenth century. Trains came to be the dominant mode of transport during this time. The corporations that built and operated the railroad system were the

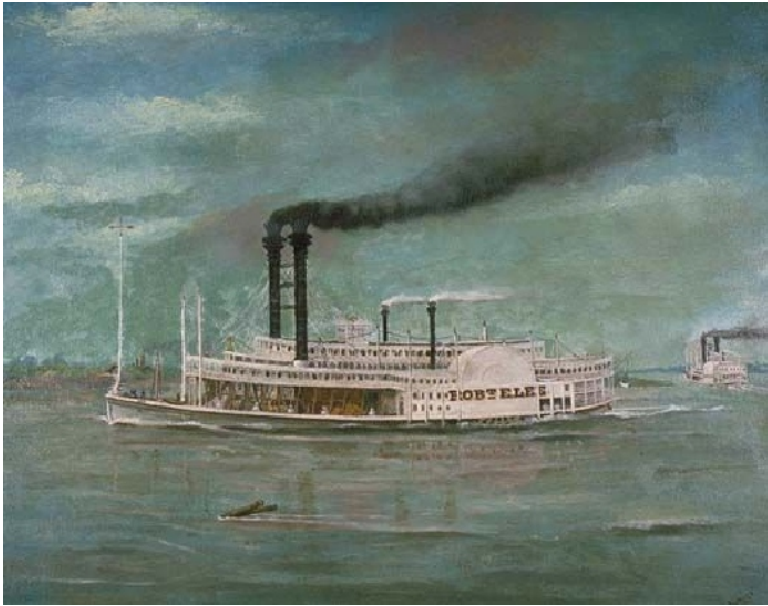
**FIGURE 6.16**

Painting of the steamboat Robert E. Lee by August Norieri.

largest corporations during this period and created significant wealth for their owners.

The first rail locomotive was built in 1803 in England by Richard Trevithick (1771–1833). The first railroad in England, however, did not go into service until 1825. In 1829, Robert Stevenson (1803–1859) designed a locomotive called the “Rocket,” which had many of the features of later steam locomotives; these include a multitubular boiler and wheels driven by near-horizontal pistons. Figure 17 shows a drawing of the Rocket.

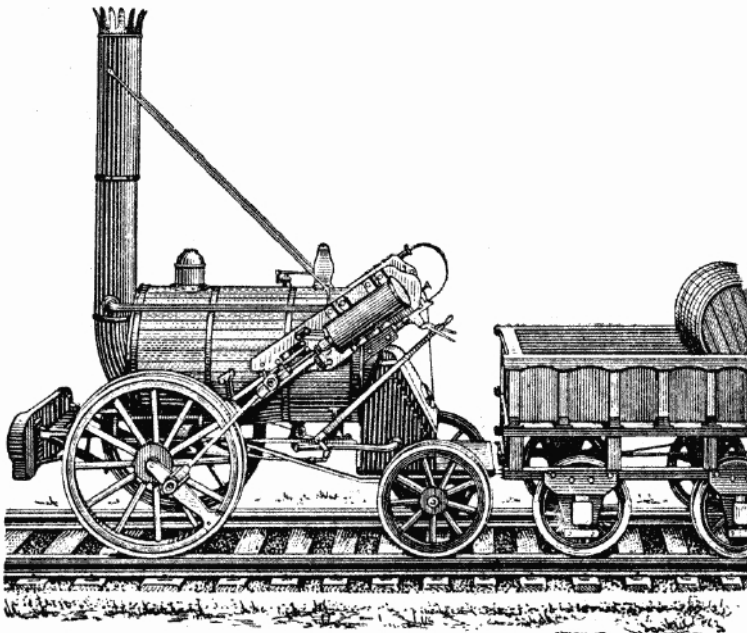
**FIGURE 6.17**

Drawing of the locomotive Rocket.

The first commercial railroad in the United States was the Baltimore and Ohio Company; in 1830, it opened the first 13 miles of track in the United States. By 1860, there was over 30,000 miles of track in the United States. American

engineers adapted British locomotive designs to the unique constraints and problems posed by the United States. American engines were larger and more powerful than British engines because American rail systems had steeper grades; American tracks also had tighter curves, necessitating the design of the bogie truck. American train tracks are not fenced, so engineers designed cow catchers on the front of the locomotive. New engineering techniques were also developed for the construction of the rail lines and the bridges and tunnels that they required.

One of the greater engineering feats of the industrial revolution was building the First Transcontinental Railroad. This railroad linked Omaha, Nebraska, with Sacramento, California. It was authorized by the United States federal government in 1862 and was completed in 1869. This railroad dramatically changed travel to the western United States; before its completion, this travel involved a journey of many months in a horse- or oxen-drawn wagon. After its completion, the journey could be made in a week.

6.6 Rise of the Corporation

The pace of technology development increased steadily in the last half of the nineteenth century and the first decades of the twentieth century. New technologies were involved in the creation and growth of corporations; fortunes were made through new technological developments.

A great change for engineering was that science began to directly inform engineering in fields such as steelmaking, generation and distribution of electricity, and chemistry. Standards for engineering education, which increasingly involved a university education, were developed, and the modern engineering disciplines of Electrical and Chemical Engineering joined Civil and Mechanical Engineering. This was coupled with the creation of engineering professional societies.

Electricity

By 1870, scientists such as Michael Faraday (1791–1867) and James Maxwell (1831–1879) had provided a firm theoretical understanding of electricity. Electricity was widely used in communications—the telegraph made long-distance communication essentially instantaneous. Electricity was supplied to the telegraph by a battery or an inefficient generator, which was still very expensive.

A dynamo is a machine that converts rotational energy supplied by a steam engine or waterwheel into electrical energy. During the 1870s, dynamos were developed that provided efficient methods of generating electricity. This set the stage for the development and widespread use of the lightbulb.

Thomas Edison (1847–1931) is generally given credit for the invention of the lightbulb in 1878. He was a prolific inventor, developing devices such as the phonograph (shown in Figure 18), which recorded and played back sound, and a moving picture projector; he is quoted as saying “genius is one percent inspiration and ninety nine percent perspiration.” He was not a solitary inventor—he led a large research laboratory with over 30 scientists, engineers, and craftsmen. His practice of using an organized research laboratory to develop new inventions was soon adopted by many others and formed the basis of much industrial manufacturing.



FIGURE 6.18

Thomas Edison and an early phonograph.

Edison began the development of the lightbulb to provide a method of lighting homes and businesses at night. His goal was to make money. The competing technologies of the time were gas lighting and carbon arc electric lamps.

Carbon arc lamps emit a very bright, harsh light; they were not suitable for indoor lighting. Thus, one goal of Edison's development was creation of a light source that provided lower light levels than carbon arc lamps. To be economically competitive, electric lighting had to be safer and cheaper than gas lights; this imposed difficult constraints on the design of the lightbulb.

As is often the case, Edison did not invent the lightbulb from scratch. Rather, he adapted and improved existing technologies, particularly related to the lightbulb filament and to creating a vacuum within the lightbulb, to create a working bulb. In addition to the lightbulb, his research lab created a system of dynamos and wiring to provide electricity to power his bulbs in homes and businesses. In the process, they developed many devices that are still used in modern systems, including fuses to prevent current overloads, meters to measure electricity use, and switches to turn lights off and on. Edison's first lighting system was installed in New York City in 1881. Figure 19 shows one of Edison's original lightbulbs.



FIGURE 6.19

An original bulb made by Edison's workshop in 1879.

Although he was hailed as the inventor of the lightbulb, Edison's electrical system was not the technology that was ultimately used to produce and distribute electricity in most parts of the world. Edison's system used direct current (DC). Shortly after Edison installed his first system, George Westinghouse (1846–1914) developed a competing

system that used alternating current (AC). The first AC current system was installed in 1886, and several more followed in the next several years. The competition between Westinghouse and Edison to dominate the electrical generation and distributional business was labeled “The War of the Currents.” AC systems had significant technical advantages over DC systems, but Edison mounted an aggressive public relations campaign that played on the public’s fears of electrocution. In one particularly distressing case, the state of New York bought an electric chair to execute criminals; this chair operated using AC current. Edison attempted to name the process of being executed “being Westinghoused.” By 1892, AC became the primary method of electrical distribution, and even Edison’s company began manufacturing AC equipment.

The Edison General Electric Company merged with the Thomson-Houston Electric Company to create General Electric (GE) in 1892. This company still exist today and is a leader in many technology fields including electrical generation and distribution, aircraft engines, medical systems, and media production and distribution.

Powered Flight

Orville Wright (1871–1948) and Wilbur Wright (1867–1912) were brothers who are credited with having achieved the first powered flight. They built on the earlier work of many pioneering engineers, including Otto Lilienthal (1848–1896) and Samuel Langley (1834–1906). They owned and operated a printing press and a bicycle shop in Dayton, Ohio. The bicycle shop provided both funding and mechanical experience for their investigation into powered flight.

They began serious investigation into flight in 1899. The death of Otto Lilienthal in a glider accident in 1896 as well as other accidents involving experimental gliders convinced them that an extremely important aspect of developing a heavier than air flying machine is understanding how to control it. They felt that the other primary issues—sufficiently powerful engines and shaping the wings for lift—had been solved. Thus, unlike other investigators of flight, they conducted careful experiments with kites and gliders to understand how to create controllable airplane designs. They developed a technique of wing warping (bending of wings) to cause the aircraft to bank and move up and down.

In 1900, the Wright brothers began experiments at Kitty Hawk, North Carolina, with gliders. Between 1900 and 1903, they combined scientific theory with careful experiments to refine the equation that predicted the lift of wings. In the process, they discovered that long, narrow wings provided more lift than short, wide ones. They used this discovery in creating their powered aircraft. They also discovered how to control an aircraft in turns—by banking the wings and turning the nose with a vertical rudder. In 1902, they made between 700 and 1,000 flights in gliders to confirm that they could be properly controlled. They applied for a patent on their three axis method of control in 1903.

In the 1890s, the nascent automobile industry had developed the gasoline internal combustion engine to the point that, by mid-1903, it was a viable power source for the Wrights planned airplane. Their shop mechanic built an engine in six weeks. They took their airplane to Kitty Hawk, North Carolina. After several weeks of delays necessitated by repairs of propeller shafts, on December 17, 1903, the Wright brothers made four powered flights, the longest of which was over 850 feet. Figure 20 shows this first powered flight.

Between 1903 and 1908, they developed the Wright flyer, which they attempted to market to the U.S. Army. Between 1908 and 1910, they gave demonstration flights in France and the United States. They were celebrities in France, and thousands of people gathered to watch their airplanes fly. They incorporated the Wright company in 1909; Orville Wright sold the company in 1915.

Neither of the Wright brothers had a formal education in engineering or science. They did have significant technical experience from their bicycle shop, and they used the scientific method to develop the control structures that made their airplane successful.

**FIGURE 6.20**

The Wright brothers' first powered flight.

Automated Typesetting

The late nineteenth and early twentieth century saw the automation of the setting of type, much as the early nineteenth century saw the automation of the printing process. Engineers invented machines that could cast and set type much faster than could be done by hand. The two most successful of these machines were the Monotype and Linotype machines.

Tolbert Lanston (1844–1914) invented the Monotype casting system. This system, developed between 1885 and 1896, cast the individual letters from molten type metal, and then arranged the letters into rows of type. This system consisted of two parts: a keyboard, at which an operator would select the sequence of letters and other symbols that were then punched into a paper tape, and the typesetter, which took the paper tape and cast the appropriate letter blocks. Figure 21 shows a Monotype keyboard with the paper tape punch. The Lanston Monotype Machine Company was founded in 1887 and eventually manufactured machines in both the United States and England. In 1907, the US Government Printing Office was the largest installation of Monotype machines in the world, with 162 keyboards and 124 casters.

Ottmar Mergenthaler (1854–1899) invented the Linotype machine. The first Linotype machine was installed in the New York Tribune newspaper office in July of 1886. The Mergenthaler Linotype Company was founded in Brooklyn, New York, in 1889. Figure 22 shows a Linotype machine. Using input from an operator at a keyboard, the machine assembled matrices for an entire line of text, which was then cast in type metal as a slug.

The Monotype and Linotype machines were the primary methods of setting type until the 1950s. In the 1950s, metal

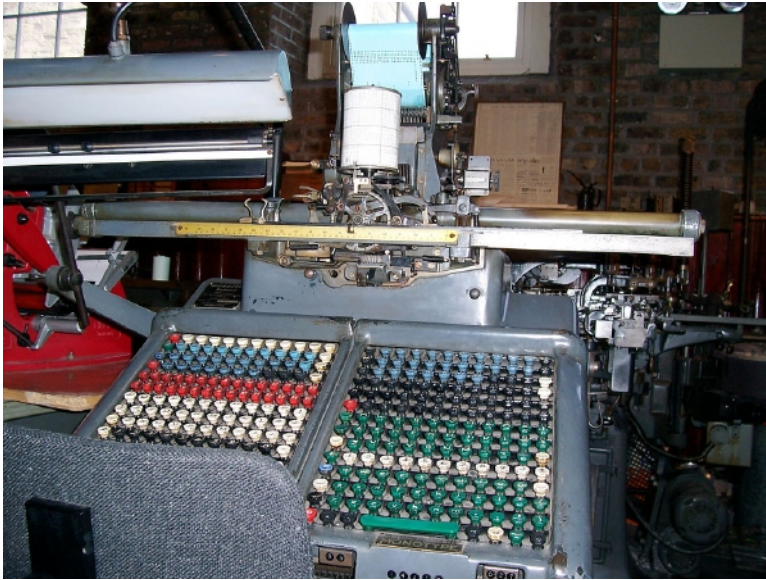
**FIGURE 6.21**

A keyboard for the Monotype casting system.

type began to be replaced by photo typesetting, in which photographic processes are used to create plates with raised areas that are inked before coming in contact with the paper.

Engineering as a Modern Profession

Through the middle of the nineteenth century, most engineers received training through apprenticeships and on the job experience. In the latter third of the nineteenth century, land-grant colleges were established, and many of these included engineering schools. These schools provided programs of study in the established fields of Civil and Mechanical Engineering as well as the newer fields of Chemical and Electrical engineering. Even though many of the great engineering accomplishments at the turn of the century were made by craftsmen without a formal engineering education, the newly established corporate research laboratories increasingly began hiring workers with university degrees in engineering.

In the latter half of the nineteenth century, engineers began to form trade organizations with the purpose of increasing the stature of the engineering profession. These organizations develop standards to distinguish professional engineers with necessary qualifications from technicians and others without qualifications. The first of these trade organizations was the American Society of Civil Engineers, founded in 1852. The American Institute of Mining and Metallurgical Engineers was founded in 1871, the American Society of Mechanical Engineers was founded in 1880, and the American Institute of Electrical Engineers was founded in 1884. These organizations often had close links with colleges and universities, and helped define the theory and practical aspects of an engineering education.

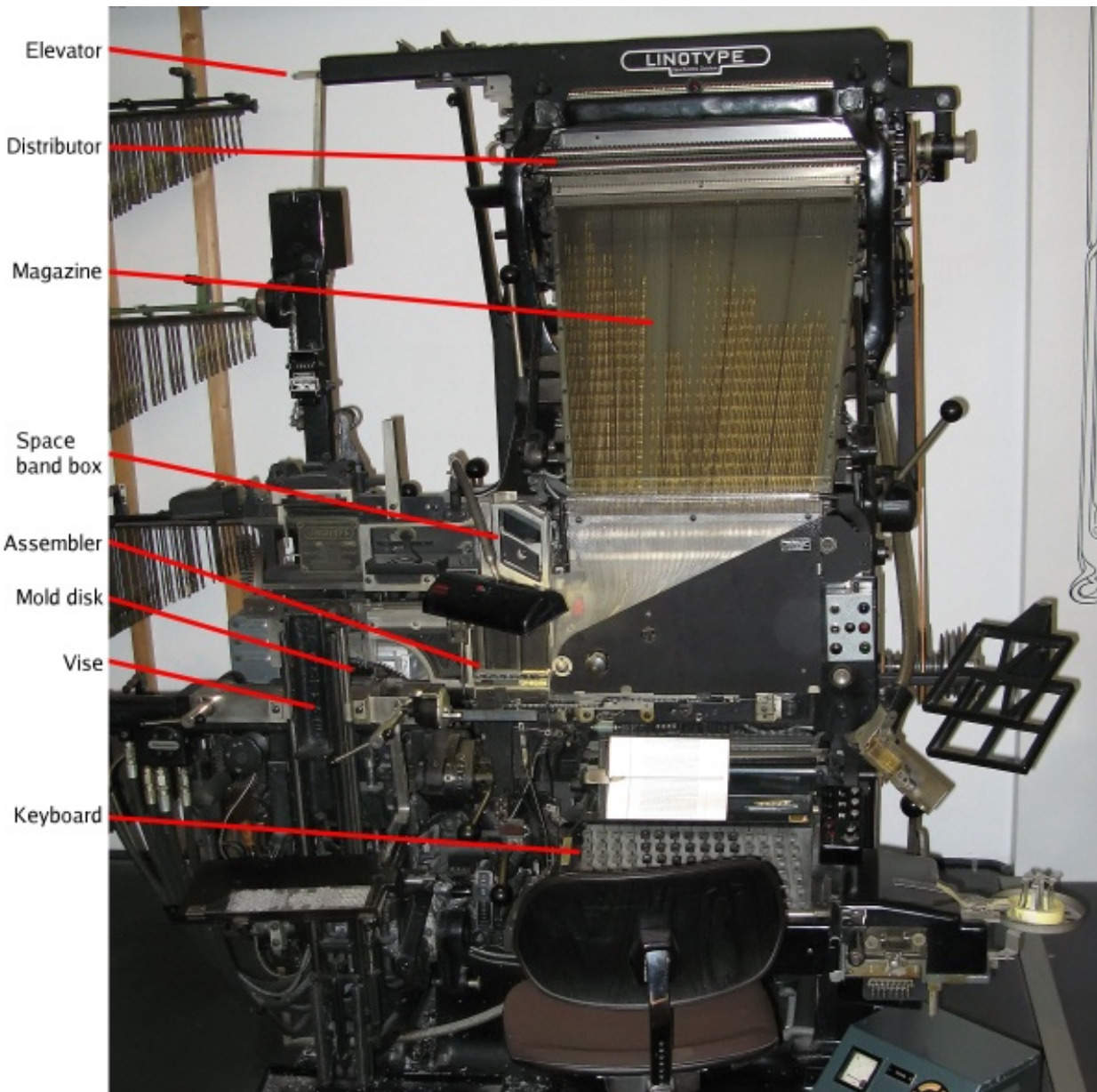

FIGURE 6.22

A Linotype type-casting system.

6.7 The Early Twentieth Century

In the early twentieth century, engineering accomplishments increasingly began to affect the lives of middle-class Americans. The automobile provided increased mobility to millions. The development of commercial radio broadcast began the creation of a popular culture and an American mass identity.

Henry Ford and Mass Production

Henry Ford (1863–1947) left home at 16 to work as an apprentice machinist in Detroit, Michigan. He was later hired by the Westinghouse Company to service steam engines, and in 1893 became the chief engineer of the Edison Illumination Company. This position provided time and money for him to begin experimenting with vehicles powered by gasoline internal combustion engines. Before 1903, he created several companies to produce and market gasoline powered automobiles, but they were not economically successful.

In 1903, Henry Ford created the Ford Motor Company. His goal was to produce an affordable and reliable car that could be purchased by an average American farmer or worker. After several years of experimentation and design, the Ford Company introduced the Model T in 1908; Figure 23 shows a Model T. In many aspects, the Model T was quite similar to the car of today: it had a steering wheel on the left, its engine was enclosed in a hood, and it had a windshield and rear wheel drive. Note that Henry Ford did not personally develop the detailed design of the model T. This was done by a team of engineers with the range of skills and expertise necessary for the project.



FIGURE 6.23

A restored Ford Model T.

One of the technical advances that made the Model T possible was the use of a vanadium steel alloy with much higher strength than normal steel. However, from an engineering point of view, the most significant innovation associated with the Model T was the production system that allowed it to be produced and sold very economically. Between 1909 and 1913, the Ford company adopted all of the techniques necessary for mass production using an assembly line. These techniques include

- Use of standardized parts.
- Specialized labor—each worker performed a very specific operation in the assembly of a Model T.
- Moving assembly line—partially assembled vehicles were moved automatically down the line, past stations where workers added components.

Figure 24 shows the use of an assembly line to attach car bodies to the car frame. These assembly-line techniques dramatically reduced the cost of assembling the Model T, and the sales price of the car was repeatedly lowered. In 1909, its first full year of production, 18,000 vehicles were built; in 1915, one-half million were sold, and in 1920, the production exceeded one million annually.

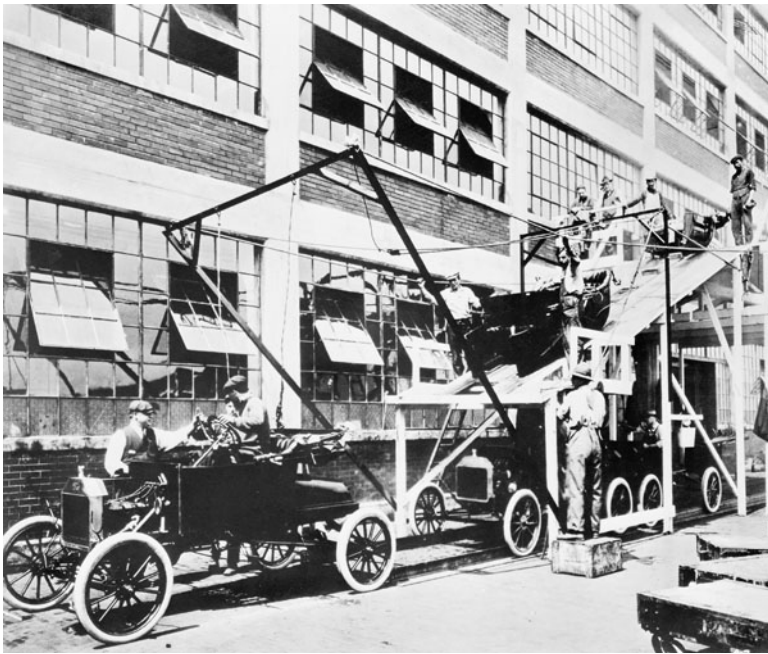
**FIGURE 6.24**

Part of a Ford assembly line.

To retain workers in the difficult assembly-line environment, Ford paid his workers five dollars per day, which is a very high wage for that time period. This, combined with the low price of the Model T, meant that Ford workers could actually afford to buy the car on which they worked. Such buying power and affordability was unprecedented. By the end of the 1920s, one in five people owned an automobile, which dramatically affected the structure of American society.

Radio

The advent of radio, which provided live broadcast to millions of listeners simultaneously, was a significant factor in the creation of an American national identity.

In the last several decades of the nineteenth century, physicists such as James Maxwell (1831–1879) and Heinrich Hertz (1857–1894) developed a theoretical understanding of the propagation of electromagnetic waves. They also experimented with methods of producing electromagnetic waves. This work was primarily for scientific purposes; they did not anticipate practical applications of their work.

Beginning in 1894, Guglielmo Marconi (1874–1937), an Italian inventor, began experimenting with radio transmitters and receivers with the goal of creating a system of “wireless telegraphy”—a system that could transmit information much as the telegraph did, but without the need for wires to connect transmitter and receiver. Similar

to many engineers before him, he adapted and combined existing technology to form a system that could be used to communicate between land and ships. The system allowed the transmission of Morse code, similar to a wire-based telegraph. By 1903, he had successfully demonstrated the transmission of signals across the Atlantic Ocean. On the basis of his technology, he founded the Marconi Wireless Telegraph Company in 1900. Many of his patents in wireless technology were challenged by Nikola Tesla (1856–1943) and others in the United States and other countries; decisions in these cases vary from case to case and from jurisdiction to jurisdiction.

Marconi's system allowed transmission of Morse code only. At the turn of the century, several researchers believed that the transmission of voice and other sound by radio could be possible. To this end, several technologies were developed that provided early demonstrations of the concept, but ultimately were not commercially successful. A significant amount of time and money was expended to make them practical, including a significant effort by GE, but these efforts were unsuccessful.

The technology that was eventually successful at transmitting and receiving sound over radio was the vacuum tube. This technology eventually enabled a whole host of electronic developments including radar, computers, and television. The triode vacuum tube was patented in 1906 by Lee De Forest (1873–1961). Throughout the 1910s, several corporate research labs, including those of GE and the AT&T Bell System, worked to improve the triode, and it quickly became the basis of radio transmitters and receivers. Figure 25 shows an early radio receiver implemented with vacuum tubes.



FIGURE 6.25

An early radio receiver. The four silvery cylindrical objects along the back of the receiver are vacuum tubes.

In 1910, De Forest used a transmitter and receivers built with triodes to broadcast performances of two operas; this is regarded as the first public radio broadcast. The program was received by radio receivers and several ships in New York Harbor and in hotels around New York; the sound quality was extremely poor.

In 1919, the Radio Corporation of America (RCA) was formed. RCA's original purpose was to develop radio for point-to-point communications, but David Sarnoff (1891–1971), who was highly influential within RCA and eventually became its president, and others soon realized that radio as a broadcast medium had significant economic potential in the form of sales of radio receivers. However, radio broadcasts were necessary to sell radio receivers. Westinghouse started the station KDKA in 1920. By 1922, over 600 stations were broadcasting. At the same time, GE and Westinghouse began to manufacture home radio receivers.

In 1926, RCA created the first network of radio stations that shared programming, creating the National Broadcasting Company (NBC). NBC was soon followed by the Columbia Broadcasting System (CBS) and the American Broadcasting Company (ABC). Within a decade, the networks had developed the advertiser-supported programming

format that is still used in radio and television. The “Golden Age” of radio included programs of all types, from music to sitcoms to adventures, supported by advertising for automobiles, home appliances, cigarettes, and other consumer goods. By the late 1930s, four out of five US households had a radio.

The development of radio, unlike many of the preceding engineering developments, reflects the continuing shift from lone inventors to the work of engineers working within existing corporations. In radio, many of the initial technical developments were made by single inventors or small companies. But once the concepts were established, large corporations became involved and dominated the growth of the markets and technology.

6.8 The Computer Age

Experimental computers were first developed in the 1940s, and became commercially important in the 1950s. Since then, they have become increasingly involved in almost every component of technology.

Electronics and the Computer

The development of the computer has had as large an effect on society as any previous engineering advance. Today, computers are involved in every aspect of our lives. They allow instant retrieval of information from any part of the world. They monitor and control the performance of almost every mechanical system we use, including automobiles, airplanes, appliances; they also control large systems such as electric power generation and distribution grids. Computers make cell phones and the Internet possible. The computer pervades the creative work of artists; it provides formerly undreamed of opportunities for relaxation and entertainment; and it has dramatically changed the way that engineers and scientists perform their work. In this section, we briefly review the coupled histories of the computer and the electronics industry.

Advances in computer technology depended on developments in the electronic industry; indeed, the advanced computing power available at low cost today is a direct consequence of improvements and advances in the technology of electronics. Beginning in the 1910s, and continuing through the 1950s and 1960s, the vacuum tube was the primary technology used to implement electronic devices such as radios, televisions, and other myriad inventions. However, tubes had several drawbacks—they were large, required large amounts of power, and were relatively fragile.

Most of the pioneering computers designed and built in the 1940s were constructed using vacuum tubes. These early computers were much less powerful than a typical microcontroller that controls a modern microwave oven; the circuits for these early computers often filled entire rooms. Vacuum tube technology was unreliable—tubes often burned out and required replacements. In 1951, the Remington Rand Corporation delivered the first Univac I computer to the US Census Bureau; eventually, more than 40 of these computers were sold at a price of over \$1 million each. Figure 26 shows a UNIVAC I. In 1952, International Business Machines (IBM) introduced the IBM 701. In the following decades, both of these as well as other companies made significant profits designing and selling large mainframe computers. (Remington Rand eventually became Sperry Rand, which later became Univac.) The design and implementation of computers employed thousands of engineers; most of these engineers were electrical engineers. IBM, with its large sales and service staffs, owned about 70% of the computer market by the late 1950s. This is a position they maintained until the 1970s, when minicomputers were introduced and dramatically cut into the market share owned by mainframe computers.

In 1948, John Bardeen (1908–1991), Walter Brattain (1902–1987), and William Shockley (1910–1989), three researchers at Bell Laboratories (a research lab of AT&T), invented the transistor. They were awarded the Nobel Prize for this invention in 1956. The transistor performs the same electronic function as a vacuum tube, but since it is fabricated from silicon and metal and requires no glass tube to contain a vacuum, it can be made much smaller and more physically robust than a vacuum tube. A significant amount of research and development was necessary to make the transistor commercially viable; by the early 1960s, transistors had replaced vacuum tubes in most electronic devices. This made possible the portable transistor radio, for example.

Transistors were widely used in the design and construction of computers in the late 1950s and early 1960s. Transistor technology allowed computers to be smaller, faster, and use less power to operate.

A second electronics innovation that dramatically affected computers was the invention of the integrated circuit

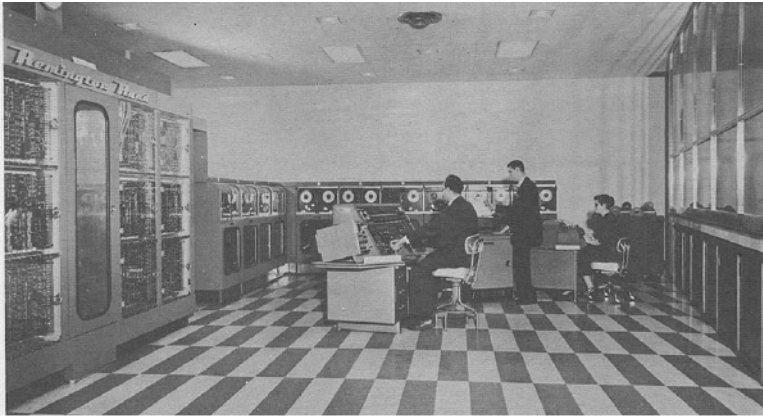
**FIGURE 6.26**

A UNIVAC I installed at the Franklin Life Insurance Company.

independently by Jack Kilby (1923–2005) of Texas Instruments and Robert Noyce (1927–1990) of Fairchild Semiconductor in 1958. The integrated circuit combined many transistors into a single silicon chip. Chips could be cheaply and quickly manufactured and provided many benefits to computer designers, including faster computation, lower power consumption, smaller physical size, and lower production costs.

Integrated circuits were used in computer design beginning in the mid-1960s. They made possible the development of the minicomputer. The first minicomputers were made by Digital Equipment Corporation. Other minicomputer manufacturers included Data General, Wang Laboratories, Apollo Computer, and Prime Computer. Compared to a typical mainframe computer, minicomputers were small (about the size of a small desk) and cheap (costing tens of thousands of dollars). Figure 27 shows a PDP-12 minicomputer. Minicomputers made computers available to smaller companies and university research laboratories.

Finally, a new generation of personal computers was made possible by the invention of the microprocessor. Microprocessors were invented independently and about the same time at Texas Instruments and Intel in 1971. A microprocessor is an entire computer processor integrated on to a single chip. Figure 28 shows a Zilog Z80 microprocessor that was manufactured in 1976. Microprocessors allowed computers to be built cheaply enough that hobbyists could afford to build their own computers. In the mid-1970s, several companies were founded to supply computers and computer kits to hobbyists. Apple Computer Co. was one of these; Steve Jobs (1955–), its cofounder, quickly realized that the computer could be used by a much larger market than hobbyists, and dramatically increased the market for low-end computers. Figure 29 shows an Apple II, the computer that established Apple as a player in the computer market. In 1981, IBM entered the market with the IBM personal computer (IBM PC) and quickly became the dominant personal computer manufacturer by marketing to business and government users; the IBM PC also played a crucial role in the establishment of a small, new company named Microsoft.

Since the invention of the integrated circuit, the capabilities of electronics have essentially doubled every eighteen months to two years. This is a phenomenon that has been called Moore's Law, named after Gordon Moore (1929–), one of the cofounders of Intel. This has resulted in the rapid evolution of the computer into today's powerful desktop and laptop machines. Engineers have played key roles in this evolution.

The development of the computer has dramatically affected engineering, as it has most of modern life. Computers are now used by engineers in all phases of their work, especially design and analysis. Computer-aided design (CAD) software is used to create designs, which can then be fabricated using computer-controlled machinery. Electrical engineers use CAD tools to design new computer and other circuits; the software allows engineers to manage the complexity of designing circuits that contain over one billion transistors. Computers are also used to analyze designs. For example, electrical engineers use computer simulators to verify that circuit designs will operate correctly. Mechanical and civil engineers use computer analysis tools to compute stresses and structures to ensure that the structures will not fail.



FIGURE 6.27

A PDP-12 minicomputer manufactured by Digital Equipment Corporation about 1970.

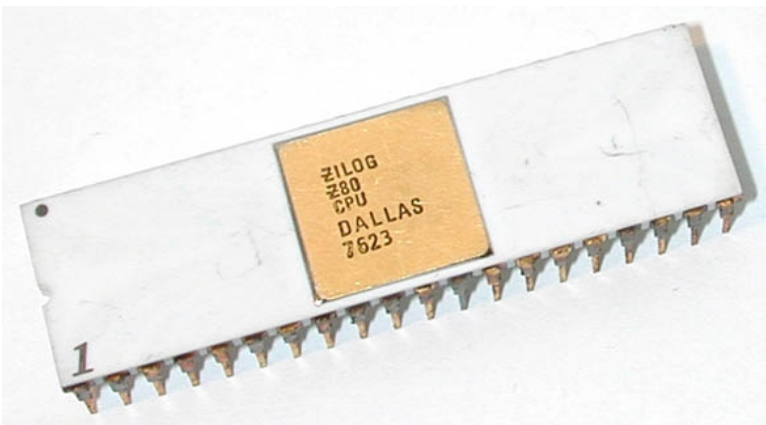

FIGURE 6.28

A Zilog Z80 microprocessor manufactured in 1976.

The use of computers to design and build even more powerful computers has created a positive feedback loop. This feedback loop has accelerated the development of computer technology.

In many cases, new computer architectures and technology were invented by small, newly formed companies that

**FIGURE 6.29**

An Apple II computer manufactured about 1980.

grew explosively once they began marketing their products. The evolution of the computer industry shows repeated occurrences of disruptive technology. A disruptive technology is typically introduced into a new market that is not currently being served by an existing technology. In this new market, the technology is improved until it is superior to the original technology. The improved technology then begins to displace the original technology and original markets. In computers, the personal computer is an example of disruptive technology. It was introduced originally for hobbyists and home users, and did not initially compete with larger mainframe and minicomputers. However, as personal computer technology has improved and matured, it has replaced minicomputers almost entirely and is beginning to replace mainframe computers for many applications.

Computerized Typesetting and Printing

The advent of the computer has had a profound effect on both typesetting and printing processes. In terms of printing processes, the computer has begun to replace the photographic methods that were previously used to create printing plates. Initially, the computer would output to a film printer; the films would then be used to create printing plates. However, now with direct to plate technology, the computer creates the printing plates directly.

Computers have had an even greater effect on every aspect of typesetting. The advent of word processors and desktop publishing software have made it possible for most computer users to create documents that have many of the characteristics of typeset documents. Early word processors allowed a computer to create documents with the same output quality as that produced with a typewriter: all characters had the same width, and only one font was available. (The word processor did allow editing of content before the document was printed, which was a significant advance over the typewriter.) The complexity of word processors rapidly increased, and word processors implemented features such as variable width fonts, WYSIWYG (what you see is what you get), and printing to higher resolution output devices such as laser printers and inkjet printers. These features allowed users to create documents that looked quite similar to those that were professionally typeset; there are, however, many features of professionally typeset text that word processors cannot duplicate. Unfortunately, the limitations inherent in these programs has actually decreased the typesetting quality of much of the material that is printed today; the capabilities of computer programs to do typesetting are just beginning to approach the quality achievable by an expert typesetter.

The Boeing 777

The first powered airplane flight by the Wright Brothers in 1903 began a sequence of engineering and technical innovation that has led to today's modern commercial and military aircraft. Significant advances along this path include

- The development of reliable and powerful engines. Initially, these engines were gasoline powered piston engines; in the 1940s, jet engines were developed and have been since improved to create today's highly efficient turbofan engines.
- The development of new construction materials. Initially, airplanes were made of wood and fabric; the development of lightweight and strong metal alloys, and more recently the development of new composite materials, has allowed airplanes to become larger, carry larger payloads, and use fuel more efficiently.
- The development of electronic instrumentation and actuators. Instrumentation allows airplanes to navigate in almost any weather conditions; today's modern airliners include autopilots that control the plane and automatically navigate to a given destination.
- The development of a civil airline infrastructure. Airports, with their terminals that allow quick and efficient boarding of airplanes and handling of luggage, make commercial passenger air traffic possible.

The design and implementation of a modern jetliner is a huge engineering task, involving thousands of engineers in a global design and implementation effort. To illustrate modern engineering practice in the aerospace industry, we will consider the design of the Boeing 777.

On June 7, 1995, the first Boeing 777 to carry paying passengers took off from London's Heathrow airport. This milestone was the culmination of over six years of work and several billion dollars to develop and design the new airplane. Figure 30 shows a Boeing 777 landing.



FIGURE 6.30

A Boeing 777 landing at Heathrow airport.

The development of the Boeing 777 began in the mid-1980s. At this time, Boeing customers (major airlines such as United, American, Delta, British Airways, etc.) indicated that they had needs that were not met by Boeing's aircraft that were available at that time. Boeing considered modifying the design of the 767, but by 1989, it became apparent that this would not meet their customers' needs. Thus, they began the development of a new airplane—the 777.

The 777 is one of the most complex airplanes ever engineered. It has over 130,000 different parts that are manufactured by hundreds of companies around the world. The design of the 777 broke new ground in many ways: it

included significant customer involvement from the beginning, it used design build teams, CADD software was used extensively, and it included the implementation of Boeing's first fly-by-wire system for a commercial airplane.

Boeing included potential customers into their design process from the start. Representatives of major airlines provided Boeing with requirements early in the design process. These airline representatives also served on Boeing's design-build teams.

Boeing developed the concept of the design-build team for the 777. In airliner design efforts prior to the 777, engineers designed components; their designs were then passed on to manufacturing groups, who had the responsibility to implement the designs. This was often ineffective, because design engineers did not take manufacturing constraints into account in their designs. A design-build team included both design engineers and manufacturing engineers, so that manufacturing concerns were addressed in the design phase. The design-build teams also had members from major airlines; airline representatives could, for example, provide information on their maintenance practices to ensure that the plane could be serviced and repaired. The design-build teams included members from subcontracting companies who made sure that there was clear communication between Boeing design engineers and smaller companies that would be manufacturing many of the 777s components.

Another aspect of the 777 design process was the use of sophisticated CADD tools. Previous to the 777, as planes were designed, the design was verified with "mockups." A mockup is a physical prototype whose purpose is to ensure everything fits together properly. So, for example, wire bundles and hydraulic lines were fitted to the mockup, and then had to be adjusted again when the first plane was assembled.

In the 777 design process, on the other hand, a sophisticated CADD system was used; the use of this system eliminated the need for most of the mockups, and the first 777 aircraft assembled could actually be flown. This system included two components. The first was Computer Graphics Aided Three-D Interface Application (CATIA), which was used to design every part. The second was Electronic Pre-Assembly In the Computer (EPIC), which was used to ensure that each designed part would fit properly with all of the other parts in the aircraft; the software discovered where, for example, a particular structural component would interfere with hydraulic lines. The CAD system allowed engineers to communicate their designs with each other across design-build teams to make sure that designs, as they were developed, were compatible with each other.

Not only was computer technology essential for the design of the 777, it is essential for the 777 control system, which is computer-based. In previous Boeing airliner designs, the pilots' controls were connected by cables to hydraulic actuators that caused control surfaces to move. In contrast, in the 777 design, the pilots' control movements are input to a computer system which determines electrical signals to send over wires to actuators. This fly-by-wire system saves significant cost and weight, but requires sophisticated and reliable computer systems to control the plane in response to the pilots' inputs. The fly-by-wire system allows the 777 to be flown by a crew of only two (a pilot and a copilot); without the system, a much larger crew would be required. Figure 31 shows the cockpit of the Boeing 777. Development of the 777 fly-by-wire system required writing and debugging millions of lines of computer code.

The development of the 777 is another example of how advancing computer technology has dramatically changed the way engineers work. The use of CAD to capture designs and to simulate the structural and mechanical characteristics has dramatically reduced the time and expense associated with a design project. In addition, the use of computer networks to communicate design information has made it possible for engineers that are located in many different countries to collaborate on the same project.



FIGURE 6.31

The cockpit of the Boeing 777. Note that most flight information is displayed on several computer operated displays.

6.9 Potable Water (Possible Sidebar)

Potable water is water that is clean enough to drink safely. It does not contain harmful levels of chemical pollutants or microorganisms. Thanks to engineering efforts that began several thousand years ago, most residents of developed countries have access to safe, clean water. However, many residents of developing countries do not have such access, and struggle daily with sickness and other effects of bad water. Providing water to these people is a challenge to engineers and to the societies in which they work.

In this section, we trace some of the important historical engineering advances related to clean water in the context of their societies. We look at supplying water to large cities in the ancient Roman world, medieval and industrial Europe, and the modern western United States.

One common theme that runs through all of the engineering projects discussed in this section is that these projects were very large. Many stretched the technical capabilities of the civilizations that implemented them. Their implementation required not only good engineering, but also large commitments of funds by governments to pay large groups of laborers and provide significant amounts of material. Throughout history, the development of clean water supplies and sanitation systems has been primarily undertaken by governments and not by private individuals or corporations. Thus, the engineers that led these projects needed skills that extended far beyond the application of math and science; they needed to understand and be able to work with governments to obtain the resources for the projects, and they needed to understand the capabilities of the laborers who would work on the projects.

Rome

Many of the civilizations that preceded Rome developed important engineering techniques that were later adopted by the Romans. Jerusalem was one of the first large human settlements in which an engineered system supplied drinking water. Water from springs near the city was diverted through tunnels under the city to cisterns and underground reservoirs for storage. Neighboring civilizations, including those in present day Syria, Iraq, and Iran, used dams, aqueducts, tunnels, and qanats to supply water.

Initially, residents of Rome got drinking water from the Tiber River and local springs and wells. However, as Rome grew, some of these sources of water became polluted, and they did not provide enough water for the city. When Rome needed a reliable supply of water, Roman engineers could use these techniques that had been developed by earlier civilizations to supply water.

The Romans built aqueducts to move water from its source in springs or rivers to Rome. We are familiar with the arched bridges used to carry aqueducts across valleys; the aqueduct shown in Figure 2 is one such bridge. Perhaps less well known is that the Roman engineers avoided building these bridges whenever possible, preferring instead to use channels in the ground or tunnels to transport the water.

The earliest aqueduct supplying Rome was the Appis, built in 312 BC. Eventually, by about AD 100, twelve aqueducts supplied water to the over one million people who lived in Rome; the aqueducts had a total length of about 300 miles, with only 40 miles on arched bridges. In addition to Rome, most other large Roman cities were supplied with potable water.

Similar to many engineering projects, the Roman engineers who planned and built the Roman water system did not invent all of the techniques they used, but did make improvements in these techniques. For example, the Romans developed a water-resistant cement that was used to line aqueducts. The Romans also developed the idea of storing potable water in reservoirs close to the water's source, as opposed to reservoirs in the city.

Much of what we know about the Roman water system comes from the writings of Sextus Julius Frontinus (about

40–103), who was the Roman water commissioner about AD 100. He was clearly proud of the Roman water system and the engineering that had implemented it. He wrote “with such an array of indispensable structures carrying so many waters, compare if you will, the idle Pyramids or the useless, though famous works of the Greek.”

In addition to a supply of potable water, Rome had a sewer system. In this system, water from the aqueducts along with water from streams and springs flushed human waste and other undesirable substances through the sewers into the Tiber River. Unlike a modern sewage system, the waste was untreated and polluted the river. Only the wealthiest private houses were connected to the system. For those without indoor plumbing, public latrines were available for a small price. However, many people would empty chamber pots from upper story windows on to the street.

London

With the decline of the Roman Empire, many of the advances in supplying potable water and in dealing with wastes were lost, particularly in northern and western Europe.

London is located on the banks of the Thames River. In the thirteenth century, it had a population of about 40,000. By the seventeenth century, this population had grown to over one-half million. As in Rome, Londoners initially relied on water from the river Thames and springs and wells, but as the city grew, these resources became polluted and did not sustain the population.

Many engineering projects were developed to increase the water supply. In the mid-thirteenth century, the “Great Conduit” was the first of twelve conduit systems to be built. In these systems, water from a spring was stored in a large nearby cistern. This cistern was connected by a pipe to another cistern up to a mile away; this second cistern had spigots to dispense the water. From 1609 to 1613, the New River, a canal of almost 60 km, was built by Sir Hugh Myddleton (1560–1631). This canal is still an important source of water for London today.

As in Rome, the disposal of human and animal waste was also an issue in London throughout its history. Impure drinking water and poor sanitation were primary causes of the devastating plague epidemics that swept through Europe, including London, from the mid-fourteenth to the mid-seventeenth centuries. In spite of repeated efforts by the government, the Thames River was polluted by the sewage and other refuse that flowed into it.

In the mid-1840s, London’s Metropolitan Commission of Sewers ordered that cesspits should be closed and that house drains should be connected to the sewer system that drained into the Thames. The increased pollution led to cholera outbreaks in 1848 and 1849. Figure 32 shows a caricature of commentary offered by Michael Faraday (1791–1867), a influential British scientist, on the state of the river in 1855. The summer of 1858 was unusually hot, and the Thames River, as well as many of the streams that flow through London into it, were extremely polluted with sewage. The resulting smell was so bad that it threatened to shut down the operation of the British government. This episode was labeled the “Great Stink.”

The Great Stink was so bad that the Metropolitan Board of Works (which replaced the Metropolitan Commission of Sewers) authorized its chief engineer, Joseph Bazalgette (1819–1891), to redesign and rebuild the London sewer system. His design used 83 miles of brick-lined sewer tunnels to move the sewage downstream of London where it was released untreated into the Thames. The capacity of the sewer system was large enough that it is still in use today. The London sewer system was a massive public works program.

The Western United States

Much of the western United States is arid or semiarid land. Many of the West’s major metropolitan centers can sustain their current populations only because of large water conservation projects. Water conservation projects include dams to store water and canals to distribute this water.



FIGURE 6.32

A caricature of commentary on the state of the River Thames offered by Michael Faraday in 1855.

Most of these large water conservation projects in the West were built in the first half of the twentieth century. Construction of these projects was a significant feat of engineering. They all involved large budgets, large work forces, and made use of the most advanced technology of their time. Three of these projects are the Salt River project in Arizona, the Los Angeles aqueduct in California, and Hoover dam on the Colorado River (on the Nevada/Arizona border). We briefly describe these three projects.

The Salt River Project

The Salt River Project was begun in 1904 with the start of construction on Theodore Roosevelt Dam. The Salt River flows from the mountains in eastern Arizona, through the Phoenix metropolitan area, then joins the Gila River on the way to the Colorado River. The Salt River is subject to both floods and droughts. Farmers whose crops were watered by the river needed a more reliable supply of water. So they created the Salt River Valley Water Users Association in 1903. The first major engineering project was the construction of the Theodore Roosevelt Dam shown in a photograph from 1915 in Figure 33. Begun in 1904 and completed in 1911, this dam was the highest masonry dam in the world at the time of its completion. It was 280 feet tall and stored 1.65 million acre feet (537 billion

gallons) of water in the Theodore Roosevelt Lake (the reservoir created by the dam). Figure 34 is a photograph of the dam's dedication by Theodore Roosevelt, who was president of the United States at the time of its completion.



FIGURE 6.33

The Theodore Roosevelt Dam in 1915.



FIGURE 6.34

President Theodore Roosevelt speaking at the dam that bears his name.

Three more dams (Horse Mesa, Mormon Flat, and Stewart Mountain) were added on the Salt River below Theodore Roosevelt Dam between 1923 and 1930. Water stored by these dams is released into the Salt River when needed, and flows downstream to the Granite Reef diversion dam where it is channeled into canals that distribute the water throughout the Phoenix metropolitan area. The original purpose of the Salt River Project was to supply water for agriculture. Since the 1960s, this water has also made the rapid population growth of the Phoenix metropolitan area possible; the Phoenix metropolitan area has grown to more than 4 million people.

The Los Angeles Aqueduct

The Los Angeles aqueduct supplies the Los Angeles metropolitan area with water. The aqueduct transports water from the Owens River in Central California to Los Angeles. It was constructed from 1908 to 1913 by about 5000 workers at a cost of \$23 million.

The engineer primarily responsible for the design and construction of the aqueduct was William Mulholland (1855–1935). An Irish immigrant born in 1855, he arrived in Los Angeles in 1877 and began work as a ditch maintainer. He had little formal education, but was mostly self-taught from mathematics and engineering textbooks. He eventually became the head of the Los Angeles Department of Water and Power, and it was in this position that he planned and built the aqueduct. His career as an engineer was abruptly ended in 1928, when the St. Francis Dam that he had designed and whose construction he had supervised collapsed, and the resulting flood killed almost 500 people.

The aqueduct was a significant engineering accomplishment at the time of its construction. It transports water for 226 miles. It has 142 tunnels whose total length is 43 miles; the longest tunnel is the Elizabeth, which is five miles long. The aqueduct uses siphons to cross several large valleys. The entry of the aqueduct into Los Angeles is by the cascades shown in Figure 35.



FIGURE 6.35

After flowing through the aqueduct, water enters Los Angeles through these cascades.

The Los Angeles aqueduct made the rapid growth of the Los Angeles area possible, particularly during the first half of the twentieth century. This came at a severe environmental cost: the Owens River Valley was changed into a desert. Owens Lake, originally fed by the Owens River, dried into an alkali salt flat, and dust from this flat today is an environmental hazard. Birds once used Owens Lake as a resting area while migrating; they no longer do so. As a result of a lawsuit settled in 2003, the Los Angeles Department of Water and Power (which operates the Los Angeles aqueduct) was required to start allowing some water to flow in the Owens River.

Hoover Dam

The Colorado River flows for 1440 miles from its source in the Rocky Mountains to the Gulf of California in the Pacific Ocean, and drains an area of 244,000 square miles. It has an average annual flow of 17.5 million acre feet; this flow varies tremendously from much lower in drought years to much higher in flood years. The Colorado River basin includes portions of seven states: Arizona, Colorado, California, Nevada, New Mexico, Utah, and Wyoming. The Colorado River supplies water to more than 24 million people living in communities inside and outside of its basin, including Los Angeles, Phoenix, Albuquerque, Las Vegas, Salt Lake City, Denver, and San Diego. It also provides irrigation water to about 2 million acres of land.

The Colorado River is one of the most regulated water sources in the United States, and each state's share of water is determined by several federal laws. To provide this water, a system of dams and canals have been developed on the Colorado River and its tributaries. Hoover Dam was the first of these dams and one of the largest engineering projects in the United States.

Hoover Dam (originally called Boulder Canyon Dam) was constructed between 1931 and 1935. The dam and Lake Mead (the reservoir behind the dam) are shown in Figure 36. At the time of its construction, it was the largest concrete structure in the world. It is 726 feet tall, and was the tallest dam in the world when constructed. The hydroelectric power plant at the base of the dam generates electric power; it was the largest hydroelectric power plant in the world from 1939 to 1949.



FIGURE 6.36

An aerial photograph of Hoover Dam.

Figure 37 shows a plan of the dam and the surrounding canyon. It shows several of the techniques that were necessary to build the dam at the bottom of a deep canyon. Before construction could begin on the dam, the Colorado River was diverted away from the construction site. The river was diverted through four tunnels cut into the canyon walls. The tunnels were 56 feet in diameter with concrete linings that were three feet thick. After the tunnels were finished, two cofferdams were built, one upstream of the dam site and one downstream of the dam site. These diverted the river through the tunnels, leaving the dam site dry for construction.

At the time of its construction, the dam was the largest concrete structure that had been built. This presented several challenges in the construction. One was moving the wet concrete to the proper location as the dam was built. Another was cooling the concrete as it hardened (concrete gives off heat as it sets, and if it becomes too hot, will not

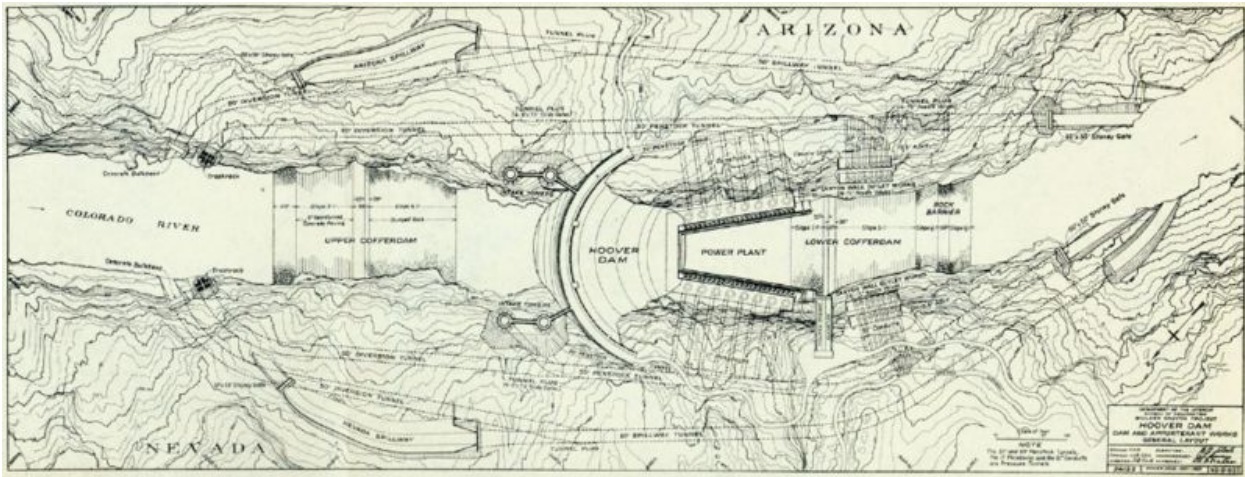

FIGURE 6.37

A contour map of Hoover Dam and the surrounding canyon.

set properly).

Frank Crowe (1882–1946) was the engineer who directed the construction of the dam. He invented the techniques that were used to solve many of the construction problems. Born in 1882, he attended the University of Maine from 1891 to 1895, studying Civil Engineering. In 1905, he began work at the US Reclamation Service, and worked in dam construction for the next 20 years; it was in this period that he began to develop the construction techniques that would make it possible to construct Hoover Dam. In addition to his technical expertise, he was talented at getting along with different people on different levels. According to one co-worker, “One thing he knew was men.”

As with all developments of such magnitude, there are also issues associated with the dam. One is that Lake Mead is slowly filling up with sediment. The Colorado River carries a huge amount of rocks, sand, and silt that has been eroded from the land that it drains. As the river flow slows on entering Lake Mead, this sediment settles out of the water. Recent studies show that it is now between 30 meters and 70 meters deep. At the current rate of sedimentation, enough sediment will accumulate to fill Lake Mead entirely within the next few hundred years unless a method is devised to solve the sedimentation problem.

6.10 Conclusions

Throughout history, engineers have solved problems and have figured out how to make things work. As mathematical and scientific knowledge has increased, particularly within the last 150 years, engineers have increasingly been required to apply principles from math and science in the course of their work. In much design and development work today, advanced understanding of a broad array of scientific disciplines is required, as is the ability to use sophisticated and complicated computer analysis and modeling tools.

As engineered systems have become more complex, teams of engineers have grown to deal with this complexity. Many advances in the Industrial Revolution were made by individuals or small groups; on the other hand, the creation of a modern jetliner now requires the efforts of thousands of people around the globe.

Engineering advances have dramatically affected society, and will continue to do so. Technological advances provide opportunities to improve society as well as risks. Engineers today and in the future must work within the context of global societies to see that engineering progress does not lead to negative consequences.

6.11 Vocabulary

Aqueduct

A man-made channel for carrying water.

Assembly line

A system for assembling identical objects using a sequence of processes.

CADD

CADD stands for computer-aided design and drafting. It is the practice of using computer software to represent the geometry of designed objects.

Cathedral

A large church building. A Cathedral is usually associated with a bishop.

Cesspi

A pit or tank in the ground for the storage of human waste and other sewage.

Chronometer

A device for measuring time.

Cistern

A tank for holding water or other liquid.

Corporation

A group of people authorized by law to act as a single entity, usually for the purpose of making money.

Cottage Industry

A manufacturing activity carried on in one's home.

Drainage basin

The region drained by a river or stream. Precipitation falling into the drainage basin of a river will end up in the river if it does not evaporate or seep into the ground.

Dynamo

A machine that converts rotational energy such as that generated by a water wheel or a steam engine into electrical energy.

Electromagnetic waves

Waves such as light or radio waves that propagate through the interaction of electric and magnetic fields.

Factory

A building where things are manufactured.

Fly-by-wire

An aircraft control system in which the setting of control surfaces (e.g., the rudder, ailerons, and so on) is controlled by electrical signals.

Flying buttress

A structure that transfers the weight loads from roofs and upper stories to the ground in Gothic architecture.

Integrated circuit

An electronic circuit of transistors etched onto a small piece of silicon which is sometimes referred to as a microchip.

Interchangeable parts

Parts that are manufactured to a particular specification so that any one of a given part can be used in a machine or assembly.

Internal combustion engine

An engine that generates power by burning a fuel inside the engine.

Locomotive

An engine for pulling trains.

Longitude

The distance east or west of the prime meridian, an imaginary north-south line that passes through Greenwich, England. It is measured in degrees.

Mainframe computer

A large high-speed computer that typically supports many users at once.

Mason

A stone worker.

Microprocessor

An integrated circuit that implements a computer processor that can store and manipulate data to perform a wide variety of useful functions.

Minicomputer

A computer that supports many users at once and whose computing capacity is lower than a mainframe. Minicomputers have largely been supplanted by powerful personal computers.

Morse code

A code in which letters of the alphabet are represented by patterns of long and short bursts of sound.

Patent

The exclusive rights granted by a government to an inventor to manufacture, use, or sell an invention for a certain number of years.

Perspective

A way of drawing solid objects so that their height and depth are apparent.

Piston

a disk or solid cylinder that moves up and down in a larger hollow cylinder.

Potable

Potable water is water that is clean enough to drink.

Printing press

A machine for printing newspapers and books.

Qanat

An irrigation tunnel through which water flows from an aquifer (ground water) to a village or town.

Reservoir

A body of water, usually formed behind a dam.

Rule of thumb

A general principle that may not be accurate for every situation to which it is applied.

Semiconductor

A substance that conducts electricity better than an insulator but not as well as a conductor. Silicon is a semiconductor used to make microchips.

Siphon

A pipe used to convey water through an area that is higher or lower than the beginning and end of the siphon.

Trade organization

An organization formed to promote the economic interests of a group of people.

Transcontinental

Stretching across the continent.

Transistor

An electrical component made from silicon or other semiconductors that can be used to build computers, radios, and other useful electronic devices.

Typesetting

The process of arranging letters prior to printing.

Vacuum tube

An electrical component that was used to create amplifiers and other useful electrical circuits. A vacuum tube contains metal components inside a glass tube that is sealed to exclude air or other gasses from the tube.

6.12 References

- Dava Sobel. *Longitude: The True Story of a Lone Genius Who Solved the Greatest Scientific Problem of His Time*. Penguin, 1996.
- David Bjerklie. “The Art of Renaissance Engineering.” Downloaded July 2004. Available on the web at <http://www.technologyreview.com/Biztech/11629/>
- Eugene S. Ferguson. *Engineering and the Mind’s Eye*. The MIT Press, 1994.
- Gary Cross and Rick Szostak. *Technology and American Society*. Pearson-Prentice Hall, 2005.
- Joseph Gies and Frances Gies. *Cathedral, Forge and Waterwheel: Technology and Invention in the Middle Ages*. Harper Perennial, 1995.
- National Academy of Engineering. *A Century of Innovation: Twenty Engineering Achievements that Transformed Our Lives*. Joseph Henry Press, 2003.
- Richard Shelton Kirby, Sidney Withington, Arthur Burr Darling, and Frederick Gridley Kilgour. *Engineering in History*. McGraw-Hill, 1956.
- Sunny Y. Auyang. *Engineering—An Endless Frontier*. Harvard University Press, 2004.
- T. K. Derry and Trevor I. Williams. *A Short History of Technology: From the Earliest Times to A.D. 1900*. Oxford University Press, 1961.

6.13 Instructor Supplemental Resources

Standards

ASEE Draft Engineering Standards. This chapter is focused on “Dimension 3: The Nature of Engineering” and “Dimension 5: Engineering and Society” of the ASEE Corporate Members Council Draft Engineering Standards; these draft standards will serve as input to the National Academy of Engineering process of considering engineering standards for K-12 education. These dimensions include the following outcomes:

- Students will develop an understanding of the characteristics and broad scope of engineering.
- Students will be able to be creative and innovative in their thought process and actions.
- Students will develop an understanding that engineering is an ethical human endeavor that addresses the needs of a global society.
- Students will be able to investigate and analyze the impact of engineering on a global society.

Common Preconceptions

Engineering and Engineers

Students have little to no knowledge about what engineers do or to the range of engineering careers open to them. They rarely know anyone who is an engineer unless that person is a relative. Perceptions of what engineers do are limited to planning, designing, building, fixing, and repairing things. Engineers are also perceived as male and never female. Engineers who work with computers are viewed as hackers. All engineers are viewed as lacking social qualities.

Technology

Students also have preconceptions of technology. They see technology as limited primarily to computers and related to electronic devices. They do not see such simple artifacts as zippers or forks as technological innovations that were groundbreaking in their time. Nor, do they see the built world as filled with engineering innovations that have served the needs of society.

Addressing the Needs of a Global Society

Among female students in particular, the strongest preconception is that engineering does not meet the needs of society and as a consequence students do not choose engineering careers. This naïve conception is strongly linked to the lack of knowledge about what engineers do and the range of engineering careers available to them. Furthermore, since conceptions of engineering are limited to building, fixing, and repairing things, as well as designing and planning, students’ views of engineering and its reach is local rather than global. Female students are also more likely than males to describe the products of engineering as having just as many negative impacts on society such as bombs, as positive impacts.

Investigate and Analyze the Impact of Engineering on a Global Society

Most people in the United States do not recognize the role of engineers in developing new forms of energy or drugs or even working in space. These activities are seen as the work of scientists. Furthermore, they do not understand that engineers work with scientists to create new technologies. In a survey of the International Technology Education Association, when students look at large-scale problems such as those relating to the environment, they tend to focus their analysis on the scientific aspects of such problems and ignore the ethical, economic, legal, and social components. A narrow focus in analyzing problems that impact a global society, attributing the work of engineers to scientists and misunderstanding the role of technology must first be addressed before students can investigate and analyze the impact of engineering on a global society.

6.14 References

1. . [The Egyptian pyramids at Giza.](#) CC-BY-SA 2.0 Generic
2. . http://www.flickr.com/photos/roberto_ferrari/2043593699/. CC-BY-SA 2.0 Generic
3. . [The west facade of the cathedral of Notre Dame de Paris.](#) CC-BY-SA 2.0 Generic
4. . [Flying buttresses on the cathedral of Notre Dame de Paris.](#) CC-BY 2.0 Generic
5. . http://en.wikipedia.org/wiki/Image:Caravel_Boa_Esperanca_Portugal.jpg. CC-BY-SA 2.0 Generic
6. . http://en.wikipedia.org/wiki/Image:Eertvelt_Santa_Maria.jpg. Public domain
7. . [Type blocks arranged into rows.](#) CC-BY 2.0 Generic
8. . [A Gutenberg bible.](#) CC-BY-SA 2.0 Generic
9. . <http://www.flickr.com/photos/aarongustafson/2336396744/>. CC-BY-SA 2.0 Generic
10. . http://commons.wikimedia.org/wiki/Image:Leonardo_crossbow.JPG. Public Domain
11. . http://en.wikipedia.org/wiki/Image:Harrison%27s_Chronometer_H5.JPG. CC-BY 2.5 Generic
12. . http://commons.wikimedia.org/wiki/Image:Newcomens_Dampfmaschine_aus_Meyers_1890.png. Public Domain
13. . http://commons.wikimedia.org/wiki/Image:Cotton_gin_EWM_2007.jpg. Public Domain
14. . [Steam press invented by Friedrich Koenig in 1814.](#) Public domain
15. . [Rotary printing press invented by Richard Hoe.](#) Public domain
16. . http://commons.wikimedia.org/wiki/Image:Robert_E_Lee_Steamboat.jpg. Public Domain
17. . [Drawing of the locomotive Rocket.](#) Public Domain
18. . [Thomas Edison and an early phonograph.](#) Public Domain
19. . [An original bulb made by Edison's workshop in 1879.](#) CC-BY 2.0
20. . [The Wright brothers' first powered flight.](#) Public Domain
21. . [A keyboard for the Monotype casting system.](#) CC-BY-SA 2.0 Generic
22. . [A Linotype type-casting system.](#) CC-BY
23. . [A restored Ford Model T.](#) CC-BY 2.0 Generic
24. . [Part of a Ford assembly line.](#) Public Domain
25. . http://commons.wikimedia.org/wiki/Image:Radio_receiver_06.jpg. CC-BY 2.5 Generic
26. . <http://en.wikipedia.org/wiki/Image:UNIVAC-I-BRL61-0977.jpg>. Public Domain
27. . <http://commons.wikimedia.org/wiki/Image:PDP-12-Update-Uppsala.jpeg>. Public Domain
28. . [A Zilog Z80 microprocessor manufactured in 1976.](#) CC-BY 2.5 Generic
29. . [An Apple II computer manufactured about 1980.](#) CC-BY 2.0 Generic
30. . [A Boeing 777 landing at Heathrow airport.](#) Public Domain
31. . http://en.wikipedia.org/wiki/Image:Boeing_777_Cockpit.jpg. CC-BY-SA 2.0 Generic
32. . <http://commons.wikimedia.org/wiki/Image:FaradayFatherThames.jpg>. Public domain
33. . [The Theodore Roosevelt Dam in 1915.](#) Public Domain
34. . http://en.wikipedia.org/wiki/Image:Roosevelt_speaking_at_Roosevelt_Dam.jpg. Public Domain
35. . http://en.wikipedia.org/wiki/Image:LA_Aqueduct_Cascades.jpg. CC-BY-SA 2.0 Generic
36. . [An aerial photograph of Hoover Dam.](#) CC-BY-SA 2.0 Generic
37. . <http://en.wikipedia.org/wiki/Image:Hoover-dam-contour-map.jpg>. Public Domain