

PROFESSIONAL C++

INTRODUCTION	xlvii
▶ PART I INTRODUCTION TO PROFESSIONAL C++	
CHAPTER 1 A Crash Course in C++ and the Standard Library	3
CHAPTER 2 Working with Strings and String Views	57
CHAPTER 3 Coding with Style	71
▶ PART II PROFESSIONAL C++ SOFTWARE DESIGN	
CHAPTER 4 Designing Professional C++ Programs	95
CHAPTER 5 Designing with Objects	123
CHAPTER 6 Designing for Reuse	143
▶ PART III C++ CODING THE PROFESSIONAL WAY	
CHAPTER 7 Memory Management	163
CHAPTER 8 Gaining Proficiency with Classes and Objects	199
CHAPTER 9 Mastering Classes and Objects	231
CHAPTER 10 Discovering Inheritance Techniques	277
CHAPTER 11 C++ Quirks, Oddities, and Incidentals	333
CHAPTER 12 Writing Generic Code with Templates	373
CHAPTER 13 Demystifying C++ I/O	409
CHAPTER 14 Handling Errors	433
CHAPTER 15 Overloading C++ Operators	473
CHAPTER 16 Overview of the C++ Standard Library	507
CHAPTER 17 Understanding Containers and Iterators	535
CHAPTER 18 Mastering Standard Library Algorithms	607
CHAPTER 19 String Localization and Regular Expressions	663
CHAPTER 20 Additional Library Utilities	691

Continues

▶ PART IV	MASTERING ADVANCED FEATURES OF C++	
CHAPTER 21	Customizing and Extending the Standard Library	727
CHAPTER 22	Advanced Templates	775
CHAPTER 23	Multithreaded Programming with C++.	813
▶ PART V	C++ SOFTWARE ENGINEERING	
CHAPTER 24	Maximizing Software Engineering Methods.	859
CHAPTER 25	Writing Efficient C++	881
CHAPTER 26	Becoming Adept at Testing.	909
CHAPTER 27	Conquering Debugging.	933
CHAPTER 28	Incorporating Design Techniques and Frameworks.	971
CHAPTER 29	Applying Design Patterns	991
CHAPTER 30	Developing Cross-Platform and Cross-Language Applications	1017
APPENDIX A	C++ Interviews.	1039
APPENDIX B	Annotated Bibliography	1063
APPENDIX C	Standard Library Header Files.	1075
APPENDIX D	Introduction to UML	1083
INDEX		1087

PROFESSIONAL

C++

PROFESSIONAL
C++

Fourth Edition

Marc Gregoire



Professional C++, Fourth Edition

Published by
John Wiley & Sons, Inc.
10475 Crosspoint Boulevard
Indianapolis, IN 46256
www.wiley.com

Copyright © 2018 by John Wiley & Sons, Inc., Indianapolis, Indiana

Published simultaneously in Canada

ISBN: 978-1-119-42130-6
ISBN: 978-1-119-42126-9 (ebk)
ISBN: 978-1-119-42122-1 (ebk)

Manufactured in the United States of America

10 9 8 7 6 5 4 3 2 1

No part of this publication may be reproduced, stored in a retrieval system or transmitted in any form or by any means, electronic, mechanical, photocopying, recording, scanning or otherwise, except as permitted under Sections 107 or 108 of the 1976 United States Copyright Act, without either the prior written permission of the Publisher, or authorization through payment of the appropriate per-copy fee to the Copyright Clearance Center, 222 Rosewood Drive, Danvers, MA 01923, (978) 750-8400, fax (978) 646-8600. Requests to the Publisher for permission should be addressed to the Permissions Department, John Wiley & Sons, Inc., 111 River Street, Hoboken, NJ 07030, (201) 748-6011, fax (201) 748-6008, or online at <http://www.wiley.com/go/permissions>.

Limit of Liability/Disclaimer of Warranty: The publisher and the author make no representations or warranties with respect to the accuracy or completeness of the contents of this work and specifically disclaim all warranties, including without limitation warranties of fitness for a particular purpose. No warranty may be created or extended by sales or promotional materials. The advice and strategies contained herein may not be suitable for every situation. This work is sold with the understanding that the publisher is not engaged in rendering legal, accounting, or other professional services. If professional assistance is required, the services of a competent professional person should be sought. Neither the publisher nor the author shall be liable for damages arising herefrom. The fact that an organization or Web site is referred to in this work as a citation and/or a potential source of further information does not mean that the author or the publisher endorses the information the organization or Web site may provide or recommendations it may make. Further, readers should be aware that Internet Web sites listed in this work may have changed or disappeared between when this work was written and when it is read.

For general information on our other products and services please contact our Customer Care Department within the United States at (877) 762-2974, outside the United States at (317) 572-3993 or fax (317) 572-4002.

Wiley publishes in a variety of print and electronic formats and by print-on-demand. Some material included with standard print versions of this book may not be included in e-books or in print-on-demand. If this book refers to media such as a CD or DVD that is not included in the version you purchased, you may download this material at <http://booksupport.wiley.com>. For more information about Wiley products, visit www.wiley.com.

Library of Congress Control Number: 2017963243

Trademarks: Wiley, the Wiley logo, Wrox, the Wrox logo, Programmer to Programmer, and related trade dress are trademarks or registered trademarks of John Wiley & Sons, Inc. and/or its affiliates, in the United States and other countries, and may not be used without written permission. All other trademarks are the property of their respective owners. John Wiley & Sons, Inc., is not associated with any product or vendor mentioned in this book.

*Dedicated to my parents and my brother, who are
always there for me. Their support and patience
helped me in finishing this book.*

ABOUT THE AUTHOR

MARC GREGOIRE is a software architect from Belgium. He graduated from the University of Leuven, Belgium, with a degree in “Burgerlijk ingenieur in de computer wetenschappen” (equivalent to master of science in engineering: computer science). The year after, he received an advanced master’s degree in artificial intelligence, cum laude, at the same university. After his studies, Marc started working for a software consultancy company called Ordina Belgium. As a consultant, he worked for Siemens and Nokia Siemens Networks on critical 2G and 3G software running on Solaris for telecom operators. This required working with international teams stretching from South America and the United States to Europe, the Middle East, Africa, and Asia. Now, Marc is a software architect at Nikon Metrology (www.nikonmetrology.com), a division of Nikon and a leading provider of precision optical instruments and metrology solutions for 3D geometric inspection.

His main expertise is in C/C++, and specifically Microsoft VC++ and the MFC framework. He has experience in developing C++ programs running 24/7 on Windows and Linux platforms: for example, KNX/EIB home automation software. In addition to C/C++, Marc also likes C# and uses PHP for creating web pages.

Since April 2007, he has received the annual Microsoft MVP (Most Valuable Professional) award for his Visual C++ expertise.

Marc is the founder of the Belgian C++ Users Group (www.becpp.org), co-author of C++ *Standard Library Quick Reference* (Apress), technical editor for numerous books for several publishers, and a member on the CodeGuru forum (as Marc G). He maintains a blog at www.nuonsoft.com/blog/, and is passionate about traveling and gastronomic restaurants.

ABOUT THE TECHNICAL EDITOR

PETER VAN WEERT is a Belgian software engineer, whose main interests and expertise are in C++, programming languages, algorithms, and data structures.

He received his master of science in computer science from the University of Leuven, Belgium, *summa cum laude*, with congratulations of the Board of Examiners. In 2010, the same university awarded him a PhD for his research on the efficient compilation of rule-based programming languages (mainly Java). During his doctoral studies, he was a teaching assistant for courses on object-oriented analysis and design, Java programming, and declarative programming languages.

After his studies, Peter worked for Nikon Metrology on large-scale, industrial-application software in the area of 3D laser scanning and point cloud inspection. In 2017, he joined the software R&D unit of Nobel Biocare, which specializes in digital dentistry software. Throughout his professional career, Peter has mastered C++ software development, as well as the management, refactoring, and debugging of very large code bases. He also gained further proficiency in all aspects of the software development process, including the analysis of functional and technical requirements, and Agile- and Scrum-based project and team management.

Peter is a regular speaker at, and board member of, the Belgian C++ Users Group. He also co-authored two books: *C++ Standard Library Quick Reference* and *Beginning C++ (5th edition)*, both published by Apress.

CREDITS

PROJECT EDITOR
Adaobi Obi Tulton

TECHNICAL EDITOR
Peter Van Weert

PRODUCTION EDITOR
Athiyappan Lalith Kumar

COPY EDITOR
Marylouise Wiack

**MANAGER OF CONTENT DEVELOPMENT
AND ASSEMBLY**
Mary Beth Wakefield

PRODUCTION MANAGER
Kathleen Wisor

MARKETING MANAGER
Christie Hilbrich

EXECUTIVE EDITOR
Jim Minatel

PROJECT COORDINATOR, COVER
Brent Savage

PROOFREADER
Nancy Bell

INDEXER
Johnna VanHoose Dinse

COVER DESIGNER
Wiley

COVER IMAGE
© ittipon/Shutterstock

ACKNOWLEDGMENTS

I THANK THE JOHN WILEY & SONS AND WROX Press editorial and production teams for their support. Especially, thank you to Jim Minatel, executive editor at Wiley, for giving me a chance to write this new edition, Adaobi Obi Tulton, project editor, for managing this project, and Marylouise Wiack, copy editor, for improving readability and consistency and making sure the text is grammatically correct.

A very special thank you to my technical editor, Peter Van Weert, for his outstanding technical review. His many constructive comments and ideas have certainly made this book better.

Of course, the support and patience of my parents and my brother were very important in finishing this book. I would also like to express my sincere gratitude toward my employer, Nikon Metrology, for supporting me during this project.

Finally, I thank you, the reader, for trying this approach to professional C++ software development.

CONTENTS

INTRODUCTION

xlvii

PART I: INTRODUCTION TO PROFESSIONAL C++

CHAPTER 1: A CRASH COURSE IN C++ AND THE STANDARD LIBRARY	3
The Basics of C++	4
The Obligatory Hello, World	4
Comments	4
Preprocessor Directives	5
The main() Function	6
I/O Streams	7
Namespaces	8
Literals	10
Variables	10
Operators	13
Types	15
Enumerated Types	15
Structs	16
Conditional Statements	17
if/else Statements	17
switch Statements	18
The Conditional Operator	20
Logical Evaluation Operators	20
Functions	21
Function Return Type Deduction	22
Current Function's Name	23
C-Style Arrays	23
std::array	25
std::vector	25
Structured Bindings	26
Loops	26
The while Loop	26
The do/while Loop	27
The for Loop	27

The Range-Based for Loop	27
Initializer Lists	28
Those Are the Basics	28
Diving Deeper into C++	28
Strings in C++	29
Pointers and Dynamic Memory	29
The Stack and the Heap	29
Working with Pointers	30
Dynamically Allocated Arrays	31
Null Pointer Constant	32
Smart Pointers	33
The Many Uses of const	35
const Constants	35
const to Protect Parameters	35
References	35
Pass By Reference	36
Pass By const Reference	37
Exceptions	37
Type Inference	38
The auto Keyword	39
The decltype Keyword	40
C++ as an Object-Oriented Language	40
Defining Classes	40
Using Classes	43
Uniform Initialization	43
Direct List Initialization versus Copy List Initialization	45
The Standard Library	46
Your First Useful C++ Program	46
An Employee Records System	46
The Employee Class	47
Employee.h	47
Employee.cpp	48
EmployeeTest.cpp	50
The Database Class	50
Database.h	50
Database.cpp	51
DatabaseTest.cpp	52
The User Interface	53
Evaluating the Program	55
Summary	56

CHAPTER 2: WORKING WITH STRINGS AND STRING VIEWS	57
Dynamic Strings	58
C-Style Strings	58
String Literals	60
Raw String Literals	60
The C++ <code>std::string</code> Class	62
What Is Wrong with C-Style Strings?	62
Using the <code>string</code> Class	62
<code>std::string</code> Literals	64
High-Level Numeric Conversions	64
Low-Level Numeric Conversions	65
The <code>std::string_view</code> Class	67
<code>std::string_view</code> Literals	69
Nonstandard Strings	69
Summary	69
CHAPTER 3: CODING WITH STYLE	71
The Importance of Looking Good	71
Thinking Ahead	72
Elements of Good Style	72
Documenting Your Code	72
Reasons to Write Comments	72
Commenting to Explain Usage	72
Commenting to Explain Complicated Code	74
Commenting to Convey Meta-information	75
Commenting Styles	77
Commenting Every Line	77
Prefix Comments	78
Fixed-Format Comments	79
Ad Hoc Comments	80
Self-Documenting Code	81
Decomposition	81
Decomposition through Refactoring	82
Decomposition by Design	83
Decomposition in This Book	83
Naming	83
Choosing a Good Name	83
Naming Conventions	84
Counters	84
Prefixes	84

Hungarian Notation	85
Getters and Setters	86
Capitalization	86
Namespaced Constants	86
Using Language Features with Style	86
Use Constants	87
Use References Instead of Pointers	87
Use Custom Exceptions	88
Formatting	88
The Curly Brace Alignment Debate	88
Coming to Blows over Spaces and Parentheses	89
Spaces and Tabs	90
Stylistic Challenges	90
Summary	91

PART II: PROFESSIONAL C++ SOFTWARE DESIGN

CHAPTER 4: DESIGNING PROFESSIONAL C++ PROGRAMS	95
What Is Programming Design?	96
The Importance of Programming Design	97
Designing for C++	99
Two Rules for C++ Design	100
Abstraction	100
Benefiting from Abstraction	100
Incorporating Abstraction in Your Design	101
Reuse	101
Writing Reusable Code	102
Reusing Designs	103
Reusing Existing Code	103
A Note on Terminology	104
Deciding Whether or Not to Reuse Code	105
Advantages to Reusing Code	105
Disadvantages to Reusing Code	105
Putting It Together to Make a Decision	106
Strategies for Reusing Code	107
Understand the Capabilities and Limitations	107
Understand the Performance	108
Understand Platform Limitations	110
Understand Licensing and Support	110
Know Where to Find Help	111
Prototype	111

Bundling Third-Party Applications	112
Open-Source Libraries	112
The Open-Source Movements	112
Finding and Using Open-Source Libraries	113
Guidelines for Using Open-Source Code	113
The C++ Standard Library	114
C Standard Library	114
Deciding Whether or Not to Use the Standard Library	114
Designing a Chess Program	114
Requirements	115
Design Steps	115
Divide the Program into Subsystems	115
Choose Threading Models	117
Specify Class Hierarchies for Each Subsystem	118
Specify Classes, Data Structures, Algorithms, and Patterns for Each Subsystem	118
Specify Error Handling for Each Subsystem	120
Summary	121
CHAPTER 5: DESIGNING WITH OBJECTS	123
Am I Thinking Procedurally?	124
The Object-Oriented Philosophy	124
Classes	124
Components	125
Properties	125
Behaviors	126
Bringing It All Together	126
Living in a World of Objects	127
Over-Objectification	127
Overly General Objects	128
Object Relationships	129
The Has-A Relationship	129
The Is-A Relationship (Inheritance)	130
Inheritance Techniques	130
Polymorphism versus Code Reuse	131
The Fine Line between Has-A and Is-A	132
The Not-A Relationship	135
Hierarchies	136
Multiple Inheritance	137
Mixin Classes	138

Abstraction	138
Interface versus Implementation	138
Deciding on an Exposed Interface	139
Consider the Audience	139
Consider the Purpose	139
Consider the Future	141
Designing a Successful Abstraction	141
Summary	142
CHAPTER 6: DESIGNING FOR REUSE	143
<hr/>	
The Reuse Philosophy	144
How to Design Reusable Code	144
Use Abstraction	145
Structure Your Code for Optimal Reuse	146
Avoid Combining Unrelated or Logically Separate Concepts	146
Use Templates for Generic Data Structures and Algorithms	148
Provide Appropriate Checks and Safeguards	150
Design for Extensibility	151
Design Usable Interfaces	153
Design Interfaces That Are Easy to Use	153
Design General-Purpose Interfaces	157
Reconciling Generality and Ease of Use	157
The SOLID Principles	158
Summary	159
<hr/>	
PART III: C++ CODING THE PROFESSIONAL WAY	
<hr/>	
CHAPTER 7: MEMORY MANAGEMENT	163
<hr/>	
Working with Dynamic Memory	164
How to Picture Memory	164
Allocation and Deallocation	166
Using new and delete	166
What about My Good Friend malloc?	167
When Memory Allocation Fails	167
Arrays	168
Arrays of Basic Types	168
Arrays of Objects	170
Deleting Arrays	171
Multi-dimensional Arrays	172
Working with Pointers	175

A Mental Model for Pointers	175
Casting with Pointers	176
Array-Pointer Duality	177
Arrays Are Pointers!	177
Not All Pointers Are Arrays!	179
Low-Level Memory Operations	179
Pointer Arithmetic	179
Custom Memory Management	180
Garbage Collection	181
Object Pools	182
Smart Pointers	182
unique_ptr	183
Creating unique_ptrs	183
Using unique_ptrs	185
unique_ptr and C-Style Arrays	186
Custom Deleters	186
shared_ptr	186
Casting a shared_ptr	187
The Need for Reference Counting	188
Aliasing	189
weak_ptr	189
Move Semantics	190
enable_shared_from_this	191
The Old Deprecated/Removed auto_ptr	192
Common Memory Pitfalls	192
Underallocating Strings	192
Accessing Out-of-Bounds Memory	193
Memory Leaks	194
Finding and Fixing Memory Leaks in Windows with Visual C++	195
Finding and Fixing Memory Leaks in Linux with Valgrind	196
Double-Deleting and Invalid Pointers	197
Summary	197

CHAPTER 8: GAINING PROFICIENCY WITH CLASSES AND OBJECTS 199

Introducing the Spreadsheet Example	200
Writing Classes	200
Class Definitions	200
Class Members	201
Access Control	201
Order of Declarations	203
In-Class Member Initializers	203

Defining Methods	203
Accessing Data Members	204
Calling Other Methods	204
The this Pointer	206
Using Objects	207
Objects on the Stack	207
Objects on the Heap	207
Object Life Cycles	208
Object Creation	208
Writing Constructors	209
Using Constructors	210
Providing Multiple Constructors	211
Default Constructors	212
Constructor Initializers	215
Copy Constructors	218
Initializer-List Constructors	220
Delegating Constructors	222
Summary of Compiler-Generated Constructors	222
Object Destruction	224
Assigning to Objects	225
Declaring an Assignment Operator	225
Defining an Assignment Operator	226
Explicitly Defaulted and Deleted Assignment Operator	227
Compiler-Generated Copy Constructor and Copy Assignment Operator	228
Distinguishing Copying from Assignment	228
Objects as Return Values	228
Copy Constructors and Object Members	229
Summary	230
CHAPTER 9: MASTERING CLASSES AND OBJECTS	231
<hr/>	
Friends	232
Dynamic Memory Allocation in Objects	233
The Spreadsheet Class	233
Freeing Memory with Destructors	235
Handling Copying and Assignment	236
The Spreadsheet Copy Constructor	239
The Spreadsheet Assignment Operator	240
Disallowing Assignment and Pass-By-Value	242
Handling Moving with Move Semantics	243
Rvalue References	243
Implementing Move Semantics	245

Testing the Spreadsheet Move Operations	248
Implementing a Swap Function with Move Semantics	250
Rule of Zero	250
More about Methods	251
static Methods	251
const Methods	251
mutable Data Members	253
Method Overloading	253
Overloading Based on const	254
Explicitly Deleting Overloads	255
Inline Methods	255
Default Arguments	257
Different Kinds of Data Members	258
static Data Members	258
Inline Variables	259
Accessing static Data Members within Class Methods	259
Accessing static Data Members Outside Methods	260
const static Data Members	260
Reference Data Members	261
const Reference Data Members	262
Nested Classes	263
Enumerated Types inside Classes	264
Operator Overloading	265
Example: Implementing Addition for SpreadsheetCells	265
First Attempt: The add Method	265
Second Attempt: Overloaded operator+ as a Method	266
Third Attempt: Global operator+	268
Overloading Arithmetic Operators	269
Overloading the Arithmetic Shorthand Operators	269
Overloading Comparison Operators	270
Building Types with Operator Overloading	271
Building Stable Interfaces	272
Using Interface and Implementation Classes	272
Summary	275
CHAPTER 10: DISCOVERING INHERITANCE TECHNIQUES	277
Building Classes with Inheritance	278
Extending Classes	278
A Client's View of Inheritance	279
A Derived Class's View of Inheritance	280
Preventing Inheritance	281

Overriding Methods	281
How I Learned to Stop Worrying and Make Everything virtual	281
Syntax for Overriding a Method	282
A Client's View of Overridden Methods	283
The override Keyword	284
The Truth about virtual	286
Preventing Overriding	290
Inheritance for Reuse	291
The WeatherPrediction Class	291
Adding Functionality in a Derived Class	292
Replacing Functionality in a Derived Class	293
Respect Your Parents	294
Parent Constructors	294
Parent Destructors	296
Referring to Parent Names	297
Casting Up and Down	299
Inheritance for Polymorphism	301
Return of the Spreadsheet	301
Designing the Polymorphic Spreadsheet Cell	301
The SpreadsheetCell Base Class	302
A First Attempt	302
Pure Virtual Methods and Abstract Base Classes	303
The Individual Derived Classes	304
StringSpreadsheetCell Class Definition	304
StringSpreadsheetCell Implementation	304
DoubleSpreadsheetCell Class Definition and Implementation	305
Leveraging Polymorphism	306
Future Considerations	306
Multiple Inheritance	308
Inheriting from Multiple Classes	308
Naming Collisions and Ambiguous Base Classes	309
Name Ambiguity	309
Ambiguous Base Classes	311
Uses for Multiple Inheritance	312
Interesting and Obscure Inheritance Issues	312
Changing the Overridden Method's Characteristics	313
Changing the Method Return Type	313
Changing the Method Parameters	315
Inherited Constructors	316
Special Cases in Overriding Methods	320

The Base Class Method Is static	320
The Base Class Method Is Overloaded	321
The Base Class Method Is private or protected	322
The Base Class Method Has Default Arguments	324
The Base Class Method Has a Different Access Level	325
Copy Constructors and Assignment Operators in Derived Classes	327
Run-Time Type Facilities	329
Non-public Inheritance	331
Virtual Base Classes	331
Summary	332

CHAPTER 11: C++ QUIRKS, ODDITIES, AND INCIDENTALS 333

References	334
Reference Variables	334
Modifying References	335
References to Pointers and Pointers to References	336
Reference Data Members	336
Reference Parameters	336
References from Pointers	337
Pass-by-Reference versus Pass-by-Value	337
Reference Return Values	338
Rvalue References	338
Deciding between References and Pointers	339
Keyword Confusion	343
The const Keyword	343
const Variables and Parameters	343
const Methods	345
The constexpr Keyword	346
The static Keyword	347
static Data Members and Methods	347
static Linkage	347
static Variables in Functions	350
Order of Initialization of Nonlocal Variables	351
Order of Destruction of Nonlocal Variables	351
Types and Casts	351
Type Aliases	352
Type Aliases for Function Pointers	353
Type Aliases for Pointers to Methods and Data Members	355
typedefs	356

Casts	357
const_cast()	357
static_cast()	358
reinterpret_cast()	359
dynamic_cast()	360
Summary of Casts	361
Scope Resolution	362
Attributes	363
[[noreturn]]	363
[[deprecated]]	364
[[fallthrough]]	364
[[nodiscard]]	364
[[maybe_unused]]	365
Vendor-Specific Attributes	365
User-Defined Literals	365
Standard User-Defined Literals	367
Header Files	367
C Utilities	369
Variable-Length Argument Lists	369
Accessing the Arguments	370
Why You Shouldn't Use C-Style Variable-Length Argument Lists	371
Preprocessor Macros	371
Summary	372
CHAPTER 12: WRITING GENERIC CODE WITH TEMPLATES	373
Overview of Templates	374
Class Templates	375
Writing a Class Template	375
Coding without Templates	375
A Template Grid Class	378
Using the Grid Template	382
Angle Brackets	383
How the Compiler Processes Templates	383
Selective Instantiation	384
Template Requirements on Types	384
Distributing Template Code between Files	384
Template Definitions in Header Files	384
Template Definitions in Source Files	385
Template Parameters	386
Non-type Template Parameters	387

Default Values for Type Parameters	389
Template Parameter Deduction for Constructors	389
Method Templates	391
Method Templates with Non-type Parameters	393
Class Template Specialization	395
Deriving from Class Templates	397
Inheritance versus Specialization	399
Alias Templates	399
Function Templates	400
Function Template Specialization	401
Function Template Overloading	402
Function Template Overloading and Specialization Together	403
Friend Function Templates of Class Templates	403
More on Template Parameter Deduction	404
Return Type of Function Templates	405
Variable Templates	407
Summary	407
CHAPTER 13: DEMYSTIFYING C++ I/O	409
Using Streams	410
What Is a Stream, Anyway?	410
Stream Sources and Destinations	411
Output with Streams	411
Output Basics	412
Methods of Output Streams	412
Handling Output Errors	414
Output Manipulators	415
Input with Streams	417
Input Basics	417
Handling Input Errors	418
Input Methods	419
Input Manipulators	423
Input and Output with Objects	423
String Streams	425
File Streams	426
Text Mode versus Binary Mode	427
Jumping around with seek() and tell()	428
Linking Streams Together	430
Bidirectional I/O	431
Summary	432

CHAPTER 14: HANDLING ERRORS	433
Errors and Exceptions	434
What Are Exceptions, Anyway?	434
Why Exceptions in C++ Are a Good Thing	434
Recommendation	436
Exception Mechanics	436
Throwing and Catching Exceptions	437
Exception Types	439
Catching Exception Objects by const Reference	440
Throwing and Catching Multiple Exceptions	441
Matching and const	443
Matching Any Exception	443
Uncaught Exceptions	444
noexcept	445
Throw Lists (Deprecated/Removed)	446
Exceptions and Polymorphism	446
The Standard Exception Hierarchy	446
Catching Exceptions in a Class Hierarchy	448
Writing Your Own Exception Classes	449
Nested Exceptions	452
Rethrowing Exceptions	454
Stack Unwinding and Cleanup	456
Use Smart Pointers	457
Catch, Cleanup, and Rethrow	458
Common Error-Handling Issues	459
Memory Allocation Errors	459
Non-throwing new	460
Customizing Memory Allocation Failure Behavior	460
Errors in Constructors	462
Function-Try-Blocks for Constructors	464
Errors in Destructors	467
Putting It All Together	468
Summary	472
CHAPTER 15: OVERLOADING C++ OPERATORS	473
Overview of Operator Overloading	474
Why Overload Operators?	474
Limitations to Operator Overloading	474
Choices in Operator Overloading	475
Method or Global Function	475

Choosing Argument Types	476
Choosing Return Types	477
Choosing Behavior	477
Operators You Shouldn't Overload	477
Summary of Overloadable Operators	478
Rvalue References	481
Relational Operators	482
Overloading the Arithmetic Operators	483
Overloading Unary Minus and Unary Plus	483
Overloading Increment and Decrement	483
Overloading the Bitwise and Binary Logical Operators	484
Overloading the Insertion and Extraction Operators	485
Overloading the Subscripting Operator	486
Providing Read-Only Access with operator[]	489
Non-integral Array Indices	490
Overloading the Function Call Operator	491
Overloading the Dereferencing Operators	492
Implementing operator*	494
Implementing operator->	494
What in the World Are operator.* and operator->*?	495
Writing Conversion Operators	496
Solving Ambiguity Problems with Explicit Conversion Operators	497
Conversions for Boolean Expressions	498
Overloading the Memory Allocation and Deallocation Operators	500
How new and delete Really Work	500
The New-Expression and operator new	501
The Delete-Expression and operator delete	501
Overloading operator new and operator delete	501
Explicitly Deleting/Defaulting operator new and operator delete	504
Overloading operator new and operator delete with Extra Parameters	504
Overloading operator delete with Size of Memory as Parameter	505
Summary	506
CHAPTER 16: OVERVIEW OF THE C++ STANDARD LIBRARY	507
<hr/>	
Coding Principles	508
Use of Templates	508
Use of Operator Overloading	509
Overview of the C++ Standard Library	509
Strings	509
Regular Expressions	510
I/O Streams	510

Smart Pointers	510
Exceptions	510
Mathematical Utilities	511
Time Utilities	512
Random Numbers	512
Initializer Lists	512
Pair and Tuple	512
optional, variant, and any	512
Function Objects	513
Filesystem	513
Multithreading	513
Type Traits	513
Standard Integer Types	514
Containers	514
vector	514
list	515
forward_list	515
deque	516
array	516
queue	516
priority_queue	516
stack	517
set and multiset	517
map and multimap	518
Unordered Associative Containers/Hash Tables	518
bitset	519
Summary of Standard Library Containers	519
Algorithms	522
Non-modifying Sequence Algorithms	523
Modifying Sequence Algorithms	525
Operational Algorithms	527
Swap and Exchange Algorithms	527
Partition Algorithms	527
Sorting Algorithms	528
Binary Search Algorithms	529
Set Algorithms	529
Heap Algorithms	529
Minimum/Maximum Algorithms	530
Numerical Processing Algorithms	530

Permutation Algorithms	532
Choosing an Algorithm	532
What's Missing from the Standard Library	532
Summary	533

CHAPTER 17: UNDERSTANDING CONTAINERS AND ITERATORS 535

Containers Overview	536
Requirements on Elements	537
Exceptions and Error Checking	539
Iterators	539
Sequential Containers	542
vector	542
vector Overview	542
vector Details	544
vector Example: A Round-Robin Class	556
The vector<bool> Specialization	561
deque	562
list	562
Accessing Elements	562
Iterators	562
Adding and Removing Elements	563
list Size	563
Special list Operations	563
list Example: Determining Enrollment	565
forward_list	566
array	568
Container Adaptors	569
queue	570
queue Operations	570
queue Example: A Network Packet Buffer	570
priority_queue	572
priority_queue Operations	573
priority_queue Example: An Error Correlator	573
stack	575
stack Operations	575
stack Example: Revised Error Correlator	575
Ordered Associative Containers	576
The pair Utility Class	576

map	577
Constructing maps	577
Inserting Elements	578
map Iterators	580
Looking Up Elements	581
Removing Elements	582
Nodes	582
map Example: Bank Account	583
multimap	585
multimap Example: Buddy Lists	586
set	589
set Example: Access Control List	589
multiset	590
Unordered Associative Containers or Hash Tables	591
Hash Functions	591
unordered_map	593
unordered_map Example: Phone Book	596
unordered_multimap	597
unordered_set/unordered_multiset	598
Other Containers	598
Standard C-Style Arrays	598
Strings	599
Streams	600
bitset	600
bitset Basics	600
Bitwise Operators	601
bitset Example: Representing Cable Channels	601
Summary	605
CHAPTER 18: MASTERING STANDARD LIBRARY ALGORITHMS	607
<hr/>	
Overview of Algorithms	608
The find and find_if Algorithms	608
The accumulate Algorithm	611
Move Semantics with Algorithms	612
std::function	612
Lambda Expressions	614
Syntax	614
Generic Lambda Expressions	617
Lambda Capture Expressions	618
Lambda Expressions as Return Type	618
Lambda Expressions as Parameters	619

Examples with Standard Library Algorithms	619
count_if	619
generate	620
Function Objects	620
Arithmetic Function Objects	621
Transparent Operator Functors	622
Comparison Function Objects	622
Logical Function Objects	623
Bitwise Function Objects	624
Adaptor Function Objects	624
Binders	624
Negators	626
Calling Member Functions	628
Invokers	629
Writing Your Own Function Objects	629
Algorithm Details	630
Iterators	631
Non-modifying Sequence Algorithms	631
Search Algorithms	631
Specialized Searchers	633
Comparison Algorithms	634
Counting Algorithms	636
Modifying Sequence Algorithms	636
transform	637
copy	638
move	640
replace	641
remove	641
unique	643
sample	643
reverse	644
shuffle	644
Operational Algorithms	644
for_each	644
for_each_n	646
Swap and Exchange Algorithms	646
swap	646
exchange	647
Partition Algorithms	647
Sorting Algorithms	649
Binary Search Algorithms	649

Set Algorithms	650
Minimum/Maximum Algorithms	653
Parallel Algorithms	655
Numerical Processing Algorithms	655
inner_product	656
iota	656
gcd and lcm	656
reduce	656
transform_reduce	657
Scan Algorithms	657
Algorithms Example: Auditing Voter Registrations	657
The Voter Registration Audit Problem Statement	658
The auditVoterRolls Function	658
The getDuplicates Function	659
Testing the auditVoterRolls Function	660
Summary	661
CHAPTER 19: STRING LOCALIZATION AND REGULAR EXPRESSIONS	663
Localization	663
Localizing String Literals	664
Wide Characters	664
Non-Western Character Sets	665
Conversions	667
Locales and Facets	668
Using Locales	668
Character Classification	669
Character Conversion	670
Using Facets	670
Regular Expressions	671
ECMAScript Syntax	672
Anchors	673
Wildcards	673
Alternation	673
Grouping	673
Repetition	673
Precedence	674
Character Set Matches	674
Word Boundaries	676
Back References	677

Lookahead	677
Regular Expressions and Raw String Literals	677
The regex Library	678
regex_match()	679
regex_match() Example	680
regex_search()	682
regex_search() Example	683
regex_iterator	683
regex_iterator Example	684
regex_token_iterator	685
regex_token_iterator Examples	685
regex_replace()	687
regex_replace() Examples	688
Summary	690
CHAPTER 20: ADDITIONAL LIBRARY UTILITIES	691
Ratios	691
The Chrono Library	694
Duration	694
Clock	698
Time Point	700
Random Number Generation	702
Random Number Engines	703
Random Number Engine Adaptors	705
Predefined Engines and Engine Adaptors	705
Generating Random Numbers	706
Random Number Distributions	708
optional	711
variant	712
any	713
Tuples	714
Decompose Tuples	717
Structured Bindings	717
tie	717
Concatenation	718
Comparisons	718
make_from_tuple	719
apply	719
Filesystem Support Library	720
Path	720

Directory Entry	721
Helper Functions	721
Directory Iteration	722
Summary	723

PART IV: MASTERING ADVANCED FEATURES OF C++

CHAPTER 21: CUSTOMIZING AND EXTENDING THE STANDARD LIBRARY **727**

Allocators	728
Stream Iterators	729
Output Stream Iterator	729
Input Stream Iterator	730
Iterator Adaptors	730
Reverse Iterators	730
Insert Iterators	731
Move Iterators	733
Extending the Standard Library	735
Why Extend the Standard Library?	735
Writing a Standard Library Algorithm	735
find_all()	735
Iterator Traits	737
Writing a Standard Library Container	737
A Basic Hash Map	738
Making hash_map a Standard Library Container	747
Note on Allocators	760
Note on Reversible Containers	760
Making hash_map an Unordered Associative Container	760
Note on Sequential Containers	773
Summary	773

CHAPTER 22: ADVANCED TEMPLATES **775**

More about Template Parameters	776
More about Template Type Parameters	776
Introducing Template Template Parameters	778
More about Non-type Template Parameters	780
Class Template Partial Specialization	782
Emulating Function Partial Specialization with Overloading	786
Template Recursion	787
An N-Dimensional Grid: First Attempt	788
A Real N-Dimensional Grid	789

Variadic Templates	792
Type-Safe Variable-Length Argument Lists	792
Variable Number of Mixin Classes	795
Folding Expressions	796
Metaprogramming	797
Factorial at Compile Time	798
Loop Unrolling	799
Printing Tuples	800
constexpr if	802
Using a Compile-Time Integer Sequence with Folding	803
Type Traits	803
Using Type Categories	805
Using Type Relations	807
Using enable_if	808
Using constexpr if to Simplify enable_if Constructs	810
Logical Operator Traits	811
Metaprogramming Conclusion	811
Summary	812
CHAPTER 23: MULTITHREADED PROGRAMMING WITH C++	813
Introduction	814
Race Conditions	815
Tearing	817
Deadlocks	817
False-Sharing	818
Threads	819
Thread with Function Pointer	819
Thread with Function Object	820
Thread with Lambda	822
Thread with Member Function	823
Thread Local Storage	823
Cancelling Threads	824
Retrieving Results from Threads	824
Copying and Rethrowing Exceptions	824
Atomic Operations Library	827
Atomic Type Example	828
Atomic Operations	830
Mutual Exclusion	831
Mutex Classes	831
Non-timed Mutex Classes	832
Timed Mutex Classes	832

Locks	833
lock_guard	833
unique_lock	834
shared_lock	835
Acquiring Multiple Locks at Once	835
scoped_lock	835
std::call_once	836
Examples Using Mutual Exclusion Objects	837
Thread-Safe Writing to Streams	837
Using Timed Locks	838
Double-Checked Locking	839
Condition Variables	840
Spurious Wake-Ups	841
Using Condition Variables	841
Futures	843
std::promise and std::future	843
std::packaged_task	844
std::async	845
Exception Handling	846
std::shared_future	847
Example: Multithreaded Logger Class	848
Thread Pools	853
Threading Design and Best Practices	853
Summary	855

PART V: C++ SOFTWARE ENGINEERING

CHAPTER 24: MAXIMIZING SOFTWARE ENGINEERING METHODS	859
The Need for Process	860
Software Life Cycle Models	861
The Waterfall Model	861
Benefits of the Waterfall Model	862
Drawbacks of the Waterfall Model	862
Sashimi Model	863
Spiral-Like Models	863
Benefits of a Spiral-Like Model	864
Drawbacks of a Spiral-Like Model	866
Agile	866
Software Engineering Methodologies	867
The Unified Process	867
The Rational Unified Process	868

RUP as a Product	868
RUP as a Process	869
RUP in Practice	869
Scrum	869
Roles	870
The Process	870
Benefits of Scrum	871
Drawbacks of Scrum	872
Extreme Programming	872
XP in Theory	872
XP in Practice	876
Software Triage	876
Building Your Own Process and Methodology	877
Be Open to New Ideas	877
Bring New Ideas to the Table	877
Recognize What Works and What Doesn't Work	877
Don't Be a Renegade	878
Source Code Control	878
Summary	880
CHAPTER 25: WRITING EFFICIENT C++	881
Overview of Performance and Efficiency	882
Two Approaches to Efficiency	882
Two Kinds of Programs	882
Is C++ an Inefficient Language?	882
Language-Level Efficiency	883
Handle Objects Efficiently	884
Pass-by-Reference	884
Return-by-Reference	886
Catch Exceptions by Reference	886
Use Move Semantics	886
Avoid Creating Temporary Objects	886
The Return-Value Optimization	887
Pre-allocate Memory	888
Use Inline Methods and Functions	888
Design-Level Efficiency	889
Cache Where Necessary	889
Use Object Pools	890
An Object Pool Implementation	891
Using the Object Pool	893

Profiling	894
Profiling Example with gprof	895
First Design Attempt	895
Profiling the First Design Attempt	898
Second Design Attempt	900
Profiling the Second Design Attempt	901
Profiling Example with Visual C++ 2017	902
Summary	907
CHAPTER 26: BECOMING ADEPT AT TESTING	909
Quality Control	910
Whose Responsibility Is Testing?	910
The Life Cycle of a Bug	910
Bug-Tracking Tools	912
Unit Testing	913
Approaches to Unit Testing	914
The Unit Testing Process	915
Define the Granularity of Your Tests	915
Brainstorm the Individual Tests	917
Create Sample Data and Results	918
Write the Tests	918
Run the Tests	919
Unit Testing in Action	919
Introducing the Microsoft Visual C++ Testing Framework	920
Writing the First Test	921
Building and Running Tests	922
Negative Tests	923
Adding the Real Tests	923
Debugging Tests	927
Basking in the Glorious Light of Unit Test Results	927
Higher-Level Testing	927
Integration Tests	928
Sample Integration Tests	928
Methods of Integration Testing	929
System Tests	929
Regression Tests	930
Tips for Successful Testing	930
Summary	931

CHAPTER 27: CONQUERING DEBUGGING	933
The Fundamental Law of Debugging	934
Bug Taxonomies	934
Avoiding Bugs	934
Planning for Bugs	935
Error Logging	935
Debug Traces	937
Debug Mode	937
Ring Buffers	942
Assertions	945
Crash Dumps	946
Static Assertions	947
Debugging Techniques	948
Reproducing Bugs	948
Debugging Reproducible Bugs	949
Debugging Nonreproducible Bugs	950
Debugging Regressions	951
Debugging Memory Problems	951
Categories of Memory Errors	952
Tips for Debugging Memory Errors	954
Debugging Multithreaded Programs	956
Debugging Example: Article Citations	957
Buggy Implementation of an ArticleCitations Class	957
Testing the ArticleCitations class	960
Lessons from the ArticleCitations Example	969
Summary	969
CHAPTER 28: INCORPORATING DESIGN TECHNIQUES AND FRAMEWORKS	971
"I Can Never Remember How to..."	972
...Write a Class	972
...Derive from an Existing Class	974
...Use the Copy-and-Swap Idiom	975
...Throw and Catch Exceptions	976
...Read from a File	976
...Write to a File	977
...Write a Template Class	977
There Must Be a Better Way	979
Resource Acquisition Is Initialization	979
Double Dispatch	981

Attempt #1: Brute Force	982
Attempt #2: Single Polymorphism with Overloading	983
Attempt #3: Double Dispatch	984
Mixin Classes	985
Designing a Mixin Class	986
Implementing a Mixin Class	987
Using a Mixin Class	988
Object-Oriented Frameworks	988
Working with Frameworks	988
The Model-View-Controller Paradigm	989
Summary	990
CHAPTER 29: APPLYING DESIGN PATTERNS	991
<hr/>	
The Iterator Pattern	992
The Singleton Pattern	993
Example: A Logging Mechanism	993
Implementation of a Singleton	994
Using a Singleton	997
The Abstract Factory Pattern	997
Example: A Car Factory Simulation	998
Implementation of a Factory	999
Using a Factory	1002
Other Uses of Factories	1003
The Proxy Pattern	1004
Example: Hiding Network Connectivity Issues	1004
Implementation of a Proxy	1004
Using a Proxy	1005
The Adaptor Pattern	1006
Example: Adapting a Logger Class	1006
Implementation of an Adaptor	1007
Using an Adaptor	1008
The Decorator Pattern	1008
Example: Defining Styles in Web Pages	1008
Implementation of a Decorator	1009
Using a Decorator	1010
The Chain of Responsibility Pattern	1010
Example: Event Handling	1011
Implementation of a Chain of Responsibility	1011
Chain of Responsibility without Hierarchy	1012
The Observer Pattern	1014
Implementation of an Observer	1014

Implementation of an Observable	1015
Using an Observer	1016
Summary	1016
CHAPTER 30: DEVELOPING CROSS-PLATFORM AND CROSS-LANGUAGE APPLICATIONS	1017
<hr/>	
Cross-Platform Development	1018
Architecture Issues	1018
Size of Integers	1018
Binary Compatibility	1019
Address Sizes	1020
Byte Order	1020
Implementation Issues	1021
Compiler Quirks and Extensions	1021
Library Implementations	1022
Platform-Specific Features	1022
Cross-Language Development	1024
Mixing C and C++	1024
Shifting Paradigms	1024
Linking with C Code	1028
Calling C++ Code from C#	1030
Calling C++ Code from Java with JNI	1031
Calling Scripts from C++ Code	1033
Calling C++ Code from Scripts	1034
A Practical Example: Encrypting Passwords	1034
Calling Assembly Code from C++	1036
Summary	1038
APPENDIX A: C++ INTERVIEWS	1039
<hr/>	
APPENDIX B: ANNOTATED BIBLIOGRAPHY	1063
<hr/>	
APPENDIX C: STANDARD LIBRARY HEADER FILES	1075
<hr/>	
APPENDIX D: INTRODUCTION TO UML	1083
<hr/>	
INDEX	1087

INTRODUCTION

For many years, C++ has served as the de facto language for writing fast, powerful, and enterprise-class object-oriented programs. As popular as C++ has become, the language is surprisingly difficult to grasp in full. There are simple, but powerful, techniques that professional C++ programmers use that don't show up in traditional texts, and there are useful parts of C++ that remain a mystery even to experienced C++ programmers.

Too often, programming books focus on the syntax of the language instead of its real-world use. The typical C++ text introduces a major part of the language in each chapter, explaining the syntax and providing an example. *Professional C++* does not follow this pattern. Instead of giving you just the nuts and bolts of the language with little practical context, this book will teach you how to use C++ in the real world. It will show you the little-known features that will make your life easier, and the programming techniques that separate novices from professional programmers.

WHO THIS BOOK IS FOR

Even if you have used the language for years, you might still be unfamiliar with the more-advanced features of C++, or you might not be using the full capabilities of the language. Perhaps you write competent C++ code, but would like to learn more about design and good programming style in C++. Or maybe you're relatively new to C++, but want to learn the “right” way to program from the start. This book will meet those needs and bring your C++ skills to the professional level.

Because this book focuses on advancing from basic or intermediate knowledge of C++ to becoming a professional C++ programmer, it assumes that you have some knowledge of the language. Chapter 1 covers the basics of C++ as a refresher, but it is not a substitute for actual training and use of the language. If you are just starting with C++, but you have significant experience in another programming language such as C, Java, or C#, you should be able to pick up most of what you need from Chapter 1.

In any case, you should have a solid foundation in programming fundamentals. You should know about loops, functions, and variables. You should know how to structure a program, and you should be familiar with fundamental techniques such as recursion. You should have some knowledge of common data structures such as queues, and useful algorithms such as sorting and searching. You don't need to know about object-oriented programming just yet—that is covered in Chapter 5.

You will also need to be familiar with the compiler you will be using to develop your code. Two compilers, Microsoft Visual C++ and GCC, are introduced later in this introduction. For other compilers, refer to the documentation that came with your compiler.

WHAT THIS BOOK COVERS

Professional C++ uses an approach to C++ programming that will both increase the quality of your code and improve your programming efficiency. You will find discussions on new C++17 features throughout this fourth edition. These features are not just isolated to a few chapters or sections; instead, examples have been updated to use new features when appropriate.

Professional C++ teaches you more than just the syntax and language features of C++. It also emphasizes programming methodologies, reusable design patterns, and good programming style. The *Professional C++* methodology incorporates the entire software development process, from designing and writing code, to debugging, and working in groups. This approach will enable you to master the C++ language and its idiosyncrasies, as well as take advantage of its powerful capabilities for large-scale software development.

Imagine users who have learned all of the syntax of C++ without seeing a single example of its use. They know just enough to be dangerous! Without examples, they might assume that all code should go in the `main()` function of the program, or that all variables should be global—practices that are generally not considered hallmarks of good programming.

Professional C++ programmers understand the correct way to use the language, in addition to the syntax. They recognize the importance of good design, the theories of object-oriented programming, and the best ways to use existing libraries. They have also developed an arsenal of useful code and reusable ideas.

By reading and understanding this book, you will become a professional C++ programmer. You will expand your knowledge of C++ to cover lesser-known and often misunderstood language features. You will gain an appreciation for object-oriented design, and acquire top-notch debugging skills. Perhaps most important, you will finish this book armed with a wealth of reusable ideas that you can actually apply to your daily work.

There are many good reasons to make the effort to be a professional C++ programmer, as opposed to a programmer who knows C++. Understanding the true workings of the language will improve the quality of your code. Learning about different programming methodologies and processes will help you to work better with your team. Discovering reusable libraries and common design patterns will improve your daily efficiency and help you stop reinventing the wheel. All of these lessons will make you a better programmer and a more valuable employee. While this book can't guarantee you a promotion, it certainly won't hurt.

HOW THIS BOOK IS STRUCTURED

This book is made up of five parts.

Part I, “Introduction to Professional C++,” begins with a crash course in C++ basics to ensure a foundation of C++ knowledge. Following the crash course, Part I goes deeper into working with strings and string views because strings are used extensively in most examples throughout the book. The last chapter of Part I explores how to write *readable* C++ code.

Part II, “Professional C++ Software Design,” discusses C++ design methodologies. You will read about the importance of design, the object-oriented methodology, and the importance of code reuse.

Part III, “C++ Coding the Professional Way,” provides a technical tour of C++ from the professional point of view. You will read about the best ways to manage memory in C++, how to create reusable classes, and how to leverage important language features such as inheritance. You will also learn about the unusual and quirky parts of the language, techniques for input and output, error handling, string localization, and how to work with regular expressions. You will read about how to implement operator overloading, and how to write templates. This part also explains the C++ Standard Library, including containers, iterators, and algorithms. You will also read about some additional libraries that are available in the standard, such as the libraries to work with time, random numbers, and the filesystem.

Part IV, “Mastering Advanced Features of C++,” demonstrates how you can get the most out of C++. This part of the book exposes the mysteries of C++ and describes how to use some of its more-advanced features. You will read about how to customize and extend the C++ Standard Library to your needs, advanced details on template programming, including template metaprogramming, and how to use multithreading to take advantage of multiprocessor and multicore systems.

Part V, “C++ Software Engineering,” focuses on writing enterprise-quality software. You’ll read about the engineering practices being used by programming organizations today; how to write efficient C++ code; software testing concepts, such as unit testing and regression testing; techniques used to debug C++ programs; how to incorporate design techniques, frameworks, and conceptual object-oriented design patterns into your own code; and solutions for cross-language and cross-platform code.

The book concludes with a useful chapter-by-chapter guide to succeeding in a C++ technical interview, an annotated bibliography, a summary of the C++ header files available in the standard, and a brief introduction to the Unified Modeling Language (UML).

This book is not a reference of every single class, method, and function available in C++. The book *C++ Standard Library Quick Reference* by Peter Van Weert and Marc Gregoire¹ is a condensed reference to all essential data structures, algorithms, and functions provided by the C++ Standard Library. Appendix B lists a couple more references. Two excellent online references are:

- www.cppreference.com
You can use this reference online, or download an offline version for use when you are not connected to the Internet.
- www.cplusplus.com/reference/

When I refer to a “Standard Library Reference” in this book, I am referring to one of these detailed C++ references.

¹Apress, 2016. ISBN: 978-1-4842-1875-4.

WHAT YOU NEED TO USE THIS BOOK

All you need to use this book is a computer with a C++ compiler. This book focuses only on parts of C++ that have been standardized, and not on vendor-specific compiler extensions.

Note that this book includes new features introduced with the C++17 standard. At the time of this writing, some compilers are not yet fully C++17 compliant.

You can use whichever C++ compiler you like. If you don't have a C++ compiler yet, you can download one for free. There are a lot of choices. For example, for Windows, you can download Microsoft Visual Studio 2017 Community Edition, which is free and includes Visual C++. For Linux, you can use GCC or Clang, which are also free.

The following two sections briefly explain how to use Visual C++ and GCC. Refer to the documentation that came with your compiler for more details.

Microsoft Visual C++

First, you need to create a project. Start Visual C++ and click File ⇨ New ⇨ Project. In the project template tree on the left, select Visual C++ ⇨ Win32 (or Windows Desktop). Then select the Win32 Console Application (or Windows Console Application) template in the list in the middle of the window. At the bottom, specify a name for the project and a location where to save it, and click OK. A wizard opens². In this wizard, click Next, select Console Application, Empty Project, and click Finish.

Once your new project is loaded, you can see a list of project files in the Solution Explorer. If this docking window is not visible, go to View ⇨ Solution Explorer. You can add new files or existing files to a project by right-clicking the project name in the Solution Explorer and then clicking Add ⇨ New Item or Add ⇨ Existing Item.

Use Build ⇨ Build Solution to compile your code. When it compiles without errors, you can run it with Debug ⇨ Start Debugging.

If your program exits before you have a chance to view the output, use Debug ⇨ Start without Debugging. This adds a pause to the end of the program so you can view the output.

At the time of this writing, Visual C++ 2017 does not yet automatically enable C++17 features. To enable C++17 features, in the Solution Explorer window, right-click your project and click Properties. In the properties window, go to Configuration Properties ⇨ C/C++ ⇨ Language, and set the C++ Language Standard option to “ISO C++17 Standard” or “ISO C++ Latest Draft Standard,” whichever is available in your version of Visual C++. These options are only accessible if your project contains at least one .cpp file.

Visual C++ supports so-called precompiled headers, a topic outside the scope of this book. In general, I recommend using precompiled headers if your compiler supports them. However, the source

²Depending on your version of VC++ 2017, you might not see any wizard. Instead, a new project will be created automatically containing four files: stdafx.h, stdafx.cpp, targetver.h, and <projectname>.cpp. If that is the case, and you want to compile source code files from the downloadable source archive for this book, then you have to select those files in the Solution Explorer (View ⇨ Solution Explorer) and delete them.

code files in the downloadable source code archive do not use precompiled headers, so you have to disable that feature for them to compile without errors. In the Solution Explorer window, right-click your project and click Properties. In the properties window, go to Configuration Properties ⇨ C/C++ ⇨ Precompiled Headers, and set the Precompiled Header option to “Not Using Precompiled Headers.”

GCC

Create your source code files with any text editor you prefer and save them to a directory. To compile your code, open a terminal and run the following command, specifying all your `.cpp` files that you want to compile:

```
gcc -lstdc++ -std=c++17 -o <executable_name> <source1.cpp> [source2.cpp ...]
```

The `-std=c++17` option is required to tell GCC to enable C++17 support.

For example, you can compile the `AirlineTicket` example from Chapter 1 by changing to the directory containing the code and running the following command:

```
gcc -lstdc++ -std=c++17 -o AirlineTicket AirlineTicket.cpp AirlineTicketTest.cpp
```

When it compiles without errors, you can run it as follows:

```
./AirlineTicket
```

CONVENTIONS

To help you get the most from the text and keep track of what’s happening, a number of conventions are used throughout this book.

WARNING *Boxes like this one hold important, not-to-be-forgotten information that is directly relevant to the surrounding text.*

NOTE *Tips, hints, tricks, and asides to the current discussion are placed in boxes like this one.*

As for styles in the text:

Important words are *highlighted* when they are introduced.

Keyboard strokes are shown like this: `Ctrl+A`.

Filenames and code within the text are shown like so: `monkey.cpp`.

URLs are shown like this: `www.wrox.com`.

Code is presented in three different ways:

```
// Comments in code are shown like this.
```

In code examples, new and important code is highlighted like this.

Code that's less important in the present context or that has been shown before is formatted like this.

 Paragraphs or sections that are specific to the C++17 standard have a little C++17 icon on the left, just as this paragraph does. C++11 and C++14 features are not marked with any icon.

SOURCE CODE

As you work through the examples in this book, you may choose either to type in all the code manually, or to use the source code files that accompany the book. However, I suggest you type in all the code manually because it greatly benefits the learning process and your memory. All of the source code used in this book is available for download at www.wiley.com/go/proc++4e.

Alternatively, you can go to the main Wrox code download page at www.wrox.com/dynamic/books/download.aspx to see the code that is available for this book and all other Wrox books.

NOTE *Because many books have similar titles, you may find it easiest to search by ISBN; for this book, the ISBN is 978-1-119-42130-6.*

Once you've downloaded the code, just decompress it with your favorite decompression tool.

ERRATA

At Wrox, we make every effort to ensure that there are no errors in the text or in the code of our books. However, no one is perfect, and mistakes do occur. If you find an error in one of our books, such as a spelling mistake or faulty piece of code, we would be very grateful for your feedback. By sending in errata, you may save another reader hours of frustration, and at the same time you will be helping us provide even higher-quality information.

To find the errata page for this book, go to www.wrox.com and locate the title by using the Search box or one of the title lists. Then, on the book details page, click the Book Errata link. On this page you can view all errata that has been submitted for this book and posted by Wrox editors. A complete book list, including links to each book's errata, is also available at www.wrox.com/misc-pages/booklist.shtml.

If you don't spot "your" error on the Book Errata page, go to www.wrox.com/contact/techsupport.shtml and complete the form there to send us the error you have found. We'll check the information and, if appropriate, post a message to the book's errata page and fix the problem in subsequent editions of the book.

PART I

Introduction to Professional C++

- ▶ CHAPTER 1: A Crash Course in C++ and the Standard Library
- ▶ CHAPTER 2: Working with Strings and String Views
- ▶ CHAPTER 3: Coding with Style

1

A Crash Course in C++ and the Standard Library

WHAT'S IN THIS CHAPTER?

- ▶ A brief overview of the most important parts and syntax of the C++ language and the Standard Library
- ▶ The basics of smart pointers

WROX.COM DOWNLOADS FOR THIS CHAPTER

Please note that all the code examples for this chapter are available as a part of the chapter's code download on this book's website at www.wrox.com/go/proc++4e on the Download Code tab.

The goal of this chapter is to cover briefly the most important parts of C++ so that you have a base of knowledge before embarking on the rest of this book. This chapter is not a comprehensive lesson in the C++ programming language or the Standard Library. Certain basic points, such as what a program is and what recursion is, are not covered. Esoteric points, such as the definition of a `union`, or the `volatile` keyword, are also omitted. Certain parts of the C language that are less relevant in C++ are also left out, as are parts of C++ that get in-depth coverage in later chapters.

This chapter aims to cover the parts of C++ that programmers encounter every day. For example, if you've been away from C++ for a while and you've forgotten the syntax of a `for` loop, you'll find that syntax in this chapter. Also, if you're fairly new to C++ and don't understand what a reference variable is, you'll learn about that kind of variable here, as well. You'll also learn the basics on how to use the functionality available in the Standard Library, such as `vector` containers, `string` objects, and smart pointers.

If you already have significant experience with C++, skim this chapter to make sure that there aren't any fundamental parts of the language on which you need to brush up. If you're new to C++, read this chapter carefully and make sure you understand the examples. If you need additional introductory information, consult the titles listed in Appendix B.

THE BASICS OF C++

The C++ language is often viewed as a “better C” or a “superset of C.” It was mainly designed to be an object-oriented C, commonly called as “C with classes.” Later on, many of the annoyances and rough edges of the C language were addressed as well. Because C++ is based on C, much of the syntax you'll see in this section will look familiar to you if you are an experienced C programmer. The two languages certainly have their differences, though. As evidence, *The C++ Programming Language* by C++ creator Bjarne Stroustrup (Fourth Edition; Addison-Wesley Professional, 2013) weighs in at 1,368 pages, while Kernighan and Ritchie's *The C Programming Language* (Second Edition; Prentice Hall, 1988) is a scant 274 pages. So, if you're a C programmer, be on the lookout for new or unfamiliar syntax!

The Obligatory Hello, World

In all its glory, the following code is the simplest C++ program you're likely to encounter:

```
// helloworld.cpp
#include <iostream>

int main()
{
    std::cout << "Hello, World!" << std::endl;
    return 0;
}
```

This code, as you might expect, prints the message, “Hello, World!” on the screen. It is a simple program and unlikely to win any awards, but it does exhibit the following important concepts about the format of a C++ program:

- Comments
- Preprocessor directives
- The `main()` function
- I/O streams

These concepts are briefly explained in the following sections.

Comments

The first line of the program is a *comment*, a message that exists for the programmer only and is ignored by the compiler. In C++, there are two ways to delineate a comment. In the preceding and following examples, two slashes indicate that whatever follows on that line is a comment.

```
// helloworld.cpp
```

The same behavior (this is to say, none) would be achieved by using a *multiline comment*. Multiline comments start with `/*` and end with `*/`. The following code shows a multiline comment in action (or, more appropriately, inaction).

```
/* This is a multiline comment.  
   The compiler will ignore it.  
*/
```

Comments are covered in detail in Chapter 3.

Preprocessor Directives

Building a C++ program is a three-step process. First, the code is run through a *preprocessor*, which recognizes meta-information about the code. Next, the code is *compiled*, or translated into machine-readable object files. Finally, the individual object files are *linked* together into a single application.

Directives aimed at the preprocessor start with the `#` character, as in the line `#include <iostream>` in the previous example. In this case, an `#include` directive tells the preprocessor to take everything from the `<iostream>` header file and make it available to the current file. The most common use of header files is to declare functions that will be defined elsewhere. A function *declaration* tells the compiler how a function is called, declaring the number and types of parameters, and the function return type. A *definition* contains the actual code for the function. In C++, declarations usually go into *header files*, typically with extension `.h`, while definitions usually go into *source files*, typically with extension `.cpp`. A lot of other programming languages, such as C# and Java, do not separate declarations and definitions into separate files.

The `<iostream>` header declares the input and output mechanisms provided by C++. If the program did not include that header, it would be unable to perform its only task of outputting text.

NOTE *In C, the names of the Standard Library header files usually end in .h, such as <stdio.h>, and namespaces are not used.*

In C++, the .h suffix is omitted for Standard Library headers, such as <iostream>, and everything is defined in the std namespace or a sub-namespace of std.

The Standard Library headers from C still exist in C++ but in two versions:

- *The new and recommended versions without a .h suffix but with a c prefix. These versions put everything in the std namespace (for example, <cstdio>).*
- *The old versions with the .h suffix. These versions do not use namespaces (for example, <stdio.h>).*

The following table shows some of the most common preprocessor directives.

PREPROCESSOR DIRECTIVE	FUNCTIONALITY	COMMON USES
<code>#include [file]</code>	The specified file is inserted into the code at the location of the directive.	Almost always used to include header files so that code can make use of functionality defined elsewhere.
<code>#define [key] [value]</code>	Every occurrence of the specified key is replaced with the specified value.	Often used in C to define a constant value or a macro. C++ provides better mechanisms for constants and most types of macros. Macros can be dangerous, so use them cautiously. See Chapter 11 for details.
<code>#ifdef [key]</code> <code>#endif</code> <code>#ifndef [key]</code> <code>#endif</code>	Code within the <code>ifdef</code> ("if defined") or <code>ifndef</code> ("if not defined") blocks are conditionally included or omitted based on whether the specified key has been defined with <code>define</code> .	Used most frequently to protect against circular includes. Each header file starts with an <code>ifndef</code> checking the absence of a key, followed by a <code>define</code> directive to define that key. The header file ends with an <code>endif</code> . This prevents the file from being included multiple times; see the example after this table.
<code>#pragma [xyz]</code>	<code>xyz</code> is compiler dependent. It often allows the programmer to display a warning or error if the directive is reached during preprocessing.	See the example after this table.

One example of using preprocessor directives is to avoid multiple includes, as shown here:

```
#ifndef MYHEADER_H
#define MYHEADER_H
// ... the contents of this header file
#endif
```

If your compiler supports the `#pragma once` directive, and most modern compilers do, then this can be rewritten as follows:

```
#pragma once
// ... the contents of this header file
```

Chapter 11 discusses this in more details.

The main() Function

`main()` is, of course, where the program starts. The return type of `main()` is an `int`, indicating the result status of the program. You can omit any explicit return statements in `main()`, in which

case zero is returned automatically. The `main()` function either takes no parameters, or takes two parameters as follows:

```
int main(int argc, char* argv[])
```

`argc` gives the number of arguments passed to the program, and `argv` contains those arguments. Note that `argv[0]` can be the program name, but it might as well be an empty string, so do not rely on it; instead, use platform-specific functionality to retrieve the program name. The important thing to remember is that the actual parameters start at index 1.

I/O Streams

I/O streams are covered in depth in Chapter 13, but the basics of output and input are very simple. Think of an output stream as a laundry chute for data. Anything you toss into it will be output appropriately. `std::cout` is the chute corresponding to the user console, or *standard out*. There are other chutes, including `std::cerr`, which outputs to the error console. The `<<` operator tosses data down the chute. In the preceding example, a quoted string of text is sent to standard out. Output streams allow multiple types of data to be sent down the stream sequentially on a single line of code. The following code outputs text, followed by a number, followed by more text:

```
std::cout << "There are " << 219 << " ways I love you." << std::endl;
```

`std::endl` represents an end-of-line sequence. When the output stream encounters `std::endl`, it will output everything that has been sent down the chute so far and move to the next line. An alternate way of representing the end of a line is by using the `\n` character. The `\n` character is an *escape sequence*, which refers to a new-line character. Escape sequences can be used within any quoted string of text. The following table shows the most common ones:

<code>\n</code>	new line
<code>\r</code>	carriage return
<code>\t</code>	tab
<code>\\</code>	backslash character
<code>\"</code>	quotation mark

Streams can also be used to accept input from the user. The simplest way to do this is to use the `>>` operator with an input stream. The `std::cin` input stream accepts keyboard input from the user. Here is an example:

```
int value;
std::cin >> value;
```

User input can be tricky because you can never know what kind of data the user will enter. See Chapter 13 for a full explanation of how to use input streams.

If you're new to C++ and coming from a C background, you're probably wondering what has been done with the trusty old `printf()` and `scanf()` functions. While these functions can still be used in C++, I recommend using the streams library instead, mainly because the `printf()` and `scanf()` family of functions do not provide any type safety.

Namespaces

Namespaces address the problem of naming conflicts between different pieces of code. For example, you might be writing some code that has a function called `foo()`. One day, you decide to start using a third-party library, which also has a `foo()` function. The compiler has no way of knowing which version of `foo()` you are referring to within your code. You can't change the library's function name, and it would be a big pain to change your own.

Namespaces come to the rescue in such scenarios because you can define the context in which names are defined. To place code in a namespace, enclose it within a namespace block. For example, the following could be the contents of a file called `namespaces.h`:

```
namespace mycode {
    void foo();
}
```

The implementation of a method or function can also be handled in a namespace. The `foo()` function, for instance, could be implemented in `namespaces.cpp` as follows:

```
#include <iostream>
#include "namespaces.h"

void mycode::foo()
{
    std::cout << "foo() called in the mycode namespace" << std::endl;
}
```

Or alternatively:

```
#include <iostream>
#include "namespaces.h"

namespace mycode {
    void foo()
    {
        std::cout << "foo() called in the mycode namespace" << std::endl;
    }
}
```

By placing your version of `foo()` in the namespace “mycode,” you are isolating it from the `foo()` function provided by the third-party library. To call the namespace-enabled version of `foo()`, prepend the namespace onto the function name by using `::`, also called the *scope resolution operator*, as follows:

```
mycode::foo();    // Calls the "foo" function in the "mycode" namespace
```

Any code that falls within a “mycode” namespace block can call other code within the same namespace without explicitly prepending the namespace. This implicit namespace is useful in making the code more readable. You can also avoid prepending of namespaces with the `using` directive. This directive tells the compiler that the subsequent code is making use of names in the specified namespace. The namespace is thus implied for the code that follows:

```
#include "namespaces.h"

using namespace mycode;
```

```
int main()
{
    foo(); // Implies mycode::foo();
    return 0;
}
```

A single source file can contain multiple `using` directives, but beware of overusing this shortcut. In the extreme case, if you declare that you're using every namespace known to humanity, you're effectively eliminating namespaces entirely! Name conflicts will again result if you are using two namespaces that contain the same names. It is also important to know in which namespace your code is operating so that you don't end up accidentally calling the wrong version of a function.

You've seen the namespace syntax before—you used it in the Hello, World program, where `cout` and `endl` are actually names defined in the `std` namespace. You could have written Hello, World with the `using` directive as shown here:

```
#include <iostream>

using namespace std;

int main()
{
    cout << "Hello, World!" << endl;
    return 0;
}
```

A `using` declaration can be used to refer to a particular item within a namespace. For example, if the only part of the `std` namespace that you intend to use is `cout`, you can refer to it as follows:

```
using std::cout;
```

Subsequent code can refer to `cout` without prepending the namespace, but other items in the `std` namespace will still need to be explicit:

```
using std::cout;
cout << "Hello, World!" << std::endl;
```

WARNING *Never put a `using` directive or `using` declaration in a header file; otherwise, you force it on everyone who is including your header file.*

C++17

C++17 makes it easier to work with *nested namespaces*. A nested namespace is a namespace inside another one. Before C++17, you had to use nested namespaces as follows:

```
namespace MyLibraries {
    namespace Networking {
        namespace FTP {
            /* ... */
        }
    }
}
```

This can be simplified a lot with C++17:

```
namespace MyLibraries::Networking::FTP {
    /* ... */
}
```

A *namespace alias* can be used to give a new and possibly shorter name to another namespace. For example: `namespace MyFTP = MyLibraries::Networking::FTP;`

Literals

Literals are used to write numbers or strings in your code. C++ supports a number of standard literals. Numbers can be specified with the following literals (the examples in the list represent the same number, 123):

- Decimal literal, `123`
- Octal literal, `0173`
- Hexadecimal literal, `0x7B`
- Binary literal, `0b1111011`

Other examples of literals in C++ include

- A floating-point value (such as `3.14f`)
- A double floating-point value (such as `3.14`)
- A single character (such as `'a'`)
- A zero-terminated array of characters (such as `"character array"`)

It is also possible to define your own type of literals, which is an advanced feature explained in Chapter 11.

Digits separators can be used in numeric literals. A digits separator is a single quote character. For example,

- `23'456'789`
- `0.123'456f`

C++17 adds support for hexadecimal floating-point literals—for example, `0x3.ABCp-10`, `0xb.cp12l`.

C++17

Variables

In C++, *variables* can be declared just about anywhere in your code and can be used anywhere in the current block below the line where they are declared. Variables can be declared without being given a value. These uninitialized variables generally end up with a semi-random value based on whatever is in memory at that time, and are therefore the source of countless bugs. Variables in C++ can alternatively be assigned an initial value when they are declared. The code that follows shows both flavors of variable declaration, both using `ints`, which represent integer values.

```
int uninitializedInt;
int initializedInt = 7;
cout << uninitializedInt << " is a random value" << endl;
cout << initializedInt << " was assigned an initial value" << endl;
```

NOTE *Most compilers will issue a warning or an error when code is using uninitialized variables. Some compilers will generate code that will report an error at run time.*

The following table shows the most common types used in C++.

TYPE	DESCRIPTION	USAGE
(signed) int signed	Positive and negative integers; the range depends on the compiler (usually 4 bytes).	<code>int i = -7;</code> <code>signed int i = -6;</code> <code>signed i = -5;</code>
(signed) short (int)	Short integer (usually 2 bytes)	<code>short s = 13;</code> <code>short int s = 14;</code> <code>signed short s = 15;</code> <code>signed short int s = 16;</code>
(signed) long (int)	Long integer (usually 4 bytes)	<code>long l = -7L;</code>
(signed) long long (int)	Long long integer; the range depends on the compiler, but is at least the same as for long (usually 8 bytes).	<code>long long ll = 14LL;</code>
unsigned (int) unsigned short (int) unsigned long (int) unsigned long long (int)	Limits the preceding types to values ≥ 0	<code>unsigned int i = 2U;</code> <code>unsigned j = 5U;</code> <code>unsigned short s = 23U;</code> <code>unsigned long l = 5400UL;</code> <code>unsigned long long ll = 140ULL;</code>
float	Floating-point numbers	<code>float f = 7.2f;</code>
double	Double precision numbers; precision is at least the same as for float.	<code>double d = 7.2;</code>
long double	Long double precision numbers; precision is at least the same as for double.	<code>long double d = 16.98L;</code>
char	A single character	<code>char ch = 'm';</code>
char16_t	A single 16-bit character	<code>char16_t c16 = u'm';</code>
char32_t	A single 32-bit character	<code>char32_t c32 = U'm';</code>

continues

(continued)

TYPE	DESCRIPTION	USAGE
<code>wchar_t</code>	A single wide character; the size depends on the compiler.	<code>wchar_t w = L'm';</code>
<code>bool</code>	A Boolean type that can have one of two values: <code>true</code> or <code>false</code>	<code>bool b = true;</code>
<code>std::byte</code> ¹	A single byte. Before C++17, a <code>char</code> or <code>unsigned char</code> was used to represent a byte, but those types make it look like you are working with characters. <code>std::byte</code> on the other hand clearly states your intention, that is, a single byte of memory.	<code>std::byte b{42};</code> ²

C++17

¹Requires an include directive for the `<cstdint>` header file.

²Initialization of an `std::byte` requires direct list initialization with a single-element list. See the “Direct List Initialization versus Copy List Initialization” section later in this chapter for the definition of direct list initialization.

NOTE *C++ does not provide a basic string type. However, a standard implementation of a string is provided as part of the Standard Library, as described later in this chapter and in more detail in Chapter 2.*

Variables can be converted to other types by *casting* them. For example, a `float` can be cast to an `int`. C++ provides three ways to *explicitly* change the type of a variable. The first method is a holdover from C; it is not recommended but unfortunately still commonly used. The second method is rarely used. The third method is the most verbose, but is also the cleanest one, and is therefore recommended.

```
float myFloat = 3.14f;
int i1 = (int)myFloat;           // method 1
int i2 = int(myFloat);          // method 2
int i3 = static_cast<int>(myFloat); // method 3
```

The resulting integer will be the value of the floating-point number with the fractional part truncated. Chapter 11 describes the different casting methods in more detail. In some contexts, variables can be automatically cast, or *coerced*. For example, a `short` can be automatically converted into a `long` because a `long` represents the same type of data with at least the same precision.

```
long someLong = someShort;           // no explicit cast needed
```

When automatically casting variables, you need to be aware of the potential loss of data. For example, casting a `float` to an `int` throws away information (the fractional part of the number). Most compilers will issue a warning or even an error if you assign a `float` to an `int` without an explicit cast. If you are certain that the left-hand side type is fully compatible with the right-hand side type, it's okay to cast implicitly.

Operators

What good is a variable if you don't have a way to change it? The following table shows the most common *operators* used in C++ and sample code that makes use of them. Note that operators in C++ can be *binary* (operate on two expressions), *unary* (operate on a single expression), or even *ternary* (operate on three expressions). There is only one ternary operator in C++, and it is explained in the “Conditional Statements” section later in this chapter.

OPERATOR	DESCRIPTION	USAGE
=	Binary operator to assign the value on the right to the expression on the left	<pre>int i; i = 3; int j; j = i;</pre>
!	Unary operator to complement the true/false (non-0/0) status of an expression	<pre>bool b = !true; bool b2 = !b;</pre>
+	Binary operator for addition	<pre>int i = 3 + 2; int j = i + 5; int k = i + j;</pre>
- * /	Binary operators for subtraction, multiplication, and division	<pre>int i = 5 - 1; int j = 5 * 2; int k = j / i;</pre>
%	Binary operator for the remainder of a division operation. This is also referred to as the <i>mod</i> or <i>modulo</i> operator.	<pre>int remainder = 5 % 2;</pre>
++	Unary operator to increment an expression by 1. If the operator occurs after the expression, or <i>post-increment</i> , the result of the expression is the unincremented value. If the operator occurs before the expression, or <i>pre-increment</i> , the result of the expression is the new value.	<pre>i++; ++i;</pre>
--	Unary operator to decrement an expression by 1	<pre>i--; --i;</pre>
+=	Shorthand syntax for <code>i = i + j</code>	<pre>i += j;</pre>
-- *= /=	Shorthand syntax for	<pre>i -= j; i *= j; i /= j;</pre>
%=		<pre>i %= j;</pre>
		<pre>i = i % j;</pre>

continues

(continued)

OPERATOR	DESCRIPTION	USAGE
& &=	Takes the raw bits of one expression and performs a bitwise “AND” with the other expression	<code>i = j & k;</code> <code>j &= k;</code>
 =	Takes the raw bits of one expression and performs a bitwise “OR” with the other expression	<code>i = j k;</code> <code>j = k;</code>
<< >> <<= >>=	Takes the raw bits of an expression and “shifts” each bit left (<<) or right (>>) the specified number of places	<code>i = i << 1;</code> <code>i = i >> 4;</code> <code>i <<= 1;</code> <code>i >>= 4;</code>
^ ^=	Performs a bitwise “exclusive or,” also called “XOR” operation, on two expressions	<code>i = i ^ j;</code> <code>i ^= j;</code>

The following program shows the most common variable types and operators in action. If you are unsure about how variables and operators work, try to figure out what the output of this program will be, and then run it to confirm your answer.

```
int someInteger = 256;
short someShort;
long someLong;
float someFloat;
double someDouble;

someInteger++;
someInteger *= 2;
someShort = static_cast<short>(someInteger);
someLong = someShort * 10000;
someFloat = someLong + 0.785f;
someDouble = static_cast<double>(someFloat) / 100000;
cout << someDouble << endl;
```

The C++ compiler has a recipe for the order in which expressions are evaluated. If you have a complicated line of code with many operators, the order of execution may not be obvious. For that reason, it’s probably better to break up a complicated expression into several smaller expressions, or explicitly group sub-expressions by using parentheses. For example, the following line of code is confusing unless you happen to know the C++ operator precedence table by heart:

```
int i = 34 + 8 * 2 + 21 / 7 % 2;
```

Adding parentheses makes it clear which operations are happening first:

```
int i = 34 + (8 * 2) + ( (21 / 7) % 2 );
```

For those of you playing along at home, both approaches are equivalent and end up with `i` equal to 51. If you assumed that C++ evaluated expressions from left to right, your answer would have been 1. C++ evaluates `/`, `*`, and `%` first (in left-to-right order), followed by addition and subtraction, then bitwise operators. Parentheses let you explicitly tell the compiler that a certain operation should be evaluated separately.

Types

In C++, you can use the basic types (`int`, `bool`, and so on) to build more complex types of your own design. Once you are an experienced C++ programmer, you will rarely use the following techniques, which are features brought in from C, because classes are far more powerful. Still, it is important to know about the following ways of building types so that you will recognize the syntax.

Enumerated Types

An integer really represents a value within a sequence—the sequence of numbers. *Enumerated types* let you define your own sequences so that you can declare variables with values in that sequence. For example, in a chess program, you *could* represent each piece as an `int`, with constants for the piece types, as shown in the following code. The integers representing the types are marked `const` to indicate that they can never change.

```
const int PieceTypeKing = 0;
const int PieceTypeQueen = 1;
const int PieceTypeRook = 2;
const int PieceTypePawn = 3;
//etc.
int myPiece = PieceTypeKing;
```

This representation is fine, but it can become dangerous. Since a piece is just an `int`, what would happen if another programmer added code to increment the value of a piece? By adding 1, a king becomes a queen, which really makes no sense. Worse still, someone could come in and give a piece a value of -1, which has no corresponding constant.

Enumerated types solve these problems by tightly defining the range of values for a variable. The following code declares a new type, `PieceType`, which has four possible values, representing four of the chess pieces:

```
enum PieceType { PieceTypeKing, PieceTypeQueen, PieceTypeRook, PieceTypePawn };
```

Behind the scenes, an enumerated type is just an integer value. The real value of `PieceTypeKing` is 0. However, by defining the possible values for variables of type `PieceType`, your compiler can give you a warning or an error if you attempt to perform arithmetic on `PieceType` variables or treat them as integers. The following code, which declares a `PieceType` variable, and then attempts to use it as an integer, results in a warning or an error on most compilers:

```
PieceType myPiece;
myPiece = 0;
```

It's also possible to specify the integer values for members of an enumeration. The syntax is as follows:

```
enum PieceType { PieceTypeKing = 1, PieceTypeQueen, PieceTypeRook = 10, PieceTypePawn };
```

In this example, `PieceTypeKing` has the integer value 1, `PieceTypeQueen` has the value 2 assigned by the compiler, `PieceTypeRook` has the value 10, and `PieceTypePawn` has the value 11 assigned automatically by the compiler.

If you do not assign a value to an enumeration member, the compiler automatically assigns it a value that is the previous enumeration member incremented by 1. If you do not assign a value to the first enumeration member yourself, the compiler assigns it the value 0.

Strongly Typed Enumerations

Enumerations as explained in the previous section are not strongly typed, meaning they are not *type safe*. They are always interpreted as integers, and thus you can compare enumeration values from completely different enumeration types.

The strongly-typed `enum class` enumerations solve this problem. For example, the following defines a type-safe version of the earlier-defined `PieceType` enumeration:

```
enum class PieceType
{
    King = 1,
    Queen,
    Rook = 10,
    Pawn
};
```

For an `enum class`, the enumeration value names are not automatically exported to the enclosing scope, which means that you always have to use the scope resolution operator:

```
PieceType piece = PieceType::King;
```

This also means that you can give shorter names to the enumeration values, for example, `King` instead of `PieceTypeKing`.

Additionally, the enumeration values are not automatically converted to integers, which means the following is illegal:

```
if (PieceType::Queen == 2) {...}
```

By default, the underlying type of an enumeration value is an integer, but this can be changed as follows:

```
enum class PieceType : unsigned long
{
    King = 1,
    Queen,
    Rook = 10,
    Pawn
};
```

NOTE *It is recommended to use the strongly-typed `enum class` enumerations instead of the type-unsafe `enum` enumerations.*

Structs

Structs let you encapsulate one or more existing types into a new type. The classic example of a struct is a database record. If you are building a personnel system to keep track of employee

information, you might want to store the first initial, last initial, employee number, and salary for each employee. A struct that contains all of this information is shown in the `employeestruct.h` header file that follows:

```
struct Employee {
    char firstInitial;
    char lastInitial;
    int  employeeNumber;
    int  salary;
};
```

A variable declared with type `Employee` will have all of these *fields* built in. The individual fields of a struct can be accessed by using the “.” operator. The example that follows creates and then outputs the record for an employee:

```
#include <iostream>
#include "employeestruct.h"

using namespace std;

int main()
{
    // Create and populate an employee.
    Employee anEmployee;
    anEmployee.firstInitial = 'M';
    anEmployee.lastInitial = 'G';
    anEmployee.employeeNumber = 42;
    anEmployee.salary = 80000;
    // Output the values of an employee.
    cout << "Employee: " << anEmployee.firstInitial <<
        anEmployee.lastInitial << endl;
    cout << "Number: " << anEmployee.employeeNumber << endl;
    cout << "Salary: $" << anEmployee.salary << endl;
    return 0;
}
```

Conditional Statements

Conditional statements let you execute code based on whether or not something is true. As shown in the following sections, there are three main types of conditional statements in C++: *if/else* statements, *switch* statements, and *conditional operators*.

if/else Statements

The most common conditional statement is the `if` statement, which can be accompanied by an `else`. If the condition given inside the `if` statement is true, the line or block of code is executed. If not, execution continues with the `else` case if present, or with the code following the conditional statement. The following code shows a *cascading if statement*, a fancy way of saying that the `if` statement has an `else` statement that in turn has another `if` statement, and so on:

```
if (i > 4) {
    // Do something.
} else if (i > 2) {
```

```

    // Do something else.
} else {
    // Do something else.
}

```

The expression between the parentheses of an `if` statement must be a Boolean value or evaluate to a Boolean value. A value of 0 evaluates to `false`, while any non-zero value evaluates to `true`. For example: `if(0)` is equivalent to `if(false)`. Logical evaluation operators, described later, provide ways of evaluating expressions to result in a `true` or `false` Boolean value.

C++17

Initializers for `if` Statements

C++17 allows you to include an initializer inside an `if` statement using the following syntax:

```
if (<initializer> ; <conditional_expression>) { <body> }
```

Any variable introduced in the `<initializer>` is only available in the `<conditional_expression>` and in the `<body>`. Such variables are not available outside the `if` statement.

It is too early in this book to give a useful example of this feature, but here is what it looks like:

```
if (Employee employee = GetEmployee() ; employee.salary > 1000) { ... }
```

In this example, the initializer gets an employee and the condition checks whether the salary of the retrieved employee exceeds 1000. Only in that case is the body of the `if` statement executed.

More concrete examples will be given throughout this book.

`switch` Statements

The `switch` statement is an alternate syntax for performing actions based on the value of an expression. In C++, the expression of a `switch` statement must be of an integral type, a type convertible to an integral type, an enumerated type, or a strongly typed enumeration, and must be compared to constants. Each constant value represents a “case.” If the expression matches the case, the subsequent lines of code are executed until a `break` statement is reached. You can also provide a `default` case, which is matched if none of the other cases match. The following pseudocode shows a common use of the `switch` statement:

```

switch (menuItem) {
    case OpenMenuItem:
        // Code to open a file
        break;
    case SaveMenuItem:
        // Code to save a file
        break;
    default:
        // Code to give an error message
        break;
}

```

A `switch` statement can always be converted into `if/else` statements. The previous `switch` statement can be converted as follows:

```

if (menuItem == OpenMenuItem) {
    // Code to open a file
}

```

```

    } else if (menuItem == SaveMenuItem) {
        // Code to save a file
    } else {
        // Code to give an error message
    }
}

```

switch statements are generally used when you want to do something based on more than 1 specific value of an expression, as opposed to some test on the expression. In such a case, the switch statement avoids cascading if-else statements. If you only need to inspect 1 value, an if or if-else statement is fine.

Once a case expression matching the switch condition is found, all statements that follow it are executed until a break statement is reached. This execution continues even if another case expression is encountered, which is called *fallthrough*. The following example has a single set of statements that is executed for several different cases:

```

switch (backgroundColor) {
    case Color::DarkBlue:
    case Color::Black:
        // Code to execute for both a dark blue or black background color
        break;
    case Color::Red:
        // Code to execute for a red background color
        break;
}

```

C++17

Fallthrough can be a source of bugs, for example if you accidentally forget a break statement. Because of this, compilers might give a warning if a fallthrough is detected in a switch statement, unless the case is empty as in the above example. Starting with C++17, you can tell the compiler that a fallthrough is intentional using the `[[fallthrough]]` attribute as follows:

```

switch (backgroundColor) {
    case Color::DarkBlue:
        doSomethingForDarkBlue();
        [[fallthrough]];
    case Color::Black:
        // Code is executed for both a dark blue or black background color
        doSomethingForBlackOrDarkBlue();
        break;
    case Color::Red:
    case Color::Green:
        // Code to execute for a red or green background color
        break;
}

```

C++17

Initializers for switch Statements

Just as for if statements, C++17 adds support for initializers to switch statements. The syntax is as follows:

```

switch (<initializer> ; <expression>) { <body> }

```

Any variables introduced in the <initializer> are only available in the <expression> and in the <body>. They are not available outside the switch statement.

The Conditional Operator

C++ has one operator that takes three arguments, known as a *ternary operator*. It is used as a shorthand conditional expression of the form “if [*something*] then [*perform action*], otherwise [*perform some other action*].” The conditional operator is represented by a `?` and a `:`. The following code outputs “yes” if the variable `i` is greater than 2, and “no” otherwise:

```
std::cout << ((i > 2) ? "yes" : "no");
```

The parentheses around `i > 2` are optional, so the following is equivalent:

```
std::cout << (i > 2 ? "yes" : "no");
```

The advantage of the conditional operator is that it can occur within almost any context. In the preceding example, the conditional operator is used within code that performs output. A convenient way to remember how the syntax is used is to treat the question mark as though the statement that comes before it really is a question. For example, “Is `i` greater than 2? If so, the result is ‘yes’; if not, the result is ‘no.’”

Unlike an `if` statement or a `switch` statement, the conditional operator doesn’t execute code blocks based on the result. Instead, it is used *within* code, as shown in the preceding example. In this way, it really is an operator (like `+` and `-`) as opposed to a true conditional statement, such as `if` and `switch`.

Logical Evaluation Operators

You have already seen a *logical evaluation operator* without a formal definition. The `>` operator compares two values. The result is “true” if the value on the left is greater than the value on the right. All logical evaluation operators follow this pattern—they all result in a `true` or `false`.

The following table shows common logical evaluation operators:

OP	DESCRIPTION	USAGE
<code><</code> <code><=</code> <code>></code> <code>>=</code>	Determines if the left-hand side is less than, less than or equal to, greater than, or greater than or equal to the right-hand side	<pre>if (i < 0) { std::cout << "i is negative"; }</pre>
<code>==</code>	Determines if the left-hand side equals the right-hand side. Don’t confuse this with the <code>=</code> (assignment) operator!	<pre>if (i == 3) { std::cout << "i is 3"; }</pre>
<code>!=</code>	Not equals. The result of the statement is true if the left-hand side does <i>not</i> equal the right-hand side.	<pre>if (i != 3) { std::cout << "i is not 3"; }</pre>

OP	DESCRIPTION	USAGE
!	Logical NOT. This complements the true/false status of a Boolean expression. This is a unary operator.	<pre>if (!someBoolean) { std::cout << "someBoolean is false"; }</pre>
&&	Logical AND. The result is true if both parts of the expression are true.	<pre>if (someBoolean && someOtherBoolean) { std::cout << "both are true"; }</pre>
	Logical OR. The result is true if either part of the expression is true.	<pre>if (someBoolean someOtherBoolean) { std::cout << "at least one is true"; }</pre>

C++ uses *short-circuit logic* when evaluating logical expressions. That means that once the final result is certain, the rest of the expression won't be evaluated. For example, if you are performing a logical OR operation of several Boolean expressions, as shown in the following code, the result is known to be `true` as soon as one of them is found to be `true`. The rest won't even be checked.

```
bool result = bool1 || bool2 || (i > 7) || (27 / 13 % i + 1) < 2;
```

In this example, if `bool1` is found to be `true`, the entire expression must be `true`, so the other parts aren't evaluated. In this way, the language saves your code from doing unnecessary work. It can, however, be a source of hard-to-find bugs if the later expressions in some way influence the state of the program (for example, by calling a separate function). The following code shows a statement using `&&` that short-circuits after the second term because `0` always evaluates to `false`:

```
bool result = bool1 && 0 && (i > 7) && !done;
```

Short-circuiting can be beneficial for performance. You can put cheaper tests first so that more expensive tests are not even executed when the logic short-circuits. It is also useful in the context of pointers to avoid parts of the expression to be executed when a pointer is not valid. Pointers and short-circuiting with pointers are discussed later in this chapter.

Functions

For programs of any significant size, placing all the code inside of `main()` is unmanageable. To make programs easy to understand, you need to break up, or *decompose*, code into concise functions.

In C++, you first declare a function to make it available for other code to use. If the function is used inside only a particular file, you generally declare and define the function in the source file. If the function is for use by other modules or files, you generally put the declaration in a header file and the definition in a source file.

NOTE Function declarations *are often called* function prototypes or function headers *to emphasize that they represent how the function can be accessed, but not the code behind it. The term* function signature *is used to denote the combination of the function name and its parameter list, but without the return type.*

A function declaration is shown in the following code. This example has a return type of `void`, indicating that the function does not provide a result to the caller. The caller must provide two arguments for the function to work with—an integer and a character.

```
void myFunction(int i, char c);
```

Without an actual definition to match this function declaration, the link stage of the compilation process will fail because code that makes use of the function will be calling nonexistent code. The following definition prints the values of the two parameters:

```
void myFunction(int i, char c)
{
    std::cout << "the value of i is " << i << std::endl;
    std::cout << "the value of c is " << c << std::endl;
}
```

Elsewhere in the program, you can make calls to `myFunction()` and pass in arguments for the two parameters. Some sample function calls are shown here:

```
myFunction(8, 'a');
myFunction(someInt, 'b');
myFunction(5, someChar);
```

NOTE *In C++, unlike C, a function that takes no parameters just has an empty parameter list. It is not necessary to use* `void` *to indicate that no parameters are taken. However, you must still use* `void` *to indicate when no value is returned.*

C++ functions can also *return* a value to the caller. The following function adds two numbers and returns the result:

```
int addNumbers(int number1, int number2)
{
    return number1 + number2;
}
```

This function can be called as follows:

```
int sum = addNumbers(5, 3);
```

Function Return Type Deduction

With C++14, you can ask the compiler to figure out the return type of a function automatically. To make use of this functionality, you need to specify `auto` as the return type:

```
auto addNumbers(int number1, int number2)
{
    return number1 + number2;
}
```

The compiler deduces the return type based on the expressions used for the `return` statements. There can be multiple `return` statements in the function, but they should all resolve to the same type. Such a function can even include recursive calls (calls to itself), but the first `return` statement in the function must be a non-recursive call.

Current Function's Name

Every function has a local predefined variable `__func__` containing the name of the current function. One use of this variable would be for logging purposes:

```
int addNumbers(int number1, int number2)
{
    std::cout << "Entering function " << __func__ << std::endl;
    return number1 + number2;
}
```

C-Style Arrays

Arrays hold a series of values, all of the same type, each of which can be accessed by its position in the array. In C++, you must provide the size of the array when the array is declared. You cannot give a variable as the size—it must be a constant, or a *constant expression* (*constexpr*). Constant expressions are discussed in Chapter 11. The code that follows shows the declaration of an array of three integers followed by three lines to initialize the elements to 0:

```
int myArray[3];
myArray[0] = 0;
myArray[1] = 0;
myArray[2] = 0;
```

WARNING *In C++, the first element of an array is always at position 0, not position 1! The last position of the array is always the size of the array minus 1!*

The next section discusses loops that you can use to initialize each element. However, instead of using loops, or using the previous initialization mechanism, you can also accomplish the *zero-initialization* with the following one-liner:

```
int myArray[3] = {0};
```

You can even drop the 0 as follows:

```
int myArray[3] = {};
```

An array can also be initialized with an initializer list, in which case the compiler can deduce the size of the array automatically. For example,

```
int myArray[] = {1, 2, 3, 4}; // The compiler creates an array of 4 elements.
```

If you do specify the size of the array, and the initializer list has less elements than the given size, the remaining elements are set to 0. For example, the following code only sets the first element in the array to the value 2, and sets all the other elements to 0:

```
int myArray[3] = {2};
```

To get the size of a stack-based C-style array, you can use the C++17 `std::size()` function (requires `<array>`). For example:

```
unsigned int arraySize = std::size(myArray);
```

If your compiler is not yet C++17 compliant, the old trick to get the size of a stack-based C-style array is to use the `sizeof` operator. The `sizeof` operator returns the size of its argument in bytes. To get the number of elements in a stack-based array, you divide the size in bytes of the array by the size in bytes of the first element. For example:

```
unsigned int arraySize = sizeof(myArray) / sizeof(myArray[0]);
```

The preceding examples show a one-dimensional array, which you can think of as a line of integers, each with its own numbered compartment. C++ allows multi-dimensional arrays. You might think of a two-dimensional array as a checkerboard, where each location has a position along the x-axis and a position along the y-axis. Three-dimensional and higher arrays are harder to picture and are rarely used. The following code shows the syntax for allocating a two-dimensional array of characters for a Tic-Tac-Toe board and then putting an “o” in the center square:

```
char ticTacToeBoard[3][3];
ticTacToeBoard[1][1] = 'o';
```

Figure 1-1 shows a visual representation of this board with the position of each square.

TicTacToeBoard[0][0]	TicTacToeBoard[0][1]	TicTacToeBoard[0][2]
TicTacToeBoard[1][0]	TicTacToeBoard[1][1]	TicTacToeBoard[1][2]
TicTacToeBoard[2][0]	TicTacToeBoard[2][1]	TicTacToeBoard[2][2]

FIGURE 1-1

NOTE *In C++, it's best to avoid C-style arrays as discussed in this section, and instead use Standard Library functionality, such as `std::array`, and `std::vector`, as discussed in the next two sections.*

std::array

The arrays discussed in the previous section come from C, and still work in C++. However, C++ has a special type of fixed-size container called `std::array`, defined in the `<array>` header file. It's basically a thin wrapper around C-style arrays.

There are a number of advantages to using `std::array`s instead of C-style arrays. They always know their own size, are not automatically cast to a pointer to avoid certain types of bugs, and have iterators to easily loop over the elements. Iterators are discussed in detail in Chapter 17.

The following example demonstrates how to use the `array` container. The use of angle brackets after `array`, as in `array<int, 3>`, will become clear during the discussion of templates in Chapter 12. However, for now, just remember that you have to specify two parameters between the angle brackets. The first parameter represents the type of the elements in the array, and the second one represents the size of the array.

```
array<int, 3> arr = {9, 8, 7};
cout << "Array size = " << arr.size() << endl;
cout << "2nd element = " << arr[1] << endl;
```

NOTE *Both the C-style arrays and the `std::array`s have a fixed size, which must be known at compile time. They cannot grow or shrink at run time.*

If you want an array with a dynamic size, it is recommended to use `std::vector`, as explained in the next section. A `vector` automatically increases in size when you add new elements to it.

std::vector

The C++ Standard Library provides a number of different non-fixed-size containers that can be used to store information. `std::vector`, declared in `<vector>`, is an example of such a container. The `vector` replaces the concept of C-style arrays with a much more flexible and safer mechanism. As a user, you need not worry about memory management, as the `vector` automatically allocates enough memory to hold its elements. A `vector` is dynamic, meaning that elements can be added and removed at run time. Chapter 17 goes into more detail regarding containers, but the basic use of a `vector` is straightforward, which is why it's introduced in the beginning of this book so that it can be used in examples. The following code demonstrates the basic functionality of `vector`.

```
// Create a vector of integers
vector<int> myVector = { 11, 22 };

// Add some more integers to the vector using push_back()
myVector.push_back(33);
myVector.push_back(44);

// Access elements
cout << "1st element: " << myVector[0] << endl;
```

`myVector` is declared as `vector<int>`. The angle brackets are required to specify the template parameters, just as with `std::array`. A `vector` is a generic container. It can contain almost any kind of object; that's why you have to specify the type of object you want in your `vector` between the angle brackets. Templates are discussed in detail in Chapters 12 and 22.

To add elements to a `vector`, you can use the `push_back()` method. Individual elements can be accessed using a similar syntax as for arrays, i.e. `operator[]`.

C++17

Structured Bindings

C++17 introduces the concept of *structured bindings*. Structured bindings allow you to declare multiple variables that are initialized with elements from an array, struct, pair, or tuple.

For example, assume you have the following array:

```
std::array<int, 3> values = { 11, 22, 33 };
```

You can declare three variables, `x`, `y`, and `z`, initialized with the three values from the array as follows. Note that you have to use the `auto` keyword for structured bindings. You cannot, for example, specify `int` instead of `auto`.

```
auto [x, y, z] = values;
```

The number of variables declared with the structured binding has to match the number of values in the expression on the right.

Structured bindings also work with structures if all non-static members are public. For example,

```
struct Point { double mX, mY, mZ; };
Point point;
point.mX = 1.0; point.mY = 2.0; point.mZ = 3.0;
auto [x, y, z] = point;
```

Examples with `std::pair` and `std::tuple` are given in chapters 17 and 20 respectively.

Loops

Computers are great for doing the same thing over and over. C++ provides four looping mechanisms: the `while` loop, `do/while` loop, `for` loop, and *range-based* `for` loop.

The while Loop

The `while` loop lets you perform a block of code repeatedly as long as an expression evaluates to `true`. For example, the following completely silly code will output “This is silly.” five times:

```
int i = 0;
while (i < 5) {
    std::cout << "This is silly." << std::endl;
    ++i;
}
```

The keyword `break` can be used within a loop to immediately get out of the loop and continue execution of the program. The keyword `continue` can be used to return to the top of the loop and reevaluate the `while` expression. However, using `continue` in loops is often considered poor style because it causes the execution of a program to jump around somewhat haphazardly, so use it sparingly.

The do/while Loop

C++ also has a variation on the `while` loop called `do/while`. It works similarly to the `while` loop, except that the code to be executed comes first, and the conditional check for whether or not to continue happens at the end. In this way, you can use a loop when you want a block of code to always be executed at least once and possibly additional times based on some condition. The example that follows outputs the statement, “This is silly.” once, even though the condition ends up being false:

```
int i = 100;
do {
    std::cout << "This is silly." << std::endl;
    ++i;
} while (i < 5);
```

The for Loop

The `for` loop provides another syntax for looping. Any `for` loop can be converted to a `while` loop and vice versa. However, the `for` loop syntax is often more convenient because it looks at a loop in terms of a starting expression, an ending condition, and a statement to execute at the end of every iteration. In the following code, `i` is initialized to 0; the loop continues as long as `i` is less than 5; and at the end of every iteration, `i` is incremented by 1. This code does the same thing as the `while` loop example, but is more readable because the starting value, ending condition, and per-iteration statement are all visible on one line.

```
for (int i = 0; i < 5; ++i) {
    std::cout << "This is silly." << std::endl;
}
```

The Range-Based for Loop

The *range-based* `for` loop is the fourth looping mechanism. It allows for easy iteration over elements of a container. This type of loop works for C-style arrays, initializer lists (discussed later in this chapter), and any type that has `begin()` and `end()` methods returning iterators (see Chapter 17), such as `std::array`, `std::vector`, and all other Standard Library containers discussed in Chapter 17.

The following example first defines an array of four integers. The range-based `for` loop then iterates over a *copy* of every element in this array and prints each value. To iterate over the elements themselves *without making copies*, use a reference variable, as I discuss later in this chapter.

```
std::array<int, 4> arr = {1, 2, 3, 4};
for (int i : arr) {
    std::cout << i << std::endl;
}
```

Initializer Lists

Initializer lists are defined in the `<initializer_list>` header file and make it easy to write functions that can accept a variable number of arguments. The `initializer_list` class is a template and so it requires you to specify the type of elements in the list between angle brackets, similar to how you have to specify the type of object stored in a `vector`. The following example shows how to use an initializer list:

```
#include <initializer_list>

using namespace std;

int makeSum(initializer_list<int> lst)
{
    int total = 0;
    for (int value : lst) {
        total += value;
    }
    return total;
}
```

The function `makeSum()` accepts an initializer list of integers as argument. The body of the function uses a range-based `for` loop to accumulate the total sum. This function can be used as follows:

```
int a = makeSum({1,2,3});
int b = makeSum({10,20,30,40,50,60});
```

Initializer lists are type safe and define which type is allowed to be in the list. For the `makeSum()` function shown here, all elements of the initializer list must be integers. Trying to call it with a `double` results in a compiler error or warning, as shown here:

```
int c = makeSum({1,2,3.0});
```

Those Are the Basics

At this point, you have reviewed the basic essentials of C++ programming. If this section was a breeze, skim the next section to make sure that you are up to speed on the more-advanced material. If you struggled with this section, you may want to obtain one of the fine introductory C++ books mentioned in Appendix B before continuing.

DIVING DEEPER INTO C++

Loops, variables, and conditionals are terrific building blocks, but there is much more to learn. The topics covered next include many features designed to help C++ programmers with their code as well as a few features that are often more confusing than helpful. If you are a C programmer with little C++ experience, you should read this section carefully.

Strings in C++

There are three ways to work with strings of text in C++: the C-style, which represents strings as arrays of characters; the C++ style, which wraps that representation in an easier-to-use string type; and the general class of nonstandard approaches. Chapter 2 provides a detailed discussion.

For now, the only thing you need to know is that the C++ `string` type is defined in the `<string>` header file, and that you can use a C++ `string` almost like a basic type. Just like I/O streams, the `string` type lives in the `std` namespace. The following example shows that strings can be used just like character arrays:

```
string myString = "Hello, World";
cout << "The value of myString is " << myString << endl;
cout << "The second letter is " << myString[1] << endl;
```

Pointers and Dynamic Memory

Dynamic memory allows you to build programs with data that is not of fixed size at compile time. Most nontrivial programs make use of dynamic memory in some form.

The Stack and the Heap

Memory in your C++ application is divided into two parts—the *stack* and the *heap*. One way to visualize the stack is as a deck of cards. The current top card represents the current scope of the program, usually the function that is currently being executed. All variables declared inside the current function will take up memory in the top stack frame, the top card of the deck. If the current function, which I'll call `foo()`, calls another function `bar()`, a new card is put on the deck so that `bar()` has its own *stack frame* to work with. Any parameters passed from `foo()` to `bar()` are copied from the `foo()` stack frame into the `bar()` stack frame. Figure 1-2 shows what the stack might look like during the execution of a hypothetical function `foo()` that has declared two integer values.

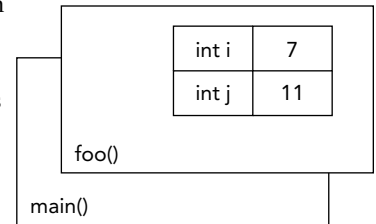

FIGURE 1-2

Stack frames are nice because they provide an isolated memory workspace for each function. If a variable is declared inside the `foo()` stack frame, calling the `bar()` function won't change it unless you specifically tell it to. Also, when the `foo()` function is done running, the stack frame goes away, and all of the variables declared within the function no longer take up memory. Variables that are stack-allocated do not need to be deallocated (deleted) by the programmer; it happens automatically.

The *heap* is an area of memory that is completely independent of the current function or stack frame. You can put variables on the heap if you want them to exist even when the function in which they were created has completed. The heap is less structured than the stack. You can think of it as just a pile of bits. Your program can add new bits to the pile at any time or modify bits that are already in the pile. You have to make sure that you deallocate (delete) any memory that you allocated on the heap. This does not happen automatically, unless you use smart pointers, which are discussed in the section “Smart Pointers.”

Working with Pointers

You can put anything on the heap by explicitly allocating memory for it. For example, to put an integer on the heap, you need to allocate memory for it, but first you need to declare a *pointer*:

```
int* myIntegerPointer;
```

The `*` after the `int` type indicates that the variable you are declaring refers or points to some integer memory. Think of the pointer as an arrow that points at the dynamically allocated heap memory. It does not yet point to anything specific because you haven't assigned it to anything; it is an *uninitialized variable*. Uninitialized variables should be avoided at all times, and especially uninitialized pointers because they point to some random place in memory. Working with such pointers will most likely make your program crash. That's why you should always declare and initialize your pointers at the same time. You can initialize them to a null pointer (`nullptr`—for more information, see the “Null Pointer Constant” section) if you don't want to allocate memory right away:

```
int* myIntegerPointer = nullptr;
```

A null pointer is a special default value that no valid pointer will ever have, and converts to `false` when used in a Boolean expression. For example:

```
if (!myIntegerPointer) { /* myIntegerPointer is a null pointer */ }
```

You use the `new` operator to allocate the memory:

```
myIntegerPointer = new int;
```

In this case, the pointer points to the address of just a single integer value. To access this value, you need to *dereference* the pointer. Think of dereferencing as following the pointer's arrow to the actual value on the heap. To set the value of the newly allocated heap integer, you would use code like the following:

```
*myIntegerPointer = 8;
```

Notice that this is not the same as setting `myIntegerPointer` to the value 8. You are not changing the pointer; you are changing the memory that it points to. If you were to reassign the pointer value, it would point to the memory address 8, which is probably random garbage that will eventually make your program crash.

After you are finished with your dynamically allocated memory, you need to deallocate the memory using the `delete` operator. To prevent the pointer from being used after having deallocated the memory it points to, it's recommended to set your pointer to `nullptr`:

```
delete myIntegerPointer;  
myIntegerPointer = nullptr;
```

WARNING *A pointer must be valid before it is dereferenced. Dereferencing a null pointer or an uninitialized pointer causes undefined behavior. Your program might crash, but it might just as well keep running and start giving strange results.*

Pointers don't always point to heap memory. You can declare a pointer that points to a variable on the stack, even another pointer. To get a pointer to a variable, you use the `&` ("address of") operator:

```
int i = 8;
int* myIntegerPointer = &i; // Points to the variable with the value 8
```

C++ has a special syntax for dealing with pointers to structures. Technically, if you have a pointer to a structure, you can access its fields by first dereferencing it with `*`, then using the normal syntax, as in the code that follows, which assumes the existence of a function called `getEmployee()`.

```
Employee* anEmployee = getEmployee();
cout << (*anEmployee).salary << endl;
```

This syntax is a little messy. The `->` (arrow) operator lets you perform both the dereference and the field access in one step. The following code is equivalent to the preceding code, but is easier to read:

```
Employee* anEmployee = getEmployee();
cout << anEmployee->salary << endl;
```

Remember the concept of short-circuiting logic, which was discussed earlier in this chapter? This can be useful in combination with pointers to avoid using an invalid pointer, as in the following example:

```
bool isValidSalary = (anEmployee && anEmployee->salary > 0);
```

Or, a little bit more verbose:

```
bool isValidSalary = (anEmployee != nullptr && anEmployee->salary > 0);
```

`anEmployee` is only dereferenced to get the salary if it is a valid pointer. If it is a null pointer, the logical operation short-circuits, and the `anEmployee` pointer is not dereferenced.

Dynamically Allocated Arrays

The heap can also be used to dynamically allocate arrays. You use the `new[]` operator to allocate memory for an array.

```
int arraySize = 8;
int* myVariableSizedArray = new int[arraySize];
```

This allocates memory for enough integers to satisfy the `arraySize` variable. Figure 1-3 shows what the stack and the heap both look like after this code is executed. As you can see, the pointer variable still resides on the stack, but the array that was dynamically created lives on the heap.

Now that the memory has been allocated, you can work with `myVariableSizedArray` as though it were a regular stack-based array.

```
myVariableSizedArray[3] = 2;
```

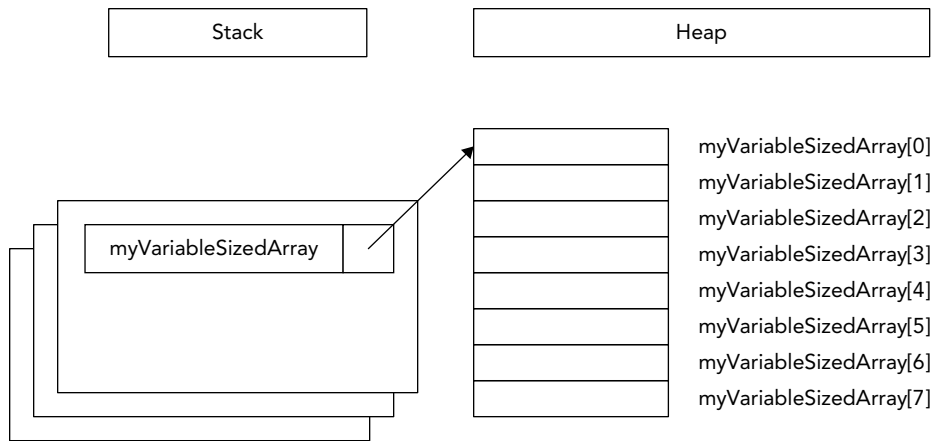

FIGURE 1-3

When your code is done with the array, it should remove the array from the heap so that other variables can use the memory. In C++, you use the `delete[]` operator to do this.

```
delete[] myVariableSizedArray;
myVariableSizedArray = nullptr;
```

The brackets after `delete` indicate that you are deleting an array!

NOTE Avoid using `malloc()` and `free()` from C. Instead, use `new` and `delete`, or `new[]` and `delete[]`.

WARNING To prevent memory leaks, every call to `new` should be paired with a call to `delete`, and every call to `new[]` should be paired with a call to `delete[]`. Not calling `delete` or `delete[]`, or mismatching calls, results in memory leaks. Memory leaks are discussed in Chapter 7.

Null Pointer Constant

Before C++11, the constant `NULL` was used for null pointers. `NULL` is simply defined as the constant `0`, and this can cause problems. Take the following example:

```
void func(char* str) {cout << "char* version" << endl;}
void func(int i) {cout << "int version" << endl;}

int main()
{
    func(NULL);
    return 0;
}
```

The `main()` function is calling `func()` with parameter `NULL`, which is supposed to be a null pointer constant. In other words, you are expecting the `char*` version of `func()` to be called with a null pointer as argument. However, since `NULL` is not a pointer, but identical to the integer 0, the integer version of `func()` is called.

This problem is solved with the introduction of a real null pointer constant, `nullptr`. The following code calls the `char*` version:

```
func(nullptr);
```

Smart Pointers

To avoid common memory problems, you should use *smart pointers* instead of “raw,” also called “naked,” C-style pointers. Smart pointers automatically deallocate memory when the smart pointer object goes out of scope, for example, when the function has finished executing.

The following are the two most important smart pointer types in C++, both defined in `<memory>` and in the `std` namespace:

- `std::unique_ptr`
- `std::shared_ptr`

`unique_ptr` is analogous to an ordinary pointer, except that it automatically frees the memory or resource when the `unique_ptr` goes out of scope or is deleted. As such, `unique_ptr` has sole ownership of the object pointed to. One advantage of a `unique_ptr` is that memory and resources are always freed, even when return statements are executed, or when exceptions (discussed later in this chapter) are thrown. This, for example, simplifies coding when a function has multiple return statements, because you don’t have to remember to free the resources before each return statement.

To create a `unique_ptr`, you should use `std::make_unique<>()`. For example, instead of writing the following,

```
Employee* anEmployee = new Employee;
// ...
delete anEmployee;
```

you should write this:

```
auto anEmployee = make_unique<Employee>();
```

Note that you do not call `delete` anymore; it happens automatically for you. The `auto` keyword is discussed in more detail in the “Type Inference” section later in this chapter. For now, it suffices to know that the `auto` keyword tells the compiler to automatically deduce the type of a variable, so that you don’t have to manually specify the full type.

`unique_ptr` is a generic smart pointer that can point to any kind of memory. That’s why it is a template. Templates require the angle brackets, `< >`, to specify the template parameters. Between the brackets, you have to specify the type of memory you want your `unique_ptr` to point to. Templates are discussed in detail in Chapters 12 and 22, but the smart pointers are introduced in Chapter 1 so that they can be used throughout the book—and as you will see, they are easy to use.

`make_unique()` has been available since C++14. If your compiler is not yet C++14 compliant, you can make your `unique_ptr` as follows (note that you now have to specify the type, `Employee`, twice):

```
unique_ptr<Employee> anEmployee(new Employee);
```

You can use the `anEmployee` smart pointer in the same way as a normal pointer, for example:

```
if (anEmployee) {  
    cout << "Salary: " << anEmployee->salary << endl;  
}
```

A `unique_ptr` can also be used to store a C-style array. The following example creates an array of ten `Employee` instances, stores it in a `unique_ptr`, and shows how to access an element from the array:

```
auto employees = make_unique<Employee[]>(10);  
cout << "Salary: " << employees[0].salary << endl;
```

`shared_ptr` allows for distributed ownership of the data. Each time a `shared_ptr` is assigned, a reference count is incremented indicating there is one more owner of the data. When a `shared_ptr` goes out of scope, the reference count is decremented. When the reference count goes to zero, it means there is no longer any owner of the data, and the object referenced by the pointer is freed.

To create a `shared_ptr`, you should use `std::make_shared<>()`, which is similar to `make_unique<>()`:

```
auto anEmployee = make_shared<Employee>();  
if (anEmployee) {  
    cout << "Salary: " << anEmployee->salary << endl;  
}
```

Starting with C++17, you can also store an array in a `shared_ptr`, whereas older versions of C++ did not allow this. Note however that `make_shared<>()` of C++17 cannot be used in this case. Here is an example:

```
shared_ptr<Employee[]> employees(new Employee[10]);  
cout << "Salary: " << employees[0].salary << endl;
```

Chapter 7 discusses memory management and smart pointers in more details, but because the basic use of `unique_ptr` and `shared_ptr` is straightforward, they are already used in examples throughout this book.

NOTE *Raw pointers are only allowed if there is no ownership involved. Otherwise, use `unique_ptr` by default, and `shared_ptr` if you need shared ownership. If you know about `auto_ptr`, forget it; it was deprecated in C++11/14, and has been removed from C++17.*

The Many Uses of `const`

The keyword `const` can be used in several different ways in C++. All of its uses are related, but there are subtle differences. The subtleties of `const` make for excellent interview questions! Chapter 11 explains in detail all the ways that `const` can be used. This section outlines two common use-cases.

`const` Constants

If you assumed that the keyword `const` has something to do with constants, you have correctly uncovered one of its uses. In the C language, programmers often use the preprocessor `#define` mechanism to declare symbolic names for values that won't change during the execution of the program, such as the version number. In C++, programmers are encouraged to avoid `#define` in favor of using `const` to define constants. Defining a constant with `const` is just like defining a variable, except that the compiler guarantees that code cannot change the value.

```
const int versionNumberMajor = 2;
const int versionNumberMinor = 1;
const std::string productName = "Super Hyper Net Modulator";
```

`const` to Protect Parameters

In C++, you can cast a non-`const` variable to a `const` variable. Why would you want to do this? It offers some degree of protection from other code changing the variable. If you are calling a function that a coworker of yours is writing, and you want to ensure that the function doesn't change the value of a parameter you pass in, you can tell your coworker to have the function take a `const` parameter. If the function attempts to change the value of the parameter, it will not compile.

In the following code, a `string*` is automatically cast to a `const string*` in the call to `mysteryFunction()`. If the author of `mysteryFunction()` attempts to change the value of the passed string, the code will not compile. There are ways around this restriction, but using them requires conscious effort. C++ only protects against accidentally changing `const` variables.

```
void mysteryFunction(const std::string* someString)
{
    *someString = "Test"; // Will not compile.
}

int main()
{
    std::string myString = "The string";
    mysteryFunction(&myString);
    return 0;
}
```

References

A reference in C++ allows you to give another name to an existing variable. For example:

```
int x = 42;
int& xReference = x;
```

Attaching `&` to a type indicates that the variable is a reference. It is still used as though it was a normal variable, but behind the scenes, it is really a pointer to the original variable. Both the variable `x` and the reference variable `xReference` point to exactly the same value. If you change the value through either one of them, the change is visible through the other one as well.

Pass By Reference

Normally, when you pass a variable into a function, you are *passing by value*. If a function takes an integer parameter, it is really a copy of the integer that you pass in, so you cannot modify the value of the original variable. Pointers to stack variables are often used in C to allow functions to modify variables in other stack frames. By dereferencing the pointer, the function can change the memory that represents the variable even though that variable isn't in the current stack frame. The problem with this approach is that it brings the messiness of pointer syntax into what is really a simple task.

Instead of passing pointers to functions, C++ offers a better mechanism, called *pass by reference*, where parameters are references instead of pointers. Following are two implementations of an `addOne()` function. The first one has no effect on the variable that is passed in because it is passed by value and thus the function receives a copy of the value passed to it. The second one uses a reference and thus changes the original variable.

```
void addOne(int i)
{
    i++; // Has no real effect because this is a copy of the original
}

void addOne(int& i)
{
    i++; // Actually changes the original variable
}
```

The syntax for the call to the `addOne()` function with an integer reference is no different than if the function just took an integer:

```
int myInt = 7;
addOne(myInt);
```

NOTE *There is a subtle difference between the two `addOne()` implementations. The version using pass-by-value accepts literals without a problem; for example, “`addOne(3);`” is legal. However, doing the same with the pass-by-reference version of `addOne()` will result in a compiler error. This can be solved by using `const` references, discussed in the next section, or `rvalue` references, an advanced C++ feature explained in Chapter 9.*

If you have a function that needs to return a big structure or class (discussed later in this chapter) that is expensive to copy, you'll often see the function taking a `non-const` reference to such a structure or class which the function then modifies, instead of directly returning it. This was the recommended way a long time ago to prevent the performance penalty of creating a copy when you return the structure or class from the function. Since C++11, this is not necessary anymore. Thanks to

move semantics, directly returning structures or classes from functions is efficient without any copying. Move semantics is discussed in detail in Chapter 9.

Pass By const Reference

You will often find code that uses `const` reference parameters for functions. At first, that seems like a contradiction. Reference parameters allow you to change the value of a variable from within another context. `const` seems to prevent such changes.

The main value in `const` reference parameters is efficiency. When you pass a value into a function, an entire copy is made. When you pass a reference, you are really just passing a pointer to the original so the computer doesn't need to make a copy. By passing a `const` reference, you get the best of both worlds: no copy is made but the original variable cannot be changed.

`const` references become more important when you are dealing with objects because they can be large and making copies of them can have unwanted side effects. Subtle issues like this are covered in Chapter 11. The following example shows how to pass an `std::string` to a function as a `const` reference:

```
void printString(const std::string& myString)
{
    std::cout << myString << std::endl;
}

int main()
{
    std::string someString = "Hello World";
    printString(someString);
    printString("Hello World"); // Passing literals works
    return 0;
}
```

NOTE *If you need to pass an object to a function, prefer to pass it by `const` reference instead of by value. This prevents unnecessary copying. Pass it by non-`const` reference if the function needs to modify the object.*

Exceptions

C++ is a very flexible language, but not a particularly safe one. The compiler will let you write code that scribbles on random memory addresses or tries to divide by zero (computers don't deal well with infinity). One language feature that attempts to add a degree of safety back to the language is *exceptions*.

An exception is an unexpected situation. For example, if you are writing a function that retrieves a web page, several things could go wrong. The Internet host that contains the page might be down, the page might come back blank, or the connection could be lost. One way you could handle this situation is by returning a special value from the function, such as `nullptr` or an error code. Exceptions provide a much better mechanism for dealing with problems.

Exceptions come with some new terminology. When a piece of code detects an exceptional situation, it *throws* an exception. Another piece of code *catches* the exception and takes appropriate action. The following example shows a function, `divideNumbers()`, that throws an exception if the caller passes in a denominator of zero. The use of `std::invalid_argument` requires `<stdexcept>`.

```
double divideNumbers(double numerator, double denominator)
{
    if (denominator == 0) {
        throw invalid_argument("Denominator cannot be 0.");
    }
    return numerator / denominator;
}
```

When the `throw` line is executed, the function immediately ends without returning a value. If the caller surrounds the function call with a `try/catch` block, as shown in the following code, it receives the exception and is able to handle it:

```
try {
    cout << divideNumbers(2.5, 0.5) << endl;
    cout << divideNumbers(2.3, 0) << endl;
    cout << divideNumbers(4.5, 2.5) << endl;
} catch (const invalid_argument& exception) {
    cout << "Exception caught: " << exception.what() << endl;
}
```

The first call to `divideNumbers()` executes successfully, and the result is output to the user. The second call throws an exception. No value is returned, and the only output is the error message that is printed when the exception is caught. The third call is never executed because the second call throws an exception, causing the program to jump to the `catch` block. The output for the preceding block of code is as follows:

```
5
An exception was caught: Denominator cannot be 0.
```

Exceptions can get tricky in C++. To use exceptions properly, you need to understand what happens to the stack variables when an exception is thrown, and you have to be careful to properly catch and handle the necessary exceptions. Also, the preceding example uses the built-in `std::invalid_argument` type, but it is preferable to write your own exception types that are more specific to the error being thrown. Lastly, the C++ compiler doesn't force you to catch every exception that might occur. If your code never catches any exceptions but an exception is thrown, it will be caught by the program itself, which will be terminated. These trickier aspects of exceptions are covered in much more detail in Chapter 14.

Type Inference

Type inference allows the compiler to automatically deduce the type of an expression. There are two keywords for type inference: `auto` and `decltype`.

The auto Keyword

The `auto` keyword has a number of completely different uses:

- Deducing a function’s return type, as explained earlier in this chapter.
- Structured bindings, as explained earlier in this chapter.
- Deducing the type of an expression, as discussed later in this section.
- Deducing the type of non-type template parameters, see Chapter 12.
- `decltype(auto)`, see Chapter 12.
- Alternative function syntax, see Chapter 12.
- Generic lambda expressions, see Chapter 18.

`auto` can be used to tell the compiler to automatically deduce the type of a variable at compile time. The following line shows the simplest use of the `auto` keyword in that context:

```
auto x = 123;    // x will be of type int
```

In this example, you don’t win much by typing `auto` instead of `int`; however, it becomes useful for more complicated types. Suppose you have a function called `getFoo()` that has a complicated return type. If you want to assign the result of calling `getFoo()` to a variable, you can spell out the complicated type, or you can simply use `auto` and let the compiler figure it out:

```
auto result = getFoo();
```

This has the added benefit that you can easily change the function’s return type without having to update all the places in the code where that function is called.

However, using `auto` to deduce the type of an expression strips away reference and `const` qualifiers. Suppose you have the following function:

```
#include <string>

const std::string message = "Test";

const std::string& foo()
{
    return message;
}
```

You can call `foo()` and store the result in a variable with the type specified as `auto`, as follows:

```
auto f1 = foo();
```

Because `auto` strips away reference and `const` qualifiers, `f1` is of type `string`, and thus a *copy* is made. If you want a `const` reference, you can explicitly make it a reference and mark it `const`, as follows:

```
const auto& f2 = foo();
```

WARNING *Always keep in mind that `auto` strips away reference and `const` qualifiers, and thus creates a copy! If you do not want a copy, use `auto&` or `const auto&`.*

The `decltype` Keyword

The `decltype` keyword takes an expression as argument, and computes the type of that expression, as shown here:

```
int x = 123;
decltype(x) y = 456;
```

In this example, the compiler deduces the type of `y` to be `int` because that is the type of `x`.

The difference between `auto` and `decltype` is that `decltype` does not strip reference and `const` qualifiers. Take again the function `foo()` returning a `const` reference to a `string`. Defining `f2` using `decltype` as follows results in `f2` being of type `const string&`, and thus no copy is made.

```
decltype(foo()) f2 = foo();
```

On first sight, `decltype` doesn't seem to add much value. However, it is pretty powerful in the context of templates, discussed in Chapters 12 and 22.

C++ AS AN OBJECT-ORIENTED LANGUAGE

If you are a C programmer, you may have viewed the features covered so far in this chapter as convenient additions to the C language. As the name C++ implies, in many ways the language is just a “better C.” There is one major point that this view overlooks: unlike C, C++ is an object-oriented language.

Object-oriented programming (OOP) is a very different, arguably more natural, way to write code. If you are used to procedural languages such as C or Pascal, don't worry. Chapter 5 covers all the background information you need to know to shift your mindset to the object-oriented paradigm. If you already know the theory of OOP, the rest of this section will get you up to speed (or refresh your memory) on basic C++ object syntax.

Defining Classes

A *class* defines the characteristics of an object. In C++, classes are usually defined in a header file (.h), while their definitions usually are in a corresponding source file (.cpp).

A basic class definition for an airline ticket class is shown in the following example. The class can calculate the price of the ticket based on the number of miles in the flight and whether or not the customer is a member of the “Elite Super Rewards Program.” The definition begins by declaring the class name. Inside a set of curly braces, the *data members* (properties) of the class and its *methods* (behaviors) are declared. Each data member and method is associated with a particular access level: `public`, `protected`, or `private`. These labels can occur in any order and can be repeated. Members that are `public` can be accessed from outside the class, while members that are `private` cannot be

accessed from outside the class. It's recommended to make all your data members `private`, and if needed, to give access to them with `public` getters and setters. This way, you can easily change the representation of your data while keeping the `public` interface the same. The use of `protected` is explained in the context of inheritance in Chapters 5 and 10.

```
#include <string>

class AirlineTicket
{
public:
    AirlineTicket();
    ~AirlineTicket();

    double calculatePriceInDollars() const;

    const std::string& getPassengerName() const;
    void setPassengerName(const std::string& name);

    int getNumberOfMiles() const;
    void setNumberOfMiles(int miles);

    bool hasEliteSuperRewardsStatus() const;
    void setHasEliteSuperRewardsStatus(bool status);
private:
    std::string mPassengerName;
    int mNumberOfMiles;
    bool mHasEliteSuperRewardsStatus;
};
```

This book follows the convention to prefix each data member of a class with a lowercase ‘m’, such as `mPassengerName`.

NOTE *To follow the const-correctness principle, it's always a good idea to declare member functions that do not change any data member of the object as being `const`. These member functions are also called “inspectors,” compared to “mutators” for non-const member functions.*

The method that has the same name as the class with no return type is a *constructor*. It is automatically called when an object of the class is created. The method with a tilde (~) character followed by the class name is a *destructor*. It is automatically called when the object is destroyed.

There are two ways of initializing data members with a constructor. The recommended way is to use a *constructor initializer*, which follows a colon after the constructor name. Here is the `AirlineTicket` constructor with a constructor initializer:

```
AirlineTicket::AirlineTicket()
: mPassengerName("Unknown Passenger")
, mNumberOfMiles(0)
, mHasEliteSuperRewardsStatus(false)
{
}
```

A second way is to put the initializations in the body of the constructor, as shown here:

```
AirlineTicket::AirlineTicket()
{
    // Initialize data members
    mPassengerName = "Unknown Passenger";
    mNumberOfMiles = 0;
    mHasEliteSuperRewardsStatus = false;
}
```

If the constructor is only initializing data members without doing anything else, then there is no real need for a constructor because data members can be initialized directly inside the class definition. For example, instead of writing an `AirlineTicket` constructor, you can modify the definition of the data members in the class definition as follows:

```
private:
    std::string mPassengerName = "Unknown Passenger";
    int mNumberOfMiles = 0;
    bool mHasEliteSuperRewardsStatus = false;
```

If your class additionally needs to perform some other types of initialization, such as opening a file, allocating memory, and so on, then you still need to write a constructor to handle those.

Here is the destructor for the `AirlineTicket` class:

```
AirlineTicket::~AirlineTicket()
{
    // Nothing much to do in terms of cleanup
}
```

This destructor doesn't do anything, and can simply be removed from this class. It is just shown here so you know the syntax of destructors. Destructors are required if you need to perform some cleanup, such as closing files, freeing memory, and so on. Chapters 8 and 9 discuss destructors in more detail.

The definitions of some of the `AirlineTicket` class methods are shown here:

```
double AirlineTicket::calculatePriceInDollars() const
{
    if (hasEliteSuperRewardsStatus()) {
        // Elite Super Rewards customers fly for free!
        return 0;
    }
    // The cost of the ticket is the number of miles times 0.1.
    // Real airlines probably have a more complicated formula!
    return getNumberOfMiles() * 0.1;
}

const string& AirlineTicket::getPassengerName() const
{
    return mPassengerName;
}

void AirlineTicket::setPassengerName(const string& name)
{
    mPassengerName = name;
}
```

```
// Other get and set methods omitted for brevity.
```

Using Classes

The following sample program makes use of the `AirlineTicket` class. This example shows the creation of a stack-based `AirlineTicket` object as well as a heap-based one:

```
AirlineTicket myTicket; // Stack-based AirlineTicket
myTicket.setPassengerName("Sherman T. Socketwrench");
myTicket.setNumberOfMiles(700);
double cost = myTicket.calculatePriceInDollars();
cout << "This ticket will cost $" << cost << endl;

// Heap-based AirlineTicket with smart pointer
auto myTicket2 = make_unique<AirlineTicket>();
myTicket2->setPassengerName("Laudimore M. Hallidue");
myTicket2->setNumberOfMiles(2000);
myTicket2->setHasEliteSuperRewardsStatus(true);
double cost2 = myTicket2->calculatePriceInDollars();
cout << "This other ticket will cost $" << cost2 << endl;
// No need to delete myTicket2, happens automatically

// Heap-based AirlineTicket without smart pointer (not recommended)
AirlineTicket* myTicket3 = new AirlineTicket();
// ... Use ticket 3
delete myTicket3; // delete the heap object!
```

The preceding example exposes you to the general syntax for creating and using classes. Of course, there is much more to learn. Chapters 8, 9, and 10 go into more depth about the specific C++ mechanisms for defining classes.

UNIFORM INITIALIZATION

Before C++11, initialization of types was not always uniform. For example, take the following definition of a circle, once as a structure, and once as a class:

```
struct CircleStruct
{
    int x, y;
    double radius;
};

class CircleClass
{
public:
    CircleClass(int x, int y, double radius)
        : mX(x), mY(y), mRadius(radius) {}
private:
    int mX, mY;
    double mRadius;
};
```

In pre-C++11, initialization of a variable of type `CircleStruct` and a variable of type `CircleClass` looks different:

```
CircleStruct myCircle1 = {10, 10, 2.5};
CircleClass myCircle2(10, 10, 2.5);
```

For the structure version, you can use the `{...}` syntax. However, for the class version, you need to call the constructor using function notation `(...)`.

Since C++11, you can more uniformly use the `{...}` syntax to initialize types, as follows:

```
CircleStruct myCircle3 = {10, 10, 2.5};
CircleClass myCircle4 = {10, 10, 2.5};
```

The definition of `myCircle4` automatically calls the constructor of `CircleClass`. Even the use of the equal sign is optional, so the following is identical:

```
CircleStruct myCircle5{10, 10, 2.5};
CircleClass myCircle6{10, 10, 2.5};
```

Uniform initialization is not limited to structures and classes. You can use it to initialize anything in C++. For example, the following code initializes all four variables with the value 3:

```
int a = 3;
int b(3);
int c = {3}; // Uniform initialization
int d{3};    // Uniform initialization
```

Uniform initialization can be used to perform zero-initialization* of variables; you just specify an empty set of curly braces, as shown here:

```
int e{}; // Uniform initialization, e will be 0
```

Using uniform initialization prevents *narrowing*. C++ implicitly performs narrowing, as shown here:

```
void func(int i) { /* ... */ }

int main()
{
    int x = 3.14;
    func(3.14);
}
```

In both cases, C++ automatically truncates 3.14 to 3 before assigning it to `x` or calling `func()`. Note that some compilers *might* issue a warning about this narrowing, while others won't. With uniform initialization, both the assignment to `x` and the call to `func()` *must* generate a compiler error if your compiler fully conforms to the C++11 standard:

```
void func(int i) { /* ... */ }

int main()
{
    int x = {3.14}; // Error because narrowing
    func({3.14});  // Error because narrowing
}
```

*Zero-initialization constructs objects with the default constructor, and initializes primitive integer types (such as `char`, `int`, and so on) to zero, primitive floating-point types to 0.0, and pointer types to `nullptr`.

Uniform initialization can be used to initialize dynamically allocated arrays, as shown here:

```
int* pArray = new int[4]{0, 1, 2, 3};
```

It can also be used in the constructor initializer to initialize arrays that are members of a class.

```
class MyClass
{
public:
    MyClass() : mArray{0, 1, 2, 3} {}
private:
    int mArray[4];
};
```

Uniform initialization can be used with the Standard Library containers as well—such as the `std::vector`, as demonstrated later in this chapter.

Direct List Initialization versus Copy List Initialization

There are two types of initialization that use braced initializer lists:

- Copy list initialization. `T obj = {arg1, arg2, ...};`
- Direct list initialization. `T obj {arg1, arg2, ...};`

In combination with auto type deduction, there is an important difference between copy- and direct list initialization introduced with C++17.

Starting with C++17, you have the following results:

```
// Copy list initialization
auto a = {11};           // initializer_list<int>
auto b = {11, 22};      // initializer_list<int>

// Direct list initialization
auto c {11};           // int
auto d {11, 22};      // Error, too many elements.
```

Note that for copy list initialization, all the elements in the braced initializer must be of the same type. For example, the following does not compile:

```
auto b = {11, 22.33}; // Compilation error
```

In earlier versions of the standard (C++11/14), both copy- and direct list initialization deduce an `initializer_list<>`:

```
// Copy list initialization
auto a = {11};           // initializer_list<int>
auto b = {11, 22};      // initializer_list<int>

// Direct list initialization
auto c {11};           // initializer_list<int>
auto d {11, 22};      // initializer_list<int>
```

THE STANDARD LIBRARY

C++ comes with a Standard Library, which contains a lot of useful classes that can easily be used in your code. The benefit of using these classes is that you don't need to reinvent certain classes and you don't need to waste time on implementing things that have already been implemented for you. Another benefit is that the classes available in the Standard Library are heavily tested and verified for correctness by thousands of users. The Standard Library classes are also tuned for high performance, so using them will most likely result in better performance compared to making your own implementation.

A lot of functionality is available to you in the Standard Library. Chapters 16 to 20 provide more details; however, when you start working with C++ it is a good idea to understand what the Standard Library can do for you from the very beginning. This is especially important if you are a C programmer. As a C programmer, you might try to solve problems in C++ the same way you would solve them in C. However, in C++ there is probably an easier and safer solution to the problem that involves using Standard Library classes.

You already saw some Standard Library classes earlier in this chapter—for example, `std::string`, `std::array`, `std::vector`, `std::unique_ptr`, and `std::shared_ptr`. Many more classes are introduced in Chapters 16 to 20.

YOUR FIRST USEFUL C++ PROGRAM

The following program builds on the employee database example used earlier in the discussion on structs. This time, you will end up with a fully functional C++ program that uses many of the features discussed in this chapter. This real-world example includes the use of classes, exceptions, streams, vectors, namespaces, references, and other language features.

An Employee Records System

A program to manage a company's employee records needs to be flexible and have useful features. The feature set for this program includes the following abilities:

- To add an employee
- To fire an employee
- To promote an employee
- To view all employees, past and present
- To view all current employees
- To view all former employees

The design for this program divides the code into three parts. The `Employee` class encapsulates the information describing a single employee. The `Database` class manages all the employees of the company. A separate `UserInterface` file provides the interactivity of the program.

The Employee Class

The `Employee` class maintains all the information about an employee. Its methods provide a way to query and change that information. `Employees` also know how to display themselves on the console. Methods also exist to adjust the employee's salary and employment status.

Employee.h

The `Employee.h` file defines the `Employee` class. The sections of this file are described individually in the text that follows.

The first line contains a `#pragma once` to prevent the file from being included multiple times, followed by the inclusion of the `string` functionality.

This code also declares that the subsequent code, contained within the curly braces, lives in the `Records` namespace. `Records` is the namespace that is used throughout this program for application-specific code.

```
#pragma once
#include <string>
namespace Records {
```

The following constant, representing the default starting salary for new employees, lives in the `Records` namespace. Other code that lives in `Records` can access this constant as `kDefaultStartingSalary`. Elsewhere, it must be referenced as `Records::kDefaultStartingSalary`.

```
const int kDefaultStartingSalary = 30000;
```

Note that this book uses the convention to prefix constants with a lowercase 'k', from the German "Konstant," meaning "Constant."

The `Employee` class is defined, along with its public methods. The `promote()` and `demote()` methods both have integer parameters that are specified with a default value. In this way, other code can omit the integer parameters and the default will automatically be used.

A number of setters and getters provide mechanisms to change the information about an employee or to query the current information about an employee.

The `Employee` class includes an explicitly defaulted constructor, as discussed in Chapter 8. It also includes a constructor that accepts a first and last name.

```
class Employee
{
public:
    Employee() = default;
    Employee(const std::string& firstName,
            const std::string& lastName);

    void promote(int raiseAmount = 1000);
    void demote(int demeritAmount = 1000);
    void hire(); // Hires or rehires the employee
    void fire(); // Dismisses the employee
    void display() const; // Outputs employee info to console
```

```
// Getters and setters
void setFirstName(const std::string& firstName);
const std::string& getFirstName() const;

void setLastName(const std::string& lastName);
const std::string& getLastName() const;

void setEmployeeNumber(int employeeNumber);
int getEmployeeNumber() const;

void setSalary(int newSalary);
int getSalary() const;

bool isHired() const;
```

Finally, the data members are declared as `private` so that other parts of the code cannot modify them directly. The setters and getters provide the only public way of modifying or querying those values. The data members are also initialized here instead of in a constructor. By default, new employees have no name, an employee number of -1, the default starting salary, and a status of not hired.

```
private:
    std::string mFirstName;
    std::string mLastName;
    int mEmployeeNumber = -1;
    int mSalary = kDefaultStartingSalary;
    bool mHired = false;
};
}
```

Employee.cpp

The constructor accepting a first and last name just sets the corresponding data members:

```
#include <iostream>
#include "Employee.h"

using namespace std;

namespace Records {
    Employee::Employee(const std::string& firstName,
                      const std::string& lastName)
        : mFirstName(firstName), mLastName(lastName)
    {
    }
}
```

The `promote()` and `demote()` methods simply call the `setSalary()` method with a new value. Note that the default values for the integer parameters do not appear in the source file; they are only allowed in a function declaration, not in a definition.

```
void Employee::promote(int raiseAmount)
{
    setSalary(getSalary() + raiseAmount);
}
```

```

void Employee::demote(int demeritAmount)
{
    setSalary(getSalary() - demeritAmount);
}

```

The `hire()` and `fire()` methods just set the `mHired` data member appropriately.

```

void Employee::hire()
{
    mHired = true;
}

void Employee::fire()
{
    mHired = false;
}

```

The `display()` method uses the console output stream to display information about the current employee. Because this code is part of the `Employee` class, it *could* access data members, such as `mSalary`, directly instead of using getters, such as `getSalary()`. However, it is considered good style to make use of getters and setters when they exist, even within the class.

```

void Employee::display() const
{
    cout << "Employee: " << getLastName() << ", " << getFirstName() << endl;
    cout << "-----" << endl;
    cout << (isHired() ? "Current Employee" : "Former Employee") << endl;
    cout << "Employee Number: " << getEmployeeNumber() << endl;
    cout << "Salary: $" << getSalary() << endl;
    cout << endl;
}

```

A number of getters and setters perform the task of getting and setting values. Even though these methods seem trivial, it's better to have trivial getters and setters than to make your data members public. For example, in the future, you may want to perform bounds checking in the `setSalary()` method. Getters and setters also make debugging easier because you can insert a breakpoint in them to inspect values when they are retrieved or set. Another reason is that when you decide to change how you are storing the data in your class, you only need to modify these getters and setters.

```

// Getters and setters
void Employee::setFirstName(const string& firstName)
{
    mFirstName = firstName;
}

const string& Employee::getFirstName() const
{
    return mFirstName;
}
// ... other getters and setters omitted for brevity
}

```

EmployeeTest.cpp

As you write individual classes, it is often useful to test them in isolation. The following code includes a `main()` function that performs some simple operations using the `Employee` class. Once you are confident that the `Employee` class works, you should remove or comment-out this file so that you don't attempt to compile your code with multiple `main()` functions.

```
#include <iostream>
#include "Employee.h"

using namespace std;
using namespace Records;

int main()
{
    cout << "Testing the Employee class." << endl;
    Employee emp;
    emp.setFirstName("John");
    emp.setLastName("Doe");
    emp.setEmployeeNumber(71);
    emp.setSalary(50000);
    emp.promote();
    emp.promote(50);
    emp.hire();
    emp.display();
    return 0;
}
```

Another way of testing individual classes is with *unit testing*, which is discussed in Chapter 26.

The Database Class

The `Database` class uses the `std::vector` class from the Standard Library to store `Employee` objects.

Database.h

Because the database will take care of automatically assigning an employee number to a new employee, a constant defines where the numbering begins.

```
#pragma once
#include <iostream>
#include <vector>
#include "Employee.h"

namespace Records {
    const int kFirstEmployeeNumber = 1000;
```

The database provides an easy way to add a new employee by providing a first and last name. For convenience, this method returns a reference to the new employee. External code can also get an employee reference by calling the `getEmployee()` method. Two versions of this method are declared. One allows retrieval by employee number. The other requires a first and last name.

```
class Database
{
    public:
```

```

Employee& addEmployee(const std::string& firstName,
                    const std::string& lastName);
Employee& getEmployee(int employeeNumber);
Employee& getEmployee(const std::string& firstName,
                    const std::string& lastName);

```

Because the database is the central repository for all employee records, it has methods that output all employees, the employees who are currently hired, and the employees who are no longer hired.

```

void displayAll() const;
void displayCurrent() const;
void displayFormer() const;

```

`mEmployees` contains the `Employee` objects. The `mNextEmployeeNumber` data member keeps track of what employee number is assigned to a new employee, and is initialized with the `kFirstEmployeeNumber` constant.

```

private:
    std::vector<Employee> mEmployees;
    int mNextEmployeeNumber = kFirstEmployeeNumber;
};
}

```

Database.cpp

The `addEmployee()` method creates a new `Employee` object, fills in its information, and adds it to the vector. The `mNextEmployeeNumber` data member is incremented after its use so that the next employee will get a new number.

```

#include <iostream>
#include <stdexcept>
#include "Database.h"

using namespace std;

namespace Records {
    Employee& Database::addEmployee(const string& firstName,
                                   const string& lastName)
    {
        Employee theEmployee(firstName, lastName);
        theEmployee.setEmployeeNumber(mNextEmployeeNumber++);
        theEmployee.hire();
        mEmployees.push_back(theEmployee);
        return mEmployees[mEmployees.size() - 1];
    }
}

```

Only one version of `getEmployee()` is shown. Both versions work in similar ways. The methods loop over all employees in `mEmployees` using range-based `for` loops, and check to see if an `Employee` is a match for the information passed to the method. An exception is thrown if no match is found.

```

Employee& Database::getEmployee(int employeeNumber)
{
    for (auto& employee : mEmployees) {
        if (employee.getEmployeeNumber() == employeeNumber) {

```

```
        return employee;
    }
}
throw logic_error("No employee found.");
}
```

The display methods all use a similar algorithm. They loop through all employees and tell each employee to display itself to the console if the criterion for display matches. `displayFormer()` is similar to `displayCurrent()`.

```
void Database::displayAll() const
{
    for (const auto& employee : mEmployees) {
        employee.display();
    }
}

void Database::displayCurrent() const
{
    for (const auto& employee : mEmployees) {
        if (employee.isHired())
            employee.display();
    }
}
}
```

DatabaseTest.cpp

A simple test for the basic functionality of the database is shown here:

```
#include <iostream>
#include "Database.h"

using namespace std;
using namespace Records;

int main()
{
    Database myDB;
    Employee& emp1 = myDB.addEmployee("Greg", "Wallis");
    emp1.fire();

    Employee& emp2 = myDB.addEmployee("Marc", "White");
    emp2.setSalary(100000);

    Employee& emp3 = myDB.addEmployee("John", "Doe");
    emp3.setSalary(10000);
    emp3.promote();

    cout << "all employees: " << endl << endl;
    myDB.displayAll();

    cout << endl << "current employees: " << endl << endl;
    myDB.displayCurrent();
}
```



```

        cout << endl << "former employees: " << endl << endl;
        myDB.displayFormer();
    }

```

The User Interface

The final part of the program is a menu-based user interface that makes it easy for users to work with the employee database.

The `main()` function is a loop that displays the menu, performs the selected action, then does it all again. For most actions, separate functions are defined. For simpler actions, like displaying employees, the actual code is put in the appropriate case.

```

#include <iostream>
#include <stdexcept>
#include <exception>
#include "Database.h"

using namespace std;
using namespace Records;

int displayMenu();
void doHire(Database& db);
void doFire(Database& db);
void doPromote(Database& db);
void doDemote(Database& db);

int main()
{
    Database employeeDB;
    bool done = false;
    while (!done) {
        int selection = displayMenu();
        switch (selection) {
            case 0:
                done = true;
                break;
            case 1:
                doHire(employeeDB);
                break;
            case 2:
                doFire(employeeDB);
                break;
            case 3:
                doPromote(employeeDB);
                break;
            case 4:
                employeeDB.displayAll();
                break;
            case 5:
                employeeDB.displayCurrent();
                break;
            case 6:
                employeeDB.displayFormer();

```

```
        break;
    default:
        cerr << "Unknown command." << endl;
        break;
    }
}
return 0;
}
```

The `displayMenu()` function outputs the menu and gets input from the user. One important note is that this code assumes that the user will “play nice” and type a number when a number is requested. When you read about I/O in Chapter 13, you will learn how to protect against bad input.

```
int displayMenu()
{
    int selection;
    cout << endl;
    cout << "Employee Database" << endl;
    cout << "-----" << endl;
    cout << "1) Hire a new employee" << endl;
    cout << "2) Fire an employee" << endl;
    cout << "3) Promote an employee" << endl;
    cout << "4) List all employees" << endl;
    cout << "5) List all current employees" << endl;
    cout << "6) List all former employees" << endl;
    cout << "0) Quit" << endl;
    cout << endl;
    cout << "---> ";
    cin >> selection;
    return selection;
}
```

The `doHire()` function gets the new employee’s name from the user and tells the database to add the employee.

```
void doHire(Database& db)
{
    string firstName;
    string lastName;

    cout << "First name? ";
    cin >> firstName;

    cout << "Last name? ";
    cin >> lastName;

    db.addEmployee(firstName, lastName);
}
```

`doFire()` and `doPromote()` both ask the database for an employee by their employee number and then use the public methods of the `Employee` object to make changes.

```
void doFire(Database& db)
{
    int employeeNumber;

    cout << "Employee number? ";
    cin >> employeeNumber;

    try {
        Employee& emp = db.getEmployee(employeeNumber);
        emp.fire();
        cout << "Employee " << employeeNumber << " terminated." << endl;
    } catch (const std::logic_error& exception) {
        cerr << "Unable to terminate employee: " << exception.what() << endl;
    }
}

void doPromote(Database& db)
{
    int employeeNumber;
    int raiseAmount;

    cout << "Employee number? ";
    cin >> employeeNumber;

    cout << "How much of a raise? ";
    cin >> raiseAmount;

    try {
        Employee& emp = db.getEmployee(employeeNumber);
        emp.promote(raiseAmount);
    } catch (const std::logic_error& exception) {
        cerr << "Unable to promote employee: " << exception.what() << endl;
    }
}
```

Evaluating the Program

The preceding program covers a number of topics from the very simple to the relatively complex. There are a number of ways that you could extend this program. For example, the user interface does not expose all of the functionality of the `Database` or `Employee` classes. You could modify the UI to include those features. You could also change the `Database` class to remove fired employees from `mEmployees`.

If there are parts of this program that don't make sense, consult the preceding sections to review those topics. If something is still unclear, the best way to learn is to play with the code and try things out. For example, if you're not sure how to use the conditional operator, write a short `main()` function that uses it.

SUMMARY

Now that you know the fundamentals of C++, you are ready to become a professional C++ programmer. When you start getting deeper into the C++ language later in this book, you can refer to this chapter to brush up on parts of the language you may need to review. Going back to some of the sample code in this chapter may be all you need to bring a forgotten concept back to the forefront of your mind.

The next chapter goes deeper in on how strings are handled in C++, because every program you write will have to work with strings one way or another.

2

Working with Strings and String Views

WHAT'S IN THIS CHAPTER?

- The differences between C-style strings and C++ strings
- Details of the C++ `std::string` class
- Why you should use `std::string_view`
- What raw string literals are

WROX.COM DOWNLOADS FOR THIS CHAPTER

Please note that all the code examples for this chapter are available as a part of the chapter's code download on this book's website at www.wrox.com/go/proc++4e on the Download Code tab.

Every program that you write will use strings of some kind. With the old C language, there is not much choice but to use a dumb null-terminated character array to represent a string. Unfortunately, doing so can cause a lot of problems, such as buffer overflows, which can result in security vulnerabilities. The C++ Standard Library includes a safe and easy-to-use `std::string` class that does not have these disadvantages.

Because strings are so important, this chapter discusses them in more detail.

DYNAMIC STRINGS

Strings in languages that have supported them as first-class objects tend to have a number of attractive features, such as being able to expand to any size, or to have sub-strings extracted or replaced. In other languages, such as C, strings were almost an afterthought; there was no really good “string” data type, just fixed arrays of bytes. The “string library” was nothing more than a collection of rather primitive functions without even bounds checking. C++ provides a string type as a first-class data type.

C-Style Strings

In the C language, strings are represented as an array of characters. The last character of a string is a null character (`'\0'`) so that code operating on the string can determine where it ends. This null character is officially known as `NUL`, spelled with one L, not two. `NUL` is not the same as the `NULL` pointer. Even though C++ provides a better string abstraction, it is important to understand the C technique for strings because they still arise in C++ programming. One of the most common situations is where a C++ program has to call a C-based interface in some third-party library or as part of interfacing to the operating system.

By far, the most common mistake that programmers make with C strings is that they forget to allocate space for the `'\0'` character. For example, the string “hello” appears to be five characters long, but six characters worth of space are needed in memory to store the value, as shown in Figure 2-1.

myString

'h'	'e'	'l'	'l'	'o'	'\0'
-----	-----	-----	-----	-----	------

FIGURE 2-1

C++ contains several functions from the C language that operate on strings. These functions are defined in the `<cstring>` header. As a general rule of thumb, these functions do not handle memory allocation. For example, the `strcpy()` function takes two strings as parameters. It copies the second string onto the first, whether it fits or not. The following code attempts to build a wrapper around `strcpy()` that allocates the correct amount of memory and returns the result, instead of taking in an already allocated string. It uses the `strlen()` function to obtain the length of the string. The caller is responsible for freeing the memory allocated by `copyString()`.

```
char* copyString(const char* str)
{
    char* result = new char[strlen(str)]; // BUG! Off by one!
    strcpy(result, str);
    return result;
}
```

The `copyString()` function as written is incorrect. The `strlen()` function returns the length of the string, not the amount of memory needed to hold it. For the string “hello”, `strlen()` returns 5, not 6. The proper way to allocate memory for a string is to add 1 to the amount of space needed for the actual characters. It seems a bit unnatural to have +1 all over the place. Unfortunately, that’s how it works, so keep this in mind when you work with C-style strings. The correct implementation is as follows:

```
char* copyString(const char* str)
{
    char* result = new char[strlen(str) + 1];
```

```

    strcpy(result, str);
    return result;
}

```

One way to remember that `strlen()` returns only the number of actual characters in the string is to consider what would happen if you were allocating space for a string made up of several other strings. For example, if your function took in three strings and returned a string that was the concatenation of all three, how big would it be? To hold exactly enough space, it would be the length of all three strings, added together, plus one space for the trailing `'\0'` character. If `strlen()` included the `'\0'` in the length of the string, the allocated memory would be too big. The following code uses the `strcpy()` and `strcat()` functions to perform this operation. The `cat` in `strcat()` stands for concatenate.

```

char* appendString(const char* str1, const char* str2, const char* str3)
{
    char* result = new char[strlen(str1) + strlen(str2) + strlen(str3) + 1];
    strcpy(result, str1);
    strcat(result, str2);
    strcat(result, str3);
    return result;
}

```

The `sizeof()` operator in C and C++ can be used to get the size of a certain data type or variable. For example, `sizeof(char)` returns 1 because a `char` has a size of 1 byte. However, in the context of C-style strings, `sizeof()` is not the same as `strlen()`. You should never use `sizeof()` to try to get the size of a string. It returns different sizes depending on how the C-style string is stored. If it is stored as a `char[]`, then `sizeof()` returns the actual memory used by the string, including the `'\0'` character, as in this example:

```

char text1[] = "abcdef";
size_t s1 = sizeof(text1); // is 7
size_t s2 = strlen(text1); // is 6

```

However, if the C-style string is stored as a `char*`, then `sizeof()` returns the size of a pointer!

```

const char* text2 = "abcdef";
size_t s3 = sizeof(text2); // is platform-dependent
size_t s4 = strlen(text2); // is 6

```

Here, `s3` will be 4 when compiled in 32-bit mode, and 8 when compiled in 64-bit mode because it is returning the size of a `const char*`, which is a pointer.

A complete list of C functions to operate on strings can be found in the `<cstring>` header file.

WARNING *When you use the C-style string functions with Microsoft Visual Studio, the compiler is likely to give you security-related warnings or even errors about these functions being deprecated. You can eliminate these warnings by using other C Standard Library functions, such as `strcpy_s()` or `strcat_s()`, which are part of the “secure C library” standard (ISO/IEC TR 24731). However, the best solution is to switch to the C++ Standard Library `std::string` class, which we discuss in the section “The C++ `std::string` Class.”*

String Literals

You’ve probably seen strings written in a C++ program with quotes around them. For example, the following code outputs the string `hello` by including the string itself, not a variable that contains it:

```
cout << "hello" << endl;
```

In the preceding line, `"hello"` is a *string literal* because it is written as a value, not a variable. String literals are actually stored in a read-only part of memory. This allows the compiler to optimize memory usage by reusing references to equivalent string literals. That is, even if your program uses the string literal `"hello"` 500 times, the compiler is allowed to create just one instance of `hello` in memory. This is called *literal pooling*.

String literals can be *assigned* to variables, but because string literals are in a read-only part of memory and because of the possibility of literal pooling, assigning them to variables can be risky. The C++ standard officially says that string literals are of type “array of n `const char`”; however, for backward compatibility with older non-`const`-aware code, most compilers do not enforce your program to assign a string literal to a variable of type `const char*`. They let you assign a string literal to a `char*` without `const`, and the program will work fine unless you attempt to change the string. Generally, the behavior of modifying string literals is undefined. It could, for example, cause a crash, or it could keep working with seemingly inexplicable side effects, or the modification could silently be ignored, or it could just work; it all depends on your compiler. For example, the following code exhibits undefined behavior:

```
char* ptr = "hello";           // Assign the string literal to a variable.
ptr[1] = 'a';                 // Undefined behavior!
```

A much safer way to code is to use a pointer to `const` characters when referring to string literals. The following code contains the same bug, but because it assigned the literal to a `const char*`, the compiler catches the attempt to write to read-only memory:

```
const char* ptr = "hello";    // Assign the string literal to a variable.
ptr[1] = 'a';                 // Error! Attempts to write to read-only memory
```

You can also use a string literal as an initial value for a character array (`char[]`). In this case, the compiler creates an array that is big enough to hold the string and copies the string to this array. The compiler does not put the literal in read-only memory and does not do any literal pooling.

```
char arr[] = "hello";        // Compiler takes care of creating appropriate sized
                             // character array arr.
arr[1] = 'a';                // The contents can be modified.
```

Raw String Literals

Raw string literals are string literals that can span across multiple lines of code, that don’t require escaping of embedded double quotes, and where escape sequences like `\t` and `\n` are processed as normal text and not as escape sequences. Escape sequences are discussed in Chapter 1. For example, if you write the following with a normal string literal, you will get a compilation error because the string contains non-escaped double quotes:

```
const char* str = "Hello "World!";    // Error!
```

Normally you have to escape the double quotes as follows:

```
const char* str = "Hello \"World\"!";
```

With a raw string literal, you can avoid the need to escape the quotes. The raw string literal starts with `R` (and ends with `)` ".

```
const char* str = R"(Hello "World!")";
```

If you need a string consisting of multiple lines, without raw string literals you need to embed `\n` escape sequences in your string where you want to start a new line. For example:

```
const char* str = "Line 1\nLine 2";
```

If you output this string to the console, you get the following:

```
Line 1
Line 2
```

With a raw string literal, instead of using `\n` escape sequences to start new lines, you can simply press enter to start real physical new lines in your source code as follows. The output is the same as the previous code snippet using the embedded `\n`.

```
const char* str = R"(Line 1
Line 2)";
```

Escape sequences are ignored in raw string literals. For example, in the following raw string literal, the `\t` escape sequence is not replaced with a tab character, but is kept as the sequence of a backslash followed by the letter `t`:

```
const char* str = R"(Is the following a tab character? \t)";
```

So, if you output this string to the console, you get:

```
Is the following a tab character? \t
```

Because a raw string literal ends with `)` " you cannot embed a `)` " in your string using this syntax. For example, the following string is not valid because it contains the `)` " sequence in the middle of the string:

```
const char* str = R"(Embedded )" characters)"; // Error!
```

If you need embedded `)` " characters, you need to use the extended raw string literal syntax, which is as follows:

```
R"d-char-sequence (r-char-sequence) d-char-sequence"
```

The `r-char-sequence` is the actual raw string. The `d-char-sequence` is an optional delimiter sequence, which should be the same at the beginning and at the end of the raw string literal. This delimiter sequence can have at most 16 characters. You should choose this delimiter sequence as a sequence that will not appear in the middle of your raw string literal.

The previous example can be rewritten using a unique delimiter sequence as follows:

```
const char* str = R"-(Embedded )" characters)-";
```

Raw string literals make it easier to work with database querying strings, regular expressions, file paths, and so on. Regular expressions are discussed in Chapter 19.

The C++ `std::string` Class

C++ provides a much-improved implementation of the concept of a string as part of the Standard Library. In C++, `std::string` is a class (actually an instantiation of the `basic_string` class template) that supports many of the same functionalities as the `<cstring>` functions, but that takes care of memory allocation for you. The `string` class is defined in the `<string>` header in the `std` namespace, and has already been introduced in the previous chapter. Now it's time to take a deeper look at it.

What Is Wrong with C-Style Strings?

To understand the necessity of the C++ `string` class, consider the advantages and disadvantages of C-style strings.

Advantages:

- They are simple, making use of the underlying basic character type and array structure.
- They are lightweight, taking up only the memory that they need if used properly.
- They are low level, so you can easily manipulate and copy them as raw memory.
- They are well understood by C programmers—why learn something new?

Disadvantages:

- They require incredible efforts to simulate a first-class string data type.
- They are unforgiving and susceptible to difficult-to-find memory bugs.
- They don't leverage the object-oriented nature of C++.
- They require knowledge of their underlying representation on the part of the programmer.

The preceding lists were carefully constructed to make you think that perhaps there is a better way. As you'll learn, C++ strings solve all the problems of C strings and render most of the arguments about the advantages of C strings over a first-class data type irrelevant.

Using the `string` Class

Even though `string` is a class, you can almost always treat it as if it were a built-in type. In fact, the more you think of it that way, the better off you are. Through the magic of operator overloading, C++ strings are much easier to use than C-style strings. For example, the `+` operator is redefined for strings to mean “string concatenation.” The following code produces `1234`:

```
string A("12");
string B("34");
string C;
C = A + B;    // C is "1234"
```

The `+=` operator is also overloaded to allow you to easily append a string:

```
string A("12");
string B("34");
A += B;    // A is "1234"
```

Another problem with C strings is that you cannot use `==` to compare them. Suppose you have the following two strings:

```
char* a = "12";
char b[] = "12";
```

Writing a comparison as follows always returns `false`, because it compares the pointer values, not the contents of the strings:

```
if (a == b)
```

Note that C arrays and pointers are related. You can think of C arrays, like the `b` array in the example, as pointers to the first element in the array. Chapter 7 goes deeper in on the array-pointer duality.

To compare C strings, you have to write something as follows:

```
if (strcmp(a, b) == 0)
```

Furthermore, there is no way to use `<`, `<=`, `>=`, or `>` to compare C strings, so `strcmp()` returns `-1`, `0`, or `1`, depending on the lexicographic relationship of the strings. This results in very clumsy and hard-to-read code, which is also error-prone.

With C++ strings, `operator==`, `operator!=`, `operator<`, and so on are all overloaded to work on the actual string characters. Individual characters can still be accessed with `operator[]`.

As the following code shows, when string operations require extending the string, the memory requirements are automatically handled by the `string` class, so memory overruns are a thing of the past:

```
string myString = "hello";
myString += ", there";
string myOtherString = myString;
if (myString == myOtherString) {
    myOtherString[0] = 'H';
}
cout << myString << endl;
cout << myOtherString << endl;
```

The output of this code is

```
hello, there
Hello, there
```

There are several things to note in this example. One point is that there are no memory leaks even though strings are allocated and resized on a few places. All of these `string` objects are created as stack variables. While the `string` class certainly has a bunch of allocating and resizing to do, the `string` destructors clean up this memory when `string` objects go out of scope.

Another point to note is that the operators work the way you want them to. For example, the `=` operator copies the strings, which is most likely what you want. If you are used to working with array-based strings, this will either be refreshingly liberating for you or somewhat confusing. Don't worry—once you learn to trust the `string` class to do the right thing, life gets so much easier.

For compatibility, you can use the `c_str()` method on a `string` to get a `const` character pointer, representing a C-style string. However, the returned `const` pointer becomes invalid whenever the `string` has to perform any memory reallocation, or when the `string` object is destroyed. You should call the method just before using the result so that it accurately reflects the current contents of the `string`, and you must never return the result of `c_str()` called on a stack-based `string` object from a function.

There is also a `data()` method which, up until C++14, always returned a `const char*` just as `c_str()`. Starting with C++17, however, `data()` returns a `char*` when called on a non-`const` `string`.

Consult a Standard Library Reference, see Appendix B, for a complete list of all supported operations that you can perform on `string` objects.

`std::string` Literals

A string literal in source code is usually interpreted as a `const char*`. You can use the standard user-defined literal `"s"` to interpret a string literal as an `std::string` instead.

```
auto string1 = "Hello World";    // string1 is a const char*
auto string2 = "Hello World"s;   // string2 is an std::string
```

The standard user-defined literal `"s"` requires a `using namespace std::string_literals;` or `using namespace std;`

High-Level Numeric Conversions

The `std` namespace includes a number of helper functions that make it easy to convert numerical values into `strings` or `strings` into numerical values. The following functions are available to convert numerical values into `strings`. All these functions take care of memory allocations. A new `string` object is created and returned from them.

- `string to_string(int val);`
- `string to_string(unsigned val);`
- `string to_string(long val);`
- `string to_string(unsigned long val);`
- `string to_string(long long val);`
- `string to_string(unsigned long long val);`
- `string to_string(float val);`
- `string to_string(double val);`
- `string to_string(long double val);`

These functions are pretty straightforward to use. For example, the following code converts a long double value into a string:

```
long double d = 3.14L;
string s = to_string(d);
```

Converting in the other direction is done by the following set of functions, also defined in the `std` namespace. In these prototypes, `str` is the string that you want to convert, `idx` is a pointer that receives the index of the first non-converted character, and `base` is the mathematical base that should be used during conversion. The `idx` pointer can be a null pointer, in which case it will be ignored. These functions ignore leading whitespace, throw `invalid_argument` if no conversion could be performed, and throw `out_of_range` if the converted value is outside the range of the return type.

- `int stoi(const string& str, size_t *idx=0, int base=10);`
- `long stol(const string& str, size_t *idx=0, int base=10);`
- `unsigned long stoul(const string& str, size_t *idx=0, int base=10);`
- `long long stoll(const string& str, size_t *idx=0, int base=10);`
- `unsigned long long stoull(const string& str, size_t *idx=0, int base=10);`
- `float stof(const string& str, size_t *idx=0);`
- `double stod(const string& str, size_t *idx=0);`
- `long double stold(const string& str, size_t *idx=0);`

Here is an example:

```
const string toParse = " 123USD";
size_t index = 0;
int value = stoi(toParse, &index);
cout << "Parsed value: " << value << endl;
cout << "First non-parsed character: '" << toParse[index] << "' << endl;
```

The output is as follows:

```
Parsed value: 123
First non-parsed character: 'U'
```

C++17 Low-Level Numeric Conversions

The C++17 standard also provides a number of lower-level numerical conversion functions, all defined in the `<charconv>` header. These functions do not perform any memory allocations, but instead use buffers allocated by the caller. Additionally, they are tuned for high performance and are locale-independent (see Chapter 19 for details on localization). The end result is that these functions can be orders of magnitude faster than other higher-level numerical conversion functions. You should use these functions if you want high performant, locale-independent conversions, for example to serialize/deserialize numerical data to/from human readable formats such as JSON, XML, and so on.

For converting integers to characters, the following set of functions is available:

```
to_chars_result to_chars(char* first, char* last, IntegerT value, int base = 10);
```

Here, `IntegerT` can be any signed or unsigned integer type or `char`. The result is of type `to_chars_result`, a type defined as follows:

```
struct to_chars_result {
    char* ptr;
    errc ec;
};
```

The `ptr` member is either equal to the one-past-the-end pointer of the written characters if the conversion was successful, or it is equal to `last` if the conversion failed (in which case, `ec == errc::value_too_large`).

Here is an example of its use:

```
std::string out(10, ' ');
auto result = std::to_chars(out.data(), out.data() + out.size(), 12345);
if (result.ec == std::errc()) { /* Conversion successful. */ }
```

Using C++17 structured bindings introduced in Chapter 1, you can write it as follows:

```
std::string out(10, ' ');
auto [ptr, ec] = std::to_chars(out.data(), out.data() + out.size(), 12345);
if (ec == std::errc()) { /* Conversion successful. */ }
```

Similarly, the following set of conversion functions is available for floating point types:

```
to_chars_result to_chars(char* first, char* last, FloatT value);
to_chars_result to_chars(char* first, char* last, FloatT value,
    chars_format format);
to_chars_result to_chars(char* first, char* last, FloatT value,
    chars_format format, int precision);
```

Here, `FloatT` can be `float`, `double`, or `long double`. Formatting can be specified with a combination of `chars_format` flags:

```
enum class chars_format {
    scientific,           // Style: (-)d.ddde±dd
    fixed,                // Style: (-)ddd.ddd
    hex,                  // Style: (-)h.hhhp±d (Note: no 0x!)
    general = fixed | scientific // See next paragraph
};
```

The default format is `chars_format::general`, which causes `to_chars()` to convert the floating point value to a decimal notation in the style of `(-)ddd.ddd`, or to a decimal exponent notation in the style of `(-)d.ddde±dd`, whichever results in the shortest representation with at least one digit before the decimal point (if present). If a format is specified but no precision, the precision is automatically determined to result in the shortest possible representation for the given format, with a maximum precision of 6 digits.

For the opposite conversion—that is, converting character sequences into numerical values—the following set of functions is available:

```
from_chars_result from_chars(const char* first, const char* last,
    IntegerT& value, int base = 10);
```

```

from_chars_result from_chars(const char* first, const char* last,
                             FloatT& value,
                             chars_format format = chars_format::general);

```

Here, `from_chars_result` is a type defined as follows:

```

struct from_chars_result {
    const char* ptr;
    errc ec;
};

```

The `ptr` member of the result type is a pointer to the first character that was not converted, or it equals `last` if all characters were successfully converted. If none of the characters could be converted, `ptr` equals `first`, and the value of the error code will be `errc::invalid_argument`. If the parsed value is too large to be representable by the given type, the value of the error code will be `errc::result_out_of_range`. Note that `from_chars()` does not skip any leading whitespace.

C++17

The `std::string_view` Class

Before C++17, there was always a dilemma of choosing the parameter type for a function that accepted a read-only string. Should it be a `const char*`? In that case, if a client had an `std::string` available, they had to call `c_str()` or `data()` on it to get a `const char*`. Even worse, the function would lose the nice object-oriented aspects of the `std::string` and all its nice helper methods. Maybe the parameter could instead be a `const std::string&`? In that case, you always needed an `std::string`. If you passed a string literal, for example, the compiler silently created a temporary `string` object that contained a copy of your string literal and passed that object to your function, so there was a bit of overhead. Sometimes people would write multiple overloads of the same function—one that accepted a `const char*`, and another that accepted a `const string&`—but that was obviously a less-than-elegant solution.

With C++17, all those problems are solved with the introduction of the `std::string_view` class, which is an instantiation of the `std::basic_string_view` class template, and is defined in the `<string_view>` header. A `string_view` is basically a drop-in replacement for `const string&`, but without the overhead. It never copies strings! A `string_view` supports an interface similar to `std::string`. One exception is the absence of `c_str()`, but `data()` is available. On the other hand, `string_view` does add the methods `remove_prefix(size_t)` and `remove_suffix(size_t)`, which shrink the string by advancing the starting pointer by a given offset, or by moving the end pointer backward by a given offset.

Note that you cannot concatenate a `string` and a `string_view`. The following code does not compile:

```

string str = "Hello";
string_view sv = " world";
auto result = str + sv;

```

To make it compile, you need to replace the last line with:

```

auto result = str + sv.data();

```

If you know how to use `std::string`, then using a `string_view` is very straightforward, as the following example code demonstrates. The `extractExtension()` function extracts and returns the

extension of a given filename. Note that `string_views` are usually passed by value because they are extremely cheap to copy. They just contain a pointer to, and the length of, a string.

```
string_view extractExtension(string_view fileName)
{
    return fileName.substr(fileName.rfind('.'));
}
```

This function can be used with all kinds of different strings:

```
string fileName = R"(c:\temp\my file.ext)";
cout << "C++ string: " << extractExtension(fileName) << endl;

const char* cString = R"(c:\temp\my file.ext)";
cout << "C string: " << extractExtension(cString) << endl;

cout << "Literal: " << extractExtension(R"(c:\temp\my file.ext)") << endl;
```

There is not a single copy being made in all these calls to `extractExtension()`. The `fileName` parameter of the `extractExtension()` function is just a pointer and a length, and so is the return type of the function. This is all very efficient.

There is also a `string_view` constructor that accepts any raw buffer and a length. This can be used to construct a `string_view` out of a string buffer that is not NUL terminated. It is also useful when you do have a NUL-terminated string buffer, but you already know the length of the string, so the constructor does not need to count the number of characters again.

```
const char* raw = /* ... */;
size_t length = /* ... */;
cout << "Raw: " << extractExtension(string_view(raw, length)) << endl;
```

You cannot implicitly construct a string from a `string_view`. Either you use an explicit string constructor, or you use the `string_view::data()` member. For example, suppose you have the following function that accepts a `const string&`:

```
void handleExtension(const string& extension) { /* ... */ }
```

Calling this function as follows does not work:

```
handleExtension(extractExtension("my file.ext"));
```

The following are two possible options you can use:

```
handleExtension(extractExtension("my file.ext").data()); // data() method
handleExtension(string(extractExtension("my file.ext"))); // explicit ctor
```

NOTE Use an `std::string_view` instead of `const std::string&` or `const char*` whenever a function or method requires a read-only string as one of its parameters.

std::string_view Literals

You can use the standard user-defined literal “sv” to interpret a string literal as an `std::string_view`. For example:

```
auto sv = "My string_view"sv;
```

The standard user-defined literal “sv” requires a `using namespace std::string_view_literals;` or `using namespace std;`.

Nonstandard Strings

There are several reasons why many C++ programmers don’t use C++-style strings. Some programmers simply aren’t aware of the `string` type because it was not always part of the C++ specification. Others have discovered over the years that the C++ `string` doesn’t provide the behavior they need, and so have developed their own string type. Perhaps the most common reason is that development frameworks and operating systems tend to have their own way of representing strings, such as the `CString` class in the Microsoft MFC. Often, this is for backward compatibility or to address legacy issues. When starting a project in C++, it is very important to decide ahead of time how your group will represent strings. Some things are for sure:

- You should not pick the C-style string representation.
- You can standardize on the string functionality available in the framework you are using, such as the built-in string features of MFC, QT, ...
- If you use `std::string` for your strings, then use `std::string_view` to pass read-only strings as parameters to functions; otherwise, see if your framework has support for something similar like `string_views`.

SUMMARY

This chapter discussed the C++ `string` and `string_view` classes and what their benefits are compared to plain old C-style character arrays. It also explained how a number of helper functions make it easier to convert numerical values into `strings` and vice versa, and it introduced the concept of raw string literals.

The next chapter discusses guidelines for good coding style, including code documentation, decomposition, naming, code formatting, and other tips.

3

Coding with Style

WHAT'S IN THIS CHAPTER?

- The importance of documenting your code, and what kind of commenting styles you can use
- What decomposition means and how to use it
- What naming conventions are
- What formatting rules are

If you're going to spend several hours each day in front of a keyboard writing code, you should take some pride in all that work. Writing code that gets the job done is only part of a programmer's work. After all, anybody can learn the fundamentals of coding. It takes a true master to code with style.

This chapter explores the question of what makes good code. Along the way, you'll see several approaches to C++ style. As you will discover, simply changing the style of code can make it appear very different. For example, C++ code written by Windows programmers often has its own style, using Windows conventions. It almost looks like a completely different language than C++ code written by Mac OS programmers. Exposure to several different styles will help you avoid that sinking feeling you get when opening up a C++ source file that barely resembles the C++ you thought you knew.

THE IMPORTANCE OF LOOKING GOOD

Writing code that is stylistically “good” takes time. You probably don't need much time to whip together a quick-and-dirty program to parse an XML file. Writing the same program with functional decomposition, adequate comments, and a clean structure would take you more time. Is it really worth it?

Thinking Ahead

How confident would you be in your code if a new programmer had to work with it a year from now? A friend of mine, faced with a growing mess of web application code, encouraged his team to think about a hypothetical intern who would be starting in a year. How would this poor intern ever get up to speed on the code base when there was no documentation and scary multiple-page functions? When you're writing code, imagine that somebody new or even you will have to maintain it in the future. Will you even still remember how it works? What if you're not available to help? Well-written code avoids these problems because it is easy to read and understand.

Elements of Good Style

It is difficult to enumerate the characteristics of code that make it “stylistically good.” Over time, you'll find styles that you like and notice useful techniques in code that others wrote. Perhaps more important, you'll encounter horrible code that teaches you what to avoid. However, good code shares several universal tenets that are explored in this chapter:

- Documentation
- Decomposition
- Naming
- Use of the language
- Formatting

DOCUMENTING YOUR CODE

In the programming context, documentation usually refers to comments contained in the source files. Comments are your opportunity to tell the world what was going through your head when you wrote the accompanying code. They are a place to say anything that isn't obvious from looking at the code itself.

Reasons to Write Comments

It may seem obvious that writing comments is a good idea, but have you ever stopped to think about why you need to comment your code? Sometimes programmers acknowledge the importance of commenting without fully understanding why comments are important. There are several reasons, all of which are explored in this chapter.

Commenting to Explain Usage

One reason to use comments is to explain how clients should interact with the code. Normally, a developer should be able to understand what a function does simply based on the name of the function, the type of the return value, and the name and type of its parameters. However, not everything can be expressed in code. Sometimes a function requires certain pre- or postconditions that you have to explain in a comment. Exceptions that can be thrown by a function are also something that

should be explained in a comment. In my opinion, you should only add a comment if it really adds any useful information. So, it's up to the developer to decide whether a function needs a comment or not. Experienced programmers will have no problems deciding this, but less experienced developers might not always make the right decision. That's why some companies have a rule stating that each publicly accessible function or method in a header file should have a comment explaining what it does. Some organizations go even further and formalize these comments by explicitly listing the purpose of each method, what its arguments are, what values it returns, and possible exceptions it can throw.

A comment gives you the opportunity to state, in English, anything that you can't state in code. For example, there's really no way in C++ code to indicate that the `saveRecord()` method of a database object throws an exception if `openDatabase()` has not been called yet. A comment, however, can be the perfect place to note this restriction, as follows:

```
/*
 * This method throws a "DatabaseNotOpenedException"
 * if the openDatabase() method has not been called yet.
 */
int saveRecord(Record& record);
```

The C++ language forces you to specify the return type of a method, but it does not provide a way for you to say what the returned value actually represents. For example, the declaration of the `saveRecord()` method may indicate that it returns an `int` (a bad design decision discussed further in this section), but the client reading that declaration wouldn't know what the `int` means. A comment explains the meaning of it:

```
/*
 * Returns: int
 *   An integer representing the ID of the saved record.
 * Throws:
 *   DatabaseNotOpenedException if the openDatabase() method has not
 *   been called yet.
 */
int saveRecord(Record& record);
```

As mentioned earlier, some companies require everything about a function to be documented in a formal way. The following is an example of how such a comment for the `saveRecord()` method might look like:

```
/*
 * saveRecord()
 *
 * Saves the given record to the database.
 *
 * Parameters:
 *   Record& record: the record to save to the database.
 * Returns: int
 *   An integer representing the ID of the saved record.
 * Throws:
 *   DatabaseNotOpenedException if the openDatabase() method has not
 *   been called yet.
 */
int saveRecord(Record& record);
```

However, I don't recommend this style of commenting. The first two lines are completely useless, since the name of the function is self-explanatory. The description of the parameter also does not add any additional information. Documenting what exactly the return type represents for this version of `saveRecord()` is required since it returns a generic `int`. However, a much better design would be to return a `RecordID` instead of a plain `int`, which removes the need to add any comments for the return type. `RecordID` could simply be a type alias (see Chapter 11) for `int`, but it conveys more information. The only comment that should remain is the exception. So, the following is my recommendation for the `saveRecord()` method:

```
/*
 * Throws:
 *     DatabaseNotOpenedException if the openDatabase() method has not
 *     been called yet.
 */
RecordID saveRecord(Record& record);
```

NOTE *If your company coding guidelines don't force you to write formal comments for functions, use common sense when writing comments. Only state something in a comment that is not obvious based on the name of the function, the type of the return value, and the name and type of its parameters.*

Sometimes, the parameters to, and the return type from, a function are generic and can be used to pass all kinds of information. In that case you need to clearly document exactly what type is being passed. For example, message handlers in Windows accept two parameters, `LPARAM` and `LPARAM`, and can return an `LRESULT`. All three can be used to pass anything you like, but you cannot change their type. By using type casting, they can, for example, be used to pass a simple integer or to pass a pointer to some object. Your documentation could look like this:

```
* Parameters:
*     WPARAM wParam: (LPARAM) (int): An integer representing...
*     LPARAM lParam: (LPARAM) (string*): A string pointer representing...
* Returns: (LRESULT) (Record*)
*     nullptr in case of an error, otherwise a pointer to a Record object
*     representing...
```

Commenting to Explain Complicated Code

Good comments are also important inside the actual source code. In a simple program that processes input from the user and writes a result to the console, it is probably easy to read through and understand all of the code. In the professional world, however, you will often need to write code that is algorithmically complex or too esoteric to understand simply by inspection.

Consider the code that follows. It is well written, but it may not be immediately apparent what it is doing. You might recognize the algorithm if you have seen it before, but a newcomer probably wouldn't understand the way the code works.

```
void sort(int inArray[], size_t inSize)
{
    for (size_t i = 1; i < inSize; i++) {
        int element = inArray[i];
        size_t j = i - 1;
```

```

        while (j >= 0 && inArray[j] > element) {
            inArray[j+1] = inArray[j];
            j--;
        }
        inArray[j+1] = element;
    }
}

```

A better approach would be to include comments that describe the algorithm that is being used, and to document (loop) invariants. Invariants are conditions that have to be true during the execution of a piece of code, for example, a loop iteration. In the modified function that follows, a thorough comment at the top explains the algorithm at a high level, and inline comments explain specific lines that may be confusing:

```

/*
 * Implements the "insertion sort" algorithm. The algorithm separates the
 * array into two parts--the sorted part and the unsorted part. Each
 * element, starting at position 1, is examined. Everything earlier in the
 * array is in the sorted part, so the algorithm shifts each element over
 * until the correct position is found to insert the current element. When
 * the algorithm finishes with the last element, the entire array is sorted.
 */
void sort(int inArray[], size_t inSize)
{
    // Start at position 1 and examine each element.
    for (size_t i = 1; i < inSize; i++) {
        // Loop invariant:
        //     All elements in the range 0 to i-1 (inclusive) are sorted.

        int element = inArray[i];
        // j marks the position in the sorted part after which element
        // will be inserted.
        size_t j = i - 1;
        // As long as the current slot in the sorted array is higher than
        // element, shift values to the right to make room for inserting
        // (hence the name, "insertion sort") element in the right position.
        while (j >= 0 && inArray[j] > element) {
            inArray[j+1] = inArray[j];
            j--;
        }
        // At this point the current position in the sorted array
        // is not greater than the element, so this is its new position.
        inArray[j+1] = element;
    }
}

```

The new code is certainly more verbose, but a reader unfamiliar with sorting algorithms would be much more likely to understand it with the comments included.

Commenting to Convey Meta-information

Another possible reason to use comments is to provide information at a higher level than the code itself. This *meta-information* provides details about the creation of the code without addressing the specifics of its behavior. For example, your organization may want to keep track of the original author of each method. You can also use meta-information to cite external documents or refer to other code.

The following example shows several instances of meta-information, including the author, the date it was created, and the specific feature it addresses. It also includes inline comments expressing metadata, such as the bug number that corresponds to a line of code and a reminder to revisit a possible problem in the code later.

```

/*
 * Author:  marcg
 * Date:    110412
 * Feature: PRD version 3, Feature 5.10
 */
RecordID saveRecord(Record& record)
{
    if (!mDatabaseOpen) {
        throw DatabaseNotOpenedException();
    }
    RecordID id = getDB()->saveRecord(record);
    if (id == -1) return -1; // Added to address bug #142 - jsmith 110428
    record.setId(id);
    // TODO: What if setId() throws an exception? - akshayr 110501
    return id;
}

```

A change-log could also be included at the beginning of each file. The following shows a possible example of such a change-log:

```

/*
 * Date      | Change
 *-----+-----
 * 110413    | REQ #005: <marcg> Do not normalize values.
 * 110417    | REQ #006: <marcg> use nullptr instead of NULL.
 */

```

WARNING *All the meta-information in the previous examples (except for the “TODO” comment) is discouraged when you use—and you should use—a source code control solution, as discussed in Chapter 24. Such a solution offers an annotated change history with revision dates, authors, and, if properly used, comments accompanying each modification, including references to change requests and bug reports. You should check in or commit each change request or bug fix separately with a descriptive comment. With such a system, you don’t need to manually keep track of meta-information.*

Another type of meta-information is a copyright notice. Some companies require such a copyright notice at the very beginning of every source file.

It’s easy to go overboard with comments. A good approach is to discuss which types of comments are most useful with your group and to form a policy. For example, if one member of the group uses a “TODO” comment to indicate code that still needs work, but nobody else knows about this convention, the code in need of attention could be overlooked.

Commenting Styles

Every organization has a different approach to commenting code. In some environments, a particular style is mandated to give the code a common standard for documentation. Other times, the quantity and style of commenting is left up to the programmer. The following examples depict several approaches to commenting code.

Commenting Every Line

One way to avoid lack of documentation is to force yourself to overdocument by including a comment for every line. Commenting every line of code should ensure that there's a specific reason for everything you write. In reality, such heavy commenting on a large scale is unwieldy, messy, and tedious! For example, consider the following useless comments:

```
int result; // Declare an integer to hold the result.
result = doodad.getResult(); // Get the doodad's result.
if (result % 2 == 0) { // If the result modulo 2 is 0 ...
    logError(); // then log an error,
} else { // otherwise ...
    logSuccess(); // log success.
} // End if/else
return result; // Return the result
```

The comments in this code express each line as part of an easily readable English story. This is entirely useless if you assume that the reader has at least basic C++ skills. These comments don't add any additional information to code. Specifically, look at this line:

```
if (result % 2 == 0) { // If the result modulo 2 is 0 ...
```

The comment is just an English translation of the code. It doesn't say *why* the programmer has used the modulo operator on the result with the value 2. The following would be a better comment:

```
if (result % 2 == 0) { // If the result is even ...
```

The modified comment, while still fairly obvious to most programmers, gives additional information about the code. The modulo operator with 2 is used because the code needs to check if the result is even.

Despite its tendency to be verbose and superfluous, heavy commenting can be useful in cases where the code would otherwise be difficult to comprehend. The following code also comments every line, but these comments are actually helpful:

```
// Calculate the doodad. The start, end, and offset values come from the
// table on page 96 of the "Doodad API v1.6".
result = doodad.calculate(kStart, kEnd, kOffset);
// To determine success or failure, we need to bitwise AND the result with
// the processor-specific mask (see "Doodad API v1.6", page 201).
result &= getProcessorMask();
// Set the user field value based on the "Marigold Formula."
// (see "Doodad API v1.6", page 136)
setUserField((result + kMarigoldOffset) / MarigoldConstant + MarigoldConstant);
```

This code is taken out of context, but the comments give you a good idea of what each line does. Without them, the calculations involving `&` and the mysterious “Marigold Formula” would be difficult to decipher.

NOTE *Commenting every line of code is usually not warranted, but if the code is complicated enough to require it, don't just translate the code to English: explain what's really going on.*

Prefix Comments

Your group may decide to begin all source files with a standard comment. This is an excellent opportunity to document important information about the program and specific file. Examples of information that you might want to document at the top of every file include the following:

- The last-modified date*
- The original author*
- A change-log (as described earlier)*
- The feature ID addressed by the file
- Copyright information
- A brief description of the file/class
- Incomplete features
- Known bugs

The items marked with an asterisk are usually automatically handled by your source code control solution.

Your development environment may allow you to create a template that automatically starts new files with your prefix comment. Some source control systems such as Subversion (SVN) can even assist by filling in metadata. For example, if your comment contains the string `Id`, SVN can automatically expand the comment to include the author, filename, revision, and date.

An example of a prefix comment is shown here:

```
/*
 * $Id: Watermelon.cpp,123 2004/03/10 12:52:33 marcg $
 *
 * Implements the basic functionality of a watermelon. All units are expressed
 * in terms of seeds per cubic centimeter. Watermelon theory is based on the
 * white paper "Algorithms for Watermelon Processing."
 *
 * The following code is (c) copyright 2017, FruitSoft, Inc. ALL RIGHTS RESERVED
 */
```

Fixed-Format Comments

Writing comments in a standard format that can be parsed by external document builders is an increasingly popular programming practice. In the Java language, programmers can write comments in a standard format that allows a tool called Javadoc to automatically create hyperlinked documentation for the project. For C++, a free tool called Doxygen (available at www.doxygen.org) parses comments to automatically build HTML documentation, class diagrams, UNIX man pages, and other useful documents. Doxygen even recognizes and parses Javadoc-style comments in C++ programs. The code that follows shows Javadoc-style comments that are recognized by Doxygen:

```
/**
 * Implements the basic functionality of a watermelon
 * TODO: Implement updated algorithms!
 */
class Watermelon
{
    public:
        /**
         * @param initialSeeds The starting number of seeds, must be > 0.
         */
        Watermelon(int initialSeeds);

        /**
         * Computes the seed ratio, using the Marigold algorithm.
         * @param slowCalc Whether or not to use long (slow) calculations
         * @return The marigold ratio
         */
        double calcSeedRatio(bool slowCalc);
};
```

Doxygen recognizes the C++ syntax and special comment directives such as `@param` and `@return` to generate customizable output. An example of a Doxygen-generated HTML class reference is shown in Figure 3-1.

Note that you should still avoid writing useless comments, including when you use a tool to automatically generate documentation. Take a look at the `Watermelon` constructor in the previous code. Its comment omits a description and only describes the parameter. Adding a description, as in the following example, is redundant:

```
/**
 * The Watermelon constructor.
 * @param initialSeeds The starting number of seeds, must be > 0.
 */
Watermelon(int initialSeeds);
```

Automatically generated documentation like the file shown in Figure 3-1 can be helpful during development because it allows developers to browse through a high-level description of classes and their relationships. Your group can easily customize a tool like Doxygen to work with the style of comments that you have adopted. Ideally, your group would set up a machine that builds documentation on a daily basis.

The screenshot shows a web-based class reference for a class named 'Watermelon'. At the top, there are navigation tabs for 'Main Page', 'Classes', and 'Files', along with a search bar. The title is 'Watermelon Class Reference' with a link to 'Public Member Functions | List of all members'. Below the title, there is a preprocessor directive: `#include <Watermelon.h>`. The 'Public Member Functions' section lists `Watermelon (int initialSeeds)` and `double calcSeedRatio (bool slowCalc)`. The 'Detailed Description' section contains the text: 'Implements the basic functionality of a watermelon TODO: Implement updated algorithms!'. The 'Constructor & Destructor Documentation' section shows the `Watermelon()` constructor with the signature `Watermelon::Watermelon (int initialSeeds)` and a 'Parameters' section stating: '`initialSeeds` The starting number of seeds, must be > 0.'. The 'Member Function Documentation' section shows the `calcSeedRatio()` function with the signature `double Watermelon::calcSeedRatio (bool slowCalc)`. Its description is 'Computes the seed ratio, using the Marigold algorithm.'. It has a 'Parameters' section for '`slowCalc` Whether or not to use long (slow) calculations' and a 'Returns' section stating 'The marigold ratio'.

FIGURE 3-1

Ad Hoc Comments

Most of the time, you use comments on an as-needed basis. Here are some guidelines for comments that appear within the body of your code:

- Avoid offensive or derogatory language. You never know who might look at your code someday.
- Liberal use of inside jokes is generally considered okay. Check with your manager.
- Before adding a comment, first consider whether you can rework the code to make the comment redundant. For example, by renaming variables, functions, and classes, by reordering steps in the code, by introducing intermediate well-named variables, and so on.

- Imagine someone else is reading your code. If there are subtleties that are not immediately obvious, then you should document those.
- Don't put your initials in the code. Source code control solutions will track that kind of information automatically for you.
- If you are doing something with an API that isn't immediately obvious, include a reference to the documentation of that API where it is explained.
- Remember to update your comments when you update the code. Nothing is more confusing than code that is fully documented with incorrect information.
- If you use comments to separate a function into sections, consider whether the function might be broken into multiple, smaller functions.

Self-Documenting Code

Well-written code often doesn't need abundant commenting. The best code is written to be readable. If you find yourself adding a comment for every line, consider whether the code could be rewritten to better match what you are saying in the comments. For example, use descriptive names for your functions, parameters, variables, classes, and so on. Properly make use of `const`; that is, if a variable is not supposed to be modified, mark it as `const`. Reorder the steps in a function to make it clearer what it is doing. Introduce intermediate well-named variables to make an algorithm easier to understand. Remember that C++ is a language. Its main purpose is to tell the computer what to do, but the semantics of the language can also be used to explain its meaning to a reader.

Another way of writing self-documenting code is to break up, or *decompose*, your code into smaller pieces. Decomposition is covered in detail in the following section.

NOTE *Good code is naturally readable and only requires comments to provide useful additional information.*

DECOMPOSITION

Decomposition is the practice of breaking up code into smaller pieces. There is nothing more daunting in the world of coding than opening up a file of source code to find 300-line functions and massive, nested blocks of code. Ideally, each function or method should accomplish a single task. Any subtasks of significant complexity should be decomposed into separate functions or methods. For example, if somebody asks you what a method does and you answer, "First it does A, then it does B; then, if C, it does D; otherwise, it does E," you should probably have separate helper methods for A, B, C, D, and E.

Decomposition is not an exact science. Some programmers will say that no function should be longer than a page of printed code. That may be a good rule of thumb, but you could certainly find a quarter-page of code that is desperately in need of decomposition. Another rule of thumb is that if you squint your eyes and look at the format of the code without reading the actual content, it shouldn't appear too dense in any one area. For example, Figures 3-2 and 3-3 show code that has

been purposely blurred so that you don't focus on the content. It should be obvious that the code in Figure 3-3 has better decomposition than the code in Figure 3-2.

Decomposition through Refactoring

Sometimes, when you've had a few coffees and you're really in the programming zone, you start coding so fast that you end up with code that does exactly what it's supposed to do, but is far from pretty. All programmers do this from time to time. Short periods of vigorous coding are sometimes the most productive times in the course of a project. Dense code also arises over the course of time as code is modified. As new requirements and bug fixes emerge, existing code is amended with small modifications. The computing term *cruff* refers to the gradual accumulation of small amounts of code that eventually turns a once-elegant piece of code into a mess of patches and special cases.

Refactoring is the act of restructuring your code. The following list contains example techniques that you can use to refactor your code. Consult one of the refactoring books in Appendix B to get a more comprehensive list.

- Techniques that allow for more abstraction:
 - **Encapsulate Field.** Make a field private and give access to it with getter and setter methods.
 - **Generalize Type.** Create more general types to allow for more code sharing.
- Techniques for breaking code apart into more logical pieces:
 - **Extract Method.** Turn part of a larger method into a new method to make it easier to understand.
 - **Extract Class.** Move part of the code from an existing class into a new class.
- Techniques for improving names and the location of code:
 - **Move Method or Move Field.** Move to a more appropriate class or source file.
 - **Rename Method or Rename Field.** Change the name to better reveal its purpose.
 - **Pull Up.** In object-oriented programming, move to a base class.
 - **Push Down.** In object-oriented programming, move to a derived class.

Whether your code starts its life as a dense block of unreadable cruff or it just evolves that way, refactoring is necessary to periodically purge the code of accumulated hacks. Through refactoring, you revisit existing code and rewrite it to make it more readable and maintainable. Refactoring is

```
void someFunction(int arg1, char arg2, Structure *arg3)
{
    agrgs_sfunc(arg1, arg2);
    def1 def;
    int sfunc;

    if (afa & feff && arg1 || arg1->fef) {
        dfad1 df = dfad1;
        arg1->wefefwef1df1;
        out1 => arg1;
        out2 => "wefef defad1 d dfad1 " << endl;
    } else {
        dfadef1 ad fadefad1;
        out1 => arg1->wefef;
        out2 => "wefef" << endl;
    }

    // now do something else
    out1 => "thing1: " << arg1->wefef << endl;
    out2 => "thing2: " << arg1->wefef << endl;
    out3 => "thing3: " << arg1->f1f1f << endl;
}
```

FIGURE 3-2

```
void someFunction(int arg1, char arg2, Structure *arg3)
{
    agrgs_sfunc(arg1, arg2);

    if (adef1f()) {
        thing1();
    } else {
        thing1();
    }

    thing1();
}

bool adef1f()
{
    return afa & feff && arg1 || arg1->fef;
}

void thing1()
{
    dfad1 df = dfad1;
    arg1->wefefwef1df1;
    out1 => arg1;
    out2 => "wefef defad1 d dfad1 " << endl;
}

void thing1()
{
    dfadef1 ad fadefad1;
    out1 => arg1->wefef;
    out2 => "wefef" << endl;
}

void thing1()
{
    out1 => "thing1: " << arg1->wefef << endl;
    out2 => "thing2: " << arg1->wefef << endl;
    out3 => "thing3: " << arg1->f1f1f << endl;
}
```

FIGURE 3-3

an opportunity to revisit the decomposition of code. If the purpose of the code has changed or if it was never decomposed in the first place, when you refactor the code, squint at it and determine if it needs to be broken down into smaller parts.

When refactoring code, it is very important to be able to rely on a testing framework that catches any defects that you might introduce. Unit tests, discussed in Chapter 26, are particularly well suited for helping you catch mistakes during refactoring.

Decomposition by Design

If you use modular decomposition and approach every module, method, or function by considering what pieces of it you can put off until later, your programs will generally be less dense and more organized than if you implement every feature in its entirety as you code.

Of course, you should still design your program *before* jumping into the code.

Decomposition in This Book

You will see decomposition in many of the examples in this book. In many cases, methods are referred to for which no implementation is shown because they are not relevant to the example and would take up too much space.

NAMING

The C++ compiler has a few naming rules:

- Names cannot start with a number (for example, 9t05).
- Names that contain a double underscore (such as `my__name`) are reserved and shall not be used.
- Names that begin with an underscore (such as `_name` or `_Name`) are reserved and shall not be used.

Other than those rules, names exist only to help you and your fellow programmers work with the individual elements of your program. Given this purpose, it is surprising how often programmers use unspecific or inappropriate names.

Choosing a Good Name

The best name for a variable, method, function, parameter, class, namespace, and so on accurately describes the purpose of the item. Names can also imply additional information, such as the type or specific usage. Of course, the real test is whether other programmers understand what you are trying to convey with a particular name.

There are no set-in-stone rules for naming other than the rules that work for your organization. However, there are some names that are rarely appropriate. The following table shows some names at both ends of the naming continuum.

GOOD NAMES	BAD NAMES
sourceName, destinationName Distinguishes two objects	thing1, thing2 Too general
gSettings Conveys global status	globalUserSpecificSettingsAndPreferences Too long
mNameCounter Conveys data member status	mNC Too obscure, too brief
calculateMarigoldOffset() Simple, accurate	doAction() Too general, imprecise
mTypeString Easy on the eyes	typeSTR256 A name only a computer could love
	mIHateLarry Unacceptable inside joke
errorMessage Descriptive name	string Non-descriptive name
sourceFile, destinationFile No abbreviations	srcFile, dstFile Abbreviations

Naming Conventions

Selecting a name doesn't always require a lot of thought and creativity. In many cases, you'll want to use standard techniques for naming. Following are some of the types of data for which you can make use of standard names.

Counters

Early in your programming career, you probably saw code that used the variable “i” as a counter. It is customary to use *i* and *j* as counters and inner-loop counters, respectively. Be careful with nested loops, however. It's a common mistake to refer to the “ith” element when you really mean the “jth” element. When working with 2-D data, it's probably easier to use *row* and *column* as indices, instead of *i* and *j*. Some programmers prefer using counters *outerLoopIndex* and *innerLoopIndex*, and some even frown upon using *i* and *j* as loop counters.

Prefixes

Many programmers begin their variable names with a letter that provides some information about the variable's type or usage. On the other hand, there are as many programmers, or even more, who disapprove of using any kind of prefix because this could make evolving code less maintainable in the future. For example, if a member variable is changed from *static* to non-*static*, you have to

rename all the uses of that name. If you don't rename them, your names continue to convey semantics, but now they are the wrong semantics.

However, you often don't have a choice and you need to follow the guidelines of your company. The following table shows some potential prefixes.

PREFIX	EXAMPLE NAME	LITERAL PREFIX MEANING	USAGE
m m_	mData m_data	"member"	Data member within a class
s ms ms_	sLookupTable msLookupTable ms_lookupTable	"static"	Static variable or data member
k	kMaximumLength	"konstant" (German for "constant")	A constant value. Some programmers use all uppercase names without a prefix to indicate constants.
b is	bCompleted isCompleted	"Boolean"	Designates a Boolean value
n mNum	nLines mNumLines	"number"	A data member that is also a counter. Because an "n" looks similar to an "m," some programmers instead use mNum as a prefix.

Hungarian Notation

Hungarian Notation is a variable and data-member-naming convention that is popular with Microsoft Windows programmers. The basic idea is that instead of using single-letter prefixes such as `m`, you should use more verbose prefixes to indicate additional information. The following line of code shows the use of Hungarian Notation:

```
char* pszName; // psz means "pointer to a null-terminated string"
```

The term *Hungarian Notation* arose from the fact that its inventor, Charles Simonyi, is Hungarian. Some also say that it accurately reflects the fact that programs using Hungarian Notation end up looking as if they were written in a foreign language. For this latter reason, some programmers tend to dislike Hungarian Notation. In this book, prefixes are used, but not Hungarian Notation. Adequately named variables don't need much additional context information besides the prefix. For example, a data member named `mName` says it all.

NOTE *Good names convey information about their purpose without making the code unreadable.*

Getters and Setters

If your class contains a data member, such as `mStatus`, it is customary to provide access to the member via a getter called `getStatus()` and a setter called `setStatus()`. To give access to a Boolean data member, you typically use `is` as a prefix instead of `get`, for example `isRunning()`. The C++ language has no prescribed naming for these methods, but your organization will probably want to adopt this or a similar naming scheme.

Capitalization

There are many different ways of capitalizing names in your code. As with most elements of coding style, it is very important that your group adopts a standardized approach and that all members adopt that approach. One way to get messy code is to have some programmers naming classes in all lowercase with underscores representing spaces (`priority_queue`) and others using capitals with each subsequent word capitalized (`PriorityQueue`). Variables and data members almost always start with a lowercase letter and use either underscores (`my_queue`) or capitals (`myQueue`) to indicate word breaks. Functions and methods are traditionally capitalized in C++, but, as you've seen, in this book I have adopted the style of lowercase functions and methods to distinguish them from class names. A similar style of capitalizing letters is used to indicate word boundaries for class and data member names.

Namespaced Constants

Imagine that you are writing a program with a graphical user interface. The program has several menus, including File, Edit, and Help. To represent the ID of each menu, you may decide to use a constant. A perfectly reasonable name for a constant referring to the Help menu ID is `kHelp`.

The name `kHelp` will work fine until you add a Help button to the main window. You also need a constant to refer to the ID of the button, but `kHelp` is already taken.

A possible solution for this is to put your constants in different namespaces, which are discussed in Chapter 1. You create two namespaces: `Menu` and `Button`. Each namespace has a `kHelp` constant and you use them as `Menu::kHelp` and `Button::kHelp`. Another, and more recommended solution is to use enumerated types, also introduced in Chapter 1.

USING LANGUAGE FEATURES WITH STYLE

The C++ language lets you do all sorts of terribly unreadable things. Take a look at this wacky code:

```
i++ + ++i;
```

This is unreadable but more importantly, its behavior is undefined by the C++ standard. The problem is that `i++` uses the value of `i` but has a side effect of incrementing it. The standard does not say when this incrementing should be done, only that the side effect (increment) should be visible after the sequence point “;”, but the compiler can do it at any time during the execution of that line. It's impossible to know which value of `i` will be used for the `++i` part. Running this code with different compilers and platforms can result in different values.

The following is another example of code which you should avoid, because it exhibits undefined behavior if your compiler is not C++17 compliant. With C++17, this has well-defined behavior: first `i` is incremented, and then used as index in `a[i]`.

```
a[i] = ++i;
```

With all the power that the C++ language offers, it is important to consider how the language features can be used toward stylistic good instead of evil.

Use Constants

Bad code is often littered with “magic numbers.” In some function, the code might be using 2.71828. Why 2.71828? What does that value mean? People with a mathematical background might find it obvious that this represents an approximation of the transcendental value e , but most people don’t know this. The language offers constants to give a symbolic name to a value that doesn’t change, such as 2.71828.

```
const double kApproximationForE = 2.71828182845904523536;
```

Use References Instead of Pointers

Traditionally, C++ programmers learned C first. In C, pointers were the only pass-by-reference mechanism, and they certainly worked just fine for many years. Pointers are still required in some cases, but in many situations you can switch to references. If you learned C first, you probably think that references don’t really add any new functionality to the language. You might think that they merely introduce a new syntax for functionality that pointers could already provide.

There are several advantages to using references rather than pointers. First, references are safer than pointers because they don’t deal directly with memory addresses and cannot be `nullptr`. Second, references are more stylistically pleasing than pointers because they use the same syntax as stack variables, avoiding symbols such as `*` and `&`. They’re also easy to use, so you should have no problem adopting references into your style palette. Unfortunately, some programmers think that if they see an `&` in a function call, they know the called function is going to change the object, and if they don’t see the `&` it must be pass-by-value. With references, they say they don’t know if the function is going to change the object unless they look at the function prototype. This is a wrong way of thinking. Passing in a pointer does not automatically mean that the object will be modified, because the parameter might be `const T*`. Passing both a pointer and a reference can modify the object, or it may not, depending on whether the function prototype uses `const T*`, `T*`, `const T&`, or `T&`. So, you need to look at the prototype anyway to know if the function might change the object.

Another benefit of references is that they clarify ownership of memory. If you are writing a method and another programmer passes you a reference to an object, it is clear that you can read and possibly modify the object, but you have no easy way of freeing its memory. If you are passed a pointer, this is less clear. Do you need to delete the object to clean up memory? Or will the caller do that? Note that the preferred way of handling memory is to use smart pointers, introduced in Chapter 1.

Use Custom Exceptions

C++ makes it easy to ignore exceptions. Nothing about the language syntax forces you to deal with exceptions and you could easily write error-tolerant programs with traditional mechanisms such as returning `nullptr` or setting an error flag.

Exceptions provide a much richer mechanism for error handling, and custom exceptions allow you to tailor this mechanism to your needs. For example, a custom exception type for a web browser could include fields that specify the web page that contained the error, the network state when the error occurred, and additional context information.

Chapter 14 contains a wealth of information about exceptions in C++.

NOTE *Language features exist to help the programmer. Understand and make use of features that contribute to good programming style.*

FORMATTING

Many programming groups have been torn apart and friendships ruined over code-formatting arguments. In college, a friend of mine got into such a heated debate with a peer over the use of spaces in an `if` statement that people were stopping by to make sure that everything was okay.

If your organization has standards in place for code formatting, consider yourself lucky. You may not like the standards they have in place, but at least you won't have to argue about them.

If no standards are in place for code formatting, I recommend to introduce them in your organization. Standardized coding guidelines make sure that all programmers on your team follow the same naming conventions, formatting rules, and so on, which makes the code more uniform and easier to understand.

If everybody on your team is just writing code their own way, try to be as tolerant as you can. As you'll see, some practices are just a matter of taste, while others actually make it difficult to work in teams.

The Curly Brace Alignment Debate

Perhaps the most frequently debated point is where to put the curly braces that demarcate a block of code. There are several styles of curly brace use. In this book, the curly brace is put on the same line as the leading statement, except in the case of a function, class, or method name. This style is shown in the code that follows (and throughout this book):

```
void someFunction()
{
    if (condition()) {
        cout << "condition was true" << endl;
    } else {
        cout << "condition was false" << endl;
    }
}
```

This style conserves vertical space while still showing blocks of code by their indentation. Some programmers would argue that preservation of vertical space isn't relevant in real-world coding. A more verbose style is shown here:

```
void someFunction()
{
    if (condition())
    {
        cout << "condition was true" << endl;
    }
    else
    {
        cout << "condition was false" << endl;
    }
}
```

Some programmers are even liberal with the use of horizontal space, yielding code like this:

```
void someFunction()
{
    if (condition())
    {
        cout << "condition was true" << endl;
    }
    else
    {
        cout << "condition was false" << endl;
    }
}
```

Another point of debate is whether or not to put braces around single statements, for example:

```
void someFunction()
{
    if (condition())
        cout << "condition was true" << endl;
    else
        cout << "condition was false" << endl;
}
```

Of course, I won't recommend any particular style because I don't want hate mail.

NOTE *When selecting a style for denoting blocks of code, the important consideration is how well you can see which block falls under which condition simply by looking at the code.*

Coming to Blows over Spaces and Parentheses

The formatting of individual lines of code can also be a source of disagreement. Again, I won't advocate a particular approach, but you are likely to encounter a few of the styles shown here.

In this book, I use a space after any keyword, a space before and after any operator, a space after every comma in a parameter list or a call, and parentheses to clarify the order of operations, as follows:

```
if (i == 2) {  
    j = i + (k / m);  
}
```

An alternative, shown next, treats `if` stylistically like a function, with no space between the keyword and the left parenthesis. Also, the parentheses used to clarify the order of operations inside of the `if` statement are omitted because they have no semantic relevance.

```
if( i == 2 ) {  
    j = i + k / m;  
}
```

The difference is subtle, and the determination of which is better is left to the reader, yet I can't move on from the issue without pointing out that `if` is not a function.

Spaces and Tabs

The use of spaces and tabs is not merely a stylistic preference. If your group does not agree on a convention for spaces and tabs, there are going to be major problems when programmers work jointly. The most obvious problem occurs when Alice uses four-space tabs to indent code and Bob uses five-space tabs; neither will be able to display code properly when working on the same file. An even worse problem arises when Bob reformats the code to use tabs at the same time that Alice edits the same code; many source code control systems won't be able to merge in Alice's changes.

Most, but not all, editors have configurable settings for spaces and tabs. Some environments even adapt to the formatting of the code as it is read in, or always save using spaces even if the Tab key is used for authoring. If you have a flexible environment, you have a better chance of being able to work with other people's code. Just remember that tabs and spaces are different because a tab can be any length and a space is always a space.

STYLISTIC CHALLENGES

Many programmers begin a new project by pledging that this time, they will do everything right. Any time a variable or parameter shouldn't be changed, it'll be marked `const`. All variables will have clear, concise, readable names. Every developer will put the left curly brace on the subsequent line and will adopt the standard text editor and its conventions for tabs and spaces.

For a number of reasons, it is difficult to sustain this level of stylistic consistency. In the case of `const`, sometimes programmers just aren't educated about how to use it. You will eventually come across old code or a library function that isn't `const`-savvy. A good programmer will use `const_cast()` to temporarily suspend the `const` property of a variable, but an inexperienced programmer will start to unwind the `const` property back from the calling function, once again ending up with a program that never uses `const`.

Other times, standardization of style comes up against programmers' individual tastes and biases. Perhaps the culture of your team makes it impractical to enforce strict style guidelines. In such situations, you may have to decide which elements you really need to standardize (such as variable names and tabs) and which ones are safe to leave up to individuals (perhaps spacing and commenting style). You can even obtain or write scripts that will automatically correct style “bugs” or flag stylistic problems along with code errors. Some development environments, such as Microsoft Visual C++ 2017, support automatic formatting of code according to rules that you specify. This makes it trivial to write code that always follows the guidelines that have been configured.

SUMMARY

The C++ language provides a number of stylistic tools without any formal guidelines on how to use them. Ultimately, any style convention is measured by how widely it is adopted and how much it benefits the readability of the code. When coding as part of a team, you should raise issues of style early in the process as part of the discussion of what language and tools to use.

The most important point about style is to appreciate that it is an important aspect of programming. Teach yourself to check over the style of your code before you make it available to others. Recognize good style in the code you interact with and adopt the conventions that you and your organization find useful.

This chapter concludes the first part of this book. The next part discusses software design on a high level.

PART II

Professional C++ Software Design

- ▶ CHAPTER 4: Designing Professional C++ Programs
- ▶ CHAPTER 5: Designing with Objects
- ▶ CHAPTER 6: Designing for Reuse

4

Designing Professional C++ Programs

WHAT'S IN THIS CHAPTER?

- ▶ The definition of programming design
- ▶ The importance of programming design
- ▶ The aspects of design that are unique to C++
- ▶ The two fundamental themes for effective C++ design: abstraction and reuse
- ▶ The different types of code available for reuse
- ▶ The advantages and disadvantages of code reuse
- ▶ General strategies and guidelines for reusing code
- ▶ Open-source libraries
- ▶ The C++ Standard Library

Before writing a single line of code in your application, you should design your program. What data structures will you use? What classes will you write? This plan is especially important when you program in groups. Imagine sitting down to write a program with no idea what your coworker, who is working on the same program, is planning! In this chapter, you'll learn how to use the Professional C++ approach to C++ design.

Despite the importance of design, it is probably the most misunderstood and underused aspect of the software-engineering process. Too often, programmers jump into applications without a clear plan: they design as they code. This approach can lead to convoluted and overly complicated designs. It also makes development, debugging, and maintenance tasks more difficult.

Although it seems counterintuitive, investing extra time at the beginning of a project to design it properly actually saves time over the life of the project.

WHAT IS PROGRAMMING DESIGN?

The very first step when starting a new program, or a new feature for an existing program, is to analyze the requirements. This involves having discussions with your *stakeholders*. A vital outcome of this analysis phase is a *functional requirements* document describing *what* exactly the new piece of code has to do, but it does not explain *how* it has to do it. Requirement analysis can also result in a *non-functional requirements* document describing how the final system should *be*, compared to what it should *do*. Examples of non-functional requirements are that the system needs to be secure, extensible, satisfy certain performance criteria, and so on.

Once all requirements have been collected, the design phase of the project can start. Your *program design*, or *software design*, is the specification of the architecture that you will implement to fulfill all the requirements (functional and non-functional) of the program. Informally, the design is how you plan to write the program. You should generally write your design in the form of a design document. Although every company or project has its own variation of a desired design document format, most design documents share the same general layout, which includes two main parts:

1. The gross subdivision of the program into subsystems, including interfaces and dependencies between the subsystems, data flow between the subsystems, input and output to and from each subsystem, and a general threading model.
2. The details of each subsystem, including subdivision into classes, class hierarchies, data structures, algorithms, a specific threading model, and error-handling specifics.

The design documents usually include diagrams and tables showing subsystem interactions and class hierarchies. The Unified Modeling Language (UML) is the industry standard for such diagrams, and is used for diagrams in this and subsequent chapters. (See Appendix D for a brief introduction to the UML syntax.) With that being said, the exact format of the design document is less important than the process of thinking about your design.

NOTE *The point of designing is to think about your program before you write it.*

You should generally try to make your design as good as possible before you begin coding. The design should provide a map of the program that any reasonable programmer could follow in order to implement the application. Of course, it is inevitable that the design will need to be modified once you begin coding and you encounter issues that you didn't think of earlier. Software-engineering processes have been designed to give you the flexibility to make these changes. Scrum, an agile software development methodology, is one example of such an iterative process whereby the application is developed in cycles, known as sprints. With each sprint, designs can be modified, and new requirements can be taken into account. Chapter 24 describes various software-engineering process models in more detail.

THE IMPORTANCE OF PROGRAMMING DESIGN

It's tempting to skip the analysis and design steps, or to perform them only cursorily, in order to begin programming as soon as possible. There's nothing like seeing code compiling and running to give you the impression that you have made progress. It seems like a waste of time to formalize a design, or to write down functional requirements when you already know, more or less, how you want to structure your program. Besides, writing a design document just isn't as much fun as coding. If you wanted to write papers all day, you wouldn't be a computer programmer! As a programmer myself, I understand this temptation to begin coding immediately, and have certainly succumbed to it on occasion. However, it will most likely lead to problems on all but the simplest projects. Whether or not you succeed without a design prior to the implementation depends on your experience as a programmer, your proficiency with commonly used design patterns, and how deeply you understand C++, the problem domain, and the requirements.

If you are working in a team where each team member will work on a different part of the project, it is paramount that there is a design document for all team members to follow. Design documents also help newcomers to get up to speed with the designs of a project.

To help you understand the importance of programming design, imagine that you own a plot of land on which you want to build a house. When the builder shows up, you ask to see the blueprints. "What blueprints?" he responds. "I know what I'm doing. I don't need to plan every little detail ahead of time. Two-story house? No problem. I did a one-story house a few months ago—I'll just start with that model and work from there."

Suppose that you suspend your disbelief and allow the builder to proceed. A few months later, you notice that the plumbing appears to run outside the house instead of inside the walls. When you query the builder about this anomaly, he says, "Oh. Well, I forgot to leave space in the walls for the plumbing. I was so excited about this new drywall technology that it just slipped my mind. But it works just as well outside, and functionality is the most important thing." You're starting to have your doubts about his approach, but, against your better judgment, you allow him to continue.

When you take your first tour of the completed building, you notice that the kitchen lacks a sink. The builder excuses himself by saying, "We were already two-thirds done with the kitchen by the time we realized there wasn't space for the sink. Instead of starting over, we just added a separate sink room next door. It works, right?"

Do the builder's excuses sound familiar if you translate them to the software domain? Have you ever found yourself implementing an "ugly" solution to a problem like putting plumbing outside the house? For example, maybe you forgot to include locking in your queue data structure that is shared between multiple threads. By the time you realize the problem, you decide to just perform the locking manually on all places where the queue is used. Sure, it's ugly, but it works, you say. That is, until someone new joins the project who assumes that the locking is built into the data structure, fails to ensure mutual exclusion in her access to the shared data, and causes a race condition bug that takes three weeks to track down. Of course, this locking problem is just given as an example of an ugly workaround. Obviously, a professional C++ programmer would never decide to perform the locking manually on each queue access but would instead directly incorporate the locking inside the queue class, or make the queue class thread-safe in a lock-free manner.

Formalizing a design before you code helps you determine how everything fits together. Just as blueprints for a house show how the rooms relate to each other and work together to fulfill the requirements of the house, the design for a program shows how the subsystems of the program relate to each other and work together to fulfill the software requirements. Without a design plan, you are likely to miss connections between subsystems, possibilities for reuse or shared information, and the simplest ways to accomplish tasks. Without the “big picture” that the design gives, you might become so bogged down in individual implementation details that you lose track of the overarching architecture and goals. Furthermore, the design provides written documentation to which all members of the project can refer. If you use an iterative process like the agile Scrum methodology mentioned earlier, you need to make sure to keep the design documentation up-to-date during each cycle of the process.

If the preceding analogy hasn’t convinced you to design before you code, here is an example where jumping directly into coding fails to lead to an optimal design. Suppose that you want to write a chess program. Instead of designing the entire program before you begin coding, you decide to jump in with the easiest parts and move slowly to the more difficult parts. Following the object-oriented perspective introduced in Chapter 1 and covered in more detail in Chapter 5, you decide to model your chess pieces with classes. You figure the pawn is the simplest chess piece, so you opt to start there. After considering the features and behaviors of a pawn, you write a class with the properties and methods shown in the UML class diagram in Figure 4-1.

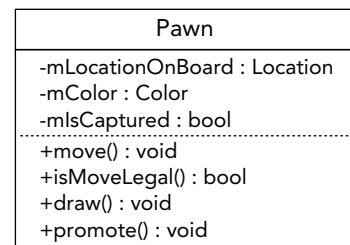

FIGURE 4-1

In this design, the `mColor` attribute denotes whether the pawn is black or white. The `promote()` method executes upon reaching the opposing side of the board.

Of course, you haven’t actually made this class diagram. You’ve gone straight to the implementation phase. Happy with that class, you move on to the next easiest piece: the bishop. After considering its attributes and functionality, you write a class with the properties and methods shown in the class diagram in Figure 4-2.

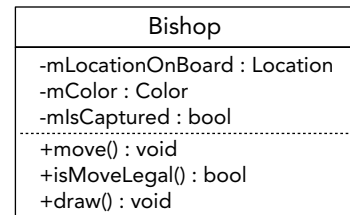

FIGURE 4-2

Again, you haven’t generated a class diagram, because you jumped straight to the coding phase. However, at this point you begin to suspect that you might be doing something wrong. The bishop and the pawn look similar. In fact, their properties are identical and they share many methods. Although the implementations of the move method might differ between the pawn and the bishop, both pieces need the ability to move. If you had designed your program before jumping into coding, you would have realized that the various pieces are actually quite similar, and that you should find some way to write the common functionality only once. Chapter 5 explains the object-oriented design techniques for doing that.

Furthermore, several aspects of the chess pieces depend on other subsystems of your program. For example, you cannot accurately represent the location on the board in a chess piece class without knowing how you will model the board. On the other hand, perhaps you will design your program so that the board manages pieces in a way that doesn’t require them to know their

own locations. In either case, encoding the location in the piece classes before designing the board leads to problems. To take another example, how can you write a draw method for a piece without first deciding your program's user interface? Will it be graphical or text-based? What will the board look like? The problem is that subsystems of a program do not exist in isolation—they interrelate with other subsystems. Most of the design work determines and defines these relationships.

DESIGNING FOR C++

There are several aspects of the C++ language that you need to keep in mind when designing for C++:

- C++ has an immense feature set. It is almost a complete superset of the C language, plus classes and objects, operator overloading, exceptions, templates, and many other features. The sheer size of the language makes design a daunting task.
- C++ is an object-oriented language. This means that your designs should include class hierarchies, class interfaces, and object interactions. This type of design is quite different from “traditional” design in C or other procedural languages. Chapter 5 focuses on object-oriented design in C++.
- C++ has numerous facilities for designing generic and reusable code. In addition to basic classes and inheritance, you can use other language facilities such as templates and operator overloading for effective design. Design techniques for reusable code are discussed in more detail later in this chapter and also in Chapter 6.
- C++ provides a useful Standard Library, including a string class, I/O facilities, and many common data structures and algorithms. All of these facilitate coding in C++.
- C++ is a language that readily accommodates many *design patterns*, or common ways to solve problems.

Tackling a design can be overwhelming. I have spent entire days scribbling design ideas on paper, crossing them out, writing more ideas, crossing those out, and repeating the process. Sometimes this process is helpful, and, at the end of those days (or weeks), it leads to a clean, efficient design. Other times it is frustrating and leads nowhere, but it is not a waste of effort. You will most likely waste more time if you have to re-implement a design that turned out to be broken. It's important to remain aware of whether or not you are making real progress. If you find that you are stuck, you can take one of the following actions:

- **Ask for help.** Consult a coworker, mentor, book, newsgroup, or web page.
- **Work on something else for a while.** Come back to this design choice later.
- **Make a decision and move on.** Even if it's not an ideal solution, decide on something and try to work with it. An incorrect choice will soon become apparent. However, it may turn out to be an acceptable method. Perhaps there is no clean way to accomplish what you want to with this design. Sometimes you have to accept an “ugly” solution if it's the only realistic strategy to fulfill your requirements. Whatever you decide, make sure you document your decision,

so that you and others in the future know why you made it. This includes documenting designs that you have rejected and the rationale behind the rejection.

NOTE *Keep in mind that good design is hard, and getting it right takes practice. Don't expect to become an expert overnight, and don't be surprised if you find it more difficult to master C++ design than C++ coding.*

TWO RULES FOR C++ DESIGN

There are two fundamental design rules in C++: *abstraction* and *reuse*. These guidelines are so important that they can be considered themes of this book. They come up repeatedly throughout the text, and throughout effective C++ program designs in all domains.

Abstraction

The principle of *abstraction* is easiest to understand through a real-world analogy. A television is a simple piece of technology found in most homes. You are probably familiar with its features: you can turn it on and off, change the channel, adjust the volume, and add external components such as speakers, DVRs, and Blu-ray players. However, can you explain how it works inside the black box? That is, do you know how it receives signals over the air or through a cable, translates them, and displays them on the screen? Most people certainly can't explain how a television works, yet are quite capable of using it. That is because the television clearly separates its internal *implementation* from its external *interface*. We interact with the television through its interface: the power button, channel changer, and volume control. We don't know, nor do we care, how the television works; we don't care whether it uses a cathode ray tube or some sort of alien technology to generate the image on our screen. It doesn't matter because it doesn't affect the interface.

Benefiting from Abstraction

The abstraction principle is similar in software. You can use code without knowing the underlying implementation. As a trivial example, your program can make a call to the `sqrt()` function declared in the header file `<cmath>` without knowing what algorithm the function actually uses to calculate the square root. In fact, the underlying implementation of the square root calculation could change between releases of the library, and as long as the interface stays the same, your function call will still work. The principle of abstraction extends to classes as well. As introduced in Chapter 1, you can use the `cout` object of class `ostream` to stream data to standard output like this:

```
cout << "This call will display this line of text" << endl;
```

In this line, you use the documented interface of the `cout` insertion operator (`<<`) with a character array. However, you don't need to understand how `cout` manages to display that text on the user's screen. You only need to know the public interface. The underlying implementation of `cout` is free to change as long as the exposed behavior and interface remain the same.

Incorporating Abstraction in Your Design

You should design functions and classes so that you and other programmers can use them without knowing, or relying on, the underlying implementations. To see the difference between a design that exposes the implementation and one that hides it behind an interface, consider the chess program again. You might want to implement the chessboard with a two-dimensional array of pointers to `ChessPiece` objects. You could declare and use the board like this:

```
ChessPiece* chessBoard[8][8];
...
chessBoard[0][0] = new Rook();
```

However, that approach fails to use the concept of abstraction. Every programmer who uses the chessboard knows that it is implemented as a two-dimensional array. Changing that implementation to something else, such as a one-dimensional flattened `vector` of size 64, would be difficult, because you would need to change every use of the board in the entire program. Everyone using the chessboard also has to properly take care of memory management. There is no separation of interface from implementation.

A better approach is to model the chessboard as a class. You could then expose an interface that hides the underlying implementation details. Here is an example of the `ChessBoard` class:

```
class ChessBoard
{
public:
    // This example omits constructors, destructor, and assignment operator.
    void setPieceAt(size_t x, size_t y, ChessPiece* piece);
    ChessPiece* getPieceAt(size_t x, size_t y);
    bool isEmpty(size_t x, size_t y) const;
private:
    // This example omits data members.
};
```

Note that this interface makes no commitment to any underlying implementation. The `ChessBoard` could easily be a two-dimensional array, but the interface does not require it. Changing the implementation does not require changing the interface. Furthermore, the implementation can provide additional functionality, such as bounds checking.

Hopefully, this example has convinced you that abstraction is an important technique in C++ programming. Chapter 5 covers abstraction and object-oriented design in more detail, and Chapters 8 and 9 provide all the details about writing your own classes.

Reuse

The second fundamental rule of design in C++ is *reuse*. Again, it is helpful to examine a real-world analogy to understand this concept. Suppose that you give up your programming career in favor of working as a baker. On your first day of work, the head baker tells you to bake cookies. In order to fulfill his orders, you find the recipe for chocolate-chip cookies, mix the ingredients, form cookies on the cookie sheet, and place the sheet in the oven. The head baker is pleased with the result.

Now, I'm going to point out something so obvious that it will surprise you: you didn't build your own oven in which to bake the cookies. Nor did you churn your own butter, mill your own flour,

or form your own chocolate chips. I can hear you think, “That goes without saying.” That’s true if you’re a real cook, but what if you’re a programmer writing a baking simulation game? In that case, you would think nothing of writing every component of the program, from the chocolate chips to the oven. Or, you could save yourself time by looking around for code to reuse. Perhaps your office-mate wrote a cooking simulation game and has some nice oven code lying around. Maybe it doesn’t do everything you need, but you might be able to modify it and add the necessary functionality.

Something else you took for granted is that you followed a recipe for the cookies instead of making up your own. Again, that goes without saying. However, in C++ programming, it does not go without saying. Although there are standard ways of approaching problems that arise over and over in C++, many programmers persist in reinventing these strategies in each design.

The idea of using existing code is not new. You’ve been reusing code from the first day you printed something with `cout`. You didn’t write the code to actually print your data to the screen. You used the existing `cout` implementation to do the work.

Unfortunately, not all programmers take advantage of available code. Your designs should take into account existing code and reuse it when appropriate.

Writing Reusable Code

The design theme of reuse applies to code you write as well as to code that you use. You should design your programs so that you can reuse your classes, algorithms, and data structures. You and your coworkers should be able to use these components in both the current project and future projects. In general, you should avoid designing overly specific code that is applicable only to the case at hand.

One language technique for writing general-purpose code in C++ is the *template*. The following example shows a templated data structure. If you’ve never seen this syntax before, don’t worry! Chapter 12 explains the syntax in depth.

Instead of writing a specific `ChessBoard` class that stores `ChessPieces`, as shown earlier, consider writing a generic `GameBoard` template that can be used for any type of two-dimensional board game such as chess or checkers. You would need only to change the class declaration so that it takes the piece to store as a template parameter instead of hard-coding it in the interface. The template could look something like this:

```
template <typename PieceType>
class GameBoard
{
public:
    // This example omits constructors, destructor, and assignment operator.
    void setPieceAt(size_t x, size_t y, PieceType* piece);
    PieceType* getPieceAt(size_t x, size_t y);
    bool isEmpty(size_t x, size_t y) const;
private:
    // This example omits data members.
};
```

With this simple change in the interface, you now have a generic game board class that you can use for any two-dimensional board game. Although the code change is simple, it is important to

make these decisions in the design phase, so that you are able to implement the code effectively and efficiently.

Chapter 6 goes into more detail on how to design your code with reuse in mind.

Reusing Designs

Learning the C++ language and becoming a good C++ programmer are two very different things. If you sat down and read the C++ standard, memorizing every fact, you would know C++ as well as anybody else. However, until you gained some experience by looking at code and writing your own programs, you wouldn't necessarily be a good programmer. The reason is that the C++ syntax defines what the language can do in its raw form, but doesn't say anything about how each feature should be used.

As the baker example illustrates, it would be ludicrous to reinvent recipes for every dish that you make. However, programmers often make an equivalent mistake in their designs. Instead of using existing “recipes,” or *patterns*, for designing programs, they reinvent these techniques every time they design a program.

As they become more experienced in using the C++ language, C++ programmers develop their own individual ways of using the features of the language. The C++ community at large has also built some standard ways of leveraging the language, some formal and some informal. Throughout this book, I point out these reusable applications of the language, known as *design techniques* and *design patterns*. Additionally, Chapters 28 and 29 focus almost exclusively on design techniques and patterns. Some will seem obvious to you because they are simply a formalization of the obvious solution. Others describe novel solutions to problems you've encountered in the past. Some present entirely new ways of thinking about your program organization.

For example, you might want to design your chess program so that you have a single `ErrorLogger` object that serializes all errors from different components to a log file. When you try to design your `ErrorLogger` class, you realize that you would like to have only a single instance of the `ErrorLogger` class in your program. But, you also want several components in your program to be able to use this `ErrorLogger` instance; that is, these components all want to use the same `ErrorLogger` service. A standard strategy to implement such a service mechanism is to use *dependency injection*. With dependency injection, you create an interface for each service and you inject the interfaces a component needs into the component. Thus, a good design at this point would specify that you want to use the dependency injection pattern.

It is important for you to familiarize yourself with these patterns and techniques so that you can recognize when a particular design problem calls for one of these solutions. There are many more techniques and patterns applicable to C++ than those described in this book. Even though a nice selection is covered here, you may want to consult a book on design patterns for more and different patterns. See Appendix B for suggestions.

REUSING EXISTING CODE

Experienced C++ programmers never start a project from scratch. They incorporate code from a wide variety of sources, such as the Standard Library, open-source libraries, proprietary code bases in their workplace, and their own code from previous projects. You should reuse code liberally in

your designs. In order to make the most of this rule, you need to understand the types of code that you can reuse and the tradeoffs involved in code reuse.

NOTE *Reusing code does not mean copying and pasting existing code! In fact, it means quite the opposite: reusing code without duplicating it.*

A Note on Terminology

Before analyzing the advantages and disadvantages of code reuse, it is helpful to specify the terminology involved and to categorize the types of reused code. There are three categories of code available for reuse:

- Code you wrote yourself in the past
- Code written by a coworker
- Code written by a third party outside your current organization or company

There are also several ways that the code you reuse can be structured:

- **Stand-alone functions or classes.** When you reuse your own code or coworkers' code, you will generally encounter this variety.
- **Libraries.** A *library* is a collection of code used to accomplish a specific task, such as parsing XML, or to handle a specific domain, such as cryptography. Other examples of functionality usually found in libraries include threads and synchronization support, networking, and graphics.
- **Frameworks.** A *framework* is a collection of code around which you design a program. For example, the Microsoft Foundation Classes (MFC) library provides a framework for creating graphical user interface applications for Microsoft Windows. Frameworks usually dictate the structure of your program.

NOTE *A program uses a library but fits into a framework. Libraries provide specific functionality, while frameworks are fundamental to your program design and structure.*

Another term that arises frequently is *application programming interface*, or *API*. An API is an interface to a library or body of code for a specific purpose. For example, programmers often refer to the sockets API, meaning the exposed interface to the sockets networking library, instead of the library itself.

NOTE *Although people use the terms API and library interchangeably, they are not equivalent. The library refers to the implementation, while the API refers to the published interface to the library.*

For the sake of brevity, the rest of this chapter uses the term *library* to refer to any reused code, whether it is really a library, framework, or random collection of functions from your office-mate.

Deciding Whether or Not to Reuse Code

The rule to reuse code is easy to understand in the abstract. However, it's somewhat vague when it comes to the details. How do you know when it's appropriate to reuse code, and which code to reuse? There is always a tradeoff, and the decision depends on the specific situation. However, there are some general advantages and disadvantages to reusing code.

Advantages to Reusing Code

Reusing code can provide tremendous advantages to you and to your project.

- You may not know how to, or may not be able to justify the time to write the code you need. Would you really want to write code to handle formatted input and output? Of course not. That's why you use the standard C++ I/O streams.
- Your designs will be simpler because you will not need to design those components of the application that you reuse.
- The code that you reuse usually requires no debugging. You can often assume that library code is bug-free because it has already been tested and used extensively.
- Libraries handle more error conditions than would your first attempt at the code. You might forget obscure errors or edge cases at the beginning of the project, and would waste time fixing these problems later. Library code that you reuse has generally been tested extensively and used by many programmers before you, so you can assume that it handles most errors properly.
- Libraries generally are designed to be suspect of bad user inputs. Invalid requests, or requests not appropriate for the current state, usually result in suitable error notifications. For example, a request to seek a nonexistent record in a database, or to read a record from a database that is not open, would have well-specified behavior from a library.
- Reusing code written by domain experts is safer than writing your own code for that area. For example, you should not attempt to write your own security code unless you are a security expert. If you need security or cryptography in your programs, use a library. Many seemingly minor details in code of that nature could compromise the security of the entire program, and possibly the entire system, if you got them wrong.
- Library code is constantly improving. If you reuse the code, you receive the benefits of these improvements without doing the work yourself. In fact, if the library writers have properly separated the interface from the implementation, you can obtain these benefits by upgrading your library version without changing your interaction with the library. A good upgrade modifies the underlying implementation without changing the interface.

Disadvantages to Reusing Code

Unfortunately, there are also some disadvantages to reusing code.

- When you use only code that you wrote yourself, you understand exactly how it works. When you use libraries that you didn't write yourself, you must spend time understanding

the interface and correct usage before you can jump in and use it. This extra time at the beginning of your project will slow your initial design and coding.

- When you write your own code, it does exactly what you want. Library code might not provide the exact functionality that you require.
- Even if the library code provides the exact functionality you need, it might not give you the performance that you desire. The performance might be bad in general, poor for your specific use case, or completely unspecified.
- Using library code introduces a Pandora's box of support issues. If you discover a bug in the library, what do you do? Often you don't have access to the source code, so you couldn't fix it even if you wanted to. If you have already invested significant time in learning the library interface and using the library, you probably don't want to give it up, but you might find it difficult to convince the library developers to fix the bug on your time schedule. Also, if you are using a third-party library, what do you do if the library authors drop support for the library before you stop supporting the product that depends on it? Think carefully about this before you decide to use a library for which you cannot get source code.
- In addition to support problems, libraries present licensing issues, which cover topics such as disclosure of your source, redistribution fees (often called binary license fees), credit attribution, and development licenses. You should carefully inspect the licensing issues before using any library. For example, some open-source libraries require you to make your own code open-source.
- Another consideration with reusing code is cross-platform portability. If you want to write a cross-platform application, make sure the libraries you use are also cross-platform portable.
- Reusing code requires a trust factor. You must trust whoever wrote the code by assuming that they did a good job. Some people like to have control over all aspects of their project, including every line of source code.
- Upgrading to a new version of the library can cause problems. The upgrade could introduce bugs, which could have fatal consequences in your product. A performance-related upgrade might optimize performance in certain cases but make it worse in your specific use case.
- Upgrading your compiler to a new version can cause problems when you are using binary-only libraries. You can only upgrade the compiler when the library vendor provides binaries compatible with your new version of the compiler.

Putting It Together to Make a Decision

Now that you are familiar with the terminology, advantages, and disadvantages of reusing code, you are better prepared to make the decision about whether or not to reuse code. Often, the decision is obvious. For example, if you want to write a graphical user interface (GUI) in C++ for Microsoft Windows, you should use a framework such as Microsoft Foundation Class (MFC) or Qt. You probably don't know how to write the underlying code to create a GUI in Windows, and more importantly, you don't want to waste time to learn it. You will save person-years of effort by using a framework in this case.

However, other times the choice is less obvious. For example, if you are unfamiliar with a library or framework, and need only a simple data structure, it might not be worth the time to learn the entire framework to reuse only one component that you could write in a few days.

Ultimately, you need to make a decision based on your own particular needs. It often comes down to a tradeoff between the time it would take to write it yourself and the time required to find and learn how to use a library to solve the problem. Carefully consider how the advantages and disadvantages listed previously apply to your specific case, and decide which factors are most important to you. Finally, remember that you can always change your mind, which might even be relatively easy if you handled the abstraction correctly.

Strategies for Reusing Code

When you use libraries, frameworks, coworkers' code, or your own code, there are several guidelines you should keep in mind.

Understand the Capabilities and Limitations

Take the time to familiarize yourself with the code. It is important to understand both its capabilities and its limitations. Start with the documentation and the published interfaces or APIs. Ideally, that will be sufficient to understand how to use the code. However, if the library doesn't provide a clear separation between interface and implementation, you may need to explore the source code itself if it is provided. Also, talk to other programmers who have used the code and who might be able to explain its intricacies. You should begin by learning the basic functionality. If it's a library, what functions does it provide? If it's a framework, how does your code fit in? What classes should you derive from? What code do you need to write yourself? You should also consider specific issues depending on the type of code.

Here are some points to keep in mind:

- Is the code safe for multithreaded programs?
- Does the library impose any specific compiler settings on code using it? If so, is that acceptable in your project?
- Which initialization and cleanup calls are needed?
- On what other libraries does the library or framework depend?
- If you derive from a class, which constructor should you call on it? Which virtual methods should you override?
- If a call returns memory pointers, who is responsible for freeing the memory: the caller or the library? If the library is responsible, when is the memory freed? It's highly recommended to find out if you can use smart pointers (see Chapter 1) to manage memory allocated by the library.
- What error conditions do library calls check for, and what do they assume? How are errors handled? How is the client program notified about errors? Avoid using libraries that pop up message boxes, issue messages to `stderr/cerr` or `stdout/cout`, or terminate the program.

- What are all the return values (by value or reference) from a call?
- What are all the possible exceptions thrown?

Understand the Performance

It is important to know the performance guarantees that the library or other code provides. Even if your particular program is not performance sensitive, you should make sure that the code you use doesn't have awful performance for your particular use.

Big-O Notation

Programmers generally discuss and document algorithm and library performance using *big-O notation*. This section explains the general concepts of algorithm complexity analysis and big-O notation without a lot of unnecessary mathematics. If you are already familiar with these concepts, you can skip this section.

Big-O notation specifies *relative*, rather than *absolute*, performance. For example, instead of saying that an algorithm runs in a specific amount of time, such as 300 milliseconds, big-O notation specifies how an algorithm performs as its input size increases. Examples of input sizes include the number of items to be sorted by a sorting algorithm, the number of elements in a hash table during a key lookup, and the size of a file to be copied between disks.

NOTE *Big-O notation applies only to algorithms whose speed depends on their inputs. It does not apply to algorithms that take no input or whose running time is random. In practice, you will find that the running times of most algorithms of interest depend on their input, so this limitation is not significant.*

To be more formal: big-O notation specifies an algorithm's run time as a function of its input size, also known as the *complexity* of the algorithm. It's not as complicated as it sounds. For example, an algorithm could take twice as long to process twice as many elements. Thus, if it takes 2 seconds to process 400 elements, it will take 4 seconds to process 800 elements. Figure 4-3 shows this graphically. It is said that the complexity of such an algorithm is a linear function of its input size, because, graphically, it is represented by a straight line.

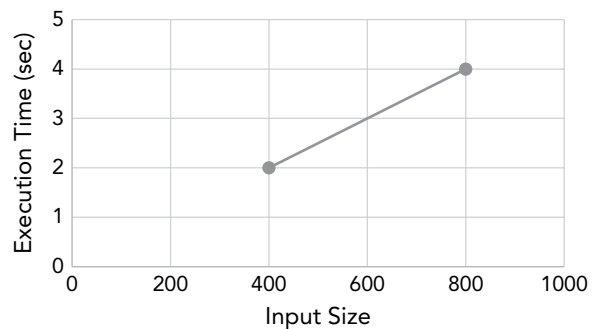

FIGURE 4-3

Big-O notation summarizes the algorithm's linear performance like this: $O(n)$. The O just means that you're using big-O notation, while the n represents the input size. $O(n)$ specifies that the algorithm speed is a direct linear function of the input size.

Of course, not all algorithms have performance that is linear with respect to their input size. The following table summarizes the common complexities, in order of their performance from best to worst.

ALGORITHM COMPLEXITY	BIG-O NOTATION	EXPLANATION	EXAMPLE ALGORITHMS
Constant	$O(1)$	The running time is independent of input size.	Accessing a single element in an array
Logarithmic	$O(\log n)$	The running time is a function of the logarithm base 2 of the input size.	Finding an element in a sorted list using binary search
Linear	$O(n)$	The running time is directly proportional to the input size.	Finding an element in an unsorted list
Linear Logarithmic	$O(n \log n)$	The running time is a function of the linear times the logarithmic function of the input size.	Merge sort
Quadratic	$O(n^2)$	The running time is a function of the square of the input size.	A slower sorting algorithm like selection sort
Exponential	$O(2^n)$	The running time is an exponential function of the input size.	Optimized traveling salesman problem

There are two advantages to specifying performance as a function of the input size instead of in absolute numbers:

1. It is platform independent. Specifying that a piece of code runs in 200 milliseconds on one computer says nothing about its speed on a second computer. It is also difficult to compare two different algorithms without running them on the same computer with the exact same load. On the other hand, performance specified as a function of the input size is applicable to any platform.
2. Performance as a function of input size covers all possible inputs to the algorithm with one specification. The specific time in seconds that an algorithm takes to run covers only one specific input, and says nothing about any other input.

Tips for Understanding Performance

Now that you are familiar with big-O notation, you are prepared to understand most performance documentation. The C++ Standard Library in particular describes its algorithm and data structure performance using big-O notation. However, big-O notation is sometimes insufficient or even misleading. Consider the following issues whenever you think about big-O performance specifications:

- If an algorithm takes twice as long to work on twice as much data, it doesn't say anything about how long it took in the first place! If the algorithm is written badly but scales well, it's still not something you want to use. For example, suppose the algorithm makes unnecessary

disk accesses. That probably wouldn't affect the big-O time but would be very bad for overall performance.

- Along those lines, it's difficult to compare two algorithms with the same big-O running time. For example, if two different sorting algorithms both claim to be $O(n \log n)$, it's hard to tell which is really faster without running your own tests.
- The big-O notation describes the time complexity of an algorithm asymptotically, as the input size grows to infinity. For small inputs, big-O time can be very misleading. An $O(n^2)$ algorithm might actually perform better than an $O(\log n)$ algorithm on small input sizes. Consider your likely input sizes before making a decision.

In addition to considering big-O characteristics, you should look at other facets of the algorithm performance. Here are some guidelines to keep in mind:

- You should consider how often you intend to use a particular piece of library code. Some people find the "90/10" rule helpful: 90 percent of the running time of most programs is spent in only 10 percent of the code (Hennessy and Patterson, *Computer Architecture: A Quantitative Approach, Fifth Edition*, 2011, Morgan Kaufmann). If the library code you intend to use falls in the oft-exercised 10 percent category of your code, you should make sure to analyze its performance characteristics carefully. On the other hand, if it falls into the oft-ignored 90 percent of the code, you should not spend much time analyzing its performance because it will not benefit the overall program performance very much. Chapter 25 discusses profilers, tools to help you find performance bottlenecks in your code.
- Don't trust the documentation. Always run performance tests to determine if library code provides acceptable performance characteristics.

Understand Platform Limitations

Before you start using library code, make sure that you understand on which platforms it runs. That might sound obvious, but even libraries that claim to be cross-platform might contain subtle differences on different platforms.

Also, platforms include not only different operating systems but different versions of the same operating system. If you write an application that should run on Solaris 8, Solaris 9, and Solaris 10, ensure that any libraries you use also support all those releases. You cannot assume either forward or backward compatibility across operating system versions. That is, just because a library runs on Solaris 9 doesn't mean that it will run on Solaris 10 and vice versa.

Understand Licensing and Support

Using third-party libraries often introduces complicated licensing issues. You must sometimes pay license fees to third-party vendors for the use of their libraries. There may also be other licensing restrictions, including export restrictions. Additionally, open-source libraries are sometimes distributed under licenses that require any code that links with them to be open source as well. A number of licenses commonly used by open-source libraries are discussed later in this chapter.

Using third-party libraries also introduces support issues. Before you use a library, make sure that you understand the process for submitting bugs, and that you realize how long it will take for bugs

to be fixed. If possible, determine how long the library will continue to be supported so that you can plan accordingly.

WARNING *Make sure that you understand the license restrictions of any third-party libraries you use if you plan to distribute or sell the code you develop. When in doubt, consult a legal expert.*

Interestingly, even using libraries from within your own organization can introduce support issues. You may find it just as difficult to convince a coworker in another part of your company to fix a bug in their library as you would to convince a stranger in another company to do the same thing. In fact, you may even find it harder, because you're not a paying customer. Make sure that you understand the politics and organizational issues within your own organization before using internal libraries.

Know Where to Find Help

Using libraries and frameworks can sometimes be daunting at first. Fortunately, there are many avenues of support available. First of all, consult the documentation that accompanies the library. If the library is widely used, such as the Standard Library or the MFC, you should be able to find a good book on the topic. In fact, for help with the Standard Library, you can consult Chapters 16 to 21. If you have specific questions not addressed by books and product documentation, try searching the web. Type your question in your favorite search engine to find web pages that discuss the library. For example, when you search for the phrase, “introduction to C++ Standard Library,” you will find several hundred websites about C++ and the Standard Library. Also, many websites contain their own private newsgroups or forums on specific topics for which you can register.

WARNING *A note of caution: don't believe everything you read on the web! Web pages do not necessarily undergo the same review process as printed books and documentation, and may contain inaccuracies.*

Prototype

When you first sit down with a new library or framework, it is often a good idea to write a quick prototype. Trying out the code is the best way to familiarize yourself with the library's capabilities. You should consider experimenting with the library even before you tackle your program design so that you are intimately familiar with the library's capabilities and limitations. This empirical testing will allow you to determine the performance characteristics of the library as well.

Even if your prototype application looks nothing like your final application, time spent prototyping is not a waste. Don't feel compelled to write a prototype of your actual application. Write a dummy program that just tests the library capabilities you want to use. The point is only to familiarize yourself with the library.

WARNING *Due to time constraints, programmers sometimes find their prototypes morphing into the final product. If you have hacked together a prototype that is insufficient as the basis for the final product, make sure that it doesn't get used that way.*

Bundling Third-Party Applications

Your project might include multiple applications. Perhaps you need a web server front end to support your new e-commerce infrastructure. It is possible to bundle third-party applications, such as a web server, with your software. This approach takes code reuse to the extreme in that you reuse entire applications. However, most of the caveats and guidelines for using libraries apply to bundling third-party applications as well. Specifically, make sure that you understand the legality and licensing ramifications of your decision.

NOTE *Consult a legal expert whose specialty is intellectual property before bundling third-party applications with your software distributions.*

Also, the support issue becomes more complex. If customers encounter a problem with your bundled web server, should they contact you or the web server vendor? Make sure that you resolve this issue *before* you release the software.

Open-Source Libraries

Open-source libraries are an increasingly popular class of reusable code. The general meaning of *open-source* is that the source code is available for anyone to look at. There are formal definitions and legal rules about including source code with all your distributions, but the important thing to remember about open-source software is that anyone (including you) can look at the source code. Note that open-source applies to more than just libraries. In fact, the most famous open-source product is probably the Android operating system. Linux is another open-source operating system. Google Chrome and Mozilla Firefox are two examples of famous open-source web browsers.

The Open-Source Movements

Unfortunately, there is some confusion in terminology in the open-source community. First of all, there are two competing names for the movement (some would say two separate, but similar, movements). Richard Stallman and the GNU project use the term *free software*. Note that the term *free* does not imply that the finished product must be available without cost. Developers are welcome to charge as much or as little as they want. Instead, the term *free* refers to the freedom for people to examine the source code, modify the source code, and redistribute the software. Think of the free in free speech rather than the free in free beer. You can read more about Richard Stallman and the GNU project at www.gnu.org.

The Open Source Initiative uses the term *open-source software* to describe software in which the source code must be available. As with free software, open-source software does not require the

product or library to be available without cost. However, an important difference with free software is that open-source software is not required to give you the freedom to use, modify, and redistribute it. You can read more about the Open Source Initiative at www.opensource.org.

There are several licensing options available for open-source projects. One of them is the GNU Public License (GPL). However, using a library under the GPL requires you to make your own product open-source under the GPL as well. On the other hand, an open-source project can use a licensing option like Boost Software License, Berkeley Software Distribution (BSD) license, Code Project Open License (CPOL), Creative Commons (CC) license, and so on, which allows using the open-source library in a closed-source product.

Because the name “open-source” is less ambiguous than “free software,” this book uses “open-source” to refer to products and libraries with which the source code is available. The choice of name is not intended to imply endorsement of the open-source philosophy over the free software philosophy: it is only for ease of comprehension.

Finding and Using Open-Source Libraries

Regardless of the terminology, you can gain amazing benefits from using open-source software. The main benefit is functionality. There is a plethora of open-source C++ libraries available for varied tasks, from XML parsing to cross-platform error logging.

Although open-source libraries are not required to provide free distribution and licensing, many open-source libraries are available without monetary cost. You will generally be able to save money in licensing fees by using open-source libraries.

Finally, you are often but not always free to modify open-source libraries to suit your exact needs.

Most open-source libraries are available on the web. For example, searching for “open-source C++ library XML parsing” results in a list of links to XML libraries in C and C++. There are also a few open-source portals where you can start your search, including the following:

- www.boost.org
- www.gnu.org
- github.com/open-source
- www.sourceforge.net

Guidelines for Using Open-Source Code

Open-source libraries present several unique issues and require new strategies. First of all, open-source libraries are usually written by people in their “free” time. The source base is generally available for any programmer who wants to pitch in and contribute to development or bug fixing. As a good programming citizen, you should try to contribute to open-source projects if you find yourself reaping the benefits of open-source libraries. If you work for a company, you may find resistance to this idea from your management because it does not lead directly to revenue for your company. However, you might be able to convince management that indirect benefits, such as exposure of your company name, and perceived support from your company for the open-source movement, should allow you to pursue this activity.

Second, because of the distributed nature of their development, and lack of single ownership, open-source libraries often present support issues. If you desperately need a bug fixed in a library, it is often more efficient to make the fix yourself than to wait for someone else to do it. If you do fix bugs, you should make sure to put those fixes back into the public source base for the library. Some licenses even require you to do so. Even if you don't fix any bugs, make sure to report problems that you find so that other programmers don't waste time encountering the same issues.

The C++ Standard Library

The most important library that you will use as a C++ programmer is the C++ Standard Library. As its name implies, this library is part of the C++ standard, so any standards-conforming compiler should include it. The Standard Library is not monolithic: it includes several disparate components, some of which you have been using already. You may even have assumed they were part of the core language. Chapters 16 to 21 go into more detail about the Standard Library.

C Standard Library

Because C++ is mostly a superset of C, the C Standard Library is still available. Its functionality includes mathematical functions such as `abs()`, `sqrt()`, and `pow()`, and error-handling helpers such as `assert()` and `errno`. Additionally, the C Standard Library facilities for manipulating character arrays as strings, such as `strlen()` and `strcpy()`, and the C-style I/O functions, such as `printf()` and `scanf()`, are all available in C++.

NOTE *C++ provides better strings and I/O support than C. Even though the C-style strings and I/O routines are available in C++, you should avoid them in favor of C++ strings (Chapter 2) and I/O streams (Chapter 13).*

Note that the C header files have different names in C++. These names should be used instead of the C library names, because they are less likely to result in name conflicts. For details of the C libraries, consult a Standard Library Reference, see Appendix B.

Deciding Whether or Not to Use the Standard Library

The Standard Library was designed with functionality, performance, and orthogonality as its priorities. The benefits of using it are substantial. Imagine having to track down pointer errors in linked list or balanced binary tree implementations, or to debug a sorting algorithm that isn't sorting properly. If you use the Standard Library correctly, you will rarely, if ever, need to perform that kind of coding. Chapters 16 to 21 provide in-depth information on the Standard Library functionality.

DESIGNING A CHESS PROGRAM

This section introduces a systematic approach to designing a C++ program in the context of a simple chess game application. In order to provide a complete example, some of the steps refer to concepts covered in later chapters. You should read this example now, in order to obtain an overview of the design process, but you might also consider rereading it after you have finished later chapters.

Requirements

Before embarking on the design, it is important to possess clear requirements for the program's functionality and efficiency. Ideally, these requirements would be documented in the form of a requirements specification. The requirements for the chess program would contain the following types of specifications, although in more detail and greater number:

- The program should support the standard rules of chess.
- The program should support two human players. The program should not provide an artificially intelligent computer player.
- The program should provide a text-based interface:
 - The program should render the game board and pieces in plain text.
 - Players should express their moves by entering numbers representing locations on the chessboard.

The requirements ensure that you design your program so that it performs as its users expect.

Design Steps

You should take a systematic approach to designing your program, working from the general to the specific. The following steps do not always apply to all programs, but they provide a general guideline. Your design should include diagrams and tables as appropriate. UML is an industry standard for making diagrams. You can refer to Appendix D for a brief introduction, but in short, UML defines a multitude of standard diagrams you can use for documenting software designs, for example, class diagrams, sequence diagrams, and so on. I recommend using UML or at least UML-like diagrams where applicable. However, I don't advocate strictly adhering to the UML syntax because having a clear, understandable diagram is more important than having a syntactically correct one.

Divide the Program into Subsystems

Your first step is to divide your program into its general functional subsystems and to specify the interfaces and interactions between the subsystems. At this point, you should not worry about specifics of data structures and algorithms, or even classes. You are trying only to obtain a general feel for the various parts of the program and their interactions. You can list the subsystems in a table that expresses the high-level behaviors or functionality of the subsystem, the interfaces exported from the subsystem to other subsystems, and the interfaces consumed, or used, by this subsystem on other subsystems. The recommended design for this chess game is to have a clear separation between storing the data and displaying the data by using the *Model-View-Controller* (MVC) paradigm. This paradigm models the notion that many applications commonly deal with a set of data, one or more views on that data, and manipulation of the data. In MVC, a set of data is called the *model*, a *view* is a particular visualization of the model, and the *controller* is the piece of code that changes the model in response to some event. The three components of MVC interact in a feedback loop: actions are handled by the controller, which adjusts the model, resulting in a change to the view or views. Using this paradigm, you can easily switch between having a text-based interface and a graphical user interface. A table for the chess game subsystems could look like this.

SUBSYSTEM NAME	INSTANCES	FUNCTIONALITY	INTERFACES EXPORTED	INTERFACES CONSUMED
GamePlay	1	Starts game Controls game flow Controls drawing Declares winner Ends game	Game Over	Take Turn (on Player) Draw (on ChessBoardView)
ChessBoard	1	Stores chess pieces Checks for ties and checkmates	Get Piece At Set Piece At	Game Over (on GamePlay)
ChessBoardView	1	Draws the associated ChessBoard	Draw	Draw (on ChessPieceView)
ChessPiece	32	Moves itself Checks for legal moves	Move Check Move	Get Piece At (on ChessBoard) Set Piece At (on ChessBoard)
ChessPieceView	32	Draws the associated ChessPiece	Draw	None
Player	2	Interacts with the user by prompting the user for a move, and obtaining the user's move Moves pieces	Take Turn	Get Piece At (on ChessBoard) Move (on ChessPiece) Check Move (on ChessPiece)
ErrorLogger	1	Writes error messages to a log file	Log Error	None

As this table shows, the functional subsystems of this chess game include a GamePlay subsystem, a ChessBoard and ChessBoardView, 32 ChessPieces and ChessPieceViews, two Players, and one ErrorLogger. However, that is not the only reasonable approach. In software design, as in programming itself, there are often many different ways to accomplish the same goal. Not all solutions are equal; some are certainly better than others. However, there are often several equally valid methods.

A good division into subsystems separates the program into its basic functional parts. For example, a Player is a subsystem distinct from the ChessBoard, ChessPieces, or GamePlay. It wouldn't make sense to lump the players into the GamePlay subsystem because they are logically separate subsystems. Other choices might not be as obvious.

In this MVC design, the ChessBoard and ChessPiece subsystems are part of the Model. The ChessBoardView and ChessPieceView are part of the View, and the Player is part of the Controller.

Because it is often difficult to visualize subsystem relationships from tables, it is usually helpful to show the subsystems of a program in a diagram where lines represent calls from one subsystem to another. Figure 4-4 shows the chess game subsystems visualized as a UML use-case diagram.

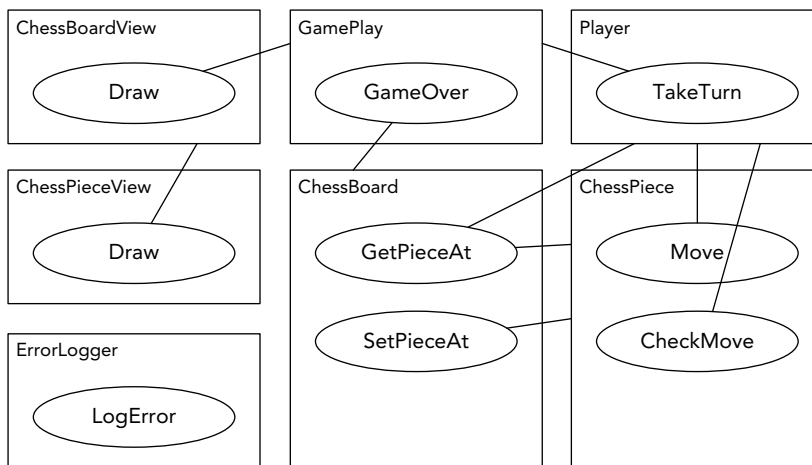

FIGURE 4-4

Choose Threading Models

It's too early in the design phase to think about how to multithread specific loops in algorithms you will write. However, in this step, you choose the number of high-level threads in your program and specify their interactions. Examples of high-level threads are a UI thread, an audio-playing thread, a network communication thread, and so on. In multithreaded designs, you should try to avoid shared data as much as possible because it will make your designs simpler and safer. If you cannot avoid shared data, you should specify locking requirements. If you are unfamiliar with multithreaded programs, or your platform does not support multithreading, then you should make your programs single-threaded. However, if your program has several distinct tasks, each of which could work in parallel, it might be a good candidate for multiple threads. For example, graphical user interface applications often have one thread performing the main application work and another thread waiting for the user to press buttons or select menu items. Multithreaded programming is covered in Chapter 23.

The chess program needs only one thread to control the game flow.

Specify Class Hierarchies for Each Subsystem

In this step, you determine the class hierarchies that you intend to write in your program. The chess program needs a class hierarchy to represent the chess pieces. This hierarchy could work as shown in Figure 4-5. The generic `ChessPiece` class serves as the abstract base class. A similar hierarchy is required for the `ChessPieceView` class.

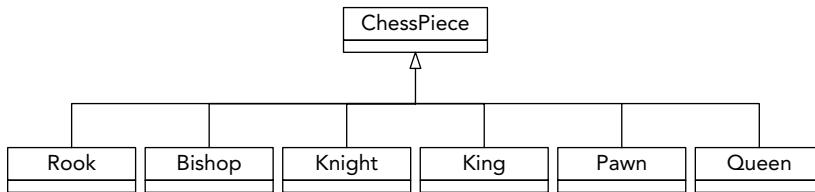

FIGURE 4-5

Another class hierarchy can be used for the `ChessBoardView` class to make it possible to have a text-based interface or a graphical user interface for the game. Figure 4-6 shows an example hierarchy that allows the chessboard to be displayed as text on a console, or with a 2D or 3D graphical user interface. A similar hierarchy is required for the `Player` controller and for the individual classes of the `ChessPieceView` hierarchy.

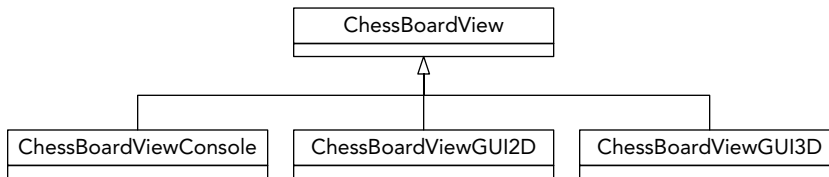

FIGURE 4-6

Chapter 5 explains the details of designing classes and class hierarchies.

Specify Classes, Data Structures, Algorithms, and Patterns for Each Subsystem

In this step, you consider a greater level of detail, and specify the particulars of each subsystem, including the specific classes that you write for each subsystem. It may well turn out that you model each subsystem itself as a class. This information can again be summarized in a table.

SUBSYSTEM	CLASSES	DATA STRUCTURES	ALGORITHMS	PATTERNS
GamePlay	GamePlay class	GamePlay object includes one ChessBoard object and two Player objects.	Gives each player a turn to play	None
ChessBoard	ChessBoard class	ChessBoard object stores a two-dimensional representation of 32 ChessPieces.	Checks for a win or tie after each move	None
ChessBoardView	ChessBoardView abstract base class Concrete derived classes ChessBoardView Console, ChessBoardView GUI2D, and so on	Stores information on how to draw a chessboard	Draws a chessboard	Observer
ChessPiece	ChessPiece abstract base class Rook, Bishop, Knight, King, Pawn, and Queen derived classes	Each piece stores its location on the chessboard.	Piece checks for a legal move by querying the chessboard for pieces at various locations.	None
ChessPieceView	ChessPieceView abstract base class Derived classes RookView, BishopView, and so on, and concrete derived classes RookViewConsole, RookViewGUI2D, and so on	Stores information on how to draw a chess piece	Draws a chess piece	Observer

continues

(continued)

SUBSYSTEM	CLASSES	DATA STRUCTURES	ALGORITHMS	PATTERNS
Player	Player abstract base class Concrete derived classes PlayerConsole, PlayerGUI2D, and so on	None	prompts the user for a move, checks if the move is legal, and moves the piece	Mediator
ErrorLogger	One ErrorLogger class	A queue of messages to log	Buffers messages and writes them to a log file	Dependency injection

This section of the design document would normally present the actual interfaces for each class, but this example will forgo that level of detail.

Designing classes and choosing data structures, algorithms, and patterns can be tricky. You should always keep in mind the rules of abstraction and reuse discussed earlier in this chapter. For abstraction, the key is to consider the interface and the implementation separately. First, specify the interface from the perspective of the user. Decide *what* you want the component to do. Then decide *how* the component will do it by choosing data structures and algorithms. For reuse, familiarize yourself with standard data structures, algorithms, and patterns. Also, make sure you are aware of the Standard Library in C++, as well as any proprietary code available in your workplace.

Specify Error Handling for Each Subsystem

In this design step, you delineate the error handling in each subsystem. The error handling should include both system errors, such as memory allocation failures, and user errors, such as invalid entries. You should specify whether each subsystem uses exceptions. You can again summarize this information in a table.

SUBSYSTEM	HANDLING SYSTEM ERRORS	HANDLING USER ERRORS
GamePlay	Logs an error with the <code>ErrorLogger</code> , shows a message to the user, and gracefully shuts down the program if unable to allocate memory for <code>ChessBoard</code> or <code>Players</code>	Not applicable (no direct user interface)
ChessBoard ChessPiece	Logs an error with the <code>ErrorLogger</code> and throws an exception if unable to allocate memory	Not applicable (no direct user interface)

SUBSYSTEM	HANDLING SYSTEM ERRORS	HANDLING USER ERRORS
ChessBoardView ChessPieceView	Logs an error with the <code>ErrorLogger</code> and throws an exception if something goes wrong during rendering	Not applicable (no direct user interface)
Player	Logs an error with the <code>ErrorLogger</code> and throws an exception if unable to allocate memory	Sanity-checks a user move entry to ensure that it is not off the board; it then prompts the user for another entry. This subsystem checks each move's legality before moving the piece; if illegal, it prompts the user for another move.
ErrorLogger	Attempts to log an error, informs the user, and gracefully shuts down the program if unable to allocate memory	Not applicable (no direct user interface)

The general rule for error handling is to handle everything. Think hard about all possible error conditions. If you forget one possibility, it will show up as a bug in your program! Don't treat anything as an "unexpected" error. Expect all possibilities: memory allocation failures, invalid user entries, disk failures, and network failures, to name a few. However, as the table for the chess game shows, you should handle user errors differently from internal errors. For example, a user entering an invalid move should not cause your chess program to terminate. Chapter 14 discusses error handling in more depth.

SUMMARY

In this chapter, you learned about the professional C++ approach to design. I hope that it convinced you that software design is an important first step in any programming project. You also learned about some of the aspects of C++ that make design difficult, including its object-oriented focus, its large feature set and Standard Library, and its facilities for writing generic code. With this information, you are better prepared to tackle C++ design.

This chapter introduced two design themes. The first theme, the concept of abstraction, or separating interface from implementation, permeates this book and should be a guideline for all your design work.

The second theme, the notion of reuse, both of code and designs, also arises frequently in real-world projects, and in this book. You learned that your C++ designs should include both reuse of code, in the form of libraries and frameworks, and reuse of ideas and designs, in the form of techniques and patterns. You should write your code to be as reusable as possible. Also remember about the tradeoffs and about specific guidelines for reusing code, including understanding the capabilities and limitations, the performance, licensing and support models, the platform limitations, prototyping, and where to find help. You also learned about performance analysis and big-O notation. Now that you understand the importance of design and the basic design themes, you are ready for the rest of Part II. Chapter 5 describes strategies for using the object-oriented aspects of C++ in your design.

5

Designing with Objects

WHAT'S IN THIS CHAPTER?

- What object-oriented programming design is
- How you can define relationships between different objects
- The importance of abstraction and how to use it in your designs

Now that you have developed an appreciation for good software design from Chapter 4, it's time to pair the notion of objects with the concept of good design. The difference between programmers who use objects in their code and those who truly grasp object-oriented programming comes down to the way their objects relate to each other and to the overall design of the program.

This chapter begins with a very brief description of procedural programming (C-style), followed by a detailed discussion of object-oriented programming (OOP). Even if you've been using objects for years, you will want to read this chapter for some new ideas regarding how to think about objects. I will discuss the different kinds of relationships between objects, including pitfalls programmers often succumb to when building an object-oriented program. I will also describe how the principle of abstraction relates to objects.

When thinking about procedural programming or object-oriented programming, the most important point to remember is that they just represent different ways of reasoning about what's going on in your program. Too often, programmers get bogged down in the syntax and jargon of OOP before they adequately understand what an object is. This chapter is light on code and heavy on concepts and ideas. For specifics on C++ object syntax, see Chapters 8, 9, and 10.

AM I THINKING PROCEDURALLY?

A procedural language, such as C, divides code into small pieces, each of which (ideally) accomplishes a single task. Without procedures in C, all your code would be lumped together inside `main()`. Your code would be difficult to read, and your coworkers would be annoyed, to say the least.

The computer doesn't care if all your code is in `main()` or if it's split into bite-sized pieces with descriptive names and comments. Procedures are an abstraction that exists to help you, the programmer, as well as those who read and maintain your code. The concept is built around a fundamental question about your program—*What does this program do?* By answering that question in English, you are thinking procedurally. For example, you might begin designing a stock selection program by answering as follows: First, the program obtains stock quotes from the Internet. Then, it sorts this data by specific metrics. Next, it performs analysis on the sorted data. Finally, it outputs a list of buy and sell recommendations. When you start coding, you might directly turn this mental model into C functions: `retrieveQuotes()`, `sortQuotes()`, `analyzeQuotes()`, and `outputRecommendations()`.

NOTE *Even though C refers to procedures as “functions,” C is not a functional language. The term functional is very different from procedural and refers to languages like Lisp, which use an entirely different abstraction.*

The procedural approach tends to work well when your program follows a specific list of steps. However, in large, modern applications, there is rarely a linear sequence of events. Often a user is able to perform any command at any time. Procedural thinking also says nothing about data representation. In the previous example, there was no discussion of what a stock quote actually is.

If the procedural mode of thought sounds like the way you approach a program, don't worry. Once you realize that OOP is simply an alternative, more flexible way of thinking about software, it'll come naturally.

THE OBJECT-ORIENTED PHILOSOPHY

Unlike the procedural approach—which is based on the question, *What does this program do?*—the object-oriented approach asks another question: *What real-world objects am I modeling?* OOP is based on the notion that you should divide your program not into tasks, but into models of physical objects. While this seems abstract at first, it becomes clearer when you consider physical objects in terms of their *classes*, *components*, *properties*, and *behaviors*.

Classes

A class helps distinguish an object from its definition. Consider the orange. There's a difference between talking about oranges in general as tasty fruit that grows on trees, and talking about a specific orange, such as the one that's currently dripping juice on my keyboard.

When answering the question “What are oranges?” you are talking about the *class* of things known as oranges. All oranges are fruit. All oranges grow on trees. All oranges are some shade of orange. All oranges have some particular flavor. A class is simply the encapsulation of what defines a classification of objects.

When describing a specific orange, you are talking about an object. All objects belong to a particular class. Because the object on my desk is an orange, I know that it belongs to the orange class. Thus, I know that it is a fruit that grows on trees. I can further say that it is a medium shade of orange and ranks “mighty tasty” in flavor. An object is an *instance* of a class—a particular item with characteristics that distinguish it from other instances of the same class.

As a more concrete example, reconsider the stock selection application from earlier. In OOP, “stock quote” is a class because it defines the abstract notion of what makes up a quote. A specific quote, such as “current Microsoft stock quote,” would be an object because it is a particular instance of the class.

From a C background, think of classes and objects as analogous to types and variables. In fact, in Chapter 8, you’ll see that the syntax for classes is similar to the syntax for C structs.

Components

If you consider a complex real-world object, such as an airplane, it should be fairly easy to see that it is made up of smaller *components*. There’s the fuselage, the controls, the landing gear, the engines, and numerous other parts. The ability to think of objects in terms of their smaller components is essential to OOP, just as the breaking up of complicated tasks into smaller procedures is fundamental to procedural programming.

A component is essentially the same thing as a class, just smaller and more specific. A good object-oriented program might have an `Airplane` class, but this class would be huge if it fully described an airplane. Instead, the `Airplane` class deals with many smaller, more manageable, components. Each of these components might have further subcomponents. For example, the landing gear is a component of an airplane, and the wheel is a component of the landing gear.

Properties

Properties are what distinguish one object from another. Going back to the `Orange` class, recall that all oranges are defined as having some shade of orange and a particular flavor. These two characteristics are properties. All oranges have the same properties, just with different values. My orange has a “mighty tasty” flavor, but yours may have a “terribly unpleasant” flavor.

You can also think about properties on the class level. As recognized earlier, all oranges are fruit and grow on trees. These are properties of the fruit class, whereas the specific shade of orange is determined by the particular fruit object. Class properties are shared by all objects of a class, while object properties are present in all objects of the class, but with different values.

In the stock selection example, a stock quote has several object properties, including the name of the company, its ticker symbol, the current price, and other statistics.

Properties are the characteristics that describe an object. They answer the question, “What makes this object different?”

Behaviors

Behaviors answer either of two questions: *What does this object do?* or *What can I do to this object?* In the case of an orange, it doesn't do a whole lot, but we can do things to it. One behavior is that it can be eaten. Like properties, you can think of behaviors on the class level or the object level. All oranges can pretty much be eaten in the same way. However, they might differ in some other behavior, such as being rolled down an incline, where the behavior of a perfectly round orange would differ from that of a more oblate one.

The stock selection example provides some more practical behaviors. If you recall, when thinking procedurally, I determined that my program needed to analyze stock quotes as one of its functions. Thinking in OOP, you might decide that a stock quote object can analyze itself. Analysis becomes a behavior of the stock quote object.

In object-oriented programming, the bulk of functional code is moved out of procedures and into classes. By building classes that have certain behaviors and defining how they interact, OOP offers a much richer mechanism for attaching code to the data on which it operates. Behaviors for classes are implemented in so-called class methods.

Bringing It All Together

With these concepts, you could take another look at the stock selection program and redesign it in an object-oriented manner.

As discussed, “stock quote” would be a fine class to start with. To obtain the list of quotes, the program needs the notion of a group of stock quotes, which is often called a *collection*. So, a better design might be to have a class that represents a “collection of stock quotes,” which is made up of smaller components that represent a single “stock quote.”

Moving on to properties, the collection class would have at least one property—the actual list of quotes received. It might also have additional properties, such as the exact date and time of the most recent retrieval. As for behaviors, the “collection of stock quotes” would be able to talk to a server to get the quotes and provide a sorted list of quotes. This is the “retrieve quotes” behavior.

The stock quote class would have the properties discussed earlier—name, symbol, current price, and so on. Also, it would have an analyze behavior. You might consider other behaviors, such as buying and selling the stock.

It is often useful to create diagrams showing the relationship between components. Figure 5-1 uses the UML class diagram syntax, see Appendix D, to indicate that a `StockQuoteCollection` contains zero or more (0..*) `StockQuote` objects, and that a `StockQuote` object belongs to a single (1) `StockQuoteCollection`.

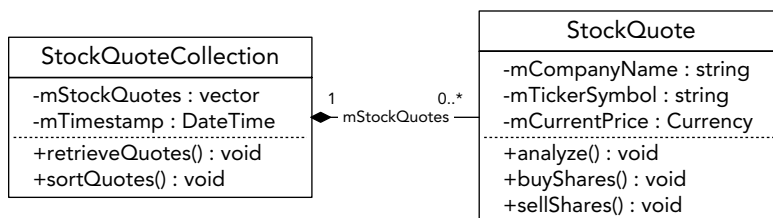

FIGURE 5-1

Figure 5-2 shows a possible UML class diagram for the orange class.

LIVING IN A WORLD OF OBJECTS

Programmers who transition from a procedural thought process to the object-oriented paradigm often experience an epiphany about the combination of properties and behaviors into objects. Some programmers find themselves revisiting the design of programs they're working on and rewriting certain pieces as objects. Others might be tempted to throw all the code away and restart the project as a fully object-oriented application.

There are two major approaches to developing software with objects. To some people, objects simply represent a nice encapsulation of data and functionality. These programmers sprinkle objects throughout their programs to make the code more readable and easier to maintain. Programmers taking this approach slice out isolated pieces of code and replace them with objects like a surgeon implanting a pacemaker. There is nothing inherently wrong with this approach. These people see objects as a tool that is beneficial in many situations. Certain parts of a program just “feel like an object,” like the stock quote. These are the parts that can be isolated and described in real-world terms.

Other programmers adopt the OOP paradigm fully and turn everything into an object. In their minds, some objects correspond to real-world things, such as an orange or a stock quote, while others encapsulate more abstract concepts, such as a sorter or an `undo` object.

The ideal approach is probably somewhere in between these extremes. Your first object-oriented program might really have been a traditional procedural program with a few objects sprinkled in. Or perhaps you went whole hog and made everything an object, from a class representing an `int` to a class representing the main application. Over time, you will find a happy medium.

Over-Objectification

There is often a fine line between designing a creative object-oriented system and annoying everybody else on your team by turning every little thing into an object. As Freud used to say, sometimes a variable is just a variable. Okay, that's a paraphrase of what he said.

Perhaps you're designing the next bestselling Tic-Tac-Toe game. You're going all-out OOP on this one, so you sit down with a cup of coffee and a notepad to sketch out your classes and objects. In games like this, there's often an object that oversees game play and is able to detect the winner. To represent the game board, you might envision a `Grid` object that will keep track of the markers and their locations. In fact, a component of the grid could be the `Piece` object that represents an X or an O.

Wait, back up! This design proposes to have a class that represents an X or an O. That is perhaps object overkill. After all, can't a `char` represent an X or an O just as well? Better yet, why can't the `Grid` just use a two-dimensional array of an enumerated type? Does a `Piece` object just complicate the code? Take a look at the following table representing the proposed piece class:

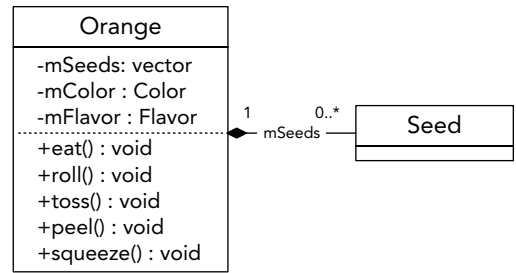

FIGURE 5-2

CLASS	ASSOCIATED COMPONENTS	PROPERTIES	BEHAVIORS
Piece	None	X or O	None

The table is a bit sparse, strongly hinting that what we have here may be too granular to be a full-fledged object.

On the other hand, a forward-thinking programmer might argue that while `Piece` is a pretty meager class as it currently stands, making it into an object allows future expansion without any real penalty. Perhaps down the road, this will be a graphical application and it might be useful to have the `Piece` class support drawing behavior. Additional properties could be the color of the `Piece` or whether the `Piece` was the most recently moved.

Another solution might be to think about the *state* of a grid square instead of using pieces. The state of a square can be `Empty`, `X`, or `O`. To make the design future-proof to support a graphical application, you could design an abstract base class `State` with concrete derived classes `StateEmpty`, `StateX`, and `StateO`, which know how to render themselves.

Obviously, there is no right answer. The important point is that these are issues that you should consider when designing your application. Remember that objects exist to help programmers manage their code. If objects are being used for no reason other than to make the code “more object-oriented,” something is wrong.

Overly General Objects

Perhaps a worse annoyance than objects that shouldn’t be objects is objects that are too general. All OOP students start with examples like “orange”—things that are objects, no question about it. In real-life coding, objects can get pretty abstract. Many OOP programs have an “application object,” despite the fact that an application isn’t really something you can envision in material form. Yet it may be useful to represent the application as an object because the application itself has certain properties and behaviors.

An overly general object is an object that doesn’t represent a particular thing at all. The programmer may be attempting to make an object that is flexible or reusable, but ends up with one that is confusing. For example, imagine a program that organizes and displays media. It can catalog your photos, organize your digital music collection, and serve as a personal journal. The overly general approach is to think of all these things as “media” objects and build a single class that can accommodate all of the formats. It might have a property called “data” that contains the raw bits of the image, song, or journal entry, depending on the type of media. It might have a behavior called “perform” that appropriately draws the image, plays the song, or brings up the journal entry for editing.

The clues that this class is too general are in the names of the properties and behaviors. The word “data” has little meaning by itself—you have to use a general term here because this class has been overextended to three very different uses. Similarly, “perform” will do very different things in the three different cases. Finally, this design is too general because “media” isn’t a particular object, not in the user interface, not in real life, and not even in the programmer’s mind. A major clue that a class is too general is when many ideas in the programmer’s mind all unite as a single object, as shown in Figure 5-3.

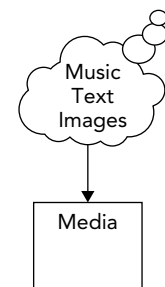

FIGURE 5-3

OBJECT RELATIONSHIPS

As a programmer, you will certainly encounter cases where different classes have characteristics in common, or at least seem somehow related to each other. For example, although creating a “media” object to represent images, music, and text in a digital catalog program is too general, these objects do share characteristics. You may want all of them to keep track of the date and time that they were last modified, or you might want them all to support a delete behavior.

Object-oriented languages provide a number of mechanisms for dealing with such relationships between objects. The tricky part is to understand what the relationship actually is. There are two main types of object relationships—a *has-a* relationship and an *is-a* relationship.

The Has-A Relationship

Objects engaged in a has-a, or *aggregation*, relationship follow the pattern A has a B, or A contains a B. In this type of relationship, you can envision one object as part of another. Components, as defined earlier, generally represent a has-a relationship because they describe objects that are made up of other objects.

A real-world example of this might be the relationship between a zoo and a monkey. You could say that a zoo has a monkey or a zoo contains a monkey. A simulation of a zoo in code would have a zoo object, which has a monkey component.

Often, thinking about user interface scenarios is helpful in understanding object relationships. This is so because even though not all UIs are implemented in OOP (though these days, most are), the visual elements on the screen translate well into objects. One UI analogy for a has-a relationship is a window that contains a button. The button and the window are clearly two separate objects but they are obviously related in some way. Because the button is inside the window, you say that the window has a button.

Figure 5-4 shows a real-world and a user interface has-a relationship.

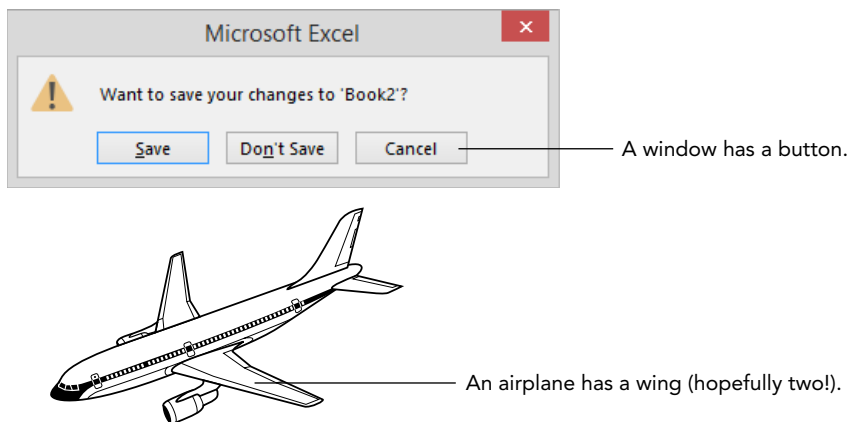

FIGURE 5-4

The Is-A Relationship (Inheritance)

The is-a relationship is such a fundamental concept of object-oriented programming that it has many names, including *deriving*, *subclassing*, *extending*, and *inheriting*. Classes model the fact that the real world contains objects with properties and behaviors. Inheritance models the fact that these objects tend to be organized in hierarchies. These hierarchies indicate is-a relationships.

Fundamentally, inheritance follows the pattern A is a B or A is really quite a bit like B—it can get tricky. To stick with the simple case, revisit the zoo, but assume that there are other animals besides monkeys. That statement alone has already constructed the relationship—a monkey is an animal. Similarly, a giraffe is an animal, a kangaroo is an animal, and a penguin is an animal. So what? Well, the magic of inheritance comes when you realize that monkeys, giraffes, kangaroos, and penguins have certain things in common. These commonalities are characteristics of animals in general.

What this means for the programmer is that you can define an `Animal` class that encapsulates all of the properties (size, location, diet, and so on) and behaviors (move, eat, sleep) that pertain to every animal. The specific animals, such as monkeys, become derived classes of `Animal` because a monkey contains all the characteristics of an animal. Remember, a monkey is an animal plus some additional characteristics that make it distinct. Figure 5-5 shows an inheritance diagram for animals. The arrows indicate the direction of the is-a relationship.

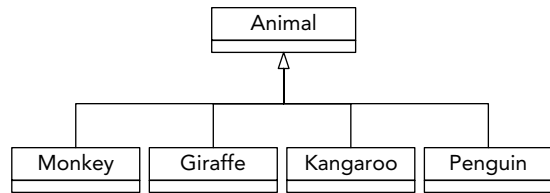

FIGURE 5-5

Just as monkeys and giraffes are different types of animals, a user interface often has different types of buttons. A checkbox, for example, is a button. Assuming that a button is simply a UI element that can be clicked to perform an action, a `Checkbox` extends the `Button` class by adding state—whether the box is checked or unchecked.

When relating classes in an is-a relationship, one goal is to factor common functionality into the *base class*, the class that other classes extend. If you find that all of your derived classes have code that is similar or exactly the same, consider how you could move some or all of the code into the base class. That way, any changes that need to be made only happen in one place and future derived classes get the shared functionality “for free.”

Inheritance Techniques

The preceding examples cover a few of the techniques used in inheritance without formalizing them. When deriving classes, there are several ways that the programmer can distinguish a class from its *parent class*, also called *base class* or *superclass*. A derived class may use one or more of these techniques, and they are recognized by completing the sentence, “A is a B that ...”.

Adding Functionality

A derived class can augment its parent by adding additional functionality. For example, a monkey is an animal that can swing from trees. In addition to having all of the methods of `Animal`, the `Monkey` class also has a `swingFromTrees()` method, which is specific to only the `Monkey` class.

Replacing Functionality

A derived class can replace or *override* a method of its parent entirely. For example, most animals move by walking, so you might give the `Animal` class a `move()` method that simulates walking. If that's the case, a kangaroo is an animal that moves by hopping instead of walking. All the other properties and methods of the `Animal` base class still apply, but the `Kangaroo` derived class simply changes the way that the `move()` method works. Of course, if you find yourself replacing *all* of the functionality of your base class, it may be an indication that inheriting was not the correct thing to do after all, unless the base class is an *abstract* base class. An abstract base class forces each of the derived classes to implement all methods that do not have an implementation in the abstract base class. You cannot create instances of an abstract base class. Abstract base classes are discussed in Chapter 10.

Adding Properties

A derived class can also add new properties to the ones that were inherited from the base class. For example, a penguin has all the properties of an animal but also has a `beak size` property.

Replacing Properties

C++ provides a way of overriding properties similar to the way you can override methods. However, doing so is rarely appropriate, because it hides the property from the base class; that is, the base class can have a specific value for a property with a certain name, while the derived class can have another value for another property but with the same name. Hiding is explained in more detail in Chapter 10. It's important not to get the notion of replacing a property confused with the notion of derived classes having different values for properties. For example, all animals have a `diet` property that indicates what they eat. Monkeys eat `bananas` and penguins eat `fish`, but neither of these is replacing the `diet` property—they simply differ in the value assigned to the property.

Polymorphism versus Code Reuse

Polymorphism is the notion that objects that adhere to a standard set of properties and methods can be used interchangeably. A class definition is like a contract between objects and the code that interacts with them. By definition, any `monkey` object must support the properties and methods of the `monkey` class.

This notion extends to base classes as well. Because all monkeys are animals, all `Monkey` objects support the properties and methods of the `Animal` class as well.

Polymorphism is a beautiful part of object-oriented programming because it truly takes advantage of what inheritance offers. In a zoo simulation, you could programmatically loop through all of the animals in the zoo and have each animal move once. Because all animals are members of the `Animal` class, they all know how to move. Some of the animals have overridden the `move` method, but that's the best part—your code simply tells each animal to move without knowing or caring what type of animal it is. Each one moves whichever way it knows how.

There is another reason to use inheritance besides polymorphism. Often, it's just a matter of leveraging existing code. For example, if you need a class that plays music with an echo effect, and your coworker has already written one that plays music without any effects, you might be able to derive a

new class from the existing class and add in the new functionality. The is-a relationship still applies (an echo music player is a music player that adds an echo effect), but you didn't intend for these classes to be used interchangeably. What you end up with are two separate classes, used in completely different parts of the program (or maybe even in different programs entirely) that happen to be related only to avoid reinventing the wheel.

The Fine Line between Has-A and Is-A

In the real world, it's pretty easy to classify has-a and is-a relationships between objects. Nobody would claim that an orange has a fruit—an orange *is a* fruit. In code, things sometimes aren't so clear.

Consider a hypothetical class that represents a hash table. A hash table is a data structure that efficiently maps a key to a value. For example, an insurance company could use a `Hashtable` class to map member IDs to names so that given an ID, it's easy to find the corresponding member name. The member ID is the *key* and the member name is the *value*.

In a standard hash table implementation, every key has a single value. If the ID 14534 maps to the member name “Kleper, Scott”, it cannot also map to the member name “Kleper, Marni”. In most implementations, if you tried to add a second value for a key that already has a value, the first value would go away. In other words, if the ID 14534 mapped to “Kleper, Scott” and you then assigned the ID 14534 to “Kleper, Marni”, then Scott would effectively be uninsured. This is demonstrated in the following sequence, which shows two calls to a hypothetical hash table `insert()` method and the resulting contents of the hash table.

```
hash.insert(14534, "Kleper, Scott");
```

KEYS	VALUES
14534	“Kleper, Scott” [string]

```
hash.insert(14534, "Kleper, Marni");
```

KEYS	VALUES
14534	“Kleper, Marni” [string]

It's not difficult to imagine uses for a data structure that's *like* a hash table, but allows multiple values for a given key. In the insurance example, a family might have several names that correspond to the same ID. Because such a data structure is very similar to a hash table, it would be nice to leverage that functionality somehow. A hash table can have only a single value as a key, but that value can be anything. Instead of a string, the value could be a collection (such as an array or a list) containing the multiple values for the key. Every time you add a new member for an existing ID, you add the name to the collection. This would work as shown in the following sequence:

```
Collection collection; // Make a new collection.
collection.insert("Kleper, Scott"); // Add a new element to the collection.
hash.insert(14534, collection); // Insert the collection into the table.
```

KEYS	VALUES
14534	{"Kleper, Scott"} [collection]

```
Collection collection = hash.get(14534); // Retrieve the existing collection.
collection.insert("Kleper, Marni");    // Add a new element to the collection.
hash.insert(14534, collection); // Replace the collection with the updated one.
```

KEYS	VALUES
14534	{"Kleper, Scott", "Kleper, Marni"} [collection]

Messing around with a collection instead of a string is tedious and requires a lot of repetitive code. It would be preferable to wrap up this multiple-value functionality in a separate class, perhaps called a `MultiHash`. The `MultiHash` class would work just like `Hashtable` except that behind the scenes, it would store each value as a collection of strings instead of a single string. Clearly, `MultiHash` is somehow related to `Hashtable` because it is still using a hash table to store the data. What is unclear is whether that constitutes an is-a or a has-a relationship.

To start with the is-a relationship, imagine that `MultiHash` is a derived class of `Hashtable`. It would have to override the method that adds an entry into the table so that it would either create a collection and add the new element, or retrieve the existing collection and add the new element. It would also override the method that retrieves a value. It could, for example, append all the values for a given key together into one string. This seems like a perfectly reasonable design. Even though it overrides all the methods of the base class, it will still make use of the base class's methods by using the original methods within the derived class. This approach is shown in the UML class diagram in Figure 5-6.

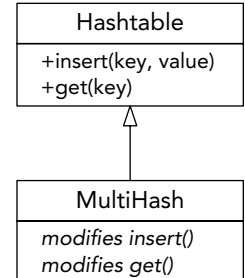

FIGURE 5-6

Now consider it as a has-a relationship. `MultiHash` is its own class, but it *contains* a `Hashtable` object. It probably has an interface very similar to `Hashtable`, but it need not be the same. Behind the scenes, when a user adds something to the `MultiHash`, it is really wrapped in a collection and put in a `Hashtable` object. This also seems perfectly reasonable and is shown in Figure 5-7.

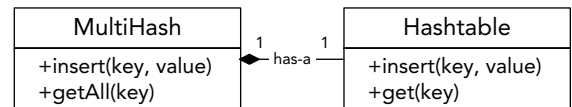

FIGURE 5-7

So, which solution is right? There's no clear answer, though a friend of mine who has written a `MultiHash` class for production use, viewed it as a has-a relationship. The main reason was to allow modifications to the exposed interface without worrying about maintaining hash table functionality. For example, in Figure 5-7, the `get()` method was changed to `getAll()`, making it clear that this would get all the values for a particular key in a `MultiHash`. Additionally, with a has-a relationship, you don't have to worry about any hash table functionality bleeding through. For example, if the hash table class supported a method that would get the total number of values, it would report the number of collections unless `MultiHash` knew to override it.

That said, one could make a convincing argument that a `MultiHash` actually is a `Hashtable` with some new functionality, and it should have been an is-a relationship. The point is that there is sometimes a fine line between the two relationships, and you will need to consider how the class is going to be used and whether what you are building just leverages some functionality from another class or really is that class with modified or new functionality.

The following table represents the arguments for and against taking either approach for the `MultiHash` class.

	IS-A	HAS-A
Reasons For	<p>Fundamentally, it's the same abstraction with different characteristics.</p> <p>It provides (almost) the same methods as <code>Hashtable</code>.</p>	<p><code>MultiHash</code> can have whatever methods are useful without needing to worry about what methods <code>Hashtable</code> has.</p> <p>The implementation could change to something other than a <code>Hashtable</code> without changing the exposed methods.</p>
Reasons Against	<p>A hash table by definition has one value per key. To say <code>MultiHash</code> is a hash table is blasphemy!</p> <p><code>MultiHash</code> overrides both methods of <code>Hashtable</code>, a strong sign that something about the design is wrong.</p> <p>Unknown or inappropriate properties or methods of <code>Hashtable</code> could "bleed through" to <code>MultiHash</code>.</p>	<p>In a sense, <code>MultiHash</code> reinvents the wheel by coming up with new methods. Some additional properties and methods of <code>Hashtable</code> might have been useful.</p>

The reasons against using an is-a relationship in this case are pretty strong. Additionally, the *Liskov substitution principle* (LSP) can help you decide between an is-a and a has-a relationship. This principle states that you should be able to use a derived class instead of a base class without altering the behavior. Applied to this example, it states that this should be a has-a relationship, because you cannot just start using a `MultiHash` where before you were using a `Hashtable`. If you would do so, the behavior would change. For example, the `insert()` method of `Hashtable` removes an earlier value with the same key that is already in the map, while `MultiHash` does not remove such values.

If you do have a choice between the two types of relationships, I recommend, after years of experience, opting for a has-a relationship over an is-a relationship.

Note that the `Hashtable` and `MultiHash` are used here to demonstrate the difference between the is-a and has-a relationships. In your own code, it is recommended to use one of the standard hash table classes instead of writing your own. The C++ Standard Library provides an `unordered_map` class, which you should use instead of the `Hashtable`, and an `unordered_multimap` class,

which you should use instead of the `MultiHash`. Both of these standard classes are discussed in Chapter 17.

The Not-A Relationship

As you consider what type of relationship classes have, you should consider whether or not they actually have a relationship at all. Don't let your zeal for object-oriented design turn into a lot of needless class/derived-class relationships.

One pitfall occurs when things are obviously related in the real world but have no actual relationship in code. Object-oriented hierarchies need to model *functional* relationships, not artificial ones. Figure 5-8 shows relationships that are meaningful as ontologies or hierarchies, but are unlikely to represent a meaningful relationship in code.

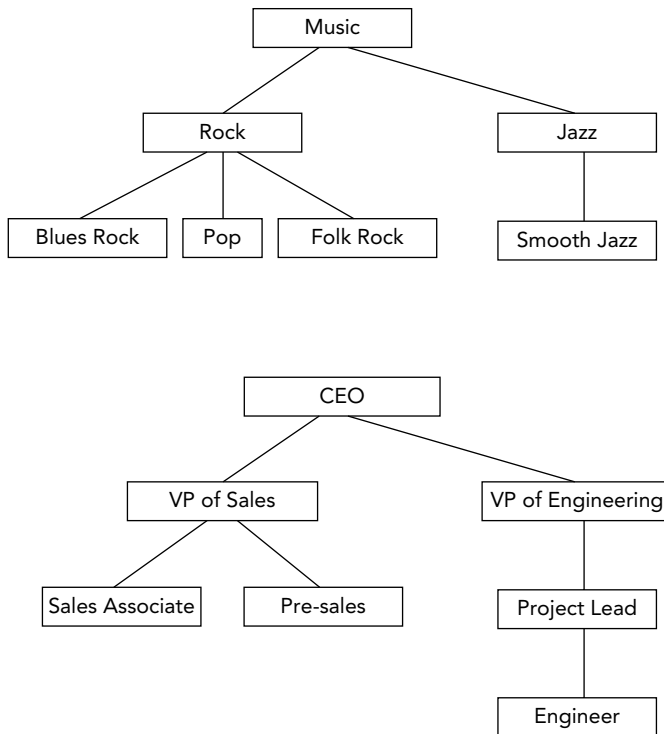

FIGURE 5-8

The best way to avoid needless inheritance is to sketch out your design first. For every class and derived class, write down what properties and methods you're planning on putting into the class. You should rethink your design if you find that a class has no particular properties or methods of its own, or if all of those properties and methods are completely overridden by its derived classes, except when working with abstract base classes as mentioned earlier.

Hierarchies

Just as a class `A` can be a base class of `B`, `B` can also be a base class of `C`. Object-oriented hierarchies can model multilevel relationships like this. A zoo simulation with more animals might be designed with every animal as a derived class of a common `Animal` class, as shown in Figure 5-9.

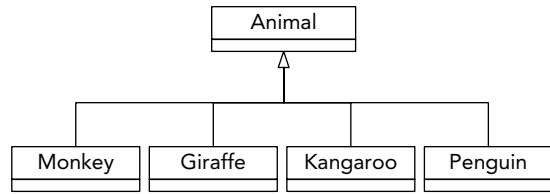

FIGURE 5-9

As you code each of these derived classes, you might find that a lot of them are similar. When this occurs, you should consider putting in a common parent. Realizing that `Lion` and `Panther` both move the same way and have the same diet might indicate a need for a possible `BigCat` class. You could further subdivide the `Animal` class to include `WaterAnimal` and `Marsupial`. A more hierarchical design that leverages this commonality is shown in Figure 5-10.

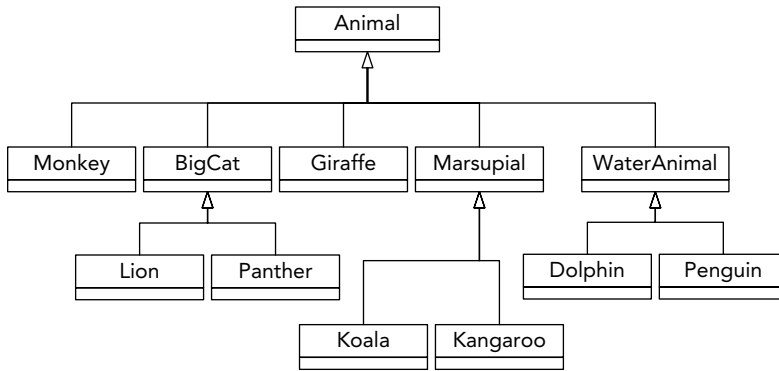

FIGURE 5-10

A biologist looking at this hierarchy may be disappointed—a penguin isn't really in the same family as a dolphin. However, it underlines a good point—in code, you need to balance real-world relationships with shared-functionality relationships. Even though two things might be very closely related in the real world, they might have a not-a relationship in code because they really don't share functionality. You could just as easily divide animals into mammals and fish, but that wouldn't factor any commonality to the base class.

Another important point is that there could be other ways of organizing the hierarchy. The preceding design is organized mostly by how the animals move. If it were instead organized by the animals' diet or height, the hierarchy could be very different. In the end, what matters is how the classes will be used. The needs will dictate the design of the object hierarchy.

A good object-oriented hierarchy accomplishes the following:

- Organizes classes into meaningful functional relationships
- Supports code reuse by factoring common functionality to base classes
- Avoids having derived classes that override much of the parent's functionality, unless the parent is an abstract class.

Multiple Inheritance

Every example so far has had a single inheritance chain. In other words, a given class has, at most, one immediate parent class. This does not have to be the case. Through multiple inheritance, a class can have more than one base class.

Figure 5-11 shows a multiple inheritance design. There is still a base class called `Animal`, which is further divided by size. A separate hierarchy categorizes by diet, and a third takes care of movement. Each type of animal is then a derived class of all three of these classes, as shown by different lines.

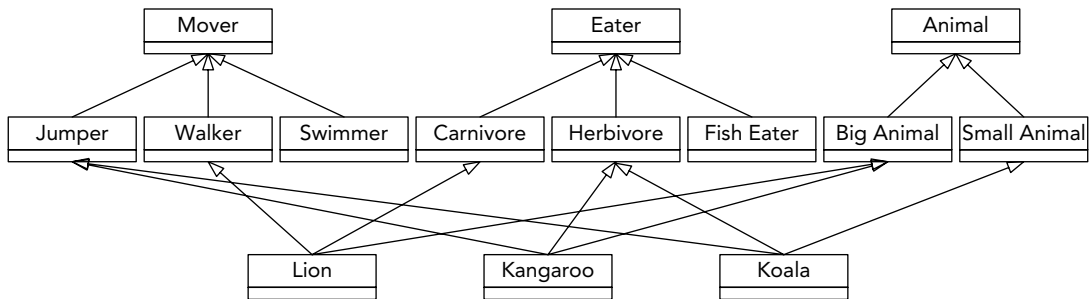

FIGURE 5-11

In a user interface context, imagine an image that the user can click on. This object seems to be both a button and an image so the implementation might involve inheriting from both the `Image` class and the `Button` class, as shown in Figure 5-12.

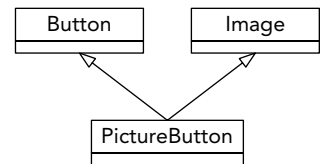

FIGURE 5-12

Multiple inheritance can be very useful in certain cases, but it also has a number of disadvantages that you should always keep in mind. Many programmers dislike multiple inheritance. C++ has explicit support for such relationships, though the Java language does away with them altogether, except for inheriting from multiple interfaces (abstract base classes). There are several reasons to which multiple inheritance critics point.

First, visualizing multiple inheritance is complicated. As you can see in Figure 5-11, even a simple class diagram can become very complicated when there are multiple hierarchies and crossing lines. Class hierarchies are supposed to make it easier for the programmer to understand the relationships between code. With multiple inheritance, a class could have several parents that are in no way related to each other. With so many classes contributing code to your object, can you really keep track of what's going on?

Second, multiple inheritance can destroy otherwise clean hierarchies. In the animal example, switching to a multiple inheritance approach means that the `Animal` base class is less meaningful because the code that describes animals is now separated into three separate hierarchies. While the design illustrated in Figure 5-11 shows three clean hierarchies, it's not difficult to imagine how they could get messy. For example, what if you realize that all `Jumpers` not only move in the same way, but they also eat the same things? Because there are separate hierarchies, there is no way to join the concepts of movement and diet without adding yet another derived class.

Third, implementation of multiple inheritance is complicated. What if two of your base classes implement the same method in different ways? Can you have two base classes that are themselves a derived class of a common base class? These possibilities complicate the implementation because structuring such intricate relationships in code is difficult both for the author and a reader.

The reason that other languages can leave out multiple inheritance is that it is usually avoidable. By rethinking your hierarchy, you can often avoid introducing multiple inheritance when you have control over the design of a project.

Mixin Classes

Mixin classes represent another type of relationship between classes. In C++, a mixin class is implemented syntactically just like multiple inheritance, but the semantics are refreshingly different. A mixin class answers the question, “What *else* is this class able to do?” and the answer often ends with “-able.” Mixin classes are a way that you can add functionality to a class without committing to a full is-a relationship. You can think of it as a *shares-with* relationship.

Going back to the zoo example, you might want to introduce the notion that some animals are “pettable.” That is, there are some animals that visitors to the zoo can pet, presumably without being bitten or mauled. You might want all pettable animals to support the behavior “be pet.” Because pettable animals don’t have anything else in common and you don’t want to break the existing hierarchy you’ve designed, `Pettable` makes a great mixin class.

Mixin classes are used frequently in user interfaces. Instead of saying that a `PictureButton` class is both an `Image` and a `Button`, you might say that it’s an `Image` that is `Clickable`. A folder icon on your desktop could be an `Image` that is `Draggable` and `Clickable`. Software developers tend to make up a lot of fun adjectives.

The difference between a mixin class and a base class has more to do with how you think about the class than any code difference. In general, mixin classes are easier to digest than multiple inheritance because they are very limited in scope. The `Pettable` mixin class just adds one behavior to any existing class. The `Clickable` mixin class might just add “mouse down” and “mouse up” behaviors. Also, mixin classes rarely have a large hierarchy so there’s no cross-contamination of functionality. Chapter 28 goes into more detail on mixin classes.

ABSTRACTION

In Chapter 4, you learned about the concept of abstraction—the notion of separating implementation from the means used to access it. Abstraction is a good idea for many reasons that were explored earlier. It’s also a fundamental part of object-oriented design.

Interface versus Implementation

The key to abstraction is effectively separating the *interface* from the *implementation*. The implementation is the code you’re writing to accomplish the task you set out to accomplish. The interface is the way that other people use your code. In C, the header file that describes the functions in a library you’ve written is an interface. In object-oriented programming, the interface to a class is

the collection of publicly accessible properties and methods. A good interface contains only public methods. Properties of a class should never be made public but can be exposed through public methods, also called *getters* and *setters*.

Deciding on an Exposed Interface

The question of how other programmers will interact with your objects comes into play when designing a class. In C++, a class's properties and methods can each be `public`, `protected`, or `private`. Making a property or method `public` means that other code can access it; `protected` means that other code cannot access the property or method but derived classes can access them; `private` is a stricter control, which means that not only are the properties or methods locked for other code, but even derived classes can't access them. Note that access specifiers are at the class level, not at the object level. This means that a method of a class can access, for example, `private` properties or `private` methods of other objects of the same class.

Designing the exposed interface is all about choosing what to make `public`. When working on a large project with other programmers, you should view the exposed interface design as a process.

Consider the Audience

The first step in designing an exposed interface is to consider whom you are designing it for. Is your audience another member of your team? Is this an interface that you will personally be using? Is it something that a programmer external to your company will use? Perhaps a customer or an offshore contractor? In addition to determining who will be coming to you for help with the interface, this should shed some light on some of your design goals.

If the interface is for your own use, you probably have more freedom to iterate on the design. As you're making use of the interface, you can change it to suit your own needs. However, you should keep in mind that roles on an engineering team change and it is quite likely that, some day, others will be using this interface as well.

Designing an interface for other internal programmers to use is slightly different. In a way, your interface becomes a contract with them. For example, if you are implementing the data store component of a program, others are depending on that interface to support certain operations. You will need to find out all of the things that the rest of the team wants your class to do. Do they need versioning? What types of data can they store? As a contract, you should view the interface as slightly less flexible. If the interface is agreed upon before coding begins, you'll receive some groans from other programmers if you decide to change it after code has been written.

If the client is an external customer, you will be designing with a very different set of requirements. Ideally, the target customer will be involved in specifying what functionality your interface exposes. You'll need to consider both the specific features they want as well as what customers might want in the future. The terminology used in the interface will have to correspond to the terms that the customer is familiar with, and the documentation will have to be written with that audience in mind. Inside jokes, codenames, and programmer slang should be left out of your design.

Consider the Purpose

There are many reasons for writing an interface. Before putting any code on paper or even deciding on what functionality you're going to expose, you need to understand the purpose of the interface.

Application Programming Interface

An application programming interface (API) is an externally visible mechanism to extend a product or use its functionality within another context. If an internal interface is a contract, an API is closer to a set-in-stone law. Once people who don't even work for your company are using your API, they don't want it to change unless you're adding new features that will help them. So, care should be given to planning the API and discussing it with customers before making it available to them.

The main tradeoff in designing an API is usually ease of use versus flexibility. Because the target audience for the interface is not familiar with the internal working of your product, the learning curve to use the API should be gradual. After all, your company is exposing this API to customers because the company wants it to be used. If it's too difficult to use, the API is a failure. Flexibility often works against this. Your product may have a lot of different uses, and you want the customer to be able to leverage all the functionality you have to offer. However, an API that lets the customer do anything that your product can do may be too complicated.

As a common programming adage goes, “A good API makes the easy case easy and the hard case *possible*.” That is, APIs should have a simple learning curve. The things that most programmers will want to do should be accessible. However, the API should allow for more advanced usage, and it's acceptable to trade off complexity of the rare case for simplicity of the common case.

Utility Class or Library

Often, your task is to develop some particular functionality for general use elsewhere in the application. It could be a random number library or a logging class. In these cases, the interface is somewhat easier to decide on because you tend to expose most or all of the functionality, ideally without giving too much away about its implementation. Generality is an important issue to consider. Because the class or library is general purpose, you'll need to take the possible set of use cases into account in your design.

Subsystem Interface

You may be designing the interface between two major subsystems of the application, such as the mechanism for accessing a database. In these cases, separating the interface from the implementation is paramount because other programmers are likely to start implementing against your interface before your implementation is complete. When working on a subsystem, first think about what its main purpose is. Once you have identified the main task your subsystem is charged with, think about specific uses and how it should be presented to other parts of the code. Try to put yourself in their shoes and not get bogged down in implementation details.

Component Interface

Most of the interfaces you define will probably be smaller than a subsystem interface or an API. These will be classes that you use within other code that you've written. In these cases, the main pitfall occurs when your interface evolves gradually and becomes unruly. Even though these interfaces are for your own use, think of them as though they weren't. As with a subsystem interface, consider the main purpose of each class and be cautious of exposing functionality that doesn't contribute to that purpose.

Consider the Future

As you are designing your interface, keep in mind what the future holds. Is this a design you will be locked into for years? If so, you might need to leave room for expansion by coming up with a plug-in architecture. Do you have evidence that people will try to use your interface for purposes other than what it was designed for? Talk to them and get a better understanding of their use case. The alternative is rewriting it later, or worse, attaching new functionality haphazardly and ending up with a messy interface. Be careful, though! Speculative generality is yet another pitfall. Don't design the be-all, end-all logging class if the future uses are unclear, because it might unnecessarily complicate the design, the implementation, and its public interface.

Designing a Successful Abstraction

Experience and iteration are essential to good abstractions. Truly well-designed interfaces come from years of writing and using other abstractions. You can also leverage someone else's years of writing and using abstractions by reusing existing, well-designed abstractions in the form of standard design patterns. As you encounter other abstractions, try to remember what worked and what didn't work. What did you find lacking in the Windows file system API you used last week? What would you have done differently if you had written the network wrapper, instead of your coworker? The best interface is rarely the first one you put on paper, so keep iterating. Bring your design to your peers and ask for feedback. If your company uses code reviews, start the code review by doing a review of the interface specifications before the implementation starts. Don't be afraid to change the abstraction once coding has begun, even if it means forcing other programmers to adapt. Hopefully, they'll realize that a good abstraction is beneficial to everyone in the long term.

Sometimes you need to evangelize a bit when communicating your design to other programmers. Perhaps the rest of the team didn't see a problem with the previous design or feels that your approach requires too much work on their part. In those situations, be prepared both to defend your work and to incorporate their ideas when appropriate.

A good abstraction means that the interface has only public methods. All code should be in the implementation file and not in the class definition file. This means that the interface files containing the class definitions are stable and will not change. A specific technique to accomplish this is called the private implementation idiom, or pimpl idiom, and is discussed in Chapter 9.

Beware of single-class abstractions. If there is significant depth to the code you're writing, consider what other companion classes might accompany the main interface. For example, if you're exposing an interface to do some data processing, consider also writing a result object that provides an easy way to view and interpret the results.

Always turn properties into methods. In other words, don't allow external code to manipulate the data behind your class directly. You don't want some careless or nefarious programmer to set the height of a bunny object to a negative number. Instead, have a "set height" method that does the necessary bounds checking.

Iteration is worth mentioning again because it is the most important point. Seek and respond to feedback on your design, change it when necessary, and learn from mistakes.

SUMMARY

In this chapter, you've gained an appreciation for the design of object-oriented programs without a lot of code getting in the way. The concepts you've learned are applicable to almost any object-oriented language. Some of it may have been a review to you, or it may be a new way of formalizing a familiar concept. Perhaps you picked up some new approaches to old problems, or new arguments in favor of the concepts you've been preaching to your team all along. Even if you've never used objects in your code, or have used them only sparingly, you now know more about how to design object-oriented programs than many experienced C++ programmers.

The relationships between objects are important to study, not just because well-linked objects contribute to code reuse and reduce clutter, but also because you will be working in a team. Objects that relate in meaningful ways are easier to read and maintain. You may decide to use the “Object Relationships” section as a reference when you design your programs.

Finally, you learned about creating successful abstractions and the two most important design considerations—audience and purpose.

The next chapter continues the design theme by explaining how to design your code with reuse in mind.

6

Designing for Reuse

WHAT'S IN THIS CHAPTER?

- The reuse philosophy: Why you should design code for reuse
- How to design reusable code
 - How to use abstraction
 - Strategies for structuring your code for reuse
 - Six strategies for designing usable interfaces
 - How to reconcile generality with ease of use
- The SOLID principles

Reusing libraries and other code in your programs is an important design strategy. However, it is only half of the *reuse* strategy. The other half is designing and writing the code that you can reuse in your programs. As you've probably discovered, there is a significant difference between well-designed and poorly designed libraries. Well-designed libraries are a pleasure to use, while poorly designed libraries can prod you to give up in disgust and write the code yourself. Whether you're writing a library explicitly designed for use by other programmers or merely deciding on a class hierarchy, you should design your code with reuse in mind. You never know when you'll need a similar piece of functionality in a subsequent project.

Chapter 4 introduces the design theme of reuse and explains how to apply this theme by incorporating libraries and other code in your designs, but it doesn't explain *how* to design reusable code. That is the topic of this chapter. It builds on the object-oriented design principles described in Chapter 5.

THE REUSE PHILOSOPHY

You should design code that both you and other programmers can reuse. This rule applies not only to libraries and frameworks that you specifically intend for other programmers to use, but also to any class, subsystem, or component that you design for a program. You should always keep in mind the mottos:

- “Write once, use often”
- “Avoid code duplication at any cost”
- “DRY—Don’t Repeat Yourself”

There are several reasons for this:

- **Code is rarely used in only one program.** You can be sure that your code will be used again somehow, so design it correctly to begin with.
- **Designing for reuse saves time and money.** If you design your code in a way that precludes future use, you ensure that you or your partners will spend time reinventing the wheel later when you encounter a need for a similar piece of functionality.
- **Other programmers in your group must be able to use the code that you write.** You are probably not working alone on a project. Your coworkers will appreciate your efforts to offer them well-designed, functionality-packed libraries and pieces of code to use. Designing for reuse can also be called *cooperative coding*.
- **Lack of reuse leads to code duplication; code duplication leads to a maintenance nightmare.** If a bug is found in duplicated code, it has to be fixed in all places where it got duplicated. Whenever you find yourself copy-pasting a piece of code, you have to at least consider moving it out to a helper function or class.
- **You will be the primary beneficiary of your own work.** Experienced programmers never throw away code. Over time, they build a personal library of evolving tools. You never know when you will need a similar piece of functionality in the future.

WARNING *When you design or write code as an employee of a company, the company, not you, generally owns the intellectual property rights. It is often illegal to retain copies of your designs or code when you terminate your employment with the company. The same is also true when you are self-employed and working for clients.*

HOW TO DESIGN REUSABLE CODE

Reusable code fulfills two main goals. First, it is general enough to use for slightly different purposes or in different application domains. Program components with details of a specific application are difficult to reuse in other programs.

Second, reusable code is also easy to use. It doesn't require significant time to understand its interface or functionality. Programmers must be able to incorporate it readily into their applications.

The means of “delivering” your library to clients is also important. You can deliver it in source form and clients just incorporate your source into their project. Another option is to deliver a static library, which they link into their application, or you can deliver a Dynamic Link Library (DLL) for Windows clients, or a shared object (.so) for Linux clients. Each of these delivery mechanisms can impose additional constraints on how you code your library.

NOTE *This chapter uses the term “client” to refer to a programmer who uses your interfaces. Don't confuse clients with “users” who run your programs. This chapter also uses the phrase “client code” to refer to code that is written to use your interfaces.*

The most important strategy for designing reusable code is abstraction. Chapter 4 presents the real-world analogy of a television, which you can use through its interfaces without understanding how it works inside. Similarly, when you design code, you should clearly separate the interface from the implementation. This separation makes the code easier to use, primarily because clients do not need to understand the internal implementation details in order to use the functionality.

Abstraction separates code into interfaces and implementation, so designing reusable code focuses on these two main areas. First, you must structure the code appropriately. What class hierarchies will you use? Should you use templates? How should you divide the code into subsystems?

Second, you must design the *interfaces*, which are the “entries” into your library, or code that programmers use, to access the functionality you provide.

Use Abstraction

You learned about the principle of abstraction in Chapter 4 and read more about its application to object-oriented design in Chapter 5. To follow the principle of abstraction, you should provide interfaces to your code that hide the underlying implementation details. There should be a clear distinction between the interface and the implementation.

Using abstraction benefits both you and the clients who use your code. Clients benefit because they don't need to worry about the implementation details; they can take advantage of the functionality you offer without understanding how the code really works. You benefit because you can modify the underlying code without changing the interface to the code. Thus, you can provide upgrades and fixes without requiring clients to change their use. With dynamically linked libraries, clients might not even need to rebuild their executables. Finally, you both benefit because you, as the library writer, can specify in the interface exactly what interactions you expect and what functionality you support. Consult Chapter 3 for a discussion on how to write documentation. A clear separation of interfaces and implementations will prevent clients from using the library in ways that you didn't intend, which can otherwise cause unexpected behaviors and bugs.

WARNING *When designing your interface, do not expose implementation details to your clients.*

Sometimes libraries require client code to keep information returned from one interface in order to pass it to another. This information is sometimes called a *handle* and is often used to keep track of specific instances that require state to be remembered between calls. If your library design requires a handle, don't expose its internals. Make that handle into an *opaque* class, in which the programmer can't access the internal data members, either directly, or through public getters or setters. Don't require the client code to tweak variables inside this handle. An example of a bad design would be a library that requires you to set a specific member of a structure in a supposedly opaque handle in order to turn on error logging.

NOTE *Unfortunately, C++ is fundamentally unfriendly to the principle of good abstraction when writing classes. The syntax requires you to combine your public interfaces and non-public (private or protected) data members and methods together in one class definition, thereby exposing some of the internal implementation details of the class to its clients. Chapter 9 describes some techniques for working around this in order to present clean interfaces.*

Abstraction is so important that it should guide your entire design. As part of every decision you make, ask yourself whether your choice fulfills the principle of abstraction. Put yourself in your clients' shoes and determine whether or not you're requiring knowledge of the internal implementation in the interface. You should rarely, if ever, make exceptions to this rule.

Structure Your Code for Optimal Reuse

You must consider reuse from the beginning of your design, on all levels, that is, from a single function, over a class, to entire libraries and frameworks. In the text that follows, all these different levels are called components. The following strategies will help you organize your code properly. Note that all of these strategies focus on making your code general purpose. The second aspect of designing reusable code, providing ease of use, is more relevant to your interface design and is discussed later in this chapter.

Avoid Combining Unrelated or Logically Separate Concepts

When you design a component, you should keep it focused on a single task or group of tasks, that is, you should strive for *high cohesion*. This is also known as the *Single Responsibility Principle* (SRP). Don't combine unrelated concepts such as a random number generator and an XML parser.

Even when you are not designing code specifically for reuse, keep this strategy in mind. Entire programs are rarely reused on their own. Instead, pieces or subsystems of the programs are incorporated directly into other applications, or are adapted for slightly different uses. Thus, you should design your programs so that you divide logically separate functionality into distinct components that can be reused in different programs. Each such component should have well-defined responsibilities.

This program strategy models the real-world design principle of discrete, interchangeable parts. For example, you could write a `Car` class and put all properties and behaviors of the engine into it.

However, engines are separable components that are not tied to other aspects of the car. The engine could be removed from one car and put into another car. A proper design would include an `Engine` class that contains all engine-specific functionality. A `Car` instance then just contains an instance of `Engine`.

Divide Your Programs into Logical Subsystems

You should design your subsystems as discrete components that can be reused independently, that is, strive for *low coupling*. For example, if you are designing a networked game, keep the networking and graphical user interface aspects in separate subsystems. That way, you can reuse either component without dragging in the other one. For example, you might want to write a non-networked game, in which case you could reuse the graphical interface subsystem, but wouldn't need the networking aspect. Similarly, you could design a peer-to-peer file-sharing program, in which case you could reuse the networking subsystem but not the graphical user interface functionality.

Make sure to follow the principle of abstraction for each subsystem. Think of each subsystem as a miniature library for which you must provide a coherent and easy-to-use interface. Even if you're the only programmer who ever uses these miniature libraries, you will benefit from well-designed interfaces and implementations that separate logically distinct functionality.

Use Class Hierarchies to Separate Logical Concepts

In addition to dividing your program into logical subsystems, you should avoid combining unrelated concepts at the class level. For example, suppose you want to write a class for a self-driving car. You decide to start with a basic class for a car and incorporate all the self-driving logic directly into it. However, what if you just want a non-self-driving car in your program? In that case, all the logic related to self-driving is useless, and might require your program to link with libraries that it could otherwise avoid, such as vision libraries, LIDAR libraries, and so on. A solution is to create a class hierarchy (introduced in Chapter 5) in which a self-driving car is a derived class of a generic car. That way, you can use the car base class in programs that do not need self-driving capabilities without incurring the cost of such algorithms. Figure 6-1 shows this hierarchy.

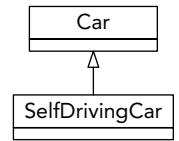

FIGURE 6-1

This strategy works well when there are two logical concepts, such as self-driving and cars. It becomes more complicated when there are three or more concepts. For example, suppose you want to provide both a truck and a car, each of which could be self-driving or not. Logically, both the truck and the car are a special case of a vehicle, and so they should be derived classes of a vehicle class. Similarly, self-driving classes could be derived classes of non-self-driving classes. You can't provide these separations with a linear hierarchy. One possibility is to make the self-driving aspect a mixin class as shown in Figure 6-2. The `SelfDriveable` mixin class provides all the necessary algorithms for implementing the self-driving functionality.

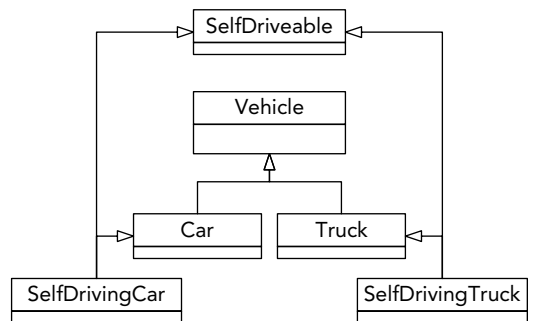

FIGURE 6-2

This hierarchy requires you to write six different classes, but the clear separation of functionality is worth the effort.

Similarly, you should avoid combining unrelated concepts, that is, strive for high cohesion, at any level of your design, not only at the class level. For example, at the level of methods, a single method should not perform logically unrelated things, mix mutation (set) and inspection (get), and so on.

Use Aggregation to Separate Logical Concepts

Aggregation, discussed in Chapter 5, models the *has-a* relationship: objects contain other objects to perform some aspects of their functionality. You can use aggregation to separate unrelated or related but separate functionality when inheritance is not appropriate.

For example, suppose you want to write a `Family` class to store the members of a family. Obviously, a tree data structure would be ideal for storing this information. Instead of integrating the code for the tree structure in your `Family` class, you should write a separate `Tree` class. Your `Family` class can then contain and use a `Tree` instance. To use the object-oriented terminology, the `Family` has-a `Tree`. With this technique, the tree data structure could be reused more easily in another program.

Eliminate User Interface Dependencies

If your library is a data manipulation library, you want to separate data manipulation from the user interface. This means that for those kinds of libraries you should never assume in which type of user interface the library will be used. As such, do not use `cout`, `cerr`, `cin`, `stdout`, `stderr`, or `stdin`, because if the library is used in the context of a graphical user interface, these concepts may make no sense. For example, a Windows GUI-based application usually will not have any form of console I/O. If you think your library will only be used in GUI-based applications, you should still never pop up any kind of message box or other kind of notification to the end user, because that is the responsibility of the client code. It's the client code that decides how messages are displayed for the user. These kinds of dependencies not only result in poor reusability, but they also prevent client code from properly responding to an error, for example, to handle it silently.

The Model-View-Controller (MVC) paradigm, introduced in Chapter 4, is a well-known design pattern to separate storing data from visualizing that data. With this paradigm, the model can be in the library, while the client code can provide the view and the controller.

Use Templates for Generic Data Structures and Algorithms

C++ has a concept called *templates* that allows you to create structures that are generic with respect to a type or class. For example, you might have written code for an array of integers. If you subsequently would like an array of `doubles`, you need to rewrite and replicate all the code to work with `doubles`. The notion of a template is that the type becomes a parameter to the specification, and you can create a single body of code that can work on any type. Templates allow you to write both data structures and algorithms that work on any types.

The simplest example of this is the `std::vector` class, which is part of the C++ Standard Library. To create a vector of integers, you write `std::vector<int>`; to create a vector of `doubles`, you write `std::vector<double>`. Template programming is, in general, extremely powerful but can be very complex. Luckily, it is possible to create rather simple usages of templates that parameterize

according to a type. Chapters 12 and 22 explain the techniques to write your own templates, while this section discusses some of their important design aspects.

Whenever possible, you should use a generic design for data structures and algorithms instead of encoding specifics of a particular program. Don't write a balanced binary tree structure that stores only book objects. Make it generic, so that it can store objects of any type. That way, you could use it in a bookstore, a music store, an operating system, or anywhere that you need a balanced binary tree. This strategy underlies the Standard Library, which provides generic data structures and algorithms that work on any types.

Why Templates Are Better Than Other Generic Programming Techniques

Templates are not the only mechanism for writing generic data structures. Another approach to write generic structures in C and C++ is to store `void*` pointers instead of pointers of a specific type. Clients can use this structure to store anything they want by casting it to a `void*`. However, the main problem with this approach is that it is not *type-safe*: the containers are unable to check or enforce the types of the stored elements. You can cast any type to a `void*` to store in the structure, and when you remove the pointers from the data structure, you must cast them back to what you think they are. Because there are no checks involved, the results can be disastrous. Imagine a scenario where one programmer stores pointers to `int` in a data structure by first casting them to `void*`, but another programmer thinks they are pointers to `Process` objects. The second programmer will blithely cast the `void*` pointers to `Process*` pointers and try to use them as `Process*` objects. Needless to say, the program will not work as expected.

Yet another approach is to write the data structure for a specific class. Through polymorphism, any derived class of that class can be stored in the structure. Java takes this approach to an extreme: it specifies that every class derives directly or indirectly from the `Object` class. The containers in earlier versions of Java store `Object`s, so they can store objects of any type. However, this approach is also not type-safe. When you remove an object from the container, you must remember what it really is and down-cast it to the appropriate type. Down casting means casting it to a more specific class in a class hierarchy, that is, casting it downward in the hierarchy.

Templates, on the other hand, are type-safe when used correctly. Each instantiation of a template stores only one type. Your program will not compile if you try to store different types in the same template instantiation. Newer versions of Java do support the concept of generics that are type-safe just like C++ templates.

Problems with Templates

Templates are not perfect. First of all, their syntax might be confusing, especially for someone who has not used them before. Second, templates require homogeneous data structures, in which you can store only objects of the same type in a single structure. That is, if you write a templated balanced binary tree, you can create one tree object to store `Process` objects and another tree object to store `ints`. You can't store both `ints` and `Processes` in the same tree. This restriction is a direct result of the type-safe nature of templates. Starting with C++17, there is a standardized way around this homogeneity restriction. You can write your data structure to store `std::variant` or `std::any` objects. An `std::any` object can store a value of any type, while an `std::variant` object can store a value of a selection of types. Both `any` and `variant` are discussed in detail in Chapter 20.

Templates versus Inheritance

Programmers sometimes find it tricky to decide whether to use templates or inheritance. Following are some tips to help you make the decision.

Use templates when you want to provide identical functionality for different types. For example, if you want to write a generic sorting algorithm that works on any type, use templates. If you want to create a container that can store any type, use templates. The key concept is that the templated structure or algorithm treats all types the same. However, if required, templates can be specialized for specific types to treat those types differently. Template specialization is discussed in Chapter 12.

When you want to provide different behaviors for related types, use inheritance. For example, use inheritance if you want to provide two different, but similar, containers such as a queue and a priority queue.

Note that you can combine inheritance and templates. You could write a templated class that derives from a templated base class. Chapter 12 covers the details of the template syntax.

Provide Appropriate Checks and Safeguards

There are two opposite styles for writing safe code. The optimal programming style is probably using a healthy mix of both of them. The first is called *design-by-contract*, which means that the documentation for a function or a class represents a contract with a detailed description of what the responsibility of the client code is and what the responsibility of your function or class is. There are three important aspects of design-by-contract: preconditions, postconditions, and invariants. *Preconditions* list the conditions that client code must satisfy before calling a function or method. *Postconditions* list the conditions that must be satisfied by the function or method when it has finished executing. Finally, *invariants* list the conditions that must be satisfied during the whole execution of the function or method.

Design-by-contract is often used in the Standard Library. For example, `std::vector` defines a contract for using the array notation to get a certain element from a `vector`. The contract states that no bounds checking is performed, but that this is the responsibility of the client code. In other words, a precondition for using array notation to get elements from a `vector` is that the given index is valid. This is done to increase performance for client code that knows their indices are within bounds. `vector` also defines an `at()` method to get a specific element that does perform bounds checking. So, client code can choose whether it uses the array notation without bounds checking, or the `at()` method with bounds checking.

The second style is that you design your functions and classes to be as safe as possible. The most important aspect of this guideline is to perform error checking in your code. For example, if your random number generator requires a seed to be in a specific range, don't just trust the user to pass a valid seed. Check the value that is passed in, and reject the call if it is invalid. The `at()` method of `vector` as discussed in the previous paragraph is another example of a method that is designed with safety in mind. If the user provides an invalid index, the method throws an exception.

As an analogy, consider an accountant who prepares income tax returns. When you hire an accountant, you provide them with all your financial information for the year. The accountant uses this information to fill out forms from the IRS. However, the accountant does not blindly fill out your

information on the form, but instead makes sure the information makes sense. For example, if you own a house, but forget to specify the property tax you paid, the accountant will remind you to supply that information. Similarly, if you say that you paid \$12,000 in mortgage interest, but made only \$15,000 gross income, the accountant might gently ask you if you provided the correct numbers (or at least recommend more affordable housing).

You can think of the accountant as a “program” where the input is your financial information and the output is an income tax return. However, the value added by an accountant is not just that they fill out the forms. You also choose to employ an accountant because of the checks and safeguards that they provide. Similarly in programming, you could provide as many checks and safeguards as possible in your implementations.

There are several techniques and language features that help you to write safe code and to incorporate checks and safeguards in your programs. To report errors to client code, you can return an error code or a distinct value like `false` or `nullptr`. Alternatively, you can throw an exception to notify the client code of any errors. Chapter 14 covers exceptions in detail. To write safe code that works with dynamically allocated resources such as memory, use smart pointers. Conceptually, a smart pointer is a pointer to some resource that automatically frees the resource when it goes out of scope. Smart pointers are introduced in Chapter 1.

Design for Extensibility

You should strive to design your classes in such a way that they can be extended by deriving another class from them, but they should be closed for modification, that is, the behavior should be extendable without you having to modify its implementation. This is called the *Open/Closed Principle* (OCP).

As an example, suppose you start implementing a drawing application. The first version should only support squares. Your design contains two classes: `Square` and `Renderer`. The former contains the definition of a square, such as the length of its sides. The latter is responsible for drawing the squares. You come up with something as follows:

```
class Square
{
    // Details not important for this example.
};

class Renderer
{
public:
    void render(const vector<Square>& squares);
};

void Renderer::render(const vector<Square>& squares)
{
    for (auto& square : squares)
    {
        // Render this square object.
    }
}
```

Next, you add support for circles, so you create a `Circle` class:

```
class Circle
{
    // Details not important for this example.
};
```

To be able to render circles, you have to modify the `render()` method of the `Renderer` class. You decide to change it as follows:

```
void Renderer::render(const vector<Square>& squares,
                     const vector<Circle>& circles)
{
    for (auto& square : squares)
    {
        // Render this square object.
    }
    for (auto& circle : circles)
    {
        // Render this circle object.
    }
}
```

While doing this, you feel there is something wrong, and you are correct! In order to extend the functionality to add support for circles, you have to modify the current implementation of the `render()` method, so it's not closed for modifications.

Your design in this case should use inheritance. This example jumps ahead a bit on the syntax for inheritance. Chapter 10 discusses inheritance; however, the syntactical details are not important to understand this example. For now, you only need to know that the following syntax specifies that `Square` derives from the `Shape` class:

```
class Square : public Shape {};
```

Here is a design using inheritance:

```
class Shape
{
public:
    virtual void render() = 0;
};

class Square : public Shape
{
public:
    virtual void render() override { /* Render square */ }
    // Other members not important for this example.
};

class Circle : public Shape
{
public:
    virtual void render() override { /* Render circle */ }
    // Other members not important for this example.
};
```



```
class Renderer
{
public:
    void render(const vector<shared_ptr<Shape>>& objects);
};

void Renderer::render(const vector<shared_ptr<Shape>>& objects)
{
    for (auto& object : objects)
    {
        object->render();
    }
}
```

With this design, if you want to add support for a new type of shape, you just need to write a new class that derives from `Shape` and that implements the `render()` method. You don't need to modify anything in the `Renderer` class. So, this design can be extended without having to modify the existing code, that is, it's open for extension, and closed for modification.

Design Usable Interfaces

In addition to abstracting and structuring your code appropriately, designing for reuse requires you to focus on the *interface* with which programmers interact. Even if you have the most beautiful and most efficient implementation, your library will not be any good if it has a wretched interface.

Note that every component in your program should have good interfaces, even if you don't intend them to be used in multiple programs. First of all, you never know when something will be reused. Second, a good interface is important even for the first use, especially if you are programming in a group and other programmers must use the code you design and write.

The main purpose of interfaces is to make the code easy to use, but some interface techniques can help you follow the principle of generality as well.

Design Interfaces That Are Easy to Use

Your interfaces should be easy to use. That doesn't mean that they must be trivial, but they should be as simple and intuitive as the functionality allows. You shouldn't require consumers of your library to wade through pages of source code in order to use a simple data structure, or to go through contortions in their code to obtain the functionality they need. This section provides four specific strategies for designing interfaces that are easy to use.

Follow Familiar Ways of Doing Things

The best strategy for developing easy-to-use interfaces is to follow standard and familiar ways of doing things. When people encounter an interface similar to something they have used in the past, they will understand it better, adopt it more readily, and be less likely to use it improperly.

For example, suppose that you are designing the steering mechanism of a car. There are a number of possibilities: a joystick, two buttons for moving left or right, a sliding horizontal lever, or a good old steering wheel. Which interface do you think would be easiest to use? Which interface do you think would sell the most cars? Consumers are familiar with steering wheels, so the answer to both

questions is, of course, the steering wheel. Even if you developed another mechanism that provided superior performance and safety, you would have a tough time selling your product, let alone teaching people how to use it. When you have a choice between following standard interface models and branching out in a new direction, it's usually better to stick to the interface to which people are accustomed.

Innovation is important, of course, but you should focus on innovation in the underlying implementation, not in the interface. For example, consumers are excited about the innovative fully electric engine in some car models. These cars are selling well in part because the interface to use them is identical to cars with standard gasoline engines.

Applied to C++, this strategy implies that you should develop interfaces that follow standards to which C++ programmers are accustomed. For example, C++ programmers expect the constructor and destructor of a class to initialize and clean up an object, respectively. When you design your classes, you should follow this standard. If you require programmers to call `initialize()` and `cleanup()` methods for initialization and cleanup instead of placing that functionality in the constructor and destructor, you will confuse everyone who tries to use your class. Because your class behaves differently from other C++ classes, programmers will take longer to learn how to use it and will be more likely to use it incorrectly by forgetting to call `initialize()` or `cleanup()`.

NOTE *Always think about your interfaces from the perspective of someone using them. Do they make sense? Are they what you would expect?*

C++ provides a language feature called *operator overloading* that can help you develop easy-to-use interfaces for your objects. Operator overloading allows you to write classes such that the standard operators work on them just as they work on built-in types like `int` and `double`. For example, you can write a `Fraction` class that allows you to add, subtract, and stream fractions like this:

```
Fraction f1(3,4);
Fraction f2(1,2);
Fraction sum = f1 + f2;
Fraction diff = f1 - f2;
cout << f1 << " " << f2 << endl;
```

Contrast that with the same behavior using method calls:

```
Fraction f1(3,4);
Fraction f2(1,2);
Fraction sum = f1.add(f2);
Fraction diff = f1.subtract(f2);
f1.print(cout);
cout << " ";
f2.print(cout);
cout << endl;
```

As you can see, operator overloading allows you to provide an easier-to-use interface for your classes. However, be careful not to abuse operator overloading. It's possible to overload the `+` operator so that it implements subtraction and the `-` operator so that it implements multiplication. Those implementations would be counterintuitive. This does not mean that each operator should

always implement exactly the same behavior. For example, the `string` class implements the `+` operator to concatenate strings, which is an intuitive interface for string concatenation. See Chapters 9 and 15 for details on operator overloading.

Don't Omit Required Functionality

This strategy is twofold. First, include interfaces for all behaviors that clients could need. That might sound obvious at first. Returning to the car analogy, you would never build a car without a speedometer for the driver to view their speed! Similarly, you would never design a `Fraction` class without a mechanism for client code to access the nominator and denominator values.

However, other possible behaviors might be more obscure. This strategy requires you to anticipate all the uses to which clients might put your code. If you are thinking about the interface in one particular way, you might miss functionality that could be needed when clients use it differently. For example, suppose that you want to design a game board class. You might consider only the typical games, such as chess and checkers, and decide to support a maximum of one game piece per spot on the board. However, what if you later decide to write a backgammon game, which allows multiple pieces in one spot on the board? By precluding that possibility, you have ruled out the use of your game board as a backgammon board.

Obviously, anticipating every possible use for your library is difficult, if not impossible. Don't feel compelled to agonize over potential future uses in order to design the perfect interface. Just give it some thought and do the best you can.

The second part of this strategy is to include as much functionality in the implementation as possible. Don't require client code to specify information that you already know in the implementation, or could know if you designed it differently. For example, if your library requires a temporary file, don't make the clients of your library specify that path. They don't care what file you use; find some other way to determine an appropriate temporary file path.

Furthermore, don't require library users to perform unnecessary work to amalgamate results. If your random number library uses a random number algorithm that calculates the low-order and high-order bits of a random number separately, combine the numbers before giving them to the user.

Present Uncluttered Interfaces

In order to avoid omitting functionality in their interfaces, some programmers go to the opposite extreme: they include every possible piece of functionality imaginable. Programmers who use the interfaces are never left without the means to accomplish a task. Unfortunately, the interface might be so cluttered that they never figure out how to do it!

Don't provide unnecessary functionality in your interfaces; keep them clean and simple. It might appear at first that this guideline directly contradicts the previous strategy of not omitting necessary functionality. Although one strategy to avoid omitting functionality would be to include every imaginable interface, that is not a sound strategy. You should include *necessary* functionality and omit useless or counterproductive interfaces.

Consider cars again. You drive a car by interacting with only a few components: the steering wheel, the brake and accelerator pedals, the gearshift, the mirrors, the speedometer, and a few other dials on your dashboard. Now, imagine a car dashboard that looked like an airplane cockpit, with hundreds of dials, levers, monitors, and buttons. It would be unusable! Driving a car is so much easier

than flying an airplane that the interface can be much simpler: You don't need to view your altitude, communicate with control towers, or control the myriad components in an airplane such as the wings, engines, and landing gear.

Additionally, from the library development perspective, smaller libraries are easier to maintain. If you try to make everyone happy, then you have more room to make mistakes, and if your implementation is complicated enough so that everything is intertwined, even one mistake can render the library useless.

Unfortunately, the idea of designing uncluttered interfaces looks good on paper, but is remarkably hard to put into practice. The rule is ultimately subjective: you decide what's necessary and what's not. Of course, your clients will be sure to tell you when you get it wrong!

Provide Documentation and Comments

Regardless of how easy you make your interfaces to use, you should supply documentation for their use. You can't expect programmers to use your library properly unless you tell them how to do it. Think of your library or code as a product for other programmers to consume. Your product should have documentation explaining its proper use.

There are two ways to provide documentation for your interfaces: comments in the interfaces themselves and external documentation. You should strive to provide both. Most public APIs provide only external documentation: comments are a scarce commodity in many of the standard Unix and Windows header files. In Unix, the documentation usually comes in the form of online manuals called *man pages*. In Windows, the documentation usually accompanies the integrated development environment.

Despite the fact that most APIs and libraries omit comments in the interfaces themselves, I actually consider this form of documentation the most important. You should never give out a “naked” header file that contains only code. Even if your comments repeat exactly what's in the external documentation, it is less intimidating to look at a header file with friendly comments than one with only code. Even the best programmers still like to see written language every so often!

Some programmers use tools to create documentation automatically from comments. Chapter 3 discusses this technique in more detail.

Whether you provide comments, external documentation, or both, the documentation should describe the *behavior* of the library, not the *implementation*. The behavior includes the inputs, outputs, error conditions and handling, intended uses, and performance guarantees. For example, documentation describing a call to generate a single random number should specify that it takes no parameters, returns an integer in a previously specified range, and should list all the exceptions that might be thrown when something goes wrong. This documentation should not explain the details of the linear congruence algorithm for actually generating the number. Providing too much implementation detail in interface comments is probably the single most common mistake in interface development. Many developers have seen perfectly good separations of interface and implementation ruined by comments in the interface that are more appropriate for library maintainers than clients.

Of course, you should also document your internal implementation; just don't make it publicly available as part of your interface. Chapter 3 provides details on the appropriate use of comments in your code.

Design General-Purpose Interfaces

The interfaces should be general purpose enough that they can be adapted to a variety of tasks. If you encode specifics of one application in a supposedly general interface, it will be unusable for any other purpose. Here are some guidelines to keep in mind.

Provide Multiple Ways to Perform the Same Functionality

In order to satisfy all your “customers,” it is sometimes helpful to provide multiple ways to perform the same functionality. Use this technique judiciously, however, because over-application can easily lead to cluttered interfaces.

Consider cars again. Most new cars these days provide remote keyless entry systems, with which you can unlock your car by pressing a button on a key fob. However, these cars always provide a standard key that you can use to physically unlock the car, for example, when the battery in the key fob is drained. Although these two methods are redundant, most customers appreciate having both options.

Sometimes there are similar situations in program interface design. For example, `std::vector` provides two methods to get access to a single element at a specific index. You can use either the `at()` method, which performs bounds checking, or `operator[]`, which does not. If you know your indices are valid, you can use `operator[]` and forgo the overhead that `at()` incurs due to bounds checking.

Note that this strategy should be considered an exception to the “uncluttered” rule in interface design. There are a few situations where the exception is appropriate, but you should most often follow the “uncluttered” rule.

Provide Customizability

In order to increase the flexibility of your interfaces, provide customizability. Customizability can be as simple as allowing a client to turn error logging on or off. The basic premise of customizability is that it allows you to provide the same basic functionality to every client, but gives clients the ability to tweak it slightly.

You can allow greater customizability through function pointers and template parameters. For example, you could allow clients to set their own error-handling routines.

The Standard Library takes this customizability strategy to the extreme and actually allows clients to specify their own memory allocators for containers. If you want to use this feature, you must write a memory allocator object that follows the Standard Library guidelines and adheres to the required interfaces. Each container in the Standard Library takes an allocator as one of its template parameters. Chapter 21 provides more details.

Reconciling Generality and Ease of Use

The two goals of ease of use and generality sometimes appear to conflict. Often, introducing generality increases the complexity of the interfaces. For example, suppose that you need a graph structure in a map program to store cities. In the interest of generality, you might use templates to write a generic map structure for any type, not just cities. That way, if you need to write a network simulator in your next program, you can employ the same graph structure to store routers in the network.

Unfortunately, by using templates, you make the interface a little clumsier and harder to use, especially if the potential client is not familiar with templates.

However, generality and ease of use are not mutually exclusive. Although in some cases increased generality may decrease ease of use, it is possible to design interfaces that are both general purpose and straightforward to use. Here are two guidelines you can follow.

Supply Multiple Interfaces

In order to reduce complexity in your interfaces while still providing enough functionality, you can provide multiple separate interfaces. This is called the *Interface Segregation Principle (ISP)*. For example, you could write a generic networking library with two separate facets: one presents the networking interfaces useful for games, and the other presents the networking interfaces useful for the HyperText Transport Protocol (HTTP) for web browsing.

Make Common Functionality Easy to Use

When you provide a general-purpose interface, some functionality will be used more often than other functionality. You should make the commonly used functionality easy to use, while still providing the option for the more advanced functionality. Returning to the map program, you might want to provide an option for clients of the map to specify names of cities in different languages. English is so predominant that you could make that the default but provide an extra option to change languages. That way, most clients will not need to worry about setting the language, but those who want to will be able to do so.

The SOLID Principles

The basic principles of object-oriented design are often abbreviated with the easy-to-remember acronym: *SOLID*. The following table summarizes the five SOLID principles. Most of the principles are discussed earlier in this chapter, if not, a reference is given to the chapter where they are discussed.

S	Single Responsibility Principle (SRP) A single component should have a single, well-defined responsibility and should not combine unrelated functionality.
O	Open/Closed Principle (OCP) A class should be open to extension (by deriving from it), but closed for modification.
L	Liskov Substitution Principle (LSP) You should be able to replace an instance of an object with an instance of a subtype of that object. Chapter 5 explains this principle in the section “The Fine Line between Has-A and Is-A” with an example to decide whether the relationship between <code>Hashtable</code> and <code>MultiHash</code> is a has-a or an is-a relationship.

I	Interface Segregation Principle (ISP) Keep interfaces clean and simple. It is better to have many smaller, well-defined single-responsibility interfaces than to have broad, general-purpose interfaces.
D	Dependency Inversion Principle (DIP) Use interfaces to invert dependency relationships. Chapter 4 briefly mentions an example of an <code>ErrorLogger</code> service. You should define an <code>ErrorLogger</code> interface, and use dependency injection to inject this interface into each component that wants to use the <code>ErrorLogger</code> service. Dependency injection is one way to support the dependency inversion principle.

SUMMARY

By reading this chapter, you learned *why* you should design reusable code and *how* you should do it. You read about the philosophy of reuse, summarized as “write once, use often,” and learned that reusable code should be both general purpose and easy to use. You also discovered that designing reusable code requires you to use abstraction, to structure your code appropriately, and to design good interfaces.

This chapter presented specific tips for structuring your code: to avoid combining unrelated or logically separate concepts, to use templates for generic data structures and algorithms, to provide appropriate checks and safeguards, and to design for extensibility.

This chapter also presented six strategies for designing interfaces: to follow familiar ways of doing things, to not omit required functionality, to present uncluttered interfaces, to provide documentation and comments, to provide multiple ways to perform the same functionality, and to provide customizability. It concluded with two tips for reconciling the often-conflicting demands of generality and ease of use: to supply multiple interfaces and to make common functionality easy to use.

The chapter concluded with SOLID, an easy-to-remember acronym that describes the most important design principles discussed in this and other chapters.

This is the last chapter of the second part of the book, which focuses on discussing design themes on a higher level. The next part delves into the implementation phase of the software engineering process, with details of C++ coding.

PART III

C++ Coding the Professional Way

- ▶ CHAPTER 7: Memory Management
- ▶ CHAPTER 8: Gaining Proficiency with Classes and Objects
- ▶ CHAPTER 9: Mastering Classes and Objects
- ▶ CHAPTER 10: Discovering Inheritance Techniques
- ▶ CHAPTER 11: C++ Quirks, Oddities, and Incidentals
- ▶ CHAPTER 12: Writing Generic Code with Templates
- ▶ CHAPTER 13: Demystifying C++ I/O
- ▶ CHAPTER 14: Handling Errors
- ▶ CHAPTER 15: Overloading C++ Operators
- ▶ CHAPTER 16: Overview of the C++ Standard Library
- ▶ CHAPTER 17: Understanding Containers and Iterators
- ▶ CHAPTER 18: Mastering Standard Library Algorithms
- ▶ CHAPTER 19: String Localization and Regular Expressions
- ▶ CHAPTER 20: Additional Library Utilities

7

Memory Management

WHAT'S IN THIS CHAPTER?

- Different ways to use and manage memory
- The often-perplexing relationship between arrays and pointers
- A low-level look at working with memory
- Smart pointers and how to use them
- Solutions to a few memory-related problems

WROX.COM DOWNLOADS FOR THIS CHAPTER

Please note that all the code examples for this chapter are available as a part of this chapter's code download on the book's website at www.wrox.com/go/proc++4e on the Download Code tab.

In many ways, programming in C++ is like driving without a road. Sure, you can go anywhere you want, but there are no lines or traffic lights to keep you from injuring yourself. C++, like the C language, has a hands-off approach toward its programmers. The language assumes that you know what you're doing. It allows you to do things that are likely to cause problems because C++ is incredibly flexible and sacrifices safety in favor of performance.

Memory allocation and management is a particularly error-prone area of C++ programming. To write high-quality C++ programs, professional C++ programmers need to understand how memory works behind the scenes. This first chapter of Part III explores the ins and outs of memory management. You will learn about the pitfalls of dynamic memory and some techniques for avoiding and eliminating them.

This chapter discusses low-level memory handling because professional C++ programmers will encounter such code. However, in modern C++ you should avoid low-level memory operations as much as possible. For example, instead of dynamically allocated C-style arrays, you should use Standard Library containers, such as `vector`, which handle all memory management automatically for you. Instead of raw pointers, you should use smart pointers, such as `unique_ptr` and `shared_ptr`, which automatically free the underlying resource, such as memory, when it's not needed anymore. Basically, you should try to avoid having calls to memory allocation routines such as `new/new[]` and `delete/delete[]` in your code. Of course, it might not always be possible, and in existing code it will most likely not be the case, so as a professional C++ programmer, you will still need to know how memory works behind the scenes.

WARNING *In modern C++ you should avoid low-level memory operations as much as possible in favor of modern constructs such as containers and smart pointers!*

WORKING WITH DYNAMIC MEMORY

Memory is a low-level component of the computer that sometimes unfortunately rears its head even in a high-level programming language like C++. Many programmers understand only enough about dynamic memory to get by. They shy away from data structures that use dynamic memory, or get their programs to work by trial and error. A solid understanding of how dynamic memory really works in C++ is essential to becoming a professional C++ programmer.

How to Picture Memory

Understanding dynamic memory is much easier if you have a mental model for what objects look like in memory. In this book, a unit of memory is shown as a box with a label next to it. The label indicates a variable name that corresponds to the memory. The data inside the box displays the current value of the memory.

For example, Figure 7-1 shows the state of memory after the following line is executed. The line should be in a function, so that `i` is a local variable:

```
int i = 7;
```

`i` is a so-called *automatic variable* allocated on the stack. It is automatically deallocated when the program flow leaves the scope in which the variable is declared.



FIGURE 7-1

When you use the `new` keyword, memory is allocated on the heap. The following code creates a variable `ptr` on the stack initialized with `nullptr`, and then allocates memory on the heap to which `ptr` points:

```
int* ptr = nullptr;
ptr = new int;
```

This can also be written as a one-liner:

```
int* ptr = new int;
```

Figure 7-2 shows the state of memory after this code is executed. Notice that the variable `ptr` is still on the stack even though it points to memory on the heap. A pointer is just a variable and can live on either the stack or the heap, although this fact is easy to forget. Dynamic memory, however, is always allocated on the heap.



FIGURE 7-2

WARNING *As a rule of thumb, every time you declare a pointer variable, you should immediately initialize it with either a proper pointer or `nullptr`. Don't leave it uninitialized!*

The next example shows that pointers can exist both on the stack and on the heap:

```
int** handle = nullptr;
handle = new int*;
*handle = new int;
```

The preceding code first declares a pointer to a pointer to an integer as the variable `handle`. It then dynamically allocates enough memory to hold a pointer to an integer, storing the pointer to that new memory in `handle`. Next, that memory (`*handle`) is assigned a pointer to another section of dynamic memory that is big enough to hold the integer. Figure 7-3 shows the two levels of pointers with one pointer residing on the stack (`handle`) and the other residing on the heap (`*handle`).

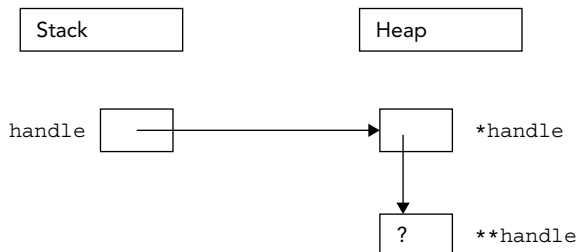

FIGURE 7-3

Allocation and Deallocation

To create space for a variable, you use the `new` keyword. To release that space for use by other parts of the program, you use the `delete` keyword. Of course, it wouldn't be C++ if simple concepts such as `new` and `delete` didn't have several variations and intricacies.

Using `new` and `delete`

When you want to allocate a block of memory, you call `new` with the type of variable for which you need space. `new` returns a pointer to that memory, although it is up to you to store that pointer in a variable. If you ignore the return value of `new`, or if the pointer variable goes out of scope, the memory becomes *orphaned* because you no longer have a way to access it. This is also called a *memory leak*.

For example, the following code orphans enough memory to hold an `int`. Figure 7-4 shows the state of memory after the code is executed. When there are blocks of data on the heap with no access, direct or indirect, from the stack, the memory is orphaned or leaked.

```
void leaky()
{
    new int;    // BUG! Orphans/leaks memory!
    cout << "I just leaked an int!" << endl;
}
```

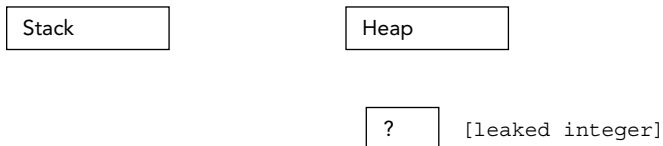

FIGURE 7-4

Until they find a way to make computers with an infinite supply of fast memory, you will need to tell the compiler when the memory associated with an object can be released and reused for another purpose. To free memory on the heap, you use the `delete` keyword with a pointer to the memory, as shown here:

```
int* ptr = new int;
delete ptr;
ptr = nullptr;
```

WARNING *As a rule of thumb, every line of code that allocates memory with `new`, and that uses a raw pointer instead of storing the pointer in a smart pointer, should correspond to another line of code that releases the same memory with `delete`.*

NOTE *It is recommended to set a pointer back to `nullptr` after having freed its memory. That way, you do not accidentally use a pointer to memory that has already been deallocated.*

What about My Good Friend `malloc`?

If you are a C programmer, you may be wondering what is wrong with the `malloc()` function. In C, `malloc()` is used to allocate a given number of bytes of memory. For the most part, using `malloc()` is simple and straightforward. The `malloc()` function still exists in C++, but you should avoid it. The main advantage of `new` over `malloc()` is that `new` doesn't just allocate memory, it constructs objects!

For example, consider the following two lines of code, which use a hypothetical class called `Foo`:

```
Foo* myFoo = (Foo*)malloc(sizeof(Foo));  
Foo* myOtherFoo = new Foo();
```

After executing these lines, both `myFoo` and `myOtherFoo` will point to areas of memory on the heap that are big enough for a `Foo` object. Data members and methods of `Foo` can be accessed using both pointers. The difference is that the `Foo` object pointed to by `myFoo` isn't a proper object because it was never constructed. The `malloc()` function only sets aside a piece of memory of a certain size. It doesn't know about or care about objects. In contrast, the call to `new` allocates the appropriate size of memory and also calls an appropriate constructor to construct the object.

A similar difference exists between the `free()` function and the `delete` operator. With `free()`, the object's destructor is not called. With `delete`, the destructor is called and the object is properly cleaned up.

WARNING *You should never use `malloc()` and `free()` in C++. Use only `new` and `delete`.*

When Memory Allocation Fails

Many, if not most, programmers write code with the assumption that `new` will always be successful. The rationale is that if `new` fails, it means that memory is very low and life is very, very bad. It is often an unfathomable state to be in because it's unclear what your program could possibly do in this situation.

By default, your program will terminate if `new` fails. In many programs, this behavior is acceptable. The program exits when `new` fails because `new` throws an exception if there is not enough memory available for the request. Chapter 14 explains possible approaches to recover gracefully from an out-of-memory situation.

There is also an alternative version of `new`, which will not throw an exception. Instead, it will return `nullptr`, similar to the behavior of `malloc()` in C. The syntax for using this version is as follows:

```
int* ptr = new(nothrow) int;
```

Of course, you still have the same problem as the version that throws an exception—what do you do when the result is `nullptr`? The compiler doesn't require you to check the result, so the `nothrow` version of `new` is more likely to lead to other bugs than the version that throws an exception. For this reason, it's suggested that you use the standard version of `new`. If out-of-memory recovery is important to your program, the techniques covered in Chapter 14 give you all the tools you need.

Arrays

Arrays package multiple variables of the same type into a single variable with indices. Working with arrays quickly becomes natural to a novice programmer because it is easy to think about values in numbered slots. The in-memory representation of an array is not far off from this mental model.

Arrays of Basic Types

When your program allocates memory for an array, it is allocating *contiguous* pieces of memory, where each piece is large enough to hold a single element of the array. For example, a local array of five `ints` can be declared on the stack as follows:

```
int myArray[5];
```

Figure 7-5 shows the state of memory after the array is created. When creating arrays on the stack, the size must be a constant value known at compile time.

NOTE *Some compilers allow variable-sized arrays on the stack. This is not a standard feature of C++, so I recommend cautiously backing away when you see it.*

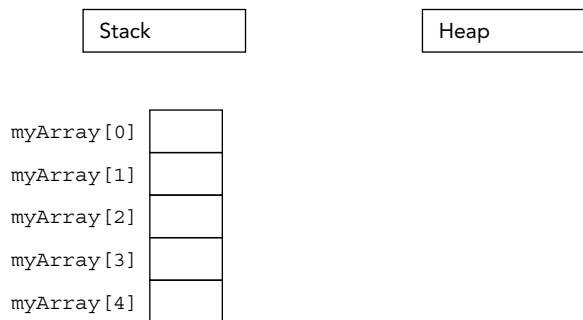

FIGURE 7-5

Declaring arrays on the heap is no different, except that you use a pointer to refer to the location of the array. The following code allocates memory for an array of five `ints` and stores a pointer to the memory in a variable called `myArrayPtr`:

```
int* myArrayPtr = new int[5];
```

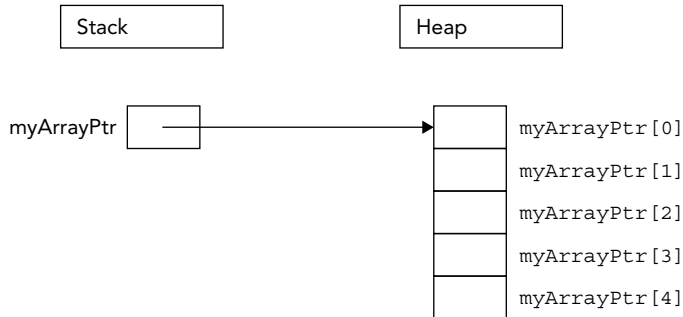

FIGURE 7-6

As Figure 7-6 illustrates, the heap-based array is similar to the stack-based array, but in a different location. The `myArrayPtr` variable points to the 0th element of the array.

Each call to `new[]` should be paired with a call to `delete[]` to clean up the memory. For example,

```
delete [] myArrayPtr;
myArrayPtr = nullptr;
```

The advantage of putting an array on the heap is that you can define its size at run time. For example, the following code snippet receives a desired number of documents from a hypothetical function named `askUserForNumberOfDocuments()` and uses that result to create an array of `Document` objects.

```
Document* createDocArray()
{
    size_t numDocs = askUserForNumberOfDocuments();
    Document* docArray = new Document[numDocs];
    return docArray;
}
```

Remember that each call to `new[]` should be paired with a call to `delete[]`, so in this example, it's important that the caller of `createDocArray()` uses `delete[]` to clean up the returned memory. Another problem is that C-style arrays don't know their size; thus callers of `createDocArray()` have no idea how many elements there are in the returned array!

In the preceding function, `docArray` is a dynamically allocated array. Do not get this confused with a *dynamic array*. The array itself is not dynamic because its size does not change once it is allocated. Dynamic memory lets you specify the size of an allocated block at run time, but it does not automatically adjust its size to accommodate the data.

NOTE *There are data structures, such as Standard Library containers, that do dynamically adjust their size and that do know their actual size. You should use these containers instead of C-style arrays because they are much safer to use.*

There is a function in C++ called `realloc()`, which is a holdover from the C language. Do not use it! In C, `realloc()` is used to effectively change the size of an array by allocating a new block of memory of the new size, copying all of the old data to the new location, and deleting the original block. This approach is extremely dangerous in C++ because user-defined objects will not respond well to bitwise copying.

WARNING *Do not use `realloc()` in C++. It is not your friend.*

Arrays of Objects

Arrays of objects are no different than arrays of simple types. When you use `new[N]` to allocate an array of N objects, enough space is allocated for N contiguous blocks where each block is large enough for a single object. Using `new[]`, the zero-argument (= default) constructor for each of the objects is automatically called. In this way, allocating an array of objects using `new[]` returns a pointer to an array of fully formed and initialized objects.

For example, consider the following class:

```
class Simple
{
public:
    Simple() { cout << "Simple constructor called!" << endl; }
    ~Simple() { cout << "Simple destructor called!" << endl; }
};
```

If you allocate an array of four `Simple` objects, the `Simple` constructor is called four times.

```
Simple* mySimpleArray = new Simple[4];
```

The memory diagram for this array is shown in Figure 7-7. As you can see, it is no different than an array of basic types.

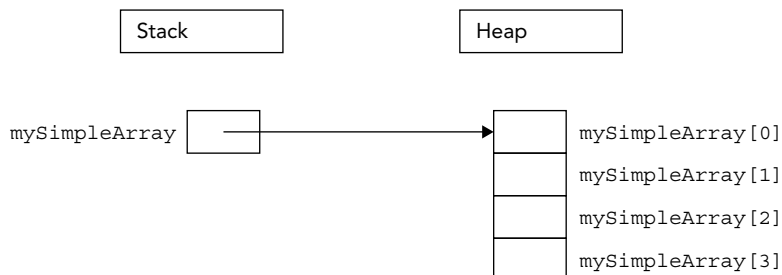

FIGURE 7-7

Deleting Arrays

As mentioned earlier, when you allocate memory with the array version of `new` (`new []`), you must release it with the array version of `delete` (`delete []`). This version automatically destructs the objects in the array in addition to releasing the memory associated with them.

```
Simple* mySimpleArray = new Simple[4];
// Use mySimpleArray ...
delete [] mySimpleArray;
mySimpleArray = nullptr;
```

If you do not use the array version of `delete`, your program may behave in odd ways. With some compilers, only the destructor for the first element of the array will be called because the compiler only knows that you are deleting a pointer to an object, and all the other elements of the array will become orphaned objects. With other compilers, memory corruption may occur because `new` and `new []` can use completely different memory allocation schemes.

WARNING *Always use `delete` on anything allocated with `new`, and always use `delete []` on anything allocated with `new []`.*

Of course, the destructors are only called if the elements of the array are objects. If you have an array of pointers, you still need to delete each object pointed to individually just as you allocated each object individually, as shown in the following code:

```
const size_t size = 4;
Simple** mySimplePtrArray = new Simple*[size];

// Allocate an object for each pointer.
for (size_t i = 0; i < size; i++) { mySimplePtrArray[i] = new Simple(); }

// Use mySimplePtrArray ...

// Delete each allocated object.
for (size_t i = 0; i < size; i++) { delete mySimplePtrArray[i]; }

// Delete the array itself.
delete [] mySimplePtrArray;
mySimplePtrArray = nullptr;
```

WARNING *In modern C++ you should avoid using raw C-style pointers. Instead of storing plain-old dumb pointers in C-style arrays, you should store smart pointers in modern Standard Library containers. Such smart pointers are discussed later in this chapter, and will automatically deallocate the memory associated with them at the right time.*

Multi-dimensional Arrays

Multi-dimensional arrays extend the notion of indexed values to multiple indices. For example, a Tic-Tac-Toe game might use a two-dimensional array to represent a three-by-three grid. The following example shows such an array declared on the stack, zero-initialized, and accessed with some test code:

```
char board[3][3] = {};
// Test code
board[0][0] = 'X'; // X puts marker in position (0,0).
board[2][1] = 'O'; // O puts marker in position (2,1).
```

You may be wondering whether the first subscript in a two-dimensional array is the x-coordinate or the y-coordinate. The truth is that it doesn't really matter, as long as you are consistent. A four-by-seven grid could be declared as `char board[4][7]` or `char board[7][4]`. For most applications, it is easiest to think of the first subscript as the x-axis and the second as the y-axis.

Multi-dimensional Stack Arrays

In memory, a stack-based two-dimensional array looks like Figure 7-8. Because memory doesn't have two axes (addresses are merely sequential), the computer represents a two-dimensional array just like a one-dimensional array. The difference is in the size of the array and the method used to access it.

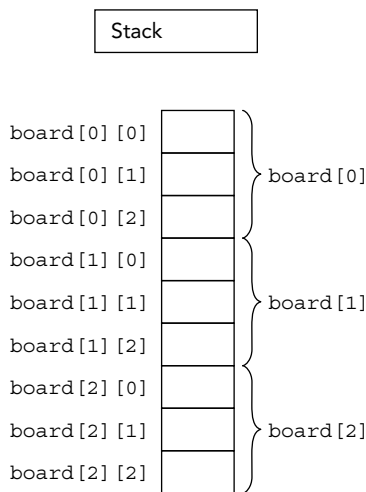

FIGURE 7-8

The size of a multi-dimensional array is all of its dimensions multiplied together, then multiplied by the size of a single element in the array. In Figure 7-8, the three-by-three board is $3 \times 3 \times 1 = 9$ bytes, assuming that a character is 1 byte. For a four-by-seven board of characters, the array would be $4 \times 7 \times 1 = 28$ bytes.

To access a value in a multi-dimensional array, the computer treats each subscript as if it were accessing another subarray within the multi-dimensional array. For example, in the three-by-three grid, the expression `board[0]` actually refers to the subarray highlighted in Figure 7-9. When you add a second subscript, such as `board[0][2]`, the computer is able to access the correct element by looking up the second subscript within the subarray, as shown in Figure 7-10.

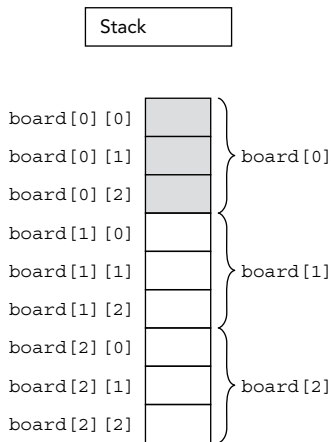

FIGURE 7-9

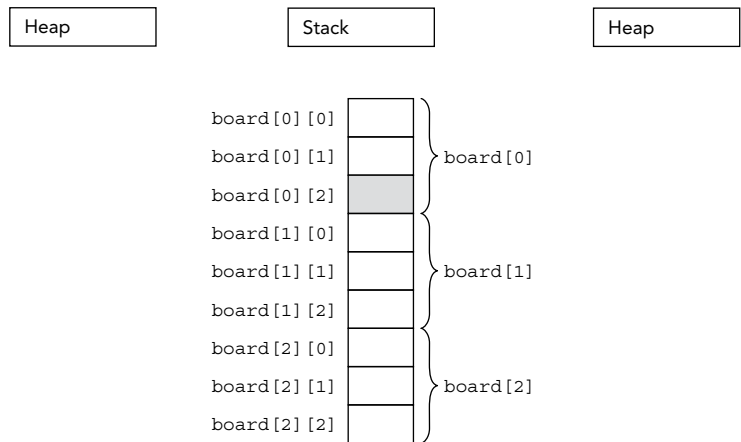

FIGURE 7-10

These techniques are extended to N -dimensional arrays, though dimensions higher than three tend to be difficult to conceptualize and are rarely used.

Multi-dimensional Heap Arrays

If you need to determine the dimensions of a multi-dimensional array at run time, you can use a heap-based array. Just as a single-dimensional dynamically allocated array is accessed through a pointer, a multi-dimensional dynamically allocated array is also accessed through a pointer. The only difference is that in a two-dimensional array, you need to start with a pointer-to-a-pointer; and in an N -dimensional array, you need N levels of pointers. At first, it might seem as if the correct way to declare and allocate a dynamically allocated multi-dimensional array is as follows:

```
char** board = new char[i][j]; // BUG! Doesn't compile
```

This code doesn't compile because heap-based arrays don't work like stack-based arrays. Their memory layout isn't contiguous, so allocating enough memory for a stack-based multi-dimensional array is incorrect. Instead, you can start by allocating a single contiguous array for the first subscript dimension of a heap-based array. Each element of that array is actually a pointer to another array that stores the elements for the second subscript dimension. This layout for a two-by-two dynamically allocated board is shown in Figure 7-11.

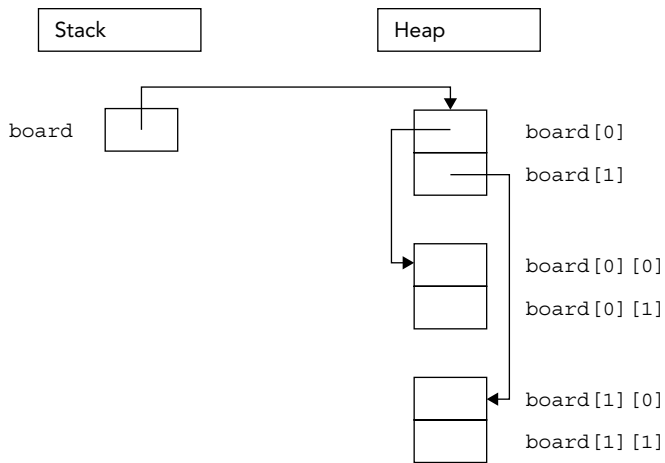

FIGURE 7-11

Unfortunately, the compiler doesn't allocate memory for the subarrays on your behalf. You can allocate the first-dimension array just like a single-dimensional heap-based array, but the individual subarrays must be explicitly allocated. The following function properly allocates memory for a two-dimensional array:

```
char** allocateCharacterBoard(size_t xDimension, size_t yDimension)
{
    char** myArray = new char*[xDimension]; // Allocate first dimension
    for (size_t i = 0; i < xDimension; i++) {
        myArray[i] = new char[yDimension]; // Allocate ith subarray
    }
    return myArray;
}
```

Similarly, when you want to release the memory associated with a multi-dimensional heap-based array, the array `delete []` syntax will not clean up the subarrays on your behalf. Your code to release an array should mirror the code to allocate it, as in the following function:

```
void releaseCharacterBoard(char** myArray, size_t xDimension)
{
    for (size_t i = 0; i < xDimension; i++) {
        delete [] myArray[i]; // Delete ith subarray
    }
    delete [] myArray; // Delete first dimension
}
```

Now that you know all the details to work with arrays, it is recommended to avoid these old C-style arrays as much as possible because they do not provide any memory safety. They are explained here because you will encounter them in legacy code. In new code, you should use the C++ Standard Library containers such as `std::array`, `std::vector`, and so on (see Chapter 17). For example, use `vector<T>` for a one-dimensional dynamic array, use `vector<vector<T>>` for a two-dimensional dynamic array, and so on. Of course, working directly with data structures such as `vector<vector<T>>` is still tedious, especially for constructing them. If you do need N-dimensional

dynamic arrays in your application, it is recommended to write helper classes that provide an easier to use interface. For example, to work with two-dimensional data with equally long rows, you should consider writing (or reusing of course) a `Matrix<T>` or `Table<T>` class template which internally might use a `vector<vector<T>>` data structure. See Chapter 12 for details on writing class templates

WARNING Use C++ Standard Library containers such as `std::array`, `std::vector`, and so on, instead of C-style arrays!

Working with Pointers

Pointers get their bad reputation from the relative ease with which you can abuse them. Because a pointer is just a memory address, you could theoretically change that address manually, even doing something as scary as the following line of code:

```
char* scaryPointer = (char*)7;
```

This line builds a pointer to the memory address 7, which is likely to be random garbage or memory used elsewhere in the application. If you start to use areas of memory that weren't set aside on your behalf, for example with `new` or on the stack, eventually you will corrupt the memory associated with an object, or the memory involved with the management of the heap, and your program will malfunction. Such a malfunction can manifest itself in several ways. For example, it can reveal itself as invalid results because the data has been corrupted, or as hardware exceptions being triggered due to accessing non-existent memory, or attempting to write to protected memory. If you are lucky, you will get one of the serious errors that usually result in program termination by the operating system or the C++ runtime library; if you are unlucky, you will just get wrong results.

A Mental Model for Pointers

There are two ways to think about pointers. More mathematically minded readers might view pointers as addresses. This view makes pointer arithmetic, covered later in this chapter, a bit easier to understand. Pointers aren't mysterious pathways through memory; they are numbers that happen to correspond to a location in memory. Figure 7-12 illustrates a two-by-two grid in the address-based view of the world.

NOTE The addresses in Figure 7-12 are just for illustrative purposes. Addresses on a real system are highly dependent on your hardware and operating system.

Readers who are more comfortable with spatial representations might derive more benefit from the “arrow” view of pointers. A pointer is a level of indirection that says to the program, “Hey! Look over there.” With this view, multiple levels of pointers become individual steps on the path to the data. Figure 7-11 shows a graphical view of pointers in memory.

When you *dereference* a pointer, by using the `*` operator, you are telling the program to look one level deeper in memory. In the address-based view, think of a dereference as a jump in memory to

the address indicated by the pointer. With the graphical view, every dereference corresponds to following an arrow from its base to its head.

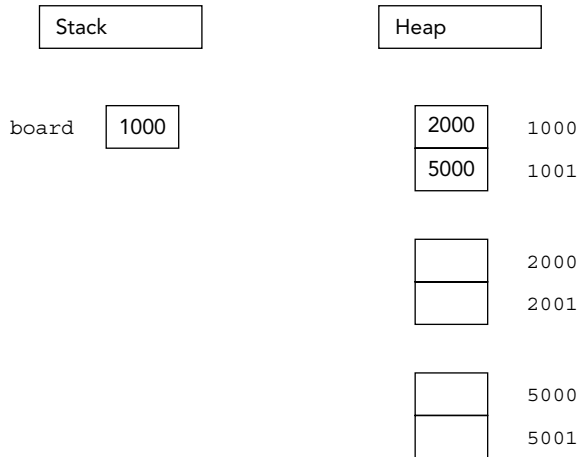

FIGURE 7-12

When you take the address of a location, using the `&` operator, you are adding a level of indirection in memory. In the address-based view, the program is noting the numerical address of the location, which can be stored as a pointer. In the graphical view, the `&` operator creates a new arrow whose head ends at the location designated by the expression. The base of the arrow can be stored as a pointer.

Casting with Pointers

Because pointers are just memory addresses (or arrows to somewhere), they are somewhat weakly typed. A pointer to an XML document is the same size as a pointer to an integer. The compiler will let you easily cast any pointer type to any other pointer type using a *C-style cast*:

```
Document* documentPtr = getDocument();
char* myCharPtr = (char*)documentPtr;
```

A *static cast* offers a bit more safety. The compiler refuses to perform a static cast on pointers to unrelated data types:

```
Document* documentPtr = getDocument();
char* myCharPtr = static_cast<char*>(documentPtr); // BUG! Won't compile
```

If the two pointers you are casting are actually pointing to objects that are related through inheritance, the compiler will permit a static cast. However, a *dynamic cast* is a safer way to accomplish a cast within an inheritance hierarchy. Chapter 10 discusses inheritance in detail, while the different C++ style casts are discussed in Chapter 11.

ARRAY-POINTER DUALITY

You have already seen some of the overlap between pointers and arrays. Heap-allocated arrays are referred to by a pointer to their first element. Stack-based arrays are referred to by using the array syntax (`[]`) with an otherwise normal variable declaration. As you are about to learn, however, the overlap doesn't end there. Pointers and arrays have a complicated relationship.

Arrays Are Pointers!

A heap-based array is not the only place where you can use a pointer to refer to an array. You can also use the pointer syntax to access elements of a stack-based array. The address of an array is really the address of the first element (index 0). The compiler knows that when you refer to an array in its entirety by its variable name, you are really referring to the address of the first element. In this way, the pointer works just like a heap-based array. The following code creates a zero-initialized array on the stack, and uses a pointer to access it:

```
int myIntArray[10] = {};  
int* myIntPtr = myIntArray;  
// Access the array through the pointer.  
myIntPtr[4] = 5;
```

The ability to refer to a stack-based array through a pointer is useful when passing arrays into functions. The following function accepts an array of integers as a pointer. Note that the caller needs to explicitly pass in the size of the array because the pointer implies nothing about size. In fact, C++ arrays of any form, pointer or not, have no built-in notion of size. That is another reason why you should use modern containers such as those provided by the Standard Library.

```
void doubleInts(int* theArray, size_t size)  
{  
    for (size_t i = 0; i < size; i++) {  
        theArray[i] *= 2;  
    }  
}
```

The caller of this function can pass a stack-based or heap-based array. In the case of a heap-based array, the pointer already exists and is passed by value into the function. In the case of a stack-based array, the caller can pass the array variable, and the compiler automatically treats the array variable as a pointer to the array, or you can explicitly pass the address of the first element. All three forms are shown here:

```
size_t arrSize = 4;  
int* heapArray = new int[arrSize]{ 1, 5, 3, 4 };  
doubleInts(heapArray, arrSize);  
delete [] heapArray;  
heapArray = nullptr;
```

```

int stackArray[] = { 5, 7, 9, 11 };
arrSize = std::size(stackArray); // Since C++17, requires <array>
//arrSize = sizeof(stackArray) / sizeof(stackArray[0]); // Pre-C++17, see Ch1
doubleInts(stackArray, arrSize);
doubleInts(&stackArray[0], arrSize);

```

The parameter-passing semantics of arrays is uncannily similar to that of pointers, because the compiler treats an array as a pointer when it is passed to a function. A function that takes an array as an argument and changes values inside the array is actually changing the original array, not a copy. Just like a pointer, passing an array effectively mimics pass-by-reference functionality because what you really pass to the function is the address of the original array, not a copy. The following implementation of `doubleInts()` changes the original array even though the parameter is an array, not a pointer:

```

void doubleInts(int theArray[], size_t size)
{
    for (size_t i = 0; i < size; i++) {
        theArray[i] *= 2;
    }
}

```

Any number between the square brackets after `theArray` in the function prototype is simply ignored. The following three versions are identical:

```

void doubleInts(int* theArray, size_t size);
void doubleInts(int theArray[], size_t size);
void doubleInts(int theArray[2], size_t size);

```

You may be wondering why things work this way. Why doesn't the compiler just copy the array when array syntax is used in the function definition? This is done for efficiency—it takes time to copy the elements of an array, and they potentially take up a lot of memory. By always passing a pointer, the compiler doesn't need to include the code to copy the array.

There is a way to pass known-length stack-based arrays “by reference” to a function, although the syntax is non-obvious. This does not work for heap-based arrays. For example, the following `doubleIntsStack()` accepts only stack-based arrays of size 4:

```

void doubleIntsStack(int (&theArray)[4]);

```

A function template, discussed in detail in Chapter 12, can be used to let the compiler deduce the size of the stack-based array automatically:

```

template<size_t N>
void doubleIntsStack(int (&theArray)[N])
{
    for (size_t i = 0; i < N; i++) {
        theArray[i] *= 2;
    }
}

```

To summarize, arrays declared using array syntax can be accessed through a pointer. When an array is passed to a function, it is always passed as a pointer.

Not All Pointers Are Arrays!

Because the compiler lets you pass in an array where a pointer is expected, as in the `doubleInts()` function in the previous section, you may be led to believe that pointers and arrays are the same. In fact, there are subtle, but important, differences. Pointers and arrays share many properties and can sometimes be used interchangeably (as shown earlier), but they are not the same.

A pointer by itself is meaningless. It may point to random memory, a single object, or an array. You can always use array syntax with a pointer, but doing so is not always appropriate because pointers aren't always arrays. For example, consider the following code:

```
int* ptr = new int;
```

The pointer `ptr` is a valid pointer, but it is not an array. You can access the pointed-to value using array syntax (`ptr[0]`), but doing so is stylistically questionable and provides no real benefit. In fact, using array syntax with non-array pointers is an invitation for bugs. The memory at `ptr[1]` could be anything!

WARNING *Arrays are automatically referenced as pointers, but not all pointers are arrays.*

LOW-LEVEL MEMORY OPERATIONS

One of the great advantages of C++ over C is that you don't need to worry quite as much about memory. If you code using objects, you just need to make sure that each individual class properly manages its own memory. Through construction and destruction, the compiler helps you manage memory by telling you when to do it. Hiding the management of memory within classes makes a huge difference in usability, as demonstrated by the Standard Library classes. However, with some applications or with legacy code, you may encounter the need to work with memory at a lower level. Whether for legacy, efficiency, debugging, or curiosity, knowing some techniques for working with raw bytes can be helpful.

Pointer Arithmetic

The C++ compiler uses the declared types of pointers to allow you to perform *pointer arithmetic*. If you declare a pointer to an `int` and increase it by 1, the pointer moves ahead in memory by the size of an `int`, not by a single byte. This type of operation is most useful with arrays, because they contain homogeneous data that is sequential in memory. For example, assume you declare an array of `ints` on the heap:

```
int* myArray = new int[8];
```

You are already familiar with the following syntax for setting the value in position 2:

```
myArray[2] = 33;
```

With pointer arithmetic, you can equivalently use the following syntax, which obtains a pointer to the memory that is “2 ints ahead” of `myArray` and then dereferences it to set the value:

```
*(myArray + 2) = 33;
```

As an alternative syntax for accessing individual elements, pointer arithmetic doesn’t seem too appealing. Its real power lies in the fact that an expression like `myArray + 2` is still a pointer to an `int`, and thus can represent a smaller `int` array. Suppose you have the following wide string. Wide strings are discussed in Chapter 19, but the details are not important at this point. For now, it is enough to know that wide strings support so-called Unicode characters to represent, for example, Japanese strings. The `wchar_t` type is a character type that can accommodate such Unicode characters, and it is usually bigger than a `char` (1 byte). To tell the compiler that a string literal is a wide-string literal, you prefix it with an `L`:

```
const wchar_t* myString = L"Hello, World";
```

Suppose you also have a function that takes in a wide string and returns a new string that contains a capitalized version of the input:

```
wchar_t* toCaps(const wchar_t* inString);
```

You can capitalize `myString` by passing it into this function. However, if you only want to capitalize *part* of `myString`, you can use pointer arithmetic to refer to only a latter part of the string. The following code calls `toCaps()` on the `World` part of the wide string by just adding 7 to the pointer, even though `wchar_t` is usually more than 1 byte:

```
toCaps(myString + 7);
```

Another useful application of pointer arithmetic involves subtraction. Subtracting one pointer from another of the same type gives you the number of elements of the pointed-to type between the two pointers, not the absolute number of bytes between them.

Custom Memory Management

For 99 percent of the cases you will encounter (some might say 100 percent of the cases), the built-in memory allocation facilities in C++ are adequate. Behind the scenes, `new` and `delete` do all the work of handing out memory in properly sized chunks, maintaining a list of available areas of memory, and releasing chunks of memory back to that list upon deletion.

When resource constraints are extremely tight, or under very special conditions, such as managing shared memory, implementing custom memory management may be a viable option. Don’t worry—it’s not as scary as it sounds. Basically, managing memory yourself means that classes allocate a large chunk of memory and dole out that memory in pieces as it is needed.

How is this approach any better? Managing your own memory can potentially reduce overhead. When you use `new` to allocate memory, the program also needs to set aside a small amount of space to record how much memory was allocated. That way, when you call `delete`, the proper amount of memory can be released. For most objects, the overhead is so much smaller than the memory allocated that it makes little difference. However, for small objects or programs with enormous numbers of objects, the overhead can have an impact.

When you manage memory yourself, you might know the size of each object a priori, so you might be able to avoid the overhead for each object. The difference can be enormous for large numbers of small objects. The syntax for performing custom memory management is described in Chapter 15.

Garbage Collection

At the other end of the memory hygiene spectrum lies *garbage collection*. With environments that support garbage collection, the programmer rarely, if ever, explicitly frees memory associated with an object. Instead, objects to which there are no longer any references will be cleaned up automatically at some point by the runtime library.

Garbage collection is not built into the C++ language as it is in C# and Java. In modern C++, you use smart pointers to manage memory, while in legacy code you will see memory management at the object level through `new` and `delete`. Smart pointers such as `shared_ptr` (discussed later in this chapter) provide something very similar to garbage-collected memory, that is, when the last `shared_ptr` instance for a certain resource is destroyed, at that point in time the resource is destroyed as well. It is possible but not easy to implement true garbage collection in C++, but freeing yourself from the task of releasing memory would probably introduce new headaches.

One approach to garbage collection is called *mark and sweep*. With this approach, the garbage collector periodically examines every single pointer in your program and annotates the fact that the referenced memory is still in use. At the end of the cycle, any memory that hasn't been marked is deemed to be not in-use and is freed.

A mark-and-sweep algorithm could be implemented in C++ if you were willing to do the following:

1. Register all pointers with the garbage collector so that it can easily walk through the list of all pointers.
2. Derive all objects from a mixin class, perhaps `GarbageCollectible`, that allows the garbage collector to mark an object as in-use.
3. Protect concurrent access to objects by making sure that no changes to pointers can occur while the garbage collector is running.

As you can see, this approach to garbage collection requires quite a bit of diligence on the part of the programmer. It may even be more error-prone than using `delete`! Attempts at a safe and easy mechanism for garbage collection have been made in C++, but even if a perfect implementation of garbage collection in C++ came along, it wouldn't necessarily be appropriate to use for all applications. Among the downsides of garbage collection are the following:

- When the garbage collector is actively running, the program might become unresponsive.
- With garbage collectors, you have so-called non-deterministic destructors. Because an object is not destroyed until it is garbage-collected, the destructor is not executed immediately when the object leaves its scope. This means that cleaning up resources (such as closing a file, releasing a lock, and so on), which is done by the destructor, is not performed until some indeterminate time in the future.

Writing a garbage collection mechanism is very hard. You will undoubtedly do it wrong, it will be error prone, and more than likely slow. So, if you do want to use garbage-collected memory in your application, I highly recommend you to research existing specialized garbage-collection libraries that you can reuse. See Chapter 4 for a discussion on code reuse.

Object Pools

Garbage collection is like buying plates for a picnic and leaving any used plates out in the yard where the wind will conveniently blow them into the neighbor's yard. Surely, there must be a more ecological approach to memory management.

Object pools are the equivalent of recycling. You buy a reasonable number of plates, and after using a plate, you clean it so that it can be reused later. Object pools are ideal for situations where you need to use many objects of the same type over time, and creating each one incurs overhead.

Chapter 25 contains further details on using object pools for performance efficiency.

SMART POINTERS

Memory management in C++ is a perennial source of errors and bugs. Many of these bugs arise from the use of dynamic memory allocation and pointers. When you extensively use dynamic memory allocation in your program and pass many pointers between objects, it's difficult to remember to call `delete` on each pointer exactly once and at the right time. The consequences of getting it wrong are severe: when you free dynamically allocated memory more than once, you can cause memory corruption or a fatal run-time error, and when you forget to free dynamically allocated memory, you cause memory leaks.

Smart pointers help you manage your dynamically allocated memory and are the recommended technique for avoiding memory leaks. Conceptually, a smart pointer can hold a dynamically allocated resource, such as memory. When a smart pointer goes out of scope or is reset, it can automatically free the resource it holds. Smart pointers can be used to manage dynamically allocated resources in the scope of a function, or as data members in classes. They can also be used to pass ownership of dynamically allocated resources through function arguments.

C++ provides several language features that make smart pointers attractive. First, you can write a type-safe smart pointer class for any pointer type using templates, see Chapter 12. Second, you can provide an interface to the smart pointer objects using operator overloading, see Chapter 15, that allows code to use the smart pointer objects as if they were dumb pointers. Specifically, you can overload the `*` and `->` operators such that client code can dereference a smart pointer object the same way it dereferences a normal pointer.

There are several kinds of smart pointers. The simplest type of smart pointer takes sole/unique ownership of the resource, and when the smart pointer goes out of scope or is reset, it frees the referenced resource. The Standard Library provides `std::unique_ptr` which is a smart pointer with *unique ownership* semantics.

However, managing pointers presents more problems than just remembering to free them when they go out of scope. Sometimes several objects or pieces of code contain copies of the same pointer. This problem is called *aliasing*. In order to free all resources properly, the last piece of code to use the resource should free the resource pointed to by the pointer. However, it is sometimes difficult to know which piece of code uses the resource last. It may even be impossible to determine the order when you code because it might depend on run-time inputs. Thus, a more sophisticated type of smart pointer implements *reference counting* to keep track of its owners. Every time such a reference-counted smart pointer is copied, a new instance is created pointing to the same resource, and the reference count is incremented. When such a smart pointer instance goes out of scope or is reset, the reference count is decremented. When the reference count drops to zero, there are no owners of the resource anymore, so the smart pointer frees the resource. The Standard Library provides `std::shared_ptr` which is a smart pointer with *shared ownership* semantics using reference counting. The standard `shared_ptr` is thread-safe, but this does not mean that the pointed-to resource is thread-safe! See Chapter 23 for a discussion on multithreading.

Both standard smart pointers, `unique_ptr` and `shared_ptr`, are discussed in detail in the next sections. Both require you to include the `<memory>` header file.

NOTE *Your default smart pointer should be `unique_ptr`. Only use `shared_ptr` when you really need to share the resource.*

WARNING *Never assign the result of a resource allocation to a dumb pointer. Whatever resource allocation method you use, always immediately store the resource pointer in a smart pointer, either `unique_ptr` or `shared_ptr`, or use other RAII classes. RAII stands for Resource Acquisition Is Initialization. An RAII class takes ownership of a certain resource and handles its deallocation at the right time. It's a design technique discussed in Chapter 28.*

unique_ptr

As a rule of thumb, always store dynamically allocated resources in instances of `unique_ptr`.

Creating unique_ptrs

Consider the following function that blatantly leaks memory by allocating a `Simple` object on the heap and neglecting to release it:

```
void leaky()
{
    Simple* mySimplePtr = new Simple(); // BUG! Memory is never released!
    mySimplePtr->go();
}
```

Sometimes you might think that your code is properly deallocating dynamically allocated memory. Unfortunately, it most likely is *not correct* in all situations. Take the following function:

```
void couldBeLeaky()
{
    Simple* mySimplePtr = new Simple();
    mySimplePtr->go();
    delete mySimplePtr;
}
```

This function dynamically allocates a `Simple` object, uses the object, and then properly calls `delete`. However, you can still have memory leaks in this example! If the `go()` method throws an exception, the call to `delete` is never executed, causing a memory leak.

In both cases you should use a `unique_ptr`. The object is not explicitly deleted; but when the `unique_ptr` instance goes out of scope (at the end of the function, or because an exception is thrown), it automatically deallocates the `Simple` object in its destructor:

```
void notLeaky()
{
    auto mySimpleSmartPtr = make_unique<Simple>();
    mySimpleSmartPtr->go();
}
```

This code uses `make_unique()` from C++14, in combination with the `auto` keyword, so that you only have to specify the type of the pointer, `Simple` in this case, once. If the `Simple` constructor requires parameters, you put them in between the parentheses of the `make_unique()` call.

If your compiler does not yet support `make_unique()`, you can create your `unique_ptr` as follows. Note that `Simple` must be mentioned twice:

```
unique_ptr<Simple> mySimpleSmartPtr(new Simple());
```

Before C++17, you had to use `make_unique()` not only because you have to specify the type only once, but also because of safety reasons! Consider the following call to a function called `foo()`:

```
foo(unique_ptr<Simple>(new Simple()), unique_ptr<Bar>(new Bar(data())));
```

If the constructor of `Simple` or `Bar`, or the `data()` function, throws an exception, depending on your compiler optimizations, it was very possible that either a `Simple` or a `Bar` object would be leaked. With `make_unique()`, nothing would leak:

```
foo(make_unique<Simple>(), make_unique<Bar>(data()))
```

With C++17, both calls to `foo()` are safe, but I still recommend using `make_unique()` as it results in code that is easier to read.

NOTE *Always use `make_unique()` to create a `unique_ptr`.*

Using `unique_ptr`

One of the greatest characteristics of the standard smart pointers is that they provide enormous benefit without requiring the user to learn a lot of new syntax. Smart pointers can still be dereferenced (using `*` or `->`) just like standard pointers. For example, in the earlier example, the `->` operator is used to call the `go()` method:

```
mySimpleSmartPtr->go();
```

Just as with standard pointers, you can also write this as follows:

```
(*mySimpleSmartPtr).go();
```

The `get()` method can be used to get direct access to the underlying pointer. This can be useful to pass the pointer to a function that requires a dumb pointer. For example, suppose you have the following function:

```
void processData(Simple* simple) { /* Use the simple pointer... */ }
```

Then you can call it as follows:

```
auto mySimpleSmartPtr = make_unique<Simple>();
processData(mySimpleSmartPtr.get());
```

You can free the underlying pointer of a `unique_ptr` and optionally change it to another pointer using `reset()`. For example:

```
mySimpleSmartPtr.reset(); // Free resource and set to nullptr
mySimpleSmartPtr.reset(new Simple()); // Free resource and set to a new
// Simple instance
```

You can disconnect the underlying pointer from a `unique_ptr` with `release()`. The `release()` method returns the underlying pointer to the resource and then sets the smart pointer to `nullptr`. Effectively, the smart pointer loses ownership of the resource, and as such, you become responsible for freeing the resource when you are done with it. For example:

```
Simple* simple = mySimpleSmartPtr.release(); // Release ownership
// Use the simple pointer...
delete simple;
simple = nullptr;
```

Because a `unique_ptr` represents unique ownership, it cannot be *copied*! Using the `std::move()` utility (discussed in Chapter 9), it is possible to *move* one `unique_ptr` to another one using move semantics. This is used to explicitly move ownership, as in this example:

```
class Foo
{
public:
    Foo(unique_ptr<int> data) : mData(move(data)) { }
private:
    unique_ptr<int> mData;
};

auto myIntSmartPtr = make_unique<int>(42);
Foo f(move(myIntSmartPtr));
```

unique_ptr and C-Style Arrays

A `unique_ptr` is suitable to store a dynamically allocated old C-style array. The following example creates a `unique_ptr` that holds a dynamically allocated C-style array of ten integers:

```
auto myVariableSizedArray = make_unique<int[]>(10);
```

Even though it is possible to use a `unique_ptr` to store a dynamically allocated C-style array, it's recommended to use a Standard Library container instead, such as `std::array` or `std::vector`.

Custom Deleters

By default, `unique_ptr` uses the standard `new` and `delete` operators to allocate and deallocate memory. You can change this behavior as follows:

```
int* malloc_int(int value)
{
    int* p = (int*)malloc(sizeof(int));
    *p = value;
    return p;
}

int main()
{
    unique_ptr<int, decltype(free)*> myIntSmartPtr(malloc_int(42), free);
    return 0;
}
```

This code allocates memory for an integer with `malloc_int()`. The `unique_ptr` deallocates the memory by calling the standard `free()` function. As said before, in C++ you should never use `malloc()`, but `new` instead. However, this feature of `unique_ptr` is available because it is useful to manage other resources instead of just memory. For example, it can be used to automatically close a file or network socket or anything when the `unique_ptr` goes out of scope.

Unfortunately, the syntax for a custom deleter with `unique_ptr` is a bit clumsy. You need to specify the type of your custom deleter as a template type parameter. In this example, `decltype(free)` is used which returns the type of `free()`. The template type parameter should be the type of a pointer to a function, so an additional `*` is appended, as in `decltype(free)*`. Using a custom deleter with `shared_ptr` is much easier. The following section on `shared_ptr` demonstrates how to use a `shared_ptr` to automatically close a file when it goes out of scope.

shared_ptr

You use `shared_ptr` in a similar way to `unique_ptr`. To create one, you use `make_shared()`, which is more efficient than creating a `shared_ptr` directly. Here's an example:

```
auto mySimpleSmartPtr = make_shared<Simple>();
```

WARNING *Always use `make_shared()` to create a `shared_ptr`.*

Starting with C++17, a `shared_ptr` can also be used to store a pointer to a dynamically allocated old C-style array, just as you can do with a `unique_ptr`. This was not possible before C++17. However, even though it is now possible in C++17, it is still recommended to use Standard Library containers instead of C-style arrays.

A `shared_ptr` also supports the `get()` and `reset()` methods, just as a `unique_ptr`. The only difference is that when calling `reset()`, due to reference counting, the underlying resource is only freed when the last `shared_ptr` is destroyed or reset. Note that `shared_ptr` does not support `release()`. You can use `use_count()` to retrieve the number of `shared_ptr` instances that are sharing the same resource.

Just like `unique_ptr`, `shared_ptr` by default uses the standard `new` and `delete` operators to allocate and deallocate memory, or `new[]` and `delete[]` when storing a C-style array with C++17. You can change this behavior as follows:

```
// Implementation of malloc_int() as before.
shared_ptr<int> myIntSmartPtr(malloc_int(42), free);
```

As you can see, you don't have to specify the type of the custom deleter as a template type parameter, so this makes it much easier than a custom deleter with `unique_ptr`.

The following example uses a `shared_ptr` to store a file pointer. When the `shared_ptr` is reset (in this case when it goes out of scope), the file pointer is automatically closed with a call to `CloseFile()`. Note that C++ has proper object-oriented classes to work with files (see Chapter 13). Those classes already automatically close their files. This example using the old C functions `fopen()` and `fclose()` is just to give a demonstration of what `shared_ptr`s can be used for besides pure memory:

```
void CloseFile(FILE* filePtr)
{
    if (filePtr == nullptr)
        return;
    fclose(filePtr);
    cout << "File closed." << endl;
}
int main()
{
    FILE* f = fopen("data.txt", "w");
    shared_ptr<FILE> filePtr(f, CloseFile);
    if (filePtr == nullptr) {
        cerr << "Error opening file." << endl;
    } else {
        cout << "File opened." << endl;
        // Use filePtr
    }
    return 0;
}
```

Casting a `shared_ptr`

The functions that are available to cast `shared_ptr`s are `const_pointer_cast()`, `dynamic_pointer_cast()`, and `static_pointer_cast()`. C++17 adds `reinterpret_pointer_cast()` to

this list. These behave and work similar to the non-smart pointer casting functions `const_cast()`, `dynamic_cast()`, `static_cast()`, and `reinterpret_cast()`, which are discussed in detail in Chapter 11.

The Need for Reference Counting

As a general concept, *reference counting* is a technique for keeping track of the number of instances of a class or particular object in use. A reference-counting smart pointer is one that keeps track of how many smart pointers have been built to refer to a single real pointer, or single object. This way, smart pointers can avoid double deletion.

The double deletion problem is easy to provoke. Consider again the `Simple` class introduced earlier in this chapter, which simply prints out messages when an object is created and destroyed. If you were to create two standard `shared_ptrs` and have them both refer to the same `Simple` object, as in the following code, both smart pointers would attempt to delete the same object when they are destroyed:

```
void doubleDelete()
{
    Simple* mySimple = new Simple();
    shared_ptr<Simple> smartPtr1(mySimple);
    shared_ptr<Simple> smartPtr2(mySimple);
}
```

Depending on your compiler, this piece of code might crash! If you do get output, it could be as follows:

```
Simple constructor called!
Simple destructor called!
Simple destructor called!
```

Yikes! One call to the constructor and two calls to the destructor? You get the same problem with `unique_ptr`. You might be surprised that even the reference-counted `shared_ptr` class behaves this way. However, this is correct behavior according to the C++ standard. You should not use `shared_ptr` as in the previous `doubleDelete()` function to create two `shared_ptrs` pointing to the same object. Instead, you should make a *copy* as follows:

```
void noDoubleDelete()
{
    auto smartPtr1 = make_shared<Simple>();
    shared_ptr<Simple> smartPtr2(smartPtr1);
}
```

Here is the output of this code:

```
Simple constructor called!
Simple destructor called!
```

Even though there are two `shared_ptrs` pointing to the same `Simple` object, the `Simple` object is destroyed only once. Remember that `unique_ptr` is not reference counted. In fact, `unique_ptr` does not allow you to use its copy constructor as in the `noDoubleDelete()` function.

If you really need to be able to write code as shown in the previous `doubleDelete()` function example, you will need to implement your own smart pointer to prevent double deletion. But again, it is recommended to use the standard `shared_ptr` template for sharing a resource. Simply avoid code like that in the `doubleDelete()` function, and use the copy constructor instead.

Aliasing

A `shared_ptr` support so-called *aliasing*. This allows a `shared_ptr` to share ownership over a pointer (*owned pointer*) with another `shared_ptr`, but pointing to a different object (*stored pointer*). It can, for example, be used to have a `shared_ptr` pointing to a member of an object while owning the object itself. Here's an example:

```
class Foo
{
public:
    Foo(int value) : mData(value) { }
    int mData;
};

auto foo = make_shared<Foo>(42);
auto aliasing = shared_ptr<int>(foo, &foo->mData);
```

The `Foo` object is only destroyed when both `shared_ptr`s (`foo` and `aliasing`) are destroyed.

The owned pointer is used for reference counting, while the stored pointer is returned when you dereference the pointer or when you call `get()` on it. The stored pointer is used with most operations, such as the comparison operators. You can use the `owner_before()` method, or the `std::owner_less` class to perform comparisons based on the owned pointer instead. This can be useful in certain situations, such as storing `shared_ptr`s in an `std::set`. Chapter 17 discusses the `set` container in detail.

weak_ptr

There is one more class in C++ that is related to `shared_ptr`, called `weak_ptr`. A `weak_ptr` can contain a reference to a resource managed by a `shared_ptr`. The `weak_ptr` does not own the resource, so the `shared_ptr` is not prevented from deallocating the resource. A `weak_ptr` does not destroy the pointed-to resource when the `weak_ptr` is destroyed (for example when it goes out of scope); however, it can be used to determine if the resource has been freed by the associated `shared_ptr` or not. The constructor of a `weak_ptr` requires a `shared_ptr` or another `weak_ptr` as argument. To get access to the pointer stored in a `weak_ptr`, you need to convert it to a `shared_ptr`. There are two ways to do this:

- Use the `lock()` method on a `weak_ptr` instance, which returns a `shared_ptr`. The returned `shared_ptr` is `nullptr` if the `shared_ptr` associated with the `weak_ptr` has been deallocated in the meantime.
- Create a new `shared_ptr` instance and give a `weak_ptr` as argument to the `shared_ptr` constructor. This throws an `std::bad_weak_ptr` exception if the `shared_ptr` associated with the `weak_ptr` has been deallocated.

The following example demonstrates the use of `weak_ptr`:

```
void useResource(weak_ptr<Simple>& weakSimple)
{
    auto resource = weakSimple.lock();
    if (resource) {
        cout << "Resource still alive." << endl;
    } else {
        cout << "Resource has been freed!" << endl;
    }
}

int main()
{
    auto sharedSimple = make_shared<Simple>();
    weak_ptr<Simple> weakSimple(sharedSimple);

    // Try to use the weak_ptr.
    useResource(weakSimple);

    // Reset the shared_ptr.
    // Since there is only 1 shared_ptr to the Simple resource, this will
    // free the resource, even though there is still a weak_ptr alive.
    sharedSimple.reset();

    // Try to use the weak_ptr a second time.
    useResource(weakSimple);

    return 0;
}
```

The output of this code is as follows:

```
Simple constructor called!
Resource still alive.
Simple destructor called!
Resource has been freed!
```

Starting with C++17, `weak_ptr` also supports C-style arrays, just as `shared_ptr` supports C-style arrays since C++17.

Move Semantics

The standard smart pointers, `shared_ptr`, `unique_ptr`, and `weak_ptr` all support move semantics to make them efficient. Move semantics is discussed in detail in Chapter 9; however, the details are not important at this time. What is important is that this means it is very efficient to return such a smart pointer from a function. For example, you can write the following `create()` function and use it as demonstrated in `main()`:

```
unique_ptr<Simple> create()
{
    auto ptr = make_unique<Simple>();
    // Do something with ptr...
    return ptr;
}
```

```
int main()
{
    unique_ptr<Simple> mySmartPtr1 = create();
    auto mySmartPtr2 = create();
    return 0;
}
```

enable_shared_from_this

The `std::enable_shared_from_this` mixin class allows a method on an object to safely return a `shared_ptr` or `weak_ptr` to itself. Mixin classes are discussed in Chapter 28. Basically, the `enable_shared_from_this` mixin class adds the following two methods to a class:

- `shared_from_this()`: returns a `shared_ptr` that shares ownership of the object.
- `weak_from_this()`: returns a `weak_ptr` that tracks ownership of the object.

C++17

This is an advanced feature not discussed in detail, but the following code briefly demonstrates its use:

```
class Foo : public enable_shared_from_this<Foo>
{
public:
    shared_ptr<Foo> getPointer() {
        return shared_from_this();
    }
};

int main()
{
    auto ptr1 = make_shared<Foo>();
    auto ptr2 = ptr1->getPointer();
}
```

Note that you can only use `shared_from_this()` on an object if its pointer has already been stored in a `shared_ptr`. In the example, `make_shared()` is used in `main()` to create a `shared_ptr` called `ptr1` which contains an instance of `Foo`. After this `shared_ptr` creation, it is allowed to call `shared_from_this()` on that `Foo` instance.

The following would be a completely wrong implementation of the `getPointer()` method:

```
class Foo
{
public:
    shared_ptr<Foo> getPointer() {
        return shared_ptr<Foo>(this);
    }
};
```

If you use the same code for `main()` as shown earlier, this implementation of `Foo` causes a double deletion. You have two completely independent `shared_ptr`s (`ptr1` and `ptr2`) pointing to the same object, which will both try to delete the object when they go out of scope.

The Old Deprecated/Removed `auto_ptr`

The old, pre-C++11 Standard Library included a basic implementation of a smart pointer, called `auto_ptr`. Unfortunately, `auto_ptr` has some serious shortcomings. One of these shortcomings is that it does not work correctly when used inside Standard Library containers such as vectors. C++11 and C++14 officially deprecated `auto_ptr`, and C++17 finally removed it entirely. It has been replaced with `unique_ptr` and `shared_ptr`. `auto_ptr` is mentioned here to make sure you know about it and to make sure you never use it.

WARNING *Do not use the old `auto_ptr` smart pointer anymore. Instead, use `unique_ptr` or `shared_ptr`!*

COMMON MEMORY PITFALLS

It is difficult to pinpoint the exact situations that can lead to a memory-related bug. Every memory leak or bad pointer has its own nuances. There is no magic bullet for resolving memory issues, but there are several common categories of problems and some tools you can use to detect and resolve them.

Underallocating Strings

The most common problem with C-style strings is *underallocation*. In most cases, this arises when the programmer fails to allocate an extra character for the trailing `'\0'` sentinel. Underallocation of strings also occurs when programmers assume a certain fixed maximum size. The basic built-in C-style string functions do not adhere to a fixed size—they will happily write off the end of the string into uncharted memory.

The following code demonstrates underallocation. It reads data off a network connection and puts it in a C-style string. This is done in a loop because the network connection receives only a small amount of data at a time. On each loop, `getMoreData()` is called, which returns a pointer to dynamically allocated memory. When `nullptr` is returned from `getMoreData()`, all of the data has been received. `strcat()` is a C function that concatenates the C-style string given as a second argument to the end of the C-style string given as a first argument. It expects the destination buffer to be big enough.

```
char buffer[1024] = {0}; // Allocate a whole bunch of memory.
while (true) {
    char* nextChunk = getMoreData();
    if (nextChunk == nullptr) {
        break;
    } else {
        strcat(buffer, nextChunk); // BUG! No guarantees against buffer overrun!
        delete [] nextChunk;
    }
}
```

There are three ways to resolve the possible underallocation problem. In decreasing order of preference, they are as follows:

1. Use C++-style strings, which handle the memory associated with concatenation on your behalf.
2. Instead of allocating a buffer as a global variable or on the stack, allocate it on the heap. When there is insufficient space left, allocate a new buffer large enough to hold at least the current contents plus the new chunk, copy the original buffer into the new buffer, append the new contents, and delete the original buffer.
3. Create a version of `getMoreData()` that takes a maximum count (including the `'\0'` character) and returns no more characters than that; then track the amount of space left and the current position in the buffer.

Accessing Out-of-Bounds Memory

Earlier in this chapter, you read that because a pointer is just a memory address, it is possible to have a pointer that points to a random location in memory. Such a condition is quite easy to fall into. For example, consider a C-style string that has somehow lost its `'\0'` termination character. The following function, which fills the string with all `'m'` characters, continues to fill the contents of memory after the string with `'m'`'s:

```
void fillWithM(char* inStr)
{
    int i = 0;
    while (inStr[i] != '\0') {
        inStr[i] = 'm';
        i++;
    }
}
```

If an improperly terminated string is handed to this function, it is only a matter of time before an essential part of memory is overwritten and the program crashes. Consider what might happen if the memory associated with the objects in your program is suddenly overwritten with `'m'`'s. It's not pretty!

Bugs that result in writing to memory past the end of an array are often called *buffer overflow errors*. These bugs have been exploited by several high-profile malware programs such as viruses and worms. A devious hacker can take advantage of the ability to overwrite portions of memory to inject code into a running program.

Many memory-checking tools detect buffer overflows. Also, using higher-level constructs like C++ strings and vectors helps prevent numerous bugs associated with writing to C-style strings and arrays.

WARNING *Avoid using old C-style strings and arrays that offer no protection whatsoever. Instead, use modern and safe constructs like C++ strings and vectors that manage all their memory for you.*

Memory Leaks

Finding and fixing memory leaks can be one of the more frustrating parts of programming in C or C++. Your program finally works and appears to give the correct results. Then, you start to notice that your program gobbles up more and more memory as it runs. Your program has a memory leak. The use of smart pointers to avoid memory leaks is a good first approach to solving the problem.

Memory leaks occur when you allocate memory and neglect to release it. At first, this sounds like the result of careless programming that could easily be avoided. After all, if every new has a corresponding `delete` in every class you write, there should be no memory leaks, right? Actually, that's not always true. In the following code, the `Simple` class is properly written to release any memory that it allocates.

When `doSomething()` is called, the `outSimplePtr` pointer is changed to another `Simple` object without deleting the old one to demonstrate a memory leak. Once you lose a pointer to an object, it's nearly impossible to delete it.

```
class Simple
{
public:
    Simple() { mIntPtr = new int(); }
    ~Simple() { delete mIntPtr; }
    void setValue(int value) { *mIntPtr = value; }
private:
    int* mIntPtr;
};

void doSomething(Simple*& outSimplePtr)
{
    outSimplePtr = new Simple(); // BUG! Doesn't delete the original.
}

int main()
{
    Simple* simplePtr = new Simple(); // Allocate a Simple object.
    doSomething(simplePtr);
    delete simplePtr; // Only cleans up the second object.
    return 0;
}
```

WARNING *Keep in mind that this code is only for demonstration purposes! In production-quality code, you should make `mIntPtr` and `simplePtr` unique_ptrs, and make `outSimplePtr` a reference to a unique_ptr.*

In cases like the preceding example, the memory leak probably arose from poor communication between programmers or poor documentation of code. The caller of `doSomething()` may not have realized that the variable was passed by reference and thus had no reason to expect that the pointer would be reassigned. If they did notice that the parameter was a non-const reference to a pointer,

they may have suspected that something strange was happening, but there is no comment around `doSomething()` that explains this behavior.

Finding and Fixing Memory Leaks in Windows with Visual C++

Memory leaks are hard to track down because you can't easily look at memory and see what objects are not in use and where they were originally allocated. However, there are programs that can do this for you. Memory leak detection tools range from expensive professional software packages to free downloadable tools. If you work with Microsoft Visual C++*, its debug library has built-in support for memory leak detection. This memory leak detection is not enabled by default, unless you create an MFC project. To enable it in other projects, you need to start by including the following three lines at the beginning of your code:

```
#define _CRTDBG_MAP_ALLOC
#include <cstdlib>
#include <crtDBG.h>
```

These lines should be in the exact order as shown. Next, you need to redefine the `new` operator as follows:

```
#ifdef _DEBUG
    #ifndef DBG_NEW
        #define DBG_NEW new ( _NORMAL_BLOCK , __FILE__ , __LINE__ )
        #define new DBG_NEW
    #endif
#endif // _DEBUG
```

Note that this is within an `"#ifdef _DEBUG"` statement so the redefinition of `new` is done only when compiling a debug version of your application. This is what you normally want. Release builds usually do not do any memory leak detection.

The last thing you need to do is to add the following line as the first line in your `main()` function:

```
_CrtSetDbgFlag(_CRTDBG_ALLOC_MEM_DF | _CRTDBG_LEAK_CHECK_DF);
```

This tells the Visual C++ CRT (C RunTime) library to write all detected memory leaks to the debug output console when the application exits. For the previous leaky program, the debug console will contain lines similar to the following:

```
Detected memory leaks!
Dumping objects ->
c:\leaky\leaky.cpp(15) : {147} normal block at 0x014FABF8, 4 bytes long.
Data: < > 00 00 00 00
c:\leaky\leaky.cpp(33) : {146} normal block at 0x014F5048, 4 bytes long.
Data: <Pa > 50 61 20 01
Object dump complete.
```

The output clearly shows in which file and on which line memory was allocated but never deallocated. The line number is between parentheses immediately behind the filename. The number between the curly braces is a counter for the memory allocations. For example, {147} means the 147th allocation in your program since it started. You can use the VC++ `_CrtSetBreakAlloc()` function to tell the VC++ debug runtime to break into the debugger when a certain allocation is

*There is a free version of Microsoft Visual C++ available, called the Community Edition.

performed. For example, you can add the following line to the beginning of your `main()` function to instruct the debugger to break on the 147th allocation:

```
_CrtSetBreakAlloc(147);
```

In this leaky program, there are two leaks: the first `Simple` object that is never deleted (line 33) and the heap-based integer that it creates (line 15). In the Visual C++ debugger output window, you can simply double-click on one of the memory leaks and it will automatically jump to that line in your code.

Of course, programs like Microsoft Visual C++ (discussed in this section) and Valgrind (discussed in the next section) can't actually fix the leak for you—what fun would that be? These tools provide information that you can use to find the actual problem. Normally, that involves stepping through the code to find out where the pointer to an object was overwritten without the original object being released. Most debuggers provide “watch point” functionality that can break execution of the program when this occurs.

Finding and Fixing Memory Leaks in Linux with Valgrind

Valgrind is an example of a free open-source tool for Linux that, among other things, pinpoints the exact line in your code where a leaked object was allocated.

The following output, generated by running Valgrind on the previous leaky program, pinpoints the exact locations where memory was allocated but never released. Valgrind finds the same two memory leaks—the first `Simple` object never deleted and the heap-based integer that it creates:

```
==15606== ERROR SUMMARY: 0 errors from 0 contexts (suppressed: 0 from 0)
==15606== malloc/free: in use at exit: 8 bytes in 2 blocks.
==15606== malloc/free: 4 allocs, 2 frees, 16 bytes allocated.
==15606== For counts of detected errors, rerun with: -v
==15606== searching for pointers to 2 not-freed blocks.
==15606== checked 4455600 bytes.
==15606==
==15606== 4 bytes in 1 blocks are still reachable in loss record 1 of 2
==15606==   at 0x4002978F: __builtin_new (vg_replace_malloc.c:172)
==15606==   by 0x400297E6: operator new(unsigned) (vg_replace_malloc.c:185)
==15606==   by 0x804875B: Simple::Simple() (leaky.cpp:4)
==15606==   by 0x8048648: main (leaky.cpp:24)
==15606==
==15606== 4 bytes in 1 blocks are definitely lost in loss record 2 of 2
==15606==   at 0x4002978F: __builtin_new (vg_replace_malloc.c:172)
==15606==   by 0x400297E6: operator new(unsigned) (vg_replace_malloc.c:185)
==15606==   by 0x8048633: main (leaky.cpp:20)
==15606==   by 0x4031FA46: __libc_start_main (in /lib/libc-2.3.2.so)
==15606==
==15606== LEAK SUMMARY:
==15606==   definitely lost: 4 bytes in 1 blocks.
==15606==   possibly lost:  0 bytes in 0 blocks.
==15606==   still reachable: 4 bytes in 1 blocks.
==15606==   suppressed:  0 bytes in 0 blocks.
```

WARNING *It is strongly recommended to use smart pointers as often as possible to avoid memory leaks.*

Double-Deleting and Invalid Pointers

Once you release memory associated with a pointer using `delete`, the memory is available for use by other parts of your program. Nothing stops you, however, from attempting to continue to use the pointer, which is now a *dangling pointer*. Double deletion is also a problem. If you use `delete` a second time on a pointer, the program could be releasing memory that has since been assigned to another object.

Double deletion and use of already released memory are both difficult problems to track down because the symptoms may not show up immediately. If two deletions occur within a relatively short amount of time, the program potentially could work indefinitely because the associated memory might not be reused that quickly. Similarly, if a deleted object is used immediately after being deleted, most likely it will still be intact.

Of course, there is no guarantee that such behavior will work or continue to work. The memory allocator is under no obligation to preserve any object once it has been deleted. Even if it does work, it is extremely poor programming style to use objects that have been deleted.

Many memory leak-detection programs, such as Microsoft Visual C++ and Valgrind, are capable of detecting double deletion and use of released objects.

If you disregard the recommendation for using smart pointers and instead still use dumb pointers, at least set your pointers to `nullptr` after deallocating their memory. This prevents you from accidentally deleting the same pointer twice or using an invalid pointer. It's worth noting that you are allowed to call `delete` on a `nullptr` pointer; it simply will not do anything.

SUMMARY

In this chapter, you learned the ins and outs of dynamic memory. Aside from memory-checking tools and careful coding, there are two key takeaways to avoid dynamic memory-related problems. First, you need to understand how pointers work under the hood. After reading about two different mental models for pointers, you should now know how the compiler doles out memory. Second, you can avoid all sorts of dynamic memory issues by using objects which automatically manage such memory, like the C++ `string` class, the `vector` container, smart pointers, and so on.

If there is one takeaway from this chapter, it is that you should try to avoid using old C-style constructs and functions as much as possible, and use the safe C++ alternatives.

8

Gaining Proficiency with Classes and Objects

WHAT'S IN THIS CHAPTER?

- ▶ How to write your own classes with methods and data members
- ▶ How to control access to your methods and data members
- ▶ How to use objects on the stack and on the heap
- ▶ What the life cycle of an object is
- ▶ How to write code that is executed when an object is created
- ▶ How to write code to copy or assign objects

WROX.COM DOWNLOADS FOR THIS CHAPTER

Please note that all the code examples for this chapter are available as a part of this chapter's code download on the book's website at www.wrox.com/go/proc++4e on the Download Code tab.

As an object-oriented language, C++ provides facilities for using objects and for writing object definitions, called classes. You can certainly write programs in C++ without classes and objects, but by doing so, you do not take advantage of the most fundamental and useful aspect of the language; writing a C++ program without classes is like traveling to Paris and eating at McDonald's. In order to use classes and objects effectively, you must understand their syntax and capabilities.

Chapter 1 reviewed the basic syntax of class definitions. Chapter 5 introduced the object-oriented approach to programming in C++ and presented specific design strategies for classes

and objects. This chapter describes the fundamental concepts involved in using classes and objects, including writing class definitions, defining methods, using objects on the stack and the heap, writing constructors, default constructors, compiler-generated constructors, constructor initializers (known as *ctor-initializers*), copy constructors, initializer-list constructors, destructors, and assignment operators. Even if you are already comfortable with classes and objects, you should skim this chapter because it contains various tidbits of information with which you might not yet be familiar.

INTRODUCING THE SPREADSHEET EXAMPLE

Both this chapter and the next present a runnable example of a simple spreadsheet application. A spreadsheet is a two-dimensional grid of “cells,” and each cell contains a number or a string. Professional spreadsheets such as Microsoft Excel provide the ability to perform mathematical operations, such as calculating the sum of the values of a set of cells. The spreadsheet example in these chapters does not attempt to challenge Microsoft in the marketplace, but is useful for illustrating the issues of classes and objects.

The spreadsheet application uses two basic classes: `Spreadsheet` and `SpreadsheetCell`. Each `Spreadsheet` object contains `SpreadsheetCell` objects. In addition, a `SpreadsheetApplication` class manages a collection of `Spreadsheets`. This chapter focuses on the `SpreadsheetCell`. Chapter 9 develops the `Spreadsheet` and `SpreadsheetApplication` classes.

NOTE *This chapter shows several different versions of the `SpreadsheetCell` class in order to introduce concepts gradually. Thus, the various attempts at the class throughout the chapter do not always illustrate the “best” way to do every aspect of class writing. In particular, the early examples omit important features that would normally be included, but have not yet been introduced. You can download the final version of the class as described in the beginning of this chapter.*

WRITING CLASSES

When you write a class, you specify the behaviors, or *methods*, that will apply to objects of that class and the properties, or *data members*, that each object will contain.

There are two components in the process of writing classes: defining the classes themselves and defining their methods.

Class Definitions

Here is a first attempt at a simple `SpreadsheetCell` class, in which each cell can store only a single number:

```
class SpreadsheetCell
{
    public:
```

```

        void setValue(double inValue);
        double getValue() const;
    private:
        double mValue;
};

```

As described in Chapter 1, every class definition begins with the keyword `class` and the name of the class. A class definition is a *statement* in C++, so it must end with a semicolon. If you fail to terminate your class definition with a semicolon, your compiler will probably give you several errors, most of which will appear to be completely unrelated.

Class definitions usually go in a file named after the class. For example, the `SpreadsheetCell` class definition can be put in a file called `SpreadsheetCell.h`. This rule is not enforced and you are free to name your file whatever you like.

Class Members

A class can have a number of *members*. A member can be a *member function* (which in turn is a *method*, *constructor*, or *destructor*), a *member variable*, also called a *data member*, member enumerations, type aliases, nested classes, and so on.

The two lines that look like function prototypes declare the methods that this class supports:

```

void setValue(double inValue);
double getValue() const;

```

Chapter 1 points out that it is always a good idea to declare member functions that do not change the object as `const`.

The line that looks like a variable declaration declares the data member for this class.

```

double mValue;

```

A class defines the member functions and data members that apply. They apply only to a specific *instance* of the class, which is an *object*. The only exceptions to this rule are static members, which are explained in Chapter 9. Classes define concepts; objects contain real bits. So, each object contains its own value for the `mValue` variable. The implementation of the member functions is shared across all objects. Classes can contain any number of member functions and data members. You cannot give a data member the same name as a member function.

Access Control

Every member in a class is subject to one of three *access specifiers*: `public`, `protected`, or `private`. An access specifier applies to all member declarations that follow it, until the next access specifier. In the `SpreadsheetCell` class, the `setValue()` and `getValue()` methods have `public` access, while the `mValue` data member has `private` access.

The default access specifier for classes is `private`: all member declarations before the first access specifier have the `private` access specification. For example, moving the `public` access specifier below the `setValue()` method declaration gives the `setValue()` method `private` access instead of `public`:

```

class SpreadsheetCell
{
    void setValue(double inValue); // now has private access

```

```

    public:
        double getValue() const;
    private:
        double mValue;
};

```

In C++, a `struct` can have methods just like a `class`. In fact, the only difference is that the default access specifier for a `struct` is `public` while the default for a `class` is `private`. For example, the `SpreadsheetCell` class can be rewritten using a `struct` as follows:

```

struct SpreadsheetCell
{
    void setValue(double inValue);
    double getValue() const;
private:
    double mValue;
};

```

It's custom to use a `struct` instead of a `class` if you only need a collection of publicly accessible data members and no or very few methods. An example of such a simple `struct` is a structure to store point coordinates:

```

struct Point
{
    double x;
    double y;
};

```

The following table summarizes the meanings of the three access specifiers:

ACCESS SPECIFICATION	MEANING	WHEN TO USE
<code>public</code>	Any code can call a <code>public</code> member function or access a <code>public</code> data member of an object.	Behaviors (methods) that you want clients to use Access methods (getters and setters) for <code>private</code> and <code>protected</code> data members
<code>protected</code>	Any member function of the class can call <code>protected</code> member functions and access <code>protected</code> data members. Member functions of a derived class can access <code>protected</code> members of a base class.	"Helper" methods that you do not want clients to use
<code>private</code>	Only member functions of the class can call <code>private</code> member functions and access <code>private</code> data members. Member functions in derived classes cannot access <code>private</code> members from a base class.	Everything should be <code>private</code> by default, especially data members. You can provide <code>protected</code> getters and setters if you only want to allow derived classes to access them, and provide <code>public</code> getters and setters if you want clients to access them.

Order of Declarations

You can declare your members and access control specifiers in any order: C++ does not impose any restrictions, such as member functions before data members or `public` before `private`. Additionally, you can repeat access specifiers. For example, the `SpreadsheetCell` definition could look like this:

```
class SpreadsheetCell
{
    public:
        void setValue(double inValue);
    private:
        double mValue;
    public:
        double getValue() const;
};
```

However, for clarity it is a good idea to group `public`, `protected`, and `private` declarations, and to group member functions and data members within those declarations.

In-Class Member Initializers

Member variables can be initialized directly in the class definition. For example, the `SpreadsheetCell` class can, by default, initialize `mValue` to 0 directly in the class definition as follows:

```
class SpreadsheetCell
{
    // Remainder of the class definition omitted for brevity
    private:
        double mValue = 0;
};
```

Defining Methods

The preceding definition for the `SpreadsheetCell` class is enough for you to create objects of the class. However, if you try to call the `setValue()` or `getValue()` methods, your linker will complain that those methods are not defined. That's because the class definition specifies the prototypes for the methods, but does not define their implementations. Just as you write both a prototype and a definition for a stand-alone function, you must write a prototype and a definition for a method. Note that the class definition must precede the method definitions. Usually the class definition goes in a header file, and the method definitions go in a source file that `#includes` that header file. Here are the definitions for the two methods of the `SpreadsheetCell` class:

```
#include "SpreadsheetCell.h"

void SpreadsheetCell::setValue(double inValue)
{
    mValue = inValue;
}

double SpreadsheetCell::getValue() const
{
    return mValue;
}
```

Note that the name of the class followed by two colons precedes each method name:

```
void SpreadsheetCell::setValue(double inValue)
```

The `::` is called the *scope resolution operator*. In this context, the syntax tells the compiler that the coming definition of the `setValue()` method is part of the `SpreadsheetCell` class. Note also that you do not repeat the access specification when you define the method.

NOTE *If you are using the Microsoft Visual C++ IDE, you will notice that by default, all source files start as follows:*

```
#include "stdafx.h"
```

In a VC++ project, by default, every source file should start with this line, and your own include files must follow this. If you place your own include files before `stdafx.h`, they will appear to have no effect and you will get all kinds of compilation errors. This situation involves the concept of precompiled header files, which is outside the scope of this book. Consult the Microsoft documentation on precompiled header files to learn the details.

Accessing Data Members

Non-static methods of a class, such as `setValue()` and `getValue()`, are always executed on behalf of a specific object of that class. Inside a method body, you have access to all data members of the class for that object. In the previous definition for `setValue()`, the following line changes the `mValue` variable inside whatever object calls the method:

```
mValue = inValue;
```

If `setValue()` is called for two different objects, the same line of code (executed once for each object) changes the variable in two different objects.

Calling Other Methods

You can call methods of a class from inside another method. For example, consider an extension to the `SpreadsheetCell` class. Real spreadsheet applications allow text data as well as numbers in the cells. When you try to interpret a text cell as a number, the spreadsheet tries to convert the text to a number. If the text does not represent a valid number, the cell value is ignored. In this program, strings that are not numbers will generate a cell value of 0. Here is a first stab at a class definition for a `SpreadsheetCell` that supports text data:

```
#include <string>
#include <string_view>
class SpreadsheetCell
{
public:
    void setValue(double inValue);
    double getValue() const;

    void setString(std::string_view inString);
```

```

        std::string getString() const;
private:
        std::string doubleToString(double inValue) const;
        double stringToDouble(std::string_view inString) const;
        double mValue;
};

```

NOTE *This code uses the C++17 `std::string_view` class. If your compiler is not yet C++17 compliant, you can replace `std::string_view` with `const std::string&`.*

This version of the class stores the data only as a `double`. If the client sets the data as a string, it is converted to a `double`. If the text is not a valid number, the `double` value is set to 0.0. The class definition shows two new methods to set and retrieve the text representation of the cell, and two new private *helper methods* to convert a `double` to a string and vice versa. Here are the implementations of all the methods:

```

#include "SpreadsheetCell.h"
using namespace std;

void SpreadsheetCell::setValue(double inValue)
{
    mValue = inValue;
}

double SpreadsheetCell::getValue() const
{
    return mValue;
}

void SpreadsheetCell::setString(string_view inString)
{
    mValue = stringToDouble(inString);
}

string SpreadsheetCell::getString() const
{
    return doubleToString(mValue);
}

string SpreadsheetCell::doubleToString(double inValue) const
{
    return to_string(inValue);
}

double SpreadsheetCell::stringToDouble(string_view inString) const
{
    return strtod(inString.data(), nullptr);
}

```

Note that with this implementation of the `doubleToString()` method, a value of, for example, 6.1 is converted to “6.100000”. However, because it is a private helper method, you are free to modify the implementation without having to modify any client code.

The this Pointer

Every normal method call passes a pointer to the object for which it is called as a “hidden” parameter with the name `this`. You can use this pointer to access data members or call methods, and you can pass it to other methods or functions. It is sometimes also useful for disambiguating names. For example, you could have defined the `SpreadsheetCell` class with a `value` data member instead of `mValue` and you could have defined the `setValue()` method to take a parameter named `value` instead of `inValue`. In that case, `setValue()` would look like this:

```
void SpreadsheetCell::setValue(double value)
{
    value = value; // Ambiguous!
}
```

That line is confusing. Which `value` do you mean: the `value` that was passed as a parameter, or the `value` that is a member of the object?

NOTE *With some compilers or compiler settings, the preceding ambiguous line compiles without any warnings or errors, but it will not produce the results that you are expecting.*

In order to disambiguate the names, you can use the `this` pointer:

```
void SpreadsheetCell::setValue(double value)
{
    this->value = value;
}
```

However, if you use the naming conventions described in Chapter 3, you will never encounter this type of name collision.

You can also use the `this` pointer to call a function or method that takes a pointer to an object from within a method of that object. For example, suppose you write a `printCell()` stand-alone function (not method) like this:

```
void printCell(const SpreadsheetCell& cell)
{
    cout << cell.getString() << endl;
}
```

If you want to call `printCell()` from the `setValue()` method, you must pass `*this` as the argument to give `printCell()` a reference to the `SpreadsheetCell` on which `setValue()` operates:

```
void SpreadsheetCell::setValue(double value)
{
    this->value = value;
    printCell(*this);
}
```

NOTE *Instead of writing a `printCell()` function, it would be more convenient to overload the `<<` operator, as explained in Chapter 15. You can then use the following line to print a `SpreadsheetCell`:*

```
cout << *this << endl;
```

Using Objects

The previous class definition says that a `SpreadsheetCell` consists of one data member, four public methods, and two private methods. However, the class definition does not actually create any `SpreadsheetCells`; it just specifies their shape and behavior. In that sense, a class is similar to architectural blueprints. The blueprints specify what a house should look like, but drawing the blueprints doesn't build any houses. Houses must be constructed later based on the blueprints.

Similarly, in C++ you can construct a `SpreadsheetCell` “object” from the `SpreadsheetCell` class definition by declaring a variable of type `SpreadsheetCell`. Just as a builder can build more than one house based on a given set of blueprints, a programmer can create more than one `SpreadsheetCell` object from a `SpreadsheetCell` class. There are two ways to create and use objects: on the stack and on the heap.

Objects on the Stack

Here is some code that creates and uses `SpreadsheetCell` objects on the stack:

```
SpreadsheetCell myCell, anotherCell;
myCell.setValue(6);
anotherCell.setString("3.2");
cout << "cell 1: " << myCell.getValue() << endl;
cout << "cell 2: " << anotherCell.getValue() << endl;
```

You create objects just as you declare simple variables, except that the variable type is the class name. The `.` in lines like `myCell.setValue(6);` is called the “dot” operator; it allows you to call methods on the object. If there were any public data members in the object, you could access them with the dot operator as well. Remember that public data members are not recommended.

The output of the program is as follows:

```
cell 1: 6
cell 2: 3.2
```

Objects on the Heap

You can also dynamically allocate objects by using `new`:

```
SpreadsheetCell* myCellp = new SpreadsheetCell();
myCellp->setValue(3.7);
cout << "cell 1: " << myCellp->getValue() <<
    " " << myCellp->getString() << endl;
delete myCellp;
myCellp = nullptr;
```

When you create an object on the heap, you access its members through the “arrow” operator: `->`. The arrow combines dereferencing (`*`) and member access (`.`). You could use those two operators instead, but doing so would be stylistically awkward:

```
SpreadsheetCell* myCellp = new SpreadsheetCell();
(*myCellp).setValue(3.7);
cout << "cell 1: " << (*myCellp).getValue() <<
    " " << (*myCellp).getString() << endl;
delete myCellp;
myCellp = nullptr;
```

Just as you must free other memory that you allocate on the heap, you must free the memory for objects that you allocate on the heap by calling `delete` on the objects. To guarantee safety and to avoid memory problems, you should use smart pointers, as in the following example:

```
auto myCellp = make_unique<SpreadsheetCell>();
// Equivalent to:
// unique_ptr<SpreadsheetCell> myCellp(new SpreadsheetCell());
myCellp->setValue(3.7);
cout << "cell 1: " << myCellp->getValue() <<
    " " << myCellp->getString() << endl;
```

With smart pointers you don’t need to manually free the memory; it happens automatically.

WARNING *If you allocate an object with `new`, free it with `delete` when you are finished with it, or use smart pointers to manage the memory automatically!*

NOTE *If you don’t use smart pointers, it is always a good idea to reset a pointer to the null pointer after deleting the object to which it pointed. You are not required to do this, but it will make debugging easier in case the pointer is accidentally used after deleting the object.*

OBJECT LIFE CYCLES

The object life cycle involves three activities: *creation*, *destruction*, and *assignment*. It is important to understand how and when objects are created, destroyed, and assigned, and how you can customize these behaviors.

Object Creation

Objects are created at the point you declare them (if they’re on the stack) or when you explicitly allocate space for them with `new`, `new[]`, or a smart pointer. When an object is created, all its embedded objects are also created. Here is an example:

```
#include <string>
```

```

class MyClass
{
    private:
        std::string mName;
};

int main()
{
    MyClass obj;
    return 0;
}

```

The embedded `string` object is created at the point where the `MyClass` object is created in the `main()` function and is destructed when its containing object is destructed.

It is often helpful to give variables initial values as you declare them, as in this example:

```
int x = 0;
```

Similarly, you should give initial values to objects. You can provide this functionality by declaring and writing a special method called a *constructor*, in which you can perform initialization work for the object. Whenever an object is created, one of its constructors is executed.

NOTE *C++ programmers sometimes call a constructor a ctor.*

Writing Constructors

Syntactically, a constructor is specified by a method name that is the same as the class name. A constructor never has a return type and may or may not have parameters. A constructor that can be called without any arguments is called a *default constructor*. This can be a constructor that does not have any parameters, or a constructor for which all parameters have default values. There are certain contexts in which you may have to provide a default constructor and you will get compilation errors if you have not provided one. Default constructors are discussed later in this chapter.

Here is a first attempt at adding a constructor to the `SpreadsheetCell` class:

```

class SpreadsheetCell
{
    public:
        SpreadsheetCell(double initialValue);
        // Remainder of the class definition omitted for brevity
};

```

Just as you must provide implementations for normal methods, you must provide an implementation for the constructor:

```

SpreadsheetCell::SpreadsheetCell(double initialValue)
{
    setValue(initialValue);
}

```

The `SpreadsheetCell` constructor is a member of the `SpreadsheetCell` class, so C++ requires the normal `SpreadsheetCell::` scope resolution before the constructor name. The constructor name

itself is also `SpreadsheetCell`, so the code ends up with the funny-looking `SpreadsheetCell::SpreadsheetCell`. The implementation simply makes a call to `setValue()`.

Using Constructors

Using the constructor creates an object and initializes its values. You can use constructors with both stack-based and heap-based allocation.

Constructors on the Stack

When you allocate a `SpreadsheetCell` object on the stack, you use the constructor like this:

```
SpreadsheetCell myCell(5), anotherCell(4);
cout << "cell 1: " << myCell.getValue() << endl;
cout << "cell 2: " << anotherCell.getValue() << endl;
```

Note that you do *not* call the `SpreadsheetCell` constructor explicitly. For example, do not use something like the following:

```
SpreadsheetCell myCell.SpreadsheetCell(5); // WILL NOT COMPILE!
```

Similarly, you cannot call the constructor later. The following is also incorrect:

```
SpreadsheetCell myCell;
myCell.SpreadsheetCell(5); // WILL NOT COMPILE!
```

Constructors on the Heap

When you dynamically allocate a `SpreadsheetCell` object, you use the constructor like this:

```
auto smartCellp = make_unique<SpreadsheetCell>(4);
// ... do something with the cell, no need to delete the smart pointer

// Or with raw pointers, without smart pointers (not recommended)
SpreadsheetCell* myCellp = new SpreadsheetCell(5);
SpreadsheetCell* anotherCellp = nullptr;
anotherCellp = new SpreadsheetCell(4);
// ... do something with the cells
delete myCellp;           myCellp = nullptr;
delete anotherCellp;     anotherCellp = nullptr;
```

Note that you can declare a pointer to a `SpreadsheetCell` object without calling the constructor immediately, which is different from objects on the stack, where the constructor is called at the point of declaration.

If you declare a pointer on the stack in a function, or declare a pointer as a data member in a class, and you don't immediately initialize the pointer, then it should be initialized to `nullptr` as in the previous declaration for `anotherCellp`. If you don't assign it to `nullptr`, the pointer is undefined. Accidentally using an undefined pointer will cause unexpected and difficult-to-diagnose memory corruption. If you initialize it to `nullptr`, using that pointer will cause a memory access error in most operating environments, instead of producing unexpected results.

Remember to call `delete` on objects that you dynamically allocate with `new`, or use smart pointers!

Providing Multiple Constructors

You can provide more than one constructor in a class. All constructors have the same name (the name of the class), but different constructors must take a different number of arguments or different argument types. In C++, if you have more than one function with the same name, the compiler selects the one whose parameter types match the types at the call site. This is called *overloading* and is discussed in detail in Chapter 9.

In the `SpreadsheetCell` class, it is helpful to have two constructors: one to take an initial double value and one to take an initial string value. Here is the new class definition:

```
class SpreadsheetCell
{
public:
    SpreadsheetCell(double initialValue);
    SpreadsheetCell(std::string_view initialValue);
    // Remainder of the class definition omitted for brevity
};
```

Here is the implementation of the second constructor:

```
SpreadsheetCell::SpreadsheetCell(string_view initialValue)
{
    setString(initialValue);
}
```

And here is some code that uses the two different constructors:

```
SpreadsheetCell aThirdCell("test"); // Uses string-arg ctor
SpreadsheetCell aFourthCell(4.4); // Uses double-arg ctor
auto aFifthCellp = make_unique<SpreadsheetCell>("5.5"); // string-arg ctor
cout << "aThirdCell: " << aThirdCell.getValue() << endl;
cout << "aFourthCell: " << aFourthCell.getValue() << endl;
cout << "aFifthCellp: " << aFifthCellp->getValue() << endl;
```

When you have multiple constructors, it is tempting to try to implement one constructor in terms of another. For example, you might want to call the double constructor from the string constructor as follows:

```
SpreadsheetCell::SpreadsheetCell(string_view initialValue)
{
    SpreadsheetCell(stringToDouble(initialValue));
}
```

That seems to make sense. After all, you can call normal class methods from within other methods. The code will compile, link, and run, *but will not do what you expect*. The explicit call to the `SpreadsheetCell` constructor actually creates a new temporary unnamed object of type `SpreadsheetCell`. It does not call the constructor for the object that you are supposed to be initializing.

However, C++ supports *delegating constructors* that allow you to call other constructors from the same class from inside the ctor-initializer. This is discussed later in this chapter.

Default Constructors

A *default constructor* is a constructor that requires no arguments. It is also called a *0-argument constructor*. With a default constructor, you can give initial values to data members even though the client did not specify them.

When You Need a Default Constructor

Consider arrays of objects. The act of creating an array of objects accomplishes two tasks: it allocates contiguous memory space for all the objects and it calls the default constructor on each object. C++ fails to provide any syntax to tell the array creation code directly to call a different constructor. For example, if you do not define a default constructor for the `SpreadsheetCell` class, the following code does not compile:

```
SpreadsheetCell cells[3]; // FAILS compilation without default constructor
SpreadsheetCell* myCellp = new SpreadsheetCell[10]; // Also FAILS
```

You can circumvent this restriction for stack-based arrays by using *initializers* like these:

```
SpreadsheetCell cells[3] = {SpreadsheetCell(0), SpreadsheetCell(23),
    SpreadsheetCell(41)};
```

However, it is usually easier to ensure that your class has a default constructor if you intend to create arrays of objects of that class. If you haven't defined your own constructors, the compiler automatically creates a default constructor for you. This compiler-generated constructor is discussed in a later section.

A default constructor is also required for classes that you want to store in Standard Library containers, such as `std::vector`.

Default constructors are also useful when you want to create objects of that class inside other classes, which is shown later in this chapter in the section, "Constructor Initializers."

How to Write a Default Constructor

Here is part of the `SpreadsheetCell` class definition with a default constructor:

```
class SpreadsheetCell
{
    public:
        SpreadsheetCell();
        // Remainder of the class definition omitted for brevity
};
```

Here is a first crack at an implementation of the default constructor:

```
SpreadsheetCell::SpreadsheetCell()
{
    mValue = 0;
}
```

If you use an in-class member initializer for `mValue`, then the single statement in this default constructor can be left out:

```
SpreadsheetCell::SpreadsheetCell()
{
}
```

You use the default constructor on the stack like this:

```
SpreadsheetCell myCell;
myCell.setValue(6);
cout << "cell 1: " << myCell.getValue() << endl;
```

The preceding code creates a new `SpreadsheetCell` called `myCell`, sets its value, and prints out its value. Unlike other constructors for stack-based objects, you do not call the default constructor with function-call syntax. Based on the syntax for other constructors, you might be tempted to call the default constructor like this:

```
SpreadsheetCell myCell(); // WRONG, but will compile.
myCell.setValue(6);      // However, this line will not compile.
cout << "cell 1: " << myCell.getValue() << endl;
```

Unfortunately, the line attempting to call the default constructor compiles. The line following it does not compile. This problem is commonly known as the *most vexing parse*, and it means that your compiler thinks the first line is actually a function declaration for a function with the name `myCell` that takes zero arguments and returns a `SpreadsheetCell` object. When it gets to the second line, it thinks that you're trying to use a function name as an object!

WARNING *When creating an object on the stack, omit parentheses for the default constructor.*

For heap-based object allocation, the default constructor can be used as follows:

```
auto smartCellp = make_unique<SpreadsheetCell>();
// Or with a raw pointer (not recommended)
SpreadsheetCell* myCellp = new SpreadsheetCell();
// Or
// SpreadsheetCell* myCellp = new SpreadsheetCell;
// ... use myCellp
delete myCellp;    myCellp = nullptr;
```

Compiler-Generated Default Constructor

The first `SpreadsheetCell` class definition in this chapter looked like this:

```
class SpreadsheetCell
{
public:
    void setValue(double inValue);
    double getValue() const;
private:
    double mValue;
};
```

This definition does not declare a default constructor, but still, the code that follows works fine:

```
SpreadsheetCell myCell;
myCell.setValue(6);
```

The following definition is the same as the preceding definition except that it adds an explicit constructor, accepting a `double`. It still does not explicitly declare a default constructor.

```
class SpreadsheetCell
{
    public:
        SpreadsheetCell(double initialValue); // No default constructor
        // Remainder of the class definition omitted for brevity
};
```

With this definition, the following code does not compile anymore:

```
SpreadsheetCell myCell;
myCell.setValue(6);
```

What's going on here? The reason it is not compiling is that if you don't specify *any* constructors, the compiler writes one for you that doesn't take any arguments. This *compiler-generated default constructor* calls the default constructor on all object members of the class, but does not initialize the language primitives such as `int` and `double`. Nonetheless, it allows you to create objects of that class. However, if you declare a default constructor, or any other constructor, the compiler no longer generates a default constructor for you.

NOTE A default constructor is the same thing as a 0-argument constructor. The term default constructor does not refer only to the constructor that is automatically generated if you fail to declare any constructors. It also refers to the constructor that is defaulted to if no arguments are required.

Explicitly Defaulted Constructors

In C++03 or older, if your class required a number of explicit constructors accepting arguments but also a default constructor that did nothing, you still had to explicitly write your empty default constructor as shown earlier.

To avoid having to write empty default constructors manually, C++ supports the concept of *explicitly defaulted constructors*. This allows you to write the class definition as follows without the need to implement the default constructor in the implementation file:

```
class SpreadsheetCell
{
    public:
        SpreadsheetCell() = default;
        SpreadsheetCell(double initialValue);
        SpreadsheetCell(std::string_view initialValue);
        // Remainder of the class definition omitted for brevity
};
```

`SpreadsheetCell` defines two custom constructors. However, the compiler still generates a standard compiler-generated default constructor due to the use of the `default` keyword.

Explicitly Deleted Constructors

C++ also supports the concept of *explicitly deleted constructors*. For example, you can define a class with only static methods (see Chapter 9) for which you do not want to write any constructors and you also do not want the compiler to generate the default constructor. In that case, you need to explicitly delete the default constructor:

```
class MyClass
{
    public:
        MyClass() = delete;
};
```

Constructor Initializers

Up to now, this chapter initialized data members in the body of a constructor, as in this example:

```
SpreadsheetCell::SpreadsheetCell(double initialValue)
{
    setValue(initialValue);
}
```

C++ provides an alternative method for initializing data members in the constructor, called the *constructor initializer*, also known as the *ctor-initializer* or *member initializer list*. Here is the same `SpreadsheetCell` constructor, rewritten to use the ctor-initializer syntax:

```
SpreadsheetCell::SpreadsheetCell(double initialValue)
    : mValue(initialValue)
{
}
```

As you can see, the ctor-initializer appears syntactically between the constructor argument list and the opening brace for the body of the constructor. The list starts with a colon and is separated by commas. Each element in the list is an initialization of a data member using function notation or the uniform initialization syntax, a call to a base class constructor (see Chapter 10), or a call to a delegated constructor, which is discussed later.

Initializing data members with a ctor-initializer provides different behavior than does initializing data members inside the constructor body itself. When C++ creates an object, it must create all the data members of the object before calling the constructor. As part of creating these data members, it must call a constructor on any of them that are themselves objects. By the time you assign a value to an object inside your constructor body, you are not actually constructing that object. You are only modifying its value. A ctor-initializer allows you to provide initial values for data members as they are created, which is more efficient than assigning values to them later.

If your class has as data member an object of a class that has a default constructor, then you do not have to explicitly initialize the object in the ctor-initializer. For example, if you have an `std::string` as data member, its default constructor initializes the string to the empty string, so initializing it to "" in the ctor-initializer is superfluous.

On the other hand, if your class has as data member an object of a class without a default constructor, you have to use the ctor-initializer to properly construct that object. For example, take the following `SpreadsheetCell` class:

```
class SpreadsheetCell
{
    public:
        SpreadsheetCell(double d);
};
```

This class only has one explicit constructor accepting a `double` and does not include a default constructor. You can use this class as a data member of another class as follows:

```
class SomeClass
{
    public:
        SomeClass();
    private:
        SpreadsheetCell mCell;
};
```

And you can implement the `SomeClass` constructor as follows:

```
SomeClass::SomeClass() { }
```

However, with this implementation, the code does not compile. The compiler does not know how to initialize the `mCell` data member of `SomeClass` because it does not have a default constructor.

You have to initialize the `mCell` data member in the ctor-initializer as follows:

```
SomeClass::SomeClass() : mCell(1.0) { }
```

NOTE *Ctor-initializers allow initialization of data members at the time of their creation.*

Some programmers prefer to assign initial values in the body of the constructor, even though this might be less efficient. However, several data types must be initialized in a ctor-initializer or with an in-class initializer. The following table summarizes them:

DATA TYPE	EXPLANATION
const data members	You cannot legally assign a value to a <code>const</code> variable after it is created. Any value must be supplied at the time of creation.
Reference data members	References cannot exist without referring to something.
Object data members for which there is no default constructor	C++ attempts to initialize member objects using a default constructor. If no default constructor exists, it cannot initialize the object.
Base classes without default constructors	These are covered in Chapter 10.

There is one important caveat with ctor-initializers: they initialize data members in the order that they appear in the class definition, not their order in the ctor-initializer. Take the following definition for a class called `Foo`. Its constructor simply stores a `double` value and prints out the value to the console.

```
class Foo
{
    public:
        Foo(double value);
    private:
        double mValue;
};

Foo::Foo(double value) : mValue(value)
{
    cout << "Foo::mValue = " << mValue << endl;
}
```

Suppose you have another class, `MyClass`, that contains a `Foo` object as one of its data members:

```
class MyClass
{
    public:
        MyClass(double value);
    private:
        double mValue;
        Foo mFoo;
};
```

Its constructor could be implemented as follows:

```
MyClass::MyClass(double value) : mValue(value), mFoo(mValue)
{
    cout << "MyClass::mValue = " << mValue << endl;
}
```

The ctor-initializer first stores the given value in `mValue`, and then calls the `Foo` constructor with `mValue` as argument. You can create an instance of `MyClass` as follows:

```
MyClass instance(1.2);
```

Here is the output of the program:

```
Foo::mValue = 1.2
MyClass::mValue = 1.2
```

So, everything looks fine. Now make one tiny change to the `MyClass` definition. You just reverse the order of the `mValue` and `mFoo` data members. Nothing else is changed.

```
class MyClass
{
    public:
        MyClass(double value);
    private:
        Foo mFoo;
        double mValue;
};
```

The output of the program now depends on your system. It could, for example, be as follows:

```
Foo::mValue = -9.25596e+61
MyClass::mValue = 1.2
```

This is far from what you would expect. You might assume, based on your ctor-initializer, that `mValue` is initialized before using `mValue` in the call to the `Foo` constructor. But C++ doesn't work that way. The data members are initialized in the order they appear in the definition of the class, not the order in the ctor-initializer! So, in this case, the `Foo` constructor is called first with an uninitialized `mValue`.

Note that some compilers issue a warning when the order in the class definition does not match the order in the ctor-initializer.

WARNING *Ctor-initializers initialize data members in their declared order in the class definition, not their order in the ctor-initializer list.*

Copy Constructors

There is a special constructor in C++ called a *copy constructor* that allows you to create an object that is an exact copy of another object. If you don't write a copy constructor, C++ generates one for you that initializes each data member in the new object from its equivalent data member in the source object. For object data members, this initialization means that their copy constructors are called.

Here is the declaration for a copy constructor in the `SpreadsheetCell` class:

```
class SpreadsheetCell
{
public:
    SpreadsheetCell(const SpreadsheetCell& src);
    // Remainder of the class definition omitted for brevity
};
```

The copy constructor takes a `const` reference to the source object. Like other constructors, it does not return a value. Inside the constructor, you should copy all the data members from the source object. Technically, of course, you can do whatever you want in the copy constructor, but it's generally a good idea to follow expected behavior and initialize the new object to be a copy of the old one. Here is a sample implementation of the `SpreadsheetCell` copy constructor. Note the use of the ctor-initializer.

```
SpreadsheetCell::SpreadsheetCell(const SpreadsheetCell& src)
    : mValue(src.mValue)
{
}
```

NOTE *The `SpreadsheetCell` copy constructor is only shown for demonstration purposes. In fact, in this case, the copy constructor can be omitted because the default compiler-generated one is good enough. However, under certain conditions, this default copy constructor is not sufficient. These conditions are covered in Chapter 9.*

Given a set of data members, called `m1`, `m2`, ... `mn`, the compiler-generated copy constructor can be expressed as follows:

```
classname::classname(const classname& src)
    : m1(src.m1), m2(src.m2), ... mn(src.mn) { }
```

Therefore, in most circumstances, there is no need for you to specify a copy constructor!

When the Copy Constructor Is Called

The default semantics for passing arguments to functions in C++ is pass-by-value. That means that the function or method receives a copy of the value or object. Thus, whenever you pass an object to a function or method, the compiler calls the copy constructor of the new object to initialize it. For example, suppose you have the following `printString()` function accepting a `string` parameter by value:

```
void printString(string inString)
{
    cout << inString << endl;
}
```

Recall that the C++ `string` is actually a class, not a built-in type. When your code makes a call to `printString()` passing a `string` argument, the `string` parameter `inString` is initialized with a call to its copy constructor. The argument to the copy constructor is the `string` you passed to `printString()`. In the following example, the `string` copy constructor is executed for the `inString` object in `printString()` with `name` as its parameter.

```
string name = "heading one";
printString(name); // Copies name
```

When the `printString()` method finishes, `inString` is destroyed. Because it was only a copy of `name`, `name` remains intact. Of course, you can avoid the overhead of copy constructors by passing parameters as `const` references.

When returning objects by value from a function, the copy constructor might also get called. This is discussed in the section “Objects as Return Values” later in this chapter.

Calling the Copy Constructor Explicitly

You can use the copy constructor explicitly as well. It is often useful to be able to construct one object as an exact copy of another. For example, you might want to create a copy of a `SpreadsheetCell` object like this:

```
SpreadsheetCell myCell1(4);
SpreadsheetCell myCell2(myCell1); // myCell2 has the same values as myCell1
```

Passing Objects by Reference

In order to avoid copying objects when you pass them to functions and methods, you should declare that the function or method takes a *reference* to the object. Passing objects by reference is usually more efficient than passing them by value, because only the address of the object is copied, not the entire contents of the object. Additionally, pass-by-reference avoids problems with dynamic memory allocation in objects, which is discussed in Chapter 9.

When you pass an object by reference, the function or method using the object reference could change the original object. When you are only using pass-by-reference for efficiency, you should preclude this possibility by declaring the object `const` as well. This is known as passing objects by `const` reference and has been done in examples throughout this book.

NOTE *For performance reasons, it is best to pass objects by `const` reference instead of by value.*

Note that the `SpreadsheetCell` class has a number of methods accepting an `std::string_view` as parameter. As discussed in Chapter 2, a `string_view` is basically just a pointer and a length. So, it is very cheap to copy, and is usually passed by value.

Also primitive types, such as `int`, `double`, and so on, should just be passed by value. You don't gain anything by passing such types by `const` reference.

The `doubleToString()` method of the `SpreadsheetCell` class always returns a `string` by value because the implementation of the method creates a local `string` object that at the end of the method is returned to the caller. Returning a reference to this `string` wouldn't work because the `string` to which it references will be destroyed when the function exits.

Explicitly Defaulted and Deleted Copy Constructor

You can explicitly default or delete a compiler-generated copy constructor as follows:

```
SpreadsheetCell(const SpreadsheetCell& src) = default;
```

or

```
SpreadsheetCell(const SpreadsheetCell& src) = delete;
```

By deleting the copy constructor, the object cannot be copied anymore. This can be used to disallow passing the object by value, as discussed in Chapter 9.

Initializer-List Constructors

An *initializer-list constructor* is a constructor with an `std::initializer_list<T>` as first parameter, without any additional parameters or with additional parameters having default values. Before you can use the `std::initializer_list<T>` template, you need to include the `<initializer_list>` header. The following class demonstrates its use. The class accepts only an `initializer_list<T>` with an even number of elements; otherwise, it throws an exception.

```

class EvenSequence
{
public:
    EvenSequence(initializer_list<double> args)
    {
        if (args.size() % 2 != 0) {
            throw invalid_argument("initializer_list should "
                "contain even number of elements.");
        }
        mSequence.reserve(args.size());
        for (const auto& value : args) {
            mSequence.push_back(value);
        }
    }

    void dump() const
    {
        for (const auto& value : mSequence) {
            cout << value << ", ";
        }
        cout << endl;
    }

private:
    vector<double> mSequence;
};

```

Inside the initializer-list constructor you can access the elements of the initializer-list with a range-based `for` loop. You can get the number of elements in the initializer-list with the `size()` method.

The `EvenSequence` initializer-list constructor uses a range-based `for` loop to copy elements from the given `initializer_list<T>`. You can also use the `assign()` method of `vector`. The different methods of `vector`, including `assign()`, are discussed in detail in Chapter 17. To give you an idea of the power of a `vector`, here is the initializer-list constructor using `assign()`:

```

EvenSequence(initializer_list<double> args)
{
    if (args.size() % 2 != 0) {
        throw invalid_argument("initializer_list should "
            "contain even number of elements.");
    }
    mSequence.assign(args);
}

```

`EvenSequence` objects can be constructed as follows:

```

EvenSequence p1 = {1.0, 2.0, 3.0, 4.0, 5.0, 6.0};
p1.dump();

try {
    EvenSequence p2 = {1.0, 2.0, 3.0};
} catch (const invalid_argument& e) {
    cout << e.what() << endl;
}

```

The construction of `p2` throws an exception because it has an odd number of elements in the initializer-list. The preceding equal signs are optional and can be left out, as in this example:

```
EvenSequence p1{1.0, 2.0, 3.0, 4.0, 5.0, 6.0};
```

The Standard Library has full support for initializer-list constructors. For example, the `std::vector` container can be initialized with an initializer-list:

```
std::vector<std::string> myVec = {"String 1", "String 2", "String 3"};
```

Without initializer-list constructors, one way to initialize this vector is by using several `push_back()` calls:

```
std::vector<std::string> myVec;
myVec.push_back("String 1");
myVec.push_back("String 2");
myVec.push_back("String 3");
```

Initializer lists are not limited to constructors and can also be used with normal functions as explained in Chapter 1.

Delegating Constructors

Delegating constructors allow constructors to call another constructor from the same class.

However, this call cannot be placed in the constructor body; it must be in the ctor-initializer and it must be the only member-initializer in the list. Following is an example:

```
SpreadsheetCell::SpreadsheetCell(string_view initialValue)
    : SpreadsheetCell(stringToDouble(initialValue))
{
}
```

When this `string_view` constructor (the delegating constructor) is called, it first delegates the call to the target constructor, which is the `double` constructor in this example. When the target constructor returns, the body of the delegating constructor is executed.

Make sure you avoid constructor recursion while using delegate constructors. Here is an example:

```
class MyClass
{
    MyClass(char c) : MyClass(1.2) { }
    MyClass(double d) : MyClass('m') { }
};
```

The first constructor delegates to the second constructor, which delegates back to the first one. The behavior of such code is undefined by the standard and depends on the compiler.

Summary of Compiler-Generated Constructors

The compiler can automatically generate a default constructor and a copy constructor for every class. However, the constructors that the compiler automatically generates depend on the constructors that you define yourself according to the rules in the following table.

IF YOU DEFINE THEN THE COMPILER GENERATES AND YOU CAN CREATE AN OBJECT . . .
[no constructors]	A default constructor A copy constructor	With no arguments: <code>SpreadsheetCell cell;</code> As a copy of another object: <code>SpreadsheetCell myCell(cell);</code>
A default constructor only	A copy constructor	With no arguments: <code>SpreadsheetCell cell;</code> As a copy of another object: <code>SpreadsheetCell myCell(cell);</code>
A copy constructor only	No constructors	Theoretically, as a copy of another object. Practically, you can't create any objects, because there are no non-copy constructors.
A single-argument or multi-argument non-copy constructor only	A copy constructor	With arguments: <code>SpreadsheetCell cell(6);</code> As a copy of another object: <code>SpreadsheetCell myCell(cell);</code>
A default constructor as well as a single-argument or multi-argument non-copy constructor	A copy constructor	With no arguments: <code>SpreadsheetCell cell;</code> With arguments: <code>SpreadsheetCell myCell(5);</code> As a copy of another object: <code>SpreadsheetCell anotherCell(cell);</code>

Note the lack of symmetry between the default constructor and the copy constructor. As long as you don't define a copy constructor explicitly, the compiler creates one for you. On the other hand, as soon as you define *any* constructor, the compiler stops generating a default constructor.

As mentioned before in this chapter, the automatic generation of a default constructor and a default copy constructor can be influenced by defining them as explicitly defaulted or explicitly deleted.

NOTE A final type of constructor is called a move constructor, which is required to implement move semantics. Move semantics can be used to increase performance in certain situations and is discussed in detail in Chapter 9.

Object Destruction

When an object is destroyed, two events occur: the object's *destructor* method is called, and the memory it was taking up is freed. The destructor is your chance to perform any cleanup work for the object, such as freeing dynamically allocated memory or closing file handles. If you don't declare a destructor, the compiler writes one for you that does recursive member-wise destruction and allows the object to be deleted. The section on dynamic memory allocation in Chapter 9 shows you how to write a destructor.

Objects on the stack are destroyed when they go *out of scope*, which means whenever the current function, method, or other execution *block* ends. In other words, whenever the code encounters an ending curly brace, any objects created on the stack within those curly braces are destroyed. The following program shows this behavior:

```
int main()
{
    SpreadsheetCell myCell(5);
    if (myCell.getValue() == 5) {
        SpreadsheetCell anotherCell(6);
    } // anotherCell is destroyed as this block ends.

    cout << "myCell: " << myCell.getValue() << endl;
    return 0;
} // myCell is destroyed as this block ends.
```

Objects on the stack are destroyed in the reverse order of their declaration (and construction). For example, in the following code fragment, `myCell12` is created before `anotherCell12`, so `anotherCell12` is destroyed before `myCell12` (note that you can start a new code block at any point in your program with an opening curly brace):

```
{
    SpreadsheetCell myCell12(4);
    SpreadsheetCell anotherCell12(5); // myCell12 constructed before anotherCell12
} // anotherCell12 destroyed before myCell12
```

This ordering also applies to objects that are data members of other objects. Recall that data members are initialized in the order of their declaration in the class. Thus, following the rule that objects are destroyed in the reverse order of their construction, data member objects are destroyed in the reverse order of their declaration in the class.

Objects allocated on the heap without the help of smart pointers are not destroyed automatically. You must call `delete` on the object pointer to call its destructor and free the memory. The following program shows this behavior:

```
int main()
{
    SpreadsheetCell* cellPtr1 = new SpreadsheetCell(5);
    SpreadsheetCell* cellPtr2 = new SpreadsheetCell(6);
    cout << "cellPtr1: " << cellPtr1->getValue() << endl;
    delete cellPtr1; // Destroys cellPtr1
    cellPtr1 = nullptr;
    return 0;
} // cellPtr2 is NOT destroyed because delete was not called on it.
```

WARNING Do not write programs like the preceding example where `cellPtr2` is not deleted. Make sure you always free dynamically allocated memory by calling `delete` or `delete[]` depending on whether the memory was allocated using `new` or `new[]`. Or better yet, use smart pointers as discussed earlier!

NOTE There are tools that are able to detect unfreed objects. These tools are discussed in Chapter 7.

Assigning to Objects

Just as you can assign the value of one `int` to another in C++, you can assign the value of one object to another. For example, the following code assigns the value of `myCell` to `anotherCell`:

```
SpreadsheetCell myCell(5), anotherCell;  
anotherCell = myCell;
```

You might be tempted to say that `myCell` is “copied” to `anotherCell`. However, in the world of C++, “copying” only occurs when an object is being initialized. If an object already has a value that is being overwritten, the more accurate term is “assigned to.” Note that the facility that C++ provides for copying is the copy constructor. Because it is a constructor, it can only be used for object creation, not for later assignments to the object.

Therefore, C++ provides another method in every class to perform assignment. This method is called the *assignment operator*. Its name is `operator=` because it is actually an overloading of the `=` operator for that class. In the preceding example, the assignment operator for `anotherCell` is called, with `myCell` as the argument.

NOTE The assignment operator as explained in this section is sometimes called the copy assignment operator because both the left-hand side and the right-hand side object stay alive after the assignment. This distinction is made because there is also a move assignment operator in which the right-hand side object is destroyed after the assignment for performance reasons. This move assignment operator is explained in Chapter 9.

As usual, if you don’t write your own assignment operator, C++ writes one for you to allow objects to be assigned to one another. The default C++ assignment behavior is almost identical to its default copying behavior: it recursively assigns each data member from the source to the destination object.

Declaring an Assignment Operator

Here is the assignment operator for the `SpreadsheetCell` class:

```
class SpreadsheetCell
{
    public:
        SpreadsheetCell& operator=(const SpreadsheetCell& rhs);
        // Remainder of the class definition omitted for brevity
};
```

The assignment operator often takes a `const` reference to the source object, like the copy constructor. In this case, the source object is called `rhs`, which stands for right-hand side of the equals sign, but you are free to call it whatever you want. The object on which the assignment operator is called is the left-hand side of the equals sign.

Unlike a copy constructor, the assignment operator returns a reference to a `SpreadsheetCell` object. The reason is that assignments can be *chained*, as in the following example:

```
myCell = anotherCell = aThirdCell;
```

When that line is executed, the first thing that happens is the assignment operator for `anotherCell` is called with `aThirdCell` as its “right-hand side” parameter. Next, the assignment operator for `myCell` is called. However, its parameter is not `anotherCell`. Its right-hand side is the *result* of the assignment of `aThirdCell` to `anotherCell`. If that assignment fails to return a result, there is nothing to pass to `myCell`.

You might be wondering why the assignment operator for `myCell` can’t just take `anotherCell`. The reason is that using the equals sign is actually just shorthand for what is really a method call. When you look at the line in its full functional syntax, you can see the problem:

```
myCell.operator=(anotherCell.operator=(aThirdCell));
```

Now, you can see that the `operator=` call from `anotherCell` must return a value, which is passed to the `operator=` call for `myCell`. The correct value to return is `anotherCell` itself, so it can serve as the source for the assignment to `myCell`. However, returning `anotherCell` directly would be inefficient, so you can return a reference to `anotherCell`.

WARNING *You could actually declare the assignment operator to return whatever type you wanted, including `void`. However, you should always return a reference to the object on which it is called because that’s what clients expect.*

Defining an Assignment Operator

The implementation of the assignment operator is similar to that of a copy constructor, with several important differences. First, a copy constructor is called only for initialization, so the destination object does not yet have valid values. An assignment operator can overwrite the current values in an object. This consideration doesn’t really come into play until you have dynamically allocated memory in your objects. See Chapter 9 for details.

Second, it’s legal in C++ to assign an object to itself. For example, the following code compiles and runs:

```
SpreadsheetCell cell(4);
cell = cell; // Self-assignment
```

Your assignment operator needs to take the possibility of self-assignment into account. In the `SpreadsheetCell` class, this is not important, as its only data member is a primitive type, `double`. However, when your class has dynamically allocated memory or other resources, it's paramount to take self-assignment into account, as is discussed in detail in Chapter 9. To prevent problems in such cases, assignment operators usually check for self-assignment at the beginning of the method and return immediately.

Here is the start of the definition of the assignment operator for the `SpreadsheetCell` class:

```
SpreadsheetCell& SpreadsheetCell::operator=(const SpreadsheetCell& rhs)
{
    if (this == &rhs) {
```

This first line checks for self-assignment, but it might be a bit cryptic. Self-assignment occurs when the left-hand side and the right-hand side of the equals sign are the same. One way to tell if two objects are the same is if they occupy the same memory location—more explicitly, if pointers to them are equal. Recall that `this` is a pointer to an object accessible from any method called on the object. Thus, `this` is a pointer to the left-hand side object. Similarly, `&rhs` is a pointer to the right-hand side object. If these pointers are equal, the assignment must be self-assignment, but because the return type is `SpreadsheetCell&`, a correct value must still be returned. All assignment operators return `*this`, and the self-assignment case is no exception:

```
        return *this;
    }
```

`this` is a pointer to the object on which the method executes, so `*this` is the object itself. The compiler returns a reference to the object to match the declared return value. Now, if it is not self-assignment, you have to do an assignment to every member:

```
        mValue = rhs.mValue;
        return *this;
    }
```

Here the method copies the values, and finally, it returns `*this`, as explained previously.

NOTE *The `SpreadsheetCell` assignment operator is only shown for demonstration purposes. In fact, in this case, the assignment operator can be omitted because the default compiler-generated one is good enough; it does simple member-wise assignments of all the data members. However, under certain conditions, this default assignment operator is not sufficient. These conditions are covered in Chapter 9.*

Explicitly Defaulted and Deleted Assignment Operator

You can explicitly default or delete a compiler-generated assignment operator as follows:

```
SpreadsheetCell& operator=(const SpreadsheetCell& rhs) = default;
```

or

```
SpreadsheetCell& operator=(const SpreadsheetCell& rhs) = delete;
```

Compiler-Generated Copy Constructor and Copy Assignment Operator

C++11 has deprecated the generation of a copy constructor if the class has a user-declared copy assignment operator or destructor. If you still need a compiler-generated copy constructor in such a case, you can explicitly default one:

```
MyClass(const MyClass& src) = default;
```

C++11 has also deprecated the generation of a copy assignment operator if the class has a user-declared copy constructor or destructor. If you still need a compiler-generated copy assignment operator in such a case, you can explicitly default one:

```
MyClass& operator=(const MyClass& rhs) = default;
```

Distinguishing Copying from Assignment

It is sometimes difficult to tell when objects are initialized with a copy constructor rather than assigned to with the assignment operator. Essentially, things that look like a declaration are going to be using copy constructors, and things that look like assignment statements are handled by the assignment operator. Consider the following code:

```
SpreadsheetCell myCell(5);  
SpreadsheetCell anotherCell(myCell);
```

`AnotherCell` is constructed with the copy constructor.

```
SpreadsheetCell aThirdCell = myCell;
```

`aThirdCell` is also constructed with the copy constructor, because this is a declaration. The `operator=` is not called for this line! This syntax is just another way to write `SpreadsheetCell aThirdCell(myCell);`. However, consider the following code:

```
anotherCell = myCell; // Calls operator= for anotherCell
```

Here, `anotherCell` has already been constructed, so the compiler calls `operator=`.

Objects as Return Values

When you return objects from functions or methods, it is sometimes difficult to see exactly what copying and assignment is happening. For example, the implementation of `SpreadsheetCell::getString()` looks like this:

```
string SpreadsheetCell::getString() const  
{  
    return doubleToString(mValue);  
}
```

Now consider the following code:

```
SpreadsheetCell myCell2(5);  
string s1;  
s1 = myCell2.getString();
```

When `getString()` returns the string, the compiler actually creates an unnamed temporary `string` object by calling a `string` copy constructor. When you assign this result to `s1`, the assignment operator is called for `s1` with the temporary `string` as a parameter. Then, the temporary `string` object is destroyed. Thus, the single line of code invokes the copy constructor and the assignment operator (for two different objects). However, compilers are free and sometimes required to implement *Return Value Optimization* (RVO), also known as *copy elision*, to optimize away costly copy constructions when returning values.

In case you're not confused enough, consider this code:

```
SpreadsheetCell myCell3(5);
string s2 = myCell3.getString();
```

In this case, `getString()` still creates a temporary unnamed `string` object when it returns. But now, `s2` gets its copy constructor called, not its assignment operator.

With *move semantics*, the compiler can use a *move constructor* instead of a copy constructor to return the string from `getString()`. This is more efficient and is discussed in Chapter 9.

If you ever forget the order in which these things happen or which constructor or operator is called, you can easily figure it out by temporarily including helpful output in your code or by stepping through it with a debugger.

Copy Constructors and Object Members

You should also note the difference between assignment and copy constructor calls in constructors. If an object contains other objects, the compiler-generated copy constructor calls the copy constructors of each of the contained objects recursively. When you write your own copy constructor, you can provide the same semantics by using a ctor-initializer, as shown previously. If you omit a data member from the ctor-initializer, the compiler performs default initialization on it (a call to the default constructor for objects) before executing your code in the body of the constructor. Thus, by the time the body of the constructor executes, all object data members have already been initialized.

For example, you could write your copy constructor like this:

```
SpreadsheetCell::SpreadsheetCell(const SpreadsheetCell& src)
{
    mValue = src.mValue;
}
```

However, when you assign values to data members in the body of the copy constructor, you are using the assignment operator on them, not the copy constructor, because they have already been initialized, as described previously.

If you write the copy constructor as follows, then `mValue` is initialized using the copy constructor:

```
SpreadsheetCell::SpreadsheetCell(const SpreadsheetCell& src)
    : mValue(src.mValue)
{
}
```

SUMMARY

This chapter covered the fundamental aspects of C++'s facilities for object-oriented programming: classes and objects. It first reviewed the basic syntax for writing classes and using objects, including access control. Then, it covered object life cycles: when objects are constructed, destructed, and assigned to, and what methods those actions invoke. The chapter included details of the constructor syntax, including ctor-initializers and initializer-list constructors, and introduced the notion of copy assignment operators. It also specified exactly which constructors the compiler writes for you, and under what circumstances, and explained that default constructors require no arguments.

You may have found this chapter to be mostly review. Or, it may have opened your eyes to the world of object-oriented programming in C++. In any case, now that you are proficient with objects and classes, read Chapter 9 to learn more about their tricks and subtleties.



Mastering Classes and Objects

WHAT'S IN THIS CHAPTER?

- How to use dynamic memory allocation in objects
- What the copy-and-swap idiom is
- What rvalues and rvalue references are
- How move semantics can increase performance
- What the rule of zero means
- The different kinds of data members you can have (`static`, `const`, `reference`)
- The different kinds of methods you can implement (`static`, `const`, `inline`)
- The details of method overloading
- How to work with default arguments
- How to use nested classes
- How to make classes friends of other classes
- What operator overloading is
- How to write separate interface and implementation classes

WROX.COM DOWNLOADS FOR THIS CHAPTER

Please note that all the code examples for this chapter are available as a part of this chapter's code download on the book's website at www.wrox.com/go/proc++4e on the Download Code tab.

Chapter 8 started the discussion on classes and objects. Now it's time to master their subtleties so you can use them to their full potential. By reading this chapter, you will learn how to manipulate and exploit some of the most powerful aspects of the C++ language in order to write safe, effective, and useful classes.

Many of the concepts in this chapter arise in advanced C++ programming, especially in the C++ Standard Library.

FRIENDS

C++ allows classes to declare that other classes, member functions of other classes, or non-member functions are *friends*, and can access `protected` and `private` data members and methods. For example, suppose you have two classes called `Foo` and `Bar`. You can specify that the `Bar` class is a friend of `Foo` as follows:

```
class Foo
{
    friend class Bar;
    // ...
};
```

Now all the methods of `Bar` can access the `private` and `protected` data members and methods of `Foo`.

If you only want to make a specific method of `Bar` a friend, you can do that as well. Suppose the `Bar` class has a method `processFoo(const Foo& foo)`. The following syntax is used to make this method a friend of `Foo`:

```
class Foo
{
    friend void Bar::processFoo(const Foo& foo);
    // ...
};
```

Standalone functions can also be friends of classes. You might, for example, want to write a function that dumps all data of a `Foo` object to the console. You might want this function to be outside the `Foo` class to model an external audit, but the function should be able to access the internal data members of the object in order to check it properly. Here is the `Foo` class definition with a `friend dumpFoo()` function:

```
class Foo
{
    friend void dumpFoo(const Foo& foo);
    // ...
};
```

The `friend` declaration in the class serves as the function's prototype. There's no need to write the prototype elsewhere (although it's harmless to do so).

Here is the function definition:

```
void dumpFoo(const Foo& foo)
{
```

```

    // Dump all data of foo to the console, including
    // private and protected data members.
}

```

You write this function just like any other function, except that you can directly access `private` and `protected` data members of `Foo`. You don't repeat the `friend` keyword in the function definition.

Note that a class needs to know which other classes, methods, or functions want to be its friends; a class, method, or function cannot declare itself to be a friend of some other class and access the non-public names of that class.

`friend` classes and methods are easy to abuse; they allow you to violate the principle of encapsulation by exposing internals of your class to other classes or functions. Thus, you should use them only in limited circumstances. Some use cases are shown throughout this chapter.

DYNAMIC MEMORY ALLOCATION IN OBJECTS

Sometimes you don't know how much memory you will need before your program actually runs. As you read in Chapter 7, the solution is to dynamically allocate as much space as you need during program execution. Classes are no exception. Sometimes you don't know how much memory an object will need when you write the class. In that case, the object should dynamically allocate memory.

Dynamically allocated memory in objects provides several challenges, including freeing the memory, handling object copying, and handling object assignment.

The Spreadsheet Class

Chapter 8 introduces the `SpreadsheetCell` class. This chapter moves on to write the `Spreadsheet` class. As with the `SpreadsheetCell` class, the `Spreadsheet` class evolves throughout this chapter. Thus, the various attempts do not always illustrate the best way to do every aspect of class writing. To start, a `Spreadsheet` is simply a two-dimensional array of `SpreadsheetCells`, with methods to set and retrieve cells at specific locations in the `Spreadsheet`. Although most spreadsheet applications use letters in one direction and numbers in the other to refer to cells, this `Spreadsheet` uses numbers in both directions. Here is a first attempt at a class definition for a simple `Spreadsheet` class:

```

#include <cstddef>
#include "SpreadsheetCell.h"

class Spreadsheet
{
public:
    Spreadsheet(size_t width, size_t height);
    void setCellAt(size_t x, size_t y, const SpreadsheetCell& cell);
    SpreadsheetCell& getCellAt(size_t x, size_t y);
private:
    bool inRange(size_t value, size_t upper) const;
    size_t mWidth = 0;
    size_t mHeight = 0;
    SpreadsheetCell** mCells = nullptr;
};

```

NOTE *The Spreadsheet class uses normal pointers for the mCells array. This is done throughout this chapter to show the consequences and to explain how you should handle dynamic memory in classes. In production code, you should use one of the standard C++ containers, like `std::vector` which greatly simplifies the implementation of Spreadsheet, but then you won't learn how to correctly handle dynamic memory using raw pointers. In modern C++, you should never use raw pointers, but you might come across them in existing code, in which case you need to know how to work with them.*

Note that the `Spreadsheet` class does not contain a standard two-dimensional array of `SpreadsheetCells`. Instead, it contains a `SpreadsheetCell**`. This is because each `Spreadsheet` object might have different dimensions, so the constructor of the class must dynamically allocate the two-dimensional array based on the client-specified height and width. In order to allocate dynamically a two-dimensional array, you need to write the following code. Note that in C++, unlike in Java, it's not possible to simply write `new SpreadsheetCell [mWidth] [mHeight]`.

```
Spreadsheet::Spreadsheet(size_t width, size_t height)
    : mWidth(width), mHeight(height)
{
    mCells = new SpreadsheetCell*[mWidth];
    for (size_t i = 0; i < mWidth; i++) {
        mCells[i] = new SpreadsheetCell[mHeight];
    }
}
```

The resulting memory for a `Spreadsheet` called `s1` on the stack with width 4 and height 3 is shown in Figure 9-1.

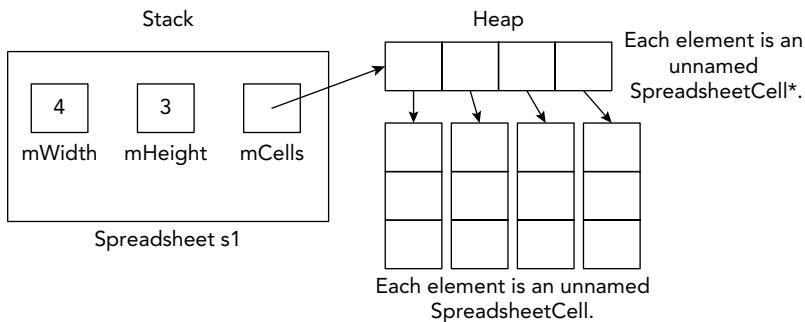

FIGURE 9-1

The implementations of the set and retrieval methods are straightforward:

```
void Spreadsheet::setCellAt(size_t x, size_t y, const SpreadsheetCell& cell)
{
    if (!inRange(x, mWidth) || !inRange(y, mHeight)) {
```

```

        throw std::out_of_range("");
    }
    mCells[x][y] = cell;
}

SpreadsheetCell& Spreadsheet::getCellAt(size_t x, size_t y)
{
    if (!inRange(x, mWidth) || !inRange(y, mHeight)) {
        throw std::out_of_range("");
    }
    return mCells[x][y];
}

```

Note that these two methods use a helper method `inRange()` to check that `x` and `y` represent valid coordinates in the spreadsheet. Attempting to access an array element at an out-of-range index will cause the program to malfunction. This example uses exceptions, which are mentioned in Chapter 1 and described in detail in Chapter 14.

If you look at the `setCellAt()` and `getCellAt()` methods, you see there is some clear code duplication. Chapter 6 explains that code duplication should be avoided at all costs. So, let's follow that guideline. Instead of a helper method called `inRange()`, the following `verifyCoordinate()` method is defined for the class:

```
void verifyCoordinate(size_t x, size_t y) const;
```

The implementation checks the given coordinate and throws an exception if the coordinate is invalid:

```
void Spreadsheet::verifyCoordinate(size_t x, size_t y) const
{
    if (x >= mWidth || y >= mHeight) {
        throw std::out_of_range("");
    }
}

```

The `setCellAt()` and `getCellAt()` methods can now be simplified:

```
void Spreadsheet::setCellAt(size_t x, size_t y, const SpreadsheetCell& cell)
{
    verifyCoordinate(x, y);
    mCells[x][y] = cell;
}

SpreadsheetCell& Spreadsheet::getCellAt(size_t x, size_t y)
{
    verifyCoordinate(x, y);
    return mCells[x][y];
}

```

Freeing Memory with Destructors

Whenever you are finished with dynamically allocated memory, you should free it. If you dynamically allocate memory in an object, the place to free that memory is in the *destructor*. The compiler

guarantees that the destructor is called when the object is destroyed. Here is the `Spreadsheet` class definition with a destructor:

```
class Spreadsheet
{
public:
    Spreadsheet(size_t width, size_t height);
    ~Spreadsheet();
    // Code omitted for brevity
};
```

The destructor has the same name as the name of the class (and of the constructors), preceded by a tilde (~). The destructor takes no arguments, and there can only be one of them. Destructors are implicitly marked as `noexcept`, since they should not throw any exceptions.

NOTE *A function can be marked with the `noexcept` keyword to specify that it won't throw any exceptions. For example:*

```
void myNonThrowingFunction() noexcept { /* ... */ }
```

Destructors are implicitly `noexcept`, so you don't need to add the keyword for them. If a `noexcept` function does throw an exception, the program is terminated. More details about `noexcept`, and why it is important that destructors don't throw any exceptions, are discussed in Chapter 14, "Handling Errors."

Here is the implementation of the `Spreadsheet` class destructor:

```
Spreadsheet::~Spreadsheet()
{
    for (size_t i = 0; i < mWidth; i++) {
        delete [] mCells[i];
    }
    delete [] mCells;
    mCells = nullptr;
}
```

This destructor frees the memory that was allocated in the constructor. However, no rule requires you to free memory in the destructor. You can write whatever code you want in the destructor, but it is a good idea to use it only for freeing memory or disposing of other resources.

Handling Copying and Assignment

Recall from Chapter 8 that if you don't write a copy constructor and an assignment operator yourself, C++ writes them for you. These compiler-generated methods recursively call the copy constructor or assignment operator on object data members. However, for primitives, such as `int`, `double`, and pointers, they provide *shallow* or *bitwise* copying or assignment: they just copy or assign the

data members from the source object directly to the destination object. That presents problems when you dynamically allocate memory in your object. For example, the following code copies the spreadsheet `s1` to initialize `s` when `s1` is passed to the `printSpreadsheet()` function:

```
#include "Spreadsheet.h"

void printSpreadsheet(Spreadsheet s)
{
    // Code omitted for brevity.
}

int main()
{
    Spreadsheet s1(4, 3);
    printSpreadsheet(s1);
    return 0;
}
```

The `Spreadsheet` contains one pointer variable: `mCells`. A shallow copy of a spreadsheet gives the destination object a copy of the `mCells` pointer, but not a copy of the underlying data. Thus, you end up with a situation where both `s` and `s1` have a pointer to the same data, as shown in Figure 9-2.

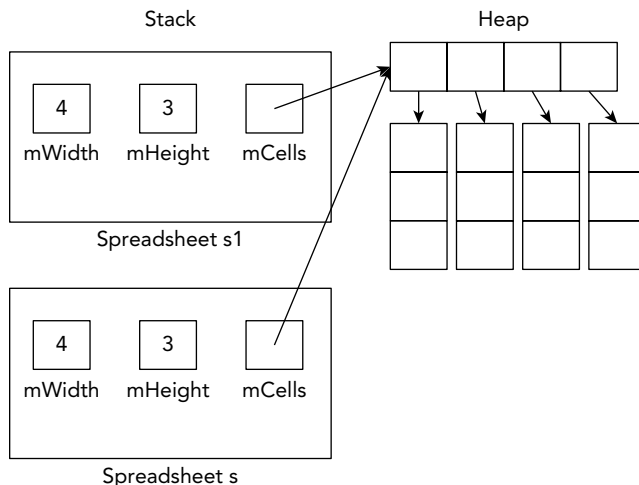

FIGURE 9-2

If `s` changes something to which `mCells` points, that change shows up in `s1` too. Even worse, when the `printSpreadsheet()` function exits, `s`'s destructor is called, which frees the memory pointed to by `mCells`. That leaves the situation shown in Figure 9-3.

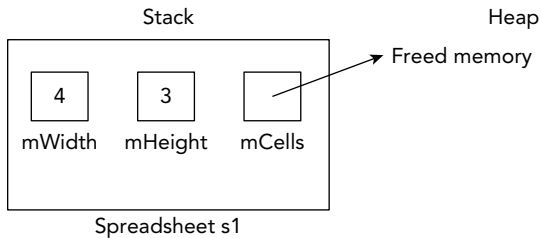

FIGURE 9-3

Now `s1` has a pointer that no longer points to valid memory. This is called a *dangling pointer*.

Unbelievably, the problem is even worse with assignment. Suppose that you have the following code:

```
Spreadsheet s1(2, 2), s2(4, 3);
s1 = s2;
```

After the first line, when both objects are constructed, you have the memory layout shown in Figure 9-4.

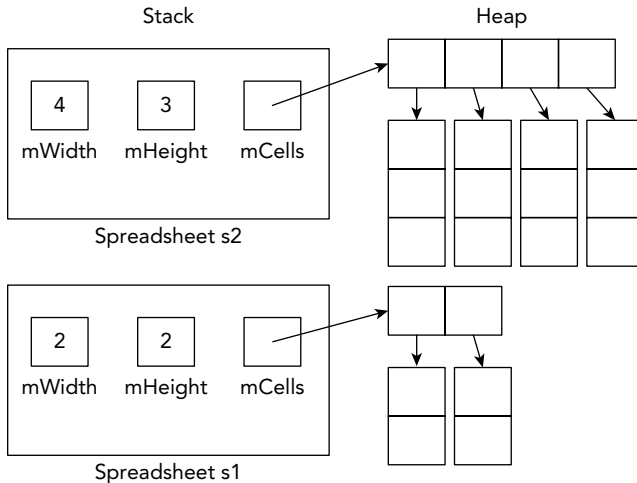

FIGURE 9-4

After the assignment statement, you have the layout shown in Figure 9-5.

Now, not only do the `mCells` pointers in `s1` and `s2` point to the same memory, but you have also *orphaned* the memory to which `mCells` in `s1` previously pointed. This is called a *memory leak*. That is why in assignment operators you must do a deep copy.

As you can see, relying on C++'s default copy constructor and default assignment operator is not always a good idea.

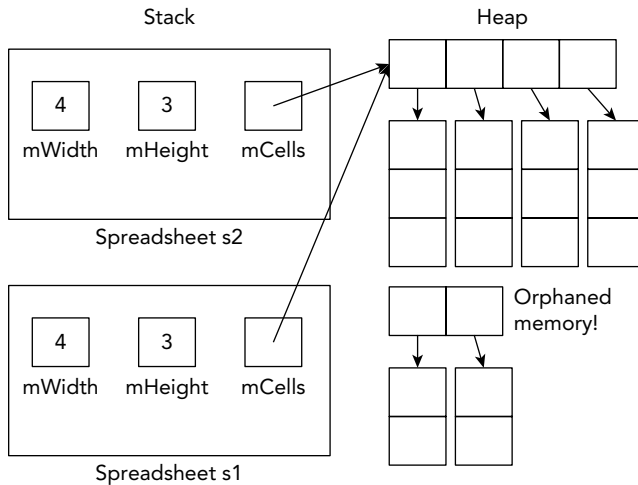

FIGURE 9-5

WARNING Whenever you have dynamically allocated memory in a class, you should write your own copy constructor and assignment operator to provide a deep copy of the memory.

The Spreadsheet Copy Constructor

Here is a declaration for a copy constructor in the `Spreadsheet` class:

```
class Spreadsheet
{
public:
    Spreadsheet(const Spreadsheet& src);
    // Code omitted for brevity
};
```

The definition is as follows:

```
Spreadsheet::Spreadsheet(const Spreadsheet& src)
: Spreadsheet(src.mWidth, src.mHeight)
{
    for (size_t i = 0; i < mWidth; i++) {
        for (size_t j = 0; j < mHeight; j++) {
            mCells[i][j] = src.mCells[i][j];
        }
    }
}
```

Note the use of a delegating constructor. The ctor-initializer of this copy constructor delegates first to the non-copy constructor to allocate the proper amount of memory. The body of the copy

constructor then copies the actual values. Together, this process implements a deep copy of the `mCells` dynamically allocated two-dimensional array.

There is no need to delete the existing `mCells` because this is a copy constructor and therefore there is not an existing `mCells` yet in `this` object.

The Spreadsheet Assignment Operator

The following shows the `Spreadsheet` class definition with an assignment operator:

```
class Spreadsheet
{
    public:
        Spreadsheet& operator=(const Spreadsheet& rhs);
        // Code omitted for brevity
};
```

A naïve implementation could be as follows:

```
Spreadsheet& Spreadsheet::operator=(const Spreadsheet& rhs)
{
    // Check for self-assignment
    if (this == &rhs) {
        return *this;
    }

    // Free the old memory
    for (size_t i = 0; i < mWidth; i++) {
        delete[] mCells[i];
    }
    delete[] mCells;
    mCells = nullptr;

    // Allocate new memory
    mWidth = rhs.mWidth;
    mHeight = rhs.mHeight;

    mCells = new SpreadsheetCell*[mWidth];
    for (size_t i = 0; i < mWidth; i++) {
        mCells[i] = new SpreadsheetCell[mHeight];
    }

    // Copy the data
    for (size_t i = 0; i < mWidth; i++) {
        for (size_t j = 0; j < mHeight; j++) {
            mCells[i][j] = rhs.mCells[i][j];
        }
    }

    return *this;
}
```

The code first checks for self-assignment, then frees the current memory of the `this` object, followed by allocating new memory, and finally copying the individual elements. There is a lot going on in this method, and a lot can go wrong! It is possible that the `this` object gets into an invalid state.

For example, suppose that the memory is successfully freed, that `mWidth` and `mHeight` are properly set, but that an exception is thrown in the loop that is allocating the memory. When that happens, execution of the remainder of the method is skipped, and the method is exited. Now the `Spreadsheet` instance is corrupt; its `mWidth` and `mHeight` data members state a certain size, but the `mCells` data member does not have the right amount of memory. Basically, this code is not exception safe!

What we need is an all-or-nothing mechanism; either everything succeeds, or the `this` object remains untouched. To implement such an exception-safe assignment operator, the *copy-and-swap* idiom is recommended. For this, a non-member `swap()` function is implemented as a friend of the `Spreadsheet` class. Instead of a non-member `swap()` function, you could also add a `swap()` method to the class. However, it's recommended practice to implement `swap()` as a non-member function, so that it can also be used by various Standard Library algorithms. Here is the definition of the `Spreadsheet` class with an assignment operator and the `swap()` function:

```
class Spreadsheet
{
    public:
        Spreadsheet& operator=(const Spreadsheet& rhs);
        friend void swap(Spreadsheet& first, Spreadsheet& second) noexcept;
        // Code omitted for brevity
};
```

A requirement for implementing the exception-safe copy-and-swap idiom is that the `swap()` function never throws any exceptions, so it is marked as `noexcept`. The implementation of the `swap()` function swaps each data member using the `std::swap()` utility function provided by the Standard Library in the `<utility>` header file:

```
void swap(Spreadsheet& first, Spreadsheet& second) noexcept
{
    using std::swap;

    swap(first.mWidth, second.mWidth);
    swap(first.mHeight, second.mHeight);
    swap(first.mCells, second.mCells);
}
```

Now that we have this exception-safe `swap()` function, it can be used to implement the assignment operator:

```
Spreadsheet& Spreadsheet::operator=(const Spreadsheet& rhs)
{
    // Check for self-assignment
    if (this == &rhs) {
        return *this;
    }

    Spreadsheet temp(rhs); // Do all the work in a temporary instance
    swap(*this, temp); // Commit the work with only non-throwing operations
    return *this;
}
```

The implementation uses the copy-and-swap idiom. For efficiency, but sometimes also for correctness, the first line of code in an assignment operator usually checks for self-assignment.

Next, a *copy* of the right-hand-side is made, called `temp`. Then `*this` is swapped with this copy. This pattern is the recommended way of implementing your assignment operators because it guarantees *strong exception safety*. This means that if any exception occurs, then the state of the current `Spreadsheet` object remains unchanged. This is implemented in three phases:

- The first phase makes a temporary copy. This does not modify the state of the current `Spreadsheet` object, and so there is no problem if an exception is thrown during this phase.
- The second phase uses the `swap()` function to swap the created temporary copy with the current object. The `swap()` function shall never throw exceptions.
- The third phase is the destruction of the temporary object, which now contains the original object (because of the swap), to clean up any memory.

NOTE *Next to copying, C++ also supports move semantics, which requires a move constructor and move assignment operator. These can be used to increase performance in certain situations and are discussed in detail in the section “Handling Moving with Move Semantics.”*

Disallowing Assignment and Pass-By-Value

Sometimes when you dynamically allocate memory in your class, it’s easiest just to prevent anyone from copying or assigning to your objects. You can do this by explicitly deleting your `operator=` and copy constructor. That way, if anyone tries to pass the object by value, return it from a function or method, or assign to it, the compiler will complain. Here is a `Spreadsheet` class definition that prevents assignment and pass-by-value:

```
class Spreadsheet
{
public:
    Spreadsheet(size_t width, size_t height);
    Spreadsheet(const Spreadsheet& src) = delete;
    ~Spreadsheet();
    Spreadsheet& operator=(const Spreadsheet& rhs) = delete;
    // Code omitted for brevity
};
```

You don’t provide implementations for deleted methods. The linker will never look for them because the compiler won’t allow code to call them. When you write code to copy or assign to a `Spreadsheet` object, the compiler will complain with a message like this:

```
'Spreadsheet &Spreadsheet::operator =(const Spreadsheet &)' : attempting to
reference a deleted function
```

NOTE *If your compiler doesn’t support explicitly deleting member functions, then you can disallow copying and assigning by making your copy constructor and assignment operator private without any implementation.*

Handling Moving with Move Semantics

Move semantics for objects requires a *move constructor* and a *move assignment operator*. These can be used by the compiler when the source object is a temporary object that will be destroyed after the operation is finished. Both the move constructor and the move assignment operator move the data members from the source object to the new object, leaving the source object in some valid but otherwise indeterminate state. Often, data members of the source object are reset to null values. This process actually *moves ownership* of the memory and other resources from one object to another object. They basically do a *shallow copy* of the member variables, *and* switch ownership of allocated memory and other resources to prevent dangling pointers or resources, and to prevent memory leaks.

Before you can implement move semantics, you need to learn about rvalues and rvalue references.

Rvalue References

In C++, an *lvalue* is something of which you can take an address; for example, a named variable. The name comes from the fact that lvalues can appear on the left-hand side of an assignment. An *rvalue*, on the other hand, is anything that is not an lvalue, such as a literal, or a temporary object or value. Typically, an rvalue is on the right-hand side of an assignment operator. For example, take the following statement:

```
int a = 4 * 2;
```

In this statement, `a` is an lvalue, it has a name and you can take the address of it with `&a`. The result of the expression `4 * 2` on the other hand is an rvalue. It is a temporary value that is destroyed when the statement finishes execution. In this example, a copy of this temporary value is stored in the variable with name `a`.

An *rvalue reference* is a reference to an rvalue. In particular, it is a concept that is applied when the rvalue is a temporary object. The purpose of an rvalue reference is to make it possible for a particular function to be chosen when a temporary object is involved. The consequence of this is that certain operations that normally involve copying large values can be implemented by copying pointers to those values, knowing the temporary object will be destroyed.

A function can specify an rvalue reference parameter by using `&&` as part of the parameter specification; for example, `type&& name`. Normally, a temporary object will be seen as a `const type&`, but when there is a function overload that uses an rvalue reference, a temporary object can be resolved to that overload. The following example demonstrates this. The code first defines two `handleMessage()` functions, one accepting an lvalue reference and one accepting an rvalue reference:

```
// lvalue reference parameter
void handleMessage(std::string& message)
{
    cout << "handleMessage with lvalue reference: " << message << endl;
}

// rvalue reference parameter
void handleMessage(std::string&& message)
{
    cout << "handleMessage with rvalue reference: " << message << endl;
}
```

You can call `handleMessage()` with a named variable as argument:

```
std::string a = "Hello ";
std::string b = "World";
handleMessage(a);           // Calls handleMessage(string& value)
```

Because `a` is a named variable, the `handleMessage()` function accepting an lvalue reference is called. Any changes `handleMessage()` does through its reference parameter will change the value of `a`.

You can also call `handleMessage()` with an expression as argument:

```
handleMessage(a + b);       // Calls handleMessage(string&& value)
```

The `handleMessage()` function accepting an lvalue reference cannot be used, because the expression `a + b` results in a temporary, which is not an lvalue. In this case the rvalue reference version is called. Because the argument is a temporary, any changes `handleMessage()` does through its reference parameter will be lost after the call returns.

A literal can also be used as argument to `handleMessage()`. This also triggers a call to the rvalue reference version because a literal cannot be an lvalue (though a literal can be passed as argument to a `const` reference parameter).

```
handleMessage("Hello World"); // Calls handleMessage(string&& value)
```

If you remove the `handleMessage()` function accepting an lvalue reference, calling `handleMessage()` with a named variable like `handleMessage(b)` will result in a compilation error because an rvalue reference parameter (`string&& message`) will never be bound to an lvalue (`b`). You can force the compiler to call the rvalue reference version of `handleMessage()` by using `std::move()`, which casts an lvalue into an rvalue as follows:

```
handleMessage(std::move(b)); // Calls handleMessage(string&& value)
```

As said before, but it's worth repeating, *a named variable is an lvalue*. So, inside the `handleMessage()` function, the rvalue reference `message` parameter itself is an lvalue because it has a name! If you want to forward this rvalue reference parameter to another function as an rvalue, then you need to use `std::move()` to cast the lvalue to an rvalue. For example, suppose you add the following function with an rvalue reference parameter:

```
void helper(std::string&& message)
{
}
```

Calling it as follows does not compile:

```
void handleMessage(std::string&& message)
{
    helper(message);
}
```

The `helper()` function needs an rvalue reference, while `handleMessage()` passes `message`, which has a name, so it's an lvalue, causing a compilation error. The correct way is to use `std::move()`:

```
void handleMessage(std::string&& message)
{
    helper(std::move(message));
}
```

WARNING *A named rvalue reference, such as an rvalue reference parameter, itself is an lvalue because it has a name!*

Rvalue references are not limited to parameters of functions. You can declare a variable of an rvalue reference type, and assign to it, although this usage is uncommon. Consider the following code, which is illegal in C++:

```
int& i = 2;           // Invalid: reference to a constant
int a = 2, b = 3;
int& j = a + b;     // Invalid: reference to a temporary
```

Using rvalue references, the following is perfectly legal:

```
int&& i = 2;
int a = 2, b = 3;
int&& j = a + b;
```

Stand-alone rvalue references, as in the preceding example, are rarely used in this way.

Implementing Move Semantics

Move semantics is implemented by using rvalue references. To add move semantics to a class, you need to implement a *move constructor* and a *move assignment operator*. Move constructors and move assignment operators should be marked with the `noexcept` qualifier to tell the compiler that they don't throw any exceptions. This is particularly important for compatibility with the Standard Library, as fully compliant implementations of, for example, the Standard Library containers will only move stored objects if, having move semantics implemented, they also guarantee not to throw. Following is the `Spreadsheet` class definition with a move constructor and move assignment operator. Two helper methods are introduced as well: `cleanup()`, which is used from the destructor and the move assignment operator, and `moveFrom()`, which moves the member variables from a source to a destination, and then resets the source object.

```
class Spreadsheet
{
public:
    Spreadsheet(Spreadsheet&& src) noexcept; // Move constructor
    Spreadsheet& operator=(Spreadsheet&& rhs) noexcept; // Move assign
    // Remaining code omitted for brevity
private:
    void cleanup() noexcept;
    void moveFrom(Spreadsheet& src) noexcept;
    // Remaining code omitted for brevity
};
```

The implementations are as follows:

```
void Spreadsheet::cleanup() noexcept
{
    for (size_t i = 0; i < mWidth; i++) {
        delete[] mCells[i];
    }
}
```

```
        delete[] mCells;
        mCells = nullptr;
        mWidth = mHeight = 0;
    }

void Spreadsheet::moveFrom(Spreadsheet& src) noexcept
{
    // Shallow copy of data
    mWidth = src.mWidth;
    mHeight = src.mHeight;
    mCells = src.mCells;

    // Reset the source object, because ownership has been moved!
    src.mWidth = 0;
    src.mHeight = 0;
    src.mCells = nullptr;
}

// Move constructor
Spreadsheet::Spreadsheet(Spreadsheet&& src) noexcept
{
    moveFrom(src);
}

// Move assignment operator
Spreadsheet& Spreadsheet::operator=(Spreadsheet&& rhs) noexcept
{
    // check for self-assignment
    if (this == &rhs) {
        return *this;
    }

    // free the old memory
    cleanup();

    moveFrom(rhs);

    return *this;
}
```

Both the move constructor and the move assignment operator are moving ownership of the memory for `mCells` from the source object to the new object. They reset the `mCells` pointer of the source object to a null pointer to prevent the destructor of the source object from deallocating that memory because now the new object is the owner of that memory.

Obviously, move semantics is useful only when you know that the source object will be destroyed.

Move constructors and move assignment operators can be explicitly deleted or defaulted, just like normal constructors and copy assignment operators, as explained in Chapter 8.

The compiler automatically generates a default move constructor for a class if and only if the class has no user-declared copy constructor, copy assignment operator, move assignment operator, or destructor. A default move assignment operator is generated for a class if and only if the class has no user-declared copy constructor, move constructor, copy assignment operator, or destructor.

NOTE *If you have dynamically allocated memory in your class, then you typically should implement a destructor, copy constructor, move constructor, copy assignment operator, and move assignment operator. This is called the Rule of Five.*

Moving Object Data Members

The `moveFrom()` method uses direct assignments of the three data members because they are primitive types. If your object has other objects as data members, then you should move these objects using `std::move()`. Suppose the `Spreadsheet` class has an `std::string` data member called `mName`. The `moveFrom()` method is then implemented as follows:

```
void Spreadsheet::moveFrom(Spreadsheet& src) noexcept
{
    // Move object data members
    mName = std::move(src.mName);

    // Move primitives:
    // Shallow copy of data
    mWidth = src.mWidth;
    mHeight = src.mHeight;
    mCells = src.mCells;

    // Reset the source object, because ownership has been moved!
    src.mWidth = 0;
    src.mHeight = 0;
    src.mCells = nullptr;
}
```

Move Constructor and Move Assignment Operator in Terms of Swap

The previous implementation of the move constructor and the move assignment operator both use the `moveFrom()` helper method which moves all data members by performing shallow copies. With this implementation, if you add a new data member to the `Spreadsheet` class, you have to modify both the `swap()` function and the `moveFrom()` method. If you forget to update one of them, you introduce a bug. To avoid such bugs, you can write the move constructor and the move assignment operator in terms of a default constructor and the `swap()` function.

The first thing to do is to add a default constructor to the `Spreadsheet` class. It doesn't make sense for users of the class to use this default constructor, so it's marked as private:

```
class Spreadsheet
{
private:
    Spreadsheet() = default;
    // Remaining code omitted for brevity
};
```

Next, we can remove the `cleanup()` and `moveFrom()` helper methods. The code from the `cleanup()` method is moved to the destructor. The move constructor and move assignment operator can then be implemented as follows:

```
Spreadsheet::Spreadsheet(Spreadsheet&& src) noexcept
    : Spreadsheet()
{
    swap(*this, src);
}

Spreadsheet& Spreadsheet::operator=(Spreadsheet&& rhs) noexcept
{
    Spreadsheet temp(std::move(rhs));
    swap(*this, temp);
    return *this;
}
```

The move constructor delegates first to the default constructor. Then, the default constructed `*this` is swapped with the given source object. The move assignment operator first creates a local `Spreadsheet` instance that is move-constructed with `rhs`. Then, `*this` is swapped with this local move-constructed `Spreadsheet` instance.

Implementing the move constructor and move assignment operator in terms of the default constructor and the `swap()` function might be a tiny bit less efficient compared to the earlier implementation using `moveFrom()`. The advantage however is that it requires less code and it is less likely bugs are introduced when data members are added to the class, because you only have to update your `swap()` implementation to include the new data members.

Testing the Spreadsheet Move Operations

The `Spreadsheet` move constructor and move assignment operator can be tested with the following code:

```
Spreadsheet createObject()
{
    return Spreadsheet(3, 2);
}

int main()
{
    vector<Spreadsheet> vec;
    for (int i = 0; i < 2; ++i) {
        cout << "Iteration " << i << endl;
        vec.push_back(Spreadsheet(100, 100));
        cout << endl;
    }

    Spreadsheet s(2,3);
    s = createObject();

    Spreadsheet s2(5,6);
    s2 = s;
    return 0;
}
```

Chapter 1 introduces the `vector`. A `vector` grows dynamically in size to accommodate new objects. This is done by allocating a bigger chunk of memory and then copying or moving the objects from the old `vector` to the new and bigger `vector`. If the compiler finds a move constructor, the objects are moved instead of copied. Because they are moved, there is no need for any deep copying, making it much more efficient.

When you add output statements to all constructors and assignment operators of the `Spreadsheet` class implemented with the `moveFrom()` method, the output of the preceding test program can be as follows. This output and the following discussion are based on the Microsoft Visual C++ 2017 compiler. The C++ standard does not specify the initial capacity of a `vector` or its growth strategy, so the output can be different on different compilers.

```
Iteration 0
Normal constructor      (1)
Move constructor        (2)

Iteration 1
Normal constructor      (3)
Move constructor        (4)
Move constructor        (5)

Normal constructor      (6)
Normal constructor      (7)
Move assignment operator (8)
Normal constructor      (9)
Copy assignment operator (10)
Normal constructor      (11)
Copy constructor        (12)
```

On the first iteration of the loop, the `vector` is still empty. Take the following line of code from the loop:

```
vec.push_back(Spreadsheet(100, 100));
```

With this line, a new `Spreadsheet` object is created, invoking the normal constructor (1). The `vector` resizes itself to make space for the new object being pushed in. The created `Spreadsheet` object is then moved into the `vector`, invoking the move constructor (2).

On the second iteration of the loop, a second `Spreadsheet` object is created with the normal constructor (3). At this point, the `vector` can hold one element, so it's again resized to make space for a second object. Because the `vector` is resized, the previously added elements need to be moved from the old `vector` to the new and bigger `vector`. This triggers a call to the move constructor for each previously added element. There is one element in the `vector`, so the move constructor is called one time (4). Finally, the new `Spreadsheet` object is moved into the `vector` with its move constructor (5).

Next, a `Spreadsheet` object `s` is created using the normal constructor (6). The `createObject()` function creates a temporary `Spreadsheet` object with its normal constructor (7), which is then returned from the function, and assigned to the variable `s`. Because the temporary object returned from `createObject()` ceases to exist after the assignment, the compiler invokes the move assignment operator (8) instead of the normal copy assignment operator. Another `Spreadsheet` object is created, `s2`, using the normal constructor (9). The assignment `s2 = s` invokes the copy assignment

operator (10) because the right-hand side object is not a temporary object, but a named object. This copy assignment operator creates a temporary copy, which triggers a call to the copy constructor, which first delegates to the normal constructor (11 and 12).

If the `Spreadsheet` class did not implement move semantics, all the calls to the move constructor and move assignment operator would be replaced with calls to the copy constructor and copy assignment operator. In the previous example, the `Spreadsheet` objects in the loop have 10,000 (100 x 100) elements. The implementation of the `Spreadsheet` move constructor and move assignment operator doesn't require any memory allocation, while the copy constructor and copy assignment operator require 101 allocations each. So, using move semantics can increase performance a lot in certain situations.

Implementing a Swap Function with Move Semantics

As another example where move semantics increases performance, take a `swap()` function that swaps two objects. The following `swapCopy()` implementation does not use move semantics:

```
void swapCopy(T& a, T& b)
{
    T temp(a);
    a = b;
    b = temp;
}
```

First, `a` is copied to `temp`, then `b` is copied to `a`, and finally `temp` is copied to `b`. This implementation will hurt performance if type `T` is expensive to copy. With move semantics, the implementation can avoid all copying:

```
void swapMove(T& a, T& b)
{
    T temp(std::move(a));
    a = std::move(b);
    b = std::move(temp);
}
```

This is exactly how `std::swap()` from the Standard Library is implemented.

Rule of Zero

Earlier in this chapter, the rule of five was introduced. All the discussions so far have been to explain how you have to write those five special member functions: destructor, copy and move constructors, and copy and move assignment operators. However, in modern C++, you should adopt the so-called *rule of zero*.

The rule of zero states that you should design your classes in such a way that they do not require any of those five special member functions. How do you do that? Basically, you should avoid having any old-style dynamically allocated memory. Instead, use modern constructs such as Standard Library containers. For example, use a `vector<vector<SpreadsheetCell>>` instead of the `SpreadsheetCell**` data member in the `Spreadsheet` class. The `vector` handles memory automatically, so there is no need for any of those five special member functions.

WARNING *In modern C++, adopt the rule of zero!*

MORE ABOUT METHODS

C++ also provides myriad choices for methods. This section explains all the tricky details.

static Methods

Methods, like data members, sometimes apply to the class as a whole, not to each object. You can write `static` methods as well as data members. As an example, consider the `SpreadsheetCell` class from Chapter 8. It has two helper methods: `stringToDouble()` and `doubleToString()`. These methods don't access information about specific objects, so they could be `static`. Here is the class definition with these methods `static`:

```
class SpreadsheetCell
{
    // Omitted for brevity
private:
    static std::string doubleToString(double inValue);
    static double stringToDouble(std::string_view inString);
    // Omitted for brevity
};
```

The implementations of these two methods are identical to the previous implementations. You don't repeat the `static` keyword in front of the method definitions. However, note that `static` methods are not called on a specific object, so they have no `this` pointer, and are not executing for a specific object with access to its non-`static` members. In fact, a `static` method is just like a regular function. The only difference is that it can access `private` and `protected` `static` members of the class. It can also access `private` and `protected` non-`static` data members on objects of the same type, if those objects are made visible to the `static` method, for example, by passing in a reference or pointer to such an object.

You call a `static` method just like a regular function from within any method of the class. Thus, the implementation of all the methods in `SpreadsheetCell` can stay the same. Outside of the class, you need to qualify the method name with the class name using the scope resolution operator. Access control applies as usual.

You might want to make `stringToDouble()` and `doubleToString()` `public` so that other code outside the class can make use of them. If so, you can call them from anywhere like this:

```
string str = SpreadsheetCell::doubleToString(5.0);
```

const Methods

A `const` object is an object whose value cannot be changed. If you have a `const`, reference to `const`, or pointer to a `const` object, the compiler does not let you call any methods on that object

unless those methods guarantee that they won't change any data members. The way you guarantee that a method won't change data members is to mark the method itself with the `const` keyword. Here is the `SpreadsheetCell` class with the methods that don't change any data members marked as `const`:

```
class SpreadsheetCell
{
    public:
        // Omitted for brevity
        double getValue() const;
        std::string getString() const;
        // Omitted for brevity
};
```

The `const` specification is part of the method prototype and must accompany its definition as well:

```
double SpreadsheetCell::getValue() const
{
    return mValue;
}

std::string SpreadsheetCell::getString() const
{
    return doubleToString(mValue);
}
```

Marking a method as `const` signs a contract with client code guaranteeing that you will not change the internal values of the object within the method. If you try to declare a method `const` that actually modifies a data member, the compiler will complain. You also cannot declare a `static` method, such as the `doubleToString()` and `stringToDouble()` methods from the previous section, `const` because it is redundant. Static methods do not have an instance of the class, so it would be impossible for them to change internal values. `const` works by making it appear inside the method that you have a `const` reference to each data member. Thus, if you try to change the data member, the compiler will flag an error.

You can call `const` and non-`const` methods on a non-`const` object. However, you can only call `const` methods on a `const` object. Here are some examples:

```
SpreadsheetCell myCell(5);
cout << myCell.getValue() << endl;           // OK
myCell.setString("6");                       // OK

const SpreadsheetCell& myCellConstRef = myCell;
cout << myCellConstRef.getValue() << endl;    // OK
myCellConstRef.setString("6");               // Compilation Error!
```

You should get into the habit of declaring `const` all methods that don't modify the object so that you can use references to `const` objects in your program.

Note that `const` objects can still be destroyed, and their destructor can be called. Nevertheless, destructors are not allowed to be declared `const`.

mutable Data Members

Sometimes you write a method that is “logically” `const` but happens to change a data member of the object. This modification has no effect on any user-visible data, but is technically a change, so the compiler won’t let you declare the method `const`. For example, suppose that you want to profile your spreadsheet application to obtain information about how often data is being read. A crude way to do this would be to add a counter to the `SpreadsheetCell` class that counts each call to `getValue()` or `getString()`. Unfortunately, that makes those methods non-`const` in the compiler’s eyes, which is not what you intended. The solution is to make your new counter variable `mutable`, which tells the compiler that it’s okay to change it in a `const` method. Here is the new `SpreadsheetCell` class definition:

```
class SpreadsheetCell
{
    // Omitted for brevity
private:
    double mValue = 0;
    mutable size_t mNumAccesses = 0;
};
```

Here are the definitions for `getValue()` and `getString()`:

```
double SpreadsheetCell::getValue() const
{
    mNumAccesses++;
    return mValue;
}

std::string SpreadsheetCell::getString() const
{
    mNumAccesses++;
    return doubleToString(mValue);
}
```

Method Overloading

You’ve already noticed that you can write multiple constructors in a class, all of which have the same name. These constructors differ only in the number and/or types of their parameters. You can do the same thing for any method or function in C++. Specifically, you can *overload* the function or method name by using it for multiple functions, as long as the number and/or types of the parameters differ. For example, in the `SpreadsheetCell` class you can rename both `setString()` and `setValue()` to `set()`. The class definition now looks like this:

```
class SpreadsheetCell
{
public:
    // Omitted for brevity
    void set(double inValue);
    void set(std::string_view inString);
    // Omitted for brevity
};
```

The implementations of the `set()` methods stay the same. When you write code to call `set()`, the compiler determines which instance to call based on the parameter you pass: if you pass a `string_view`, the compiler calls the `string` instance; if you pass a `double`, the compiler calls the `double` instance. This is called *overload resolution*.

You might be tempted to do the same thing for `getValue()` and `getString()`: rename each of them to `get()`. However, that does not work. C++ does not allow you to overload a method name based only on the return type of the method because in many cases it would be impossible for the compiler to determine which instance of the method to call. For example, if the return value of the method is not captured anywhere, the compiler has no way to tell which instance of the method you are trying to call.

Overloading Based on `const`

You can overload a method based on `const`. That is, you can write two methods with the same name and same parameters, one of which is declared `const` and one of which is not. The compiler calls the `const` method if you have a `const` object, and the non-`const` method if you have a non-`const` object.

Often, the implementation of the `const` version and the non-`const` version is identical. To prevent code duplication, you can use the Scott Meyer's `const_cast()` pattern. For example, the `Spreadsheet` class has a method called `getCellAt()` returning a non-`const` reference to a `SpreadsheetCell`. You can add a `const` overload that returns a `const` reference to a `SpreadsheetCell` as follows:

```
class Spreadsheet
{
public:
    SpreadsheetCell& getCellAt(size_t x, size_t y);
    const SpreadsheetCell& getCellAt(size_t x, size_t y) const;
    // Code omitted for brevity.
};
```

Scott Meyer's `const_cast()` pattern says that you should implement the `const` version as you normally would, and implement the non-`const` version by forwarding the call to the `const` version with the appropriate casts. Basically, you cast `*this` to a `const Spreadsheet&` using `std::as_const()` (defined in `<utility>`), call the `const` version of `getCellAt()`, and then remove the `const` from the result by using a `const_cast()`:

```
const SpreadsheetCell& Spreadsheet::getCellAt(size_t x, size_t y) const
{
    verifyCoordinate(x, y);
    return mCells[x][y];
}

SpreadsheetCell& Spreadsheet::getCellAt(size_t x, size_t y)
{
    return const_cast<SpreadsheetCell&>(std::as_const(*this).getCellAt(x, y));
}
```

The `std::as_const()` function is available since C++17. If your compiler doesn't support it yet, you can use the following `static_cast()` instead:

```
return const_cast<SpreadsheetCell&>(
    static_cast<const Spreadsheet&>(*this).getCellAt(x, y));
```

With these two `getCellAt()` overloads, you can now call `getCellAt()` on `const` and non-`const` `Spreadsheet` objects:

```
Spreadsheet sheet1(5, 6);
SpreadsheetCell& cell1 = sheet1.getCellAt(1, 1);

const Spreadsheet sheet2(5, 6);
const SpreadsheetCell& cell2 = sheet2.getCellAt(1, 1);
```

In this case, the `const` version of `getCellAt()` is not doing much, so you don't win a lot by using the `const_cast()` pattern. However, imagine that the `const` version of `getCellAt()` is doing more work, then forwarding the non-`const` to the `const` version avoids duplicating that code.

Explicitly Deleting Overloads

Overloaded methods can be explicitly deleted, which enables you to disallow calling a method with particular arguments. For example, suppose you have the following class:

```
class MyClass
{
public:
    void foo(int i);
};
```

The `foo()` method can be called as follows:

```
MyClass c;
c.foo(123);
c.foo(1.23);
```

For the third line, the compiler converts the `double` value (1.23) to an integer value (1) and then calls `foo(int i)`. The compiler might give you a warning, but it will perform this implicit conversion. You can prevent the compiler from performing this conversion by explicitly deleting a `double` instance of `foo()`:

```
class MyClass
{
public:
    void foo(int i);
    void foo(double d) = delete;
};
```

With this change, an attempt to call `foo()` with a `double` will be flagged as an error by the compiler, instead of the compiler performing a conversion to an integer.

Inline Methods

C++ gives you the ability to recommend that a call to a method (or function) should not actually be implemented in the generated code as a call to a separate block of code. Instead, the compiler should insert the method's body directly into the code where the method is called. This process is called

inlining, and methods that want this behavior are called `inline` methods. Inlining is safer than using `#define` macros.

You can specify an `inline` method by placing the `inline` keyword in front of its name in the method definition. For example, you might want to make the accessor methods of the `SpreadsheetCell` class `inline`, in which case you would define them like this:

```
inline double SpreadsheetCell::getValue() const
{
    mNumAccesses++;
    return mValue;
}

inline std::string SpreadsheetCell::getString() const
{
    mNumAccesses++;
    return doubleToString(mValue);
}
```

This gives a hint to the compiler to replace calls to `getValue()` and `getString()` with the actual method body instead of generating code to make a function call. Note that the `inline` keyword is just a hint for the compiler. The compiler can ignore it if it thinks it would hurt performance.

There is one caveat: definitions of `inline` methods (and functions) must be available in every source file in which they are called. That makes sense if you think about it: how can the compiler substitute the method's body if it can't see the method definition? Thus, if you write `inline` methods, you should place the definitions in a header file along with their prototypes.

NOTE *Advanced C++ compilers do not require you to put definitions of `inline` methods in a header file. For example, Microsoft Visual C++ supports Link-Time Code Generation (LTCG), which automatically inlines small function bodies, even if they are not declared as `inline` and even if they are not defined in a header file. GCC and Clang have similar features. When you use such a compiler, make use of it, and don't put the definitions in the header file. This way, your interface files stay clean without any visible implementation details.*

C++ provides an alternate syntax for declaring `inline` methods that doesn't use the `inline` keyword at all. Instead, you place the method definition directly in the class definition. Here is a `SpreadsheetCell` class definition with this syntax:

```
class SpreadsheetCell
{
public:
    // Omitted for brevity
    double getValue() const { mNumAccesses++; return mValue; }

    std::string getString() const
    {
```

```

        mNumAccesses++;
        return doubleToString(mValue);
    }
    // Omitted for brevity
};

```

NOTE *If you single-step with a debugger on a function call that is inlined, some advanced C++ debuggers will jump to the actual source code of the inline function, giving you the illusion of a function call when in reality, the code is inlined.*

Many C++ programmers discover the `inline` method syntax and employ it without understanding the ramifications of marking a method `inline`. Marking a method or function as `inline` only gives a hint to the compiler. Compilers will only inline the simplest methods and functions. If you define an `inline` method that the compiler doesn't want to inline, it will silently ignore the hint. Modern compilers will take metrics like code bloat into account before deciding to inline a method or function, and they will not inline anything that is not cost-effective.

Default Arguments

A feature similar to method overloading in C++ is *default arguments*. You can specify defaults for function and method parameters in the prototype. If the user specifies those arguments, the default values are ignored. If the user omits those arguments, the default values are used. There is a limitation, though: you can only provide defaults for a continuous list of parameters starting from the *rightmost parameter*. Otherwise, the compiler will not be able to match missing arguments to default arguments. Default arguments can be used in functions, methods, and constructors. For example, you can assign default values to the width and height in your `Spreadsheet` constructor:

```

class Spreadsheet
{
    public:
        Spreadsheet(size_t width = 100, size_t height = 100);
        // Omitted for brevity
};

```

The implementation of the `Spreadsheet` constructor stays the same. Note that you specify the default arguments only in the method declaration, but not in the definition.

Now you can call the `Spreadsheet` constructor with zero, one, or two, arguments even though there is only one non-copy constructor:

```

Spreadsheet s1;
Spreadsheet s2(5);
Spreadsheet s3(5, 6);

```

A constructor with defaults for all its parameters can function as a default constructor. That is, you can construct an object of that class without specifying any arguments. If you try to declare both a default constructor and a multi-argument constructor with defaults for all its parameters, the compiler will complain because it won't know which constructor to call if you don't specify any arguments.

Note that anything you can do with default arguments you can do with method overloading. You could write three different constructors, each of which takes a different number of parameters. However, default arguments allow you to write just one constructor that can take three different number of arguments. You should use the mechanism with which you are most comfortable.

DIFFERENT KINDS OF DATA MEMBERS

C++ gives you many choices for data members. In addition to declaring simple data members in your classes, you can create `static` data members that all objects of the class share, `const` members, reference members, `const` reference members, and more. This section explains the intricacies of these different kinds of data members.

static Data Members

Sometimes giving each object of a class a copy of a variable is overkill or won't work. The data member might be specific to the class, but not appropriate for each object to have its own copy. For example, you might want to give each spreadsheet a unique numerical identifier. You would need a counter that starts at 0 from which each new object could obtain its ID. This spreadsheet counter really belongs to the `Spreadsheet` class, but it doesn't make sense for each `Spreadsheet` object to have a copy of it because you would have to keep all the counters synchronized somehow. C++ provides a solution with *static data members*. A `static` data member is a data member associated with a class instead of an object. You can think of `static` data members as global variables specific to a class. Here is the `Spreadsheet` class definition, including the new `static` counter data member:

```
class Spreadsheet
{
    // Omitted for brevity
private:
    static size_t sCounter;
};
```

In addition to listing `static` class members in the class definition, you will have to allocate space for them in a source file, usually the source file in which you place your class method definitions. You can initialize them at the same time, but note that unlike normal variables and data members, they are initialized to 0 by default. Static pointers are initialized to `nullptr`. Here is the code to allocate space for, and zero-initialize, the `sCounter` member:

```
size_t Spreadsheet::sCounter;
```

Static data members are zero-initialized by default, but if you want, you can explicitly initialize them to 0 as follows:

```
size_t Spreadsheet::sCounter = 0;
```

This code appears outside of any function or method bodies. It's almost like declaring a global variable, except that the `Spreadsheet::` scope resolution specifies that it's part of the `Spreadsheet` class.

C++17

Inline Variables

Starting with C++17, you can declare your static data members as *inline*. The benefit of this is that you do not have to allocate space for them in a source file. Here's an example:

```
class Spreadsheet
{
    // Omitted for brevity
private:
    static inline size_t sCounter = 0;
};
```

Note the `inline` keyword. With this class definition, the following line can be removed from the source file:

```
size_t Spreadsheet::sCounter;
```

Accessing static Data Members within Class Methods

You can use `static` data members as if they were regular data members from within class methods. For example, you might want to create an `mId` data member for the `Spreadsheet` class and initialize it from `sCounter` in the `Spreadsheet` constructor. Here is the `Spreadsheet` class definition with an `mId` member:

```
class Spreadsheet
{
public:
    // Omitted for brevity
    size_t getId() const;
private:
    // Omitted for brevity
    static size_t sCounter;
    size_t mId = 0;
};
```

Here is an implementation of the `Spreadsheet` constructor that assigns the initial ID:

```
Spreadsheet::Spreadsheet(size_t width, size_t height)
    : mId(sCounter++), mWidth(width), mHeight(height)
{
    mCells = new SpreadsheetCell*[mWidth];
    for (size_t i = 0; i < mWidth; i++) {
        mCells[i] = new SpreadsheetCell[mHeight];
    }
}
```

As you can see, the constructor can access `sCounter` as if it were a normal member. The copy constructor should also assign a new ID. This is handled automatically because the `Spreadsheet` copy constructor delegates to the non-copy constructor, which creates the new ID.

You should not copy the ID in the copy assignment operator. Once an ID is assigned to an object, it should never change. Thus, it's recommended to make `mId` a `const` data member. `const` data members are discussed later in this chapter.

Accessing static Data Members Outside Methods

Access control specifiers apply to `static` data members: `sCounter` is `private`, so it cannot be accessed from outside class methods. If `sCounter` was `public`, you could access it from outside class methods by specifying that the variable is part of the `Spreadsheet` class with the `::` scope resolution operator:

```
int c = Spreadsheet::sCounter;
```

However, it's not recommended to have `public` data members (`const static` members discussed in the next section are an exception). You should grant access through `public` `get/set` methods. If you want to grant access to a `static` data member, you need to implement `static` `get/set` methods.

const static Data Members

Data members in your class can be declared `const`, meaning they can't be changed after they are created and initialized. You should use `static const` (or `const static`) data members in place of global constants when the constants apply only to the class, also called *class constants*. `static const` data members of integral and enumeration types can be defined and initialized inside the class definition without making them inline variables. For example, you might want to specify a maximum height and width for spreadsheets. If the user tries to construct a spreadsheet with a greater height or width than the maximum, the maximum is used instead. You can make the maximum height and width `static const` members of the `Spreadsheet` class:

```
class Spreadsheet
{
    public:
        // Omitted for brevity
        static const size_t kMaxHeight = 100;
        static const size_t kMaxWidth = 100;
};
```

You can use these new constants in your constructor as follows:

```
Spreadsheet::Spreadsheet(size_t width, size_t height)
    : mId(sCounter++)
    , mWidth(std::min(width, kMaxWidth)) // std::min() requires <algorithm>
    , mHeight(std::min(height, kMaxHeight))
{
    mCells = new SpreadsheetCell*[mWidth];
    for (size_t i = 0; i < mWidth; i++) {
        mCells[i] = new SpreadsheetCell[mHeight];
    }
}
```

NOTE *Instead of automatically clamping the width and height to their maximum, you could also decide to throw an exception when the width or height exceed their maximum. However, the destructor will not be called when you throw an exception from a constructor, so you need to be careful with this. This is further explained in Chapter 14.*

NOTE *Non-static data members can also be declared `const`. For example, the `mId` data member could be declared as `const`. Because you cannot assign to `const` data members, you need to initialize them with in-class initializers or with `ctor-initializers`. Depending on your use case, this might mean that an assignment operator cannot be provided for your class with non-static `const` data members. If that's the case, the assignment operator is typically marked as `deleted`.*

`kMaxHeight` and `kMaxWidth` are public, so you can access them from anywhere in your program as if they were global variables, but with slightly different syntax. You must specify that the variable is part of the `Spreadsheet` class with the `::` scope resolution operator:

```
cout << "Maximum height is: " << Spreadsheet::kMaxHeight << endl;
```

These constants can also be used as default values for the constructor parameters. Remember that you can only give default values for a continuous set of parameters starting with the rightmost parameter:

```
class Spreadsheet
{
public:
    Spreadsheet(size_t width = kMaxWidth, size_t height = kMaxHeight);
    // Omitted for brevity
};
```

Reference Data Members

`Spreadsheets` and `SpreadsheetCells` are great, but they don't make a very useful application by themselves. You need code to control the entire spreadsheet program, which you could package into a `SpreadsheetApplication` class.

The implementation of this class is unimportant at the moment. For now, consider this architecture problem: how can spreadsheets communicate with the application? The application stores a list of spreadsheets, so it can communicate with the spreadsheets. Similarly, each spreadsheet could store a reference to the application object. The `Spreadsheet` class must then know about the `SpreadsheetApplication` class, and the `SpreadsheetApplication` class must know about the `Spreadsheet` class. This is a circular reference and cannot be solved with normal `#includes`. The solution is to use a *forward declaration* in one of the header files. The following is a new `Spreadsheet` class definition that uses a forward declaration to tell the compiler about the `SpreadsheetApplication` class. Chapter 11 explains another benefit of forward declarations: they can improve compilation and linking times.

```
class SpreadsheetApplication; // forward declaration

class Spreadsheet
{
public:
    Spreadsheet(size_t width, size_t height,
                SpreadsheetApplication& theApp);
```

```

        // Code omitted for brevity.
private:
        // Code omitted for brevity.
        SpreadsheetApplication& mTheApp;
};

```

This definition adds a `SpreadsheetApplication` reference as a data member. It's recommended to use a reference in this case instead of a pointer because a `Spreadsheet` should always refer to a `SpreadsheetApplication`. This would not be guaranteed with a pointer.

Note that storing a reference to the application is only done to demonstrate the use of references as data members. It's not recommended to couple the `Spreadsheet` and `SpreadsheetApplication` classes together in this way, but instead to use a paradigm such as MVC (Model-View-Controller), introduced in Chapter 4.

The application reference is given to each `Spreadsheet` in its constructor. A reference cannot exist without referring to something, so `mTheApp` must be given a value in the ctor-initializer of the constructor:

```

Spreadsheet::Spreadsheet(size_t width, size_t height,
    SpreadsheetApplication& theApp)
    : mId(sCounter++)
    , mWidth(std::min(width, kMaxWidth))
    , mHeight(std::min(height, kMaxHeight))
    , mTheApp(theApp)
{
    // Code omitted for brevity.
}

```

You must also initialize the reference member in the copy constructor. This is handled automatically because the `Spreadsheet` copy constructor delegates to the non-copy constructor, which initializes the reference member.

Remember that after you have initialized a reference, you cannot change the object to which it refers. It's not possible to assign to references in the assignment operator. Depending on your use case, this might mean that an assignment operator cannot be provided for your class with reference data members. If that's the case, the assignment operator is typically marked as deleted.

const Reference Data Members

Your reference members can refer to `const` objects just as normal references can refer to `const` objects. For example, you might decide that `Spreadsheets` should only have a `const` reference to the application object. You can simply change the class definition to declare `mTheApp` as a `const` reference:

```

class Spreadsheet
{
public:
    Spreadsheet(size_t width, size_t height,
        const SpreadsheetApplication& theApp);

```

```

        // Code omitted for brevity.
private:
        // Code omitted for brevity.
        const SpreadsheetApplication& mTheApp;
};

```

There is an important difference between using a `const` reference versus a non-`const` reference. The `const` reference `SpreadsheetApplication` data member can only be used to call `const` methods on the `SpreadsheetApplication` object. If you try to call a non-`const` method through a `const` reference, you will get a compilation error.

It's also possible to have a `static` reference member or a `static const` reference member, but you will rarely need something like that.

NESTED CLASSES

Class definitions can contain more than just member functions and data members. You can also write nested classes and `structs`, declare type aliases, or create enumerated types. Anything declared inside a class is in the scope of that class. If it is `public`, you can access it outside the class by scoping it with the `ClassName::` scope resolution syntax.

You can provide a class definition inside another class definition. For example, you might decide that the `SpreadsheetCell` class is really part of the `Spreadsheet` class. And since it becomes part of the `Spreadsheet` class, you might as well rename it to `Cell`. You could define both of them like this:

```

class Spreadsheet
{
    public:
        class Cell
        {
            public:
                Cell() = default;
                Cell(double initialValue);
                // Omitted for brevity
        };

        Spreadsheet(size_t width, size_t height,
                    const SpreadsheetApplication& theApp);
        // Remainder of Spreadsheet declarations omitted for brevity
};

```

Now, the `Cell` class is defined inside the `Spreadsheet` class, so anywhere you refer to a `Cell` outside of the `Spreadsheet` class, you must qualify the name with the `Spreadsheet::` scope. This applies even to the method definitions. For example, the `double` constructor of `Cell` now looks like this:

```

Spreadsheet::Cell::Cell(double initialValue)
    : mValue(initialValue)
{
}

```

You must even use the syntax for return types (but not parameters) of methods in the `Spreadsheet` class itself:

```
Spreadsheet::Cell& Spreadsheet::getCellAt(size_t x, size_t y)
{
    verifyCoordinate(x, y);
    return mCells[x][y];
}
```

Fully defining the nested `Cell` class directly inside the `Spreadsheet` class makes the definition of the `Spreadsheet` class a bit bloated. You can alleviate this by only including a forward declaration for `Cell` in the `Spreadsheet` class, and then defining the `Cell` class separately, as follows:

```
class Spreadsheet
{
public:
    class Cell;

    Spreadsheet(size_t width, size_t height,
                const SpreadsheetApplication& theApp);
    // Remainder of Spreadsheet declarations omitted for brevity
};

class Spreadsheet::Cell
{
public:
    Cell() = default;
    Cell(double initialValue);
    // Omitted for brevity
};
```

Normal access control applies to nested class definitions. If you declare a `private` or `protected` nested class, you can only use it inside the outer class. A nested class has access to all `protected` and `private` members of the outer class. The outer class on the other hand can only access `public` members of the nested class.

ENUMERATED TYPES INSIDE CLASSES

If you want to define a number of constants inside a class, you should use an enumerated type instead of a collection of `#defines`. For example, you can add support for cell coloring to the `SpreadsheetCell` class as follows:

```
class SpreadsheetCell
{
public:
    // Omitted for brevity
    enum class Color { Red = 1, Green, Blue, Yellow };
    void setColor(Color color);
    Color getColor() const;
private:
    // Omitted for brevity
    Color mColor = Color::Red;
};
```

The implementation of the `setColor()` and `getColor()` methods is straightforward:

```
void SpreadsheetCell::setColor(Color color) { mColor = color; }

SpreadsheetCell::Color SpreadsheetCell::getColor() const { return mColor; }
```

The new methods can be used as follows:

```
SpreadsheetCell myCell(5);
myCell.setColor(SpreadsheetCell::Color::Blue);
auto color = myCell.getColor();
```

OPERATOR OVERLOADING

You often want to perform operations on objects, such as adding them, comparing them, or streaming them to or from files. For example, spreadsheets are really only useful when you can perform arithmetic actions on them, such as summing an entire row of cells.

Example: Implementing Addition for SpreadsheetCells

In true object-oriented fashion, `SpreadsheetCell` objects should be able to add themselves to other `SpreadsheetCell` objects. Adding a cell to another cell produces a third cell with the result. It doesn't change either of the original cells. The meaning of addition for `SpreadsheetCells` is the addition of the values of the cells.

First Attempt: The add Method

You can declare and define an `add()` method for your `SpreadsheetCell` class like this:

```
class SpreadsheetCell
{
public:
    // Omitted for brevity
    SpreadsheetCell add(const SpreadsheetCell& cell) const;
    // Omitted for brevity
};
```

This method adds two cells together, returning a new third cell whose value is the sum of the first two. It is declared `const` and takes a reference to a `const SpreadsheetCell` because `add()` does not change either of the source cells. Here is the implementation:

```
SpreadsheetCell SpreadsheetCell::add(const SpreadsheetCell& cell) const
{
    return SpreadsheetCell(getValue() + cell.getValue());
}
```

You can use the `add()` method like this:

```
SpreadsheetCell myCell(4), anotherCell(5);
SpreadsheetCell aThirdCell = myCell.add(anotherCell);
```

That works, but it's a bit clumsy. You can do better.

Second Attempt: Overloaded operator+ as a Method

It would be convenient to be able to add two cells with the plus sign the way that you add two ints or two doubles—something like this:

```
SpreadsheetCell myCell(4), anotherCell(5);
SpreadsheetCell aThirdCell = myCell + anotherCell;
```

C++ allows you to write your own version of the plus sign, called the *addition operator*, to work correctly with your classes. To do that, you write a method with the name `operator+` that looks like this:

```
class SpreadsheetCell
{
public:
    // Omitted for brevity
    SpreadsheetCell operator+(const SpreadsheetCell& cell) const;
    // Omitted for brevity
};
```

NOTE *You are allowed to write spaces between operator and the plus sign. For example, instead of writing `operator+`, you can write `operator +`. This is true for all operators. This book adopts the style without spaces.*

The definition of the method is identical to the implementation of the `add()` method:

```
SpreadsheetCell SpreadsheetCell::operator+(const SpreadsheetCell& cell) const
{
    return SpreadsheetCell(getValue() + cell.getValue());
}
```

Now you can add two cells together using the plus sign as shown previously.

This syntax takes a bit of getting used to. Try not to worry too much about the strange method name `operator+`—it’s just a name like `foo` or `add`. In order to understand the rest of the syntax, it helps to understand what’s really going on. When your C++ compiler parses a program and encounters an operator, such as `+`, `-`, `=`, or `<<`, it tries to find a function or method with the name `operator+`, `operator-`, `operator=`, or `operator<<`, respectively, that takes the appropriate parameters. For example, when the compiler sees the following line, it tries to find either a method in the `SpreadsheetCell` class named `operator+` that takes another `SpreadsheetCell` object, or a global function named `operator+` that takes two `SpreadsheetCell` objects:

```
SpreadsheetCell aThirdCell = myCell + anotherCell;
```

If the `SpreadsheetCell` class contains an `operator+` method, then the previous line is translated to this:

```
SpreadsheetCell aThirdCell = myCell.operator+(anotherCell);
```

Note that there’s no requirement that `operator+` takes as a parameter an object of the same type as the class for which it’s written. You could write an `operator+` for `SpreadsheetCells` that takes a

Spreadsheet to add to the SpreadsheetCell. That wouldn't make sense to the programmer, but the compiler would allow it.

Note also that you can give operator+ any return value you want. Operator overloading is a form of function overloading, and recall that function overloading does not look at the return type of the function.

Implicit Conversions

Surprisingly, once you've written the operator+ shown earlier, not only can you add two cells together, but you can also add a cell to a string_view, a double, or an int!

```
SpreadsheetCell myCell(4), aThirdCell;
string str = "hello";
aThirdCell = myCell + string_view(str);
aThirdCell = myCell + 5.6;
aThirdCell = myCell + 4;
```

The reason this code works is that the compiler does more to try to find an appropriate operator+ than just look for one with the exact types specified. The compiler also tries to find an appropriate conversion for the types so that an operator+ can be found. Constructors that take the type in question are appropriate converters. In the preceding example, when the compiler sees a SpreadsheetCell trying to add itself to double, it finds the SpreadsheetCell constructor that takes a double and constructs a temporary SpreadsheetCell object to pass to operator+. Similarly, when the compiler sees the line trying to add a SpreadsheetCell to a string_view, it calls the string_view SpreadsheetCell constructor to create a temporary SpreadsheetCell to pass to operator+.

This implicit conversion behavior is usually convenient. However, in the preceding example, it doesn't really make sense to add a string_view to a SpreadsheetCell. You can prevent the implicit construction of a SpreadsheetCell from a string_view by marking that constructor with the explicit keyword:

```
class SpreadsheetCell
{
public:
    SpreadsheetCell() = default;
    SpreadsheetCell(double initialValue);
    explicit SpreadsheetCell(std::string_view initialValue);
    // Remainder omitted for brevity
};
```

The explicit keyword goes only in the class definition, and only makes sense when applied to constructors that can be called with one argument, such as one-parameter constructors or multi-parameter constructors with default values for parameters.

The selection of an implicit constructor might be inefficient, because temporary objects must be created. To avoid implicit construction for adding a double, you could write a second operator+ as follows:

```
SpreadsheetCell SpreadsheetCell::operator+(double rhs) const
{
    return SpreadsheetCell(getValue() + rhs);
}
```

Third Attempt: Global operator+

Implicit conversions allow you to use an `operator+` method to add your `SpreadsheetCell` objects to `ints` and `doubles`. However, the operator is not commutative, as shown in the following code:

```
aThirdCell = myCell + 4;    // Works fine.
aThirdCell = myCell + 5.6; // Works fine.
aThirdCell = 4 + myCell;   // FAILS TO COMPILE!
aThirdCell = 5.6 + myCell; // FAILS TO COMPILE!
```

The implicit conversion works fine when the `SpreadsheetCell` object is on the left of the operator, but it doesn't work when it's on the right. Addition is supposed to be commutative, so something is wrong here. The problem is that the `operator+` method must be called on a `SpreadsheetCell` object, and that object must be on the left-hand side of the `operator+`. That's just the way the C++ language is defined. So, there's no way you can get this code to work with an `operator+` method.

However, you can get it to work if you replace the in-class `operator+` method with a global `operator+` function that is not tied to any particular object. The function looks like this:

```
SpreadsheetCell operator+(const SpreadsheetCell& lhs,
                          const SpreadsheetCell& rhs)
{
    return SpreadsheetCell(lhs.getValue() + rhs.getValue());
}
```

You need to declare the operator in the header file:

```
class SpreadsheetCell
{
    //Omitted for brevity
};

SpreadsheetCell operator+(const SpreadsheetCell& lhs,
                          const SpreadsheetCell& rhs);
```

Now all four of the addition lines work as you expect:

```
aThirdCell = myCell + 4;    // Works fine.
aThirdCell = myCell + 5.6; // Works fine.
aThirdCell = 4 + myCell;   // Works fine.
aThirdCell = 5.6 + myCell; // Works fine.
```

You might be wondering what happens if you write the following code:

```
aThirdCell = 4.5 + 5.5;
```

It compiles and runs, but it's not calling the `operator+` you wrote. It does normal `double` addition of 4.5 and 5.5, which results in the following intermediate statement:

```
aThirdCell = 10;
```

To make this assignment work, there should be a `SpreadsheetCell` object on the right-hand side. The compiler will discover a non-explicit user-defined constructor that takes a `double`, will use this constructor to implicitly convert the `double` value into a temporary `SpreadsheetCell` object, and will then call the assignment operator.

NOTE In C++, you cannot change the precedence of operators. For example, `*` and `/` are always evaluated before `+` and `-`. The only thing user-defined operators can do is specify the implementation once the precedence of operations has been determined. C++ also does not allow you to invent new operator symbols, or to change the number of arguments for operators.

Overloading Arithmetic Operators

Now that you understand how to write `operator+`, the rest of the basic arithmetic operators are straightforward. Here are the declarations of `+`, `-`, `*`, and `/`, where you have to replace `<op>` with `+`, `-`, `*`, and `/`, resulting in four functions. You can also overload `%`, but it doesn't make sense for the double values stored in `SpreadsheetCells`.

```
class SpreadsheetCell
{
    // Omitted for brevity
};

SpreadsheetCell operator<op>(const SpreadsheetCell& lhs,
    const SpreadsheetCell& rhs);
```

The implementations of `operator-` and `operator*` are very similar to the implementation of `operator+`, so these are not shown. For `operator/`, the only tricky aspect is remembering to check for division by zero. This implementation throws an exception if division by zero is detected:

```
SpreadsheetCell operator/(const SpreadsheetCell& lhs,
    const SpreadsheetCell& rhs)
{
    if (rhs.getValue() == 0) {
        throw invalid_argument("Divide by zero.");
    }
    return SpreadsheetCell(lhs.getValue() / rhs.getValue());
}
```

C++ does not require you to actually implement multiplication in `operator*`, division in `operator/`, and so on. You could implement multiplication in `operator/`, division in `operator+`, and so forth. However, that would be extremely confusing, and there is no good reason to do so except as a practical joke. Whenever possible, stick to the commonly used operator meanings in your implementations.

Overloading the Arithmetic Shorthand Operators

In addition to the basic arithmetic operators, C++ provides shorthand operators such as `+=` and `-=`. You might assume that writing `operator+` for your class also provides `operator+=`. No such luck. You have to overload the shorthand arithmetic operators explicitly. These operators differ from the basic arithmetic operators in that they change the object on the left-hand side of the operator instead of creating a new object. A second, subtler difference is that, like the assignment operator, they generate a result that is a reference to the modified object.

The arithmetic shorthand operators always require an object on the left-hand side, so you should write them as methods, not as global functions. Here are the declarations for the `SpreadsheetCell` class:

```
class SpreadsheetCell
{
    public:
        // Omitted for brevity
        SpreadsheetCell& operator+=(const SpreadsheetCell& rhs);
        SpreadsheetCell& operator-=(const SpreadsheetCell& rhs);
        SpreadsheetCell& operator*=(const SpreadsheetCell& rhs);
        SpreadsheetCell& operator/=(const SpreadsheetCell& rhs);
        // Omitted for brevity
};
```

Here is the implementation for `operator+=`. The others are very similar.

```
SpreadsheetCell& SpreadsheetCell::operator+=(const SpreadsheetCell& rhs)
{
    set(getValue() + rhs.getValue());
    return *this;
}
```

The shorthand arithmetic operators are combinations of the basic arithmetic and assignment operators. With the previous definitions, you can now write code like this:

```
SpreadsheetCell myCell(4), aThirdCell(2);
aThirdCell -= myCell;
aThirdCell += 5.4;
```

You cannot, however, write code like this (which is a good thing!):

```
5.4 += aThirdCell;
```

When you have both a normal and a shorthand version of a certain operator, it's recommended to implement the normal one in terms of the shorthand version to avoid code duplication. For example:

```
SpreadsheetCell operator+(const SpreadsheetCell& lhs, const SpreadsheetCell& rhs)
{
    auto result(lhs); // Local copy
    result += rhs;    // Forward to op=() version
    return result;
}
```

Overloading Comparison Operators

The comparison operators, such as `>`, `<`, and `==`, are another useful set of operators to define for your classes. Like the basic arithmetic operators, they should be global functions so that you can use implicit conversion on both the left-hand side and the right-hand side of the operator. The comparison operators all return a `bool`. Of course, you can change the return type, but that's not recommended.

Here are the declarations, where you have to replace `<op>` with `==`, `<`, `>`, `!=`, `<=`, and `>=`, resulting in six functions:

```
class SpreadsheetCell
{
    // Omitted for brevity
};
```

```
bool operator<op>(const SpreadsheetCell& lhs, const SpreadsheetCell& rhs);
```

Here is the definition of `operator==`. The others are very similar.

```
bool operator==(const SpreadsheetCell& lhs, const SpreadsheetCell& rhs)
{
    return (lhs.getValue() == rhs.getValue());
}
```

NOTE *The preceding overloaded comparison operators are using `getValue()`, which returns a `double`. Most of the time, performing equality or inequality tests on floating point values is not a good idea. You should use an epsilon test, but that falls outside the scope of this book.*

In classes with more data members, it might be painful to compare each data member. However, once you've implemented `==` and `<`, you can write the rest of the comparison operators in terms of those two. For example, here is a definition of `operator>=` that uses `operator<`:

```
bool operator>=(const SpreadsheetCell& lhs, const SpreadsheetCell& rhs)
{
    return !(lhs < rhs);
}
```

You can use these operators to compare `SpreadsheetCells` to other `SpreadsheetCells`, and also to `doubles` and `ints`:

```
if (myCell > aThirdCell || myCell < 10) {
    cout << myCell.getValue() << endl;
}
```

Building Types with Operator Overloading

Many people find the syntax of operator overloading tricky and confusing, at least at first. The irony is that it's supposed to make things simpler. As you've discovered, that doesn't mean simpler for the person writing the class, but simpler for the person using the class. The point is to make your new classes as similar as possible to built-in types such as `int` and `double`: it's easier to add objects using `+` than to remember whether the method name you should call is `add()` or `sum()`.

NOTE *Provide operator overloading as a service to clients of your class.*

At this point, you might be wondering exactly which operators you can overload. The answer is almost all of them—even some you've never heard of. You have actually just scratched the surface: you've seen the assignment operator in the section on object life cycles, the basic arithmetic operators, the shorthand arithmetic operators, and the comparison operators. Overloading the stream insertion and extraction operators is also useful. In addition, there are some tricky, but

interesting, things you can do with operator overloading that you might not anticipate at first. The Standard Library uses operator overloading extensively. Chapter 15 explains how and when to overload the rest of the operators. Chapters 16 to 20 cover the Standard Library.

BUILDING STABLE INTERFACES

Now that you understand all the gory syntax of writing classes in C++, it helps to revisit the design principles from Chapters 5 and 6. Classes are the main unit of abstraction in C++. You should apply the principles of abstraction to your classes to separate the interface from the implementation as much as possible. Specifically, you should make all data members private and provide getter and setter methods for them. This is how the `SpreadsheetCell` class is implemented. `mValue` is private; `set()` sets this value, while `getValue()` and `getString()` retrieve the value.

Using Interface and Implementation Classes

Even with the preceding measures and the best design principles, the C++ language is fundamentally unfriendly to the principle of abstraction. The syntax requires you to combine your `public` interfaces and `private` (or `protected`) data members and methods together in one class definition, thereby exposing some of the internal implementation details of the class to its clients. The downside of this is that if you have to add new non-`public` methods or data members to your class, all the clients of the class have to be recompiled. This can become a burden in bigger projects.

The good news is that you can make your interfaces a lot cleaner and hide all implementation details, resulting in stable interfaces. The bad news is that it takes a bit of coding. The basic principle is to define two classes for every class you want to write: the *interface class* and the *implementation class*. The implementation class is identical to the class you would have written if you were not taking this approach. The interface class presents `public` methods identical to those of the implementation class, but it only has one data member: a pointer to an implementation class object. This is called the *pimpl idiom*, *private implementation idiom*, or *bridge pattern*. The interface class method implementations simply call the equivalent methods on the implementation class object. The result of this is that no matter how the implementation changes, it has no impact on the `public` interface class. This reduces the need for recompilation. None of the clients that use the interface class need to be recompiled if the implementation (and only the implementation) changes. Note that this idiom only works if the single data member is a pointer to the implementation class. If it were a by-value data member, the clients would have to be recompiled when the definition of the implementation class changes.

To use this approach with the `Spreadsheet` class, define a public interface class, `Spreadsheet`, that looks like this:

```
#include "SpreadsheetCell.h"
#include <memory>

// Forward declarations
class SpreadsheetApplication;
```

```

class Spreadsheet
{
public:
    Spreadsheet(const SpreadsheetApplication& theApp,
               size_t width = kMaxWidth, size_t height = kMaxHeight);
    Spreadsheet(const Spreadsheet& src);
    ~Spreadsheet();

    Spreadsheet& operator=(const Spreadsheet& rhs);

    void setCellAt(size_t x, size_t y, const SpreadsheetCell& cell);
    SpreadsheetCell& getCellAt(size_t x, size_t y);

    size_t getId() const;

    static const size_t kMaxHeight = 100;
    static const size_t kMaxWidth = 100;

    friend void swap(Spreadsheet& first, Spreadsheet& second) noexcept;

private:
    class Impl;
    std::unique_ptr<Impl> mImpl;
};

```

The implementation class, `Impl`, is a private nested class, because no one else besides the `Spreadsheet` class needs to know about the implementation class. The `Spreadsheet` class now contains only one data member: a pointer to an `Impl` instance. The `public` methods are identical to the old `Spreadsheet`.

The nested `Spreadsheet::Impl` class has almost the same interface as the original `Spreadsheet` class. However, because the `Impl` class is a private nested class of `Spreadsheet`, you cannot have the following global `swap()` function that swaps two `Spreadsheet::Impl` objects:

```
friend void swap(Spreadsheet::Impl& first, Spreadsheet::Impl& second) noexcept;
```

Instead, a private `swap()` method is defined for the `Spreadsheet::Impl` class as follows:

```
void swap(Impl& other) noexcept;
```

The implementation is straightforward, but you need to remember that this is a nested class, so you need to specify `Spreadsheet::Impl::swap()` instead of just `Impl::swap()`. The same holds true for the other members. For details, see the section on nested classes earlier in this chapter. Here is the `swap()` method:

```

void Spreadsheet::Impl::swap(Impl& other) noexcept
{
    using std::swap;

    swap(mWidth, other.mWidth);
    swap(mHeight, other.mHeight);
    swap(mCells, other.mCells);
}

```

Now that the `Spreadsheet` class has a `unique_ptr` to the implementation class, the `Spreadsheet` class needs to have a user-declared destructor. Since we don't need to do anything in this destructor, it can be defaulted in the implementation file as follows:

```
Spreadsheet::~Spreadsheet() = default;
```

This shows that you can default a special member function not only in the class definition, but also in the implementation file.

The implementations of the `Spreadsheet` methods, such as `setCellAt()` and `getCellAt()`, just pass the request on to the underlying `Impl` object:

```
void Spreadsheet::setCellAt(size_t x, size_t y, const SpreadsheetCell& cell)
{
    mImpl->setCellAt(x, y, cell);
}

SpreadsheetCell& Spreadsheet::getCellAt(size_t x, size_t y)
{
    return mImpl->getCellAt(x, y);
}
```

The constructors for the `Spreadsheet` must construct a new `Impl` to do its work:

```
Spreadsheet::Spreadsheet(const SpreadsheetApplication& theApp,
    size_t width, size_t height)
{
    mImpl = std::make_unique<Impl>(theApp, width, height);
}

Spreadsheet::Spreadsheet(const Spreadsheet& src)
{
    mImpl = std::make_unique<Impl>(*src.mImpl);
}
```

The copy constructor looks a bit strange because it needs to copy the underlying `Impl` from the source spreadsheet. The copy constructor takes a reference to an `Impl`, not a pointer, so you must dereference the `mImpl` pointer to get to the object itself so the constructor call can take its reference.

The `Spreadsheet` assignment operator must similarly pass on the assignment to the underlying `Impl`:

```
Spreadsheet& Spreadsheet::operator=(const Spreadsheet& rhs)
{
    *mImpl = *rhs.mImpl;
    return *this;
}
```

The first line in the assignment operator looks a little odd. The `Spreadsheet` assignment operator needs to forward the call to the `Impl` assignment operator, which only runs when you copy direct objects. By dereferencing the `mImpl` pointers, you force direct object assignment, which causes the assignment operator of `Impl` to be called.

The `swap()` function simply swaps the single data member:

```
void swap(Spreadsheet& first, Spreadsheet& second) noexcept
{
```

```
using std::swap;

swap(first.mImpl, second.mImpl);
}
```

This technique to truly separate interface from implementation is powerful. Although it is a bit clumsy at first, once you get used to it, you will find it natural to work with. However, it's not common practice in most workplace environments, so you might find some resistance to trying it from your coworkers. The most compelling argument in favor of it is not the aesthetic one of splitting out the interface, but the speedup in build time if the implementation of the class changes. When a class is not using the pimpl idiom, a change to its implementation details might trigger a long build. For example, adding a new data member to a class definition triggers a rebuild of all other source files that include this class definition. With the pimpl idiom, you can modify the implementation class definition as much as you like, as long as the public interface class remains untouched, it won't trigger a long build.

NOTE *With stable interface classes, build times can be reduced.*

An alternative to separating the implementation from the interface is to use an abstract interface—that is, an interface with only pure virtual methods—and then have an implementation class that implements that interface. See Chapter 10 for a discussion on abstract interfaces.

SUMMARY

This chapter, along with Chapter 8, provided all the tools you need to write solid, well-designed classes, and to use objects effectively.

You discovered that dynamic memory allocation in objects presents new challenges: you need to implement a destructor, copy constructor, copy assignment operator, move constructor, and move assignment operator, which properly copy, move, and free your memory. You learned how to prevent assignment and pass-by-value by explicitly deleting the copy constructor and assignment operator. You discovered the copy-and-swap idiom to implement copy assignment operators, and learned about the rule of zero.

You read more about different kinds of data members, including `static`, `const`, `const` reference, and `mutable` members. You also learned about `static`, `inline`, and `const` methods, method overloading, and default arguments. This chapter also described nested class definitions, and `friend` classes, functions, and methods.

You encountered operator overloading, and learned how to overload the arithmetic and comparison operators, both as global `friend` functions and as class methods.

Finally, you learned how to take abstraction to the extreme by providing separate interface and implementation classes.

Now that you're fluent in the language of object-oriented programming, it's time to tackle inheritance, which is covered next in Chapter 10.

10

Discovering Inheritance Techniques

WHAT'S IN THIS CHAPTER?

- How to extend a class through inheritance
- How to employ inheritance to reuse code
- How to build interactions between base classes and derived classes
- How to use inheritance to achieve polymorphism
- How to work with multiple inheritance
- How to deal with unusual problems in inheritance

WROX.COM DOWNLOADS FOR THIS CHAPTER

Please note that all the code examples for this chapter are available as a part of this chapter's code download on the book's website at www.wrox.com/go/proc++4e on the Download Code tab.

Without inheritance, classes would simply be data structures with associated behaviors. That alone would be a powerful improvement over procedural languages, but inheritance adds an entirely new dimension. Through inheritance, you can build new classes based on existing ones. In this way, your classes become reusable and extensible components. This chapter teaches you the different ways to leverage the power of inheritance. You will learn about the specific syntax of inheritance as well as sophisticated techniques for making the most of inheritance.

The portion of this chapter relating to polymorphism draws heavily on the spreadsheet example discussed in Chapters 8 and 9. This chapter also refers to the object-oriented methodologies described in Chapter 5. If you have not read that chapter and are unfamiliar with the theories behind inheritance, you should review Chapter 5 before continuing.

BUILDING CLASSES WITH INHERITANCE

In Chapter 5, you learned that an “is-a” relationship recognizes the pattern that real-world objects tend to exist in hierarchies. In programming, that pattern becomes relevant when you need to write a class that builds on, or slightly changes, another class. One way to accomplish this aim is to copy code from one class and paste it into the other. By changing the relevant parts or amending the code, you can achieve the goal of creating a new class that is slightly different from the original. This approach, however, leaves an OOP programmer feeling sullen and highly annoyed for the following reasons:

- A bug fix to the original class will not be reflected in the new class because the two classes contain completely separate code.
- The compiler does not know about any relationship between the two classes, so they are not polymorphic (see Chapter 5)—they are not just different variations on the same thing.
- This approach does not build a true is-a relationship. The new class is very similar to the original because it shares code, not because it really *is* the same type of object.
- The original code might not be obtainable. It may exist only in a precompiled binary format, so copying and pasting the code might be impossible.

Not surprisingly, C++ provides built-in support for defining a true is-a relationship. The characteristics of C++ is-a relationships are described in the following section.

Extending Classes

When you write a class definition in C++, you can tell the compiler that your class is *inheriting from*, *deriving from*, or *extending* an existing class. By doing so, your class automatically contains the data members and methods of the original class, which is called the *parent class* or *base class* or *superclass*. Extending an existing class gives your class (which is now called a *derived class* or a *subclass*) the ability to describe only the ways in which it is different from the parent class.

To extend a class in C++, you specify the class you are extending when you write the class definition. To show the syntax for inheritance, two classes are used, called `Base` and `Derived`. Don't worry—more interesting examples are coming later. To begin, consider the following definition for the `Base` class:

```
class Base
{
    public:
        void someMethod();
    protected:
```

```

        int mProtectedInt;
    private:
        int mPrivateInt;
};

```

If you want to build a new class, called `Derived`, which inherits from `Base`, you tell the compiler that `Derived` derives from `Base` with the following syntax:

```

class Derived : public Base
{
    public:
        void someOtherMethod();
};

```

`Derived` is a full-fledged class that just happens to share the characteristics of the `Base` class. Don't worry about the word `public` for now—its meaning is explained later in this chapter. Figure 10-1 shows the simple relationship between `Derived` and `Base`. You can declare objects of type `Derived` just like any other object. You could even define a third class that inherits from `Derived`, forming a chain of classes, as shown in Figure 10-2.

`Derived` doesn't have to be the only derived class of `Base`. Additional classes can also inherit from `Base`, effectively becoming *siblings* to `Derived`, as shown in Figure 10-3.

A Client's View of Inheritance

To a client, or another part of your code, an object of type `Derived` is also an object of type `Base` because `Derived` inherits from `Base`. This means that all the public methods and data members of `Base` and all the public methods and data members of `Derived` are available.

Code that uses the derived class does not need to know which class in your inheritance chain has defined a method in order to call it. For example, the following code calls two methods of a `Derived` object even though one of the methods is defined by the `Base` class:

```

Derived myDerived;
myDerived.someMethod();
myDerived.someOtherMethod();

```

It is important to understand that inheritance works in only one direction. The `Derived` class has a very clearly defined relationship to the `Base` class, but the `Base` class, as written, doesn't know anything about the `Derived` class. That means that objects of type `Base` do not support public methods and data members of `Derived` because `Base` is *not* a `Derived`.

The following code does not compile because the `Base` class does not contain a public method called `someOtherMethod()`:

```

Base myBase;
myBase.someOtherMethod(); // Error! Base doesn't have a someOtherMethod().

```

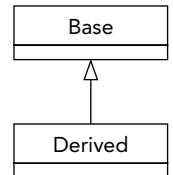

FIGURE 10-1

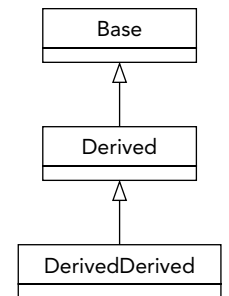

FIGURE 10-2

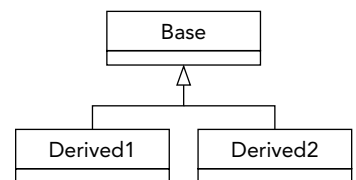

FIGURE 10-3

NOTE *From the perspective of other code, an object belongs to its defined class as well as to any base classes.*

A pointer or reference to an object can refer to an object of the declared class or any of its derived classes. This tricky subject is explained in detail later in this chapter. The concept to understand now is that a pointer to a `Base` can actually be pointing to a `Derived` object. The same is true for a reference. The client can still access only the methods and data members that exist in `Base`, but through this mechanism, any code that operates on a `Base` can also operate on a `Derived`.

For example, the following code compiles and works just fine, even though it initially appears that there is a type mismatch:

```
Base* base = new Derived(); // Create Derived, store it in Base pointer.
```

However, you cannot call methods from the `Derived` class through the `Base` pointer. The following does not work:

```
base->someOtherMethod();
```

This is flagged as an error by the compiler because, although the object is of type `Derived` and therefore does have `someOtherMethod()` defined, the compiler can only think of it as type `Base`, which does not have `someOtherMethod()` defined.

A Derived Class's View of Inheritance

To the derived class, nothing much has changed in terms of how it is written or how it behaves. You can still define methods and data members on a derived class just as you would on a regular class. The previous definition of `Derived` declares a method called `someOtherMethod()`. Thus, the `Derived` class augments the `Base` class by adding an additional method.

A derived class can access `public` and `protected` methods and data members declared in its base class as though they were its own, because technically, they are. For example, the implementation of `someOtherMethod()` on `Derived` could make use of the data member `mProtectedInt`, which is declared as part of `Base`. The following code shows this. Accessing a base class data member or method is no different than if the data member or method were declared as part of the derived class.

```
void Derived::someOtherMethod()
{
    cout << "I can access base class data member mProtectedInt." << endl;
    cout << "Its value is " << mProtectedInt << endl;
}
```

When access specifiers (`public`, `private`, and `protected`) were introduced in Chapter 8, the difference between `private` and `protected` may have been confusing. Now that you understand derived classes, the difference should be clear. If a class declares methods or data members as `protected`, derived classes have access to them. If they are declared as `private`, derived classes do not have access. The following implementation of `someOtherMethod()` does not compile because the derived class attempts to access a `private` data member from the base class.

```
void Derived::someOtherMethod()
{
    cout << "I can access base class data member mProtectedInt." << endl;
```

```

    cout << "Its value is " << mProtectedInt << endl;
    cout << "The value of mPrivateInt is " << mPrivateInt << endl; // Error!
}

```

The `private` access specifier gives you control over how a potential derived class could interact with your class. I recommend that you make all your data members `private` by default. You can provide `public` getters and setters if you want to allow anyone to access those data members, and you can provide `protected` getters and setters if you want only derived classes to access them. The reason to make data members `private` by default is that this provides the highest level of encapsulation. This means that you can change how you represent your data while keeping the `public` and `protected` interfaces unchanged. Without giving direct access to data members, you can also easily add checks on the input data in your `public` and `protected` setters. Methods should also be `private` by default. Only make those methods `public` that are designed to be public, and make methods `protected` if you want only derived classes to have access to them.

NOTE *From the perspective of a derived class, all `public` and `protected` data members and methods from the base class are available for use.*

Preventing Inheritance

C++ allows you to mark a class as `final`, which means trying to inherit from it will result in a compilation error. A class can be marked as `final` with the `final` keyword right behind the name of the class. For example, the following `Base` class is marked as `final`:

```

class Base final
{
    // Omitted for brevity
};

```

If a class tries to inherit from this `Base` class, the compiler will complain because `Base` is marked as `final`.

```

class Derived : public Base
{
    // Omitted for brevity
};

```

Overriding Methods

The main reasons to inherit from a class are to add or replace functionality. The definition of `Derived` adds functionality to its parent class by providing an additional method, `someOtherMethod()`. The other method, `someMethod()`, is inherited from `Base` and behaves in the derived class exactly as it does in the base class. In many cases, you will want to modify the behavior of a class by replacing, or *overriding*, a method.

How I Learned to Stop Worrying and Make Everything virtual

There is one small twist to overriding methods in C++ and it has to do with the keyword `virtual`. Only methods that are declared as `virtual` in the base class can be overridden properly by

derived classes. The keyword goes at the beginning of a method declaration as shown in the modified version of `Base` that follows:

```
class Base
{
    public:
        virtual void someMethod();
    protected:
        int mProtectedInt;
    private:
        int mPrivateInt;
};
```

The `virtual` keyword has a few subtleties. A good rule of thumb is to just make all of your methods `virtual`. That way, you won't have to worry about whether or not overriding the method will work. The only drawback is a very tiny performance hit. The subtleties of the `virtual` keyword are covered in the section "The Truth about `virtual`."

The same holds for the `Derived` class. Its methods should also be marked `virtual`:

```
class Derived : public Base
{
    public:
        virtual void someOtherMethod();
};
```

NOTE *As a rule of thumb, make all your methods `virtual` (including the destructor, but not constructors) to avoid problems associated with omission of the `virtual` keyword. Note that the compiler-generated destructor is not `virtual`!*

Syntax for Overriding a Method

To override a method, you redeclare it in the derived class definition exactly as it was declared in the base class, and you add the `override` keyword. In the derived class's implementation file, you provide the new definition.

For example, the `Base` class contains a method called `someMethod()`. The definition of `someMethod()` is provided in `Base.cpp` and is shown here:

```
void Base::someMethod()
{
    cout << "This is Base's version of someMethod()." << endl;
}
```

Note that you do not repeat the `virtual` keyword in front of the method definition.

If you want to provide a new definition for `someMethod()` in the `Derived` class, you must first add it to the class definition for `Derived`, as follows:

```
class Derived : public Base
{
```

```

public:
    virtual void someMethod() override; // Overrides Base's someMethod()
    virtual void someOtherMethod();
};

```

Adding the `override` keyword is not mandatory, but it is highly recommended, and discussed in more detail in the section after looking at the client's view of overridden methods. The new definition of `someMethod()` is specified along with the rest of `Derived`'s methods in `Derived.cpp`.

```

void Derived::someMethod()
{
    cout << "This is Derived's version of someMethod()." << endl;
}

```

Once a method or destructor is marked as `virtual`, it is `virtual` for all derived classes even if the `virtual` keyword is removed from derived classes. For example, in the following `Derived` class, `someMethod()` is still `virtual` and can still be overridden by classes inheriting from `Derived`, because it was marked as `virtual` in the `Base` class.

```

class Derived : public Base
{
public:
    void someMethod() override; // Overrides Base's someMethod()
};

```

A Client's View of Overridden Methods

With the preceding changes, other code still calls `someMethod()` the same way it did before. Just as before, the method could be called on an object of class `Base` or an object of class `Derived`. Now, however, the behavior of `someMethod()` varies based on the class of the object.

For example, the following code works just as it did before, calling `Base`'s version of `someMethod()`:

```

Base myBase;
myBase.someMethod(); // Calls Base's version of someMethod().

```

The output of this code is as follows:

```

This is Base's version of someMethod().

```

If the code declares an object of class `Derived`, the other version is automatically called:

```

Derived myDerived;
myDerived.someMethod(); // Calls Derived's version of someMethod()

```

The output this time is as follows:

```

This is Derived's version of someMethod().

```

Everything else about objects of class `Derived` remains the same. Other methods that might have been inherited from `Base` still have the definition provided by `Base` unless they are explicitly overridden in `Derived`.

As you learned earlier, a pointer or reference can refer to an object of a class or any of its derived classes. The object itself “knows” the class of which it is actually a member, so the appropriate method is called as long as it was declared `virtual`. For example, if you have a `Base` reference that

refers to an object that is really a `Derived`, calling `someMethod()` actually calls the derived class's version, as shown next. This aspect of overriding does *not* work properly if you omit the `virtual` keyword in the base class.

```
Derived myDerived;
Base& ref = myDerived;
ref.someMethod(); // Calls Derived's version of someMethod()
```

Remember that even though a base class reference or pointer knows that it is actually a derived class, you cannot access derived class methods or members that are not defined in the base class. The following code does not compile because a `Base` reference does not have a method called `someOtherMethod()`:

```
Derived myDerived;
Base& ref = myDerived;
myDerived.someOtherMethod(); // This is fine.
ref.someOtherMethod(); // Error
```

The derived class knowledge characteristic is *not* true for non-pointer or non-reference objects. You can cast or assign a `Derived` to a `Base` because a `Derived` is a `Base`. However, the object loses any knowledge of the derived class at that point.

```
Derived myDerived;
Base assignedObject = myDerived; // Assigns a Derived to a Base.
assignedObject.someMethod(); // Calls Base's version of someMethod()
```

One way to remember this seemingly strange behavior is to imagine what the objects look like in memory. Picture a `Base` object as a box taking up a certain amount of memory. A `Derived` object is a box that is slightly bigger because it has everything a `Base` has plus a bit more. When you have a reference or pointer to a `Derived`, the box doesn't change—you just have a new way of accessing it. However, when you cast a `Derived` into a `Base`, you are throwing out all the “uniqueness” of the `Derived` class to fit it into a smaller box.

NOTE *Derived classes retain their overridden methods when referred to by base class pointers or references. They lose their uniqueness when cast to a base class object. The loss of the derived class's data members and overridden methods is called slicing.*

The override Keyword

Sometimes, it is possible to accidentally create a new `virtual` method instead of overriding a method from the base class. Take the following `Base` and `Derived` classes where `Derived` is properly overriding `someMethod()`, but is not using the `override` keyword:

```
class Base
{
    public:
        virtual void someMethod(double d);
};
```



```
class Derived : public Base
{
    public:
        virtual void someMethod(double d);
};
```

You can call `someMethod()` through a reference as follows:

```
Derived myDerived;
Base& ref = myDerived;
ref.someMethod(1.1); // Calls Derived's version of someMethod()
```

This correctly calls the overridden `someMethod()` from the `Derived` class. Now, suppose you accidentally use an integer parameter instead of a `double` while overriding `someMethod()`, as follows:

```
class Derived : public Base
{
    public:
        virtual void someMethod(int i);
};
```

This code does *not* override `someMethod()` from `Base`, but instead creates a new virtual method. If you try to call `someMethod()` through a reference as in the following code, `someMethod()` of `Base` is called instead of the one from `Derived`!

```
Derived myDerived;
Base& ref = myDerived;
ref.someMethod(1.1); // Calls Base's version of someMethod()
```

This type of problem can happen when you start to modify the `Base` class but forget to update all derived classes. For example, maybe your first version of the `Base` class has a method called `someMethod()` accepting an integer. You then write the `Derived` class overriding this `someMethod()` accepting an integer. Later you decide that `someMethod()` in `Base` needs a `double` instead of an integer, so you update `someMethod()` in the `Base` class. It might happen that at that time, you forget to update the `someMethod()` methods in derived classes to also accept a `double` instead of an integer. By forgetting this, you are now actually creating a new virtual method instead of properly overriding the method.

You can prevent this situation by using the `override` keyword as follows:

```
class Derived : public Base
{
    public:
        virtual void someMethod(int i) override;
};
```

This definition of `Derived` generates a compilation error, because with the `override` keyword you are saying that `someMethod()` is supposed to be overriding a method from a base class, but in the `Base` class there is no `someMethod()` accepting an integer, only one accepting a `double`.

The problem of accidentally creating a new method instead of properly overriding one can also happen when you rename a method in the base class, and forget to rename the overriding methods in derived classes.

NOTE *Always use the `override` keyword on methods that are meant to be overriding methods from a base class.*

The Truth about virtual

If a method is not `virtual`, you can still attempt to override it, but it will be wrong in subtle ways.

Hiding Instead of Overriding

The following code shows a base class and a derived class, each with a single method. The derived class is attempting to override the method in the base class, but it is not declared to be `virtual` in the base class:

```
class Base
{
    public:
        void go() { cout << "go() called on Base" << endl; }
};

class Derived : public Base
{
    public:
        void go() { cout << "go() called on Derived" << endl; }
};
```

Attempting to call `go()` on a `Derived` object initially appears to work:

```
Derived myDerived;
myDerived.go();
```

The output of this call is, as expected, “go() called on Derived”. However, because the method is not `virtual`, it is not actually overridden. Rather, the `Derived` class creates a new method, also called `go()`, that is completely unrelated to the `Base` class’s method called `go()`. To prove this, simply call the method in the context of a `Base` pointer or reference:

```
Derived myDerived;
Base& ref = myDerived;
ref.go();
```

You would expect the output to be “go() called on Derived”, but in fact, the output is “go() called on Base”. This is because the `ref` variable is a `Base` reference and because the `virtual` keyword was omitted. When the `go()` method is called, it simply executes `Base`’s `go()` method. Because it is not `virtual`, there is no need to consider whether a derived class has overridden it.

WARNING *Attempting to override a non-virtual method hides the base class definition, and it will only be used in the context of the derived class.*

How virtual Is Implemented

To understand how method hiding is avoided, you need to know a bit more about what the `virtual` keyword actually does. When a class is compiled in C++, a binary object is created that contains all methods for the class. In the non-`virtual` case, the code to transfer control to the appropriate method is hard-coded directly where the method is called based on the compile-time type. This is called *static binding*, also known as *early binding*.

If the method is declared `virtual`, the correct implementation is called through the use of a special area of memory called the *vtable*, or “virtual table.” Each class that has one or more virtual methods, has a vtable, and every object of such a class contains a pointer to said vtable. This vtable contains pointers to the implementations of the `virtual` methods. In this way, when a method is called on an object, the pointer is followed into the vtable and the appropriate version of the method is executed based on the actual type of the object at run time. This is called *dynamic binding*, also known as *late binding*.

To better understand how vtables make overriding of methods possible, take the following `Base` and `Derived` classes as an example:

```
class Base
{
    public:
        virtual void func1() {}
        virtual void func2() {}
        void nonVirtualFunc() {}
};

class Derived : public Base
{
    public:
        virtual void func2() override {}
        void nonVirtualFunc() {}
};
```

For this example, assume that you have the following two instances:

```
Base myBase;
Derived myDerived;
```

Figure 10-4 shows a high-level view of how the vtables for both instances look. The `myBase` object contains a pointer to its vtable. This vtable has two entries, one for `func1()` and one for `func2()`. Those entries point to the implementations of `Base::func1()` and `Base::func2()`.

`myDerived` also contains a pointer to its vtable, which also has two entries, one for `func1()` and one for `func2()`. Its `func1()` entry points to `Base::func1()` because `Derived` does not override `func1()`. On the other hand, its `func2()` entry points to `Derived::func2()`.

Note that both vtables do not contain any entry for the `nonVirtualFunc()` method because that method is not virtual.

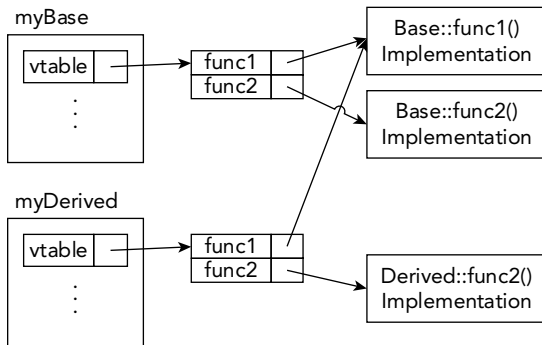

FIGURE 10-4

The Justification for virtual

Because you are advised to make all methods `virtual`, you might be wondering why the `virtual` keyword even exists. Can't the compiler automatically make all methods `virtual`? The answer is yes, it *could*. Many people think that the language *should* just make everything `virtual`. The Java language effectively does this.

The argument against making everything `virtual`, and the reason that the keyword was created in the first place, has to do with the overhead of the `vtable`. To call a `virtual` method, the program needs to perform an extra operation by dereferencing the pointer to the appropriate code to execute. This is a miniscule performance hit in most cases, but the designers of C++ thought that it was better, at least at the time, to let the programmer decide if the performance hit was necessary. If the method was never going to be overridden, there was no need to make it `virtual` and take the performance hit. However, with today's CPUs, the performance hit is measured in fractions of a nano-second and this will keep getting smaller with future CPUs. In most applications, you will not have a measurable performance difference between using `virtual` methods and avoiding them, so you should still follow the advice of making all methods, especially destructors, `virtual`.

Still, in certain cases, the performance overhead might be too costly, and you may need to have an option to avoid the hit. For example, suppose you have a `Point` class that has a `virtual` method. If you have another data structure that stores millions or even billions of `Points`, calling a `virtual` method on each point creates a significant overhead. In that case, it's probably wise to avoid any `virtual` methods in your `Point` class.

There is also a tiny hit to memory usage for each object. In addition to the implementation of the method, each object also needs a pointer for its `vtable`, which takes up a tiny amount of space. This is not an issue in the majority of cases. However, sometimes it does matter. Take again the `Point` class and the container storing billions of `Points`. In that case, the additional required memory becomes significant.

The Need for virtual Destructors

Even programmers who don't adopt the guideline of making all methods `virtual` still adhere to the rule when it comes to destructors. This is because making your destructors non-`virtual` can

easily result in situations in which memory is not freed by object destruction. Only for a class that is marked as `final` you could make its destructor non-virtual.

For example, if a derived class uses memory that is dynamically allocated in the constructor and deleted in the destructor, it will never be freed if the destructor is never called. Similarly, if your derived class has members that are automatically deleted when an instance of the class is destroyed, such as `std::unique_ptr`, then those members will not get deleted either if the destructor is never called.

As the following code shows, it is easy to “trick” the compiler into skipping the call to the destructor if it is non-virtual:

```
class Base
{
    public:
        Base() {}
        ~Base() {}
};

class Derived : public Base
{
    public:
        Derived()
        {
            mString = new char[30];
            cout << "mString allocated" << endl;
        }

        ~Derived()
        {
            delete[] mString;
            cout << "mString deallocated" << endl;
        }
    private:
        char* mString;
};

int main()
{
    Base* ptr = new Derived(); // mString is allocated here.
    delete ptr; // ~Base is called, but not ~Derived because the destructor
                // is not virtual!
    return 0;
}
```

As you can see from the output, the destructor of the `Derived` object is never called:

```
mString allocated
```

Actually, the behavior of the `delete` call in the preceding code is undefined by the standard. A C++ compiler could do whatever it wants in such undefined situations. However, most compilers simply call the destructor of the base class, and not the destructor of the derived class.

NOTE *If you don't need to do any work in your destructor, but you only want to make it virtual, you can explicitly default it. For example:*

```
class Base
{
    public:
        virtual ~Base() = default;
};
```

Note that since C++11, the generation of a copy constructor and copy assignment operator is deprecated if the class has a user-declared destructor, as mentioned in Chapter 8. If you still need a compiler-generated copy constructor or copy assignment operator in such cases, you can explicitly default them. This is not done in the examples in this chapter in the interest of keeping them concise and to the point.

WARNING *Unless you have a specific reason not to, or the class is marked as final, I recommend making all methods, including destructors but not constructors, virtual. Constructors cannot and need not be virtual because you always specify the exact class being constructed when creating an object.*

Preventing Overriding

C++ allows you to mark a method as `final`, which means that the method cannot be overridden in a derived class. Trying to override a `final` method results in a compilation error. Take the following Base class:

```
class Base
{
    public:
        virtual ~Base() = default;
        virtual void someMethod() final;
};
```

Trying to override `someMethod()`, as in the following Derived class, results in a compilation error because `someMethod()` is marked as `final` in the Base class:

```
class Derived : public Base
{
    public:
        virtual void someMethod() override; // Error
};
```

INHERITANCE FOR REUSE

Now that you are familiar with the basic syntax for inheritance, it's time to explore one of the main reasons that inheritance is an important feature of the C++ language. Inheritance is a vehicle that allows you to leverage existing code. This section presents an example of inheritance for the purpose of code reuse.

The WeatherPrediction Class

Imagine that you are given the task of writing a program to issue simple weather predictions, working with both Fahrenheit and Celsius. Weather predictions may be a little bit out of your area of expertise as a programmer, so you obtain a third-party class library that was written to make weather predictions based on the current temperature and the current distance between Jupiter and Mars (hey, it's plausible). This third-party package is distributed as a compiled library to protect the intellectual property of the prediction algorithms, but you do get to see the class definition. The `WeatherPrediction` class definition is as follows:

```
// Predicts the weather using proven new-age techniques given the current
// temperature and the distance from Jupiter to Mars. If these values are
// not provided, a guess is still given but it's only 99% accurate.
class WeatherPrediction
{
public:
    // Virtual destructor
    virtual ~WeatherPrediction();
    // Sets the current temperature in Fahrenheit
    virtual void setCurrentTempFahrenheit(int temp);
    // Sets the current distance between Jupiter and Mars
    virtual void setPositionOfJupiter(int distanceFromMars);
    // Gets the prediction for tomorrow's temperature
    virtual int getTomorrowTempFahrenheit() const;
    // Gets the probability of rain tomorrow. 1 means
    // definite rain. 0 means no chance of rain.
    virtual double getChanceOfRain() const;
    // Displays the result to the user in this format:
    // Result: x.xx chance. Temp. xx
    virtual void showResult() const;
    // Returns a string representation of the temperature
    virtual std::string getTemperature() const;
private:
    int mCurrentTempFahrenheit;
    int mDistanceFromMars;
};
```

Note that this class marks all methods as `virtual`, because the class presumes that its methods might be overridden in a derived class.

This class solves most of the problems for your program. However, as is usually the case, it's not *exactly* right for your needs. First, all the temperatures are given in Fahrenheit. Your program needs to operate in Celsius as well. Also, the `showResult()` method might not display the result in a way you require.

Adding Functionality in a Derived Class

When you learned about inheritance in Chapter 5, adding functionality was the first technique described. Fundamentally, your program needs something just like the `WeatherPrediction` class but with a few extra bells and whistles. Sounds like a good case for inheritance to reuse code. To begin, define a new class, `MyWeatherPrediction`, that inherits from `WeatherPrediction`.

```
#include "WeatherPrediction.h"

class MyWeatherPrediction : public WeatherPrediction
{
};
```

The preceding class definition compiles just fine. The `MyWeatherPrediction` class can already be used in place of `WeatherPrediction`. It provides exactly the same functionality, but nothing new yet. For the first modification, you might want to add knowledge of the Celsius scale to the class. There is a bit of a quandary here because you don't know what the class is doing internally. If all of the internal calculations are made using Fahrenheit, how do you add support for Celsius? One way is to use the derived class to act as a go-between, interfacing between the user, who can use either scale, and the base class, which only understands Fahrenheit.

The first step in supporting Celsius is to add new methods that allow clients to set the current temperature in Celsius instead of Fahrenheit and to get tomorrow's prediction in Celsius instead of Fahrenheit. You also need private helper methods that convert between Celsius and Fahrenheit in both directions. These methods can be `static` because they are the same for all instances of the class.

```
#include "WeatherPrediction.h"

class MyWeatherPrediction : public WeatherPrediction
{
    public:
        virtual void setCurrentTempCelsius(int temp);
        virtual int getTomorrowTempCelsius() const;
    private:
        static int convertCelsiusToFahrenheit(int celsius);
        static int convertFahrenheitToCelsius(int fahrenheit);
};
```

The new methods follow the same naming convention as the parent class. Remember that from the point of view of other code, a `MyWeatherPrediction` object has all of the functionality defined in both `MyWeatherPrediction` and `WeatherPrediction`. Adopting the parent class's naming convention presents a consistent interface.

The implementation of the Celsius/Fahrenheit conversion methods is left as an exercise for the reader—and a fun one at that! The other two methods are more interesting. To set the current temperature in Celsius, you need to convert the temperature first and then present it to the parent class in units that it understands.

```
void MyWeatherPrediction::setCurrentTempCelsius(int temp)
{
    int fahrenheitTemp = convertCelsiusToFahrenheit(temp);
    setCurrentTempFahrenheit(fahrenheitTemp);
}
```

As you can see, once the temperature is converted, the method calls the existing functionality from the base class. Similarly, the implementation of `getTomorrowTempCelsius()` uses the parent's existing functionality to get the temperature in Fahrenheit, but converts the result before returning it.

```
int MyWeatherPrediction::getTomorrowTempCelsius() const
{
    int fahrenheitTemp = getTomorrowTempFahrenheit();
    return convertFahrenheitToCelsius(fahrenheitTemp);
}
```

The two new methods effectively reuse the parent class because they “wrap” the existing functionality in a way that provides a new interface for using it.

You can also add new functionality completely unrelated to existing functionality of the parent class. For example, you could add a method that retrieves alternative forecasts from the Internet or a method that suggests an activity based on the predicted weather.

Replacing Functionality in a Derived Class

The other major technique for inheritance is replacing existing functionality. The `showResult()` method in the `WeatherPrediction` class is in dire need of a facelift. `MyWeatherPrediction` can override this method to replace the behavior with its own implementation.

The new class definition for `MyWeatherPrediction` is as follows:

```
class MyWeatherPrediction : public WeatherPrediction
{
public:
    virtual void setCurrentTempCelsius(int temp);
    virtual int getTomorrowTempCelsius() const;
    virtual void showResult() const override;
private:
    static int convertCelsiusToFahrenheit(int celsius);
    static int convertFahrenheitToCelsius(int fahrenheit);
};
```

Here is a possible new user-friendly implementation:

```
void MyWeatherPrediction::showResult() const
{
    cout << "Tomorrow's temperature will be " <<
        getTomorrowTempCelsius() << " degrees Celsius (" <<
```

```
        getTomorrowTempFahrenheit() << " degrees Fahrenheit)" << endl;
    cout << "Chance of rain is " << (getChanceOfRain() * 100) << " percent"
        << endl;
    if (getChanceOfRain() > 0.5) {
        cout << "Bring an umbrella!" << endl;
    }
}
```

To clients using this class, it's as if the old version of `showResult()` never existed. As long as the object is a `MyWeatherPrediction` object, the new version is called.

As a result of these changes, `MyWeatherPrediction` has emerged as a new class with new functionality tailored to a more specific purpose. Yet, it did not require much code because it leveraged its base class's existing functionality.

RESPECT YOUR PARENTS

When you write a derived class, you need to be aware of the interaction between parent classes and child classes. Issues such as order of creation, constructor chaining, and casting are all potential sources of bugs.

Parent Constructors

Objects don't spring to life all at once; they must be constructed along with their parents and any objects that are contained within them. C++ defines the creation order as follows:

1. If the class has a base class, the default constructor of the base class is executed, unless there is a call to a base class constructor in the ctor-initializer, in which case that constructor is called instead of the default constructor.
2. Non-`static` data members of the class are constructed in the order in which they are declared.
3. The body of the class's constructor is executed.

These rules can apply recursively. If the class has a grandparent, the grandparent is initialized before the parent, and so on. The following code shows this creation order. As a reminder, I generally advise against implementing methods directly in a class definition, as is done in the code that follows. In the interest of readable and concise examples, I have broken my own rule. The proper execution of this code outputs 123.

```
class Something
{
    public:
        Something() { cout << "2"; }
};

class Base
{
    public:
        Base() { cout << "1"; }
```

```

};

class Derived : public Base
{
    public:
        Derived() { cout << "3"; }
    private:
        Something mDataMember;
};

int main()
{
    Derived myDerived;
    return 0;
}

```

When the `myDerived` object is created, the constructor for `Base` is called first, outputting the string "1". Next, `mDataMember` is initialized, calling the `Something` constructor, which outputs the string "2". Finally, the `Derived` constructor is called, which outputs "3".

Note that the `Base` constructor was called automatically. C++ automatically calls the default constructor for the parent class if one exists. If no default constructor exists in the parent class, or if one does exist but you want to use an alternate constructor, you can *chain* the constructor just as when initializing data members in the constructor initializer. For example, the following code shows a version of `Base` that lacks a default constructor. The associated version of `Derived` must explicitly tell the compiler how to call the `Base` constructor or the code will not compile.

```

class Base
{
    public:
        Base(int i);
};

class Derived : public Base
{
    public:
        Derived();
};

Derived::Derived() : Base(7)
{
    // Do Derived's other initialization here.
}

```

The `Derived` constructor passes a fixed value (7) to the `Base` constructor. `Derived` could also pass a variable if its constructor required an argument:

```

Derived::Derived(int i) : Base(i) {}

```

Passing constructor arguments from the derived class to the base class is perfectly fine and quite normal. Passing data members, however, will not work. The code will compile, but remember that data members are not initialized until *after* the base class is constructed. If you pass a data member as an argument to the parent constructor, it will be uninitialized.

WARNING *Virtual methods behave differently in constructors. If your derived class has overridden a virtual method from the base class, calling that method from a base class constructor calls the base class implementation of that virtual method and not your overridden version in the derived class!*

Parent Destructors

Because destructors cannot take arguments, the language can always automatically call the destructor for parent classes. The order of destruction is conveniently the reverse of the order of construction:

1. The body of the class's destructor is called.
2. Any data members of the class are destroyed in the reverse order of their construction.
3. The parent class, if any, is destroyed.

Again, these rules apply recursively. The lowest member of the chain is always destroyed first. The following code adds destructors to the previous example. The destructors are all declared `virtual`! If executed, this code outputs "123321".

```
class Something
{
    public:
        Something() { cout << "2"; }
        virtual ~Something() { cout << "2"; }
};

class Base
{
    public:
        Base() { cout << "1"; }
        virtual ~Base() { cout << "1"; }
};

class Derived : public Base
{
    public:
        Derived() { cout << "3"; }
        virtual ~Derived() { cout << "3"; }
    private:
        Something mDataMember;
};
```

If the preceding destructors were not declared `virtual`, the code would continue to work fine. However, if code ever called `delete` on a base class pointer that was really pointing to a derived class, the destruction chain would begin in the wrong place. For example, if you remove the `virtual` keyword from all destructors in the previous code, then a problem arises when a `Derived` object is accessed as a pointer to a `Base` and deleted, as shown here:

```
Base* ptr = new Derived();
delete ptr;
```

The output of this code is a shockingly terse "1231". When the `ptr` variable is deleted, only the `Base` destructor is called because the destructor was not declared `virtual`. As a result, the `Derived` destructor is not called and the destructors for its data members are not called!

Technically, you could fix the preceding problem by marking only the `Base` destructor `virtual`. The “virtualness” is automatically used by any children. However, I advocate explicitly making all destructors `virtual` so that you never have to worry about it.

WARNING *Always make your destructors `virtual`! The compiler-generated default destructor is not `virtual`, so you should define (or explicitly default) a `virtual` destructor, at least for your parent classes.*

WARNING *Just as with constructors, virtual methods behave differently when called from a destructor. If your derived class has overridden a virtual method from the base class, calling that method from the base class destructor calls the base class implementation of that virtual method and not your overridden version in the derived class.*

Referring to Parent Names

When you override a method in a derived class, you are effectively replacing the original as far as other code is concerned. However, that parent version of the method still exists and you may want to make use of it. For example, an overridden method would like to keep doing what the base class implementation does, plus something else. Take a look at the `getTemperature()` method in the `WeatherPrediction` class that returns a `string` representation of the current temperature:

```
class WeatherPrediction
{
    public:
        virtual std::string getTemperature() const;
        // Omitted for brevity
};
```

You can override this method in the `MyWeatherPrediction` class as follows:

```
class MyWeatherPrediction : public WeatherPrediction
{
    public:
        virtual std::string getTemperature() const override;
        // Omitted for brevity
};
```

Suppose the derived class wants to add °F to the string by first calling the base class `getTemperature()` method and then adding °F to the string. You might write this as follows:

```
string MyWeatherPrediction::getTemperature() const
{
```

```

    // Note: \u00B0 is the ISO/IEC 10646 representation of the degree symbol.
    return getTemperature() + "\u00B0F"; // BUG
}

```

However, this does not work because, under the rules of name resolution for C++, it first resolves against the local scope, then the class scope, and as a consequence ends up calling `MyWeatherPrediction::getTemperature()`. This results in an infinite recursion until you run out of stack space (some compilers detect this error and report it at compile time).

To make this work, you need to use the scope resolution operator as follows:

```

string MyWeatherPrediction::getTemperature() const
{
    // Note: \u00B0 is the ISO/IEC 10646 representation of the degree symbol.
    return WeatherPrediction::getTemperature() + "\u00B0F";
}

```

NOTE Microsoft Visual C++ supports the `__super` keyword (with two underscores). This allows you to write the following:

```
return __super::getTemperature() + "\u00B0F";
```

Calling the parent version of the current method is a commonly used pattern in C++. If you have a chain of derived classes, each might want to perform the operation already defined by the base class but add their own additional functionality as well.

As another example, imagine a class hierarchy of book types. A diagram showing such a hierarchy is shown in Figure 10-5.

Because each lower class in the hierarchy further specifies the type of book, a method that gets the description of a book really needs to take all levels of the hierarchy into consideration. This can be accomplished by chaining to the parent method. The following code illustrates this pattern:

```

class Book
{
public:
    virtual ~Book() = default;
    virtual string getDescription() const { return "Book"; }
    virtual int getHeight() const { return 120; }
};

class Paperback : public Book
{
public:
    virtual string getDescription() const override {
        return "Paperback " + Book::getDescription();
    }
};

```

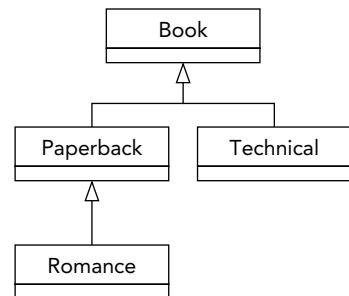

FIGURE 10-5

```

class Romance : public Paperback
{
    public:
        virtual string getDescription() const override {
            return "Romance " + Paperback::getDescription();
        }
        virtual int getHeight() const override {
            return Paperback::getHeight() / 2; }
};

class Technical : public Book
{
    public:
        virtual string getDescription() const override {
            return "Technical " + Book::getDescription();
        }
};

int main()
{
    Romance novel;
    Book book;
    cout << novel.getDescription() << endl; // Outputs "Romance Paperback Book"
    cout << book.getDescription() << endl; // Outputs "Book"
    cout << novel.getHeight() << endl; // Outputs "60"
    cout << book.getHeight() << endl; // Outputs "120"
    return 0;
}

```

The `Book` base class has two virtual methods: `getDescription()` and `getHeight()`. All derived classes override `getDescription()`, but only the `Romance` class overrides `getHeight()` by calling `getHeight()` on its parent class (`Paperback`) and dividing the result by two. `Paperback` does not override `getHeight()`, but C++ walks up the class hierarchy to find a class that implements `getHeight()`. In this example, `Paperback::getHeight()` resolves to `Book::getHeight()`.

Casting Up and Down

As you have already seen, an object can be cast or assigned to its parent class. If the cast or assignment is performed on a plain old object, this results in slicing:

```
Base myBase = myDerived; // Slicing!
```

Slicing occurs in situations like this because the end result is a `Base` object, and `Base` objects lack the additional functionality defined in the `Derived` class. However, slicing does *not* occur if a derived class is assigned to a pointer or reference to its base class:

```
Base& myBase = myDerived; // No slicing!
```

This is generally the correct way to refer to a derived class in terms of its base class, also called *upcasting*. This is why it's always a good idea to make your methods and functions take references to classes instead of directly using objects of those classes. By using references, derived classes can be passed in without slicing.

WARNING *When upcasting, use a pointer or reference to the base class to avoid slicing.*

Casting from a base class to one of its derived classes, also called *downcasting*, is often frowned upon by professional C++ programmers because there is no guarantee that the object really belongs to that derived class, and because downcasting is a sign of bad design. For example, consider the following code:

```
void presumptuous(Base* base)
{
    Derived* myDerived = static_cast<Derived*>(base);
    // Proceed to access Derived methods on myDerived.
}
```

If the author of `presumptuous()` also writes code that calls `presumptuous()`, everything will probably be okay because the author knows that the function expects the argument to be of type `Derived*`. However, if other programmers call `presumptuous()`, they might pass in a `Base*`. There are no compile-time checks that can be done to enforce the type of the argument, and the function blindly assumes that `base` is actually a pointer to a `Derived`.

Downcasting is sometimes necessary, and you can use it effectively in controlled circumstances. However, if you are going to downcast, you should use a `dynamic_cast()`, which uses the object's built-in knowledge of its type to refuse a cast that doesn't make sense. This built-in knowledge typically resides in the vtable, which means that `dynamic_cast()` works only for objects with a vtable, that is, objects with at least one virtual member. If a `dynamic_cast()` fails on a pointer, the pointer's value will be `nullptr` instead of pointing to nonsensical data. If a `dynamic_cast()` fails on an object reference, an `std::bad_cast` exception will be thrown. Chapter 11 discusses the different options for casting in more detail.

The previous example could have been written as follows:

```
void lessPresumptuous(Base* base)
{
    Derived* myDerived = dynamic_cast<Derived*>(base);
    if (myDerived != nullptr) {
        // Proceed to access Derived methods on myDerived.
    }
}
```

The use of downcasting is often a sign of a bad design. You should rethink and modify your design so that downcasting can be avoided. For example, the `lessPresumptuous()` function only really works with `Derived` objects, so instead of accepting a `Base` pointer, it should simply accept a `Derived` pointer. This eliminates the need for any downcasting. If the function should work with different derived classes, all inheriting from `Base`, then look for a solution that uses polymorphism, which is discussed next.

WARNING *Use downcasting only when really necessary, and be sure to use a `dynamic_cast()`.*

INHERITANCE FOR POLYMORPHISM

Now that you understand the relationship between a derived class and its parent, you can use inheritance in its most powerful scenario—polymorphism. Chapter 5 discusses how polymorphism allows you to use objects with a common parent class interchangeably, and to use objects in place of their parents.

Return of the Spreadsheet

Chapters 8 and 9 use a spreadsheet program as an example of an application that lends itself to an object-oriented design. A `SpreadsheetCell` represents a single element of data. Up to now, that element always stored a single `double` value. A simplified class definition for `SpreadsheetCell` follows. Note that a cell can be set either as a `double` or a `string`, but it is always stored as a `double`. The current value of the cell, however, is always returned as a `string` for this example.

```
class SpreadsheetCell
{
public:
    virtual void set(double inDouble);
    virtual void set(std::string_view inString);
    virtual std::string getString() const;
private:
    static std::string doubleToString(double inValue);
    static double stringToDouble(std::string_view inString);
    double mValue;
};
```

In a real spreadsheet application, cells can store different things. A cell could store a `double`, but it might just as well store a piece of text. There could also be a need for additional types of cells, such as a formula cell, or a date cell. How can you support this?

Designing the Polymorphic Spreadsheet Cell

The `SpreadsheetCell` class is screaming out for a hierarchical makeover. A reasonable approach would be to narrow the scope of the `SpreadsheetCell` to cover only `strings`, perhaps renaming it `StringSpreadsheetCell` in the process. To handle `doubles`, a second class, `DoubleSpreadsheetCell`, would inherit from the `StringSpreadsheetCell` and provide functionality specific to its own format. Figure 10-6 illustrates such a design. This approach models inheritance for reuse because the `DoubleSpreadsheetCell` would only be deriving from `StringSpreadsheetCell` to make use of some of its built-in functionality.

If you were to implement the design shown in Figure 10-6, you might discover that the derived class would override most, if not all, of the functionality of the base class. Because `doubles` are treated differently from `strings` in almost all cases, the relationship may not be quite as it was originally understood. Yet, there clearly is a relationship between a cell containing `strings` and a cell containing `doubles`. Rather than using the model in Figure 10-6, which implies that somehow a `DoubleSpreadsheetCell` “is-a” `StringSpreadsheetCell`, a better

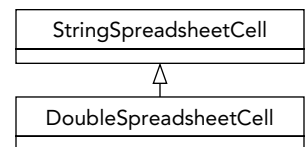

FIGURE 10-6

design would make these classes peers with a common parent, `SpreadsheetCell`. Such a design is shown in Figure 10-7.

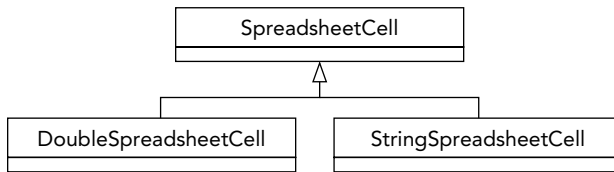

FIGURE 10-7

The design in Figure 10-7 shows a polymorphic approach to the `SpreadsheetCell` hierarchy. Because `DoubleSpreadsheetCell` and `StringSpreadsheetCell` both inherit from a common parent, `SpreadsheetCell`, they are interchangeable in the view of other code. In practical terms, that means the following:

- Both derived classes support the same interface (set of methods) defined by the base class.
- Code that makes use of `SpreadsheetCell` objects can call any method in the interface without even knowing whether the cell is a `DoubleSpreadsheetCell` or a `StringSpreadsheetCell`.
- Through the magic of `virtual` methods, the appropriate instance of every method in the interface is called depending on the class of the object.
- Other data structures, such as the `Spreadsheet` class described in Chapter 9, can contain a collection of multi-typed cells by referring to the parent type.

The SpreadsheetCell Base Class

Because all spreadsheet cells are deriving from the `SpreadsheetCell` base class, it is probably a good idea to write that class first. When designing a base class, you need to consider how the derived classes relate to each other. From this information, you can derive the commonality that will go inside the parent class. For example, `string` cells and `double` cells are similar in that they both contain a single piece of data. Because the data is coming from the user and will be displayed back to the user, the value is set as a `string` and retrieved as a `string`. These behaviors are the shared functionality that will make up the base class.

A First Attempt

The `SpreadsheetCell` base class is responsible for defining the behaviors that all `SpreadsheetCell`-derived classes will support. In this example, all cells need to be able to set their value as a `string`. All cells also need to be able to return their current value as a `string`. The base class definition declares these methods, as well as an explicitly defaulted `virtual` destructor, but note that it has no data members:

```

class SpreadsheetCell
{
    public:

```

```

        virtual ~SpreadsheetCell() = default;
        virtual void set(std::string_view inString);
        virtual std::string getString() const;
};

```

When you start writing the `.cpp` file for this class, you very quickly run into a problem. Considering that the base class of the spreadsheet cell contains neither a `double` nor a `string` data member, how can you implement it? More generally, how do you write a parent class that declares the behaviors that are supported by derived classes without actually defining the implementation of those behaviors?

One possible approach is to implement “do nothing” functionality for those behaviors. For example, calling the `set()` method on the `SpreadsheetCell` base class will have no effect because the base class has nothing to set. This approach still doesn’t feel right, however. Ideally, there should never be an object that is an instance of the base class. Calling `set()` should always have an effect because it should always be called on either a `DoubleSpreadsheetCell` or a `StringSpreadsheetCell`. A good solution enforces this constraint.

Pure Virtual Methods and Abstract Base Classes

Pure virtual methods are methods that are explicitly undefined in the class definition. By making a method pure virtual, you are telling the compiler that no definition for the method exists in the current class. A class with at least one pure virtual method is said to be an *abstract class* because no other code will be able to instantiate it. The compiler enforces the fact that if a class contains one or more pure virtual methods, it can never be used to construct an object of that type.

There is a special syntax for designating a pure virtual method. The method declaration is followed by `= 0`. No implementation needs to be written.

```

class SpreadsheetCell
{
public:
    virtual ~SpreadsheetCell() = default;
    virtual void set(std::string_view inString) = 0;
    virtual std::string getString() const = 0;
};

```

Now that the base class is an abstract class, it is impossible to create a `SpreadsheetCell` object. The following code does not compile, and returns an error such as “error C2259: ‘SpreadsheetCell’: cannot instantiate abstract class”:

```
SpreadsheetCell cell; // Error! Attempts creating abstract class instance
```

However, once the `StringSpreadsheetCell` class has been implemented, the following code will compile fine because it instantiates a derived class of the abstract base class:

```
std::unique_ptr<SpreadsheetCell> cell(new StringSpreadsheetCell());
```

NOTE *An abstract class provides a way to prevent other code from instantiating an object directly, as opposed to one of its derived classes.*

Note that you don't need a `SpreadsheetCell.cpp` source file, because there is nothing to implement. Most methods are pure virtual, and the destructor is explicitly defaulted in the class definition.

The Individual Derived Classes

Writing the `StringSpreadsheetCell` and `DoubleSpreadsheetCell` classes is just a matter of implementing the functionality that is *defined* in the parent. Because you want clients to be able to instantiate and work with `string` cells and `double` cells, the cells can't be abstract—they *must* implement all of the pure virtual methods inherited from their parent. If a derived class does not implement all pure virtual methods from the base class, then the derived class is abstract as well, and clients will not be able to instantiate objects of the derived class.

StringSpreadsheetCell Class Definition

The first step in writing the class definition of `StringSpreadsheetCell` is to inherit from `SpreadsheetCell`.

Next, the inherited pure virtual methods are overridden, this time without being set to zero.

Finally, the string cell adds a private data member, `mValue`, which stores the actual cell data. This data member is an `std::optional`, which is defined since C++17 in the `<optional>` header file. The `optional` type is a class template, so you have to specify the actual type that you need between angled brackets, as in `optional<string>`. Class templates are discussed in detail in Chapter 12. By using an `optional`, it is possible to distinguish whether a value for a cell has been set or not. The `optional` type is discussed in detail in Chapter 20, but its basic use is rather easy, as the next section shows.

```
class StringSpreadsheetCell : public SpreadsheetCell
{
public:
    virtual void set(std::string_view inString) override;
    virtual std::string getString() const override;

private:
    std::optional<std::string> mValue;
};
```

StringSpreadsheetCell Implementation

The source file for `StringSpreadsheetCell` contains the implementation of the methods. The `set()` method is straightforward because the internal representation is already a string. The `getString()` method has to keep into account that `mValue` is of type `optional`, and that it might not have a value. When `mValue` doesn't have a value, `getString()` should return the empty string. This is made easy with the `value_or()` method of `std::optional`. By using `mValue.value_or("")`, the real value is returned if `mValue` contains an actual value, otherwise the empty string is returned.

```
void StringSpreadsheetCell::set(string_view inString)
{
    mValue = inString;
}
```

```
string SpreadsheetCell::getString() const
{
    return mValue.value_or("");
}
```

DoubleSpreadsheetCell Class Definition and Implementation

The `double` version follows a similar pattern, but with different logic. In addition to the `set()` method from the base class that takes a `string_view`, it also provides a new `set()` method that allows a client to set the value with a `double`. Two new `private static` methods are used to convert between a `string` and a `double`, and vice versa. As in `StringSpreadsheetCell`, it has a data member called `mValue`, this time of type `optional<double>`.

```
class DoubleSpreadsheetCell : public SpreadsheetCell
{
public:
    virtual void set(double inDouble);
    virtual void set(std::string_view inString) override;
    virtual std::string getString() const override;

private:
    static std::string doubleToString(double inValue);
    static double stringToDouble(std::string_view inValue);

    std::optional<double> mValue;
};
```

The `set()` method that takes a `double` is straightforward. The `string_view` version uses the `private static` method `stringToDouble()`. The `getString()` method returns the stored `double` value as a `string`, or returns an empty string if no value has been stored. It uses the `has_value()` method of `std::optional` to query whether the `optional` has an actual value or not. If it has a value, the `value()` method is used to get it.

```
void DoubleSpreadsheetCell::set(double inDouble)
{
    mValue = inDouble;
}

void DoubleSpreadsheetCell::set(string_view inString)
{
    mValue = stringToDouble(inString);
}

string DoubleSpreadsheetCell::getString() const
{
    return (mValue.has_value() ? doubleToString(mValue.value()) : "");
}
```

You may already see one major advantage of implementing spreadsheet cells in a hierarchy—the code is much simpler. Each object can be self-centered and only deal with its own functionality.

Note that the implementations of `doubleToString()` and `stringToDouble()` are omitted because they are the same as in Chapter 8.

Leveraging Polymorphism

Now that the `SpreadsheetCell` hierarchy is polymorphic, client code can take advantage of the many benefits that polymorphism has to offer. The following test program explores many of these features.

To demonstrate polymorphism, the test program declares a vector of three `SpreadsheetCell` pointers. Remember that because `SpreadsheetCell` is an abstract class, you can't create objects of that type. However, you can still have a pointer or reference to a `SpreadsheetCell` because it would actually be pointing to one of the derived classes. This vector, because it is a vector of the parent type `SpreadsheetCell`, allows you to store a heterogeneous mixture of the two derived classes. This means that elements of the vector could be either a `StringSpreadsheetCell` or a `DoubleSpreadsheetCell`.

```
vector<unique_ptr<SpreadsheetCell>> cellArray;
```

The first two elements of the vector are set to point to a new `StringSpreadsheetCell`, while the third is a new `DoubleSpreadsheetCell`.

```
cellArray.push_back(make_unique<StringSpreadsheetCell>());
cellArray.push_back(make_unique<StringSpreadsheetCell>());
cellArray.push_back(make_unique<DoubleSpreadsheetCell>());
```

Now that the vector contains multi-typed data, any of the methods declared by the base class can be applied to the objects in the vector. The code just uses `SpreadsheetCell` pointers—the compiler has no idea at compile time what types the objects actually are. However, because they are inheriting from `SpreadsheetCell`, they must support the methods of `SpreadsheetCell`:

```
cellArray[0]->set("hello");
cellArray[1]->set("10");
cellArray[2]->set("18");
```

When the `getString()` method is called, each object properly returns a string representation of their value. The important, and somewhat amazing, thing to realize is that the different objects do this in different ways. A `StringSpreadsheetCell` returns its stored value, or an empty string. A `DoubleSpreadsheetCell` first performs a conversion if it contains a value, otherwise it returns an empty string. As the programmer, you don't need to know how the object does it—you just need to know that because the object is a `SpreadsheetCell`, it *can* perform this behavior.

```
cout << "Vector values are [" << cellArray[0]->getString() << ", " <<
    cellArray[1]->getString() << ", " <<
    cellArray[2]->getString() << "]" <<
endl;
```

Future Considerations

The new implementation of the `SpreadsheetCell` hierarchy is certainly an improvement from an object-oriented design point of view. Yet, it would probably not suffice as an actual class hierarchy for a real-world spreadsheet program for several reasons.

First, despite the improved design, one feature is still missing: the ability to convert from one cell type to another. By dividing them into two classes, the cell objects become more loosely integrated.

To provide the ability to convert from a `DoubleSpreadsheetCell` to a `StringSpreadsheetCell`, you could add a *converting constructor*, also known as a *typed constructor*. It has a similar appearance as a copy constructor, but instead of a reference to an object of the same class, it takes a reference to an object of a sibling class. Note also that you now have to declare a default constructor, which can be explicitly defaulted, because the compiler stops generating one as soon as you declare any constructor yourself:

```
class StringSpreadsheetCell : public SpreadsheetCell
{
public:
    StringSpreadsheetCell() = default;
    StringSpreadsheetCell(const DoubleSpreadsheetCell& inDoubleCell);
    // Omitted for brevity
};
```

This converting constructor can be implemented as follows:

```
StringSpreadsheetCell::StringSpreadsheetCell(
    const DoubleSpreadsheetCell& inDoubleCell)
{
    mValue = inDoubleCell.getString();
}
```

With a converting constructor, you can easily create a `StringSpreadsheetCell` given a `DoubleSpreadsheetCell`. Don't confuse this with casting pointers or references, however. Casting from one sibling pointer or reference to another does not work, unless you overload the cast operator as described in Chapter 15.

WARNING *You can always cast up the hierarchy, and you can sometimes cast down the hierarchy. Casting across the hierarchy is possible by changing the behavior of the cast operator, or by using `reinterpret_cast()`, neither of which is recommended.*

Second, the question of how to implement overloaded operators for cells is an interesting one, and there are several possible solutions. One approach is to implement a version of each operator for every combination of cells. With only two derived classes, this is manageable. There would be an `operator+` function to add two `double` cells, to add two `string` cells, and to add a `double` cell to a `string` cell. Another approach is to decide on a common representation. The preceding implementation already standardizes on a `string` as a common representation of sorts. A single `operator+` function could cover all the cases by taking advantage of this common representation. One possible implementation, which assumes that the result of adding two cells is always a `string` cell, is as follows:

```
StringSpreadsheetCell operator+(const StringSpreadsheetCell& lhs,
                               const StringSpreadsheetCell& rhs)
{
    StringSpreadsheetCell newCell;
    newCell.set(lhs.getString() + rhs.getString());
    return newCell;
}
```

As long as the compiler has a way to turn a particular cell into a `StringSpreadsheetCell`, the operator will work. Given the previous example of having a `StringSpreadsheetCell` constructor that takes a `DoubleSpreadsheetCell` as an argument, the compiler will automatically perform the conversion if it is the only way to get the operator+ to work. That means the following code works, even though operator+ was explicitly written to work on `StringSpreadsheetCells`:

```
DoubleSpreadsheetCell myDb1;
myDb1.set(8.4);
StringSpreadsheetCell result = myDb1 + myDb1;
```

Of course, the result of this addition doesn't really add the numbers together. It converts the `double` cells into `string` cells and concatenates the strings, resulting in a `StringSpreadsheetCell` with a value of `8.4000008.400000`.

If you are still feeling a little unsure about polymorphism, start with the code for this example and try things out. The `main()` function in the preceding example is a great starting point for experimental code that simply exercises various aspects of the class.

MULTIPLE INHERITANCE

As you read in Chapter 5, multiple inheritance is often perceived as a complicated and unnecessary part of object-oriented programming. I'll leave the decision of whether or not it is useful up to you and your coworkers. This section explains the mechanics of multiple inheritance in C++.

Inheriting from Multiple Classes

Defining a class to have multiple parent classes is very simple from a syntactic point of view. All you need to do is list the base classes individually when declaring the class name.

```
class Baz : public Foo, public Bar
{
    // Etc.
};
```

By listing multiple parents, the `Baz` object has the following characteristics:

- A `Baz` object supports the `public` methods, and contains the data members of both `Foo` and `Bar`.
- The methods of the `Baz` class have access to `protected` data and methods in both `Foo` and `Bar`.
- A `Baz` object can be upcast to either a `Foo` or a `Bar`.
- Creating a new `Baz` object automatically calls the `Foo` and `Bar` default constructors, in the order that the classes are listed in the class definition.
- Deleting a `Baz` object automatically calls the destructors for the `Foo` and `Bar` classes, in the reverse order that the classes are listed in the class definition.

The following example shows a class, `DogBird`, that has two parent classes—a `Dog` class and a `Bird` class, as shown in Figure 10-8. The fact that a dog-bird is a ridiculous example should not be viewed as a statement that multiple inheritance itself is ridiculous. Honestly, I leave that judgment up to you.

```
class Dog
{
    public:
        virtual void bark() { cout << "Woof!" << endl; }
};

class Bird
{
    public:
        virtual void chirp() { cout << "Chirp!" << endl; }
};

class DogBird : public Dog, public Bird
{
};
```

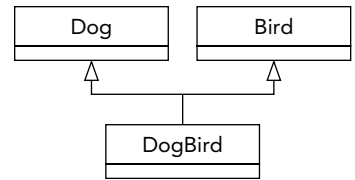

FIGURE 10-8

Using objects of classes with multiple parents is no different from using objects without multiple parents. In fact, the client code doesn't even have to know that the class has two parents. All that really matters are the properties and behaviors supported by the class. In this case, a `DogBird` object supports all of the `public` methods of `Dog` and `Bird`.

```
DogBird myConfusedAnimal;
myConfusedAnimal.bark();
myConfusedAnimal.chirp();
```

The output of this program is as follows:

```
Woof!
Chirp!
```

Naming Collisions and Ambiguous Base Classes

It's not difficult to construct a scenario where multiple inheritance would seem to break down. The following examples show some of the edge cases that must be considered.

Name Ambiguity

What if the `Dog` class and the `Bird` class both had a method called `eat()`? Because `Dog` and `Bird` are not related in any way, one version of the method does not override the other—they both continue to exist in the `DogBird`-derived class.

As long as client code never attempts to call the `eat()` method, that is not a problem. The `DogBird` class compiles correctly despite having two versions of `eat()`. However, if client code attempts to call the `eat()` method on a `DogBird`, the compiler gives an error indicating that the call to `eat()`

is ambiguous. The compiler does not know which version to call. The following code provokes this ambiguity error:

```
class Dog
{
    public:
        virtual void bark() { cout << "Woof!" << endl; }
        virtual void eat() { cout << "The dog ate." << endl; }
};

class Bird
{
    public:
        virtual void chirp() { cout << "Chirp!" << endl; }
        virtual void eat() { cout << "The bird ate." << endl; }
};

class DogBird : public Dog, public Bird
{
};

int main()
{
    DogBird myConfusedAnimal;
    myConfusedAnimal.eat(); // Error! Ambiguous call to method eat()
    return 0;
}
```

The solution to the ambiguity is to either explicitly upcast the object using a `dynamic_cast()`, essentially hiding the undesired version of the method from the compiler, or to use a *disambiguation syntax*. For example, the following code shows two ways to invoke the `Dog` version of `eat()`:

```
dynamic_cast<Dog&>(myConfusedAnimal).eat(); // Calls Dog::eat()
myConfusedAnimal.Dog::eat(); // Calls Dog::eat()
```

Methods of the derived class itself can also explicitly disambiguate between different methods of the same name by using the same syntax used to access parent methods, that is, the `::` scope resolution operator. For example, the `DogBird` class could prevent ambiguity errors in other code by defining its own `eat()` method. Inside this method, it would determine which parent version to call:

```
class DogBird : public Dog, public Bird
{
    public:
        void eat() override;
};

void DogBird::eat()
{
    Dog::eat(); // Explicitly call Dog's version of eat()
}
```

Yet another way to prevent the ambiguity error is to use a `using` statement to explicitly state which version of `eat()` should be inherited in `DogBird`. This is done in the following `DogBird` definition:

```
class DogBird : public Dog, public Bird
{
```

```

public:
    using Dog::eat; // Explicitly inherit Dog's version of eat()
};

```

Ambiguous Base Classes

Another way to provoke ambiguity is to inherit from the same class twice. For example, if the `Bird` class inherits from `Dog` for some reason, the code for `DogBird` does not compile because `Dog` becomes an ambiguous base class:

```

class Dog {};
class Bird : public Dog {};
class DogBird : public Bird, public Dog {}; // Error!

```

Most occurrences of ambiguous base classes are either contrived “what-if” examples, as in the preceding one, or arise from untidy class hierarchies. Figure 10-9 shows a class diagram for the preceding example, indicating the ambiguity.

Ambiguity can also occur with data members. If `Dog` and `Bird` both had a data member with the same name, an ambiguity error would occur when client code attempted to access that member.

A more likely scenario is that multiple parents themselves have common parents. For example, perhaps both `Bird` and `Dog` are inheriting from an `Animal` class, as shown in Figure 10-10.

This type of class hierarchy is permitted in C++, though name ambiguity can still occur. For example, if the `Animal` class has a public method called `sleep()`, that method cannot be called on a `DogBird` object because the compiler does not know whether to call the version inherited by `Dog` or by `Bird`.

The best way to use these “diamond-shaped” class hierarchies is to make the topmost class an abstract base class with all methods declared as pure virtual. Because the class only declares methods without providing definitions, there are no methods in the base class to call and thus there are no ambiguities at that level.

The following example implements a diamond-shaped class hierarchy in which the `Animal` abstract base class has a pure virtual `eat()` method that must be defined by each derived class. The `DogBird` class still needs to be explicit about which parent’s `eat()` method it uses, but any ambiguity is caused by `Dog` and `Bird` having the same method, not because they inherit from the same class.

```

class Animal
{
public:
    virtual void eat() = 0;
};

```

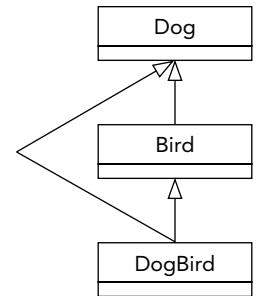

FIGURE 10-9

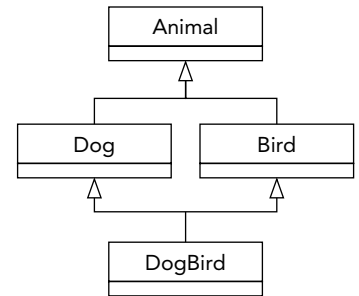

FIGURE 10-10

```
class Dog : public Animal
{
    public:
        virtual void bark() { cout << "Woof!" << endl; }
        virtual void eat() override { cout << "The dog ate." << endl; }
};

class Bird : public Animal
{
    public:
        virtual void chirp() { cout << "Chirp!" << endl; }
        virtual void eat() override { cout << "The bird ate." << endl; }
};

class DogBird : public Dog, public Bird
{
    public:
        using Dog::eat;
};
```

A more refined mechanism for dealing with the top class in a diamond-shaped hierarchy, *virtual base classes*, is explained at the end of this chapter.

Uses for Multiple Inheritance

At this point, you're probably wondering why programmers would want to tackle multiple inheritance in their code. The most straightforward use case for multiple inheritance is to define a class of objects that is-a something and also is-a something else. As was said in Chapter 5, any real-world objects you find that follow this pattern are unlikely to translate well into code.

One of the most compelling and simple uses of multiple inheritance is for the implementation of mixin classes. Mixin classes are explained in Chapter 5.

Another reason that people sometimes use multiple inheritance is to model a component-based class. Chapter 5 gives the example of an airplane simulator. The `Airplane` class has an engine, a fuselage, controls, and other components. While the typical implementation of an `Airplane` class would make each of these components a separate data member, you *could* use multiple inheritance. The airplane class would inherit from engine, fuselage, and controls, in effect getting the behaviors and properties of all of its components. I recommend you to stay away from this type of code because it confuses a clear has-a relationship with inheritance, which should be used for is-a relationships. The recommended solution is to have an `Airplane` class that contains data members of type `Engine`, `Fuselage`, and `Controls`.

INTERESTING AND OBSCURE INHERITANCE ISSUES

Extending a class opens up a variety of issues. What characteristics of the class can and cannot be changed? What is non-public inheritance? What are virtual base classes? These questions, and more, are answered in the following sections.

Changing the Overridden Method's Characteristics

For the most part, the reason you override a method is to change its implementation. Sometimes, however, you may want to change other characteristics of the method.

Changing the Method Return Type

A good rule of thumb is to override a method with the exact method declaration, or *method prototype*, that the base class uses. The implementation can change, but the prototype stays the same.

That does not have to be the case, however. In C++, an overriding method can change the return type as long as the original return type is a pointer or reference to a class, and the new return type is a pointer or reference to a descendent class. Such types are called *covariant return types*. This feature sometimes comes in handy when the base class and derived class work with objects in a *parallel hierarchy*—that is, another group of classes that is tangential, but related, to the first class hierarchy.

For example, consider a hypothetical cherry orchard simulator. You might have two hierarchies of classes that model different real-world objects but are obviously related. The first is the `Cherry` chain. The base class, `Cherry`, has a derived class called `BingCherry`. Similarly, there is another chain of classes with a base class called `CherryTree` and a derived class called `BingCherryTree`. Figure 10-11 shows the two class chains.

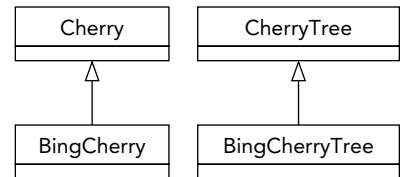

FIGURE 10-11

Now assume that the `CherryTree` class has a virtual method called `pick()` that retrieves a single cherry from the tree:

```
Cherry* CherryTree::pick()
{
    return new Cherry();
}
```

NOTE *To demonstrate changing the return type, this example does not return smart pointers, but raw pointers. The reason is explained at the end of this section. Of course, the caller should store the result immediately in a smart pointer instead of keeping the raw pointer around.*

In the `BingCherryTree`-derived class, you may want to override this method. Perhaps bing cherries need to be polished when they are picked (bear with me on this one). Because a `BingCherry` is a `Cherry`, you could leave the method prototype as is and override the method as in the following example. The `BingCherry` pointer is automatically cast to a `Cherry` pointer. Note that this implementation uses a `unique_ptr` to make sure no memory is leaked when `polish()` throws an exception.

```
Cherry* BingCherryTree::pick()
{
    auto theCherry = std::make_unique<BingCherry>();
```

```

    theCherry->polish();
    return theCherry.release();
}

```

This implementation is perfectly fine and is probably the way that I would write it. However, because you know that the `BingCherryTree` will always return `BingCherry` objects, you could indicate this fact to potential users of this class by changing the return type, as shown here:

```

BingCherry* BingCherryTree::pick()
{
    auto theCherry = std::make_unique<BingCherry>();
    theCherry->polish();
    return theCherry.release();
}

```

Here is how you can use the `BingCherryTree::pick()` method:

```

BingCherryTree theTree;
std::unique_ptr<Cherry> theCherry(theTree.pick());
theCherry->printType();

```

A good way to figure out whether you can change the return type of an overridden method is to consider whether existing code would still work; this is called the *Liskov substitution principle* (LSP). In the preceding example, changing the return type was fine because any code that assumed that the `pick()` method would always return a `Cherry*` would still compile and work correctly. Because a `BingCherry` is a `Cherry`, any methods that were called on the result of `CherryTree`'s version of `pick()` could still be called on the result of `BingCherryTree`'s version of `pick()`.

You could *not*, for example, change the return type to something completely unrelated, such as `void*`. The following code does not compile:

```

void* BingCherryTree::pick() // Error!
{
    auto theCherry = std::make_unique<BingCherry>();
    theCherry->polish();
    return theCherry.release();
}

```

This generates a compilation error, something like this:

```

' BingCherryTree::pick': overriding virtual function return type differs and is not
covariant from 'CherryTree::pick'.

```

As mentioned before, this example is using raw pointers instead of smart pointers. It does not work for example when using `std::unique_ptr` as return type. Suppose the `CherryTree::pick()` method returns a `unique_ptr<Cherry>` as follows:

```

std::unique_ptr<Cherry> CherryTree::pick()
{
    return std::make_unique<Cherry>();
}

```

Now, you cannot change the return type for the `BingCherryTree::pick()` method to `unique_ptr<BingCherry>`. That is, the following does not compile:

```
class BingCherryTree : public CherryTree
{
    public:
        virtual std::unique_ptr<BingCherry> pick() override;
};
```

The reason is that `std::unique_ptr` is a class template. Class templates are discussed in detail in Chapter 12. Two instantiations of the `unique_ptr` class template are created, `unique_ptr<Cherry>` and `unique_ptr<BingCherry>`. Both these instantiations are completely different types and are in no way related to each other. You cannot change the return type of an overridden method to return a completely different type.

Changing the Method Parameters

If you use the name of a virtual method from the parent class in the definition of a derived class, but it uses different parameters than the method with that name uses in the parent class, it is not overriding the method of the parent class—it is creating a new method. Returning to the `Base` and `Derived` example from earlier in this chapter, you could *attempt* to override `someMethod()` in `Derived` with a new argument list as follows:

```
class Base
{
    public:
        virtual void someMethod();
};

class Derived : public Base
{
    public:
        virtual void someMethod(int i); // Compiles, but doesn't override
        virtual void someOtherMethod();
};
```

The implementation of this method could be as follows:

```
void Derived::someMethod(int i)
{
    cout << "This is Derived's version of someMethod with argument " << i
         << "." << endl;
}
```

The preceding class definition compiles, but you have not overridden `someMethod()`. Because the arguments are different, you have created a new method that exists only in `Derived`. If you want a method called `someMethod()` that takes an `int`, and you want it to work only on objects of class `Derived`, the preceding code is correct.

The C++ standard says that the original method is now *hidden* as far as `Derived` is concerned. The following sample code does not compile because there is no longer a no-argument version of `someMethod()`.

```
Derived myDerived;
myDerived.someMethod(); // Error! Won't compile because original
                        // method is hidden.
```

If your intention is to override `someMethod()` from `Base`, then you should use the `override` keyword as recommended before. The compiler then gives an error if you make a mistake in overriding the method.

There is a somewhat obscure technique you can use to have your cake and eat it too. That is, you can use this technique to effectively “override” a method in the derived class with a new prototype but continue to inherit the base class version. This technique uses the `using` keyword to explicitly include the base class definition of the method within the derived class, as follows:

```
class Base
{
    public:
        virtual void someMethod();
};

class Derived : public Base
{
    public:
        using Base::someMethod; // Explicitly "inherits" the Base version
        virtual void someMethod(int i); // Adds a new version of someMethod
        virtual void someOtherMethod();
};
```

NOTE *It is rare to find a method in a derived class with the same name as a method in the base class but using a different parameter list.*

Inherited Constructors

In the previous section, you saw the use of the `using` keyword to explicitly include the base class definition of a method within a derived class. This works perfectly fine for normal class methods, but it also works for constructors, allowing you to inherit constructors from your base classes. Take a look at the following definition for the `Base` and `Derived` classes:

```
class Base
{
    public:
        virtual ~Base() = default;
        Base() = default;
        Base(std::string_view str);
};
```



```
class Derived : public Base
{
    public:
        Derived(int i);
};
```

You can construct a `Base` object only with the provided `Base` constructors, either the default constructor or the constructor with a `string_view` parameter. On the other hand, constructing a `Derived` object can happen only with the provided `Derived` constructor, which requires a single integer as argument. You cannot construct `Derived` objects using the constructor accepting a `string_view` defined in the `Base` class. Here is an example:

```
Base base("Hello");           // OK, calls string_view Base ctor
Derived derived1(1);         // OK, calls integer Derived ctor
Derived derived2("Hello");   // Error, Derived does not inherit string_view ctor
```

If you would like the ability to construct `Derived` objects using the `string_view`-based `Base` constructor, you can explicitly inherit the `Base` constructors in the `Derived` class as follows:

```
class Derived : public Base
{
    public:
        using Base::Base;
        Derived(int i);
};
```

The `using` statement inherits all constructors from the parent class except the default constructor, so now you can construct `Derived` objects in the following two ways:

```
Derived derived1(1);         // OK, calls integer Derived ctor
Derived derived2("Hello");  // OK, calls inherited string_view Base ctor
```

The `Derived` class can define a constructor with the same parameter list as one of the inherited constructors in the `Base` class. In this case, as with any override, the constructor of the `Derived` class takes precedence over the inherited constructor. In the following example, the `Derived` class inherits all constructors, except the default constructor, from the `Base` class with the `using` statement. However, because the `Derived` class defines its own constructor with a single parameter of type `float`, the inherited constructor from the `Base` class with a single parameter of type `float` is overridden.

```
class Base
{
    public:
        virtual ~Base() = default;
        Base() = default;
        Base(std::string_view str);
        Base(float f);
};

class Derived : public Base
{
    public:
        using Base::Base;
        Derived(float f);    // Overrides inherited float Base ctor
};
```

With this definition, objects of `Derived` can be created as follows:

```
Derived derived1("Hello"); // OK, calls inherited string_view Base ctor
Derived derived2(1.23f);  // OK, calls float Derived ctor
```

A few restrictions apply to inheriting constructors from a base class with the `using` clause. When you inherit a constructor from a base class, you inherit all of them, except the default constructor. It is not possible to inherit only a subset of the constructors of a base class. A second restriction is related to multiple inheritance. It's not possible to inherit constructors from one of the base classes if another base class has a constructor with the same parameter list, because this leads to ambiguity. To resolve this, the `Derived` class needs to explicitly define the conflicting constructors. For example, the following `Derived` class tries to inherit all constructors from both `Base1` and `Base2`, which results in a compilation error due to ambiguity of the `float`-based constructors.

```
class Base1
{
public:
    virtual ~Base1() = default;
    Base1() = default;
    Base1(float f);
};

class Base2
{
public:
    virtual ~Base2() = default;
    Base2() = default;
    Base2(std::string_view str);
    Base2(float f);
};

class Derived : public Base1, public Base2
{
public:
    using Base1::Base1;
    using Base2::Base2;
    Derived(char c);
};
```

The first `using` clause in `Derived` inherits all constructors from `Base1`. This means that `Derived` gets the following constructor:

```
Derived(float f); // Inherited from Base1
```

With the second `using` clause in `Derived`, you are trying to inherit all constructors from `Base2`. However, this causes a compilation error because this means that `Derived` gets a second `Derived(float f)` constructor. The problem is solved by explicitly declaring conflicting constructors in the `Derived` class as follows:

```
class Derived : public Base1, public Base2
{
public:
    using Base1::Base1;
    using Base2::Base2;
    Derived(char c);
    Derived(float f);
};
```

The `Derived` class now explicitly declares a constructor with a single parameter of type `float`, solving the ambiguity. If you want, this explicitly declared constructor in the `Derived` class accepting a `float` parameter can still forward the call to both the `Base1` and `Base2` constructors in its ctor-initializer as follows:

```
Derived::Derived(float f) : Base1(f), Base2(f) {}
```

When using inherited constructors, make sure that all member variables are properly initialized. For example, take the following new definitions for `Base` and `Derived`. This example does not properly initialize the `mInt` data member in all cases, which is a serious error.

```
class Base
{
public:
    virtual ~Base() = default;
    Base(std::string_view str) : mStr(str) {}
private:
    std::string mStr;
};

class Derived : public Base
{
public:
    using Base::Base;
    Derived(int i) : Base(""), mInt(i) {}
private:
    int mInt;
};
```

You can create a `Derived` object as follows:

```
Derived s1(2);
```

This calls the `Derived(int i)` constructor, which initializes the `mInt` data member of the `Derived` class and calls the `Base` constructor with an empty string to initialize the `mStr` data member.

Because the `Base` constructor is inherited in the `Derived` class, you can also construct a `Derived` object as follows:

```
Derived s2("Hello World");
```

This calls the inherited `Base` constructor in the `Derived` class. However, this inherited `Base` constructor only initializes `mStr` of the `Base` class, and does not initialize `mInt` of the `Derived` class, leaving it in an uninitialized state. This is not recommended!

The solution in this case is to use in-class member initializers, which are discussed in Chapter 8. The following code uses an in-class member initializer to initialize `mInt` to 0. The `Derived(int i)` constructor can still change this and initialize `mInt` to the constructor parameter `i`.

```
class Derived : public Base
{
public:
    using Base::Base;
    Derived(int i) : Base(""), mInt(i) {}
private:
    int mInt = 0;
};
```

Special Cases in Overriding Methods

Several special cases require attention when overriding a method. This section outlines the cases that you are likely to encounter.

The Base Class Method Is `static`

In C++, you cannot override a `static` method. For the most part, that's all you need to know. There are, however, a few corollaries that you need to understand.

First of all, a method cannot be both `static` and `virtual`. This is the first clue that attempting to override a `static` method will not do what you intend it to do. If you have a `static` method in your derived class with the same name as a `static` method in your base class, you actually have two separate methods.

The following code shows two classes that both happen to have `static` methods called `beStatic()`. These two methods are in no way related.

```
class BaseStatic
{
    public:
        static void beStatic() {
            cout << "BaseStatic being static." << endl; }
};

class DerivedStatic : public BaseStatic
{
    public:
        static void beStatic() {
            cout << "DerivedStatic keepin' it static." << endl; }
};
```

Because a `static` method belongs to its class, calling the identically named methods on the two different classes calls their respective methods:

```
BaseStatic::beStatic();
DerivedStatic::beStatic();
```

This outputs the following:

```
BaseStatic being static.
DerivedStatic keepin' it static.
```

Everything makes perfect sense as long as the methods are accessed by their class name. The behavior is less clear when objects are involved. In C++, you can call a `static` method using an object, but because the method is `static`, it has no `this` pointer and no access to the object itself, so it is equivalent to calling it by `classname::method()`. Referring to the previous example classes, you can write code as follows, but the results may be surprising.

```
DerivedStatic myDerivedStatic;
BaseStatic& ref = myDerivedStatic;
myDerivedStatic.beStatic();
ref.beStatic();
```

The first call to `beStatic()` obviously calls the `DerivedStatic` version because it is explicitly called on an object declared as a `DerivedStatic`. The second call might not work as you expect. The object is a `BaseStatic` reference, but it refers to a `DerivedStatic` object. In this case, `BaseStatic`'s version of `beStatic()` is called. The reason is that C++ doesn't care what the object actually is when calling a static method. It only cares about the compile-time type. In this case, the type is a reference to a `BaseStatic`.

The output of the previous example is as follows:

```
DerivedStatic keepin' it static.
BaseStatic being static.
```

NOTE *static methods are scoped by the name of the class in which they are defined, but they are not methods that apply to a specific object. When you call a static method, the version determined by normal name resolution is called. When the method is called syntactically by using an object, the object is not actually involved in the call, except to determine the type at compile time.*

The Base Class Method Is Overloaded

When you override a method by specifying a name and a set of parameters, the compiler implicitly hides all other instances of the name in the base class. The idea is that if you have overridden one method of a given name, you might have intended to override all the methods of that name, but simply forgot, and therefore this should be treated as an error. It makes sense if you think about it—why would you want to change some versions of a method and not others? Consider the following `Derived` class, which overrides a method without overriding its associated overloaded siblings:

```
class Base
{
    public:
        virtual ~Base() = default;
        virtual void overload() { cout << "Base's overload()" << endl; }
        virtual void overload(int i) {
            cout << "Base's overload(int i)" << endl; }
};

class Derived : public Base
{
    public:
        virtual void overload() override {
            cout << "Derived's overload()" << endl; }
};
```

If you attempt to call the version of `overload()` that takes an `int` parameter on a `Derived` object, your code will not compile because it was not explicitly overridden.

```
Derived myDerived;
myDerived.overload(2); // Error! No matching method for overload(int).
```

It is possible, however, to access this version of the method from a `Derived` object. All you need is a pointer or a reference to a `Base` object:

```
Derived myDerived;
Base& ref = myDerived;
ref.overload(7);
```

The hiding of unimplemented overloaded methods is only skin deep in C++. Objects that are explicitly declared as instances of the derived class do not make the methods available, but a simple cast to the base class brings them right back.

The `using` keyword can be employed to save you the trouble of overloading all the versions when you really only want to change one. In the following code, the `Derived` class definition uses one version of `overload()` from `Base` and explicitly overloads the other:

```
class Base
{
    public:
        virtual ~Base() = default;
        virtual void overload() { cout << "Base's overload()" << endl; }
        virtual void overload(int i) {
            cout << "Base's overload(int i)" << endl; }
};

class Derived : public Base
{
    public:
        using Base::overload;
        virtual void overload() override {
            cout << "Derived's overload()" << endl; }
};
```

The `using` clause has certain risks. Suppose a third `overload()` method is added to `Base`, which should have been overridden in `Derived`. This will now not be detected as an error, because, due to the `using` clause, the designer of the `Derived` class has explicitly said, “I am willing to accept all other overloads of this method from the parent class.”

WARNING *To avoid obscure bugs, you should override all versions of an overloaded method, either explicitly or with the `using` keyword, but keep the risks of the `using` clause in mind.*

The Base Class Method Is `private` or `protected`

There’s absolutely nothing wrong with overriding a `private` or `protected` method. Remember that the access specifier for a method determines who is able to *call* the method. Just because a derived class can’t call its parent’s `private` methods doesn’t mean it can’t override them. In fact, overriding a `private` or `protected` method is a common pattern in C++. It allows derived classes to define their own “uniqueness” that is referenced in the base class. Note that, for example, Java and C# only allow overriding `public` and `protected` methods, not `private` methods.

For example, the following class is part of a car simulator that estimates the number of miles the car can travel based on its gas mileage and the amount of fuel left:

```
class MilesEstimator
{
    public:
        virtual ~MilesEstimator() = default;

        virtual int getMilesLeft() const;

        virtual void setGallonsLeft(int gallons);
        virtual int  getGallonsLeft() const;

    private:
        int mGallonsLeft;
        virtual int getMilesPerGallon() const;
};
```

The implementations of the methods are as follows:

```
int MilesEstimator::getMilesLeft() const
{
    return getMilesPerGallon() * getGallonsLeft();
}

void MilesEstimator::setGallonsLeft(int gallons)
{
    mGallonsLeft = gallons;
}

int MilesEstimator::getGallonsLeft() const
{
    return mGallonsLeft;
}

int MilesEstimator::getMilesPerGallon() const
{
    return 20;
}
```

The `getMilesLeft()` method performs a calculation based on the results of two of its own methods. The following code uses the `MilesEstimator` to calculate how many miles can be traveled with two gallons of gas:

```
MilesEstimator myMilesEstimator;
myMilesEstimator.setGallonsLeft(2);
cout << "Normal estimator can go " << myMilesEstimator.getMilesLeft()
    << " more miles." << endl;
```

The output of this code is as follows:

```
Normal estimator can go 40 more miles.
```

To make the simulator more interesting, you may want to introduce different types of vehicles, perhaps a more efficient car. The existing `MilesEstimator` assumes that all cars get 20 miles per

gallon, but this value is returned from a separate method specifically so that a derived class can override it. Such a derived class is shown here:

```
class EfficientCarMilesEstimator : public MilesEstimator
{
    private:
        virtual int getMilesPerGallon() const override;
};
```

The implementation is as follows:

```
int EfficientCarMilesEstimator::getMilesPerGallon() const
{
    return 35;
}
```

By overriding this one private method, the new class completely changes the behavior of existing, unmodified, public methods. The `getMilesLeft()` method in the base class automatically calls the overridden version of the private `getMilesPerGallon()` method. An example using the new class is shown here:

```
EfficientCarMilesEstimator myEstimator;
myEstimator.setGallonsLeft(2);
cout << "Efficient estimator can go " << myEstimator.getMilesLeft()
    << " more miles." << endl;
```

This time, the output reflects the overridden functionality:

```
Efficient estimator can go 70 more miles.
```

NOTE *Overriding private and protected methods is a good way to change certain features of a class without a major overhaul.*

The Base Class Method Has Default Arguments

Derived classes and base classes can each have different default arguments, but the arguments that are used depend on the declared type of the variable, not the underlying object. Following is a simple example of a derived class that provides a different default argument in an overridden method:

```
class Base
{
    public:
        virtual ~Base() = default;
        virtual void go(int i = 2) {
            cout << "Base's go with i=" << i << endl; }
};

class Derived : public Base
{
    public:
        virtual void go(int i = 7) override {
            cout << "Derived's go with i=" << i << endl; }
};
```

If `go()` is called on a `Derived` object, `Derived`'s version of `go()` is executed with the default argument of 7. If `go()` is called on a `Base` object, `Base`'s version of `go()` is called with the default argument of 2. However (and this is the weird part), if `go()` is called on a `Base` pointer or `Base` reference that really points to a `Derived` object, `Derived`'s version of `go()` is called but with `Base`'s default argument of 2. This behavior is shown in the following example:

```
Base myBase;
Derived myDerived;
Base& myBaseReferenceToDerived = myDerived;
myBase.go();
myDerived.go();
myBaseReferenceToDerived.go();
```

The output of this code is as follows:

```
Base's go with i=2
Derived's go with i=7
Derived's go with i=2
```

The reason for this behavior is that C++ uses the compile-time type of the expression to bind default arguments, not the run-time type. Default arguments are not “inherited” in C++. If the `Derived` class in this example failed to provide a default argument as its parent did, it would be overloading the `go()` method with a new non-zero-argument version.

NOTE *When overriding a method that has a default argument, you should provide a default argument as well, and it should probably be the same value. It is recommended to use a symbolic constant for default values so that the same symbolic constant can be used in derived classes.*

The Base Class Method Has a Different Access Level

There are two ways you may want to change the access level of a method: you could try to make it more restrictive or less restrictive. Neither case makes much sense in C++, but there are a few legitimate reasons for attempting to do so.

To enforce tighter restrictions on a method (or on a data member for that matter), there are two approaches you can take. One way is to change the access specifier for the entire base class. This approach is described later in this chapter. The other approach is simply to redefine the access in the derived class, as illustrated in the `shy` class that follows:

```
class Gregarious
{
    public:
        virtual void talk() {
            cout << "Gregarious says hi!" << endl; }
};

class Shy : public Gregarious
{
    protected:
        virtual void talk() override {
            cout << "Shy reluctantly says hello." << endl; }
};
```

The protected version of `talk()` in the `Shy` class properly overrides the `Gregarious::talk()` method. Any client code that attempts to call `talk()` on a `Shy` object gets a compilation error:

```
Shy myShy;
myShy.talk(); // Error! Attempt to access protected method.
```

However, the method is not fully protected. One only has to obtain a `Gregarious` reference or pointer to access the method that you thought was protected:

```
Shy myShy;
Gregarious& ref = myShy;
ref.talk();
```

The output of this code is as follows:

```
Shy reluctantly says hello.
```

This proves that making the method protected in the derived class actually overrode the method (because the derived class version is correctly called), but it also proves that the protected access can't be fully enforced if the base class makes it public.

NOTE *There is no reasonable way (or good reason) to restrict access to a public base class method.*

NOTE *The previous example redefined the method in the derived class because it wants to display a different message. If you don't want to change the implementation, but instead only want to change the access level of a method, the preferred way is to simply add a using statement in the derived class definition with the desired access level.*

It is much easier (and makes more sense) to lessen access restrictions in derived classes. The simplest way is to provide a public method that calls a protected method from the base class, as shown here:

```
class Secret
{
    protected:
        virtual void dontTell() { cout << "I'll never tell." << endl; }
};

class Blabber : public Secret
{
    public:
        virtual void tell() { dontTell(); }
};
```

A client calling the public `tell()` method of a `Blabber` object effectively accesses the protected method of the `Secret` class. Of course, this doesn't *really* change the access level of `dontTell()`, it just provides a public way of accessing it.

You can also override `dontTell()` explicitly in `Blabber` and give it new behavior with `public` access. This makes a lot more sense than reducing the level of access because it is entirely clear what happens with a reference or pointer to the base class. For example, suppose that `Blabber` actually makes the `dontTell()` method `public`:

```
class Blabber : public Secret
{
    public:
        virtual void dontTell() override { cout << "I'll tell all!" << endl; }
};
```

Now you can call `dontTell()` on a `Blabber` object:

```
myBlabber.dontTell(); // Outputs "I'll tell all!"
```

If you don't want to change the implementation of the overridden method, but only change the access level, then you can use a `using` clause. For example:

```
class Blabber : public Secret
{
    public:
        using Secret::dontTell;
};
```

This also allows you to call `dontTell()` on a `Blabber` object, but this time the output will be "I'll never tell.":

```
myBlabber.dontTell(); // Outputs "I'll never tell."
```

In both previous cases, however, the protected method in the base class stays protected because any attempts to call `Secret`'s `dontTell()` method through a `Secret` pointer or reference will not compile.

```
Blabber myBlabber;
Secret& ref = myBlabber;
Secret* ptr = &myBlabber;
ref.dontTell(); // Error! Attempt to access protected method.
ptr->dontTell(); // Error! Attempt to access protected method.
```

NOTE *The only truly useful way to change a method's access level is by providing a less restrictive accessor to a protected method.*

Copy Constructors and Assignment Operators in Derived Classes

Chapter 9 says that providing a copy constructor and assignment operator is considered a good programming practice when you have dynamically allocated memory in a class. When defining a derived class, you need to be careful about copy constructors and `operator=`.

If your derived class does not have any special data (pointers, usually) that require a nondefault copy constructor or `operator=`, you don't need to have one, regardless of whether or not the base class

has one. If your derived class omits the copy constructor or `operator=`, a default copy constructor or `operator=` will be provided for the data members specified in the derived class, and the base class copy constructor or `operator=` will be used for the data members specified in the base class.

On the other hand, if you *do* specify a copy constructor in the derived class, you need to explicitly chain to the parent copy constructor, as shown in the following code. If you do not do this, the default constructor (not the copy constructor!) will be used for the parent portion of the object.

```
class Base
{
    public:
        virtual ~Base() = default;
        Base() = default;
        Base(const Base& src);
};

Base::Base(const Base& src)
{
}

class Derived : public Base
{
    public:
        Derived() = default;
        Derived(const Derived& src);
};

Derived::Derived(const Derived& src) : Base(src)
{
}
```

Similarly, if the derived class overrides `operator=`, it is almost always necessary to call the parent's version of `operator=` as well. The only case where you wouldn't do this would be if there was some bizarre reason why you only wanted part of the object assigned when an assignment took place. The following code shows how to call the parent's assignment operator from the derived class:

```
Derived& Derived::operator=(const Derived& rhs)
{
    if (&rhs == this) {
        return *this;
    }
    Base::operator=(rhs); // Calls parent's operator=.
    // Do necessary assignments for derived class.
    return *this;
}
```

WARNING *If your derived class does not specify its own copy constructor or `operator=`, the base class functionality continues to work. However, if the derived class does provide its own copy constructor or `operator=`, it needs to explicitly call the base class versions.*

NOTE *When you need copy functionality in an inheritance hierarchy, the common idiom employed by professional C++ developers is to implement a polymorphic `clone()` method, because relying on the standard copy constructor and copy assignment operators is not sufficient. The polymorphic `clone()` idiom is discussed in Chapter 12.*

Run-Time Type Facilities

Relative to other object-oriented languages, C++ is very compile-time oriented. As you learned earlier, overriding methods works because of a level of indirection between a method and its implementation, not because the object has built-in knowledge of its own class.

There are, however, features in C++ that provide a run-time view of an object. These features are commonly grouped together under a feature set called *run-time type information*, or *RTTI*. RTTI provides a number of useful features for working with information about an object's class membership. One such feature is `dynamic_cast()`, which allows you to safely convert between types within an object-oriented hierarchy; this was discussed earlier in this chapter. Using `dynamic_cast()` on a class without a vtable, that is, without any virtual methods, causes a compilation error.

A second RTTI feature is the `typeid` operator, which lets you query an object at run time to find out its type. For the most part, you shouldn't ever need to use `typeid` because any code that is conditionally run based on the type of the object would be better handled with virtual methods.

The following code uses `typeid` to print a message based on the type of the object:

```
#include <typeinfo>

class Animal { public: virtual ~Animal() = default; };
class Dog : public Animal {};
class Bird : public Animal {};

void speak(const Animal& animal)
{
    if (typeid(animal) == typeid(Dog)) {
        cout << "Woof!" << endl;
    } else if (typeid(animal) == typeid(Bird)) {
        cout << "Chirp!" << endl;
    }
}
```

Whenever you see code like this, you should immediately consider reimplementing the functionality as a virtual method. In this case, a better implementation would be to declare a virtual method called `speak()` in the `Animal` class. `Dog` would override the method to print "Woof!" and `Bird` would override the method to print "Chirp!". This approach better fits object-oriented programming, where functionality related to objects is given to those objects.

WARNING *The typeid operator only works correctly if the class has at least one virtual method, that is, when the class has a vtable. The typeid operator also strips reference and const qualifiers from its argument.*

One of the primary values of the typeid operator is for logging and debugging purposes. The following code makes use of typeid for logging. The logObject() function takes a “loggable” object as a parameter. The design is such that any object that can be logged inherits from the Loggable class and supports a method called getLogMessage().

```
class Loggable
{
    public:
        virtual ~Loggable() = default;
        virtual std::string getLogMessage() const = 0;
};

class Foo : public Loggable
{
    public:
        std::string getLogMessage() const override;
};

std::string Foo::getLogMessage() const
{
    return "Hello logger.";
}

void logObject(const Loggable& loggableObject)
{
    cout << typeid(loggableObject).name() << ": ";
    cout << loggableObject.getLogMessage() << endl;
}
```

The logObject() function first writes the name of the object’s class to the output stream, followed by its log message. This way, when you read the log later, you can see which object was responsible for every written line. Here is the output generated by Microsoft Visual C++ 2017 when the logObject() function is called with an instance of Foo:

```
class Foo: Hello logger.
```

As you can see, the name returned by the typeid operator is “class Foo”. However, this name depends on your compiler. For example, if you compile the same code with GCC, the output is as follows:

```
3Foo: Hello logger.
```

NOTE *If you are using typeid for purposes other than logging and debugging, consider reimplementing it using virtual methods.*

Non-public Inheritance

In all previous examples, parent classes were always listed using the `public` keyword. You may be wondering if a parent can be `private` or `protected`. In fact, it can, though neither is as common as `public`. If you don't specify any access specifier for the parent, then it is `private` inheritance for a class, and `public` inheritance for a `struct`.

Declaring the relationship with the parent to be `protected` means that all `public` methods and data members from the base class become `protected` in the context of the derived class. Similarly, specifying `private` inheritance means that all `public` and `protected` methods and data members of the base class become `private` in the derived class.

There are a handful of reasons why you might want to uniformly degrade the access level of the parent in this way, but most reasons imply flaws in the design of the hierarchy. Some programmers abuse this language feature, often in combination with multiple inheritance, to implement “components” of a class. Instead of making an `Airplane` class that contains an engine data member and a fuselage data member, they make an `Airplane` class that is a `protected` engine and a `protected` fuselage. In this way, the `Airplane` doesn't look like an engine or a fuselage to client code (because everything is `protected`), but it is able to use all of that functionality internally.

NOTE *Non-public inheritance is rare and I recommend using it cautiously, if for no other reason than because most programmers are not familiar with it.*

Virtual Base Classes

Earlier in this chapter, you learned about ambiguous base classes, a situation that arises when multiple parents each have a parent in common, as shown again in Figure 10-12. The solution that I recommended was to make sure that the shared parent doesn't have any functionality of its own. That way, its methods can never be called and there is no ambiguity problem.

C++ has another mechanism, called *virtual base classes*, for addressing this problem if you do want the shared parent to have its own functionality. If the shared parent is a virtual base class, there will not be any ambiguity. The following code adds a `sleep()` method to the `Animal` base class and modifies the `Dog` and `Bird` classes to inherit from `Animal` as a virtual base class. Without the `virtual` keyword, a call to `sleep()` on a `DogBird` object would be ambiguous and would generate a compiler error because `DogBird` would have two subobjects of class `Animal`, one coming from `Dog` and one coming from `Bird`. However, when `Animal` is inherited virtually, `DogBird` has only one subobject of class `Animal`, so there will be no ambiguity with calling `sleep()`.

```
class Animal
{
    public:
```

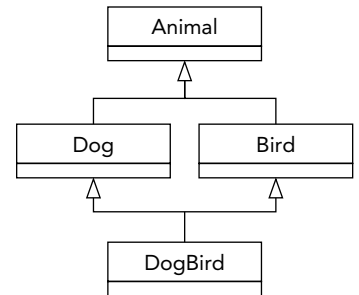

FIGURE 10-12

```
        virtual void eat() = 0;
        virtual void sleep() { cout << "zzzzz...." << endl; }
};

class Dog : public virtual Animal
{
    public:
        virtual void bark() { cout << "Woof!" << endl; }
        virtual void eat() override { cout << "The dog ate." << endl; }
};

class Bird : public virtual Animal
{
    public:
        virtual void chirp() { cout << "Chirp!" << endl; }
        virtual void eat() override { cout << "The bird ate." << endl; }
};

class DogBird : public Dog, public Bird
{
    public:
        virtual void eat() override { Dog::eat(); }
};

int main()
{
    DogBird myConfusedAnimal;
    myConfusedAnimal.sleep(); // Not ambiguous because of virtual base class
    return 0;
}
```

NOTE *Virtual base classes are a great way to avoid ambiguity in class hierarchies. The only drawback is that many C++ programmers are unfamiliar with the concept.*

SUMMARY

This chapter covered numerous details about inheritance. You learned about its many applications, including code reuse and polymorphism. You also learned about its many abuses, including poorly designed multiple-inheritance schemes. Along the way, you uncovered some cases that require special attention.

Inheritance is a powerful language feature that takes some time to get used to. After you have worked with the examples in this chapter and experimented on your own, I hope that inheritance will become your tool of choice for object-oriented design.

11

C++ Quirks, Oddities, and Incidentals

WHAT'S IN THIS CHAPTER?

- What the different use-cases are for references
- Keyword confusion
- How to use type aliases and `typedefs`
- The different casts that you can use
- What scope resolution is
- What you can do with C++ attributes
- How you can define your own user-defined literals
- The standard user-defined literals that are available
- C-style variable-length argument lists and preprocessor macros

WROX.COM DOWNLOADS FOR THIS CHAPTER

Please note that all the code examples for this chapter are available as a part of this chapter's code download on the book's website at www.wrox.com/go/proc++4e on the Download Code tab.

Many parts of the C++ language have tricky syntax or quirky semantics. As a C++ programmer, you grow accustomed to most of this idiosyncratic behavior; it starts to feel natural. However, some aspects of C++ are a source of perennial confusion. Either books never explain them thoroughly enough, or you forget how they work and continually look them up, or both.

This chapter addresses this gap by providing clear explanations for some of C++’s most niggling quirks and oddities.

Many language idiosyncrasies are covered in various chapters throughout this book. This chapter tries not to repeat those topics by limiting itself to subjects that are not covered in detail elsewhere in the book. There is a bit of redundancy with other chapters, but the material is “sliced” in a different way in order to provide you with a new perspective.

The topics of this chapter include references, `const`, `constexpr`, `static`, `extern`, type aliases, `typedefs`, casts, scope resolution, attributes, user-defined literals, header files, variable-length argument lists, and preprocessor macros. Although this list might appear to be a hodgepodge of topics, it is a carefully selected collection of features and confusing aspects of the language.

REFERENCES

Professional C++ code, including much of the code in this book, uses references extensively. It is helpful to step back and think about what exactly references are, and how they behave.

A *reference* in C++ is an *alias* for another variable. All modifications to the reference change the value of the variable to which it refers. You can think of references as implicit pointers that save you the trouble of taking the address of variables and dereferencing the pointer. Alternatively, you can think of references as just another name for the original variable. You can create stand-alone reference variables, use reference data members in classes, accept references as parameters to functions and methods, and return references from functions and methods.

Reference Variables

Reference variables must be initialized as soon as they are created, like this:

```
int x = 3;
int& xRef = x;
```

Subsequent to this assignment, `xRef` is another name for `x`. Any use of `xRef` uses the current value of `x`. Any assignment to `xRef` changes the value of `x`. For example, the following code sets `x` to 10 through `xRef`:

```
xRef = 10;
```

You cannot declare a reference variable outside of a class without initializing it:

```
int& emptyRef; // DOES NOT COMPILE!
```

WARNING *You must always initialize a reference when it is created. Usually, references are created when they are declared, but reference data members need to be initialized in the constructor initializer for the containing class.*

You cannot create a reference to an unnamed value, such as an integer literal, unless the reference is to a `const` value. In the following example, `unnamedRef1` does not compile because it is a

non-const reference to a constant. That would mean you could change the value of the constant, 5, which doesn't make sense. `unnamedRef2` works because it's a const reference, so you cannot for example write `unnamedRef2 = 7`.

```
int& unnamedRef1 = 5;           // DOES NOT COMPILE
const int& unnamedRef2 = 5;    // Works as expected
```

The same holds for temporary objects. You cannot have a non-const reference to a temporary object, but a const reference is fine. For example, suppose you have the following function returning an `std::string` object:

```
std::string getString() { return "Hello world!"; }
```

You can have a const reference to the result of calling `getString()`, and that const reference keeps the `std::string` object alive until the reference goes out of scope:

```
std::string& string1 = getString();           // DOES NOT COMPILE
const std::string& string2 = getString();    // Works as expected
```

Modifying References

A reference always refers to the same variable to which it is initialized; references cannot be changed once they are created. This rule leads to some confusing syntax. If you “assign” a variable to a reference when the reference is declared, the reference refers to that variable. However, if you assign a variable to a reference after that, the variable to which the reference refers is changed to the value of the variable being assigned. The reference is not updated to refer to that variable. Here is a code example:

```
int x = 3, y = 4;
int& xRef = x;
xRef = y; // Changes value of x to 4. Doesn't make xRef refer to y.
```

You might try to circumvent this restriction by taking the address of `y` when you assign it:

```
xRef = &y; // DOES NOT COMPILE!
```

This code does not compile. The address of `y` is a pointer, but `xRef` is declared as a reference to an `int`, not a reference to a pointer.

Some programmers go even further in their attempts to circumvent the intended semantics of references. What if you assign a reference to a reference? Won't that make the first reference refer to the variable to which the second reference refers? You might be tempted to try this code:

```
int x = 3, z = 5;
int& xRef = x;
int& zRef = z;
zRef = xRef; // Assigns values, not references
```

The final line does not change `zRef`. Instead, it sets the value of `z` to 3, because `xRef` refers to `x`, which is 3.

WARNING *You cannot change the variable to which a reference refers after it is initialized; you can change only the value of that variable.*

References to Pointers and Pointers to References

You can create references to any type, including pointer types. Here is an example of a reference to a pointer to `int`:

```
int* intP;  
int*& ptrRef = intP;  
ptrRef = new int;  
*ptrRef = 5;
```

The syntax is a little strange: you might not be accustomed to seeing `*` and `&` right next to each other. However, the semantics are straightforward: `ptrRef` is a reference to `intP`, which is a pointer to `int`. Modifying `ptrRef` changes `intP`. References to pointers are rare, but can occasionally be useful, as discussed in the “Reference Parameters” section later in this chapter.

Note that taking the address of a reference gives the same result as taking the address of the variable to which the reference refers. Here is an example:

```
int x = 3;  
int& xRef = x;  
int* xPtr = &xRef; // Address of a reference is pointer to value  
*xPtr = 100;
```

This code sets `xPtr` to point to `x` by taking the address of a reference to `x`. Assigning 100 to `*xPtr` changes the value of `x` to 100. Writing a comparison “`xPtr == xRef`” will not compile because of a type mismatch; `xPtr` is a pointer to an `int` while `xRef` is a reference to an `int`. The comparisons “`xPtr == &xRef`” and “`xPtr == &x`” both compile without errors and are both `true`.

Finally, note that you cannot declare a reference to a reference, or a pointer to a reference. For example, neither “`int& &`” nor “`int&*`” is allowed.

Reference Data Members

As Chapter 9 explains, data members of classes can be references. A reference cannot exist without referring to some other variable. Thus, you must initialize reference data members in the constructor initializer, not in the body of the constructor. The following is a quick example:

```
class MyClass  
{  
    public:  
        MyClass(int& ref) : mRef(ref) {}  
    private:  
        int& mRef;  
};
```

Consult Chapter 9 for details.

Reference Parameters

C++ programmers do not often use stand-alone reference variables or reference data members. The most common use of references is for parameters to functions and methods. Recall that the default

parameter-passing semantics are pass-by-value: functions receive copies of their arguments. When those parameters are modified, the original arguments remain unchanged. References allow you to specify pass-by-reference semantics for arguments passed to the function. When you use reference parameters, the function receives references to the function arguments. If those references are modified, the changes are reflected in the original argument variables. For example, here is a simple swap function to swap the values of two ints:

```
void swap(int& first, int& second)
{
    int temp = first;
    first = second;
    second = temp;
}
```

You can call it like this:

```
int x = 5, y = 6;
swap(x, y);
```

When `swap()` is called with the arguments `x` and `y`, the `first` parameter is initialized to refer to `x`, and the `second` parameter is initialized to refer to `y`. When `swap()` modifies `first` and `second`, `x` and `y` are actually changed.

Just as you can't initialize normal reference variables with constants, you can't pass constants as arguments to functions that employ pass-by-non-const-reference:

```
swap(3, 4); // DOES NOT COMPILE
```

NOTE *It is possible to pass constants as arguments to functions if you use pass-by-const-reference (discussed later in this chapter) or pass-by-rvalue-reference. Rvalue references are discussed in detail in Chapter 9.*

References from Pointers

A common quandary arises when you have a pointer to something that you need to pass to a function or method that takes a reference. You can “convert” a pointer to a reference in this case by dereferencing the pointer. This action gives you the value to which the pointer points, which the compiler then uses to initialize the reference parameter. For example, you can call `swap()` like this:

```
int x = 5, y = 6;
int *xp = &x, *yp = &y;
swap(*xp, *yp);
```

Pass-by-Reference versus Pass-by-Value

Pass-by-reference is required when you want to modify the parameter and see those changes reflected in the variable passed to the function or method. However, you should not limit your use

of pass-by-reference to only those cases. Pass-by-reference avoids copying the arguments to the function, providing two additional benefits in some cases:

1. **Efficiency.** Large objects and `structs` could take a long time to copy. Pass-by-reference passes only a reference to the object or `struct` into the function.
2. **Correctness.** Not all objects allow pass-by-value. Even those that do allow it might not support deep copying correctly. As Chapter 9 explains, objects with dynamically allocated memory must provide a custom copy constructor and copy assignment operator in order to support deep copying.

If you want to leverage these benefits, but do not want to allow the original objects to be modified, you should mark the parameters `const`, giving you pass-by-const-reference. This topic is covered in detail later in this chapter.

These benefits to pass-by-reference imply that you should use pass-by-value only for simple built-in types like `int` and `double` for which you don't need to modify the arguments. Use pass-by-const-reference or pass-by-reference in all other cases.

Reference Return Values

You can also return a reference from a function or method. The main reason to do so is efficiency. Instead of returning a whole object, return a reference to the object to avoid copying it unnecessarily. Of course, you can only use this technique if the object in question continues to exist following the function termination.

WARNING *From a function or method, never return a reference to a variable that is locally scoped to that function or method, such as an automatically allocated variable on the stack that will be destroyed when the function ends.*

Note that if the type you want to return from your function supports move semantics, discussed in Chapter 9, then returning it by value is almost as efficient as returning a reference.

A second reason to return a reference is if you want to be able to assign to the return value directly as an *lvalue* (the left-hand side of an assignment statement). Several overloaded operators commonly return references. Chapter 9 shows some examples, and you can read about more applications of this technique in Chapter 15.

Rvalue References

An *rvalue* is anything that is not an lvalue, such as a constant value, or a temporary object or value. Typically, an rvalue is on the right-hand side of an assignment operator. Rvalue references are discussed in detail in Chapter 9, but here is a quick reminder:

```
// lvalue reference parameter
void handleMessage(std::string& message)
{
    cout << "handleMessage with lvalue reference: " << message << endl;
}
```

With only this version of `handleMessage()`, you cannot call it as follows:

```
handleMessage("Hello World"); // A literal is not an lvalue.

std::string a = "Hello ";
std::string b = "World";
handleMessage(a + b); // A temporary is not an lvalue.
```

To allow these kinds of calls, you need a version that accepts an rvalue reference:

```
// rvalue reference parameter
void handleMessage(std::string&& message)
{
    cout << "handleMessage with rvalue reference: " << message << endl;
}
```

See Chapter 9 for more details.

Deciding between References and Pointers

References in C++ could be considered redundant: everything you can do with references, you can accomplish with pointers. For example, you could write the earlier shown `swap()` function like this:

```
void swap(int* first, int* second)
{
    int temp = *first;
    *first = *second;
    *second = temp;
}
```

However, this code is more cluttered than the version with references. References make your programs cleaner and easier to understand. They are also safer than pointers: it's impossible to have a null reference, and you don't explicitly dereference references, so you can't encounter any of the dereferencing errors associated with pointers. These arguments, saying that references are safer, are only valid in the absence of any pointers. For example, take the following function that accepts a reference to an `int`:

```
void refcall(int& t) { ++t; }
```

You could declare a pointer and initialize it to point to some random place in memory. Then you could dereference this pointer and pass it as the reference argument to `refcall()`, as in the following code. This code compiles fine, but it is undefined what will happen when executed. It could for example cause a crash.

```
int* ptr = (int*)8;
refcall(*ptr);
```

Most of the time, you can use references instead of pointers. References to objects even support polymorphism in the same way as pointers to objects. However, there are some use-cases in which you need to use a pointer. One example is when you need to change the location to which it points. Recall that you cannot change the variable to which references refer. For example, when you dynamically allocate memory, you need to store a pointer to the result in a pointer rather than a reference. A second use-case in which you need to use a pointer is when the pointer is optional, that is, when it can be `nullptr`. Yet another use-case is if you want to store polymorphic types in a container.

A way to distinguish between appropriate use of pointers and references in parameters and return types is to consider who *owns* the memory. If the code receiving the variable becomes the owner and thus becomes responsible for releasing the memory associated with an object, it must receive a pointer to the object. Better yet, it should receive a smart pointer, which is the recommended way to transfer ownership. If the code receiving the variable should not free the memory, it should receive a reference.

NOTE *Prefer references over pointers, that is, only use a pointer if a reference is not possible.*

Consider a function that splits an array of `ints` into two arrays: one of even numbers and one of odd numbers. The function doesn't know how many numbers in the source array will be even or odd, so it should dynamically allocate the memory for the destination arrays after examining the source array. It should also return the sizes of the two new arrays. Altogether, there are four items to return: pointers to the two new arrays and the sizes of the two new arrays. Obviously, you must use pass-by-reference. The canonical C way to write the function looks like this:

```
void separateOddsAndEvens(const int arr[], size_t size, int** odds,
    size_t* numOdds, int** evens, size_t* numEvens)
{
    // Count the number of odds and evens
    *numOdds = *numEvens = 0;
    for (size_t i = 0; i < size; ++i) {
        if (arr[i] % 2 == 1) {
            ++(*numOdds);
        } else {
            ++(*numEvens);
        }
    }

    // Allocate two new arrays of the appropriate size.
    *odds = new int[*numOdds];
    *evens = new int[*numEvens];

    // Copy the odds and evens to the new arrays
    size_t oddsPos = 0, evensPos = 0;
    for (size_t i = 0; i < size; ++i) {
        if (arr[i] % 2 == 1) {
            (*odds)[oddsPos++] = arr[i];
        } else {
            (*evens)[evensPos++] = arr[i];
        }
    }
}
```

The final four parameters to the function are the “reference” parameters. In order to change the values to which they refer, `separateOddsAndEvens()` must dereference them, leading to some ugly syntax in the function body. Additionally, when you want to call `separateOddsAndEvens()`, you must pass the address of two pointers so that the function can change the actual pointers, and the

address of two ints so that the function can change the actual ints. Note also that the caller is responsible for deleting the two arrays created by `separateOddsAndEvens()`!

```
int unSplit[] = {1, 2, 3, 4, 5, 6, 7, 8, 9, 10};
int* oddNums = nullptr;
int* evenNums = nullptr;
size_t numOdds = 0, numEvens = 0;

separateOddsAndEvens(unSplit, std::size(unSplit),
    &oddNums, &numOdds, &evenNums, &numEvens);

// Use the arrays...

delete[] oddNums; oddNums = nullptr;
delete[] evenNums; evenNums = nullptr;
```

If this syntax annoys you (which it should), you can write the same function by using references to obtain true pass-by-reference semantics:

```
void separateOddsAndEvens(const int arr[], size_t size, int*& odds,
    size_t& numOdds, int*& evens, size_t& numEvens)
{
    numOdds = numEvens = 0;
    for (size_t i = 0; i < size; ++i) {
        if (arr[i] % 2 == 1) {
            ++numOdds;
        } else {
            ++numEvens;
        }
    }

    odds = new int[numOdds];
    evens = new int[numEvens];

    size_t oddsPos = 0, evensPos = 0;
    for (size_t i = 0; i < size; ++i) {
        if (arr[i] % 2 == 1) {
            odds[oddsPos++] = arr[i];
        } else {
            evens[evensPos++] = arr[i];
        }
    }
}
```

In this case, the `odds` and `evens` parameters are references to `int*`s. `separateOddsAndEvens()` can modify the `int*`s that are used as arguments to the function (through the reference), without any explicit dereferencing. The same logic applies to `numOdds` and `numEvens`, which are references to ints. With this version of the function, you no longer need to pass the addresses of the pointers or ints. The reference parameters handle it for you automatically:

```
separateOddsAndEvens(unSplit, std::size(unSplit),
    oddNums, numOdds, evenNums, numEvens);
```

Even though using reference parameters is already much cleaner than using pointers, it is recommended that you avoid dynamically allocated arrays as much as possible. For example, by using the

Standard Library `vector` container, the previous `separateOddsAndEvens()` function can be rewritten to be much safer, more elegant, and much more readable, because all memory allocation and deallocation happens automatically:

```
void separateOddsAndEvens(const vector<int>& arr,
    vector<int>& odds, vector<int>& evens)
{
    for (int i : arr) {
        if (i % 2 == 1) {
            odds.push_back(i);
        } else {
            evens.push_back(i);
        }
    }
}
```

This version can be used as follows:

```
vector<int> vecUnSplit = {1, 2, 3, 4, 5, 6, 7, 8, 9, 10};
vector<int> odds, evens;
separateOddsAndEvens(vecUnSplit, odds, evens);
```

Note that you don't need to deallocate the `odds` and `evens` containers; the `vector` class takes care of this. This version is much easier to use than the versions using pointers or references. The Standard Library `vector` container is discussed in detail in Chapter 17.

C++17

The version using `vectors` is already much better than the versions using pointers or references, but it's usually recommended to avoid output parameters as much as possible. If a function needs to return something, you should just return it, instead of using output parameters. Especially since C++11 introduced move semantics, returning something by value from a function is efficient. And now that C++17 has introduced structured bindings, see Chapter 1, it is really convenient to return multiple values from a function.

So, for the `separateOddsAndEvens()` function, instead of accepting two output vectors, it should simply return a pair of vectors. The `std::pair` utility class, defined in `<utility>`, is discussed in detail in Chapter 17, but its use is rather straightforward. Basically, a `pair` can store two values of two different or equal types. It's a class template, and it requires two types between the angle brackets to specify the type of both values. A `pair` can be created using `std::make_pair()`. Here is the `separateOddsAndEvens()` function returning a pair of vectors:

```
pair<vector<int>, vector<int>> separateOddsAndEvens(const vector<int>& arr)
{
    vector<int> odds, evens;
    for (int i : arr) {
        if (i % 2 == 1) {
            odds.push_back(i);
        } else {
            evens.push_back(i);
        }
    }
    return make_pair(odds, evens);
}
```

By using a structured binding, the code to call `separateOddsAndEvens()` becomes very compact, yet very easy to read and understand:

```
vector<int> vecUnSplit = {1, 2, 3, 4, 5, 6, 7, 8, 9, 10};
auto[odds, evens] = separateOddsAndEvens(vecUnSplit);
```

KEYWORD CONFUSION

Two keywords in C++ appear to cause more confusion than any others: `const` and `static`. Both of these keywords have several different meanings, and each of their uses presents subtleties that are important to understand.

The `const` Keyword

The keyword `const` is short for “constant” and specifies that something remains unchanged. The compiler enforces this requirement by marking any attempt to change it as an error. Furthermore, when optimizations are enabled, the compiler can take advantage of this knowledge to produce better code. The keyword has two related roles. It can mark variables or parameters, and it can mark methods. This section provides a definitive discussion of these two meanings.

`const` Variables and Parameters

You can use `const` to “protect” variables by specifying that they cannot be modified. One important use is as a replacement for `#define` to define constants. This use of `const` is its most straightforward application. For example, you could declare the constant `PI` like this:

```
const double PI = 3.141592653589793238462;
```

You can mark any variable `const`, including global variables and class data members.

You can also use `const` to specify that parameters to functions or methods should remain unchanged. For example, the following function accepts a `const` parameter. In the body of the function, you cannot modify the `param` integer. If you do try to modify it, the compiler will generate an error.

```
void func(const int param)
{
    // Not allowed to change param...
}
```

The following subsections discuss two special kinds of `const` variables or parameters in more detail: `const` pointers and `const` references.

`const` Pointers

When a variable contains one or more levels of indirection via a pointer, applying `const` becomes trickier. Consider the following lines of code:

```
int* ip;
ip = new int[10];
ip[4] = 5;
```

Suppose that you decide to apply `const` to `ip`. Set aside your doubts about the usefulness of doing so for a moment, and consider what it means. Do you want to prevent the `ip` variable itself from being changed, or do you want to prevent the values to which it points from being changed? That is, do you want to prevent the second line or the third line?

In order to prevent the pointed-to values from being modified (as in the third line), you can add the keyword `const` to the declaration of `ip` like this:

```
const int* ip;
ip = new int[10];
ip[4] = 5; // DOES NOT COMPILE!
```

Now you cannot change the values to which `ip` points.

An alternative but semantically equivalent way to write this is as follows:

```
int const* ip;
ip = new int[10];
ip[4] = 5; // DOES NOT COMPILE!
```

Putting the `const` before or after the `int` makes no difference in its functionality.

If you instead want to mark `ip` itself `const` (not the values to which it points), you need to write this:

```
int* const ip = nullptr;
ip = new int[10]; // DOES NOT COMPILE!
ip[4] = 5; // Error: dereferencing a null pointer
```

Now that `ip` itself cannot be changed, the compiler requires you to initialize it when you declare it, either with `nullptr` as in the preceding code or with newly allocated memory as follows:

```
int* const ip = new int[10];
ip[4] = 5;
```

You can also mark both the pointer and the values to which it points `const` like this:

```
int const* const ip = nullptr;
```

Here is an alternative but equivalent syntax:

```
const int* const ip = nullptr;
```

Although this syntax might seem confusing, there is actually a very simple rule: the `const` keyword applies to whatever is directly to its left. Consider this line again:

```
int const* const ip = nullptr;
```

From left to right, the first `const` is directly to the right of the word `int`. Thus, it applies to the `int` to which `ip` points. Therefore, it specifies that you cannot change the values to which `ip` points. The second `const` is directly to the right of the `*`. Thus, it applies to the pointer to the `int`, which is the `ip` variable. Therefore, it specifies that you cannot change `ip` (the pointer) itself.

The reason this rule becomes confusing is an exception. That is, the first `const` can go before the variable like this:

```
const int* const ip = nullptr;
```

This “exceptional” syntax is used much more commonly than the other syntax.

You can extend this rule to any number of levels of indirection, as in this example:

```
const int * const * const * const ip = nullptr;
```

NOTE *Another easy-to-remember rule to figure out complicated variable declarations: read from right to left. Take, for example, “int* const ip.” Reading this from right to left gives you “ip is a const pointer to an int.” On the other hand, “int const* ip” reads as “ip is a pointer to a const int.”*

const References

`const` applied to references is usually simpler than `const` applied to pointers for two reasons. First, references are `const` by default, in that you can’t change to what they refer. So, there is no need to mark them `const` explicitly. Second, you can’t create a reference to a reference, so there is usually only one level of indirection with references. The only way to get multiple levels of indirection is to create a reference to a pointer.

Thus, when C++ programmers refer to a “const reference,” they mean something like this:

```
int z;
const int& zRef = z;
zRef = 4; // DOES NOT COMPILE
```

By applying `const` to the `int&`, you prevent assignment to `zRef`, as shown. Similar to pointers, `const int& zRef` is equivalent to `int const& zRef`. Note, however, that marking `zRef` `const` has no effect on `z`. You can still modify the value of `z` by changing it directly instead of through the reference.

`const` references are used most commonly as parameters, where they are quite useful. If you want to pass something by reference for efficiency, but don’t want it to be modifiable, make it a `const` reference, as in this example:

```
void doSomething(const BigClass& arg)
{
    // Implementation here
}
```

WARNING *Your default choice for passing objects as parameters should be const reference. You should only omit the const if you explicitly need to change the object.*

const Methods

Chapter 9 explains that you can mark a class method `const`, which prevents the method from modifying any non-`mutable` data members of the class. Consult Chapter 9 for an example.

The constexpr Keyword

C++ always had the notion of constant expressions, and in some circumstances constant expressions are required. For example, when defining an array, the size of the array needs to be a constant expression. Because of this restriction, the following piece of code is not valid in C++:

```
const int getArraySize() { return 32; }

int main()
{
    int myArray[getArraySize()];    // Invalid in C++
    return 0;
}
```

Using the `constexpr` keyword, the `getArraySize()` function can be redefined to make it a *constant expression*. Constant expressions are evaluated at compile time!

```
constexpr int getArraySize() { return 32; }

int main()
{
    int myArray[getArraySize()];    // OK
    return 0;
}
```

You can even do something like this:

```
int myArray[getArraySize() + 1];    // OK
```

Declaring a function as `constexpr` imposes quite a lot of restrictions on what the function can do because the compiler has to be able to evaluate the function at compile time, and the function is not allowed to have any side effects. Here are a couple of restrictions, although this is not an exhaustive list:

- The function body shall not contain any `goto` statements, try catch blocks, uninitialized variables, or variable definitions that are not literal types,¹ and shall not throw any exceptions. It is allowed to call other `constexpr` functions.
- The return type of the function shall be a literal type.
- If the `constexpr` function is a member of a class, the function cannot be `virtual`.
- All the function parameters shall be literal types.
- A `constexpr` function cannot be called until it's defined in the translation unit because the compiler needs to know the complete definition.
- `dynamic_cast()` and `reinterpret_cast()` are not allowed.
- `new` and `delete` expressions are not allowed.

¹A *literal type* is the type of `constexpr` variables. They can be returned from `constexpr` functions. A literal type can be a `void` (possibly `const/volatile` qualified), a scalar type (integral and floating point types, enumeration types, pointer types, pointer to member types, and `const/volatile` qualified versions of these types), a reference type, an array of literal type, or a class type (possibly `const/volatile` qualified) that has a trivial (that is, not user-provided) destructor, has at least one `constexpr` constructor, and all of its non-`static` data members and base classes are literal types.

By defining a `constexpr` constructor, you can create constant expression variables of user-defined types. A `constexpr` constructor also has a lot of restrictions. Here are some of them:

- The class cannot have any virtual base classes.
- All the constructor parameters shall be literal types.
- The constructor body cannot be a function-try-block (see Chapter 14).
- The constructor body either shall be explicitly defaulted, or shall satisfy the same requirements as the body of a `constexpr` function.
- All data members shall be initialized with constant expressions.

For example, the following `Rect` class defines a `constexpr` constructor satisfying the previous requirements. It also defines a `constexpr` `getArea()` method that is performing some calculation.

```
class Rect
{
public:
    constexpr Rect(size_t width, size_t height)
        : mWidth(width), mHeight(height) {}

    constexpr size_t getArea() const { return mWidth * mHeight; }
private:
    size_t mWidth, mHeight;
};
```

Using this class to declare a `constexpr` object is straightforward:

```
constexpr Rect r(8, 2);
int myArray[r.getArea()];    // OK
```

The static Keyword

There are several uses of the keyword `static` in C++, all seemingly unrelated. Part of the motivation for “overloading” the keyword was attempting to avoid having to introduce new keywords into the language.

static Data Members and Methods

You can declare `static` data members and methods of classes. `static` data members, unlike non-`static` data members, are not part of each object. Instead, there is only one copy of the data member, which exists outside any objects of that class.

`static` methods are similarly at the class level instead of the object level. A `static` method does not execute in the context of a specific object.

Chapter 9 provides examples of both `static` data members and methods.

static Linkage

Before covering the use of the `static` keyword for linkage, you need to understand the concept of *linkage* in C++. C++ source files are each compiled independently, and the resulting object files are

linked together. Each name in a C++ source file, including functions and global variables, has a linkage that is either *external* or *internal*. External linkage means that the name is available from other source files. Internal linkage (also called *static linkage*) means that it is not. By default, functions and global variables have external linkage. However, you can specify internal (or static) linkage by prefixing the declaration with the keyword `static`. For example, suppose you have two source files: `FirstFile.cpp` and `AnotherFile.cpp`. Here is `FirstFile.cpp`:

```
void f();

int main()
{
    f();
    return 0;
}
```

Note that this file provides a prototype for `f()`, but doesn't show the definition. Here is `AnotherFile.cpp`:

```
#include <iostream>

void f();

void f()
{
    std::cout << "f\n";
}
```

This file provides both a prototype and a definition for `f()`. Note that it is legal to write prototypes for the same function in two different files. That's precisely what the preprocessor does for you if you put the prototype in a header file that you `#include` in each of the source files. The reason to use header files is that it's easier to maintain (and keep synchronized) one copy of the prototype. However, for this example, I don't use a header file.

Each of these source files compiles without error, and the program links fine: because `f()` has external linkage, `main()` can call it from a different file.

However, suppose you apply `static` to the `f()` prototype in `AnotherFile.cpp`. Note that you don't need to repeat the `static` keyword in front of the definition of `f()`. As long as it precedes the first instance of the function name, there is no need to repeat it:

```
#include <iostream>

static void f();

void f()
{
    std::cout << "f\n";
}
```

Now each of the source files compiles without error, but the linker step fails because `f()` has internal (static) linkage, making it unavailable from `FirstFile.cpp`. Some compilers issue a warning when `static` methods are defined but not used in that source file (implying that they shouldn't be `static`, because they're probably used elsewhere).

An alternative to using `static` for internal linkage is to employ *anonymous namespaces*. Instead of marking a variable or function `static`, wrap it in an unnamed namespace like this:

```
#include <iostream>

namespace {
    void f();

    void f()
    {
        std::cout << "f\n";
    }
}
```

Entities in an anonymous namespace can be accessed anywhere following their declaration in the same source file, but cannot be accessed from other source files. These semantics are the same as those obtained with the `static` keyword.

WARNING *The recommended method to get internal linkage is to use anonymous namespaces, instead of the `static` keyword.*

The extern Keyword

A related keyword, `extern`, seems like it should be the opposite of `static`, specifying external linkage for the names it precedes. It can be used that way in certain cases. For example, `consts` and `typedefs` have internal linkage by default. You can use `extern` to give them external linkage. However, `extern` has some complications. When you specify a name as `extern`, the compiler treats it as a declaration, not a definition. For variables, this means the compiler doesn't allocate space for the variable. You must provide a separate definition line for the variable without the `extern` keyword. For example, here is the content of `AnotherFile.cpp`:

```
extern int x;
int x = 3;
```

Alternatively, you can initialize `x` in the `extern` line, which then serves as the declaration and definition:

```
extern int x = 3;
```

The `extern` in this case is not very useful, because `x` has external linkage by default anyway. The real use of `extern` is when you want to use `x` from another source file, `FirstFile.cpp`:

```
#include <iostream>

extern int x;

int main()
{
    std::cout << x << std::endl;
}
```

Here, `FirstFile.cpp` uses an `extern` declaration so that it can use `x`. The compiler needs a declaration of `x` in order to use it in `main()`. If you declared `x` without the `extern` keyword, the compiler would think it's a definition and would allocate space for `x`, causing the linkage step to fail (because there are now two `x` variables in the global scope). With `extern`, you can make variables globally accessible from multiple source files.

WARNING *It is not recommended to use global variables at all. They are confusing and error-prone, especially in large programs. Use them judiciously!*

static Variables in Functions

The final use of the `static` keyword in C++ is to create local variables that retain their values between exits and entrances to their scope. A `static` variable inside a function is like a global variable that is only accessible from that function. One common use of `static` variables is to “remember” whether a particular initialization has been performed for a certain function. For example, code that employs this technique might look something like this:

```
void performTask()
{
    static bool initialized = false;
    if (!initialized) {
        cout << "initializing" << endl;
        // Perform initialization.
        initialized = true;
    }
    // Perform the desired task.
}
```

However, `static` variables are confusing, and there are usually better ways to structure your code so that you can avoid them. In this case, you might want to write a class in which the constructor performs the required initialization.

NOTE *Avoid using stand-alone static variables. Maintain state within an object instead.*

Sometimes, however, they are quite useful. One example is for implementing the Meyer's singleton design pattern, as explained in Chapter 29.

NOTE *The implementation of `performTask()` is not thread-safe; it contains a race condition. In a multithreaded environment, you need to use atomics or other mechanisms for synchronization of multiple threads. Multithreading is discussed in detail in Chapter 23.*

Order of Initialization of Nonlocal Variables

Before leaving the topic of `static` data members and global variables, consider the order of initialization of these variables. All global variables and `static` class data members in a program are initialized before `main()` begins. The variables in a given source file are initialized in the order they appear in the source file. For example, in the following file, `Demo::x` is guaranteed to be initialized before `y`:

```
class Demo
{
    public:
        static int x;
};
int Demo::x = 3;
int y = 4;
```

However, C++ provides no specifications or guarantees about the initialization ordering of nonlocal variables in different source files. If you have a global variable `x` in one source file and a global variable `y` in another, you have no way of knowing which will be initialized first. Normally, this lack of specification isn't cause for concern. However, it can be problematic if one global or `static` variable depends on another. Recall that initialization of objects implies running their constructors. The constructor of one global object might access another global object, assuming that it is already constructed. If these two global objects are declared in two different source files, you cannot count on one being constructed before the other, and you cannot control the order of initialization. This order might not be the same for different compilers or even different versions of the same compiler, and the order might even change when you simply add another file to your project.

WARNING *Initialization order of nonlocal variables in different source files is undefined.*

Order of Destruction of Nonlocal Variables

Nonlocal variables are destroyed in the reverse order they were initialized. Nonlocal variables in different source files are initialized in an undefined order, which means that the order of destruction is also undefined.

TYPES AND CASTS

The basic types in C++ are reviewed in Chapter 1, while Chapter 8 shows you how to write your own types with classes. This section explores some of the trickier aspects of types: type aliases, type aliases for function pointers, type aliases for pointers to methods and data members, `typedefs`, and casts.

Type Aliases

A *type alias* provides a new name for an existing type declaration. You can think of a type alias as syntax for introducing a synonym for an existing type declaration without creating a new type. The following gives a new name, `IntPtr`, to the `int*` type declaration:

```
using IntPtr = int*;
```

You can use the new type name and the definition it aliases interchangeably. For example, the following two lines are valid:

```
int* p1;
IntPtr p2;
```

Variables created with the new type name are completely compatible with those created with the original type declaration. So, it is perfectly valid, given these definitions, to write the following, because they are not just “compatible” types, they are the same type:

```
p1 = p2;
p2 = p1;
```

The most common use for type aliases is to provide manageable names when the real type declarations become too unwieldy. This situation commonly arises with templates. For example, Chapter 1 introduces the `std::vector` from the Standard Library. To declare a vector of strings, you need to declare it as `std::vector<std::string>`. It’s a templated class, and thus requires you to specify the template parameters any time you want to refer to the type of this `vector`. Templates are discussed in detail in Chapter 12. For declaring variables, specifying function parameters, and so on, you would have to write `std::vector<std::string>`:

```
void processVector(const std::vector<std::string>& vec) { /* omitted */ }

int main()
{
    std::vector<std::string> myVector;
    processVector(myVector);
    return 0;
}
```

With a type alias, you can create a shorter, more meaningful name:

```
using StringVector = std::vector<std::string>;

void processVector(const StringVector& vec) { /* omitted */ }

int main()
{
    StringVector myVector;
    processVector(myVector);
    return 0;
}
```

Type aliases can include the scope qualifiers. The preceding example shows this by including the scope `std` for `StringVector`.

The Standard Library uses type aliases extensively to provide shorter names for types. For example, `std::string` is actually a type alias that looks like this:

```
using string = basic_string<char>;
```

Type Aliases for Function Pointers

You don't normally think about the location of functions in memory, but each function actually lives at a particular address. In C++, you can use *functions as data*. In other words, you can take the address of a function and use it like you use a variable.

Function pointers are typed according to the parameter types and return type of compatible functions. One way to work with function pointers is to use a type alias. A type alias allows you to assign a type name to the family of functions that have the given characteristics. For example, the following line defines a type called `MatchFunction` that represents a pointer to any function that has two `int` parameters and returns a `bool`:

```
using MatchFunction = bool (*)(int, int);
```

Now that this new type exists, you can write a function that takes a `MatchFunction` as a parameter. For example, the following function accepts two `int` arrays and their size, as well as a `MatchFunction`. It iterates through the arrays in parallel and calls the `MatchFunction` on corresponding elements of both arrays, printing a message if the call returns `true`. Notice that even though the `MatchFunction` is passed in as a variable, it can be called just like a regular function:

```
void findMatches(int values1[], int values2[], size_t numValues,
                MatchFunction matcher)
{
    for (size_t i = 0; i < numValues; i++) {
        if (matcher(values1[i], values2[i])) {
            cout << "Match found at position " << i <<
                " (" << values1[i] << ", " << values2[i] << ")" << endl;
        }
    }
}
```

Note that this implementation requires that both arrays have at least `numValues` elements.

To call the `findMatches()` function, all you need is any function that adheres to the defined `MatchFunction` type—that is, any type that takes in two `ints` and returns a `bool`. For example, consider the following function, which returns `true` if the two parameters are equal:

```
bool intEqual(int item1, int item2)
{
    return item1 == item2;
}
```

Because the `intEqual()` function matches the `MatchFunction` type, it can be passed as the final argument to `findMatches()`, as follows:

```
int arr1[] = { 2, 5, 6, 9, 10, 1, 1 };
int arr2[] = { 4, 4, 2, 9, 0, 3, 4 };
```

```
size_t arrSize = std::size(arr1); // Pre-C++17: sizeof(arr1)/sizeof(arr1[0]);
cout << "Calling findMatches() using intEqual():" << endl;
findMatches(arr1, arr2, arrSize, &intEqual);
```

The `intEqual()` function is passed into the `findMatches()` function by taking its address. Technically, the `&` character is optional—if you omit it and only put the function name, the compiler will know that you mean to take its address. The output is as follows:

```
Calling findMatches() using intEqual():
Match found at position 3 (9, 9)
```

The benefit of function pointers lies in the fact that `findMatches()` is a generic function that compares parallel values in two arrays. As it is used here, it compares based on equality. However, because it takes a function pointer, it could compare based on other criteria. For example, the following function also adheres to the definition of `MatchFunction`:

```
bool bothOdd(int item1, int item2)
{
    return item1 % 2 == 1 && item2 % 2 == 1;
}
```

The following code calls `findMatches()` using `bothOdd`:

```
cout << "Calling findMatches() using bothOdd():" << endl;
findMatches(arr1, arr2, arrSize, &bothOdd);
```

The output is as follows:

```
Calling findMatches() using bothOdd():
Match found at position 3 (9, 9)
Match found at position 5 (1, 3)
```

By using function pointers, a single function, `findMatches()`, is customized to different uses based on a parameter, `matcher`.

NOTE *Instead of using these old-style function pointers, you can also use `std::function`, which is explained in Chapter 18.*

While function pointers in C++ are uncommon, you may need to obtain function pointers in certain cases. Perhaps the most common example of this is when obtaining a pointer to a function in a dynamic link library. The following example obtains a pointer to a function in a Microsoft Windows Dynamic Link Library (DLL). Details of Windows DLLs are outside the scope of this book on platform-independent C++, but it is so important to Windows programmers that it is worth discussing, and it is a good example to explain the details of function pointers in general.

Consider a DLL, `hardware.dll`, that has a function called `Connect()`. You would like to load this library only if you need to call `Connect()`. Loading the library at run-time is done with the Windows `LoadLibrary()` kernel function:

```
HMODULE lib = ::LoadLibrary("hardware.dll");
```

The result of this call is what is called a “library handle” and will be `NULL` if there is an error. Before you can load the function from the library, you need to know the prototype for the function. Suppose the following is the prototype for `Connect()`, which returns an integer and accepts three parameters: a Boolean, an integer, and a C-style string.

```
int __stdcall Connect(bool b, int n, const char* p);
```

The `__stdcall` is a Microsoft-specific directive to specify how parameters are passed to the function and how they are cleaned up.

You can now use a type alias to define a name (`ConnectFunction`) for a pointer to a function with the preceding prototype:

```
using ConnectFunction = int(__stdcall*)(bool, int, const char*);
```

Having successfully loaded the library and defined a name for the function pointer, you can get a pointer to the function in the library as follows:

```
ConnectFunction connect = (ConnectFunction)::GetProcAddress(lib, "Connect");
```

If this fails, `connect` will be `nullptr`. If it succeeds, you can call the loaded function:

```
connect(true, 3, "Hello world");
```

A C programmer might think that you need to dereference the function pointer before calling it as follows:

```
(*connect)(true, 3, "Hello world");
```

This was true decades ago, but now, every C and C++ compiler is smart enough to know how to automatically dereference a function pointer before calling it.

Type Aliases for Pointers to Methods and Data Members

You can create and use pointers to both variables and functions. Now, consider pointers to class data members and methods. It’s perfectly legitimate in C++ to take the addresses of class data members and methods in order to obtain pointers to them. However, you can’t access a non-`static` data member or call a non-`static` method without an object. The whole point of class data members and methods is that they exist on a per-object basis. Thus, when you want to call the method or access the data member via the pointer, you must dereference the pointer in the context of an object. Here is an example using the `Employee` class introduced in Chapter 1:

```
Employee employee;
int (Employee::*methodPtr) () const = &Employee::getSalary;
cout << (employee.*methodPtr) () << endl;
```

Don’t panic at the syntax. The second line declares a variable called `methodPtr` of type pointer to a non-`static` `const` method of `Employee` that takes no arguments and returns an `int`. At the same time, it initializes this variable to point to the `getSalary()` method of the `Employee` class. This syntax is quite similar to declaring a simple function pointer, except for the addition of `Employee::` before the `*methodPtr`. Note also that the `&` is required in this case.

The third line calls the `getSalary()` method (via the `methodPtr` pointer) on the `employee` object. Note the use of parentheses surrounding `employee.*methodPtr`. They are needed because `()` has higher precedence than `*`.

The second line can be made easier to read with a type alias:

```
Employee employee;
using PtrToGet = int (Employee::*) () const;
PtrToGet methodPtr = &Employee::getSalary;
cout << (employee.*methodPtr) () << endl;
```

Using `auto`, it can be simplified even further:

```
Employee employee;
auto methodPtr = &Employee::getSalary;
cout << (employee.*methodPtr) () << endl;
```

NOTE You can get rid of the `(.*)` syntax by using `std::mem_fn()`. This is explained in the context of function objects in Chapter 18.

Pointers to methods and data members usually won't come up in your programs. However, it's important to keep in mind that you can't dereference a pointer to a non-static method or data member without an object. Every so often, you may want to try something like passing a pointer to a non-static method to a function such as `qsort()` that requires a function pointer, which simply won't work.

NOTE C++ does permit you to dereference a pointer to a static data member or static method without an object.

typedefs

Type aliases were introduced in C++11. Before C++11, you had to use `typedefs` to accomplish something similar but in a more convoluted way.

Just as a type alias, a `typedef` provides a new name for an existing type declaration. For example, take the following type alias:

```
using IntPtr = int*;
```

Without type aliases, you had to use a `typedef` which looked as follows:

```
typedef int* IntPtr;
```

As you can see, it's much less readable! The order is reversed, which causes a lot of confusion, even for professional C++ developers. Other than being more convoluted, a `typedef` behaves almost the same as a type alias. For example, the `typedef` can be used as follows:

```
IntPtr p;
```

Before type aliases were introduced, you also had to use `typedefs` for function pointers, which is even more convoluted. For example, take the following type alias:

```
using FunctionType = int (*)(char, double);
```

Defining the same `FunctionType` with a `typedef` looks as follows:

```
typedef int (*FunctionType)(char, double);
```

This is more convoluted because the name `FunctionType` is somewhere in the middle of it.

Type aliases and `typedefs` are not entirely equivalent. Compared to `typedefs`, type aliases are more powerful when used with templates, but that is covered in Chapter 12 because it requires more details about templates.

WARNING *Always prefer type aliases over typedefs.*

Casts

C++ provides four specific casts: `const_cast()`, `static_cast()`, `reinterpret_cast()`, and `dynamic_cast()`.

The old C-style casts with `()` still work in C++, and are still used extensively in existing code bases. C-style casts cover all four C++ casts, so they are more error-prone because it's not always obvious what you are trying to achieve, and you might end up with unexpected results. I strongly recommend you only use the C++ style casts in new code because they are safer and stand out better syntactically in your code.

This section describes the purposes of each C++ cast and specifies when you would use each of them.

`const_cast()`

`const_cast()` is the most straightforward of the different casts available. You can use it to add `const`-ness to a variable, or cast away `const`-ness of a variable. It is the only cast of the four that is allowed to cast away `const`-ness. Theoretically, of course, there should be no need for a `const` cast. If a variable is `const`, it should stay `const`. In practice, however, you sometimes find yourself in a situation where a function is specified to take a `const` variable, which it must then pass to a function that takes a non-`const` variable. The “correct” solution would be to make `const` consistent in the program, but that is not always an option, especially if you are using third-party libraries. Thus, you sometimes need to cast away the `const`-ness of a variable, but you should only do this when you are sure the function you are calling will not modify the object; otherwise, there is no other option than to restructure your program. Here is an example:

```
extern void ThirdPartyLibraryMethod(char* str);

void f(const char* str)
{
    ThirdPartyLibraryMethod(const_cast<char*>(str));
}
```

C++17

Starting with C++17, there is a helper method called `std::as_const()`, defined in `<utility>`, that returns a `const` reference version of its reference parameter. Basically, `as_const(obj)` is equivalent to `const_cast<const T&>(obj)`, where `T` is the type of `obj`. As you can see, using `as_const()` is shorter than using `const_cast()`. Here is an example:

```
std::string str = "C++";
const std::string& constStr = std::as_const(str);
```

Watch out when using `as_const()` in combination with `auto`. Remember from Chapter 1 that `auto` strips away reference and `const` qualifiers! So, the following result variable has type `std::string`, not `const std::string&`:

```
auto result = std::as_const(str);
```

static_cast()

You can use `static_cast()` to perform explicit conversions that are supported directly by the language. For example, if you write an arithmetic expression in which you need to convert an `int` to a `double` in order to avoid integer division, use a `static_cast()`. In this example, it's enough to only use `static_cast()` with `i`, because that makes one of the two operands a `double`, making sure C++ performs floating point division.

```
int i = 3;
int j = 4;
double result = static_cast<double>(i) / j;
```

You can also use `static_cast()` to perform explicit conversions that are allowed because of user-defined constructors or conversion routines. For example, if class `A` has a constructor that takes an object of class `B`, you can convert a `B` object to an `A` object with `static_cast()`. In most situations where you want this behavior, however, the compiler performs the conversion automatically.

Another use for `static_cast()` is to perform downcasts in an inheritance hierarchy, as in this example:

```
class Base
{
public:
    virtual ~Base() = default;
};

class Derived : public Base
{
public:
    virtual ~Derived() = default;
};

int main()
{
    Base* b;
    Derived* d = new Derived();
    b = d; // Don't need a cast to go up the inheritance hierarchy
    d = static_cast<Derived*>(b); // Need a cast to go down the hierarchy

    Base base;
```

```

    Derived derived;
    Base& br = derived;
    Derived& dr = static_cast<Derived&>(br);
    return 0;
}

```

These casts work with both pointers and references. They do not work with objects themselves.

Note that these casts using `static_cast()` do not perform run-time type checking. They allow you to convert any `Base` pointer to a `Derived` pointer, or `Base` reference to a `Derived` reference, even if the `Base` really isn't a `Derived` at run time. For example, the following code compiles and executes, but using the pointer `d` can result in potentially catastrophic failure, including memory overwrites outside the bounds of the object.

```

Base* b = new Base();
Derived* d = static_cast<Derived*>(b);

```

To perform the cast safely with run-time type checking, use `dynamic_cast()`, which is explained a little later in this chapter.

`static_cast()` is not all-powerful. You can't `static_cast()` pointers of one type to pointers of another unrelated type. You can't directly `static_cast()` objects of one type to objects of another type if there is no converting constructor available. You can't `static_cast()` a `const` type to a non-`const` type. You can't `static_cast()` pointers to ints. Basically, you can't do anything that doesn't make sense according to the type rules of C++.

reinterpret_cast()

`reinterpret_cast()` is a bit more powerful, and concomitantly less safe, than `static_cast()`. You can use it to perform some casts that are not technically allowed by the C++ type rules, but which might make sense to the programmer in some circumstances. For example, you can cast a reference to one type to a reference to another type, even if the types are unrelated. Similarly, you can cast a pointer type to any other pointer type, even if they are unrelated by an inheritance hierarchy. This is commonly used to cast a pointer to a `void*`. This can be done implicitly, so no explicit cast is required. However, casting a `void*` back to a correctly-typed pointer requires `reinterpret_cast()`. A `void*` pointer is just a pointer to some location in memory. No type information is associated with a `void*` pointer. Here are some examples:

```

class X {};
class Y {};

int main()
{
    X x;
    Y y;
    X* xp = &x;
    Y* yp = &y;
    // Need reinterpret cast for pointer conversion from unrelated classes
    // static_cast doesn't work.
    xp = reinterpret_cast<X*>(yp);
    // No cast required for conversion from pointer to void*
    void* p = xp;
    // Need reinterpret cast for pointer conversion from void*

```

```

    xp = reinterpret_cast<X*>(p);
    // Need reinterpret cast for reference conversion from unrelated classes
    // static_cast doesn't work.
    X& xr = x;
    Y& yr = reinterpret_cast<Y&>(x);
    return 0;
}

```

One use-case for `reinterpret_cast()` is with binary I/O of trivially copyable types.² For example, you can write the individual bytes of such types to a file. When you read the file back into memory, you can use `reinterpret_cast()` to correctly interpret the bytes read from the file.

However, in general, you should be very careful with `reinterpret_cast()` because it allows you to do conversions without performing any type checking.

WARNING *You can also use `reinterpret_cast()` to cast pointers to integral types and back. However, you can only cast a pointer to an integral type that is large enough to hold it. For example, trying to use `reinterpret_cast()` to cast a 64-bit pointer to a 32-bit integer results in a compilation error.*

dynamic_cast()

`dynamic_cast()` provides a run-time check on casts within an inheritance hierarchy. You can use it to cast pointers or references. `dynamic_cast()` checks the run-time type information of the underlying object at run time. If the cast doesn't make sense, `dynamic_cast()` returns a null pointer (for the pointer version), or throws an `std::bad_cast` exception (for the reference version).

For example, suppose you have the following class hierarchy:

```

class Base
{
public:
    virtual ~Base() = default;
};

class Derived : public Base
{
public:
    virtual ~Derived() = default;
};

```

The following example shows a correct use of `dynamic_cast()`:

```

Base* b;
Derived* d = new Derived();
b = d;
d = dynamic_cast<Derived*>(b);

```

²A trivially copyable type is a type of which the underlying bytes making up the object can be copied into an array of, for example, `char`. If the data of that array is then copied back into the object, the object shall keep its original value.

The following `dynamic_cast()` on a reference will cause an exception to be thrown:

```
Base base;
Derived derived;
Base& br = base;
try {
    Derived& dr = dynamic_cast<Derived&>(br);
} catch (const bad_cast&) {
    cout << "Bad cast!" << endl;
}
```

Note that you can perform the same casts down the inheritance hierarchy with a `static_cast()` or `reinterpret_cast()`. The difference with `dynamic_cast()` is that it performs run-time (dynamic) type checking, while `static_cast()` and `reinterpret_cast()` perform the casting even if they are erroneous.

As Chapter 10 discusses, the run-time type information is stored in the vtable of an object. Therefore, in order to use `dynamic_cast()`, your classes must have at least one virtual method. If your classes don't have a vtable, trying to use `dynamic_cast()` will result in a compilation error. Microsoft VC++, for example, gives the following error:

```
error C2683: 'dynamic_cast' : 'MyClass' is not a polymorphic type.
```

Summary of Casts

The following table summarizes the casts you should use for different situations.

SITUATION	CAST
Remove <code>const</code> -ness	<code>const_cast()</code>
Explicit cast supported by the language (for example, <code>int</code> to <code>double</code> , <code>int</code> to <code>bool</code>)	<code>static_cast()</code>
Explicit cast supported by user-defined constructors or conversions	<code>static_cast()</code>
Object of one class to object of another (unrelated) class	Can't be done
Pointer-to-object of one class to pointer-to-object of another class in the same inheritance hierarchy	<code>dynamic_cast()</code> recommended, or <code>static_cast()</code>
Reference-to-object of one class to reference-to-object of another class in the same inheritance hierarchy	<code>dynamic_cast()</code> recommended, or <code>static_cast()</code>
Pointer-to-type to unrelated pointer-to-type	<code>reinterpret_cast()</code>
Reference-to-type to unrelated reference-to-type	<code>reinterpret_cast()</code>
Pointer-to-function to pointer-to-function	<code>reinterpret_cast()</code>

SCOPE RESOLUTION

As a C++ programmer, you need to familiarize yourself with the concept of a *scope*. Every name in your program, including variable, function, and class names, is in a certain scope. You create scopes with namespaces, function definitions, blocks delimited by curly braces, and class definitions. Variables that are initialized in the initialization statement of `for` loops are scoped to that `for` loop and are not visible outside that `for` loop. Similarly, C++17 introduced initializers for `if` and `switch` statements; see Chapter 1. Variables initialized in such initializers are scoped to the `if` or `switch` statement and are not visible outside that statement. When you try to access a variable, function, or class, the name is first looked up in the nearest enclosing scope, then the next scope, and so forth, up to the *global scope*. Any name not in a namespace, function, block delimited by curly braces, or class is assumed to be in the global scope. If it is not found in the global scope, at that point the compiler generates an undefined symbol error.

Sometimes names in scopes hide identical names in other scopes. Other times, the scope you want is not part of the default scope resolution from that particular line in the program. If you don't want the default scope resolution for a name, you can qualify the name with a specific scope using the scope resolution operator `::`. For example, to access a `static` method of a class, one way is to prefix the method name with the name of the class (its scope) and the scope resolution operator. A second way is to access the `static` method through an object of that class. The following example demonstrates these options. The example defines a class `Demo` with a `static get()` method, a `get()` function that is globally scoped, and a `get()` function that is in the `NS` namespace.

```
class Demo
{
    public:
        static int get() { return 5; }
};

int get() { return 10; }

namespace NS
{
    int get() { return 20; }
}
```

The global scope is unnamed, but you can access it specifically by using the scope resolution operator by itself (with no name prefix). The different `get()` functions can be called as follows. In this example, the code itself is in the `main()` function, which is always in the global scope:

```
int main()
{
    auto pd = std::make_unique<Demo>();
    Demo d;
    std::cout << pd->get() << std::endl;    // prints 5
    std::cout << d.get() << std::endl;     // prints 5
    std::cout << NS::get() << std::endl;   // prints 20
    std::cout << Demo::get() << std::endl; // prints 5
    std::cout << ::get() << std::endl;    // prints 10
    std::cout << get() << std::endl;      // prints 10
    return 0;
}
```

Note that if the namespace called `NS` is given as an unnamed namespace, then the following line will give an error about ambiguous name resolution, because you would have a `get()` defined in the global scope, and another `get()` defined in the unnamed namespace.

```
std::cout << get() << std::endl;
```

The same error occurs if you add the following `using` clause right before the `main()` function:

```
using namespace NS;
```

ATTRIBUTES

Attributes are a mechanism to add optional and/or vendor-specific information into source code. Before attributes were standardized in C++, vendors decided how to specify such information. Examples are `__attribute__`, `__declspec`, and so on. Since C++11, there is standardized support for attributes by using the double square brackets syntax `[[attribute]]`.

The C++ standard defines only six standard attributes. One of them, `[[carries_dependency]]`, is a rather exotic attribute and is not discussed further. The others are discussed in the following sections.

[[noreturn]]

`[[noreturn]]` means that a function never returns control to the call site. Typically, the function either causes some kind of termination (process termination or thread termination), or throws an exception. With this attribute, the compiler can avoid giving certain warnings or errors because it now knows more about the intent of the function. Here is an example:

```
[[noreturn]] void forceProgramTermination()
{
    std::exit(1);
}

bool isDongleAvailable()
{
    bool isAvailable = false;
    // Check whether a licensing dongle is available...
    return isAvailable;
}

bool isFeatureLicensed(int featureId)
{
    if (!isDongleAvailable()) {
        // No licensing dongle found, abort program execution!
        forceProgramTermination();
    } else {
        bool isLicensed = false;
        // Dongle available, perform license check of the given feature...
        return isLicensed;
    }
}
```

```
int main()
{
    bool isLicensed = isFeatureLicensed(42);
}
```

This code snippet compiles fine without any warnings or errors. However, if you remove the `[[noreturn]]` attribute, the compiler generates the following warning (output from Visual C++):

```
warning C4715: 'isFeatureLicensed': not all control paths return a value
```

[[deprecated]]

`[[deprecated]]` can be used to mark something as deprecated, which means you can still use it, but its use is discouraged. This attribute accepts an optional argument that can be used to explain the reason of the deprecation, as in this example:

```
[[deprecated("Unsafe method, please use xyz")] void func();
```

If you use this deprecated function, you'll get a compilation error or warning. For example, GCC gives the following warning:

```
warning: 'void func()' is deprecated: Unsafe method, please use xyz
```

C++17

[[fallthrough]]

Starting with C++17, you can tell the compiler that a fallthrough in a `switch` statement is intentional using the `[[fallthrough]]` attribute. If you don't specify this attribute for intentional fallthroughs, the compiler might give you a warning. You don't need to specify the attribute for empty cases. For example:

```
switch (backgroundColor) {
    case Color::DarkBlue:
        doSomethingForDarkBlue();
        [[fallthrough]];
    case Color::Black:
        // Code is executed for both a dark blue or black background color
        doSomethingForBlackOrDarkBlue();
        break;
    case Color::Red:
    case Color::Green:
        // Code to execute for a red or green background color
        break;
}
```

C++17

[[nodiscard]]

The `[[nodiscard]]` attribute can be used on a function returning a value to let the compiler issue a warning when that function is used without doing something with the returned value. Here is an example:

```
[[nodiscard]] int func()
{
    return 42;
}
```



```
int main()
{
    func();
    return 0;
}
```

The compiler issues a warning similar to the following:

```
warning C4834: discarding return value of function with 'nodiscard' attribute
```

This feature can, for example, be used for functions that return error codes. By adding the `[[nodiscard]]` attribute to such functions, the error codes cannot be ignored.

C++17

[[maybe_unused]]

The `[[maybe_unused]]` attribute can be used to suppress the compiler from issuing a warning when something is unused, as in this example:

```
int func(int param1, int param2)
{
    return 42;
}
```

If your compiler warning level is set high enough, this function definition might result in two compiler warnings. For example, Microsoft VC++ gives these warnings:

```
warning C4100: 'param2': unreferenced formal parameter
warning C4100: 'param1': unreferenced formal parameter
```

By using the `[[maybe_unused]]` attribute, you can suppress such warnings:

```
int func(int param1, [[maybe_unused]] int param2)
{
    return 42;
}
```

In this case, the second parameter is marked with the attribute suppressing its warning. The compiler now only issues a warning for `param1`:

```
warning C4100: 'param1': unreferenced formal parameter
```

Vendor-Specific Attributes

Most attributes will be vendor-specific extensions. Vendors are advised not to use attributes to change the meaning of the program, but to use them to help the compiler to optimize code or detect errors in code. Because attributes of different vendors could clash, vendors are recommended to qualify them. Here is an example:

```
[[clang::noduplicate]]
```

USER-DEFINED LITERALS

C++ has a number of standard literals that you can use in your code. Here are some examples:

- `'a'`: character
- `"character array"`: zero-terminated array of characters, C-style string

- 3.14f: float floating point value
- 0xabc: hexadecimal value

However, C++ also allows you to define your own literals. User-defined literals should start with an underscore. The first character following the underscore must be a lowercase letter. Some examples are: `_i`, `_s`, `_km`, `_miles`, and so on. User-defined literals are implemented by writing *literal operators*. A literal operator can work in *raw* or *cooked* mode. In raw mode, your literal operator receives a sequence of characters, while in cooked mode your literal operator receives a specific interpreted type. For example, take the C++ literal `123`. A raw literal operator receives this as a sequence of characters `'1'`, `'2'`, `'3'`. A cooked literal operator receives this as the integer `123`. As another example, take the C++ literal `0x23`. A raw operator receives the characters `'0'`, `'x'`, `'2'`, `'3'`, while a cooked operator receives the integer `35`. One last example, take the C++ literal `3.14`. A raw operator receives this as `'3'`, `'.'`, `'1'`, `'4'`, while a cooked operator receives the floating point value `3.14`.

A cooked-mode literal operator should have either of the following:

- one parameter of type `unsigned long long`, `long double`, `char`, `wchar_t`, `char16_t`, or `char32_t` to process numeric values, or
- two parameters where the first is a character array and the second is the length of the character array, to process strings (for example, `const char* str, size_t len`).

As an example, the following implements a cooked literal operator for the user-defined literal `_i` to define a complex number literal:

```
std::complex<long double> operator"" _i(long double d)
{
    return std::complex<long double>(0, d);
}
```

This `_i` literal can be used as follows:

```
std::complex<long double> c1 = 9.634_i;
auto c2 = 1.23_i;           // c2 has as type std::complex<long double>
```

A second example implements a cooked literal operator for a user-defined literal `_s` to define `std::string` literals:

```
std::string operator"" _s(const char* str, size_t len)
{
    return std::string(str, len);
}
```

This literal can be used as follows:

```
std::string str1 = "Hello World"_s;
auto str2 = "Hello World"_s;    // str2 has as type std::string
```

Without the `_s` literal, the auto type deduction would be `const char*`:

```
auto str3 = "Hello World";      // str3 has as type const char*
```

A raw-mode literal operator requires one parameter of type `const char*`, a zero-terminated C-style string. The following example defines the literal `_i`, but using a raw literal operator:

```
std::complex<long double> operator"" _i(const char* p)
{
    // Implementation omitted; it requires parsing the C-style
    // string and converting it to a complex number.
}
```

Using this raw-mode literal operator is exactly the same as using the cooked version.

Standard User-Defined Literals

C++ defines the following standard user-defined literals. Note that these standard user-defined literals do not start with an underscore.

- “s” for creating `std::strings`
For example: `auto myString = "Hello World"s;`
Requires a `using namespace std::string_literals;`
- “sv” for creating `std::string_views`
For example: `auto myStringView = "Hello World"sv;`
Requires a `using namespace std::string_view_literals;`
- “h”, “min”, “s”, “ms”, “us”, “ns”, for creating `std::chrono::duration` time intervals, discussed in Chapter 20
For example: `auto myDuration = 42min;`
Requires a `using namespace std::chrono_literals;`
- “i”, “il”, “if” for creating complex numbers, `complex<double>`, `complex<long double>`, and `complex<float>`, respectively
For example: `auto myComplexNumber = 1.3i;`
Requires a `using namespace std::complex_literals;`

A `using namespace std;` also makes these standard user-defined literals available.

HEADER FILES

Header files are a mechanism for providing an abstract interface to a subsystem or piece of code. One of the trickier parts of using headers is avoiding multiple includes of the same header file and circular references.

For example, suppose `A.h` includes `Logger.h`, defining a `Logger` class, and `B.h` also includes `Logger.h`. If you have a source file called `App.cpp`, which includes both `A.h` and `B.h`, you end up with *duplicate definitions* of the `Logger` class because the `Logger.h` header is included through `A.h` and `B.h`.

This problem of duplicate definitions can be avoided with a mechanism known as *include guards*. The following code snippet shows the `Logger.h` header with include guards. At the beginning of each header file, the `#ifndef` directive checks to see if a certain key has *not* been defined. If the key has been defined, the compiler skips to the matching `#endif`, which is usually placed at the end

of the file. If the key has *not* been defined, the file proceeds to define the key so that a subsequent include of the same file will be skipped.

```
#ifndef LOGGER_H
#define LOGGER_H

class Logger
{
    // ...
};

#endif // LOGGER_H
```

Nearly all compilers these days support the `#pragma once` directive which replaces include guards. For example:

```
#pragma once

class Logger
{
    // ...
};
```

Another tool for avoiding problems with header files is *forward declarations*. If you need to refer to a class but you cannot include its header file (for example, because it relies heavily on the class you are writing), you can tell the compiler that such a class exists without providing a formal definition through the `#include` mechanism. Of course, you cannot actually use the class in the code because the compiler knows nothing about it, except that the named class will exist after everything is linked together. However, you can still make use of pointers or references to forward-declared classes in your code. You can also declare functions that return such forward-declared classes by value, or that have such forward-declared classes as pass-by-value function parameters. Of course, both the code defining the function and any code calling the function will need to include the right header files that properly defines the forward-declared classes.

For example, assume that the `Logger` class uses another class called `Preferences`, that keeps track of user settings. The `Preferences` class may in turn use the `Logger` class, so you have a circular dependency which cannot be resolved with include guards. You need to make use of forward declarations in such cases. In the following code, the `Logger.h` header file uses a forward declaration for the `Preferences` class, and subsequently refers to the `Preferences` class without including its header file.

```
#pragma once

#include <string_view>

class Preferences; // forward declaration

class Logger
{
public:
    static void setPreferences(const Preferences& prefs);
    static void logError(std::string_view error);
};
```

It's recommended to use forward declarations as much as possible in your header files instead of including other headers. This can reduce your compilation and recompilation times, because it breaks dependencies of your header file on other headers. Of course, your implementation file needs to include the correct headers for types that you've forward-declared; otherwise, it won't compile.

C++17

To query whether a certain header file exists, C++17 adds the `__has_include("filename")` and `__has_include(<filename>)` preprocessor constants. These constants evaluate to 1 if the header file exists, 0 if it doesn't exist. For example, before the `<optional>` header file was fully approved for C++17, a preliminary version existed in `<experimental/optional>`. You could use `__has_include()` to check which of the two header files is available on your system:

```
#if __has_include(<optional>)
    #include <optional>
#elif __has_include(<experimental/optional>)
    #include <experimental/optional>
#endif
```

C UTILITIES

There are a few obscure C features that are also available in C++ and which can occasionally be useful. This section examines two of these features: variable-length argument lists and preprocessor macros.

Variable-Length Argument Lists

This section explains the old C-style variable-length argument lists. You need to know how these work because you might find them in legacy code. However, in new code you should use variadic templates for type-safe variable-length argument lists, which are described in Chapter 22.

Consider the C function `printf()` from `<cstdio>`. You can call it with any number of arguments:

```
printf("int %d\n", 5);
printf("String %s and int %d\n", "hello", 5);
printf("Many ints: %d, %d, %d, %d, %d\n", 1, 2, 3, 4, 5);
```

C/C++ provides the syntax and some utility macros for writing your own functions with a variable number of arguments. These functions usually look a lot like `printf()`. Although you shouldn't need this feature very often, occasionally you will run into situations in which it's quite useful. For example, suppose you want to write a quick-and-dirty debug function that prints strings to `stderr` if a debug flag is set, but does nothing if the debug flag is not set. Just like `printf()`, this function should be able to print strings with an arbitrary number of arguments and arbitrary types of arguments. A simple implementation looks like this:

```
#include <cstdio>
#include <stdarg.h>

bool debug = false;

void debugOut(const char* str, ...)
{
```

```

    va_list ap;
    if (debug) {
        va_start(ap, str);
        vfprintf(stderr, str, ap);
        va_end(ap);
    }
}

```

First, note that the prototype for `debugOut()` contains one typed and named parameter `str`, followed by `...` (ellipses). They stand for any number and type of arguments. In order to access these arguments, you must use macros defined in `<stdarg.h>`. You declare a variable of type `va_list`, and initialize it with a call to `va_start()`. The second parameter to `va_start()` must be the right-most *named* variable in the parameter list. All functions with variable-length argument lists require at least one named parameter. The `debugOut()` function simply passes this list to `vfprintf()` (a standard function in `<stdio.h>`). After the call to `vfprintf()` returns, `debugOut()` calls `va_end()` to terminate the access of the variable argument list. You must always call `va_end()` after calling `va_start()` to ensure that the function ends with the stack in a consistent state.

You can use the function in the following way:

```

debug = true;
debugOut("int %d\n", 5);
debugOut("String %s and int %d\n", "hello", 5);
debugOut("Many ints: %d, %d, %d, %d, %d\n", 1, 2, 3, 4, 5);

```

Accessing the Arguments

If you want to access the actual arguments yourself, you can use `va_arg()` to do so. It accepts a `va_list` as first argument, and the type of the argument to interpret. Unfortunately, there is no way to know what the end of the argument list is unless you provide an explicit way of doing so. For example, you can make the first parameter a count of the number of parameters. Or, in the case where you have a set of pointers, you may require the last pointer to be `nullptr`. There are many ways, but they are all burdensome to the programmer.

The following example demonstrates the technique where the caller specifies in the first named parameter how many arguments are provided. The function accepts any number of `ints` and prints them out:

```

void printInts(size_t num, ...)
{
    int temp;
    va_list ap;
    va_start(ap, num);
    for (size_t i = 0; i < num; ++i) {
        temp = va_arg(ap, int);
        cout << temp << " ";
    }
    va_end(ap);
    cout << endl;
}

```

You can call `printInts()` as follows. Note that the first parameter specifies how many integers will follow:

```
printInts(5, 5, 4, 3, 2, 1);
```

Why You Shouldn't Use C-Style Variable-Length Argument Lists

Accessing C-style variable-length argument lists is not very safe. There are several risks, as you can see from the `printInts()` function:

- You don't know the number of parameters. In the case of `printInts()`, you must trust the caller to pass the right number of arguments as the first argument. In the case of `debugOut()`, you must trust the caller to pass the same number of arguments after the character array as there are formatting codes in the character array.
- You don't know the types of the arguments. `va_arg()` takes a type, which it uses to interpret the value in its current spot. However, you can tell `va_arg()` to interpret the value as any type. There is no way for it to verify the correct type.

WARNING *Avoid using C-style variable-length argument lists. It is preferable to pass in an `std::array` or vector of values, to use initializer lists described in Chapter 1, or to use variadic templates for type-safe variable-length argument lists, as described in Chapter 22.*

Preprocessor Macros

You can use the C++ preprocessor to write *macros*, which are like little functions. Here is an example:

```
#define SQUARE(x) ((x) * (x)) // No semicolon after the macro definition!

int main()
{
    cout << SQUARE(5) << endl;
    return 0;
}
```

Macros are a remnant from C that are quite similar to `inline` functions, except that they are not type-checked, and the preprocessor dumbly replaces any calls to them with their expansions. The preprocessor does not apply true function-call semantics. This behavior can cause unexpected results. For example, consider what would happen if you called the `SQUARE` macro with `2 + 3` instead of `5`, like this:

```
cout << SQUARE(2 + 3) << endl;
```

You expect `SQUARE` to calculate 25, which it does. However, what if you left off some parentheses on the macro definition, so that it looks like this?

```
#define SQUARE(x) (x * x)
```

Now, the call to `SQUARE(2 + 3)` generates 11, not 25! Remember that the macro is dumbly expanded without regard to function-call semantics. This means that any `x` in the macro body is replaced by `2 + 3`, leading to this expansion:

```
cout << (2 + 3 * 2 + 3) << endl;
```

Following proper order of operations, this line performs the multiplication first, followed by the additions, generating 11 instead of 25!

Macros can also have a performance impact. Suppose you call the `SQUARE` macro as follows:

```
cout << SQUARE(veryExpensiveFunctionCallToComputeNumber()) << endl;
```

The preprocessor replaces this with the following:

```
cout << ((veryExpensiveFunctionCallToComputeNumber()) *  
        (veryExpensiveFunctionCallToComputeNumber())) << endl;
```

Now you are calling the expensive function twice—another reason to avoid macros.

Macros also cause problems for debugging because the code you write is not the code that the compiler sees, or that shows up in your debugger (because of the search-and-replace behavior of the preprocessor). For these reasons, you should avoid macros entirely in favor of inline functions. The details are shown here only because quite a bit of C++ code out there still employs macros. You need to understand them in order to read and maintain that code.

NOTE *Most compilers can output the preprocessed source to a file or to standard output. You can use that to see how the preprocessor is preprocessing your file. For example, with Microsoft VC++ you need to use the `/P` switch. With GCC you can use the `-E` switch.*

SUMMARY

This chapter explained some of the aspects of C++ that generate confusion. By reading this chapter, you learned a plethora of syntax details about C++. Some of the information, such as the details of references, `const`, scope resolution, the specifics of the C++-style casts, and the techniques for header files, you should use often in your programs. Other information, such as the uses of `static` and `extern`, how to write C-style variable-length argument lists, and how to write preprocessor macros, is important to understand, but not information that you should put into use in your programs on a day-to-day basis.

The next chapter starts a discussion on templates allowing you to write generic code.

12

Writing Generic Code with Templates

WHAT'S IN THIS CHAPTER?

- How to write class templates
- How the compiler processes templates
- How to organize template source code
- How to use non-type template parameters
- How to write templates of individual class methods
- How to write customizations of your class templates for specific types
- How to combine templates and inheritance
- How to write function templates
- How to make function templates friends of class templates
- How to write alias templates
- How to use variable templates

WROX.COM DOWNLOADS FOR THIS CHAPTER

Please note that all the code examples for this chapter are available as a part of this chapter's code download on the book's website at www.wrox.com/go/proc++4e on the Download Code tab.

C++ provides language support not only for object-oriented programming, but also for *generic programming*. As discussed in Chapter 6, the goal of generic programming is to write reusable code. The fundamental tools for generic programming in C++ are *templates*. Although not strictly an object-oriented feature, templates can be combined with object-oriented programming for powerful results. Many programmers consider templates to be the most difficult part of C++ and, for that reason, tend to avoid them. However, as a professional C++ programmer, you need to know about them.

This chapter provides the code details for fulfilling the design principle of generality discussed in Chapter 6, while Chapter 22 delves into some of the more advanced template features, including the following:

- The three kinds of template parameters and their subtleties
- Partial specialization
- How to exploit template recursion
- Variadic templates
- Metaprogramming

OVERVIEW OF TEMPLATES

The main programming unit in the procedural paradigm is the *procedure* or *function*. Functions are useful primarily because they allow you to write algorithms that are independent of specific values and can thus be reused for many different values. For example, the `sqrt()` function in C++ calculates the square root of a value supplied by the caller. A square root function that calculates only the square root of one number, such as four, would not be particularly useful! The `sqrt()` function is written in terms of a *parameter*, which is a stand-in for whatever value the caller passes. Computer scientists say that functions *parameterize* values.

The object-oriented programming paradigm adds the concept of *objects*, which group related data and behaviors, but it does not change the way functions and methods parameterize values.

Templates take the concept of parameterization a step further to allow you to parameterize on *types* as well as *values*. Types in C++ include primitives such as `int` and `double`, as well as user-defined classes such as `SpreadsheetCell` and `CherryTree`. With templates, you can write code that is independent not only of the values it will be given, but also of the types of those values. For example, instead of writing separate stack classes to store `ints`, `Cars`, and `SpreadsheetCells`, you can write one stack class definition that can be used for any of those types.

Although templates are an amazing language feature, templates in C++ are syntactically confusing, and many programmers avoid writing templates themselves. However, every programmer needs to know at least how to use templates, because they are widely used by libraries. For example, the C++ Standard Library uses templates extensively.

This chapter teaches you about template support in C++ with an emphasis on the aspects that arise in the Standard Library. Along the way, you will learn about some nifty features that you can employ in your programs aside from using the Standard Library.

CLASS TEMPLATES

Class templates define a class where the types of some of the variables, return types of methods, and/or parameters to the methods are specified as parameters. Class templates are useful primarily for containers, or data structures, that store objects. This section uses a running example of a `Grid` container. In order to keep the examples reasonable in length and simple enough to illustrate specific points, different sections of the chapter add features to the `Grid` container that are not used in subsequent sections.

Writing a Class Template

Suppose that you want a generic game board class that you can use as a chessboard, checkers board, tic-tac-toe board, or any other two-dimensional game board. In order to make it general-purpose, you should be able to store chess pieces, checkers pieces, tic-tac-toe pieces, or any type of game piece.

Coding without Templates

Without templates, the best approach to build a generic game board is to employ polymorphism to store generic `GamePiece` objects. Then, you could let the pieces for each game inherit from the `GamePiece` class. For example, in a chess game, `ChessPiece` would be a derived class of `GamePiece`. Through polymorphism, the `GameBoard`, written to store `GamePieces`, could also store `ChessPieces`. Because it should be possible to copy a `GameBoard`, the `GameBoard` needs to be able to copy `GamePieces`. This implementation employs polymorphism, so one solution is to add a pure virtual `clone()` method to the `GamePiece` base class. Here is the basic `GamePiece` interface:

```
class GamePiece
{
public:
    virtual std::unique_ptr<GamePiece> clone() const = 0;
};
```

`GamePiece` is an abstract base class. Concrete classes, such as `ChessPiece`, derive from it and implement the `clone()` method:

```
class ChessPiece : public GamePiece
{
public:
    virtual std::unique_ptr<GamePiece> clone() const override;
};

std::unique_ptr<GamePiece> ChessPiece::clone() const
{
    // Call the copy constructor to copy this instance
    return std::make_unique<ChessPiece>(*this);
}
```

The implementation of `GameBoard` uses a vector of vectors of `unique_ptr`s to store the `GamePieces`.

```
class GameBoard
{
public:
```

```

explicit GameBoard(size_t width = kDefaultWidth,
                  size_t height = kDefaultHeight);
GameBoard(const GameBoard& src); // copy constructor
virtual ~GameBoard() = default; // virtual defaulted destructor
GameBoard& operator=(const GameBoard& rhs); // assignment operator

// Explicitly default a move constructor and assignment operator.
GameBoard(GameBoard&& src) = default;
GameBoard& operator=(GameBoard&& src) = default;

std::unique_ptr<GamePiece>& at(size_t x, size_t y);
const std::unique_ptr<GamePiece>& at(size_t x, size_t y) const;

size_t getHeight() const { return mHeight; }
size_t getWidth() const { return mWidth; }

static const size_t kDefaultWidth = 10;
static const size_t kDefaultHeight = 10;

friend void swap(GameBoard& first, GameBoard& second) noexcept;

private:
void verifyCoordinate(size_t x, size_t y) const;

std::vector<std::vector<std::unique_ptr<GamePiece>>> mCells;
size_t mWidth, mHeight;
};

```

In this implementation, `at()` returns a reference to the piece at a specified spot instead of a copy of the piece. The `GameBoard` serves as an abstraction of a two-dimensional array, so it should provide array access semantics by giving the actual object at an index, not a copy of the object. Client code should not store this reference for future use because it might become invalid. Instead, client code should call `at()` right before using the returned reference. This follows the design philosophy of the Standard Library `std::vector` class.

NOTE *This implementation of the class provides two versions of `at()`, one of which returns a reference and one of which returns a `const` reference.*

Here are the method definitions. Note that this implementation uses the copy-and-swap idiom for the assignment operator, and Scott Meyer's `const_cast()` pattern to avoid code duplication, both of which are discussed in Chapter 9.

```

GameBoard::GameBoard(size_t width, size_t height)
    : mWidth(width), mHeight(height)
{
    mCells.resize(mWidth);
    for (auto& column : mCells) {
        column.resize(mHeight);
    }
}

```

```

GameBoard::GameBoard(const GameBoard& src)
    : GameBoard(src.mWidth, src.mHeight)
{
    // The ctor-initializer of this constructor delegates first to the
    // non-copy constructor to allocate the proper amount of memory.

    // The next step is to copy the data.
    for (size_t i = 0; i < mWidth; i++) {
        for (size_t j = 0; j < mHeight; j++) {
            if (src.mCells[i][j])
                mCells[i][j] = src.mCells[i][j]->clone();
        }
    }
}

void GameBoard::verifyCoordinate(size_t x, size_t y) const
{
    if (x >= mWidth || y >= mHeight) {
        throw std::out_of_range("");
    }
}

void swap(GameBoard& first, GameBoard& second) noexcept
{
    using std::swap;

    swap(first.mWidth, second.mWidth);
    swap(first.mHeight, second.mHeight);
    swap(first.mCells, second.mCells);
}

GameBoard& GameBoard::operator=(const GameBoard& rhs)
{
    // Check for self-assignment
    if (this == &rhs) {
        return *this;
    }

    // Copy-and-swap idiom
    GameBoard temp(rhs); // Do all the work in a temporary instance
    swap(*this, temp); // Commit the work with only non-throwing operations
    return *this;
}

const unique_ptr<GamePiece>& GameBoard::at(size_t x, size_t y) const
{
    verifyCoordinate(x, y);
    return mCells[x][y];
}

unique_ptr<GamePiece>& GameBoard::at(size_t x, size_t y)
{
    return const_cast<unique_ptr<GamePiece>&>(as_const(*this).at(x, y));
}

```

This `GameBoard` class works pretty well:

```
GameBoard chessBoard(8, 8);
auto pawn = std::make_unique<ChessPiece>();
chessBoard.at(0, 0) = std::move(pawn);
chessBoard.at(0, 1) = std::make_unique<ChessPiece>();
chessBoard.at(0, 1) = nullptr;
```

A Template Grid Class

The `GameBoard` class in the previous section is nice, but insufficient. A first problem is that you cannot use `GameBoard` to store elements by value; it always stores pointers. Another, more serious issue is related to type safety. Each cell in a `GameBoard` stores a `unique_ptr<GamePiece>`. Even if you are storing `ChessPieces`, when you use `at()` to request a certain cell, you will get back a `unique_ptr<GamePiece>`. This means you have to downcast the retrieved `GamePiece` to a `ChessPiece` to be able to make use of `ChessPiece`'s specific functionality. Another shortcoming of `GameBoard` is that it cannot be used to store primitive types, such as `int` or `double`, because the type stored in a cell has to derive from `GamePiece`.

So, it would be nice if you could write a generic `Grid` class that you could use for storing `ChessPieces`, `SpreadsheetCells`, `ints`, `doubles`, and so on. In C++, you can do this by writing a *class template*, which allows you to write a class without specifying one or more types. Clients then *instantiate* the template by specifying the types they want to use. This is called *generic programming*. The biggest advantage of generic programming is type safety. The types used in the class and its methods are concrete types, and not abstract base class types, as is the case with the polymorphic solution from the previous section. For example, suppose there is not only a `ChessPiece` but also a `TicTacToePiece`:

```
class TicTacToePiece : public GamePiece
{
public:
    virtual std::unique_ptr<GamePiece> clone() const override;
};

std::unique_ptr<GamePiece> TicTacToePiece::clone() const
{
    // Call the copy constructor to copy this instance
    return std::make_unique<TicTacToePiece>(*this);
}
```

With the polymorphic solution from the previous section, nothing stops you from storing tic-tac-toe pieces and chess pieces on the same chess board:

```
GameBoard chessBoard(8, 8);
chessBoard.at(0, 0) = std::make_unique<ChessPiece>();
chessBoard.at(0, 1) = std::make_unique<TicTacToePiece>();
```

The big problem with this is that you somehow need to remember what a cell is storing, so that you can perform the correct downcast when you call `at()`.

The Grid Class Definition

In order to understand class templates, it is helpful to examine the syntax. The following example shows how you can modify the `GameBoard` class to make a templated `Grid` class. The syntax is explained in detail following the code. Note that the class name has changed from `GameBoard` to `Grid`. The `Grid` should also be usable with primitive types such as `int` and `double`. That’s why I opted to implement this solution using value semantics without polymorphism, compared to the polymorphic pointer semantics used in the `GameBoard` implementation. A downside of using value semantics compared to pointer semantics is that you cannot have a true empty cell, that is, a cell must always contain some value. With pointer semantics, an empty cell stores `nullptr`. Luckily, C++17’s `std::optional`, defined in `<optional>`, comes to the rescue here. It allows you to use value semantics, while still having a way to represent empty cells.

```
template <typename T>
class Grid
{
public:
    explicit Grid(size_t width = kDefaultWidth,
                 size_t height = kDefaultHeight);
    virtual ~Grid() = default;

    // Explicitly default a copy constructor and assignment operator.
    Grid(const Grid& src) = default;
    Grid<T>& operator=(const Grid& rhs) = default;

    // Explicitly default a move constructor and assignment operator.
    Grid(Grid&& src) = default;
    Grid<T>& operator=(Grid&& rhs) = default;

    std::optional<T>& at(size_t x, size_t y);
    const std::optional<T>& at(size_t x, size_t y) const;

    size_t getHeight() const { return mHeight; }
    size_t getWidth() const { return mWidth; }

    static const size_t kDefaultWidth = 10;
    static const size_t kDefaultHeight = 10;

private:
    void verifyCoordinate(size_t x, size_t y) const;

    std::vector<std::vector<std::optional<T>>> mCells;
    size_t mWidth, mHeight;
};
```

Now that you’ve seen the full class definition, take another look at it, one line at a time:

```
template <typename T>
```

This first line says that the following class definition is a template on one type. Both `template` and `typename` are keywords in C++. As discussed earlier, templates “parameterize” types in the same

way that functions “parameterize” values. Just as you use parameter names in functions to represent the arguments that the caller will pass, you use template parameter names (such as `T`) in templates to represent the types that the caller will specify. There’s nothing special about the name `T`—you can use whatever name you want. Traditionally, when a single type is used, it is called `T`, but that’s just a historical convention, like calling the integer that indexes an array `i` or `j`. The template specifier holds for the entire statement, which in this case is the class definition.

NOTE *For historical reasons, you can use the keyword `class` instead of `typename` to specify template type parameters. Thus, many books and existing programs use syntax like this: `template <class T>`. However, the use of the word “class” in this context is confusing because it implies that the type must be a class, which is not true. The type can be a class, a struct, a union, a primitive type of the language like `int` or `double`, and so on.*

In the earlier `GameBoard` class, the `mCells` data member is a vector of vectors of *pointers*, which requires special code for copying—thus the need for a copy constructor and copy assignment operator. In the `Grid` class, `mCells` is a vector of vectors of optional *values*, so the compiler-generated copy constructor and assignment operator are fine. However, as explained in Chapter 8, once you have a user-declared destructor, it’s deprecated for the compiler to implicitly generate a copy constructor or copy assignment operator, so the `Grid` class template explicitly defaults them. It also explicitly defaults the move constructor and move assignment operator. Here is the explicitly defaulted copy assignment operator:

```
Grid<T>& operator=(const Grid& rhs) = default;
```

As you can see, the type of the `rhs` parameter is no longer a `const GameBoard&`, but a `const Grid&`. You can also specify it as a `const Grid<T>&`. Within a class definition, the compiler interprets `Grid` as `Grid<T>` where needed. However, outside a class definition you need to use `Grid<T>`. When you write a class template, what you used to think of as the class name (`Grid`) is actually the *template name*. When you want to talk about actual `Grid` classes or types, you discuss them as `Grid<T>`, *instantiations* of the `Grid` class template for a certain type, such as `int`, `SpreadsheetCell`, or `ChessPiece`.

Because `mCells` is not storing pointers anymore, but optional values, the `at()` methods now return `optional<T>&` or `const optional<T>&` instead of `unique_ptr`s:

```
std::optional<T>& at(size_t x, size_t y);
const std::optional<T>& at(size_t x, size_t y) const;
```

The Grid Class Method Definitions

The `template <typename T>` specifier must precede each method definition for the `Grid` template. The constructor looks like this:

```
template <typename T>
Grid<T>::Grid(size_t width, size_t height)
    : mWidth(width), mHeight(height)
```



```

{
    mCells.resize(mWidth);
    for (auto& column : mCells) {
        // Equivalent to:
        //for (std::vector<std::optional<T>>& column : mCells) {
            column.resize(mHeight);
        }
    }
}

```

NOTE *Templates require you to put the implementation of the methods in the header file itself, because the compiler needs to know the complete definition, including the definition of methods, before it can create an instance of the template. Some ways around this restriction are discussed later in this chapter.*

Note that the class name before the `::` is `Grid<T>`, not `Grid`. You must specify `Grid<T>` as the class name in all your methods and `static` data member definitions. The body of the constructor is identical to the `GameBoard` constructor.

The rest of the method definitions are also similar to their equivalents in the `GameBoard` class with the exception of the appropriate template and `Grid<T>` syntax changes:

```

template <typename T>
void Grid<T>::verifyCoordinate(size_t x, size_t y) const
{
    if (x >= mWidth || y >= mHeight) {
        throw std::out_of_range("");
    }
}

template <typename T>
const std::optional<T>& Grid<T>::at(size_t x, size_t y) const
{
    verifyCoordinate(x, y);
    return mCells[x][y];
}

template <typename T>
std::optional<T>& Grid<T>::at(size_t x, size_t y)
{
    return const_cast<std::optional<T>&>(std::as_const(*this).at(x, y));
}

```

NOTE *If an implementation of a class template method needs a default value for a certain template type parameter, for example `T`, then you can use the `T()` syntax. `T()` calls the default constructor for the object if `T` is a class type, or generates zero if `T` is a simple type. This syntax is called the zero-initialization syntax. It's a good way to provide a reasonable default value for a variable whose type you don't know yet.*

Using the Grid Template

When you want to create grid objects, you cannot use `Grid` alone as a type; you must specify the type that will be stored in that `Grid`. Creating an object of a class template for a specific type is called *instantiating the template*. Here is an example:

```
Grid<int> myIntGrid; // declares a grid that stores ints,
                  // using default arguments for the constructor
Grid<double> myDoubleGrid(11, 11); // declares an 11x11 Grid of doubles

myIntGrid.at(0, 0) = 10;
int x = myIntGrid.at(0, 0).value_or(0);

Grid<int> grid2(myIntGrid); // Copy constructor
Grid<int> anotherIntGrid;
anotherIntGrid = grid2;    // Assignment operator
```

Note that the type of `myIntGrid`, `grid2`, and `anotherIntGrid` is `Grid<int>`. You cannot store `SpreadsheetCells` or `ChessPieces` in these grids; the compiler will generate an error if you try to do so.

Note also the use of `value_or()`. The `at()` method returns an `std::optional` reference. This `optional` can contain a value or not. The `value_or()` method returns the value inside the `optional` if there is a value; otherwise it returns the argument given to `value_or()`.

The type specification is important; neither of the following two lines compiles:

```
Grid test; // WILL NOT COMPILE
Grid<> test; // WILL NOT COMPILE
```

The first line causes your compiler to complain with something like, “use of class template requires template argument list.” The second line causes it to say something like, “too few template arguments.”

If you want to declare a function or method that takes a `Grid` object, you must specify the type stored in that grid as part of the `Grid` type:

```
void processIntGrid(Grid<int>& grid)
{
    // Body omitted for brevity
}
```

Alternatively, you can use function templates, discussed later in this chapter, to write a function templated on the type of the elements in the grid.

NOTE *Instead of writing the full `Grid` type every time—for example, `Grid<int>`—you can use a type alias to give it an easier name:*

```
using IntGrid = Grid<int>;
```

Now you can write code as follows:

```
void processIntGrid(IntGrid& grid) { }
```

The `Grid` template can store more than just ints. For example, you can instantiate a `Grid` that stores `SpreadsheetCells`:

```
Grid<SpreadsheetCell> mySpreadsheet;
SpreadsheetCell myCell(1.234);
mySpreadsheet.at(3, 4) = myCell;
```

You can store pointer types as well:

```
Grid<const char*> myStringGrid;
myStringGrid.at(2, 2) = "hello";
```

The type specified can even be another template type:

```
Grid<vector<int>> gridOfVectors;
vector<int> myVector{ 1, 2, 3, 4 };
gridOfVectors.at(5, 6) = myVector;
```

You can also dynamically allocate `Grid` template instantiations on the heap:

```
auto myGridOnHeap = make_unique<Grid<int>>(2, 2); // 2x2 Grid on the heap
myGridOnHeap->at(0, 0) = 10;
int x = myGridOnHeap->at(0, 0).value_or(0);
```

Angle Brackets

Some of the examples in this book use templates with double angle brackets, as in this example:

```
std::vector<std::vector<T>> mCells;
```

This works perfectly fine since C++11. However, before C++11, the double angle brackets `>>` could mean only one thing: the `>>` operator. Depending on the types involved, this `>>` operator could be a right bit-shift operation, or a stream extraction operator. This was annoying with template code, because you were forced to put a space between double angle brackets. The previous declaration had to be written as follows:

```
std::vector<std::vector<T> > mCells;
```

This book uses the modern style without the spaces.

How the Compiler Processes Templates

In order to understand the intricacies of templates, you need to learn how the compiler processes template code. When the compiler encounters template method definitions, it performs syntax checking, but doesn't actually compile the templates. It can't compile template definitions because it doesn't know for which types they will be used. It's impossible for a compiler to generate code for something like `x = y` without knowing the types of `x` and `y`.

When the compiler encounters an instantiation of the template, such as `Grid<int> myIntGrid`, it writes code for an `int` version of the `Grid` template by replacing each `T` in the class template definition with `int`. When the compiler encounters a different instantiation of the template, such as `Grid<SpreadsheetCell> mySpreadsheet`, it writes another version of the `Grid` class for `SpreadsheetCells`. The compiler just writes the code that you would write if you didn't have template support in the language and had to write separate classes for each element type. There's no

magic here; templates just automate an annoying process. If you don't instantiate a class template for any types in your program, then the class method definitions are never compiled.

This instantiation process explains why you need to use the `Grid<T>` syntax in various places in your definition. When the compiler instantiates the template for a particular type, such as `int`, it replaces `T` with `int`, so that `Grid<int>` is the type.

Selective Instantiation

The compiler always generates code for all virtual methods of a generic class. However, for non-virtual methods, the compiler generates code only for those non-virtual methods that you actually call for a particular type. For example, given the preceding `Grid` class template, suppose that you write this code (and only this code) in `main()`:

```
Grid<int> myIntGrid;
myIntGrid.at(0, 0) = 10;
```

The compiler generates only the zero-argument constructor, the destructor, and the non-const `at()` method for an `int` version of the `Grid`. It does not generate other methods like the copy constructor, the assignment operator, or `getHeight()`.

Template Requirements on Types

When you write code that is independent of types, you must assume certain things about those types. For example, in the `Grid` template, you assume that the element type (represented by `T`) is destructible. The `Grid` template implementation doesn't assume much. However, other templates could assume that their template type parameters support, for example, an assignment operator.

If you attempt to instantiate a template with a type that does not support all the operations used by the template in your particular program, the code will not compile, and the error messages will almost always be quite obscure. However, even if the type you want to use doesn't support the operations required by all the template code, you can exploit selective instantiation to use some methods but not others.

Distributing Template Code between Files

Normally you put class definitions in a header file and method definitions in a source file. Code that creates or uses objects of the class `#includes` the header file and obtains access to the method code via the linker. Templates don't work that way. Because they are "templates" for the compiler to generate the actual methods for the instantiated types, both class template definitions and method definitions must be available to the compiler in any source file that uses them. There are several mechanisms to obtain this inclusion.

Template Definitions in Header Files

You can place the method definitions directly in the same header file where you define the class itself. When you `#include` this file in a source file where you use the template, the compiler will have access to all the code it needs. This mechanism is used for the previous `Grid` implementation.

Alternatively, you can place the template method definitions in a separate header file that you `#include` in the header file with the class definitions. Make sure the `#include` for the method definitions follows the class definition; otherwise, the code won't compile. For example:

```
template <typename T>
class Grid
{
    // Class definition omitted for brevity
};

#include "GridDefinitions.h"
```

Any client that wants to use the `Grid` template needs only to include the `Grid.h` header file. This division helps to keep the distinction between class definitions and method definitions.

Template Definitions in Source Files

Method implementations look strange in header files. If that syntax annoys you, there is a way that you can place the method definitions in a source file. However, you still need to make the definitions available to the code that uses the template, which you can do by `#include`ing the method implementation *source* file in the class template definition header file. That sounds odd if you've never seen it before, but it's legal in C++. The header file looks like this:

```
template <typename T>
class Grid
{
    // Class definition omitted for brevity
};

#include "Grid.cpp"
```

When using this technique, make sure you don't add the `Grid.cpp` file to your project, because it is not supposed to be, and cannot be, compiled separately; it should be `#included` only in a header file!

You can actually call your file with method implementations anything you want. Some programmers like to give source files that are included an `.inl` extension, for example, `Grid.inl`.

Limit Class Template Instantiations

If you want your class templates to be used only with certain known types, you can use the following technique.

Suppose you want the `Grid` class to be instantiated only for `int`, `double`, and `vector<int>`. The header file should look like this:

```
template <typename T>
class Grid
{
    // Class definition omitted for brevity
};
```

Note that there are no method definitions in this header file and that there is no `#include` at the end!

In this case, you need a real `.cpp` file added to your project, which contains the method definitions and looks like this:

```
#include "Grid.h"
#include <utility>

template <typename T>
Grid<T>::Grid(size_t width, size_t height)
    : mWidth(width), mHeight(height)
{
    mCells.resize(mWidth);
    for (auto& column : mCells) {
        column.resize(mHeight);
    }
}
// Other method definitions omitted for brevity...
```

For this method to work, you need to explicitly instantiate the template for those types that you want to allow clients to use. At the end of the `.cpp` file you can do this as follows:

```
// Explicit instantiations for the types you want to allow.
template class Grid<int>;
template class Grid<double>;
template class Grid<std::vector<int>>;
```

With these explicit instantiations, you disallow client code from using the `Grid` class template with other types, such as `SpreadsheetCell`.

NOTE *With explicit class template instantiations, the compiler generates code for all methods of the class template, irrespective of whether the methods will be called or not.*

Template Parameters

In the `Grid` example, the `Grid` template has one *template parameter*: the type that is stored in the grid. When you write the class template, you specify the parameter list inside the angle brackets, like this:

```
template <typename T>
```

This parameter list is similar to the parameter list in a function or method. As in functions and methods, you can write a class with as many template parameters as you want. Additionally, these parameters don't have to be types, and they can have default values.

Non-type Template Parameters

Non-type parameters are “normal” parameters such as ints and pointers: the kind of parameters with which you’re familiar from functions and methods. However, non-type template parameters can only be integral types (char, int, long, and so on), enumeration types, pointers, references, and `std::nullptr_t`. Starting with C++17, you can also specify `auto`, `auto&`, `auto*`, and so on, as the type of a non-type template parameter. In that case, the compiler deduces the type automatically.

In the `Grid` class template, you could use non-type template parameters to specify the height and width of the grid instead of specifying them in the constructor. The principle advantage to specifying non-type parameters in the template list instead of in the constructor is that the values are known before the code is compiled. Recall that the compiler generates code for templated methods by substituting the template parameters before compiling. Thus, you can use a normal two-dimensional array in your implementation instead of a vector of vectors that is dynamically resized. Here is the new class definition:

```
template <typename T, size_t WIDTH, size_t HEIGHT>
class Grid
{
public:
    Grid() = default;
    virtual ~Grid() = default;

    // Explicitly default a copy constructor and assignment operator.
    Grid(const Grid& src) = default;
    Grid<T, WIDTH, HEIGHT>& operator=(const Grid& rhs) = default;

    std::optional<T>& at(size_t x, size_t y);
    const std::optional<T>& at(size_t x, size_t y) const;

    size_t getHeight() const { return HEIGHT; }
    size_t getWidth() const { return WIDTH; }

private:
    void verifyCoordinate(size_t x, size_t y) const;

    std::optional<T> mCells[WIDTH][HEIGHT];
};
```

This class does not explicitly default the move constructor and move assignment operator, because C-style arrays do not support move semantics anyways.

Note that the template parameter list requires three parameters: the type of objects stored in the grid, and the width and height of the grid. The width and height are used to create a two-dimensional array to store the objects. Here are the class method definitions:

```
template <typename T, size_t WIDTH, size_t HEIGHT>
void Grid<T, WIDTH, HEIGHT>::verifyCoordinate(size_t x, size_t y) const
{
    if (x >= WIDTH || y >= HEIGHT) {
```

```

        throw std::out_of_range("");
    }
}

template <typename T, size_t WIDTH, size_t HEIGHT>
const std::optional<T>& Grid<T, WIDTH, HEIGHT>::at(size_t x, size_t y) const
{
    verifyCoordinate(x, y);
    return mCells[x][y];
}

template <typename T, size_t WIDTH, size_t HEIGHT>
std::optional<T>& Grid<T, WIDTH, HEIGHT>::at(size_t x, size_t y)
{
    return const_cast<std::optional<T>&>(std::as_const(*this).at(x, y));
}

```

Note that wherever you previously specified `Grid<T>` you must now specify `Grid<T, WIDTH, HEIGHT>` to represent the three template parameters.

You can instantiate this template and use it like this:

```

Grid<int, 10, 10> myGrid;
Grid<int, 10, 10> anotherGrid;
myGrid.at(2, 3) = 42;
anotherGrid = myGrid;
cout << anotherGrid.at(2, 3).value_or(0);

```

This code seems great, but unfortunately, there are more restrictions than you might initially expect. First, you can't use a non-constant integer to specify the height or width. The following code doesn't compile:

```

size_t height = 10;
Grid<int, 10, height> testGrid; // DOES NOT COMPILE

```

However, if you define `height` as a constant, it compiles:

```

const size_t height = 10;
Grid<int, 10, height> testGrid; // Compiles and works

```

`constexpr` functions with the correct return type also work. For example, if you have a `constexpr` function that returns a `size_t`, you can use it to initialize the height template parameter:

```

constexpr size_t getHeight() { return 10; }
...
Grid<double, 2, getHeight()> myDoubleGrid;

```

A second restriction might be more significant. Now that the width and height are template parameters, they are part of the type of each grid. That means that `Grid<int, 10, 10>` and `Grid<int, 10, 11>` are two different types. You can't assign an object of one type to an object of the other, and variables of one type can't be passed to functions or methods that expect variables of another type.

NOTE *Non-type template parameters become part of the type specification of instantiated objects.*

Default Values for Type Parameters

If you continue the approach of making height and width template parameters, you might want to provide defaults for the height and width non-type template parameters just as you did previously in the constructor of the `Grid<T>` class. C++ allows you to provide defaults for template parameters with a similar syntax. While you are at it, you could also provide a default for the `T` type parameter. Here is the class definition:

```
template <typename T = int, size_t WIDTH = 10, size_t HEIGHT = 10>
class Grid
{
    // Remainder is identical to the previous version
};
```

You need not specify the default values for `T`, `WIDTH`, and `HEIGHT` in the template specification for the method definitions. For example, here is the implementation of `at()`:

```
template <typename T, size_t WIDTH, size_t HEIGHT>
const std::optional<T>& Grid<T, WIDTH, HEIGHT>::at(size_t x, size_t y) const
{
    verifyCoordinate(x, y);
    return mCells[x][y];
}
```

Now, you can instantiate a `Grid` without any template parameters, with only the element type, the element type and the width, or the element type, width, and height:

```
Grid<> myIntGrid;
Grid<int> myGrid;
Grid<int, 5> anotherGrid;
Grid<int, 5, 5> aFourthGrid;
```

Note that if you don't specify any class template parameters, you still need to specify an empty set of angle brackets. For example, the following does not compile!

```
Grid myIntGrid;
```

The rules for default arguments in class template parameter lists are the same as for functions or methods; that is, you can provide defaults for parameters in order starting from the right.

C++17

Template Parameter Deduction for Constructors

C++17 adds support to automatically deduce the template parameters from the arguments passed to a class template constructor. Before C++17, you always had to specify all the template parameters for a class template explicitly.

For example, the Standard Library has a class template called `std::pair`, defined in `<utility>`, and discussed in Chapter 17 in detail. For now, it suffices to know that a `pair` stores exactly two values of two possibly different types, which you have to specify as the template parameters:

```
std::pair<int, double> pair1(1, 2.3);
```

To avoid the need of having to write the template parameters, a helper function template called `std::make_pair()` is available. Details of function templates are discussed later in this chapter. Function templates have always supported the automatic deduction of template parameters based on

the arguments passed to the function template. So, `make_pair()` is capable of automatically deducing the template type parameters based on the values passed to it. For example, the compiler deduces `pair<int, double>` for the following call:

```
auto pair2 = std::make_pair(1, 2.3);
```

With C++17, such helper function templates are not necessary anymore. The compiler now automatically deduces the template type parameters based on the arguments passed to the constructor. For the `pair` class template, you can simply write the following code:

```
std::pair pair3(1, 2.3);
```

Of course, this only works when all template parameters of a class template either have a default value, or are used as parameters in the constructor so they can be deduced.

NOTE *This type deduction is disabled for `std::unique_ptr` and `shared_ptr`. You pass a `T*` to their constructors, which means that the compiler would have to choose between deducing `<T>` or `<T[]>`, a dangerous choice to get wrong. So, just remember that for `unique_ptr` and `shared_ptr`, you need to keep using `make_unique()` and `make_shared()`.*

User-Defined Deduction Guides

You can also write your own user-defined deduction guides. These allow you to write rules for how the template parameters have to be deduced. This is an advanced topic, so it is not discussed in detail, although one example will demonstrate their power.

Suppose you have the following `SpreadsheetCell` class template:

```
template<typename T>
class SpreadsheetCell
{
public:
    SpreadsheetCell(const T& t) : mContent(t) { }

    const T& getContent() const { return mContent; }

private:
    T mContent;
};
```

With automatic template parameter deduction, you can create a `SpreadsheetCell` with an `std::string` type:

```
std::string myString = "Hello World!";
SpreadsheetCell cell(myString);
```

However, if you pass a `const char*` to the `SpreadsheetCell` constructor, then the type `T` is deduced as `const char*`, which is not what you want. You can create the following user-defined deduction guide to cause it to deduce `T` as `std::string` when passing a `const char*` as argument to the constructor:

```
SpreadsheetCell(const char*) -> SpreadsheetCell<std::string>;
```

This guide has to be defined outside the class definition but inside the same namespace as the `SpreadsheetCell` class.

The general syntax is as follows. The `explicit` keyword is optional. It behaves the same as `explicit` for single-parameter constructors, so it only makes sense for deduction rules with one parameter.

```
explicit TemplateName(Parameters) -> DeducedTemplate;
```

Method Templates

C++ allows you to templatize individual methods of a class. These methods can be inside a class template or in a non-templatized class. When you write a templatized class method, you are actually writing many different versions of that method for many different types. Method templates come in useful for assignment operators and copy constructors in class templates.

WARNING *Virtual methods and destructors cannot be method templates.*

Consider the original `Grid` template with only one template parameter: the element type. You can instantiate grids of many different types, such as ints and doubles:

```
Grid<int> myIntGrid;
Grid<double> myDoubleGrid;
```

However, `Grid<int>` and `Grid<double>` are two different types. If you write a function that takes an object of type `Grid<double>`, you cannot pass a `Grid<int>`. Even though you know that the elements of an `int` grid could be copied to the elements of a `double` grid, because the ints could be coerced into doubles, you cannot assign an object of type `Grid<int>` to one of type `Grid<double>` or construct a `Grid<double>` from a `Grid<int>`. Neither of the following two lines compiles:

```
myDoubleGrid = myIntGrid; // DOES NOT COMPILE
Grid<double> newDoubleGrid(myIntGrid); // DOES NOT COMPILE
```

The problem is that the copy constructor and assignment operator for the `Grid` template are as follows,

```
Grid(const Grid& src);
Grid<T>& operator=(const Grid& rhs);
```

which are equivalent to

```
Grid(const Grid<T>& src);
Grid<T>& operator=(const Grid<T>& rhs);
```

The `Grid` copy constructor and `operator=` both take a reference to a `const Grid<T>`. When you instantiate a `Grid<double>` and try to call the copy constructor and `operator=`, the compiler generates methods with these prototypes:

```
Grid(const Grid<double>& src);
Grid<double>& operator=(const Grid<double>& rhs);
```

Note that there are no constructors or `operator=` that take a `Grid<int>` within the generated `Grid<double>` class.

Luckily, you can rectify this oversight by adding templated versions of the copy constructor and assignment operator to the `Grid` class to generate methods that will convert from one grid type to another. Here is the new `Grid` class definition:

```
template <typename T>
class Grid
{
public:
    // Omitted for brevity

    template <typename E>
    Grid(const Grid<E>& src);

    template <typename E>
    Grid<T>& operator=(const Grid<E>& rhs);

    void swap(Grid& other) noexcept;

    // Omitted for brevity
};
```

Examine the new templated copy constructor first:

```
template <typename E>
Grid(const Grid<E>& src);
```

You can see that there is another template declaration with a different typename, `E` (short for “element”). The class is templated on one type, `T`, and the new copy constructor is also templated on a different type, `E`. This twofold templating allows you to copy grids of one type to another. Here is the definition of the new copy constructor:

```
template <typename T>
template <typename E>
Grid<T>::Grid(const Grid<E>& src)
    : Grid(src.getWidth(), src.getHeight())
{
    // The ctor-initializer of this constructor delegates first to the
    // non-copy constructor to allocate the proper amount of memory.

    // The next step is to copy the data.
    for (size_t i = 0; i < mWidth; i++) {
        for (size_t j = 0; j < mHeight; j++) {
            mCells[i][j] = src.at(i, j);
        }
    }
}
```

As you can see, you must declare the class template line (with the `T` parameter) before the member template line (with the `E` parameter). You can’t combine them like this:

```
template <typename T, typename E> // Wrong for nested template constructor!
Grid<T>::Grid(const Grid<E>& src)
```

In addition to the extra template parameter line before the constructor definition, note that you must use the public accessor methods `getWidth()`, `getHeight()`, and `at()` to access the elements of `src`. That's because the object you're copying to is of type `Grid<T>`, and the object you're copying from is of type `Grid<E>`. They are not the same type, so you must use public methods.

The templated assignment operator takes a `const Grid<E>&` but returns a `Grid<T>&`:

```
template <typename T>
template <typename E>
Grid<T>& Grid<T>::operator=(const Grid<E>& rhs)
{
    // no need to check for self-assignment because this version of
    // assignment is never called when T and E are the same

    // Copy-and-swap idiom
    Grid<T> temp(rhs); // Do all the work in a temporary instance
    swap(temp); // Commit the work with only non-throwing operations
    return *this;
}
```

You need not check for self-assignment in the templated assignment operator, because assignment of the same types still happens in the old, non-templated, version of `operator=`, so there's no way you can get self-assignment here.

The implementation of this assignment operator uses the copy-and-swap idiom introduced in Chapter 9. However, instead of using a friend `swap()` function, the `Grid` template uses a `swap()` method because function templates are only discussed later in this chapter. Note that this `swap()` method can only swap `Grids` of the same type, but that's okay because the templated assignment operator first converts the given `Grid<E>` to a `Grid<T>` called `temp` using the templated copy constructor. Afterward, it uses the `swap()` method to swap this temporary `Grid<T>` with `this`, which is also of type `Grid<T>`. Here is the definition of the `swap()` method:

```
template <typename T>
void Grid<T>::swap(Grid<T>& other) noexcept
{
    using std::swap;

    swap(mWidth, other.mWidth);
    swap(mHeight, other.mHeight);
    swap(mCells, other.mCells);
}
```

Method Templates with Non-type Parameters

Looking at the earlier example with integer template parameters for `HEIGHT` and `WIDTH`, you see that a major problem is that the height and width become part of the types. This restriction prevents you from assigning a grid with one height and width to a grid with a different height and width. In some cases, however, it's desirable to assign or copy a grid of one size to a grid of a different size. Instead of making the destination object a perfect clone of the source object, you would copy only those elements from the source array that fit in the destination array, padding the destination array with default values if the source array is smaller in either dimension. With method templates for the

assignment operator and copy constructor, you can do exactly that, thus allowing assignment and copying of different-sized grids. Here is the class definition:

```
template <typename T, size_t WIDTH = 10, size_t HEIGHT = 10>
class Grid
{
public:
    Grid() = default;
    virtual ~Grid() = default;

    // Explicitly default a copy constructor and assignment operator.
    Grid(const Grid& src) = default;
    Grid<T, WIDTH, HEIGHT>& operator=(const Grid& rhs) = default;

    template <typename E, size_t WIDTH2, size_t HEIGHT2>
    Grid(const Grid<E, WIDTH2, HEIGHT2>& src);

    template <typename E, size_t WIDTH2, size_t HEIGHT2>
    Grid<T, WIDTH, HEIGHT>& operator=(const Grid<E, WIDTH2, HEIGHT2>& rhs);

    void swap(Grid& other) noexcept;

    std::optional<T>& at(size_t x, size_t y);
    const std::optional<T>& at(size_t x, size_t y) const;

    size_t getHeight() const { return HEIGHT; }
    size_t getWidth() const { return WIDTH; }

private:
    void verifyCoordinate(size_t x, size_t y) const;

    std::optional<T> mCells[WIDTH][HEIGHT];
};
```

This new definition includes method templates for the copy constructor and assignment operator, plus a helper method `swap()`. Note that the non-templated copy constructor and assignment operator are explicitly defaulted (because of the user-declared destructor). They simply copy or assign `mCells` from the source to the destination, which is exactly the semantics you want for two grids of the same size.

Here is the templated copy constructor:

```
template <typename T, size_t WIDTH, size_t HEIGHT>
template <typename E, size_t WIDTH2, size_t HEIGHT2>
Grid<T, WIDTH, HEIGHT>::Grid(const Grid<E, WIDTH2, HEIGHT2>& src)
{
    for (size_t i = 0; i < WIDTH; i++) {
        for (size_t j = 0; j < HEIGHT; j++) {
            if (i < WIDTH2 && j < HEIGHT2) {
                mCells[i][j] = src.at(i, j);
            } else {
                mCells[i][j].reset();
            }
        }
    }
}
```

Note that this copy constructor copies only `WIDTH` and `HEIGHT` elements in the `x` and `y` dimensions, respectively, from `src`, even if `src` is bigger than that. If `src` is smaller in either dimension, the `std::optional` objects in the extra spots are reset using the `reset()` method.

Here are the implementations of `swap()` and `operator=`:

```
template <typename T, size_t WIDTH, size_t HEIGHT>
void Grid<T, WIDTH, HEIGHT>::swap(Grid<T, WIDTH, HEIGHT>& other) noexcept
{
    using std::swap;

    swap(mCells, other.mCells);
}

template <typename T, size_t WIDTH, size_t HEIGHT>
template <typename E, size_t WIDTH2, size_t HEIGHT2>
Grid<T, WIDTH, HEIGHT>& Grid<T, WIDTH, HEIGHT>::operator=(
    const Grid<E, WIDTH2, HEIGHT2>& rhs)
{
    // no need to check for self-assignment because this version of
    // assignment is never called when T and E are the same

    // Copy-and-swap idiom
    Grid<T, WIDTH, HEIGHT> temp(rhs); // Do all the work in a temp instance
    swap(temp); // Commit the work with only non-throwing operations
    return *this;
}
```

Class Template Specialization

You can provide alternate implementations of class templates for specific types. For example, you might decide that the `Grid` behavior for `const char*`s (C-style strings) doesn't make sense. A `Grid<const char*>` will store its elements in a `vector<vector<optional<const char*>>>`. The copy constructor and assignment operator will perform shallow copies of this `const char*` pointer type. For `const char*`s, it might make sense to do a deep copy of the string. The easiest solution for this is to write an alternative implementation specifically for `const char*`s, which stores the strings in a `vector<vector<optional<string>>>` and converts C-style strings into C++ strings so that their memory is automatically handled.

Alternate implementations of templates are called *template specializations*. You might find the syntax to be a little weird. When you write a class template specialization, you must specify that it's a template, and that you are writing the version of the template for that particular type. Here is the syntax for specializing the original version of the `Grid` for `const char*`s:

```
// When the template specialization is used, the original template must be
// visible too. Including it here ensures that it will always be visible
// when this specialization is visible.
#include "Grid.h"

template <>
class Grid<const char*>
{
public:
    explicit Grid(size_t width = kDefaultWidth,
```

```

        size_t height = kDefaultHeight);
virtual ~Grid() = default;

// Explicitly default a copy constructor and assignment operator.
Grid(const Grid& src) = default;
Grid<const char*>& operator=(const Grid& rhs) = default;

// Explicitly default a move constructor and assignment operator.
Grid(Grid&& src) = default;
Grid<const char*>& operator=(Grid&& rhs) = default;

std::optional<std::string>& at(size_t x, size_t y);
const std::optional<std::string>& at(size_t x, size_t y) const;

size_t getHeight() const { return mHeight; }
size_t getWidth() const { return mWidth; }

static const size_t kDefaultWidth = 10;
static const size_t kDefaultHeight = 10;

private:
void verifyCoordinate(size_t x, size_t y) const;

std::vector<std::vector<std::optional<std::string>>> mCells;
size_t mWidth, mHeight;
};

```

Note that you don't refer to any type variable, such as `T`, in the specialization: you work directly with `const char*s`. One obvious question at this point is why this class is still a template. That is, what good is the following syntax?

```

template <>
class Grid<const char*>

```

This syntax tells the compiler that this class is a `const char*` specialization of the `Grid` class. Suppose that you didn't use that syntax and just tried to write this:

```

class Grid

```

The compiler wouldn't let you do that because there is already a class named `Grid` (the original class template). Only by specializing it can you reuse the name. The main benefit of specializations is that they can be invisible to the user. When a user creates a `Grid` of `ints` or `SpreadsheetCells`, the compiler generates code from the original `Grid` template. When the user creates a `Grid` of `const char*s`, the compiler uses the `const char*` specialization. This can all be "behind the scenes."

```

Grid<int> myIntGrid; // Uses original Grid template
Grid<const char*> stringGrid1(2, 2); // Uses const char* specialization

const char* dummy = "dummy";
stringGrid1.at(0, 0) = "hello";
stringGrid1.at(0, 1) = dummy;
stringGrid1.at(1, 0) = dummy;
stringGrid1.at(1, 1) = "there";

Grid<const char*> stringGrid2(stringGrid1);

```

When you specialize a template, you don't "inherit" any code: Specializations are not like derivations. You must rewrite the entire implementation of the class. There is no requirement that you provide methods with the same names or behavior. As an example, the `const char*` specialization of `Grid` implements the `at()` methods by returning an `std::optional<std::string>`, not an `std::optional<const char*>`. As a matter of fact, you could write a completely different class with no relation to the original. Of course, that would abuse the template specialization ability, and you shouldn't do it without good reason. Here are the implementations for the methods of the `const char*` specialization. Unlike in the template definitions, you do not repeat the `template<>` syntax before each method definition.

```
Grid<const char*>::Grid(size_t width, size_t height)
    : mWidth(width), mHeight(height)
{
    mCells.resize(mWidth);
    for (auto& column : mCells) {
        column.resize(mHeight);
    }
}

void Grid<const char*>::verifyCoordinate(size_t x, size_t y) const
{
    if (x >= mWidth || y >= mHeight) {
        throw std::out_of_range("");
    }
}

const std::optional<std::string>& Grid<const char*>::at(
    size_t x, size_t y) const
{
    verifyCoordinate(x, y);
    return mCells[x][y];
}

std::optional<std::string>& Grid<const char*>::at(size_t x, size_t y)
{
    return const_cast<std::optional<std::string>&>(
        std::as_const(*this).at(x, y));
}
```

This section discussed how to use class template specialization. Template specialization allows you to write a special implementation for a template, with the template types replaced by specific types. Chapter 22 continues the discussion of specialization with a more advanced feature called *partial specialization*.

Deriving from Class Templates

You can inherit from class templates. If the derived class inherits from the template itself, it must be a template as well. Alternatively, you can derive from a specific instantiation of the class template, in which case your derived class does not need to be a template. As an example of the former, suppose you decide that the generic `Grid` class doesn't provide enough functionality to use as a game board.

Specifically, you would like to add a `move()` method to the game board that moves a piece from one location on the board to another. Here is the class definition for the `GameBoard` template:

```
#include "Grid.h"

template <typename T>
class GameBoard : public Grid<T>
{
public:
    explicit GameBoard(size_t width = Grid<T>::kDefaultWidth,
                      size_t height = Grid<T>::kDefaultHeight);
    void move(size_t xSrc, size_t ySrc, size_t xDest, size_t yDest);
};
```

This `GameBoard` template derives from the `Grid` template, and thereby inherits all its functionality. You don't need to rewrite `at()`, `getHeight()`, or any of the other methods. You also don't need to add a copy constructor, `operator=`, or destructor, because you don't have any dynamically allocated memory in the `GameBoard`.

The inheritance syntax looks normal, except that the base class is `Grid<T>`, not `Grid`. The reason for this syntax is that the `GameBoard` template doesn't really derive from the generic `Grid` template. Rather, each instantiation of the `GameBoard` template for a specific type derives from the `Grid` instantiation for that type. For example, if you instantiate a `GameBoard` with a `ChessPiece` type, then the compiler generates code for a `Grid<ChessPiece>` as well. The “`: public Grid<T>`” syntax says that this class inherits from whatever `Grid` instantiation makes sense for the `T` type parameter. Note that the C++ name lookup rules for template inheritance require you to specify that `kDefaultWidth` and `kDefaultHeight` are declared in, and thus dependent on, the `Grid<T>` base class.

Here are the implementations of the constructor and the `move()` method. Note the use of `Grid<T>` in the call to the base class constructor. Additionally, although many compilers don't enforce it, the name lookup rules require you to use the `this` pointer or `Grid<T>::` to refer to data members and methods in the base class template.

```
template <typename T>
GameBoard<T>::GameBoard(size_t width, size_t height)
    : Grid<T>(width, height)
{
}

template <typename T>
void GameBoard<T>::move(size_t xSrc, size_t ySrc, size_t xDest, size_t yDest)
{
    Grid<T>::at(xDest, yDest) = std::move(Grid<T>::at(xSrc, ySrc));
    Grid<T>::at(xSrc, ySrc).reset(); // Reset source cell
    // Or:
    // this->at(xDest, yDest) = std::move(this->at(xSrc, ySrc));
    // this->at(xSrc, ySrc).reset();
}
```

You can use the `GameBoard` template as follows:

```
GameBoard<ChessPiece> chessboard(8, 8);
ChessPiece pawn;
chessboard.at(0, 0) = pawn;
chessboard.move(0, 0, 0, 1);
```

Inheritance versus Specialization

Some programmers find the distinction between template inheritance and template specialization confusing. The following table summarizes the differences.

	INHERITANCE	SPECIALIZATION
Reuses code?	Yes: Derived classes contain all base class data members and methods.	No: you must rewrite all required code in the specialization.
Reuses name?	No: the derived class name must be different from the base class name.	Yes: the specialization must have the same name as the original.
Supports polymorphism?	Yes: objects of the derived class can stand in for objects of the base class.	No: each instantiation of a template for a type is a different type.

NOTE Use inheritance for extending implementations and for polymorphism. Use specialization for customizing implementations for particular types.

Alias Templates

Chapter 11 introduces the concept of type aliases and `typedefs`. They allow you to give other names to specific types. To refresh your memory, you could, for example, write the following type alias to give a second name to type `int`:

```
using MyInt = int;
```

Similarly, you can use a type alias to give another name to a templated class. Suppose you have the following class template:

```
template<typename T1, typename T2>
class MyTemplateClass { /* ... */};
```

You can define the following type alias in which you specify both class template type parameters:

```
using OtherName = MyTemplateClass<int, double>;
```

A `typedef` can also be used instead of such a type alias.

It's also possible to only specify some of the types, and keep the other types as template type parameters. This is called an *alias template*. For example:

```
template<typename T1>
using OtherName = MyTemplateClass<T1, double>;
```

This is something you cannot do with a `typedef`.

FUNCTION TEMPLATES

You can also write templates for stand-alone functions. For example, you could write a generic function to find a value in an array and return its index:

```
static const size_t NOT_FOUND = static_cast<size_t>(-1);

template <typename T>
size_t Find(const T& value, const T* arr, size_t size)
{
    for (size_t i = 0; i < size; i++) {
        if (arr[i] == value) {
            return i; // Found it; return the index
        }
    }
    return NOT_FOUND; // Failed to find it; return NOT_FOUND
}
```

NOTE *Of course, instead of returning some kind of sentinel value when an element is not found, such as NOT_FOUND, you could rewrite this code to return an `std::optional<size_t>` instead of a `size_t`. This would be an interesting exercise to practice using `std::optional`.*

The `Find()` function template can work on arrays of any type. For example, you could use it to find the index of an `int` in an array of `ints`, or a `SpreadsheetCell` in an array of `SpreadsheetCells`.

You can call the function in two ways: explicitly specifying the type parameter with angle brackets, or omitting the type and letting the compiler *deduce* the type parameter from the arguments. Here are some examples:

```
int myInt = 3, intArray[] = {1, 2, 3, 4};
const size_t sizeIntArray = std::size(intArray);

size_t res;
res = Find(myInt, intArray, sizeIntArray); // calls Find<int> by deduction
res = Find<int>(myInt, intArray, sizeIntArray); // calls Find<int> explicitly
if (res != NOT_FOUND)
    cout << res << endl;
else
    cout << "Not found" << endl;

double myDouble = 5.6, doubleArray[] = {1.2, 3.4, 5.7, 7.5};
const size_t sizeDoubleArray = std::size(doubleArray);

// calls Find<double> by deduction
res = Find(myDouble, doubleArray, sizeDoubleArray);
// calls Find<double> explicitly
res = Find<double>(myDouble, doubleArray, sizeDoubleArray);
if (res != NOT_FOUND)
    cout << res << endl;
else
```

```

    cout << "Not found" << endl;

    //res = Find(myInt, doubleArray, sizeDoubleArray); // DOES NOT COMPILE!
                                                // Arguments are different types.
    // calls Find<double> explicitly, even with myInt
    res = Find<double>(myInt, doubleArray, sizeDoubleArray);

    SpreadsheetCell cell1(10), cellArray[] =
        {SpreadsheetCell(4), SpreadsheetCell(10)};
    const size_t sizeCellArray = std::size(cellArray);

    res = Find(cell1, cellArray, sizeCellArray);
    res = Find<SpreadsheetCell>(cell1, cellArray, sizeCellArray);

```

The previous implementation of the `Find()` function requires the size of the array as one of the parameters. Sometimes the compiler knows the exact size of an array, for example, for stack-based arrays. It would be nice to be able to call `Find()` with such arrays without the need to pass it the size of the array. This can be accomplished by adding the following function template. The implementation just forwards the call to the previous `Find()` function template. This also demonstrates that function templates can take non-type parameters, just like class templates.

```

template <typename T, size_t N>
size_t Find(const T& value, const T(&arr)[N])
{
    return Find(value, arr, N);
}

```

The syntax of this version of `Find()` looks a bit strange, but its use is straightforward, as in this example:

```

int myInt = 3, intArray[] = {1, 2, 3, 4};
size_t res = Find(myInt, intArray);

```

Like class template method definitions, function template definitions (not just the prototypes) must be available to all source files that use them. Thus, you should put the definitions in header files if more than one source file uses them, or use explicit instantiations as discussed earlier in this chapter.

Template parameters of function templates can have defaults, just like class templates.

NOTE *The C++ Standard Library provides a templated `std::find()` function that is more powerful than the `Find()` function template shown here. See Chapter 18 for details.*

Function Template Specialization

Just as you can specialize class templates, you can specialize function templates. For example, you might want to write a `Find()` function for `const char*` C-style strings that compares them with `strcmp()` instead of `operator==`. Here is a specialization of the `Find()` function to do this:

```

template<>
size_t Find<const char*>(const char* const& value,
    const char* const* arr, size_t size)

```

```

{
    for (size_t i = 0; i < size; i++) {
        if (strcmp(arr[i], value) == 0) {
            return i; // Found it; return the index
        }
    }
    return NOT_FOUND; // Failed to find it; return NOT_FOUND
}

```

You can omit the `<const char*>` in the function name when the parameter type can be deduced from the arguments, making your prototype look like this:

```

template<>
size_t Find(const char* const& value, const char* const* arr, size_t size)

```

However, the deduction rules are tricky when you involve overloading as well (see the next section), so, in order to avoid mistakes, it's better to note the type explicitly.

Although the specialized `find()` function could take just `const char*` instead of `const char* const&` as its first parameter, it's best to keep the arguments parallel to the non-specialized version of the function for the deduction rules to function properly.

You can use this specialization as follows:

```

const char* word = "two";
const char* words[] = {"one", "two", "three", "four"};
const size_t sizeWords = std::size(words);
size_t res;
// Calls const char* specialization
res = Find<const char*>(word, words, sizeWords);
// Calls const char* specialization
res = Find(word, words, sizeWords);

```

Function Template Overloading

You can also overload function templates with non-template functions. For example, instead of writing a `Find()` template specialization for `const char*`, you could write a non-template `Find()` function that works on `const char*s`:

```

size_t Find(const char* const& value, const char* const* arr, size_t size)
{
    for (size_t i = 0; i < size; i++) {
        if (strcmp(arr[i], value) == 0) {
            return i; // Found it; return the index
        }
    }
    return NOT_FOUND; // Failed to find it; return NOT_FOUND
}

```

This function is identical in behavior to the specialized version in the previous section. However, the rules for when it is called are different:

```

const char* word = "two";
const char* words[] = {"one", "two", "three", "four"};
const size_t sizeWords = std::size(words);
size_t res;

```

```
// Calls template with T=const char*
res = Find<const char*>(word, words, sizeWords);
res = Find(word, words, sizeWords); // Calls non-template function!
```

Thus, if you want your function to work both when `const char*` is explicitly specified and via deduction when it is not, you should write a specialized template version instead of a non-template, overloaded version.

Function Template Overloading and Specialization Together

It's possible to write both a specialized `Find()` template for `const char*s` and a stand-alone `Find()` function for `const char*s`. The compiler always prefers the non-template function to a templated version. However, if you specify the template instantiation explicitly, the compiler will be forced to use the template version:

```
const char* word = "two";
const char* words[] = {"one", "two", "three", "four"};
const size_t sizeWords = std::size(words);
size_t res;
// Calls const char* specialization of the template
res = Find<const char*>(word, words, sizeWords);
res = Find(word, words, sizeWords); // Calls the Find non-template function
```

Friend Function Templates of Class Templates

Function templates are useful when you want to overload operators in a class template. For example, you might want to overload the addition operator (`operator+`) for the `Grid` class template to be able to add two grids together. The result will be a `Grid` with the same size as the smallest `Grid` of the two operands. Corresponding cells are only added together if both cells contain an actual value. Suppose you want to make your `operator+` a stand-alone function template. The definition, which should go directly in `Grid.h`, looks as follows:

```
template <typename T>
Grid<T> operator+(const Grid<T>& lhs, const Grid<T>& rhs)
{
    size_t minWidth = std::min(lhs.getWidth(), rhs.getWidth());
    size_t minHeight = std::min(lhs.getHeight(), rhs.getHeight());

    Grid<T> result(minWidth, minHeight);
    for (size_t y = 0; y < minHeight; ++y) {
        for (size_t x = 0; x < minWidth; ++x) {
            const auto& leftElement = lhs.mCells[x][y];
            const auto& rightElement = rhs.mCells[x][y];
            if (leftElement.has_value() && rightElement.has_value())
                result.at(x, y) = leftElement.value() + rightElement.value();
        }
    }
    return result;
}
```

To query whether an `std::optional` contains an actual value, you use the `has_value()` method, while `value()` is used to retrieve this value.

This function template works on any `Grid`, as long as there is an addition operator for the type of elements stored in the grid. The only problem with this implementation is that it accesses `private` member `mCells` of the `Grid` class. The obvious solution is to use the `public at ()` method, but let's see how you can make a function template a friend of a class template. For this example, you can make the operator a friend of the `Grid` class. However, both the `Grid` class and the `operator+` are templates. What you really want is for each instantiation of `operator+` for a particular type `T` to be a friend of the `Grid` template instantiation for that type. The syntax looks like this:

```
// Forward declare Grid template.
template <typename T> class Grid;

// Prototype for templated operator+.
template<typename T>
Grid<T> operator+(const Grid<T>& lhs, const Grid<T>& rhs);

template <typename T>
class Grid
{
    public:
        // Omitted for brevity
        friend Grid<T> operator+ <T>(const Grid<T>& lhs, const Grid<T>& rhs);
        // Omitted for brevity
};
```

This friend declaration is tricky: you're saying that, for an instance of the template with type `T`, the `T` instantiation of `operator+` is a friend. In other words, there is a one-to-one mapping of friends between the class instantiations and the function instantiations. Note particularly the explicit template specification `<T>` on `operator+` (the space after `operator+` is optional). This syntax tells the compiler that `operator+` is itself a template.

More on Template Parameter Deduction

The compiler deduces the type of the template parameters based on the arguments passed to the function template. Template parameters that cannot be deduced have to be specified explicitly.

For example, the following `add()` function template requires three template parameters: the type of the return value, and the types of the two operands:

```
template<typename RetType, typename T1, typename T2>
RetType add(const T1& t1, const T2& t2) { return t1 + t2; }
```

You can call this function template specifying all three parameters as follows:

```
auto result = add<long long, int, int>(1, 2);
```

However, because the template parameters `T1` and `T2` are parameters to the function, the compiler can deduce those two parameters, so you can call `add()` by only specifying the type for the return value:

```
auto result = add<long long>(1, 2);
```

Of course, this only works when the parameters to deduce are last in the list of parameters. Suppose the function template is defined as follows:

```
template<typename T1, typename RetType, typename T2>
RetType add(const T1& t1, const T2& t2) { return t1 + t2; }
```

You have to specify `RetType`, because the compiler cannot deduce that type. However, because `RetType` is the second parameter, you have to explicitly specify `T1` as well:

```
auto result = add<int, long long>(1, 2);
```

You can also provide a default value for the return type template parameter so that you can call `add()` without specifying any types:

```
template<typename RetType = long long, typename T1, typename T2>
RetType add(const T1& t1, const T2& t2) { return t1 + t2; }
...
auto result = add(1, 2);
```

Return Type of Function Templates

Continuing the example of the `add()` function template, wouldn't it be nice to let the compiler deduce the type of the return value? It would; however, the return type depends on the template type parameters, so how can you do this? For example, take the following templated function:

```
template<typename T1, typename T2>
RetType add(const T1& t1, const T2& t2) { return t1 + t2; }
```

In this example, *RetType* should be the type of the expression `t1+t2`, but you don't know this because you don't know what `T1` and `T2` are.

As discussed in Chapter 1, since C++14 you can ask the compiler to automatically deduce the function return type. So, you can simply write `add()` as follows:

```
template<typename T1, typename T2>
auto add(const T1& t1, const T2& t2)
{
    return t1 + t2;
}
```

However, using `auto` to deduce the type of an expression strips away reference and `const` qualifiers; `decltype` does not strip those. Before continuing with the `add()` function template, let's look at the differences between `auto` and `decltype` using a non-template example. Suppose you have the following function:

```
const std::string message = "Test";

const std::string& getString()
{
    return message;
}
```

You can call `getString()` and store the result in a variable with the type specified as `auto` as follows:

```
auto s1 = getString();
```

Because `auto` strips reference and `const` qualifiers, `s1` is of type `string`, and thus a *copy* is made. If you want a `const` reference, you can explicitly make it a reference and mark it `const` as follows:

```
const auto& s2 = getString();
```

An alternative solution is to use `decltype`, which does not strip anything:

```
decltype(getString()) s3 = getString();
```

In this case, `s3` is of type `const string&`; however, there is code duplication because you need to specify `getString()` twice, which can be cumbersome when `getString()` is a more complicated expression.

This is solved with `decltype(auto)`:

```
decltype(auto) s4 = getString();
```

`s4` is also of type `const string&`.

So, with this knowledge, we can write our `add()` function template using `decltype(auto)` to avoid stripping any `const` and reference qualifiers:

```
template<typename T1, typename T2>
decltype(auto) add(const T1& t1, const T2& t2)
{
    return t1 + t2;
}
```

Before C++14—that is, before function return type deduction and `decltype(auto)` were supported—the problem was solved using `decltype(expression)`, introduced with C++11. For example, you would think you could write the following:

```
template<typename T1, typename T2>
decltype(t1+t2) add(const T1& t1, const T2& t2) { return t1 + t2; }
```

However, this is wrong. You are using `t1` and `t2` in the beginning of the prototype line, but these are not yet known. `t1` and `t2` become known once the semantic analyzer reaches the end of the parameter list.

This problem used to be solved with the *alternative function syntax*. Note that in this syntax, the return type is specified after the parameter list (*trailing return type*); thus, the names of the parameters (and their types, and consequently, the type `t1+t2`) are known:

```
template<typename T1, typename T2>
auto add(const T1& t1, const T2& t2) -> decltype(t1+t2)
{
    return t1 + t2;
}
```

However, now that C++ supports `auto` return type deduction and `decltype(auto)`, it is recommended to use one of these mechanisms, instead of the alternative function syntax.

VARIABLE TEMPLATES

In addition to class templates, class method templates, and function templates, C++14 adds the ability to write *variable templates*. The syntax is as follows:

```
template <typename T>
constexpr T pi = T(3.141592653589793238462643383279502884);
```

This is a variable template for the value of pi. To get pi in a certain type, you use the following syntax:

```
float piFloat = pi<float>;
long double piLongDouble = pi<long double>;
```

You will always get the closest value of pi representable in the requested type. Just like other types of templates, variable templates can also be specialized.

SUMMARY

This chapter started a discussion on using templates for generic programming. You saw the syntax on how to write templates and examples where templates are really useful. It explained how to write class templates, how to organize your code in different files, how to use template parameters, and how to templatize methods of a class. It further discussed how to use class template specialization to write special implementations of a template where the template parameters are replaced with specific arguments. The chapter finished with an explanation of function templates and variable templates.

Chapter 22 continues the discussion on templates with some more advanced features such as variadic templates and metaprogramming.

13

Demystifying C++ I/O

WHAT'S IN THIS CHAPTER?

- What streams are
- How to use streams for input and output of data
- What the available standard streams are in the Standard Library

WROX.COM DOWNLOADS FOR THIS CHAPTER

Please note that all the code examples for this chapter are available as a part of this chapter's code download on the book's website at www.wrox.com/go/proc++4e on the Download Code tab.

A program's fundamental job is to accept input and produce output. A program that produces no output of any sort would not be very useful. All languages provide some mechanism for I/O, either as a built-in part of the language or through an OS-specific API. A good I/O system is both flexible and easy to use. Flexible I/O systems support input and output through a variety of devices, such as files and the user console. They also support reading and writing of different types of data. I/O is error-prone because data coming from a user can be incorrect or the underlying file system or other data source can be inaccessible. Thus, a good I/O system is also capable of handling error conditions.

If you are familiar with the C language, you have undoubtedly used `printf()` and `scanf()`. As I/O mechanisms, `printf()` and `scanf()` are certainly flexible. Through escape codes and variable placeholders, they can be customized to read in specially formatted data, or output any value that the formatting codes permit, which is currently limited to integer/character values, floating point values, and strings. However, `printf()` and `scanf()` falter on other measures of good I/O systems. They do not handle errors particularly well, they are not flexible enough to handle custom data types, and in an object-oriented language like C++, they are not at all object oriented.

C++ provides a more refined method of input and output through a mechanism known as *streams*. Streams are a flexible and object-oriented approach to I/O. In this chapter, you will learn how to use streams for data output and input. You will also learn how to use the stream mechanism to read from various sources and write to various destinations, such as the user console, files, and even strings. This chapter covers the most commonly used I/O features.

USING STREAMS

The stream metaphor takes a bit of getting used to. At first, streams may seem more complex than traditional C-style I/O, such as `printf()`. In reality, they seem complicated initially only because there is a deeper metaphor behind streams than there is behind `printf()`. Don't worry, though; after a few examples, you'll never look back.

What Is a Stream, Anyway?

Chapter 1 compares the `cout` stream to a laundry chute for data. You throw some variables down the stream, and they are written to the user's screen, or *console*. More generally, all streams can be viewed as data chutes. Streams vary in their direction and their associated source or destination. For example, the `cout` stream that you are already familiar with is an output stream, so its direction is "out." It writes data to the console so its associated destination is "console." The `c` in `cout` does not stand for "console" as you might expect, but stands for "character" as it's a character-based stream. There is another standard stream called `cin` that accepts input from the user. Its direction is "in," and its associated source is "console." As with `cout`, the `c` in `cin` stands for "character." Both `cout` and `cin` are predefined instances of streams that are defined within the `std` namespace in C++. The following table gives a brief description of all predefined streams.

The difference between *buffered* and *unbuffered* streams is that a buffered stream does not immediately send the data to the destination, but instead, it buffers incoming data and then sends it in blocks. An unbuffered stream, on the other hand, immediately sends the data to the destination. Buffering is usually done to improve performance, as certain destinations, such as files, perform better when writing bigger blocks at once. Note that you can always force a buffered stream to send all its currently buffered data to the destination by *flushing* its buffer using the `flush()` method.

STREAM	DESCRIPTION
<code>cin</code>	An input stream, reads data from the "input console."
<code>cout</code>	A buffered output stream, writes data to the "output console."
<code>cerr</code>	An unbuffered output stream, writes data to the "error console," which is often the same as the "output console."
<code>clog</code>	A buffered version of <code>cerr</code> .

There are also wide-character versions available of these streams: `wcin`, `wcout`, `wcerr`, and `wclog`. Wide characters are discussed in Chapter 19.

Note that graphical user interface applications normally do not have a console; that is, if you write something to `cout`, the user will not see it. If you are writing a library, you should never assume the existence of `cout`, `cin`, `cerr`, or `clog` because you never know whether your library will be used in a console or in a GUI application.

NOTE *Every input stream has an associated source. Every output stream has an associated destination.*

Another important aspect of streams is that they include data but also have a so-called *current position*. The current position is the position in the stream where the next read or write operation will take place.

Stream Sources and Destinations

Streams as a concept can be applied to any object that accepts data or emits data. You could write a stream-based network class or stream-based access to a MIDI-based instrument. In C++, there are three common sources and destinations for streams: console, file, and string.

You have already read many examples of user, or console, streams. Console input streams make programs interactive by allowing input from the user at run time. Console output streams provide feedback to the user and output results.

File streams, as the name implies, read data from and write data to a file system. File input streams are useful for reading configuration data and saved files, or for batch processing file-based data. File output streams are useful for saving state and providing output. File streams subsume the functionality of the C functions `fprintf()`, `fwrite()`, and `fputs()` for output, and `fscanf()`, `fread()`, and `fgets()` for input.

String streams are an application of the stream metaphor to the string type. With a string stream, you can treat character data just as you would treat any other stream. For the most part, this is merely a handy syntax for functionality that could be handled through methods on the `string` class. However, using stream syntax provides opportunities for optimization and can be far more convenient and more efficient than direct use of the `string` class. String streams subsume the functionality of `sprintf()`, `sprintf_s()`, `scanf()`, and other forms of C string-formatting functions.

The rest of this section deals with console streams (`cin` and `cout`). Examples of file and string streams are provided later in this chapter. Other types of streams, such as printer output or network I/O, are often platform dependent, so they are not covered in this book.

Output with Streams

Output using streams is introduced in Chapter 1 and is used in almost every chapter in this book. This section briefly revisits some of the basics and introduces material that is more advanced.

Output Basics

Output streams are defined in the `<ostream>` header file. Most programmers include `<iostream>` in their programs, which in turn includes the headers for both input streams and output streams. The `<iostream>` header also declares all predefined stream instances: `cout`, `cin`, `cerr`, `clog`, and the wide versions.

The `<<` operator is the simplest way to use output streams. C++ basic types, such as ints, pointers, doubles, and characters, can be output using `<<`. In addition, the C++ `string` class is compatible with `<<`, and C-style strings are properly output as well. Following are some examples of using `<<`:

```
int i = 7;
cout << i << endl;

char ch = 'a';
cout << ch << endl;

string myString = "Hello World.";
cout << myString << endl;
```

The output is as follows:

```
7
a
Hello World.
```

The `cout` stream is the built-in stream for writing to the console, or *standard output*. You can “chain” uses of `<<` together to output multiple pieces of data. This is because the `<<` operator returns a reference to the stream as its result so you can immediately use `<<` again on the same stream. Here is an example:

```
int j = 11;
cout << "The value of j is " << j << "!" << endl;
```

The output is as follows:

```
The value of j is 11!
```

C++ streams correctly parse C-style escape sequences, such as strings that contain `\n`. You can also use `std::endl` to start a new line. The difference between using `\n` and `endl` is that `\n` just starts a new line while `endl` also flushes the buffer. Watch out with `endl` because too many flushes might hurt performance. The following example uses `endl` to output and flush several lines of text with just one line of code:

```
cout << "Line 1" << endl << "Line 2" << endl << "Line 3" << endl;
```

The output is as follows:

```
Line 1
Line 2
Line 3
```

Methods of Output Streams

The `<<` operator is, without a doubt, the most useful part of output streams. However, there is additional functionality to be explored. If you look at the `<ostream>` header file, you’ll see many lines

of overloaded definitions of the `<<` operator to support outputting all kinds of different data types. You'll also find some useful public methods.

put() and write()

`put()` and `write()` are *raw output methods*. Instead of taking an object or variable that has some defined behavior for output, `put()` accepts a single character, while `write()` accepts a character array. The data passed to these methods is output as is, without any special formatting or processing. For example, the following code snippet shows how to output a C-style string to the console without using the `<<` operator:

```
const char* test = "hello there\n";
cout.write(test, strlen(test));
```

The next snippet shows how to write a single character to the console by using the `put()` method:

```
cout.put('a');
```

flush()

When you write to an output stream, the stream does not necessarily write the data to its destination right away. Most output streams *buffer*, or accumulate data instead of writing it out as soon as it comes in. This is usually done to improve performance. Certain stream destinations, such as files, are much more performant if data is written in larger blocks, instead of for example character-by-character. The stream *flushes*, or writes out the accumulated data, when one of the following conditions occurs:

- A sentinel, such as the `endl` marker, is reached.
- The stream goes out of scope and is destructed.
- Input is requested from a corresponding input stream (that is, when you make use of `cin` for input, `cout` will flush). In the section, “File Streams,” you will learn how to establish this type of link.
- The stream buffer is full.
- You explicitly tell the stream to flush its buffer.

One way to explicitly tell a stream to flush is to call its `flush()` method, as in the following code:

```
cout << "abc";
cout.flush(); // abc is written to the console.
cout << "def";
cout << endl; // def is written to the console.
```

NOTE *Not all output streams are buffered. The `cerr` stream, for example, does not buffer its output.*

Handling Output Errors

Output errors can arise in a variety of situations. Perhaps you are trying to open a non-existing file. Maybe a disk error has prevented a write operation from succeeding, for example, because the disk is full. None of the streams' code you have read up until this point has considered these possibilities, mainly for brevity. However, it is vital that you address any error conditions that occur.

When a stream is in its normal usable state, it is said to be “good.” The `good()` method can be called directly on a stream to determine whether or not the stream is currently good.

```
if (cout.good()) {
    cout << "All good" << endl;
}
```

The `good()` method provides an easy way to obtain basic information about the validity of the stream, but it does not tell you why the stream is unusable. There is a method called `bad()` that provides a bit more information. If `bad()` returns `true`, it means that a fatal error has occurred (as opposed to any nonfatal condition like end-of-file, `eof()`). Another method, `fail()`, returns `true` if the most recent operation has failed; however, it doesn't say anything about the next operation, which can either succeed or fail as well. For example, after calling `flush()` on an output stream, you could call `fail()` to make sure the flush was successful.

```
cout.flush();
if (cout.fail()) {
    cerr << "Unable to flush to standard out" << endl;
}
```

Streams have a conversion operator to convert to type `bool`. This conversion operator returns the same as calling `!fail()`. So, the previous code snippet can be rewritten as follows:

```
cout.flush();
if (!cout) {
    cerr << "Unable to flush to standard out" << endl;
}
```

Important to know is that both `good()` and `fail()` return `false` if the end-of-file is reached. The relation is as follows: `good() == (!fail() && !eof())`.

You can also tell the streams to throw exceptions when a failure occurs. You then write a `catch` handler to catch `ios_base::failure` exceptions, on which you can use the `what()` method to get a description of the error, and the `code()` method to get the error code. However, whether or not you get useful information depends on the Standard Library implementation that you use.

```
cout.exceptions(ios::failbit | ios::badbit | ios::eofbit);
try {
    cout << "Hello World." << endl;
} catch (const ios_base::failure& ex) {
    cerr << "Caught exception: " << ex.what()
        << ", error code = " << ex.code() << endl;
}
```

To reset the error state of a stream, use the `clear()` method:

```
cout.clear();
```

Error checking is performed less frequently for console output streams than for file output or input streams. The methods discussed here apply for other types of streams as well and are revisited later as each type is discussed.

Output Manipulators

One of the unusual features of streams is that you can throw more than just data down the chute. C++ streams also recognize *manipulators*, objects that make a change to the behavior of the stream instead of, or in addition to, providing data for the stream to work with.

You have already seen one manipulator: `endl`. The `endl` manipulator encapsulates data and behavior. It tells the stream to output an end-of-line sequence and to flush its buffer. Following are some other useful manipulators, many of which are defined in the `<ios>` and `<iomanip>` standard header files. The example after this list shows how to use them.

- **boolalpha** and **noboolalpha**: Tells the stream to output `bool` values as *true* and *false* (`boolalpha`) or *1* and *0* (`noboolalpha`). The default is `noboolalpha`.
- **hex**, **oct**, and **dec**: Outputs numbers in hexadecimal, octal, and base 10, respectively.
- **setprecision**: Sets the number of decimal places that are output for fractional numbers. This is a parameterized manipulator (meaning that it takes an argument).
- **setw**: Sets the field width for outputting numerical data. This is a parameterized manipulator.
- **setfill**: Specifies the character that is used to pad numbers that are smaller than the specified width. This is a parameterized manipulator.
- **showpoint** and **noshowpoint**: Forces the stream to always or never show the decimal point for floating point numbers with no fractional part.
- **put_money**: A parameterized manipulator that writes a formatted monetary value to a stream.
- **put_time**: A parameterized manipulator that writes a formatted time to a stream.
- **quoted**: A parameterized manipulator that encloses a given string with quotes and escapes embedded quotes.

All of these manipulators stay in effect for subsequent output to the stream until they are reset, except `setw`, which is only active for the next single output. The following example uses several of these manipulators to customize its output:

```
// Boolean values
bool myBool = true;
cout << "This is the default: " << myBool << endl;
cout << "This should be true: " << boolalpha << myBool << endl;
cout << "This should be 1: " << noboolalpha << myBool << endl;

// Simulate "%6d" with streams
int i = 123;
printf("This should be ' 123': %6d\n", i);
cout << "This should be ' 123': " << setw(6) << i << endl;
```

```

// Simulate "%06d" with streams
printf("This should be '000123': %06d\n", i);
cout << "This should be '000123': " << setfill('0') << setw(6) << i << endl;

// Fill with *
cout << "This should be '***123': " << setfill('*') << setw(6) << i << endl;
// Reset fill character
cout << setfill(' ');

// Floating point values
double dbl = 1.452;
double dbl2 = 5;
cout << "This should be ' 5': " << setw(2) << noshowpoint << dbl2 << endl;
cout << "This should be @@1.452: " << setw(7) << setfill('@') << dbl << endl;
// Reset fill character
cout << setfill(' ');

// Instructs cout to start formatting numbers according to your location.
// Chapter 19 explains the details of the imbue call and the locale object.
cout.imbue(locale(""));

// Format numbers according to your location
cout << "This is 1234567 formatted according to your location: " << 1234567
    << endl;

// Monetary value. What exactly a monetary value means depends on your
// location. For example, in the USA, a monetary value of 120000 means 120000
// dollar cents, which is 1200.00 dollars.
cout << "This should be a monetary value of 120000, "
    << "formatted according to your location: "
    << put_money("120000") << endl;

// Date and time
time_t t_t = time(nullptr); // Get current system time
tm* t = localtime(&t_t);    // Convert to local time
cout << "This should be the current date and time "
    << "formatted according to your location: "
    << put_time(t, "%c") << endl;

// Quoted string
cout << "This should be: \"Quoted string with \\\"embedded quotes\\\".\".: "
    << quoted("Quoted string with \"embedded quotes\".") << endl;

```

NOTE *This example might give you a security-related error or warning on the call to `localtime()`. With Microsoft Visual C++ you can use the safe version, called `localtime_s()`. On Linux you can use `localtime_r()`.*

If you don't care for the concept of manipulators, you can usually get by without them. Streams provide much of the same functionality through equivalent methods like `precision()`. For example, take the following line:

```
cout << "This should be '1.2346': " << setprecision(5) << 1.23456789 << endl;
```

This can be converted to use a method call as follows. The advantage of the method calls is that they return the previous value, allowing you to restore it, if needed.

```
cout.precision(5);
cout << "This should be '1.2346': " << 1.23456789 << endl;
```

For a detailed description of all stream methods and manipulators, consult a Standard Library Reference, for example, the book *C++ Standard Library Quick Reference*, or online references <http://www.cppreference.com/> or <http://www.cplusplus.com/reference/>.

Input with Streams

Input streams provide a simple way to read in structured or unstructured data. In this section, the techniques for input are discussed within the context of `cin`, the console input stream.

Input Basics

There are two easy ways to read data by using an input stream. The first is an analog of the `<<` operator that outputs data to an output stream. The corresponding operator for reading data is `>>`. When you use `>>` to read data from an input stream, the variable you provide is the storage for the received value. For example, the following program reads one word from the user and puts it into a string. Then the string is output back to the console.

```
string userInput;
cin >> userInput;
cout << "User input was " << userInput << endl;
```

By default, the `>>` operator tokenizes values according to white space. For example, if a user runs the previous program and enters `hello there` as input, only the characters up to the first white space character (the space character in this instance) are captured into the `userInput` variable. The output would be as follows:

```
User input was hello
```

One solution to include white space in the input is to use `get()`, which is discussed later in this chapter.

The `>>` operator works with different variable types, just like the `<<` operator. For example, to read an integer, the code differs only in the type of the variable:

```
int userInput;
cin >> userInput;
cout << "User input was " << userInput << endl;
```

You can use input streams to read in multiple values, mixing and matching types as necessary. For example, the following function, an excerpt from a restaurant reservation system, asks the user for a last name and the number of people in their party:

```
void getReservationData()
{
    string guestName;
    int partySize;
    cout << "Name and number of guests: ";
    cin >> guestName >> partySize;
    cout << "Thank you, " << guestName << "." << endl;
```

```

    if (partySize > 10) {
        cout << "An extra gratuity will apply." << endl;
    }
}

```

Remember that the `>>` operator tokenizes values according to white space, so the `getReservationData()` function does not allow you to enter a name with white space. A solution using `unget()` is discussed later in this chapter. Note also that even though the use of `cout` does not explicitly flush the buffer using `endl` or `flush()`, the text will still be written to the console because the use of `cin` immediately flushes the `cout` buffer; they are linked together in this way.

NOTE *If you get confused between `<<` and `>>`, just think of the angles as pointing toward their destination. In an output stream, `<<` points toward the stream itself because data is being sent to the stream. In an input stream, `>>` points toward the variables because data is being stored.*

Handling Input Errors

Input streams have a number of methods to detect unusual circumstances. Most of the error conditions related to input streams occur when there is no data available to read. For example, the end of stream (referred to as *end-of-file*, even for non-file streams) may have been reached. The most common way of querying the state of an input stream is to access it within a conditional. For example, the following loop keeps looping as long as `cin` remains in a good state:

```
while (cin) { ... }
```

You can input data at the same time:

```
while (cin >> ch) { ... }
```

The `good()`, `bad()`, and `fail()` methods can be called on input streams, just as on output streams. There is also an `eof()` method that returns `true` if the stream has reached its end. Similar as for output streams, both `good()` and `fail()` return `false` if the end-of-file is reached. The relation is again as follows: `good() == (!fail() && !eof())`.

You should get into the habit of checking the stream state after reading data so that you can recover from bad input.

The following program shows the common pattern for reading data from a stream and handling errors. The program reads numbers from standard input and displays their sum once end-of-file is reached. Note that in command-line environments, the end-of-file is indicated by the user typing a particular character. In Unix and Linux, it is `Control+D`; in Windows it is `Control+Z`. The exact character is operating-system dependent, so you will need to know what your operating system requires:

```

cout << "Enter numbers on separate lines to add. "
    << "Use Control+D to finish (Control+Z in Windows)." << endl;
int sum = 0;

```

```

if (!cin.good()) {
    cerr << "Standard input is in a bad state!" << endl;
    return 1;
}

int number;
while (!cin.bad()) {
    cin >> number;
    if (cin.good()) {
        sum += number;
    } else if (cin.eof()) {
        break; // Reached end of file
    } else if (cin.fail()) {
        // Failure!
        cin.clear(); // Clear the failure state.
        string badToken;
        cin >> badToken; // Consume the bad input.
        cerr << "WARNING: Bad input encountered: " << badToken << endl;
    }
}
cout << "The sum is " << sum << endl;

```

Here is some example output of this program:

```

Enter numbers on separate lines to add. Use Control+D to finish (Control+Z in
Windows).
1
2
test
WARNING: Bad input encountered: test
3
^Z
The sum is 6

```

Input Methods

Just like output streams, input streams have several methods that allow a lower level of access than the functionality provided by the more common `>>` operator.

get()

The `get()` method allows raw input of data from a stream. The simplest version of `get()` returns the next character in the stream, though other versions exist that read multiple characters at once. `get()` is most commonly used to avoid the automatic tokenization that occurs with the `>>` operator. For example, the following function reads a name, which can be made up of several words, from an input stream until the end of the stream is reached:

```

string readName(istream& stream)
{
    string name;
    while (stream) { // Or: while (!stream.fail()) {
        int next = stream.get();
        if (!stream || next == std::char_traits<char>::eof())
            break;
    }
}

```

```

        name += static_cast<char>(next); // Append character.
    }
    return name;
}

```

There are several interesting observations to make about this `readName()` function:

- Its parameter is a non-const reference to an `istream`, not a const reference. The methods that read in data from a stream will change the actual stream (most notably, its position), so they are not const methods. Thus, you cannot call them on a const reference.
- The return value of `get()` is stored in an `int`, not in a `char`, because `get()` can return special non-character values such as `std::char_traits<char>::eof()` (end-of-file).

`readName()` is a bit strange because there are two ways to get out of the loop: either the stream can get into a failed state, or the end of the stream is reached. A more common pattern for reading from a stream uses a different version of `get()` that takes a reference to a character and returns a reference to the stream. This pattern takes advantage of the fact that evaluating an input stream within a conditional context results in `true` only if the stream is not in any error state. Encountering an error causes the stream to evaluate to `false`. The underlying details of the conversion operations required to implement this feature are explained in Chapter 15. The following version of the same function is a bit more concise:

```

string readName(istream& stream)
{
    string name;
    char next;
    while (stream.get(next)) {
        name += next;
    }
    return name;
}

```

unget()

For most purposes, the correct way to think of an input stream is as a one-way chute. Data falls down the chute and into variables. The `unget()` method breaks this model in a way by allowing you to push data back up the chute.

A call to `unget()` causes the stream to back up by one position, essentially putting the previous character read back on the stream. You can use the `fail()` method to see if `unget()` was successful or not. For example, `unget()` can fail if the current position is at the beginning of the stream.

The `getReservationData()` function seen earlier in this chapter did not allow you to enter a name with white space. The following code uses `unget()` to allow white space in the name. The code reads character by character and checks whether the character is a digit or not. If the character is not a digit, it is added to `guestName`. If it is a digit, the character is put back into the stream using `unget()`, the loop is stopped, and the `>>` operator is used to input an integer, `partySize`. The `noskipws` input manipulator tells the stream not to skip white space, that is, white space is read like any other characters.

```

void getReservationData()
{

```

```

string guestName;
int partySize = 0;
// Read characters until we find a digit
char ch;
cin >> noskipws;
while (cin >> ch) {
    if (isdigit(ch)) {
        cin.unget();
        if (cin.fail())
            cout << "unget() failed" << endl;
        break;
    }
    guestName += ch;
}
// Read partySize, if the stream is not in error state
if (cin)
    cin >> partySize;
if (!cin) {
    cerr << "Error getting party size." << endl;
    return;
}

cout << "Thank you '" << guestName
    << "', party of " << partySize << endl;
if (partySize > 10) {
    cout << "An extra gratuity will apply." << endl;
}
}

```

putback()

The `putback()` method, like `unget()`, lets you move backward by one character in an input stream. The difference is that the `putback()` method takes the character being placed back on the stream as a parameter:

```

char ch1;
cin >> ch1;
cin.putback('e');
// 'e' will be the next character read off the stream.

```

peek()

The `peek()` method allows you to preview the next value that *would* be returned if you were to call `get()`. To take the chute metaphor perhaps a bit too far, you could think of it as looking up the chute without a value actually falling down it.

`peek()` is ideal for any situation where you need to look ahead before reading a value. For example, the following code implements the `getReservationData()` function that allows white space in the name, but uses `peek()` instead of `unget()`:

```

void getReservationData()
{
    string guestName;
    int partySize = 0;
    // Read characters until we find a digit

```



```

char ch;
cin >> noskipws;
while (true) {
    // 'peek' at next character
    ch = static_cast<char>(cin.peek());
    if (!cin)
        break;
    if (isdigit(ch)) {
        // next character will be a digit, so stop the loop
        break;
    }
    // next character will be a non-digit, so read it
    cin >> ch;
    if (!cin)
        break;
    guestName += ch;
}
// Read partySize, if the stream is not in error state
if (cin)
    cin >> partySize;
if (!cin) {
    cerr << "Error getting party size." << endl;
    return;
}

cout << "Thank you '" << guestName
     << "', party of " << partySize << endl;
if (partySize > 10) {
    cout << "An extra gratuity will apply." << endl;
}
}

```

getline()

Obtaining a single line of data from an input stream is so common that a method exists to do it for you. The `getline()` method fills a character buffer with a line of data up to the specified size. The specified size includes the `\0` character. Thus, the following code reads a maximum of `kBufferSize-1` characters from `cin`, or until an end-of-line sequence is read:

```

char buffer[kBufferSize] = { 0 };
cin.getline(buffer, kBufferSize);

```

When `getline()` is called, it reads a line from the input stream, up to and including the end-of-line sequence. However, the end-of-line character or characters do not appear in the string. Note that the end-of-line sequence is platform dependent. For example, it can be `\r\n`, or `\n`, or `\n\r`.

There is a form of `get()` that performs the same operation as `getline()`, except that it leaves the newline sequence in the input stream.

There is also a function called `std::getline()` that can be used with C++ strings. It is defined in the `<string>` header file and is in the `std` namespace. It takes a stream reference, a string reference, and an optional delimiter as parameters. The advantage of using this version of `getline()` is that it doesn't require you to specify the size of the buffer.

```

string myString;
std::getline(cin, myString);

```

Input Manipulators

The built-in input manipulators, described in the list that follows, can be sent to an input stream to customize the way that data is read.

- **boolalpha** and **noboolalpha**: If `boolalpha` is used, the string *false* will be interpreted as the Boolean value `false`; anything else will be treated as the Boolean value `true`. If `noboolalpha` is set, zero will be interpreted as `false`, anything else as `true`. The default is `noboolalpha`.
- **hex**, **oct**, and **dec**: Reads numbers in hexadecimal, octal, and base 10, respectively.
- **skipws** and **noskipws**: Tells the stream to either skip white space when tokenizing, or to read in white space as its own token. The default is `skipws`.
- **ws**: A handy manipulator that simply skips over the current series of white space at the current position in the stream.
- **get_money**: A parameterized manipulator that reads a monetary value from a stream.
- **get_time**: A parameterized manipulator that reads a formatted time from a stream.
- **quoted**: A parameterized manipulator that reads a string enclosed with quotes and in which embedded quotes are escaped.

Input is locale aware. For example, the following code enables your system locale for `cin`. Locales are discussed in Chapter 19:

```
cin.imbue(locale(""));
int i;
cin >> i;
```

If your system locale is U.S. English, you can enter `1,000` and it will be parsed as `1000`. If you would enter `1.000`, it will be parsed as `1`. On the other hand, if your system locale is Dutch Belgium, you can enter `1.000` to get the value of `1000`, but entering `1,000` will result in `1`. In both cases, you can also just enter `1000` without any digit separators to get the value `1000`.

Input and Output with Objects

You can use the `<<` operator to output a C++ *string* even though it is not a basic type. In C++, objects are able to prescribe how they are output and input. This is accomplished by *overloading* the `<<` and `>>` operators to understand a new type or class.

Why would you want to overload these operators? If you are familiar with the `printf()` function in C, you know that it is not flexible in this area. `printf()` knows about several types of data, but there really isn't a way to give it additional knowledge. For example, consider the following simple class:

```
class Muffin
{
public:
    virtual ~Muffin() = default;

    string_view getDescription() const;
    void setDescription(string_view description);
```

```

        int getSize() const;
        void setSize(int size);

        bool hasChocolateChips() const;
        void setHasChocolateChips(bool hasChips);
    private:
        string mDescription;
        int mSize = 0;
        bool mHasChocolateChips = false;
};

string_view Muffin::getDescription() const { return mDescription; }

void Muffin::setDescription(string_view description)
{
    mDescription = description;
}

int Muffin::getSize() const { return mSize; }
void Muffin::setSize(int size) { mSize = size; }

bool Muffin::hasChocolateChips() const { return mHasChocolateChips; }

void Muffin::setHasChocolateChips(bool hasChips)
{
    mHasChocolateChips = hasChips;
}

```

To output an object of class `Muffin` by using `printf()`, it would be nice if you could specify it as an argument, perhaps using `%m` as a placeholder:

```
printf("Muffin: %m\n", myMuffin); // BUG! printf doesn't understand Muffin.
```

Unfortunately, the `printf()` function knows nothing about the `Muffin` type and is unable to output an object of type `Muffin`. Worse still, because of the way the `printf()` function is declared, this will result in a run-time error, not a compile-time error (though a good compiler will give you a warning).

The best you can do with `printf()` is to add a new `output()` method to the `Muffin` class:

```

class Muffin
{
    public:
        // Omitted for brevity
        void output() const;
        // Omitted for brevity
};

// Other method implementations omitted for brevity

void Muffin::output() const
{
    printf("%s, Size is %d, %s\n", getDescription().data(), getSize(),
        (hasChocolateChips() ? "has chips" : "no chips"));
}

```

Using such a mechanism is cumbersome, however. To output a `Muffin` in the middle of another line of text, you'd need to split the line into two calls with a call to `Muffin::output()` in between, as shown here:

```
printf("The muffin is ");
myMuffin.output();
printf(" -- yummy!\n");
```

Overloading the `<<` operator lets you output a `Muffin` just like you output a `string`—by providing it as an argument to `<<`. Chapter 15 covers the details of overloading the `<<` and `>>` operators.

STRING STREAMS

String streams provide a way to use stream semantics with `strings`. In this way, you can have an *in-memory stream* that represents textual data. For example, in a GUI application you might want to use streams to build up textual data, but instead of outputting the text to the console or a file, you might want to display the result in a GUI element like a message box or an edit control. Another example could be that you want to pass a string stream around to different functions, while retaining the current read position, so that each function can process the next part of the stream. String streams are also useful for parsing text, because streams have built-in tokenizing functionality.

The `std::ostringstream` class is used to write data to a `string`, while the `std::istringstream` class is used to read data from a `string`. They are both defined in the `<sstream>` header file. Because `ostringstream` and `istringstream` inherit the same behavior as `ostream` and `istream`, working with them is pleasantly similar.

The following program requests words from the user and outputs them to a single `ostringstream`, separated by the tab character. At the end of the program, the whole stream is turned into a `string` object using the `str()` method and is written to the console. Input of tokens can be stopped by entering the token “done” or by closing the input stream with `Control+D` (Unix) or `Control+Z` (Windows).

```
cout << "Enter tokens. Control+D (Unix) or Control+Z (Windows) to end" << endl;
ostringstream outStream;
while (cin) {
    string nextToken;
    cout << "Next token: ";
    cin >> nextToken;
    if (!cin || nextToken == "done")
        break;
    outStream << nextToken << "\t";
}
cout << "The end result is: " << outStream.str();
```

Reading data from a string stream is similarly familiar. The following function creates and populates a `Muffin` object (see the earlier example) from a string input stream. The stream data is in a fixed format so that the function can easily turn its values into calls to the `Muffin` setters.

```
Muffin createMuffin(istringstream& stream)
{
    Muffin muffin;
    // Assume data is properly formatted:
```

```

    // Description size chips

    string description;
    int size;
    bool hasChips;

    // Read all three values. Note that chips is represented
    // by the strings "true" and "false"
    stream >> description >> size >> boolalpha >> hasChips;
    if (stream) { // Reading was successful.
        muffin.setSize(size);
        muffin.setDescription(description);
        muffin.setHasChocolateChips(hasChips);
    }
    return muffin;
}

```

NOTE *Turning an object into a “flattened” type, like a string, is often called marshalling. Marshalling is useful for saving objects to disk or sending them across a network.*

An advantage of string streams over standard C++ strings is that, in addition to data, they know where the next read or write operation will take place, also called the *current position*. Another advantage is that string streams support manipulators and locales to enable more powerful formatting compared to strings.

FILE STREAMS

Files lend themselves very well to the stream abstraction because reading and writing files always involves a position in addition to the data. In C++, the `std::ofstream` and `std::ifstream` classes provide output and input functionality for files. They are defined in the `<fstream>` header file.

When dealing with the file system, it is especially important to detect and handle error cases. The file you are working with could be on a network file store that just went offline, or you may be trying to write to a file that is located on a disk that is full. Maybe you are trying to open a file for which the current user does not have permissions. Error conditions can be detected by using the standard error handling mechanisms described earlier.

The only major difference between output file streams and other output streams is that the file stream constructor can take the name of the file and the mode in which you would like to open it. The default mode is write, `ios_base::out`, which starts writing to a file at the beginning, overwriting any existing data. You can also open an output file stream in append mode by specifying the constant `ios_base::app` as second argument to the file stream constructor. The following table lists the different constants that are available.

CONSTANT	DESCRIPTION
<code>ios_base::app</code>	Open, and go to the end before each write operation.
<code>ios_base::ate</code>	Open, and go to the end once immediately after opening.
<code>ios_base::binary</code>	Perform input and output in binary mode as opposed to text mode. See the next section.
<code>ios_base::in</code>	Open for input, start reading at the beginning.
<code>ios_base::out</code>	Open for output, start writing at the beginning, overwriting existing data.
<code>ios_base::trunc</code>	Open for output, and delete all existing data (truncate).

Note that modes can be combined. For example, if you want to open a file for output in binary mode, while truncating existing data, you would specify the open mode as follows:

```
ios_base::out | ios_base::binary | ios_base::trunc
```

An `ifstream` automatically includes the `ios_base::in` mode, while an `ofstream` automatically includes the `ios_base::out` mode, even if you don't explicitly specify `in` or `out` as the mode.

The following program opens the file `test.txt` and outputs the arguments to the program. The `ifstream` and `ofstream` destructors automatically close the underlying file, so there is no need to explicitly call `close()`.

```
int main(int argc, char* argv[])
{
    ofstream outFile("test.txt", ios_base::trunc);
    if (!outFile.good()) {
        cerr << "Error while opening output file!" << endl;
        return -1;
    }
    outFile << "There were " << argc << " arguments to this program." << endl;
    outFile << "They are: " << endl;
    for (int i = 0; i < argc; i++) {
        outFile << argv[i] << endl;
    }
    return 0;
}
```

Text Mode versus Binary Mode

By default, a file stream is opened in *text mode*. If you specify the `ios_base::binary` flag, then the file is opened in *binary mode*.

In binary mode, the exact bytes you ask the stream to write are written to the file. When reading, the bytes are returned to you exactly as they are in the file.

In text mode, there is some hidden conversion happening: each line you write to, or read from a file ends with a `\n`. However, it is operating-system dependent how the end of a line is encoded in a file. For example, on Windows, a line ends with `\r\n` instead of with a single `\n` character. Therefore, when a file is opened in text mode and you write a line ending with `\n` to it, the underlying implementation automatically converts the `\n` to `\r\n` before writing it to the file. Similarly, when reading a line from the file, the `\r\n` that is read from the file is automatically converted back to `\n` before being returned to you.

Jumping around with `seek()` and `tell()`

The `seek()` and `tell()` methods are present on all input and output streams.

The `seek()` methods let you move to an arbitrary position within an input or output stream. There are several forms of `seek()`. The methods of `seek()` within an input stream are actually called `seekg()` (the *g* is for *get*), and the versions of `seek()` in an output stream are called `seekp()` (the *p* is for *put*). You might wonder why there is both a `seekg()` and a `seekp()` method, instead of one `seek()` method. The reason is that you can have streams that are both input and output, for example, file streams. In that case, the stream needs to remember both a read position and a separate write position. This is also called bidirectional I/O and is covered later in this chapter.

There are two overloads of `seekg()` and two of `seekp()`. One overload accepts a single argument, an absolute position, and seeks to this absolute position. The second overload accepts an offset and a position, and seeks an offset relative to the given position. Positions are of type `std::streampos`, while offsets are of type `std::streamoff`; both are measured in bytes. There are three predefined positions available, as shown here.

POSITION	DESCRIPTION
<code>ios_base::beg</code>	The beginning of the stream
<code>ios_base::end</code>	The end of the stream
<code>ios_base::cur</code>	The current position in the stream

For example, to seek to an absolute position in an output stream, you can use the one-parameter version of `seekp()`, as in the following case, which uses the constant `ios_base::beg` to move to the beginning of the stream:

```
outStream.seekp(ios_base::beg);
```

Seeking within an input stream is exactly the same, except that the `seekg()` method is used:

```
inStream.seekg(ios_base::beg);
```

The two-argument versions move to a relative position in the stream. The first argument prescribes how many positions to move, and the second argument provides the starting point. To move relative to the beginning of the file, the constant `ios_base::beg` is used. To move relative to the end of the file, `ios_base::end` is used. And to move relative to the current position, `ios_base::cur` is used. For example, the following line moves to the second byte from the beginning of the stream. Note that integers are implicitly converted to type `streampos` and `streamoff`.

```
outStream.seekp(2, ios_base::beg);
```

The next example moves to the third-to-last byte of an input stream:

```
inStream.seekg(-3, ios_base::end);
```

You can also query a stream's current location using the `tell()` method, which returns a `streampos` that indicates the current position. You can use this result to remember the current marker position before doing a `seek()` or to query whether you are in a particular location. As with `seek()`, there are separate versions of `tell()` for input streams and output streams. Input streams use `tellg()`, and output streams use `tellp()`.

The following code checks the position of an input stream to determine if it is at the beginning:

```
std::streampos curPos = inStream.tellg();
if (ios_base::beg == curPos) {
    cout << "We're at the beginning." << endl;
}
```

Following is a sample program that brings it all together. This program writes into a file called `test.out` and performs the following tests:

1. Outputs the string `12345` to the file.
2. Verifies that the marker is at position 5 in the stream.
3. Moves to position 2 in the output stream.
4. Outputs a `0` in position 2 and closes the output stream.
5. Opens an input stream on the `test.out` file.
6. Reads the first token as an integer.
7. Confirms that the value is `12045`.

```
ofstream fout("test.out");
if (!fout) {
    cerr << "Error opening test.out for writing" << endl;
    return 1;
}

// 1. Output the string "12345".
fout << "12345";

// 2. Verify that the marker is at position 5.
streampos curPos = fout.tellp();
if (5 == curPos) {
    cout << "Test passed: Currently at position 5" << endl;
} else {
    cout << "Test failed: Not at position 5" << endl;
}

// 3. Move to position 2 in the stream.
fout.seekp(2, ios_base::beg);

// 4. Output a 0 in position 2 and close the stream.
fout << 0;
```



```

fout.close();

// 5. Open an input stream on test.out.
ifstream fin("test.out");
if (!fin) {
    cerr << "Error opening test.out for reading" << endl;
    return 1;
}

// 6. Read the first token as an integer.
int testVal;
fin >> testVal;
if (!fin) {
    cerr << "Error reading from file" << endl;
    return 1;
}

// 7. Confirm that the value is 12045.
const int expected = 12045;
if (testVal == expected) {
    cout << "Test passed: Value is " << expected << endl;
} else {
    cout << "Test failed: Value is not " << expected
        << " (it was " << testVal << ")" << endl;
}

```

Linking Streams Together

A link can be established between any input and output streams to give them *flush-on-access* behavior. In other words, when data is requested from an input stream, its linked output stream is automatically flushed. This behavior is available to all streams, but is particularly useful for file streams that may be dependent upon each other.

Stream linking is accomplished with the `tie()` method. To tie an output stream to an input stream, call `tie()` on the input stream, and pass the address of the output stream. To break the link, pass `nullptr`.

The following program ties the input stream of one file to the output stream of an entirely different file. You could also tie it to an output stream on the same file, but bidirectional I/O (covered in the next section) is perhaps a more elegant way to read and write the same file simultaneously.

```

ifstream inFile("input.txt"); // Note: input.txt must exist.
ofstream outFile("output.txt");
// Set up a link between inFile and outFile.
inFile.tie(&outFile);
// Output some text to outFile. Normally, this would
// not flush because std::endl is not sent.
outFile << "Hello there!";
// outFile has NOT been flushed.
// Read some text from inFile. This will trigger flush()
// on outFile.
string nextToken;
inFile >> nextToken;
// outFile HAS been flushed.

```

The `flush()` method is defined on the `ostream` base class, so you can also link an output stream to another output stream:

```
outFile.tie(&anotherOutputFile);
```

Such a relationship means that every time you write to one file, the buffered data that has been sent to the other file is flushed. You can use this mechanism to keep two related files synchronized.

One example of this stream linking is the link between `cout` and `cin`. Whenever you try to input data from `cin`, `cout` is automatically flushed. There is also a link between `cerr` and `cout`, meaning that any output to `cerr` causes `cout` to flush. The `clog` stream on the other hand is not linked to `cout`. The wide versions of these streams have similar links.

BIDIRECTIONAL I/O

So far, this chapter has discussed input and output streams as two separate but related classes. In fact, there is such a thing as a stream that performs both input and output. A *bidirectional stream* operates as both an input stream and an output stream.

Bidirectional streams derive from `iostream`, which in turn derives from both `istream` and `ostream`, thus serving as an example of useful multiple inheritance. As you would expect, bidirectional streams support both the `>>` operator and the `<<` operator, as well as the methods of both input streams and output streams.

The `fstream` class provides a bidirectional file stream. `fstream` is ideal for applications that need to replace data within a file because you can read until you find the correct position, then immediately switch to writing. For example, imagine a program that stores a list of mappings between ID numbers and phone numbers. It might use a data file with the following format:

```
123 408-555-0394
124 415-555-3422
263 585-555-3490
100 650-555-3434
```

A reasonable approach to such a program would be to read in the entire data file when the program opens and rewrite the file, with any modifications, when the program closes. If the data set is huge, however, you might not be able to keep everything in memory. With `iostreams`, you don't have to. You can easily scan through the file to find a record, and you can add new records by opening the file for output in append mode. To modify an existing record, you could use a bidirectional stream, as in the following function that changes the phone number for a given ID:

```
bool changeNumberForID(string_view filename, int id, string_view newNumber)
{
    ifstream ioData(filename.data());
    if (!ioData) {
        cerr << "Error while opening file " << filename << endl;
        return false;
    }

    // Loop until the end of file
    while (ioData) {
```

```

int idRead;
string number;

// Read the next ID.
ioData >> idRead;
if (!ioData)
    break;

// Check to see if the current record is the one being changed.
if (idRead == id) {
    // Seek the write position to the current read position
    ioData.seekp(ioData.tellg());
    // Output a space, then the new number.
    ioData << " " << newNumber;
    break;
}

// Read the current number to advance the stream.
ioData >> number;
}
return true;
}

```

Of course, an approach like this only works properly if the data is of a fixed size. When the preceding program switched from reading to writing, the output data overwrote other data in the file. To preserve the format of the file, and to avoid writing over the next record, the data had to be the exact same size.

String streams can also be accessed in a bidirectional manner through the `stringstream` class.

NOTE *Bidirectional streams have separate pointers for the read position and the write position. When switching between reading and writing, you need to seek to the appropriate position.*

SUMMARY

Streams provide a flexible and object-oriented way to perform input and output. The most important message in this chapter, even more important than the use of streams, is the concept of a stream. Some operating systems may have their own file access and I/O facilities, but knowledge of how streams and stream-like libraries work is essential to working with any type of modern I/O system.

14

Handling Errors

WHAT'S IN THIS CHAPTER?

- How to handle errors in C++, including pros and cons of exceptions
- The syntax of exceptions
- Exception class hierarchies and polymorphism
- Stack unwinding and cleanup
- Common error-handling situations

WROX.COM DOWNLOADS FOR THIS CHAPTER

Please note that all the code examples for this chapter are available as a part of this chapter's code download on the book's website at www.wrox.com/go/proc++4e on the Download Code tab.

Inevitably, your C++ programs will encounter errors. The program might be unable to open a file, the network connection might go down, or the user might enter an incorrect value, to name a few possibilities. The C++ language provides a feature called *exceptions* to handle these *exceptional* but not *unexpected* situations.

The code examples in this book so far have generally ignored error conditions for brevity. This chapter rectifies that simplification by teaching you how to incorporate error handling into your programs from their beginnings. It focuses on C++ exceptions, including the details of their syntax, and describes how to employ them effectively to create well-designed error-handling programs.

ERRORS AND EXCEPTIONS

No program exists in isolation; they all depend on external facilities such as interfaces with the operating system, networks and file systems, external code such as third-party libraries, and user input. Each of these areas can introduce situations that require you to respond to problems you may encounter. These potential problems can be referred to with the general term *exceptional situations*. Even perfectly written programs encounter errors and exceptional situations. Thus, anyone who writes a computer program must include error-handling capabilities. Some languages, such as C, do not include many specific language facilities for error handling. Programmers using these languages generally rely on return values from functions and other ad hoc approaches. Other languages, such as Java, enforce the use of a language feature called *exceptions* as an error-handling mechanism. C++ lies between these extremes. It provides language support for exceptions, but does not require their use. However, you can't ignore exceptions entirely in C++ because a few basic facilities, such as memory allocation routines, use them.

What Are Exceptions, Anyway?

Exceptions are a mechanism for a piece of code to notify another piece of code of an “exceptional” situation or error condition without progressing through the normal code paths. The code that encounters the error *throws* the exception, and the code that handles the exception *catches* it. Exceptions do not follow the fundamental rule of step-by-step execution to which you are accustomed. When a piece of code throws an exception, the program control immediately stops executing code step by step and transitions to the exception handler, which could be anywhere from the next line in the same function to several function calls up the stack. If you like sports analogies, you can think of the code that throws an exception as an outfielder throwing a baseball back to the infield, where the nearest infielder (closest exception handler) catches it. Figure 14-1 shows a hypothetical stack of three function calls. Function A () has the exception handler. It calls function B (), which calls function C (), which throws the exception.

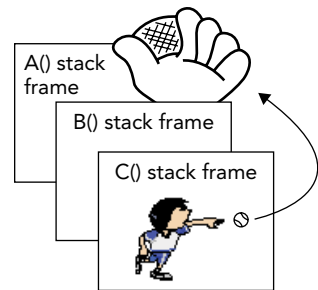

FIGURE 14-1

Figure 14-2 shows the handler catching the exception. The stack frames for C () and B () have been removed, leaving only A ().

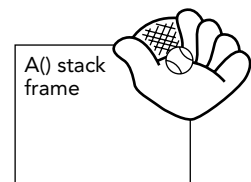

FIGURE 14-2

Most modern programming languages, such as C# and Java, have support for exceptions, so it's no surprise that C++ has full-fledged support for them as well. However, if you are coming from C, then exceptions are something new; but once you get used to them, you probably won't want to go back.

Why Exceptions in C++ Are a Good Thing

As mentioned earlier, run-time errors in programs are inevitable. Despite that fact, error handling in most C and C++ programs is messy and ad hoc. The de facto C error-handling standard, which

was carried over into many C++ programs, uses integer function return codes, and the `errno` macro to signify errors. Each thread has its own `errno` value. `errno` acts as a thread-local integer variable that functions can use to communicate errors back to calling functions.

Unfortunately, the integer return codes and `errno` are used inconsistently. Some functions might choose to return 0 for success and -1 for an error. If they return -1, they also set `errno` to an error code. Other functions return 0 for success and nonzero for an error, with the actual return value specifying the error code. These functions do not use `errno`. Still others return 0 for failure instead of for success, presumably because 0 always evaluates to `false` in C and C++.

These inconsistencies can cause problems because programmers encountering a new function often assume that its return codes are the same as other similar functions. That is not always true. For example, on Solaris 9, there are two different libraries of synchronization objects: the POSIX version and the Solaris version. The function to initialize a semaphore in the POSIX version is called `sem_init()`, and the function to initialize a semaphore in the Solaris version is called `sema_init()`. As if that weren't confusing enough, the two functions handle error codes differently! `sem_init()` returns -1 and sets `errno` on error, while `sema_init()` returns the error code directly as a positive integer, and does not set `errno`.

Another problem is that the return type of functions in C++ can only be of one type, so if you need to return both an error and a value, you must find an alternative mechanism. One solution is to return an `std::pair` or `std::tuple`, an object that you can use to store two or more types. These classes are discussed in the upcoming chapters that cover the Standard Library. Another choice is to define your own `struct` or class that contains several values, and return an instance of that `struct` or class from your function. Yet another option is to return the value or error through a reference parameter or to make the error code one possible value of the return type, such as a `nullptr` pointer. In all these solutions, the caller is responsible to explicitly check for any errors returned from the function and if it doesn't handle the error itself, it should propagate the error to its caller. Unfortunately, this often results in the loss of critical details about the error.

C programmers may be familiar with a mechanism known as `setjmp()/longjmp()`. This mechanism cannot be used correctly in C++, because it bypasses scoped destructors on the stack. You should avoid it at all costs, even in C programs; therefore, this book does not explain the details of how to use it.

Exceptions provide an easier, more consistent, and safer mechanism for error handling. There are several specific advantages of exceptions over the ad hoc approaches in C and C++.

- When return codes are used as an error reporting mechanism, you might forget to check the return code and properly handle it either locally or by propagating it upward. The C++17 `[[nodiscard]]` attribute, introduced in Chapter 11, offers a possible solution to prevent return codes from being ignored, but it's not foolproof either. Exceptions cannot be forgotten or ignored: if your program fails to catch an exception, it terminates.
- When integer return codes are used, they generally do not contain sufficient information. You can use exceptions to pass as much information as you want from the code that finds

the error to the code that handles it. Exceptions can also be used to communicate information other than errors, though many programmers consider that an abuse of the exception mechanism.

- Exception handling can skip levels of the call stack. That is, a function can handle an error that occurred several function calls down the stack, without error-handling code in the intermediate functions. Return codes require each level of the call stack to clean up explicitly after the previous level.

In some compilers (fewer and fewer these days), exception handling added a tiny amount of overhead to any function that had an exception handler. For most modern compilers there is a trade-off in that there is almost no overhead in the non-throwing case, and only some slight overhead when you actually throw something. This trade-off is not a bad thing because throwing an exception should be exceptional.

Exception handling is not enforced in C++. For example, in Java a function that does not specify a list of possible exceptions that it can throw is not allowed to throw any exceptions. In C++, it is just the opposite: a function can throw any exception it wants, unless it specifies that it will not throw any exceptions (using the `noexcept` keyword)!

Recommendation

I recommend exceptions as a useful mechanism for error handling. I feel that the structure and error-handling formalization that exceptions provide outweigh the less desirable aspects. Thus, the remainder of this chapter focuses on exceptions. Also, many popular libraries, such as the Standard Library and Boost, use exceptions, so you need to be prepared to handle them.

EXCEPTION MECHANICS

Exceptional situations arise frequently in file input and output. The following is a function to open a file, read a list of integers from the file, and return the integers in an `std::vector` data structure. The lack of error handling should jump out at you.

```
vector<int> readIntegerFile(string_view fileName)
{
    ifstream inputStream(fileName.data());
    // Read the integers one-by-one and add them to a vector.
    vector<int> integers;
    int temp;
    while (inputStream >> temp) {
        integers.push_back(temp);
    }
    return integers;
}
```

The following line keeps reading values from the `ifstream` until the end of the file is reached or until an error occurs:

```
while (inputStream >> temp) {
```

If the `>>` operator encounters an error, it sets the fail bit of the `ifstream` object. In that case, the `bool()` conversion operator returns `false` and the `while` loop terminates. Streams are discussed in more detail in Chapter 13.

You might use `readIntegerFile()` like this:

```
const string fileName = "IntegerFile.txt";
vector<int> myInts = readIntegerFile(fileName);
for (const auto& element : myInts) {
    cout << element << " ";
}
cout << endl;
```

The rest of this section shows you how to add error handling with exceptions, but first, we need to delve a bit deeper into how you throw and catch exceptions.

Throwing and Catching Exceptions

Using exceptions consists of providing two parts in your program: a `try/catch` construct to handle an exception, and a `throw` statement that throws an exception. Both must be present in some form to make exceptions work. However, in many cases, the `throw` happens deep inside some library (including the C++ runtime) and the programmer never sees it, but still has to react to it using a `try/catch` construct.

The `try/catch` construct looks like this:

```
try {
    // ... code which may result in an exception being thrown
} catch (exception-type1 exception-name) {
    // ... code which responds to the exception of type 1
} catch (exception-type2 exception-name) {
    // ... code which responds to the exception of type 2
}
// ... remaining code
```

The code that may result in an exception being thrown might contain a `throw` directly. It might also be calling a function that either directly throws an exception or calls—by some unknown number of layers of calls—a function that throws an exception.

If no exception is thrown, the code in the `catch` blocks is not executed, and the “remaining code” that follows will follow the last statement executed in the `try` block.

If an exception is thrown, any code following the `throw` or following the call that resulted in the `throw`, is not executed; instead, control immediately goes to the right `catch` block, depending on the type of the exception that is thrown.

If the `catch` block does not do a control transfer—for example, by returning a value, throwing a new exception, or rethrowing the exception—then the “remaining code” is executed after the last statement of that `catch` block.

The simplest example to demonstrate exception handling is avoiding division-by-zero. This example throws an exception of type `std::invalid_argument`, which requires the `<stdexcept>` header:

```
double SafeDivide(double num, double den)
{
    if (den == 0)
        throw invalid_argument("Divide by zero");
    return num / den;
}

int main()
{
    try {
        cout << SafeDivide(5, 2) << endl;
        cout << SafeDivide(10, 0) << endl;
        cout << SafeDivide(3, 3) << endl;
    } catch (const invalid_argument& e) {
        cout << "Caught exception: " << e.what() << endl;
    }
    return 0;
}
```

The output is as follows:

```
2.5
Caught exception: Divide by zero
```

`throw` is a keyword in C++, and is the only way to throw an exception. The `invalid_argument()` part of the `throw` line means that you are constructing a new object of type `invalid_argument` to throw. It is one of the standard exceptions provided by the C++ Standard Library. All Standard Library exceptions form a hierarchy, which is discussed later in this chapter. Each class in the hierarchy supports a `what()` method that returns a `const char*` string describing the exception¹. This is the string you provide in the constructor of the exception.

Let's go back to the `readIntegerFile()` function. The most likely problem to occur is for the file open to fail. That's a perfect situation for throwing an exception. This code throws an exception of type `std::exception`, which requires the `<exception>` header. The syntax looks like this:

```
vector<int> readIntegerFile(string_view fileName)
{
    ifstream inputStream(fileName.data());
    if (inputStream.fail()) {
        // We failed to open the file: throw an exception
        throw exception();
    }

    // Read the integers one-by-one and add them to a vector
    vector<int> integers;
    int temp;
    while (inputStream >> temp) {
        integers.push_back(temp);
    }
    return integers;
}
```

¹Even though the return type of `what()` is `const char*`, exceptions can support Unicode strings if you encode them using UTF-8. See Chapter 19 for details on Unicode strings.

NOTE *Always document the possible exceptions a function can throw in its code documentation, because users of your function need to know which exceptions might get thrown so they can properly handle them.*

If the function fails to open the file and executes the `throw exception();` line, the rest of the function is skipped, and control transitions to the nearest exception handler.

Throwing exceptions in your code is most useful when you also write code that handles them. Exception handling is a way to “try” a block of code, with another block of code designated to react to any problems that might occur. In the following `main()` function, the `catch` statement reacts to any exception of type `exception` that was thrown within the `try` block by printing an error message. If the `try` block finishes without throwing an exception, the `catch` block is skipped. You can think of `try/catch` blocks as glorified `if` statements. If an exception is thrown in the `try` block, execute the `catch` block. Otherwise, skip it.

```
int main()
{
    const string fileName = "IntegerFile.txt";
    vector<int> myInts;
    try {
        myInts = readIntegerFile(fileName);
    } catch (const exception& e) {
        cerr << "Unable to open file " << fileName << endl;
        return 1;
    }
    for (const auto& element : myInts) {
        cout << element << " ";
    }
    cout << endl;
    return 0;
}
```

NOTE *Although by default, streams do not throw exceptions, you can tell the streams to throw exceptions for error conditions by calling their `exceptions()` method. However, most compilers give useless information in the stream exceptions they throw. For such compilers, it might be better to deal with the stream state directly instead of using exceptions. This book does not use stream exceptions.*

Exception Types

You can throw an exception of any type. The preceding example throws an object of type `std::exception`, but exceptions do not need to be objects. You could throw a simple `int` like this:

```
vector<int> readIntegerFile(string_view fileName)
{
    ifstream inputStream(fileName.data());
```

```
        if (inputStream.fail()) {
            // We failed to open the file: throw an exception
            throw 5;
        }
        // Omitted for brevity
    }
```

You would then need to change the catch statement as well:

```
try {
    myInts = readIntegerFile(fileName);
} catch (int e) {
    cerr << "Unable to open file " << fileName << " (" << e << ")" << endl;
    return 1;
}
```

Alternatively, you could throw a `const char*` C-style string. This technique is sometimes useful because the string can contain information about the exception.

```
vector<int> readIntegerFile(string_view fileName)
{
    ifstream inputStream(fileName.data());
    if (inputStream.fail()) {
        // We failed to open the file: throw an exception
        throw "Unable to open file";
    }
    // Omitted for brevity
}
```

When you catch the `const char*` exception, you can print the result:

```
try {
    myInts = readIntegerFile(fileName);
} catch (const char* e) {
    cerr << e << endl;
    return 1;
}
```

Despite the previous examples, you should generally throw objects as exceptions for two reasons:

- Objects convey information by their class name.
- Objects can store information, including strings that describe the exceptions.

The C++ Standard Library defines a number of predefined exception classes, and you can write your own exception classes, as you'll learn later in this chapter.

Catching Exception Objects by `const` Reference

In the preceding example in which `readIntegerFile()` throws an object of type `exception`, the catch line looks like this:

```
    } catch (const exception& e) {
```

However, there is no requirement to catch objects by `const` reference. You could catch the object by value like this:

```
    } catch (exception e) {
```

Alternatively, you could catch the object by non-`const` reference:

```
    } catch (exception& e) {
```

Also, as you saw in the `const char*` example, you can catch pointers to exceptions, as long as pointers to exceptions are thrown.

NOTE *Always catch exception objects by `const` reference! This avoids object slicing, which could happen when you catch exception objects by value.*

Throwing and Catching Multiple Exceptions

Failure to open the file is not the only problem `readIntegerFile()` could encounter. Reading the data from the file can cause an error if it is formatted incorrectly. Here is an implementation of `readIntegerFile()` that throws an exception if it cannot either open the file or read the data correctly. This time, it uses a `runtime_error`, derived from `exception`, and which allows you to specify a descriptive string in its constructor. The `runtime_error` exception class is defined in `<stdexcept>`.

```
vector<int> readIntegerFile(string_view fileName)
{
    ifstream inputStream(fileName.data());
    if (inputStream.fail()) {
        // We failed to open the file: throw an exception
        throw runtime_error("Unable to open the file.");
    }

    // Read the integers one-by-one and add them to a vector
    vector<int> integers;
    int temp;
    while (inputStream >> temp) {
        integers.push_back(temp);
    }

    if (!inputStream.eof()) {
        // We did not reach the end-of-file.
        // This means that some error occurred while reading the file.
        // Throw an exception.
        throw runtime_error("Error reading the file.");
    }

    return integers;
}
```

Your code in `main()` does not need to change because it already catches an exception of type `exception`, from which `runtime_error` derives. However, that exception could now be thrown in two different situations.

```
try {
    myInts = readIntegerFile(fileName);
} catch (const exception& e) {
    cerr << e.what() << endl;
    return 1;
}
```

Alternatively, you could throw two different types of exceptions from `readIntegerFile()`. Here is an implementation of `readIntegerFile()` that throws an exception object of class `invalid_argument` if the file cannot be opened, and an object of class `runtime_error` if the integers cannot be read. Both `invalid_argument` and `runtime_error` are classes defined in the header file `<stdexcept>` as part of the C++ Standard Library.

```
vector<int> readIntegerFile(string_view fileName)
{
    ifstream inputStream(fileName.data());
    if (inputStream.fail()) {
        // We failed to open the file: throw an exception
        throw invalid_argument("Unable to open the file.");
    }

    // Read the integers one-by-one and add them to a vector
    vector<int> integers;
    int temp;
    while (inputStream >> temp) {
        integers.push_back(temp);
    }

    if (!inputStream.eof()) {
        // We did not reach the end-of-file.
        // This means that some error occurred while reading the file.
        // Throw an exception.
        throw runtime_error("Error reading the file.");
    }

    return integers;
}
```

There are no public default constructors for `invalid_argument` and `runtime_error`, only string constructors.

Now `main()` can catch both `invalid_argument` and `runtime_error` with two catch statements:

```
try {
    myInts = readIntegerFile(fileName);
} catch (const invalid_argument& e) {
    cerr << e.what() << endl;
    return 1;
} catch (const runtime_error& e) {
    cerr << e.what() << endl;
    return 2;
}
```

If an exception is thrown inside the `try` block, the compiler matches the type of the exception to the proper catch handler. So, if `readIntegerFile()` is unable to open the file and throws an `invalid_argument` object, it is caught by the first catch statement. If `readIntegerFile()` is unable to read the file properly and throws a `runtime_error`, then the second catch statement catches the exception.

Matching and const

The `const`-ness specified in the type of the exception you want to catch makes no difference for matching purposes. That is, this line matches any exception of type `runtime_error`:

```
    } catch (const runtime_error& e) {
```

The following line also matches any exception of type `runtime_error`:

```
    } catch (runtime_error& e) {
```

Matching Any Exception

You can write a catch line that matches any possible exception with the special syntax shown in the following example:

```
try {
    myInts = readIntegerFile(fileName);
} catch (...) {
    cerr << "Error reading or opening file " << fileName << endl;
    return 1;
}
```

The three dots are not a typo. They are a wildcard that matches any exception type. When you are calling poorly documented code, this technique can be useful to ensure that you catch all possible exceptions. However, in situations where you have complete information about the set of thrown exceptions, this technique is not recommended because it handles every exception type identically. It's better to match exception types explicitly and take appropriate, targeted actions.

A possible use of a catch block matching any exception is as a default catch handler. When an exception is thrown, a catch handler is looked up in the order that it appears in the code. The following example shows how you can write catch handlers that explicitly handle `invalid_argument` and `runtime_error` exceptions, and how to include a default catch handler for all other exceptions:

```
try {
    // Code that can throw exceptions
} catch (const invalid_argument& e) {
    // Handle invalid_argument exception
} catch (const runtime_error& e) {
    // Handle runtime_error exception
} catch (...) {
    // Handle all other exceptions
}
```

Uncaught Exceptions

If your program throws an exception that is not caught anywhere, the program terminates. Basically, there is a `try/catch` construct around the call to your `main()` function, which catches all unhandled exceptions, similar to the following:

```
try {
    main(argc, argv);
} catch (...) {
    // issue error message and terminate program
}
```

However, this behavior is not usually what you want. The point of exceptions is to give your program a chance to handle and correct undesirable or unexpected situations.

WARNING *You should catch and handle all possible exceptions thrown in your programs.*

It is also possible to change the behavior of your program if there is an uncaught exception. When the program encounters an uncaught exception, it calls the built-in `terminate()` function, which calls `abort()` from `<cstdlib>` to kill the program. You can set your own `terminate_handler` by calling `set_terminate()` with a pointer to a callback function that takes no arguments and returns no value. `terminate()`, `set_terminate()`, and `terminate_handler` are all declared in the `<exception>` header. The following code shows a high-level overview of how it works:

```
try {
    main(argc, argv);
} catch (...) {
    if (terminate_handler != nullptr) {
        terminate_handler();
    } else {
        terminate();
    }
}
// normal termination code
```

Before you get too excited about this feature, you should know that your callback function must still terminate the program. It can't just ignore the error. However, you can use it to print a helpful error message before exiting. Here is an example of a `main()` function that doesn't catch the exceptions thrown by `readIntegerFile()`. Instead, it sets the `terminate_handler` to a custom callback. This callback prints an error message and terminates the process by calling `exit()`. The `exit()` function accepts an integer which is returned back to the operating system, and which can be used to determine how a process exited.

```
void myTerminate()
{
    cout << "Uncaught exception!" << endl;
```

```

    exit(1);
}

int main()
{
    set_terminate(myTerminate);

    const string fileName = "IntegerFile.txt";
    vector<int> myInts = readIntegerFile(fileName);

    for (const auto& element : myInts) {
        cout << element << " ";
    }
    cout << endl;
    return 0;
}

```

Although not shown in this example, `set_terminate()` returns the old `terminate_handler` when it sets the new one. The `terminate_handler` applies program-wide, so it's considered good style to reset the old `terminate_handler` when you have completed the code that needed the new `terminate_handler`. In this case, the entire program needs the new `terminate_handler`, so there's no point in resetting it.

While it's important to know about `set_terminate()`, it's not a very effective exception-handling approach. It's recommended to try to catch and handle each exception individually in order to provide more precise error handling.

NOTE *In professionally written software, a `terminate_handler` is usually set up that creates a crash dump before terminating the process. This crash dump can then be loaded into a debugger to allow you to figure out what the uncaught exception was, and what caused it. However, how to write crash dumps is platform dependent, and therefore not further discussed in this book.*

noexcept

A function is allowed to throw any exception it likes. However, it is possible to mark a function with the `noexcept` keyword to state that it will not throw any exceptions. For example, here is the `readIntegerFile()` function from earlier, but this time marked as `noexcept`, so it is not allowed to throw any exceptions:

```
vector<int> readIntegerFile(string_view fileName) noexcept;
```

NOTE *A function marked with `noexcept` should not throw any exceptions.*

When a function marked as `noexcept` throws an exception anyway, C++ calls `terminate()` to terminate the application.

When you override a `virtual` method in a derived class, you are allowed to mark the overridden method as `noexcept`, even if the version in the base class is not `noexcept`. The opposite is not allowed.

Throw Lists (Deprecated/Removed)

Older versions of C++ allowed you to specify the exceptions a function or method intended to throw. This specification was called the *throw list* or the *exception specification*.

WARNING C++11 has deprecated, and C++17 has removed support for, exception specifications, except for `noexcept` and `throw()` which is equivalent to `noexcept`.

Because C++17 has officially removed support for exception specifications, this book does not use them, and does not explain them in detail. Even while exception specifications were still supported, they were used rarely. Still, this section briefly mentions them, so you will at least get an idea of what the syntax looked like in the unlikely event you encounter them in legacy code. Here is a simple example of the syntax, the `readIntegerFile()` function from earlier, with an exception specification:

```
vector<int> readIntegerFile(string_view fileName)
    throw(invalid_argument, runtime_error)
{
    // Remainder of the function is the same as before
}
```

If a function threw an exception that was not in its exception specification, the C++ runtime called `std::unexpected()` which by default called `std::terminate()` to terminate the application.

EXCEPTIONS AND POLYMORPHISM

As described earlier, you can actually throw any type of exception. However, classes are the most useful types of exceptions. In fact, exception classes are usually written in a hierarchy, so that you can employ polymorphism when you catch the exceptions.

The Standard Exception Hierarchy

You've already seen several exceptions from the C++ standard exception hierarchy: `exception`, `runtime_error`, and `invalid_argument`. Figure 14-3 shows the full hierarchy. For completeness, all standard exceptions are shown, including those thrown by parts of the Standard Library, which are discussed in later chapters.

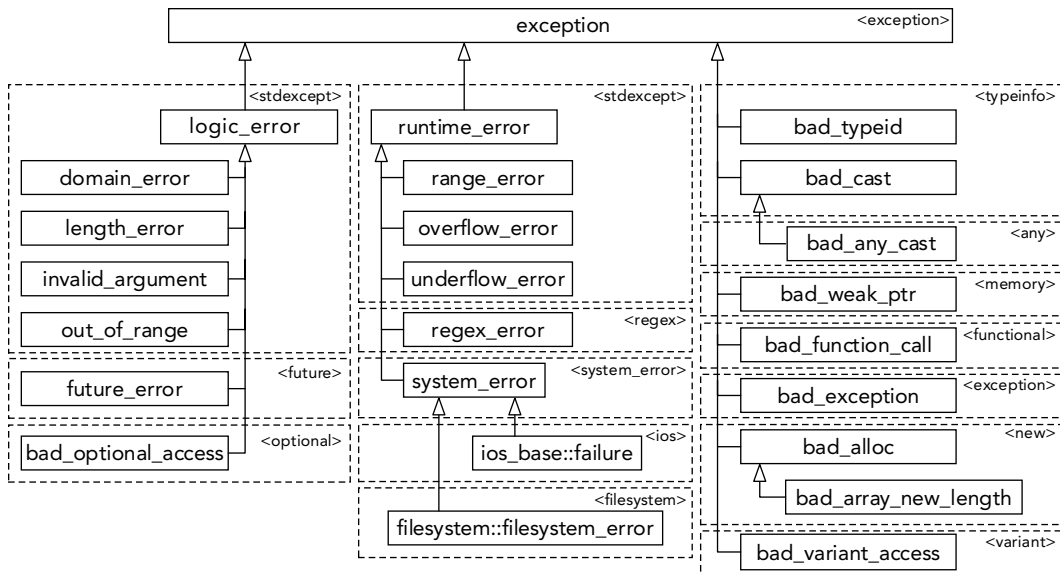

FIGURE 14-3

All of the exceptions thrown by the C++ Standard Library are objects of classes in this hierarchy. Each class in the hierarchy supports a `what()` method that returns a `const char*` string describing the exception. You can use this string in an error message.

Most of the exception classes (a notable exception is the base exception class) require you to set in the constructor the string that is returned by `what()`. That's why you have to specify a string in the constructors for `runtime_error` and `invalid_argument`. This has already been done in examples throughout this chapter. Here is another version of `readIntegerFile()` that includes the filename in the error message. Note also the use of the standard user-defined literal "s", introduced in Chapter 2, to interpret a string literal as an `std::string`.

```
vector<int> readIntegerFile(string_view fileName)
{
    ifstream inputStream(fileName.data());
    if (inputStream.fail()) {
        // We failed to open the file: throw an exception
        const string error = "Unable to open file "s + fileName.data();
        throw invalid_argument(error);
    }

    // Read the integers one-by-one and add them to a vector
    vector<int> integers;
    int temp;
    while (inputStream >> temp) {
```

```
        integers.push_back(temp);
    }

    if (!inputStream.eof()) {
        // We did not reach the end-of-file.
        // This means that some error occurred while reading the file.
        // Throw an exception.
        const string error = "Unable to read file "s + fileName.data();
        throw runtime_error(error);
    }

    return integers;
}

int main()
{
    // Code omitted
    try {
        myInts = readIntegerFile(fileName);
    } catch (const invalid_argument& e) {
        cerr << e.what() << endl;
        return 1;
    } catch (const runtime_error& e) {
        cerr << e.what() << endl;
        return 2;
    }
    // Code omitted
}
```

Catching Exceptions in a Class Hierarchy

A feature of exception hierarchies is that you can catch exceptions polymorphically. For example, if you look at the two catch statements in `main()` following the call to `readIntegerFile()`, you can see that they are identical except for the exception class that they handle. Conveniently, `invalid_argument` and `runtime_error` are both derived classes of `exception`, so you can replace the two catch statements with a single catch statement for class `exception`:

```
try {
    myInts = readIntegerFile(fileName);
} catch (const exception& e) {
    cerr << e.what() << endl;
    return 2;
}
```

The catch statement for an exception reference matches any derived classes of `exception`, including both `invalid_argument` and `runtime_error`. Note that the higher in the exception hierarchy you catch exceptions, the less specific your error handling can be. You should generally catch exceptions at as specific a level as possible.

WARNING *When you catch exceptions polymorphically, make sure to catch them by reference! If you catch exceptions by value, you can encounter slicing, in which case you lose information from the object. See Chapter 10 for details on slicing.*

When more than one `catch` clause is used, the `catch` clauses are matched in syntactic order as they appear in your code; the first one that matches, wins. If one `catch` is more inclusive than a later one, it will match first, and the more restrictive one, which comes later, will not be executed at all. Therefore, you should place your `catch` clauses from most restrictive to least restrictive in order. For example, suppose that you want to catch `invalid_argument` from `readIntegerFile()` explicitly, but you also want to leave the generic exception match for any other exceptions. The correct way to do so is like this:

```
try {
    myInts = readIntegerFile(fileName);
} catch (const invalid_argument& e) { // List the derived class first.
    // Take some special action for invalid filenames.
} catch (const exception& e) { // Now list exception
    cerr << e.what() << endl;
    return 1;
}
```

The first `catch` statement catches `invalid_argument` exceptions, and the second catches any other exceptions of type `exception`. However, if you reverse the order of the `catch` statements, you don't get the same result:

```
try {
    myInts = readIntegerFile(fileName);
} catch (const exception& e) { // BUG: catching base class first!
    cerr << e.what() << endl;
    return 1;
} catch (const invalid_argument& e) {
    // Take some special action for invalid filenames.
}
```

With this order, any exception of a class that derives from `exception` is caught by the first `catch` statement; the second will never be reached. Some compilers issue a warning in this case, but you shouldn't count on it.

Writing Your Own Exception Classes

There are two advantages to writing your own exception classes.

1. The number of exceptions in the C++ Standard Library is limited. Instead of using an exception class with a generic name, such as `runtime_error`, you can create classes with names that are more meaningful for the particular errors in your program.
2. You can add your own information to these exceptions. The exceptions in the standard hierarchy allow you to set only an error string. You might want to pass different information in the exception.

It's recommended that all the exception classes that you write inherit directly or indirectly from the standard `exception` class. If everyone on your project follows that rule, you know that every exception in the program will be derived from `exception` (assuming that you aren't using third-party libraries that break this rule). This guideline makes exception handling via polymorphism significantly easier.

For example, `invalid_argument` and `runtime_error` don't do a very good job of capturing the file opening and reading errors in `readIntegerFile()`. You can define your own error hierarchy for file errors, starting with a generic `FileError` class:

```
class FileError : public exception
{
public:
    FileError(string_view fileName) : mFileName(fileName) {}

    virtual const char* what() const noexcept override {
        return mMessage.c_str();
    }

    string_view getFileName() const noexcept { return mFileName; }

protected:
    void setMessage(string_view message) { mMessage = message; }

private:
    string mFileName;
    string mMessage;
};
```

As a good programming citizen, you should make `FileError` a part of the standard exception hierarchy. It seems appropriate to integrate it as a child of `exception`. When you derive from `exception`, you can override the `what()` method, which has the prototype shown and which must return a `const char*` string that is valid until the object is destroyed. In the case of `FileError`, this string comes from the `mMessage` data member. Derived classes of `FileError` can set the message using the protected `setMessage()` method. The generic `FileError` class also contains a filename, and a public accessor for that filename.

The first exceptional situation in `readIntegerFile()` occurs if the file cannot be opened. Thus, you might want to write a `FileOpenError` exception derived from `FileError`:

```
class FileOpenError : public FileError
{
public:
    FileOpenError(string_view fileName) : FileError(fileName)
    {
        setMessage("Unable to open "s + fileName.data());
    }
};
```

The `FileOpenError` exception changes the `mMessage` string to represent the file-opening error.

The second exceptional situation in `readIntegerFile()` occurs if the file cannot be read properly. It might be useful for this exception to contain the line number of the error in the file, as well as

the filename in the error message string returned from `what()`. Here is a `FileReadError` exception derived from `FileError`:

```
class FileReadError : public FileError
{
public:
    FileReadError(string_view fileName, size_t lineNumber)
        : FileError(fileName), mLineNumber(lineNumber)
    {
        ostringstream ostr;
        ostr << "Error reading " << fileName << " at line "
            << lineNumber;
        setMessage(ostr.str());
    }

    size_t getLineNumber() const noexcept { return mLineNumber; }

private:
    size_t mLineNumber;
};
```

Of course, in order to set the line number properly, you need to modify your `readIntegerFile()` function to track the number of lines read instead of just reading integers directly. Here is a new `readIntegerFile()` function that uses the new exceptions:

```
vector<int> readIntegerFile(string_view fileName)
{
    ifstream inputStream(fileName.data());
    if (inputStream.fail()) {
        // We failed to open the file: throw an exception
        throw FileOpenError(fileName);
    }

    vector<int> integers;
    size_t lineNumber = 0;
    while (!inputStream.eof()) {
        // Read one line from the file
        string line;
        getline(inputStream, line);
        ++lineNumber;

        // Create a string stream out of the line
        istringstream lineStream(line);

        // Read the integers one-by-one and add them to a vector
        int temp;
        while (lineStream >> temp) {
            integers.push_back(temp);
        }

        if (!lineStream.eof()) {
            // We did not reach the end of the string stream.
            // This means that some error occurred while reading this line.
            // Throw an exception.
        }
    }
}
```

```
        throw FileReadError(fileName, lineNumber);
    }
}

return integers;
}
```

Now, code that calls `readIntegerFile()` can use polymorphism to catch exceptions of type `FileError` like this:

```
try {
    myInts = readIntegerFile(fileName);
} catch (const FileError& e) {
    cerr << e.what() << endl;
    return 1;
}
```

There is one trick to writing classes whose objects will be used as exceptions. When a piece of code throws an exception, the object or value thrown is moved or copied, using either the move constructor or copy constructor. Thus, if you write a class whose objects will be thrown as exceptions, you must make sure those objects are copyable and/or moveable. This means that if you have dynamically allocated memory, your class must have a destructor, but also a copy constructor and copy assignment operator, and/or a move constructor and move assignment operator, see Chapter 9.

WARNING *Objects thrown as exceptions are always moved or copied at least once.*

It is possible for exceptions to be copied more than once, but only if you catch the exception by value instead of by reference.

NOTE *Catch exception objects by reference (preferably `const` reference) to avoid unnecessary copying.*

Nested Exceptions

It could happen that during handling of a first exception, a second exceptional situation is triggered which requires a second exception to be thrown. Unfortunately, when you throw the second exception, all information about the first exception that you are currently trying to handle will be lost. The solution provided by C++ for this problem is called *nested exceptions*, which allow you to nest a caught exception in the context of a new exception. This can also be useful if you call a function in a third-party library that throws an exception of a certain type, `A`, but you only want exceptions of another type, `B`, in your code. In such a case, you catch all exceptions from the library, and nest them in an exception of type `B`.

You use `std::throw_with_nested()` to throw an exception with another exception nested inside it. A catch handler for the second exception can use a `dynamic_cast()` to get access to the nested exception representing the first exception. The following example demonstrates the use of nested exceptions. This example defines a `MyException` class, which derives from `exception` and accepts a string in its constructor.

```
class MyException : public std::exception
{
public:
    MyException(string_view message) : mMessage(message) {}
    virtual const char* what() const noexcept override {
        return mMessage.c_str();
    }
private:
    string mMessage;
};
```

When you are handling a first exception and you need to throw a second exception with the first one nested inside it, you need to use the `std::throw_with_nested()` function. The following `doSomething()` function throws a `runtime_error` that is immediately caught in the catch handler. The catch handler writes a message and then uses the `throw_with_nested()` function to throw a second exception that has the first one nested inside it. Note that nesting the exception happens automatically. The predefined `__func__` variable is discussed in Chapter 1.

```
void doSomething()
{
    try {
        throw runtime_error("Throwing a runtime_error exception");
    } catch (const runtime_error& e) {
        cout << __func__ << " caught a runtime_error" << endl;
        cout << __func__ << " throwing MyException" << endl;
        throw_with_nested(
            MyException("MyException with nested runtime_error"));
    }
}
```

The following `main()` function demonstrates how to handle the exception with a nested exception. The code calls the `doSomething()` function and has one catch handler for exceptions of type `MyException`. When it catches such an exception, it writes a message, and then uses a `dynamic_cast()` to get access to the nested exception. If there is no nested exception inside, the result will be a null pointer. If there is a nested exception inside, the `rethrow_nested()` method on the nested exception is called. This will cause the nested exception to be rethrown, which you can then catch in another `try/catch` block.

```
int main()
{
    try {
        doSomething();
    } catch (const MyException& e) {
        cout << __func__ << " caught MyException: " << e.what() << endl;
    }
}
```



```

    const auto* pNested = dynamic_cast<const nested_exception*>(&e);
    if (pNested) {
        try {
            pNested->rethrow_nested();
        } catch (const runtime_error& e) {
            // Handle nested exception
            cout << " Nested exception: " << e.what() << endl;
        }
    }
}
return 0;
}

```

The output should be as follows:

```

doSomething caught a runtime_error
doSomething throwing MyException
main caught MyException: MyException with nested runtime_error
Nested exception: Throwing a runtime_error exception

```

The preceding `main()` function uses a `dynamic_cast()` to check for the nested exception. Because you often have to perform this `dynamic_cast()` if you want to check for a nested exception, the standard provides a small helper function called `std::rethrow_if_nested()` that does it for you. This helper function can be used as follows:

```

int main()
{
    try {
        doSomething();
    } catch (const MyException& e) {
        cout << __func__ << " caught MyException: " << e.what() << endl;
        try {
            rethrow_if_nested(e);
        } catch (const runtime_error& e) {
            // Handle nested exception
            cout << " Nested exception: " << e.what() << endl;
        }
    }
    return 0;
}

```

RETHROWING EXCEPTIONS

The `throw` keyword can also be used to rethrow the current exception, as in the following example:

```

void g() { throw invalid_argument("Some exception"); }

void f()
{
    try {
        g();
    } catch (const invalid_argument& e) {
        cout << "caught in f: " << e.what() << endl;
        throw; // rethrow
    }
}

```

```

    }
}

int main()
{
    try {
        f();
    } catch (const invalid_argument& e) {
        cout << "caught in main: " << e.what() << endl;
    }
    return 0;
}

```

This example produces the following output:

```

caught in f: Some exception
caught in main: Some exception

```

You might think you could also rethrow an exception using something like a “`throw e;`” statement; however, that’s wrong, because it can cause slicing of your exception object. For example, suppose `f()` is modified to catch `std::exceptions`, and `main()` is modified to catch both `exception` and `invalid_argument` exceptions:

```

void g() { throw invalid_argument("Some exception"); }

void f()
{
    try {
        g();
    } catch (const exception& e) {
        cout << "caught in f: " << e.what() << endl;
        throw; // rethrow
    }
}

int main()
{
    try {
        f();
    } catch (const invalid_argument& e) {
        cout << "invalid_argument caught in main: " << e.what() << endl;
    } catch (const exception& e) {
        cout << "exception caught in main: " << e.what() << endl;
    }
    return 0;
}

```

Remember that `invalid_argument` derives from `exception`. The output of this code is as you would expect:

```

caught in f: Some exception
invalid_argument caught in main: Some exception

```

However, try replacing the “`throw e;`” line in `f()` with:

```

throw e;

```

The output then is as follows:

```
caught in f: Some exception
exception caught in main: Some exception
```

Now `main()` seems to be catching an exception object, instead of an `invalid_argument` object. That's because the `"throw e;"` statement causes slicing, reducing the `invalid_argument` to an exception.

WARNING Always use `"throw;"` to rethrow an exception. Never do something like `"throw e;"` to rethrow `e!`

STACK UNWINDING AND CLEANUP

When a piece of code throws an exception, it searches for a catch handler on the stack. This catch handler could be zero or more function calls up the stack of execution. When one is found, the stack is stripped back to the stack level that defines the catch handler by unwinding all intermediate stack frames. *Stack unwinding* means that the destructors for all locally scoped names are called, and all code remaining in each function past the current point of execution is skipped.

However, in stack unwinding, pointer variables are not freed, and other cleanup is not performed. This behavior can present problems, as the following code demonstrates:

```
void funcOne();
void funcTwo();

int main()
{
    try {
        funcOne();
    } catch (const exception& e) {
        cerr << "Exception caught!" << endl;
        return 1;
    }
    return 0;
}

void funcOne()
{
    string str1;
    string* str2 = new string();
    funcTwo();
    delete str2;
}

void funcTwo()
{
    ifstream fileStream;
```

```

        fileStream.open("filename");
        throw exception();
        fileStream.close();
    }

```

When `funcTwo()` throws an exception, the closest exception handler is in `main()`. Control then jumps immediately from this line in `funcTwo()`,

```
    throw exception();
```

to this line in `main()`:

```
    cerr << "Exception caught!" << endl;
```

In `funcTwo()`, control remains at the line that threw the exception, so this subsequent line never gets a chance to run:

```
    fileStream.close();
```

However, luckily for you, the `ifstream` destructor is called because `fileStream` is a local variable on the stack. The `ifstream` destructor closes the file for you, so there is no resource leak here. If you had dynamically allocated `fileStream`, it would not be destroyed, and the file would not be closed.

In `funcOne()`, control is at the call to `funcTwo()`, so this subsequent line never gets a chance to run:

```
    delete str2;
```

In this case, there really is a memory leak. Stack unwinding does not automatically call `delete` on `str2` for you. However, `str1` is destroyed properly because it is a local variable on the stack. Stack unwinding destroys all local variables correctly.

WARNING *Careless exception handling can lead to memory and resource leaks.*

This is one reason why you should never mix older C models of allocation (even if you are calling new so it looks like C++) with modern programming methodologies like exceptions. In C++, this situation should be handled by using stack-based allocations, or if that is not possible, by one of the techniques discussed in the following two sections.

Use Smart Pointers

If stack-based allocation is not possible, then use smart pointers. They allow you to write code that automatically prevents memory or resource leaks with exception handling. Whenever a smart pointer object is destroyed, it frees the underlying resource. Here is an example of the previous `funcOne()` function but using the `unique_ptr` smart pointer, defined in `<memory>`, and introduced in Chapter 1:

```

void funcOne()
{
    string str1;
    auto str2 = make_unique<string>("hello");
    funcTwo();
}

```

The `str2` pointer will automatically be deleted when you return from `funcOne()` or when an exception is thrown.

Of course, you should only allocate something dynamically if you have a good reason to do so. For example, in the previous `funcOne()` function, there is no good reason to make `str2` a dynamically allocated string. It should just be a stack-based `string` variable. It's merely shown here as a compact example of the consequences of throwing exceptions.

NOTE *With smart pointers, or other RAII objects (see Chapter 28), you never have to remember to free the underlying resource: the destructor of the RAII object does it for you, whether you leave the function via an exception or leave the function normally.*

Catch, Cleanup, and Rethrow

Another technique for avoiding memory and resource leaks is for each function to catch any possible exceptions, perform necessary cleanup work, and rethrow the exception for the function higher up the stack to handle. Here is a revised `funcOne()` with this technique:

```
void funcOne()
{
    string str1;
    string* str2 = new string();
    try {
        funcTwo();
    } catch (...) {
        delete str2;
        throw; // Rethrow the exception.
    }
    delete str2;
}
```

This function wraps the call to `funcTwo()` with an exception handler that performs the cleanup (calls `delete` on `str2`) and then rethrows the exception. The keyword `throw` by itself rethrows whatever exception was caught most recently. Note that the `catch` statement uses the `...` syntax to catch any exception.

This method works fine, but is messy. In particular, note that there are now two identical lines that call `delete` on `str2`: one to handle the exception and one if the function exits normally.

WARNING *The preferred solution is to use smart pointers or other RAII classes instead of the catch, cleanup, and rethrow technique.*

COMMON ERROR-HANDLING ISSUES

Whether or not you use exceptions in your programs is up to you and your colleagues. However, you are strongly encouraged to formalize an error-handling plan for your programs, regardless of your use of exceptions. If you use exceptions, it is generally easier to come up with a unified error-handling scheme, but it is not impossible without exceptions. The most important aspect of a good plan is uniformity of error handling throughout all the modules of the program. Make sure that every programmer on the project understands and follows the error-handling rules.

This section discusses the most common error-handling issues in the context of exceptions, but the issues are also relevant to programs that do not use exceptions.

Memory Allocation Errors

Despite the fact that all the examples so far in this book have ignored the possibility, memory allocation can fail. On current 64-bit platforms, this will almost never happen, but on mobile or legacy systems, memory allocation can fail. On such systems, you must account for memory allocation failures. C++ provides several different ways to handle memory errors.

The default behaviors of `new` and `new[]` are to throw an exception of type `bad_alloc`, defined in the `<new>` header file, if they cannot allocate memory. Your code could catch these exceptions and handle them appropriately.

It's not realistic to wrap all your calls to `new` and `new[]` with a `try/catch`, but at least you should do so when you are trying to allocate a big block of memory. The following example demonstrates how to catch memory allocation exceptions:

```
int* ptr = nullptr;
size_t integerCount = numeric_limits<size_t>::max();
try {
    ptr = new int[integerCount];
} catch (const bad_alloc& e) {
    cerr << __FILE__ << "(" << __LINE__
        << "): Unable to allocate memory: " << e.what() << endl;
    // Handle memory allocation failure.
    return;
}
// Proceed with function that assumes memory has been allocated.
```

Note that this code uses the predefined preprocessor symbols `__FILE__` and `__LINE__`, which are replaced with the name of the file and the current line number. This makes debugging easier.

NOTE *This example prints an error message to `cerr`. This assumes your program is running with a console. In GUI applications, you usually don't have a console, in which case you need to show the error in a GUI-specific way to the user.*

You could, of course, bulk handle many possible new failures with a single `try/catch` block at a higher point in the program, if that works for your program.

Another point to consider is that logging an error might try to allocate memory. If `new` fails, there might not be enough memory left even to log the error message.

Non-throwing new

If you don't like exceptions, you can revert to the old C model in which memory allocation routines return a null pointer if they cannot allocate memory. C++ provides *nothrow* versions of `new` and `new[]`, which return `nullptr` instead of throwing an exception if they fail to allocate memory. This is done by using the syntax `new(nothrow)` instead of `new`, as shown in the following example:

```
int* ptr = new(nothrow) int[integerCount];
if (ptr == nullptr) {
    cerr << __FILE__ << " (" << __LINE__
        << "): Unable to allocate memory!" << endl;
    // Handle memory allocation failure.
    return;
}
// Proceed with function that assumes memory has been allocated.
```

The syntax is a little strange: you really do write “nothrow” as if it's an argument to `new` (which it is).

Customizing Memory Allocation Failure Behavior

C++ allows you to specify a *new handler* callback function. By default, there is no new handler, so `new` and `new[]` just throw `bad_alloc` exceptions. However, if there is a new handler, the memory allocation routine calls the new handler upon memory allocation failure instead of throwing an exception. If the new handler returns, the memory allocation routines attempt to allocate memory again, calling the new handler again if they fail. This cycle could become an infinite loop unless your new handler changes the situation with one of three alternatives. Practically speaking, some of the options are better than others. Here is the list with commentary:

- **Make more memory available.** One trick to expose space is to allocate a large chunk of memory at program start-up, and then to free it in the new handler. A practical example is when you hit an allocation error and you need to save the user state so no work gets lost. The key is to allocate a block of memory at program start-up large enough to allow a complete document save operation. When the new handler is triggered, you free this block, save the document, restart the application, and let it reload the saved document.
- **Throw an exception.** The C++ standard mandates that if you throw an exception from your new handler, it must be a `bad_alloc` exception, or an exception derived from `bad_alloc`. For example:
 - You could write and throw a `document_recovery_alloc` exception, inheriting from `bad_alloc`. This exception can be caught somewhere in your application to trigger the document save operation and restart of the application.

- You could write and throw a `please_terminate_me` exception, deriving from `bad_alloc`. In your top-level function—for example, `main()`—you catch this exception and handle it by returning from the top-level function. It's recommended to terminate a program by returning from the top-level function, instead of by calling `exit()`.
- **Set a different new handler.** Theoretically, you could have a series of new handlers, each of which tries to create memory and sets a different new handler if it fails. However, such a scenario is usually more complicated than useful.

If you don't do one of these three things in your new handler, any memory allocation failure will cause an infinite loop.

If there are some memory allocations that can fail but you don't want the new handler to be called, you can simply set the new handler back to its default of `nullptr` temporarily before calling `new` in those cases.

You set the new handler with a call to `set_new_handler()`, declared in the `<new>` header file. Here is an example of a new handler that logs an error message and throws an exception:

```
class please_terminate_me : public bad_alloc { };

void myNewHandler()
{
    cerr << "Unable to allocate memory." << endl;
    throw please_terminate_me();
}
```

The new handler must take no arguments and return no value. This new handler throws a `please_terminate_me` exception, as suggested in the second bullet in the preceding list.

You can set this new handler like this:

```
int main()
{
    try {
        // Set the new new_handler and save the old one.
        new_handler oldHandler = set_new_handler(myNewHandler);

        // Generate allocation error
        size_t numInts = numeric_limits<size_t>::max();
        int* ptr = new int[numInts];

        // Reset the old new_handler
        set_new_handler(oldHandler);
    } catch (const please_terminate_me&) {
        cerr << __FILE__ << "(" << __LINE__
            << "): Terminating program." << endl;
        return 1;
    }
    return 0;
}
```

Note that `new_handler` is a typedef for the type of function pointer that `set_new_handler()` takes.

Errors in Constructors

Before C++ programmers discover exceptions, they are often stymied by error handling and constructors. What if a constructor fails to construct the object properly? Constructors don't have a return value, so the standard pre-exception error-handling mechanism doesn't work. Without exceptions, the best you can do is to set a flag in the object specifying that it is not constructed properly. You can provide a method, with a name like `checkConstructionStatus()`, which returns the value of that flag, and hope that clients remember to call this method on the object after constructing it.

Exceptions provide a much better solution. You can throw an exception from a constructor, even though you can't return a value. With exceptions, you can easily tell clients whether or not construction of an object succeeded. However, there is one major problem: if an exception leaves a constructor, the destructor for that object will never be called! Thus, you must be careful to clean up any resources and free any allocated memory in constructors before allowing exceptions to leave the constructor. This problem is the same as in any other function, but it is subtler in constructors because you're accustomed to letting the destructors take care of the memory deallocation and resource freeing.

This section describes a `Matrix` class template as an example in which the constructor correctly handles exceptions. Note that this example is using a raw pointer called `mMatrix` to demonstrate the problems. In production-quality code, you should avoid using raw pointers, for example, by using a Standard Library container! The definition of the `Matrix` class template looks like this:

```
template <typename T>
class Matrix
{
public:
    Matrix(size_t width, size_t height);
    virtual ~Matrix();
private:
    void cleanup();

    size_t mWidth = 0;
    size_t mHeight = 0;
    T** mMatrix = nullptr;
};
```

The implementation of the `Matrix` class is as follows. Note that the first call to `new` is not protected with a `try/catch` block. It doesn't matter if the first `new` throws an exception because the constructor hasn't allocated anything else yet that needs freeing. If any of the subsequent `new` calls throws an exception, though, the constructor must clean up all of the memory already allocated. However, it doesn't know what exceptions the `T` constructors themselves might throw, so it catches any exceptions via `...` and then nests the caught exception inside a `bad_alloc` exception. Note that the array allocated with the first call to `new` is zero-initialized using the `{}` syntax, that is, each element will be `nullptr`. This makes the `cleanup()` method easier, because it is allowed to call `delete` on a `nullptr`.

```
template <typename T>
Matrix<T>::Matrix(size_t width, size_t height)
{
    mMatrix = new T*[width] {};    // Array is zero-initialized!
```

```

// Don't initialize the mWidth and mHeight members in the ctor-
// initializer. These should only be initialized when the above
// mMatrix allocation succeeds!
mWidth = width;
mHeight = height;

try {
    for (size_t i = 0; i < width; ++i) {
        mMatrix[i] = new T[height];
    }
} catch (...) {
    std::cerr << "Exception caught in constructor, cleaning up..."
               << std::endl;
    cleanup();
    // Nest any caught exception inside a bad_alloc exception.
    std::throw_with_nested(std::bad_alloc());
}
}

template <typename T>
Matrix<T>::~Matrix()
{
    cleanup();
}

template <typename T>
void Matrix<T>::cleanup()
{
    for (size_t i = 0; i < mWidth; ++i)
        delete[] mMatrix[i];
    delete[] mMatrix;
    mMatrix = nullptr;
    mWidth = mHeight = 0;
}

```

WARNING *Remember, if an exception leaves a constructor, the destructor for that object will never be called!*

The Matrix class template can be tested as follows:

```

class Element
{
    // Kept to a bare minimum, but in practice, this Element class
    // could throw exceptions in its constructor.
private:
    int mValue;
};

int main()
{
    Matrix<Element> m(10, 10);
    return 0;
}

```

You might be wondering what happens when you add inheritance into the mix. Base class constructors run before derived class constructors. If a derived class constructor throws an exception, C++ will execute the destructor of the fully constructed base class.

NOTE *C++ guarantees that it will run the destructor for any fully constructed “subobjects.” Therefore, any constructor that completes without an exception will cause the corresponding destructor to be run.*

Function-Try-Blocks for Constructors

The exception mechanism, as discussed up to now in this chapter, is perfect for handling exceptions within functions. But how should you handle exceptions thrown from inside a ctor-initializer of a constructor? This section explains a feature called *function-try-blocks*, which are capable of catching those exceptions. Function-try-blocks work for normal functions as well as for constructors. This section focuses on the use with constructors. Most C++ programmers, even experienced C++ programmers, don’t know of the existence of this feature, even though it was introduced a long time ago.

The following piece of pseudo-code shows the basic syntax for a function-try-block for a constructor:

```
MyClass::MyClass()
try
    : <ctor-initializer>
{
    /* ... constructor body ... */
}
catch (const exception& e)
{
    /* ... */
}
```

As you can see, the `try` keyword should be right before the start of the ctor-initializer. The `catch` statements should be after the closing brace for the constructor, actually putting them outside the constructor body. There are a number of restrictions and guidelines that you should keep in mind when using function-try-blocks with constructors:

- The `catch` statements catch any exception thrown either directly or indirectly by the ctor-initializer or by the constructor body.
- The `catch` statements have to rethrow the current exception or throw a new exception. If a `catch` statement doesn’t do this, the runtime automatically rethrows the current exception.
- The `catch` statements can access arguments passed to the constructor.
- When a `catch` statement catches an exception in a function-try-block, all fully constructed base classes and members of the object are destroyed before execution of the `catch` statement starts.

- Inside `catch` statements you should not access member variables that are objects because these are destroyed prior to executing the `catch` statements (see the previous bullet). However, if your object contains non-class data members—for example, raw pointers—you can access them if they have been initialized before the exception was thrown. If you have such naked resources, you have to take care of them by freeing them in the `catch` statements, as the following example demonstrates.
- The `catch` statements in a function-try-block cannot use the `return` keyword to return a value from the function enclosed by it. This is not relevant for constructors because they do not return anything.

Based on this list of limitations, function-try-blocks for constructors are useful only in a limited number of situations:

- To convert an exception thrown by the `ctor-initializer` to another exception.
- To log a message to a log file.
- To free naked resources that have been allocated in the `ctor-initializer` prior to the exception being thrown.

The following example demonstrates how to use function-try-blocks. The code defines a class called `SubObject`. It has only one constructor, which throws an exception of type `runtime_error`.

```
class SubObject
{
public:
    SubObject(int i);
};

SubObject::SubObject(int i)
{
    throw std::runtime_error("Exception by SubObject ctor");
}
```

The `MyClass` class has a member variable of type `int*` and another one of type `SubObject`:

```
class MyClass
{
public:
    MyClass();
private:
    int* mData = nullptr;
    SubObject mSubObject;
};
```

The `SubObject` class does not have a default constructor. This means that you need to initialize `mSubObject` in the `MyClass` `ctor-initializer`. The constructor of `MyClass` uses a function-try-block to catch exceptions thrown in its `ctor-initializer`:

```
MyClass::MyClass()
try
    : mData(new int [42]{ 1, 2, 3 }), mSubObject(42)
```

```
{
    /* ... constructor body ... */
}
catch (const std::exception& e)
{
    // Cleanup memory.
    delete[] mData;
    mData = nullptr;
    cout << "function-try-block caught: '" << e.what() << "'" << endl;
}
}
```

Remember that `catch` statements in a function-try-block for a constructor have to either rethrow the current exception, or throw a new exception. The preceding `catch` statement does not throw anything, so the C++ runtime automatically rethrows the current exception. Following is a simple function that uses the preceding class:

```
int main()
{
    try {
        MyClass m;
    } catch (const std::exception& e) {
        cout << "main() caught: '" << e.what() << "'" << endl;
    }
    return 0;
}
```

The output of the preceding example is as follows:

```
function-try-block caught: 'Exception by SubObject ctor'
main() caught: 'Exception by SubObject ctor'
```

Note that the code in the example can be dangerous. Depending on the order of initialization, it could be that `mData` contains garbage when entering the `catch` statement. Deleting such a garbage pointer causes undefined behavior. The solution in this example's case is to use a smart pointer for the `mData` member, for example `std::unique_ptr`, and to remove the function-try-block. Therefore:

WARNING *Avoid using function-try-blocks!*

Function-try-blocks are usually only necessary when you have naked resources as data members. Naked resources should be avoided by using RAII classes such as `std::unique_ptr`. RAII classes are discussed in Chapter 28.

Function-try-blocks are not limited to constructors. They can be used with ordinary functions as well. However, for normal functions, there is no useful reason to use function-try-blocks because they can just as easily be converted to a simple `try/catch` block inside the function body. One notable difference when using a function-try-block on a normal function compared to a constructor

is that rethrowing the current exception or throwing a new exception in the `catch` statements is not required and the C++ runtime will not automatically rethrow the exception.

Errors in Destructors

You should handle all error conditions that arise in destructors in the destructors themselves. You should not let any exceptions be thrown from destructors, for a couple of reasons:

1. Destructors are implicitly marked as `noexcept`, unless they are marked with `noexcept(false)`² or the class has any subobjects whose destructor is `noexcept(false)`. If you throw an exception from a `noexcept` destructor, the C++ runtime calls `std::terminate()` to terminate the application.
2. Destructors can run while there is another pending exception, in the process of stack unwinding. If you throw an exception from the destructor in the middle of stack unwinding, the C++ runtime calls `std::terminate()` to terminate the application. For the brave and curious, C++ does provide the ability to determine, in a destructor, whether you are executing as a result of a normal function exit or delete call, or because of stack unwinding. The function `uncaught_exceptions()`, declared in the `<exception>` header file, returns the number of uncaught exceptions, that is, exceptions that have been thrown but that have not reached a matching `catch` yet. If the result of `uncaught_exceptions()` is greater than zero, then you are in the middle of stack unwinding. However, correct use of this function is complicated, messy, and should be avoided. Note that before C++17, the function was called `uncaught_exception()` (singular), and returned a `bool` that was `true` if you were in the middle of stack unwinding.
3. What action would clients take? Clients don't call destructors explicitly: they call `delete`, which calls the destructor. If you throw an exception from the destructor, what is a client supposed to do? It can't call `delete` on the object again, and it shouldn't call the destructor explicitly. There is no reasonable action the client can take, so there is no reason to burden that code with exception handling.
4. The destructor is your one chance to free memory and resources used in the object. If you waste your chance by exiting the function early due to an exception, you will never be able to go back and free the memory or resources.

WARNING *Be careful to catch in a destructor any exceptions that can be thrown by calls you make from the destructor.*

²The `noexcept(expression)` specifier is not discussed in detail in this book. Suffice to know that `noexcept` equals `noexcept(true)`, and that `noexcept(false)` is the opposite of `noexcept(true)`; that is, a method marked with `noexcept(false)` can throw any exception it wants.

PUTTING IT ALL TOGETHER

Now that you've learned about error handling and exceptions, let's see it all coming together in a bigger example, a `GameBoard` class. This `GameBoard` class is based on the `GameBoard` class from Chapter 12. The implementation in Chapter 12 using a `vector` of `vectors` is the recommended implementation because even when an exception is thrown, the code is not leaking any memory due to the use of Standard Library containers. To be able to demonstrate handling memory allocation errors, the following version is adapted to use a raw pointer, `GamePiece** mCells`. First, here is the definition of the class without any exceptions:

```
class GamePiece {};

class GameBoard
{
public:
    // general-purpose GameBoard allows user to specify its dimensions
    explicit GameBoard(size_t width = kDefaultWidth,
                      size_t height = kDefaultHeight);
    GameBoard(const GameBoard& src); // Copy constructor
    virtual ~GameBoard();
    GameBoard& operator=(const GameBoard& rhs); // Assignment operator

    GamePiece& at(size_t x, size_t y);
    const GamePiece& at(size_t x, size_t y) const;

    size_t getHeight() const { return mHeight; }
    size_t getWidth() const { return mWidth; }

    static const size_t kDefaultWidth = 100;
    static const size_t kDefaultHeight = 100;

    friend void swap(GameBoard& first, GameBoard& second) noexcept;
private:
    // Objects dynamically allocate space for the game pieces.
    GamePiece** mCells = nullptr;
    size_t mWidth = 0, mHeight = 0;
};
```

Note that you could also add move semantics to this `GameBoard` class. That would require adding a move constructor and move assignment operator, which both have to be `noexcept`. See Chapter 9 for details on move semantics.

Here are the implementations without any exceptions:

```
GameBoard::GameBoard(size_t width, size_t height)
    : mWidth(width), mHeight(height)
{
    mCells = new GamePiece*[mWidth];
    for (size_t i = 0; i < mWidth; i++) {
        mCells[i] = new GamePiece[mHeight];
    }
}
```

```

GameBoard::GameBoard(const GameBoard& src)
    : GameBoard(src.mWidth, src.mHeight)
{
    // The ctor-initializer of this constructor delegates first to the
    // non-copy constructor to allocate the proper amount of memory.

    // The next step is to copy the data.
    for (size_t i = 0; i < mWidth; i++) {
        for (size_t j = 0; j < mHeight; j++) {
            mCells[i][j] = src.mCells[i][j];
        }
    }
}

GameBoard::~GameBoard()
{
    for (size_t i = 0; i < mWidth; i++) {
        delete[] mCells[i];
    }
    delete[] mCells;
    mCells = nullptr;
    mWidth = mHeight = 0;
}

void swap(GameBoard& first, GameBoard& second) noexcept
{
    using std::swap;

    swap(first.mWidth, second.mWidth);
    swap(first.mHeight, second.mHeight);
    swap(first.mCells, second.mCells);
}

GameBoard& GameBoard::operator=(const GameBoard& rhs)
{
    // Check for self-assignment
    if (this == &rhs) {
        return *this;
    }

    // Copy-and-swap idiom
    GameBoard temp(rhs); // Do all the work in a temporary instance
    swap(*this, temp); // Commit the work with only non-throwing operations
    return *this;
}

const GamePiece& GameBoard::at(size_t x, size_t y) const
{
    return mCells[x][y];
}

GamePiece& GameBoard::at(size_t x, size_t y)
{
    return const_cast<GamePiece&>(std::as_const(*this).at(x, y));
}

```

Now, let's retrofit the preceding class to include error handling and exceptions. The constructors and `operator=` can all throw `bad_alloc` because they perform memory allocation directly or indirectly. The destructor, `cleanup()`, `getHeight()`, `getWidth()`, and `swap()` throw no exceptions. The `verifyCoordinate()` and `at()` methods throw `out_of_range` if the caller supplies an invalid coordinate. Here is the retrofitted class definition:

```
class GamePiece {};
```

```
class GameBoard
{
public:
    explicit GameBoard(size_t width = kDefaultWidth,
        size_t height = kDefaultHeight);
    GameBoard(const GameBoard& src);
    virtual ~GameBoard() noexcept;
    GameBoard& operator=(const GameBoard& rhs); // Assignment operator

    GamePiece& at(size_t x, size_t y);
    const GamePiece& at(size_t x, size_t y) const;

    size_t getHeight() const noexcept { return mHeight; }
    size_t getWidth() const noexcept { return mWidth; }

    static const size_t kDefaultWidth = 100;
    static const size_t kDefaultHeight = 100;

    friend void swap(GameBoard& first, GameBoard& second) noexcept;
private:
    void cleanup() noexcept;
    void verifyCoordinate(size_t x, size_t y) const;

    GamePiece** mCells = nullptr;
    size_t mWidth = 0, mHeight = 0;
};
```

Here are the implementations with exception handling:

```
GameBoard::GameBoard(size_t width, size_t height)
{
    mCells = new GamePiece*[width] {}; // Array is zero-initialized!

    // Don't initialize the mWidth and mHeight members in the ctor-
    // initializer. These should only be initialized when the above
    // mCells allocation succeeds!
    mWidth = width;
    mHeight = height;

    try {
        for (size_t i = 0; i < mWidth; i++) {
            mCells[i] = new GamePiece[mHeight];
        }
    } catch (...) {
        cleanup();
    }
}
```

```

        // Nest any caught exception inside a bad_alloc exception.
        std::throw_with_nested(std::bad_alloc());
    }
}

GameBoard::GameBoard(const GameBoard& src)
    : GameBoard(src.mWidth, src.mHeight)
{
    // The ctor-initializer of this constructor delegates first to the
    // non-copy constructor to allocate the proper amount of memory.

    // The next step is to copy the data.
    for (size_t i = 0; i < mWidth; i++) {
        for (size_t j = 0; j < mHeight; j++) {
            mCells[i][j] = src.mCells[i][j];
        }
    }
}

GameBoard::~GameBoard() noexcept
{
    cleanup();
}

void GameBoard::cleanup() noexcept
{
    for (size_t i = 0; i < mWidth; i++)
        delete[] mCells[i];
    delete[] mCells;
    mCells = nullptr;
    mWidth = mHeight = 0;
}

void GameBoard::verifyCoordinate(size_t x, size_t y) const
{
    if (x >= mWidth)
        throw out_of_range("x-coordinate beyond width");
    if (y >= mHeight)
        throw out_of_range("y-coordinate beyond height");
}

void swap(GameBoard& first, GameBoard& second) noexcept
{
    using std::swap;

    swap(first.mWidth, second.mWidth);
    swap(first.mHeight, second.mHeight);
    swap(first.mCells, second.mCells);
}

GameBoard& GameBoard::operator=(const GameBoard& rhs)
{
    // Check for self-assignment

```

```
    if (this == &rhs) {
        return *this;
    }

    // Copy-and-swap idiom
    GameBoard temp(rhs); // Do all the work in a temporary instance
    swap(*this, temp); // Commit the work with only non-throwing operations
    return *this;
}

const GamePiece& GameBoard::at(size_t x, size_t y) const
{
    verifyCoordinate(x, y);
    return mCells[x][y];
}

GamePiece& GameBoard::at(size_t x, size_t y)
{
    return const_cast<GamePiece&>(std::as_const(*this).at(x, y));
}
```

SUMMARY

This chapter described the issues related to error handling in C++ programs, and emphasized that you must design and code your programs with an error-handling plan. By reading this chapter, you learned the details of C++ exceptions syntax and behavior. The chapter also covered some of the areas in which error handling plays a large role, including I/O streams, memory allocation, constructors, and destructors. Finally, you saw an example of error handling in a `GameBoard` class.

15

Overloading C++ Operators

WHAT'S IN THIS CHAPTER?

- Explaining operator overloading
 - Rationale for overloading operators
 - Limitations, caveats, and choices in operator overloading
 - Summary of operators you can, cannot, and should not overload
- How to overload unary plus, unary minus, increment, and decrement
- How to overload the I/O stream operators (`operator<<` and `operator>>`)
- How to overload the subscripting (array index) operator
- How to overload the function call operator
- How to overload the dereferencing operators (`*` and `->`)
- How to write conversion operators
- How to overload the memory allocation and deallocation operators

WROX.COM DOWNLOADS FOR THIS CHAPTER

Please note that all the code examples for this chapter are available as a part of this chapter's code download on the book's website at www.wrox.com/go/proc++4e on the Download Code tab.

C++ allows you to redefine the meanings of operators, such as `+`, `-`, and `=`, for your classes. Many object-oriented languages do not provide this capability, so you might be tempted to disregard its usefulness in C++. However, it can be beneficial for making your classes behave similarly to built-in types such as `ints` and `doubles`. It is even possible to write classes that look like arrays, functions, or pointers.

Chapters 5 and 6 introduce object-oriented design and operator overloading, respectively. Chapters 8 and 9 present the syntax details for objects and for basic operator overloading. This chapter picks up operator overloading where Chapter 9 left off.

OVERVIEW OF OPERATOR OVERLOADING

As Chapter 1 explains, operators in C++ are symbols such as `+`, `<`, `*`, and `<<`. They work on built-in types such as `int` and `double` to allow you to perform arithmetic, logical, and other operations. There are also operators such as `->` and `*` that allow you to dereference pointers. The concept of operators in C++ is broad, and even includes `[]` (array index), `()` (function call), casting, and the memory allocation and deallocation operators. Operator overloading allows you to change the behavior of language operators for your classes. However, this capability comes with rules, limitations, and choices.

Why Overload Operators?

Before learning how to overload operators, you probably want to know why you would ever want to do so. The reasons vary for the different operators, but the general guiding principle is to make your classes behave like built-in types. The closer your classes are to built-in types, the easier they will be for clients to use. For example, if you want to write a class to represent fractions, it's quite helpful to have the ability to define what `+`, `-`, `*`, and `/` mean when applied to objects of that class.

Another reason to overload operators is to gain greater control over the behavior in your program. For example, you can overload memory allocation and deallocation operators for your classes to specify exactly how memory should be distributed and reclaimed for each new object.

It's important to emphasize that operator overloading doesn't necessarily make things easier for you as the class developer; its main purpose is to make things easier for users of the class.

Limitations to Operator Overloading

Here is a list of things you cannot do when you overload operators:

- You cannot add new operator symbols. You can only redefine the meanings of operators already in the language. The table in the section, "Summary of Overloadable Operators," lists all of the operators that you can overload.
- There are a few operators that you cannot overload, such as `.` (member access in an object), `::` (scope resolution operator), `sizeof`, `?:` (the conditional operator), and a few others. The table lists all the operators that you *can* overload. The operators that you can't overload are

usually not those you would care to overload anyway, so you shouldn't find this restriction limiting.

- The *arity* describes the number of arguments, or *operands*, associated with the operator. You can only change the arity for the function call, new, and delete operators. For all other operators, you cannot change the arity. Unary operators, such as ++, work on only one operand. Binary operators, such as /, work on two operands. The main situation where this limitation might affect you is when overloading [] (array index), which is discussed later in this chapter.
- You cannot change the *precedence* or *associativity* of the operator. These rules determine in which order operators are evaluated in a statement. Again, this constraint shouldn't be cause for concern in most programs because there are rarely benefits to changing the order of evaluation.
- You cannot redefine operators for built-in types. The operator must be a method in a class, or at least one of the arguments to a global overloaded operator function must be a user-defined type (for example, a class). This means that you can't do something ridiculous, such as redefine + for ints to mean subtraction (though you could do so for your classes). The one exception to this rule is the memory allocation and deallocation operators; you can replace the global operators for all memory allocations in your program.

Some of the operators already mean two different things. For example, the - operator can be used as a binary operator (as in `x = y - z;`) or as a unary operator (as in `x = -y;`). The * operator can be used for multiplication or for dereferencing a pointer. The << operator is the stream insertion operator or the left-shift operator, depending on the context. You can overload both meanings of operators with dual meanings.

Choices in Operator Overloading

When you overload an operator, you write a function or method with the name `operatorX`, where `X` is the symbol for some operator, and with optional white space between `operator` and `X`. For example, Chapter 9 declares `operator+` for `SpreadsheetCell` objects like this:

```
SpreadsheetCell operator+(const SpreadsheetCell& lhs,
    const SpreadsheetCell& rhs);
```

The following sections describe several choices involved in each overloaded operator function or method you write.

Method or Global Function

First, you must decide whether your operator should be a method of your class or a global function (sometimes a `friend` of the class). How do you choose? First, you need to understand the difference between these two choices. When the operator is a method of a class, the left-hand side of the operator expression must always be an object of that class. If you write a global function, the left-hand side can be an object of a different type.

There are three different types of operators:

- **Operators that must be methods.** The C++ language requires some operators to be methods of a class because they don't make sense outside of a class. For example, `operator=` is tied so closely to the class that it can't exist anywhere else. The table in the section, "Summary of Overloadable Operators," lists those operators that must be methods. Most operators do not impose this requirement.
- **Operators that must be global functions.** Whenever you need to allow the left-hand side of the operator to be a variable of a different type than your class, you must make the operator a global function. This rule applies specifically to `operator<<` and `operator>>`, where the left-hand side is an `ostream` object, not an object of your class. Additionally, commutative operators like binary `+` and `-` should allow variables that are not objects of your class on the left-hand side. Chapter 9 discusses this problem.
- **Operators that can be either methods or global functions.** There is some disagreement in the C++ community on whether it's better to write methods or global functions to overload operators. However, I recommend the following rule: make every operator a method unless you must make it a global function, as described previously. One major advantage to this rule is that methods can be `virtual`, while global functions obviously cannot. Therefore, when you plan to write overloaded operators in an inheritance tree, you should make them methods if possible.

When you write an overloaded operator as a method, you should mark it `const` if it doesn't change the object. That way, it can be called on `const` objects.

Choosing Argument Types

You are somewhat limited in your choice of argument types because, as stated earlier, for most operators you cannot change the number of arguments. For example, `operator/` must always have two arguments if it is a global function, and one argument if it's a method. The compiler issues an error if it differs from this standard. In this sense, the operator functions are different from normal functions, which you can overload with any number of parameters. Additionally, although you can write the operator for whichever types you want, the choice is usually constrained by the class for which you are writing the operator. For example, if you want to implement addition for class `T`, you don't write an `operator+` that takes two `strings`! The real choice arises when you try to determine whether to take parameters by value or by reference, and whether or not to make them `const`.

The choice of value versus reference is easy: you should take every non-primitive parameter type by reference. As Chapters 9 and 11 explain, you should never pass objects by value if you can pass-by-reference instead.

The `const` decision is also trivial: mark every parameter `const` unless you actually modify it. The table in the section, "Summary of Overloadable Operators," shows sample prototypes for each operator, with the arguments marked `const` and reference as appropriate.

Choosing Return Types

C++ doesn't determine overload resolution based on return type. Thus, you can specify any return type you want when you write overloaded operators. However, just because you *can* do something doesn't mean you *should* do it. This flexibility implies that you could write confusing code in which comparison operators return pointers, and arithmetic operators return `bool`s. However, you shouldn't do that. Instead, you should write your overloaded operators such that they return the same types as the operators do for the built-in types. If you write a comparison operator, return a `bool`. If you write an arithmetic operator, return an object representing the result. Sometimes the return type is not obvious at first. For example, as Chapter 8 mentions, `operator=` should return a reference to the object on which it's called in order to support nested assignments. Other operators have similarly tricky return types, all of which are summarized in the table in the section, "Summary of Overloadable Operators."

The same choices of reference and `const` apply to return types as well. However, for return values, the choices are more difficult. The general rule for value or reference is to return a reference if you can; otherwise, return a value. How do you know when you can return a reference? This choice applies only to operators that return objects: the choice is moot for the comparison operators that return `bool`, the conversion operators that have no return type, and the function call operator, which may return any type you want. If your operator constructs a new object, then you must return that new object by value. If it does not construct a new object, you can return a reference to the object on which the operator is called, or one of its arguments. The table in the section, "Summary of Overloadable Operators," shows examples.

A return value that can be modified as an *lvalue* (the left-hand side of an assignment expression) must be non-`const`. Otherwise, it should be `const`. More operators than you might expect require that you return lvalues, including all of the assignment operators (`operator=`, `operator+=`, `operator-=`, and so on).

Choosing Behavior

You can provide whichever implementation you want in an overloaded operator. For example, you could write an `operator+` that launches a game of Scrabble. However, as Chapter 6 describes, you should generally constrain your implementations to provide behaviors that clients expect. Write `operator+` so that it performs addition, or something like addition, such as string concatenation. This chapter explains how you *should* implement your overloaded operators. In exceptional circumstances, you might want to differ from these recommendations; but, in general, you should follow the standard patterns.

Operators You Shouldn't Overload

Some operators should not be overloaded, even though it is permitted. Specifically, the address-of operator (`operator&`) is not particularly useful to overload, and leads to confusion if you do because you are changing fundamental language behavior (taking addresses of variables) in potentially unexpected ways. The entire Standard Library, which uses operator overloading extensively, never overloads the address-of operator.

Additionally, you should avoid overloading the binary Boolean operators `operator&&` and `operator||` because you lose C++'s short-circuit evaluation rules.

Finally, you should not overload the comma operator (`operator,`). Yes, you read that correctly: there really is a comma operator in C++. It's also called the *sequencing operator*, and is used to separate two expressions in a single statement, while guaranteeing that they are evaluated left to right. There is rarely a good reason to overload this operator.

Summary of Overloadable Operators

The following table lists the operators that you can overload, specifies whether they should be methods of the class or global functions, summarizes when you should (or should not) overload them, and provides sample prototypes showing the proper return values.

This table is a useful reference for the future when you want to write an overloaded operator. You're bound to forget which return type you should use, and whether or not the function should be a method.

In this table, `T` is the name of the class for which the overloaded operator is written, and `E` is a different type. Note that the sample prototypes given are not exhaustive; often there are other combinations of `T` and `E` possible for a given operator.

OPERATOR	NAME OR CATEGORY	METHOD OR GLOBAL FUNCTION	WHEN TO OVERLOAD	SAMPLE PROTOTYPE
<code>operator+</code> <code>operator-</code> <code>operator*</code> <code>operator/</code> <code>operator%</code>	Binary arithmetic	Global function recommended	Whenever you want to provide these operations for your class	<code>T operator+(const T&, const T&);</code> <code>T operator+(const T&, const E&);</code>
<code>operator-</code> <code>operator+</code> <code>operator~</code>	Unary arithmetic and bitwise operators	Method recommended	Whenever you want to provide these operations for your class	<code>T operator-() const;</code>
<code>operator++</code> <code>operator--</code>	Pre-increment and pre-decrement	Method recommended	Whenever you overload <code>+=</code> and <code>-=</code> taking an arithmetic argument (<code>int</code> , <code>long</code> , ...)	<code>T& operator++();</code>
<code>operator++</code> <code>operator--</code>	Post-increment and post-decrement	Method recommended	Whenever you overload <code>+=</code> and <code>-=</code> taking an arithmetic argument (<code>int</code> , <code>long</code> , ...)	<code>T operator++(int);</code>

OPERATOR	NAME OR CATEGORY	METHOD OR GLOBAL FUNCTION	WHEN TO OVERLOAD	SAMPLE PROTOTYPE
<code>operator=</code>	Assignment operator	Method required	Whenever your class has dynamically allocated memory or resources, or members that are references	<code>T& operator=(const T&);</code>
<code>operator+=</code> <code>operator-=</code> <code>operator*=</code> <code>operator/=</code> <code>operator%=</code>	Shorthand arithmetic operator assignments	Method recommended	Whenever you overload the binary arithmetic operators and your class is not designed to be immutable	<code>T& operator+=(const T&);</code> <code>T& operator+=(const E&);</code>
<code>operator<<</code> <code>operator>></code> <code>operator&</code> <code>operator </code> <code>operator^</code>	Binary bitwise operators	Global function recommended	Whenever you want to provide these operations	<code>T operator<<(const T&, const T&);</code> <code>T operator<<(const T&, const E&);</code>
<code>operator<<=</code> <code>operator>>=</code> <code>operator&=</code> <code>operator =</code> <code>operator^=</code>	Shorthand bitwise operator assignments	Method recommended	Whenever you overload the binary bitwise operators and your class is not designed to be immutable	<code>T& operator<<=(const T&);</code> <code>T& operator<<=(const E&);</code>
<code>operator<</code> <code>operator></code> <code>operator<=</code> <code>operator>=</code> <code>operator==</code> <code>operator!=</code>	Binary comparison operators	Global function recommended	Whenever you want to provide these operations	<code>bool operator<(const T&, const T&);</code> <code>bool operator<(const T&, const E&);</code>
<code>operator<<</code> <code>operator>></code>	I/O stream operators (insertion and extraction)	Global function required	Whenever you want to provide these operations	<code>ostream& operator<<(ostream&, const T&);</code> <code>istream& operator>>(istream&, T&);</code>

continues

TABLE (continued)

OPERATOR	NAME OR CATEGORY	METHOD OR GLOBAL FUNCTION	WHEN TO OVERLOAD	SAMPLE PROTOTYPE
<code>operator!</code>	Boolean negation operator	Member function recommended	Rarely; use <code>bool</code> or <code>void*</code> conversion instead.	<code>bool operator!() const;</code>
<code>operator&&</code> <code>operator </code>	Binary Boolean operators	Global function recommended	Rarely, if ever, because you lose short-circuiting; it's better to overload <code>&</code> and <code> </code> instead, as these never short-circuit.	<code>bool operator&&(const T&, const T&);</code>
<code>operator[]</code>	Subscripting (array index) operator	Method required	When you want to support subscripting	<code>E& operator[] (size_t);</code> <code>const E& operator[] (size_t) const;</code>
<code>operator()</code>	Function call operator	Method required	When you want objects to behave like function pointers, or for multi-dimensional array access, since <code>[]</code> can only have one index	Return type and parameters can vary; see further examples in this chapter.
<code>operator type()</code>	Conversion, or cast, operators (separate operator for each type)	Method required	When you want to provide conversions from your class to other types	<code>operator double() const;</code>
<code>operator new</code> <code>operator new[]</code>	Memory allocation routines	Method recommended	When you want to control memory allocation for your classes (rarely)	<code>void* operator new(size_t size);</code> <code>void* operator new[] (size_t size);</code>
<code>operator delete</code> <code>operator delete[]</code>	Memory deallocation routines	Method recommended	Whenever you overload the memory allocation routines (rarely)	<code>void operator delete(void* ptr) noexcept;</code> <code>void operator delete[] (void* ptr) noexcept;</code>

OPERATOR	NAME OR CATEGORY	METHOD OR GLOBAL FUNCTION	WHEN TO OVERLOAD	SAMPLE PROTOTYPE
operator* operator->	Dereferencing operators	Method recommended for operator* Method required for operator->	Useful for smart pointers	E& operator*() const; E* operator->() const;
operator&	Address-of operator	N/A	Never	N/A
operator->*	Dereference pointer-to-member	N/A	Never	N/A
operator,	Comma operator	N/A	Never	N/A

Rvalue References

Chapter 9 discusses *rvalue references*, written as `&&` instead of the normal lvalue references, `&`. They are demonstrated in Chapter 9 by defining *move assignment operators*, which are used by the compiler in cases where the second object is a temporary object that will be destroyed after the assignment. The normal assignment operator from the preceding table has the following prototype:

```
T& operator=(const T&);
```

The move assignment operator has almost the same prototype, but uses an rvalue reference. It modifies the argument so it cannot be passed as `const`. See Chapter 9 for details.

```
T& operator=(T&&);
```

The preceding table does not include sample prototypes with rvalue reference semantics. However, for most operators it can make sense to write both a version using normal lvalue references and a version using rvalue references. Whether it makes sense depends on implementation details of your class. The `operator=` is one example from Chapter 9. Another example is `operator+` to prevent unnecessary memory allocations. The `std::string` class from the Standard Library, for example, implements an `operator+` using rvalue references as follows (simplified):

```
string operator+(string&& lhs, string&& rhs);
```

The implementation of this operator reuses memory of one of the arguments because they are being passed as rvalue references, meaning both are temporary objects that will be destroyed when this `operator+` is finished. The implementation of the preceding `operator+` has the following effect depending on the size and the capacity of both operands:

```
return std::move(lhs.append(rhs));
or
return std::move(rhs.insert(0, lhs));
```

In fact, `std::string` defines several overloaded `operator+` operators with different combinations of lvalue references and rvalue references. The following is a list of all `operator+` operators for `std::string` accepting two strings as arguments (simplified):

```
string operator+(const string& lhs, const string& rhs);
string operator+(string&& lhs, const string& rhs);
string operator+(const string& lhs, string&& rhs);
string operator+(string&& lhs, string&& rhs);
```

Reusing memory of one of the rvalue reference arguments is implemented in the same way as it is explained for move assignment operators in Chapter 9.

Relational Operators

There is a handy `<utility>` header file included with the C++ Standard Library. It contains quite a few helper functions and classes. It also contains the following set of function templates for relational operators in the `std::rel_ops` namespace:

```
template<class T> bool operator!=(const T& a, const T& b); // Needs operator==
template<class T> bool operator>(const T& a, const T& b); // Needs operator<
template<class T> bool operator<=(const T& a, const T& b); // Needs operator<
template<class T> bool operator>=(const T& a, const T& b); // Needs operator<
```

These function templates define the operators `!=`, `>`, `<=`, and `>=` in terms of the `==` and `<` operators for any class. If you implement `operator==` and `operator<` in your class, you get the other relational operators for free with these templates. You can make these available for your class by simply adding a `#include <utility>` and adding the following `using` statement:

```
using namespace std::rel_ops;
```

However, one problem with this technique is that now those operators might be created for all classes that you use in relational operations, not only for your own class.

A second problem with this technique is that utility templates such as `std::greater<T>` (discussed in Chapter 18) do not work with those automatically generated relational operators.

Yet another problem with these is that implicit conversions will not work. Therefore:

NOTE *I recommend that you just implement all relational operators for a class yourself instead of relying on `std::rel_ops`.*

OVERLOADING THE ARITHMETIC OPERATORS

Chapter 9 shows how to write the binary arithmetic operators and the shorthand arithmetic assignment operators, but it does not cover how to overload the other arithmetic operators.

Overloading Unary Minus and Unary Plus

C++ has several unary arithmetic operators. Two of these are unary minus and unary plus. Here is an example of these operators using ints:

```
int i, j = 4;
i = -j;    // Unary minus
i = +i;    // Unary plus
j = +(-i); // Apply unary plus to the result of applying unary minus to i.
j = -(-i); // Apply unary minus to the result of applying unary minus to i.
```

Unary minus negates the operand, while unary plus returns the operand directly. Note that you can apply unary plus or unary minus to the result of unary plus or unary minus. These operators don't change the object on which they are called so you should make them `const`.

Here is an example of a unary operator- as a member function for a `SpreadsheetCell` class. Unary plus is usually an identity operation, so this class doesn't overload it:

```
SpreadsheetCell SpreadsheetCell::operator-() const
{
    return SpreadsheetCell(-getValue());
}
```

`operator-` doesn't change the operand, so this method must construct a new `SpreadsheetCell` with the negated value, and return it. Thus, it can't return a reference. You can use this operator as follows:

```
SpreadsheetCell c1(4);
SpreadsheetCell c3 = -c1;
```

Overloading Increment and Decrement

There are four ways to add 1 to a variable:

```
i = i + 1;
i += 1;
++i;
i++;
```

The last two forms are called the *increment* operators. The first form is *prefix increment*, which adds 1 to the variable, then returns the newly incremented value for use in the rest of the expression. The second form is *postfix increment*, which returns the old (non-incremented) value for use in the rest of the expression. The decrement operators work similarly.

The two possible meanings for `operator++` and `operator--` (prefix and postfix) present a problem when you want to overload them. When you write an overloaded `operator++`, for example, how do you specify whether you are overloading the prefix or the postfix version? C++ introduced a hack

to allow you to make this distinction: the prefix versions of `operator++` and `operator--` take no arguments, while the postfix versions take one unused argument of type `int`.

The prototypes of these overloaded operators for the `SpreadsheetCell` class look like this:

```
SpreadsheetCell& operator++(); // Prefix
SpreadsheetCell operator++(int); // Postfix
SpreadsheetCell& operator--(); // Prefix
SpreadsheetCell operator--(int); // Postfix
```

The return value in the prefix forms is the same as the end value of the operand, so prefix increment and decrement can return a reference to the object on which they are called. The postfix versions of increment and decrement, however, return values that are different from the end values of the operands, so they cannot return references.

Here are the implementations for `operator++`:

```
SpreadsheetCell& SpreadsheetCell::operator++()
{
    set(getValue() + 1);
    return *this;
}

SpreadsheetCell SpreadsheetCell::operator++(int)
{
    auto oldCell(*this); // Save current value
    ++(*this);           // Increment using prefix ++
    return oldCell;      // Return the old value
}
```

The implementations for `operator--` are almost identical. Now you can increment and decrement `SpreadsheetCell` objects to your heart's content:

```
SpreadsheetCell c1(4);
SpreadsheetCell c2(4);
c1++;
++c2;
```

Increment and decrement also work on pointers. When you write classes that are smart pointers or iterators, you can overload `operator++` and `operator--` to provide pointer incrementing and decrementing.

OVERLOADING THE BITWISE AND BINARY LOGICAL OPERATORS

The bitwise operators are similar to the arithmetic operators, and the bitwise shorthand assignment operators are similar to the arithmetic shorthand assignment operators. However, they are significantly less common, so no examples are shown here. The table in the section “Summary of Overloadable Operators” shows sample prototypes, so you should be able to implement them easily if the need ever arises.

The logical operators are trickier. It's not recommended to overload `&&` and `||`. These operators don't really apply to individual types: they aggregate results of Boolean expressions. Additionally, you lose the short-circuit evaluation, because both the left-hand side and the right-hand side have to be evaluated before they can be bound to the parameters of your overloaded operator `&&` and `||`. Thus, it rarely, if ever, makes sense to overload them for specific types.

OVERLOADING THE INSERTION AND EXTRACTION OPERATORS

In C++, you use operators not only for arithmetic operations, but also for reading from, and writing to, streams. For example, when you write ints and strings to `cout`, you use the insertion operator `<<`:

```
int number = 10;
cout << "The number is " << number << endl;
```

When you read from streams, you use the extraction operator `>>`:

```
int number;
string str;
cin >> number >> str;
```

You can write insertion and extraction operators that work on your classes as well, so that you can read and write them like this:

```
SpreadsheetCell myCell, anotherCell, aThirdCell;
cin >> myCell >> anotherCell >> aThirdCell;
cout << myCell << " " << anotherCell << " " << aThirdCell << endl;
```

Before you write the insertion and extraction operators, you need to decide how you want to stream your class out and how you want to read it in. In this example, the `SpreadsheetCells` simply read and write `double` values.

The object on the left of an extraction or insertion operator is an `istream` or `ostream` (such as `cin` or `cout`), not a `SpreadsheetCell` object. Because you can't add a method to the `istream` or `ostream` classes, you must write the extraction and insertion operators as global functions. The declaration of these functions looks like this:

```
class SpreadsheetCell
{
    // Omitted for brevity
};
std::ostream& operator<<(std::ostream& ostr, const SpreadsheetCell& cell);
std::istream& operator>>(std::istream& istr, SpreadsheetCell& cell);
```

By making the insertion operator take a reference to an `ostream` as its first parameter, you allow it to be used for file output streams, string output streams, `cout`, `cerr`, and `clog`. See Chapter 13 for details on streams. Similarly, by making the extraction operator take a reference to an `istream`, you make it work on file input streams, string input streams, and `cin`.

The second parameter to `operator<<` and `operator>>` is a reference to the `SpreadsheetCell` object that you want to write or read. The insertion operator doesn't change the `SpreadsheetCell`

it writes, so that reference can be `const`. The extraction operator, however, modifies the `SpreadsheetCell` object, requiring the argument to be a non-`const` reference.

Both operators return a reference to the stream they were given as their first argument so that calls to the operator can be nested. Remember that the operator syntax is shorthand for calling the global `operator>>` or `operator<<` functions explicitly. Consider this line:

```
cin >> myCell >> anotherCell >> aThirdCell;
```

It's actually shorthand for this line:

```
operator>>(operator>>(operator>>(cin, myCell), anotherCell), aThirdCell);
```

As you can see, the return value of the first call to `operator>>` is used as input to the next call. Thus, you must return the stream reference so that it can be used in the next nested call. Otherwise, the nesting won't compile.

Here are the implementations for `operator<<` and `operator>>` for the `SpreadsheetCell` class:

```
ostream& operator<<(ostream& ostr, const SpreadsheetCell& cell)
{
    ostr << cell.getValue();
    return ostr;
}

istream& operator>>(istream& istr, SpreadsheetCell& cell)
{
    double value;
    istr >> value;
    cell.set(value);
    return istr;
}
```

OVERLOADING THE SUBSCRIPTING OPERATOR

Pretend for a few minutes that you have never heard of the `vector` or `array` class templates in the Standard Library, and so you have decided to write your own dynamically allocated array class. This class would allow you to set and retrieve elements at specified indices, and would take care of all memory allocation “behind the scenes.” A first stab at the class definition for a dynamically allocated array might look like this:

```
template <typename T>
class Array
{
public:
    // Creates an array with a default size that will grow as needed.
    Array();
    virtual ~Array();

    // Disallow assignment and pass-by-value
    Array<T>& operator=(const Array<T>& rhs) = delete;
    Array(const Array<T>& src) = delete;

    // Returns the value at index x. Throws an exception of type
```

```

    // out_of_range if index x does not exist in the array.
    const T& getElementAt(size_t x) const;

    // Sets the value at index x. If index x is out of range,
    // allocates more space to make it in range.
    void setElementAt(size_t x, const T& value);

    size_t getSize() const;
private:
    static const size_t kAllocSize = 4;
    void resize(size_t newSize);
    T* mElements = nullptr;
    size_t mSize = 0;
};

```

The interface supports setting and accessing elements. It provides random-access guarantees: a client could create an array and set elements 1, 100, and 1000 without worrying about memory management.

Here are the implementations of the methods:

```

template <typename T> Array<T>::Array()
{
    mSize = kAllocSize;
    mElements = new T[mSize] {}; // Elements are zero-initialized!
}

template <typename T> Array<T>::~~Array()
{
    delete [] mElements;
    mElements = nullptr;
}

template <typename T> void Array<T>::resize(size_t newSize)
{
    // Create new bigger array with zero-initialized elements.
    auto newArray = std::make_unique<T[]>(newSize);

    // The new size is always bigger than the old size (mSize)
    for (size_t i = 0; i < mSize; i++) {
        // Copy the elements from the old array to the new one
        newArray[i] = mElements[i];
    }

    // Delete the old array, and set the new array
    delete[] mElements;
    mSize = newSize;
    mElements = newArray.release();
}

template <typename T> const T& Array<T>::getElementAt(size_t x) const
{
    if (x >= mSize) {
        throw std::out_of_range("");
    }
    return mElements[x];
}

```

```

template <typename T> void Array<T>::setElementAt(size_t x, const T& val)
{
    if (x >= mSize) {
        // Allocate kAllocSize past the element the client wants
        resize(x + kAllocSize);
    }
    mElements[x] = val;
}

template <typename T> size_t Array<T>::getSize() const
{
    return mSize;
}

```

Pay some attention to the exception-safe implementation of the `resize()` method. First, it creates a new array of appropriate size, and stores it in a `unique_ptr`. Then, all elements are copied from the old array to the new array. If anything goes wrong while copying the values, the `unique_ptr` cleans up the memory automatically. Finally, when both the allocation of the new array and copying all the elements was successful, that is, no exceptions have been thrown, only then we delete the old `mElements` array and assign the new array to it. The last line has to use `release()` to release the ownership of the new array from the `unique_ptr`, otherwise the array will get destroyed when the destructor for the `unique_ptr` is called.

Here is a small example of how you could use this class:

```

Array<int> myArray;
for (size_t i = 0; i < 10; i++) {
    myArray.setElementAt(i, 100);
}
for (size_t i = 0; i < 10; i++) {
    cout << myArray.getElementAt(i) << " ";
}

```

As you can see, you never have to tell the array how much space you need. It allocates as much space as it requires to store the elements you give it. However, it's inconvenient to always have to use the `setElementAt()` and `getElementAt()` methods. It would be nice to be able to use conventional array index notation like this:

```

Array<int> myArray;
for (size_t i = 0; i < 10; i++) {
    myArray[i] = 100;
}
for (size_t i = 0; i < 10; i++) {
    cout << myArray[i] << " ";
}

```

This is where the overloaded subscripting operator comes in. You can add an `operator[]` to the class with the following implementation:

```

template <typename T> T& Array<T>::operator[](size_t x)
{
    if (x >= mSize) {
        // Allocate kAllocSize past the element the client wants.
        resize(x + kAllocSize);
    }
}

```

```

    }
    return mElements[x];
}

```

The example code using array index notation now compiles. The `operator[]` can be used to both set and get elements because it returns a reference to the element at location `x`. This reference can be used to assign to that element. When `operator[]` is used on the left-hand side of an assignment statement, the assignment actually changes the value at location `x` in the `mElements` array.

Providing Read-Only Access with `operator[]`

Although it's sometimes convenient for `operator[]` to return an element that can serve as an lvalue, you don't always want that behavior. It would be nice to be able to provide read-only access to the elements of the array as well, by returning a `const` reference. To provide for this, you need two `operator[]`s: one returns a reference and one returns a `const` reference:

```

T& operator[] (size_t x);
const T& operator[] (size_t x) const;

```

Remember that you can't overload a method or operator based only on the return type, so the second overload returns a `const` reference *and* is marked as `const`.

Here is the implementation of the `const operator[]`. It throws an exception if the index is out of range instead of trying to allocate new space. It doesn't make sense to allocate new space when you're only trying to read the element value.

```

template <typename T> const T& Array<T>::operator[] (size_t x) const
{
    if (x >= mSize) {
        throw std::out_of_range("");
    }
    return mElements[x];
}

```

The following code demonstrates these two forms of `operator[]`:

```

void printArray(const Array<int>& arr)
{
    for (size_t i = 0; i < arr.getSize(); i++) {
        cout << arr[i] << " "; // Calls the const operator[] because arr is
                               // a const object.
    }
    cout << endl;
}

int main()
{
    Array<int> myArray;
    for (size_t i = 0; i < 10; i++) {
        myArray[i] = 100; // Calls the non-const operator[] because
                          // myArray is a non-const object.
    }
    printArray(myArray);
    return 0;
}

```

Note that the `const operator[]` is called in `printArray()` only because `arr` is `const`. If `arr` were not `const`, the non-`const operator[]` would be called, despite the fact that the result is not modified.

The `const operator[]` is called for `const` objects, so it cannot grow the size of the array. The current implementation throws an exception when the given index is out of bounds. An alternative would be to return a zero-initialized element instead of throwing. This can be done as follows:

```
template <typename T> const T& Array<T>::operator[](size_t x) const
{
    if (x >= mSize) {
        static T nullValue = T();
        return nullValue;
    }
    return mElements[x];
}
```

The `nullValue` static variable is initialized using the zero-initialization¹ syntax `T()`. It's up to you and your specific use case whether you opt for the throwing version or the version returning a null value.

Non-integral Array Indices

It is a natural extension of the paradigm of “indexing” into a collection to provide a key of some sort; a `vector` (or in general, any linear array) is a special case where the “key” is just a position in the array. Think of the argument of `operator[]` as providing a mapping between two domains: the domain of keys and the domain of values. Thus, you can write an `operator[]` that uses any type as its index. This type does not need to be an integer type. This is done for the Standard Library associative containers, like `std::map`, which are discussed in Chapter 17.

For example, you could create an *associative array* in which you use `string` keys instead of integers. Here is the definition for such an associative array class:

```
template <typename T>
class AssociativeArray
{
public:
    virtual ~AssociativeArray() = default;

    T& operator[](std::string_view key);
    const T& operator[](std::string_view key) const;
private:
    // Implementation details omitted
};
```

Implementing this class would be a good exercise for you. You can also find an implementation of this class in the downloadable source code for this book at www.wrox.com/go/proc++4e.

¹*Zero-initialization* constructs objects with the default constructor, and initializes primitive integer types (such as `char`, `int`, and so on) to zero, primitive floating-point types to 0.0, and pointer types to `nullptr`.

NOTE *You cannot overload the subscripting operator to take more than one parameter. If you want to provide subscripting on more than one index, you can use the function call operator explained in the next section.*

OVERLOADING THE FUNCTION CALL OPERATOR

C++ allows you to overload the function call operator, written as `operator()`. If you write an `operator()` for your class, you can use objects of that class as if they were function pointers. An object of a class with a function call operator is called a *function object*, or *functor*, for short. You can overload this operator only as a non-static method in a class. Here is an example of a simple class with an overloaded `operator()` and a class method with the same behavior:

```
class FunctionObject
{
public:
    int operator() (int param); // Function call operator
    int doSquare(int param);   // Normal method
};

// Implementation of overloaded function call operator
int FunctionObject::operator() (int param)
{
    return doSquare(param);
}

// Implementation of normal method
int FunctionObject::doSquare(int param)
{
    return param * param;
}
```

Here is an example of code that uses the function call operator, contrasted with the call to a normal method of the class:

```
int x = 3, xSquared, xSquaredAgain;
FunctionObject square;
xSquared = square(x);           // Call the function call operator
xSquaredAgain = square.doSquare(x); // Call the normal method
```

At first, the function call operator probably seems a little strange. Why would you want to write a special method for a class to make objects of the class look like function pointers? Why wouldn't you just write a function or a standard method of a class? The advantage of function objects over standard methods of objects is simple: these objects can sometimes masquerade as function pointers, that is, you can pass function objects as callback functions to other functions. This is discussed in more detail in Chapter 18.

The advantages of function objects over global functions are more intricate. There are two main benefits:

- Objects can retain information in their data members between repeated calls to their function call operators. For example, a function object might be used to keep a running sum of numbers collected from each call to the function call operator.
- You can customize the behavior of a function object by setting data members. For example, you could write a function object to compare an argument to the function call operator against a data member. This data member could be configurable so that the object could be customized for whatever comparison you want.

Of course, you could implement either of the preceding benefits with global or `static` variables. However, function objects provide a cleaner way to do it, and using global or `static` variables might cause problems in a multithreaded application. The true benefits of function objects are demonstrated with the Standard Library in Chapter 18.

By following the normal method overloading rules, you can write as many `operator()`s for your classes as you want. For example, you could add an `operator()` to the `FunctionObject` class that takes an `std::string_view`:

```
int operator() (int param);
void operator() (std::string_view str);
```

The function call operator can also be used to provide subscripting for multi-dimensional arrays. Simply write an `operator()` that behaves like `operator[]` but allows for more than one index. The only minor annoyance with this technique is that you have to use `()` to index instead of `[]`, as in `myArray(3, 4) = 6;`.

OVERLOADING THE DEREFERENCING OPERATORS

You can overload three dereferencing operators: `*`, `->`, and `->*`. Ignoring `->*` for the moment (I'll come back to it later), consider the built-in meanings of `*` and `->`. The `*` operator dereferences a pointer to give you direct access to its value, while `->` is shorthand for a `*` dereference followed by a `.` member selection. The following code shows the equivalences:

```
SpreadsheetCell* cell = new SpreadsheetCell;
(*cell).set(5); // Dereference plus member selection
cell->set(5); // Shorthand arrow dereference and member selection together
```

You can overload the dereferencing operators for your classes in order to make objects of the classes behave like pointers. The main use of this capability is for implementing smart pointers, introduced in Chapter 1. It is also useful for iterators, which the Standard Library uses extensively. Iterators are discussed in Chapter 17. This chapter teaches you the basic mechanics for overloading the relevant operators in the context of a simple smart pointer class template.

WARNING *C++ has two standard smart pointers called `std::unique_ptr` and `std::shared_ptr`. It is highly recommended to use these standard smart pointer classes instead of writing your own. The example here is given only to demonstrate how to write dereferencing operators.*

Here is the example smart pointer class template definition, without the dereferencing operators filled in yet:

```
template <typename T> class Pointer
{
public:
    Pointer(T* ptr);
    virtual ~Pointer();

    // Prevent assignment and pass by value.
    Pointer(const Pointer<T>& src) = delete;
    Pointer<T>& operator=(const Pointer<T>& rhs) = delete;

    // Dereferencing operators will go here.
private:
    T* mPtr = nullptr;
};
```

This smart pointer is about as simple as you can get. All it does is store a dumb raw pointer, and the storage pointed to by the pointer is deleted when the smart pointer is destroyed. The implementation is equally simple: the constructor takes a raw pointer, which is stored as the only data member in the class. The destructor frees the storage referenced by the pointer.

```
template <typename T> Pointer<T>::Pointer(T* ptr) : mPtr(ptr)
{
}

template <typename T> Pointer<T>::~~Pointer()
{
    delete mPtr;
    mPtr = nullptr;
}
```

You want to be able to use the smart pointer class template like this:

```
Pointer<int> smartInt(new int);
*smartInt = 5; // Dereference the smart pointer.
cout << *smartInt << endl;

Pointer<SpreadsheetCell> smartCell(new SpreadsheetCell);
smartCell->set(5); // Dereference and member select the set method.
cout << smartCell->getValue() << endl;
```

As you can see from this example, you have to provide implementations of `operator*` and `operator->` for this class. These are implemented in the next two sections.

WARNING *You should rarely, if ever, write an implementation of just one of `operator*` and `operator->`. You should almost always write both operators together. It would confuse the users of your class if you failed to provide both.*

Implementing `operator*`

When you dereference a pointer, you expect to be able to access the memory to which the pointer points. If that memory contains a simple type such as an `int`, you should be able to change its value directly. If the memory contains a more complicated type, such as an object, you should be able to access its data members or methods with the `.` operator.

To provide these semantics, you should return a reference from `operator*`. In the `Pointer` class, the declaration and definition are as follows:

```
template <typename T> class Pointer
{
public:
    // Omitted for brevity
    T& operator*();
    const T& operator*() const;
    // Omitted for brevity
};

template <typename T> T& Pointer<T>::operator*()
{
    return *mPtr;
}

template <typename T> const T& Pointer<T>::operator*() const
{
    return *mPtr;
}
```

As you can see, `operator*` returns a reference to the object or variable to which the underlying raw pointer points. As with overloading the subscripting operators, it's useful to provide both `const` and non-`const` versions of the method, which return a `const` reference and a non-`const` reference, respectively.

Implementing `operator->`

The arrow operator is a bit trickier. The result of applying the arrow operator should be a member or method of an object. However, in order to implement it like that, you would have to be able to implement the equivalent of `operator*` followed by `operator.`; C++ doesn't allow you to overload `operator.` for good reason: it's impossible to write a single prototype that allows you to capture

any possible member or method selection. Therefore, C++ treats `operator->` as a special case. Consider this line:

```
smartCell->set(5);
```

C++ translates this to

```
(smartCell.operator->())->set(5);
```

As you can see, C++ applies another `operator->` to whatever you return from your overloaded `operator->`. Therefore, you must return a pointer, like this:

```
template <typename T> class Pointer
{
public:
    // Omitted for brevity
    T* operator->();
    const T* operator->() const;
    // Omitted for brevity
};

template <typename T> T* Pointer<T>::operator->()
{
    return mPtr;
}

template <typename T> const T* Pointer<T>::operator->() const
{
    return mPtr;
}
```

You may find it confusing that `operator*` and `operator->` are asymmetric, but once you see them a few times, you'll get used to it.

What in the World Are `operator.*` and `operator->*`?

It's perfectly legitimate in C++ to take the addresses of class data members and methods in order to obtain pointers to them. However, you can't access a non-`static` data member or call a non-`static` method without an object. The whole point of class data members and methods is that they exist on a per-object basis. Thus, when you want to call the method or access the data member via the pointer, you must dereference the pointer in the context of an object. The following example demonstrates this. Chapter 11 discusses the syntactical details in the section "Pointers to Methods and Data Members."

```
SpreadsheetCell myCell;
double (SpreadsheetCell::*methodPtr) () const = &SpreadsheetCell::getValue;
cout << (myCell.*methodPtr) () << endl;
```

Note the use of the `.*` operator to dereference the method pointer and call the method. There is also an equivalent `operator->*` for calling methods via pointers when you have a pointer to an object instead of the object itself. The operator looks like this:

```
SpreadsheetCell* myCell = new SpreadsheetCell();
double (SpreadsheetCell::*methodPtr) () const = &SpreadsheetCell::getValue;
cout << (myCell->.*methodPtr) () << endl;
```

C++ does not allow you to overload `operator.*` (just as you can't overload `operator.`), but you could overload `operator->*`. However, it is very tricky, and, given that most C++ programmers don't even know that you can access methods and data members through pointers, it's probably not worth the trouble. The `std::shared_ptr` template in the Standard Library, for example, does not overload `operator->*`.

WRITING CONVERSION OPERATORS

Going back to the `SpreadsheetCell` example, consider these two lines of code:

```
SpreadsheetCell cell(1.23);
double d1 = cell; // DOES NOT COMPILE!
```

A `SpreadsheetCell` contains a `double` representation, so it seems logical that you could assign it to a `double` variable. Well, you can't. The compiler tells you that it doesn't know how to convert a `SpreadsheetCell` to a `double`. You might be tempted to try forcing the compiler to do what you want, like this:

```
double d1 = (double)cell; // STILL DOES NOT COMPILE!
```

First, the preceding code still doesn't compile because the compiler still doesn't know *how* to convert the `SpreadsheetCell` to a `double`. It already knew from the first line what you wanted it to do, and it would do it if it could. Second, it's a bad idea in general to add gratuitous casts to your program.

If you want to allow this kind of assignment, you must tell the compiler how to perform it. Specifically, you can write a conversion operator to convert `SpreadsheetCells` to `doubles`. The prototype looks like this:

```
operator double() const;
```

The name of the function is `operator double`. It has no return type because the return type is specified by the name of the operator: `double`. It is `const` because it doesn't change the object on which it is called. The implementation looks like this:

```
SpreadsheetCell::operator double() const
{
    return getValue();
}
```

That's all you need to do to write a conversion operator from `SpreadsheetCell` to `double`. Now the compiler accepts the following lines and does the right thing at run time:

```
SpreadsheetCell cell(1.23);
double d1 = cell; // Works as expected
```

You can write conversion operators for any type with this same syntax. For example, here is an `std::string` conversion operator for `SpreadsheetCell`:

```
SpreadsheetCell::operator std::string() const
{
    return doubleToString(getValue());
}
```

Now you can write code like the following:

```
SpreadsheetCell cell(1.23);
string str = cell;
```

Solving Ambiguity Problems with Explicit Conversion Operators

Note that writing the `double` conversion operator for the `SpreadsheetCell` object introduces an *ambiguity* problem. Consider this line:

```
SpreadsheetCell cell(1.23);
double d2 = cell + 3.3; // DOES NOT COMPILE IF YOU DEFINE operator double()
```

This line now fails to compile. It worked before you wrote `operator double()`, so what's the problem now? The issue is that the compiler doesn't know if it should convert `cell` to a `double` with `operator double()` and perform `double` addition, or convert `3.3` to a `SpreadsheetCell` with the `double` constructor and perform `SpreadsheetCell` addition. Before you wrote `operator double()`, the compiler had only one choice: convert `3.3` to a `SpreadsheetCell` with the `double` constructor and perform `SpreadsheetCell` addition. However, now the compiler could do either. It doesn't want to make a choice you might not like, so it refuses to make any choice at all.

The usual pre-C++11 solution to this conundrum is to make the constructor in question *explicit*, so that the automatic conversion using that constructor is prevented (see Chapter 9). However, you don't want that constructor to be *explicit* because you generally like the automatic conversion of `doubles` to `SpreadsheetCells`. Since C++11, you can solve this problem by making the `double` conversion operator *explicit* instead of the constructor:

```
explicit operator double() const;
```

The following code demonstrates its use:

```
SpreadsheetCell cell = 6.6;           // [1]
string str = cell;                   // [2]
double d1 = static_cast<double>(cell); // [3]
double d2 = static_cast<double>(cell + 3.3); // [4]
```

Here is what each line of code means:

- [1] Uses the implicit conversion from a `double` to a `SpreadsheetCell`. Because this is in the declaration, this is done by calling the constructor that accepts a `double`.
- [2] Uses the `operator string()` conversion operator.
- [3] Uses the `operator double()` conversion operator. Note that because this conversion operator is now declared *explicit*, the cast is required.
- [4] Uses the implicit conversion of `3.3` to a `SpreadsheetCell`, followed by `operator+` on two `SpreadsheetCells`, followed by a required *explicit* cast to invoke `operator double()`.

Conversions for Boolean Expressions

Sometimes it is useful to be able to use objects in Boolean expressions. For example, programmers often use pointers in conditional statements like this:

```
if (ptr != nullptr) { /* Perform some dereferencing action. */ }
```

Sometimes they write shorthand conditions such as this:

```
if (ptr) { /* Perform some dereferencing action. */ }
```

Other times, you see code as follows:

```
if (!ptr) { /* Do something. */ }
```

Currently, none of the preceding expressions compile with the `Pointer` smart pointer class template defined earlier. However, you can add a conversion operator to the class to convert it to a pointer type. Then, the comparisons to `nullptr`, as well as the object alone in an `if` statement, will trigger the conversion to the pointer type. The usual pointer type for the conversion operator is `void*` because that's a pointer type with which you cannot do much except test it in Boolean expressions. Here is the implementation:

```
template <typename T> Pointer<T>::operator void*() const
{
    return mPtr;
}
```

Now the following code compiles and does what you expect:

```
void process(Pointer<SpreadsheetCell>& p)
{
    if (p != nullptr) { cout << "not nullptr" << endl; }
    if (p != NULL) { cout << "not NULL" << endl; }
    if (p) { cout << "not nullptr" << endl; }
    if (!p) { cout << "nullptr" << endl; }
}

int main()
{
    Pointer<SpreadsheetCell> smartCell(nullptr);
    process(smartCell);
    cout << endl;

    Pointer<SpreadsheetCell> anotherSmartCell(new SpreadsheetCell(5.0));
    process(anotherSmartCell);
}
```

The output is as follows:

```
nullptr

not nullptr
not NULL
not nullptr
```

Another alternative is to overload operator `bool()` as follows instead of operator `void*()`. After all, you're using the object in a Boolean expression; why not convert it directly to a `bool`?

```
template <typename T> Pointer<T>::operator bool() const
{
    return mPtr != nullptr;
}
```

The following comparisons still work:

```
if (p != NULL) { cout << "not NULL" << endl; }
if (p) { cout << "not nullptr" << endl; }
if (!p) { cout << "nullptr" << endl; }
```

However, with operator `bool()`, the following comparison with `nullptr` results in a compilation error:

```
if (p != nullptr) { cout << "not nullptr" << endl; } // Error
```

This is correct behavior because `nullptr` has its own type called `nullptr_t`, which is not automatically converted to the integer `0` (`false`). The compiler cannot find an operator `!=` that takes a `Pointer` object and a `nullptr_t` object. You could implement such an operator `!=` as a friend of the `Pointer` class:

```
template <typename T>
class Pointer
{
public:
    // Omitted for brevity
    template <typename T>
    friend bool operator!=(const Pointer<T>& lhs, std::nullptr_t rhs);
    // Omitted for brevity
};

template <typename T>
bool operator!=(const Pointer<T>& lhs, std::nullptr_t rhs)
{
    return lhs.mPtr != rhs;
}
```

However, after implementing this operator `!=`, the following comparison stops working, because the compiler no longer knows which operator `!=` to use.

```
if (p != NULL) { cout << "not NULL" << endl; }
```

From this example, you might conclude that the operator `bool()` technique only seems appropriate for objects that don't represent pointers and for which conversion to a pointer type really doesn't make sense. Unfortunately, adding a conversion operator to `bool` presents some other unanticipated consequences. C++ applies "promotion" rules to silently convert `bool` to `int` whenever the opportunity arises. Therefore, with the operator `bool()`, the following code compiles and runs:

```
Pointer<SpreadsheetCell> anotherSmartCell(new SpreadsheetCell(5.0));
int i = anotherSmartCell; // Converts Pointer to bool to int.
```

That's usually not behavior that you expect or desire. To prevent such assignments, you could explicitly delete the conversion operators to `int`, `long`, `long long`, and so on. However, this is getting messy. So, many programmers prefer operator `void*()` instead of operator `bool()`.

As you can see, there is a design element to overloading operators. Your decisions about which operators to overload directly influence the ways in which clients can use your classes.

OVERLOADING THE MEMORY ALLOCATION AND DEALLOCATION OPERATORS

C++ gives you the ability to redefine the way memory allocation and deallocation work in your programs. You can provide this customization both on the global level and the class level. This capability is most useful when you are worried about memory fragmentation, which can occur if you allocate and deallocate a lot of small objects. For example, instead of going to the default C++ memory allocation each time you need memory, you could write a memory pool allocator that reuses fixed-size chunks of memory. This section explains the subtleties of the memory allocation and deallocation routines and shows you how to customize them. With these tools, you should be able to write your own allocator if the need ever arises.

WARNING *Unless you know a lot about memory allocation strategies, attempts to overload the memory allocation routines are rarely worth the trouble. Don't overload them just because it sounds like a neat idea. Only do so if you have a genuine requirement and the necessary knowledge.*

How new and delete Really Work

One of the trickiest aspects of C++ is the details of `new` and `delete`. Consider this line of code:

```
SpreadsheetCell* cell = new SpreadsheetCell();
```

The part “`new SpreadsheetCell()`” is called the *new-expression*. It does two things. First, it allocates space for the `SpreadsheetCell` object by making a call to operator `new`. Second, it calls the constructor for the object. Only after the constructor has completed does it return the pointer to you.

`delete` works analogously. Consider this line of code:

```
delete cell;
```

This line is called the *delete-expression*. It first calls the destructor for `cell`, and then calls operator `delete` to free the memory.

You can overload operator `new` and operator `delete` to control memory allocation and deallocation, but you cannot overload the *new-expression* or the *delete-expression*. Thus, you can customize the actual memory allocation and deallocation, but not the calls to the constructor and destructor.

The New-Expression and operator new

There are six different forms of the *new-expression*, each of which has a corresponding operator `new`. Earlier chapters in this book already show four `new`-expressions: `new`, `new[]`, `new(nothrow)`, and `new(nothrow) []`. The following list shows the corresponding four operator `new` forms from the `<new>` header file:

```
void* operator new(size_t size);
void* operator new[](size_t size);
void* operator new(size_t size, const std::nothrow_t&) noexcept;
void* operator new[](size_t size, const std::nothrow_t&) noexcept;
```

There are two special `new`-expressions that do no allocation, but invoke the constructor on an existing piece of storage. These are called *placement new operators* (including both single and array forms). They allow you to construct an object in preexisting memory like this:

```
void* ptr = allocateMemorySomehow();
SpreadsheetCell* cell = new (ptr) SpreadsheetCell();
```

This feature is a bit obscure, but it's important to realize that it exists. It can come in handy if you want to implement memory pools such that you reuse memory without freeing it in between. The corresponding operator `new` forms look as follows; however, the C++ standard forbids you from overloading them.

```
void* operator new(size_t size, void* p) noexcept;
void* operator new[](size_t size, void* p) noexcept;
```

The Delete-Expression and operator delete

There are only two different forms of the *delete-expression* that you can call: `delete`, and `delete[]`; there are no `nothrow` or `placement` forms. However, there are all six forms of operator `delete`. Why the asymmetry? The two `nothrow` and two `placement` forms are used only if an exception is thrown from a constructor. In that case, the operator `delete` is called that matches the operator `new` that was used to allocate the memory prior to the constructor call. However, if you `delete` a pointer normally, `delete` will call either operator `delete` or operator `delete[]` (never the `nothrow` or `placement` forms). Practically, this doesn't really matter because the C++ standard says that throwing an exception from `delete` results in undefined behavior. This means `delete` should never throw an exception anyway, so the `nothrow` version of operator `delete` is superfluous. Also, `placement delete` should be a no-op, because the memory wasn't allocated in `placement new`, so there's nothing to free. Here are the prototypes for the operator `delete` forms:

```
void operator delete(void* ptr) noexcept;
void operator delete[](void* ptr) noexcept;
void operator delete(void* ptr, const std::nothrow_t&) noexcept;
void operator delete[](void* ptr, const std::nothrow_t&) noexcept;
void operator delete(void* p, void*) noexcept;
void operator delete[](void* p, void*) noexcept;
```

Overloading operator new and operator delete

You can actually replace the global operator `new` and operator `delete` routines if you want. These functions are called for every `new`-expression and `delete`-expression in the program, unless there are

more specific routines in individual classes. However, to quote Bjarne Stroustrup, “. . . replacing the global operator `new` and operator `delete` is not for the fainthearted.” (*The C++ Programming Language*, third edition, Addison-Wesley, 1997). I don’t recommend it either!

WARNING *If you fail to heed my advice and decide to replace the global operator `new`, keep in mind that you cannot put any code in the operator that makes a call to `new` because this will cause an infinite recursion. For example, you cannot write a message to the console with `cout`.*

A more useful technique is to overload operator `new` and operator `delete` for specific classes. These overloaded operators will be called only when you allocate and deallocate objects of that particular class. Here is an example of a class that overloads the four non-placement forms of operator `new` and operator `delete`:

```
#include <cstddef>
#include <new>

class MemoryDemo
{
public:
    virtual ~MemoryDemo() = default;

    void* operator new(size_t size);
    void operator delete(void* ptr) noexcept;

    void* operator new[](size_t size);
    void operator delete[](void* ptr) noexcept;

    void* operator new(size_t size, const std::nothrow_t&) noexcept;
    void operator delete(void* ptr, const std::nothrow_t&) noexcept;

    void* operator new[](size_t size, const std::nothrow_t&) noexcept;
    void operator delete[](void* ptr, const std::nothrow_t&) noexcept;
};
```

Here are implementations of these operators that simply pass the arguments through to calls to the global versions of the operators. Note that `nothrow` is actually a variable of type `nothrow_t`:

```
void* MemoryDemo::operator new(size_t size)
{
    cout << "operator new" << endl;
    return ::operator new(size);
}
void MemoryDemo::operator delete(void* ptr) noexcept
{
    cout << "operator delete" << endl;
    ::operator delete(ptr);
}
void* MemoryDemo::operator new[](size_t size)
{
```

```

        cout << "operator new[]" << endl;
        return ::operator new[] (size);
    }
    void MemoryDemo::operator delete[] (void* ptr) noexcept
    {
        cout << "operator delete[]" << endl;
        ::operator delete[] (ptr);
    }
    void* MemoryDemo::operator new(size_t size, const nothrow_t&) noexcept
    {
        cout << "operator new nothrow" << endl;
        return ::operator new(size, nothrow);
    }
    void MemoryDemo::operator delete(void* ptr, const nothrow_t&) noexcept
    {
        cout << "operator delete nothrow" << endl;
        ::operator delete(ptr, nothrow);
    }
    void* MemoryDemo::operator new[] (size_t size, const nothrow_t&) noexcept
    {
        cout << "operator new[] nothrow" << endl;
        return ::operator new[] (size, nothrow);
    }
    void MemoryDemo::operator delete[] (void* ptr, const nothrow_t&) noexcept
    {
        cout << "operator delete[] nothrow" << endl;
        ::operator delete[] (ptr, nothrow);
    }
}

```

Here is some code that allocates and frees objects of this class in several ways:

```

MemoryDemo* mem = new MemoryDemo();
delete mem;
mem = new MemoryDemo[10];
delete [] mem;
mem = new (nothrow) MemoryDemo();
delete mem;
mem = new (nothrow) MemoryDemo[10];
delete [] mem;

```

Here is the output from running the program:

```

operator new
operator delete
operator new[]
operator delete[]
operator new nothrow
operator delete
operator new[] nothrow
operator delete[]

```

These implementations of `operator new` and `operator delete` are obviously trivial and not particularly useful. They are intended only to give you an idea of the syntax in case you ever want to implement nontrivial versions of them.

WARNING *Whenever you overload operator new, overload the corresponding form of operator delete. Otherwise, memory will be allocated as you specify but freed according to the built-in semantics, which may not be compatible.*

It might seem overkill to overload all of the various forms of operator new. However, it's generally a good idea to do so in order to prevent inconsistencies in the memory allocations. If you don't want to provide implementations for certain forms, you can explicitly delete these using =delete in order to prevent anyone from using them. See the next section for more information.

WARNING *Overload all forms of operator new, or explicitly delete forms that you don't want to get used, to prevent inconsistencies in the memory allocations.*

Explicitly Deleting/Defaulting operator new and operator delete

Chapter 8 shows how you can explicitly delete or default a constructor or assignment operator. Explicitly deleting or defaulting is not limited to constructors and assignment operators. For example, the following class deletes the operator new and new[], which means that this class cannot be dynamically created using new or new[]:

```
class MyClass
{
    public:
        void* operator new(size_t size) = delete;
        void* operator new[](size_t size) = delete;
};
```

Using this class in the following ways results in compilation errors:

```
int main()
{
    MyClass* p1 = new MyClass;
    MyClass* pArray = new MyClass[2];
    return 0;
}
```

Overloading operator new and operator delete with Extra Parameters

In addition to overloading the standard forms of operator new, you can write your own versions with extra parameters. These extra parameters can be useful for passing various flags or counters to your memory allocation routines. For instance, some runtime libraries use this in debug mode to

provide the filename and line number where an object is allocated, so when there is a memory leak, the offending line that did the allocation can be identified.

As an example, here are the prototypes for an additional `operator new` and `operator delete` with an extra integer parameter for the `MemoryDemo` class:

```
void* operator new(size_t size, int extra);
void operator delete(void* ptr, int extra) noexcept;
```

The implementation is as follows:

```
void* MemoryDemo::operator new(size_t size, int extra)
{
    cout << "operator new with extra int: " << extra << endl;
    return ::operator new(size);
}
void MemoryDemo::operator delete(void* ptr, int extra) noexcept
{
    cout << "operator delete with extra int: " << extra << endl;
    return ::operator delete(ptr);
}
```

When you write an overloaded `operator new` with extra parameters, the compiler automatically allows the corresponding `new`-expression. The extra arguments to `new` are passed with function call syntax (as with `nothrow` versions). So, you can now write code like this:

```
MemoryDemo* memp = new(5) MemoryDemo();
delete memp;
```

The output is as follows:

```
operator new with extra int: 5
operator delete
```

When you define an `operator new` with extra parameters, you should also define the corresponding `operator delete` with the same extra parameters. You cannot call this `operator delete` with extra parameters yourself, but it will be called only when you use your `operator new` with extra parameters and the constructor of your object throws an exception.

Overloading operator delete with Size of Memory as Parameter

An alternate form of `operator delete` gives you the size of the memory that should be freed as well as the pointer. Simply declare the prototype for `operator delete` with an extra size parameter.

WARNING *If your class declares two identical versions of `operator delete` except that one takes the size parameter and the other doesn't, the version without the size parameter will always get called. If you want the version with the size parameter to be used, write only that version.*

You can replace `operator delete` with the version that takes a size for any of the versions of `operator delete` independently. Here is the `MemoryDemo` class definition with the first `operator delete` modified to take the size of the memory to be deleted:

```
class MemoryDemo
{
public:
    // Omitted for brevity
    void* operator new(size_t size);
    void operator delete(void* ptr, size_t size) noexcept;
    // Omitted for brevity
};
```

The implementation of this `operator delete` calls the global `operator delete` without the size parameter because there is no global `operator delete` that takes the size:

```
void MemoryDemo::operator delete(void* ptr, size_t size) noexcept
{
    cout << "operator delete with size " << size << endl;
    ::operator delete(ptr);
}
```

This capability is useful only if you are writing a complicated memory allocation and deallocation scheme for your classes.

SUMMARY

This chapter summarized the rationale for operator overloading and provided examples and explanations for overloading the various categories of operators. Hopefully, this chapter taught you to appreciate the power that it gives you. Throughout this book, operator overloading is used to provide abstractions and easy-to-use class interfaces.

Now it's time to start delving into the C++ Standard Library. The next chapter starts with an overview of the functionality provided by the C++ Standard Library, followed by chapters that go deeper into specific features of the library.

16

Overview of the C++ Standard Library

WHAT'S IN THIS CHAPTER?

- ▶ The coding principles used throughout the Standard Library
- ▶ The kind of functionality the Standard Library provides

WROX.COM DOWNLOADS FOR THIS CHAPTER

Please note that all the code examples for this chapter are available as a part of this chapter's code download on the book's website at www.wrox.com/go/proc++4e on the Download Code tab.

The most important library that you will use as a C++ programmer is the C++ Standard Library. As its name implies, this library is part of the C++ standard, so any standards-conforming compiler should include it. The Standard Library is not monolithic: it includes several disparate components, some of which you have been using already. You may even have assumed they were part of the core language. All Standard Library classes and functions are declared in the `std` namespace, or a sub-namespace of `std`.

The heart of the C++ Standard Library is its generic *containers* and *algorithms*. Some people still call this subset of the library the *Standard Template Library*, or STL for short, because originally it was based on a third-party library called the Standard Template Library which used templates abundantly. However, STL is not a term defined by the C++ standard itself, so this book does not use it. The power of the Standard Library is that it provides generic containers and generic algorithms in such a way that most of the algorithms work on most of the containers, no matter what type of data the containers store. Performance is a very important aspect of the Standard Library. The goal is to make the Standard Library containers and algorithms as fast as, or faster than hand-written code.

The C++17 Standard Library also includes most of the C headers that are part of the C11 standard, but with new names.¹ For example, you can access the functionality from the C `<stdio.h>` header by including `<cstdio>`, which also puts everything in the `std` namespace. C++17 has deprecated the use of the C headers `<complex.h>`, `<ccomplex>`, `<tgmath.h>`, and `<ctgmath>`. These headers don't contain any C functionality, and simply include equivalent functionality from other C++ headers (`<complex>` and `<cmath>`). The C headers `<iso646.h>`, `<stdalign.h>`, `<stdbool.h>`, and their `<xyz>` equivalents are useless in C++ as these define macros that are keywords in C++.

NOTE *The use of any functionality provided by C headers is discouraged in favor of true C++ functionality.*

A C++ programmer who wishes to claim language expertise is expected to be familiar with the Standard Library. You can save yourself immeasurable time and energy by incorporating Standard Library containers and algorithms into your programs instead of writing and debugging your own versions. Now is the time to master this Standard Library.

This first chapter on the Standard Library provides a general overview of the available functionality. The next few chapters go into more detail on several aspects of the Standard Library, including containers, iterators, generic algorithms, predefined function object classes, regular expressions, filesystem support, random number generation, and much more. I also discuss customizing and extending the library.

Despite the depth of material found in this and the following chapters, the Standard Library is too large for this book to cover exhaustively. You should read these chapters to learn about the Standard Library, but keep in mind that they don't mention every method and data member that the various classes provide, or show you the prototypes of every algorithm. Appendix C provides a summary of all the header files in the Standard Library. Consult a Standard Library Reference, such as the “C++ Standard Library Quick Reference” book, or the online resources <http://www.cppreference.com/> or <http://www.cplusplus.com/reference/>, for a complete reference of all provided functionality.

CODING PRINCIPLES

The Standard Library makes heavy use of the C++ features called *templates* and *operator overloading*.

Use of Templates

Templates are used to allow *generic programming*. They make it possible to write code that can work with all kinds of objects, even objects unknown to the programmer when writing the code. The obligation of the programmer writing the template code is to specify the requirements of the classes that define these objects; for example, that they have an operator for comparison, or a copy constructor, or whatever is deemed appropriate, and then making sure the code that is written uses only those required capabilities. The obligation of the programmer creating the objects is to supply those operators and methods that the template writer requires.

¹The C11 headers `<stdatomic.h>`, `<stdnoreturn.h>`, `<threads.h>`, and their `<xyz>` equivalents are not included in the C++ standard.

Unfortunately, many programmers consider templates to be the most difficult part of C++ and, for that reason, tend to avoid them. However, even if you never write your own templates, you need to understand their syntax and capabilities in order to use the Standard Library. Templates are described in detail in Chapter 12. If you skipped that chapter and are not familiar with templates, I suggest you first read Chapter 12, and then come back to learn more about the Standard Library.

Use of Operator Overloading

Operator overloading is another feature used extensively by the C++ Standard Library. Chapter 9 has a whole section devoted to operator overloading. Make sure you read that section and understand it before tackling this and subsequent chapters. In addition, Chapter 15 presents much more detail on the subject of operator overloading, but those details are not required to understand the following chapters.

OVERVIEW OF THE C++ STANDARD LIBRARY

This section introduces the various components of the Standard Library from a design perspective. You will learn what facilities are available for you to use, but you will not learn the coding details. Those details are covered in other chapters.

Strings

C++ provides a built-in `string` class, defined in the `<string>` header. Although you may still use C-style strings of character arrays, the C++ `string` class is superior in almost every way. It handles the memory management; provides some bounds checking, assignment semantics, and comparisons; and supports manipulations such as concatenation, substring extraction, and substring or character replacement.

NOTE *Technically, `std::string` is a type alias for a `char` instantiation of the `std::basic_string` template. However, you need not worry about these details; you can use `string` as if it were a bona fide non-template class.*

The Standard Library also provides a `string_view` class, defined in `<string_view>`. It is a read-only view of all kind of string representations, and can be used as a drop-in replacement for `const string&`, but without the overhead. It never copies strings!

C++ provides support for *Unicode* and *localization*. These features allow you to write programs that work with different languages, for example, Chinese. Locales, defined in `<locale>`, allow you to format data such as numbers and dates according to the rules of a certain country or region.

In case you missed it, Chapter 2 provides all the details of the `string` and `string_view` classes, while Chapter 19 discusses Unicode and localization.

Regular Expressions

Regular expressions are available through the `<regex>` header file. They make it easy to perform so-called *pattern-matching*, often used in text processing. Pattern-matching allows you to search special patterns in strings and optionally to replace them with a new pattern. Regular expressions are discussed in Chapter 19.

I/O Streams

C++ includes a model for input and output called *streams*. The C++ library provides routines for reading and writing built-in types from and to files, console/keyboard, and strings. C++ also provides the facilities for coding your own routines for reading and writing your own objects. The I/O functionality is defined in several header files: `<fstream>`, `<iomanip>`, `<ios>`, `<iosfwd>`, `<iostream>`, `<istream>`, `<ostream>`, `<sstream>`, `<streambuf>`, and `<strstream>`. Chapter 1 reviews the basics of I/O streams, and Chapter 13 discusses streams in detail.

Smart Pointers

One of the problems faced in robust programming is knowing when to delete an object. There are several failures that can happen. A first problem is not deleting the object at all (failing to free the storage). These are known as *memory leaks*, where objects accumulate and take up space but are not used. Another problem is where a piece of code deletes the storage while another piece of code is still pointing to that storage, resulting in pointers to storage that either is no longer in use or has been reallocated for another purpose. These are known as *dangling pointers*. One more problem is when one piece of code frees the storage, and another piece of code attempts to free the same storage. This is known as *double-freeing*. All of these problems tend to result in program failures of some sort. Some failures are readily detected; others cause the program to produce erroneous results. Most of these errors are difficult to discover and repair.

C++ addresses these problems with smart pointers: `unique_ptr`, `shared_ptr`, and `weak_ptr`. `shared_ptr` and `weak_ptr` are thread-safe. They are all defined in the `<memory>` header. These smart pointers are introduced in Chapter 1 and discussed in more detail in Chapter 7.

Before C++11, the functionality of `unique_ptr` was handled by a type called `auto_ptr`, which has been removed from C++17 and should not be used anymore. There was no equivalent to `shared_ptr` in the earlier Standard Library, although many third-party libraries (for example, Boost) did provide this capability.

Exceptions

The C++ language supports exceptions, which allow functions or methods to pass errors of various types up to calling functions or methods. The C++ Standard Library provides a class hierarchy of exceptions that you can use in your code as is, or that you can derive from to create your own exception types. Exception support is defined in a couple of header files: `<exception>`, `<stdexcept>`, and `<system_error>`. Chapter 14 covers the details of exceptions and the standard exception classes.

Mathematical Utilities

The C++ Standard Library provides a collection of mathematical utility classes and functions.

A whole range of common mathematical functions is available, such as `abs()`, `remainder()`, `fma()`, `exp()`, `log()`, `pow()`, `sqrt()`, `sin()`, `atan2()`, `sinh()`, `erf()`, `tgamma()`, `ceil()`, `floor()`, and more. C++17 adds a number of special mathematical functions to work with Legendre polynomials, beta functions, elliptic integrals, Bessel functions, cylindrical Neumann functions, and so on.

There is a complex number class called `complex`, defined in `<complex>`, which provides an abstraction for working with numbers that contain both real and imaginary components.

The compile-time rational arithmetic library provides a `ratio` class template, defined in the `<ratio>` header file. This `ratio` class template can exactly represent any finite rational number defined by a numerator and denominator. This library is discussed in Chapter 20.

The Standard Library also contains a class called `valarray`, defined in `<valarray>`, which is similar to the `vector` class but is more optimized for high-performance numerical applications. The library provides several related classes to represent the concept of vector slices. From these building blocks, it is possible to build classes to perform matrix mathematics. There is no built-in matrix class; however, there are third-party libraries like Boost that include matrix support. The `valarray` class is not further discussed in this book.

C++ also provides a standard way to obtain information about numeric limits, such as the maximum possible value for an integer on the current platform. In C, you could access `#defines`, such as `INT_MAX`. While those are still available in C++, it's recommended to use the `numeric_limits` class template defined in the `<limits>` header file. Its use is straightforward, as shown in the following code:

```
cout << "int:" << endl;
cout << "Max int value: " << numeric_limits<int>::max() << endl;
cout << "Min int value: " << numeric_limits<int>::min() << endl;
cout << "Lowest int value: " << numeric_limits<int>::lowest() << endl;

cout << endl << "double:" << endl;
cout << "Max double value: " << numeric_limits<double>::max() << endl;
cout << "Min double value: " << numeric_limits<double>::min() << endl;
cout << "Lowest double value: " << numeric_limits<double>::lowest() << endl;
```

The output of this code snippet on my system is as follows:

```
int:
Max int value: 2147483647
Min int value: -2147483648
Lowest int value: -2147483648

double:
Max double value: 1.79769e+308
Min double value: 2.22507e-308
Lowest double value: -1.79769e+308
```

Note the differences between `min()` and `lowest()`. For an integer, the minimum value equals the lowest value. However, for floating-point types, the minimum value is the smallest positive value that can be represented, while the lowest value is the most negative value representable, which equals `-max()`.

Time Utilities

C++ includes the chrono library, defined in the `<chrono>` header file. This library makes it easy to work with time; for example, to time certain durations, or to perform actions based on timing. The chrono library is discussed in detail in Chapter 20. Other time and date utilities are provided in the `<ctime>` header.

Random Numbers

C++ already has support for generating pseudo-random numbers for a long time with the `srand()` and `rand()` functions. However, those functions provide only very basic random numbers. For example, you cannot change the distribution of the generated random numbers.

Since C++11, a random number library has been added to the standard, which is much more powerful. The new library is defined in `<random>`, and comes with *random number engines*, *random number engine adaptors*, and *random number distributions*. All of these can be used to give you random numbers more suited to your problem domain, such as normal distributions, negative exponential distributions, and so on.

Consult Chapter 20 for details on this library.

Initializer Lists

Initializer lists are defined in the `<initializer_list>` header file. They make it easy to write functions that can accept a variable number of arguments and are discussed in Chapter 1.

Pair and Tuple

The `<utility>` header defines the `pair` template, which can store two elements with two different types. This is known as storing *heterogeneous* elements. All Standard Library containers discussed further in this chapter store *homogeneous* elements, meaning that all the elements in the container must have the same type. A `pair` allows you to store exactly two elements of completely unrelated types in one object. The `pair` class template is discussed in more detail in Chapter 17.

`tuple`, defined in `<tuple>`, is a generalization of `pair`. It is a sequence with a fixed size that can have heterogeneous elements. The number and type of elements for a `tuple` instantiation is fixed at compile time. Tuples are discussed in Chapter 20.

C++17

optional, variant, and any

C++17 introduces the following new classes:

- `optional`, defined in `<optional>`, holds a value of a specific type, or nothing. It can be used for parameters or return types of a function if you want to allow for values to be optional.

- `variant`, defined in `<variant>`, can hold a single value of one of a given set of types, or nothing.
- `any`, defined in `<any>`, is a class that can contain a single value of any type.

These three types are discussed in Chapter 20.

Function Objects

A class that implements a function call operator is called a *function object*. Function objects can, for example, be used as predicates for certain Standard Library algorithms. The `<functional>` header file defines a number of predefined function objects and supports creating new function objects based on existing ones.

Function objects are discussed in detail in Chapter 18 together with the Standard Library algorithms.



Filesystem

C++17 introduces a filesystem support library. Everything is defined in the `<filesystem>` header, and lives in the `std::filesystem` namespace. It allows you to write portable code to work with a filesystem. You can use it for querying whether something is a directory or a file, iterating over the contents of a directory, manipulating paths, and retrieving information about files such as their size, extension, creation time, and so on. This filesystem support library is discussed in Chapter 20.

Multithreading

All major CPU vendors are selling processors with multiple cores. They are being used for everything from servers to consumer computers and even smartphones. If you want your software to take advantage of all these cores, then you need to write multithreaded code. The Standard Library provides a couple of basic building blocks for writing such code. Individual threads can be created using the `thread` class from the `<thread>` header.

In multithreaded code you need to take care that several threads are not reading and writing to the same piece of data at the same time. To prevent this, you can use atomics, defined in `<atomic>`, which give you thread-safe atomic access to a piece of data. Other thread synchronization mechanisms are provided by `<condition_variable>` and `<mutex>`.

If you just need to calculate something, possibly on a different thread, and get the result back with proper exception handling, you can use `async` and `future`. These are defined in the `<future>` header, and are easier to use than directly using the `thread` class.

Writing multithreaded code is discussed in detail in Chapter 23.

Type Traits

Type traits are defined in the `<type_traits>` header file and provide information about types at compile time. They are useful when writing advanced templates and are discussed in Chapter 22.

Standard Integer Types

The `<cstdint>` header file defines a number of standard integer types such as `int8_t`, `int64_t` and so on. It also includes macros specifying minimum and maximum values of those types. These integer types are discussed in the context of writing cross-platform code in Chapter 30.

Containers

The Standard Library provides implementations of commonly used data structures such as linked lists and queues. When you use C++, you should not need to write such data structures again. The data structures are implemented using a concept called *containers*, which store information called *elements*, in a way that implements the data structure (linked list, queue, and so on) appropriately. Different data structures have different insertion, deletion, and access behavior and performance characteristics. It is important to be familiar with the available data structures so that you can choose the most appropriate one for any given task.

All the containers in the Standard Library are class templates, so you can use them to store any type, from built-in types such as `int` and `double` to your own classes. Each container instance stores objects of only one type; that is, they are *homogeneous collections*. If you need non-fixed-sized heterogeneous collections, you can wrap each element in an `std::any` instance and store those any instances in a container. Alternatively, you can store `std::variant` instances in a container. A `variant` can be used if the number of different required types is limited and known at compile time. Both `any` and `variant` are introduced with C++17, and are discussed in Chapter 20. If you needed heterogeneous collections before C++17, you could create a class that had multiple derived classes, and each derived class could wrap an object of your required type.

NOTE *The C++ Standard Library containers are homogeneous: they allow elements of only one type in each container.*

Note that the C++ standard specifies the *interface*, but not the *implementation*, of each container and algorithm. Thus, different vendors are free to provide different implementations. However, the standard also specifies performance requirements as part of the interface, which the implementations must meet.

This section provides an overview of the various containers available in the Standard Library.

vector

The `<vector>` header file defines `vector`, which stores a sequence of elements and provides random access to these elements. You can think of a `vector` as an array of elements that grows dynamically as you insert elements, and additionally provides some bounds checking. Like an array, the elements of a `vector` are stored in contiguous memory.

NOTE *A vector in C++ is a synonym for a dynamic array: an array that grows and shrinks automatically in response to the number of elements it stores.*

vectors provide fast element insertion and deletion (amortized constant time) at the end of the vector. Amortized constant time insertion means that most of the time insertions are done in constant time $O(1)$ (Chapter 4 explains big-O notation). However, sometimes the vector needs to grow in size to accommodate new elements, which has a complexity of $O(N)$. On average, this results in $O(1)$ complexity or amortized constant time. Details are explained in Chapter 17. A vector has slower (linear time) insertion and deletion anywhere else, because the operation must move all the elements “up” or “down” by one to make room for the new element or to fill the space left by the deleted element. Like arrays, vectors provide fast (constant time) access to any of their elements.

Even though inserting and removing elements in the middle of a vector requires moving other elements up or down, a vector should be your default container! Often, a vector will be faster than, for example, a linked list, even for inserting and removing elements in the middle. The reason is that a vector is stored contiguously in memory, while a linked list is scattered around in memory. Computers are extremely efficient to work with contiguous data, which makes vector operations fast. You should only use something like a linked list if a performance profiler (discussed in Chapter 25) tells you that it performs better than a vector.

NOTE *The vector container should be your default container.*

There is a template specialization available for `vector<bool>` to store Boolean values in a vector. This specialization optimizes space allocation for the Boolean elements; however, the standard does not specify how an implementation of `vector<bool>` should optimize space. The difference between the `vector<bool>` specialization and the `bitset` discussed further in this chapter is that the `bitset` container is of fixed size.

list

A Standard Library `list` is a *doubly linked list* structure and is defined in `<list>`. Like an array or vector, it stores a sequence of elements. However, unlike an array or vector, the elements of a `list` are not necessarily contiguous in memory. Instead, each element in the `list` specifies where to find the next and previous elements in the `list` (usually via pointers), hence the name *doubly linked list*.

The performance characteristics of a `list` are the exact opposite of a vector. They provide slow (linear time) element lookup and access, but quick (constant time) insertion and deletion of elements once the relevant position has been found. Still, as discussed in the previous section, a vector is usually faster than a `list`. Use a profiler to be sure.

forward_list

The `forward_list`, defined in `<forward_list>`, is a *singly linked list*, compared to the `list` container, which is doubly linked. `forward_list` supports forward iteration only, and requires less memory than a `list`. Like lists, `forward_lists` allow constant time insertion and deletion anywhere once the relevant position has been found, and there is no fast random access to elements.

deque

The name `deque` is an abbreviation for a *double-ended queue*. A `deque`, defined in `<deque>`, provides quick (constant time) element access. It also provides fast (constant time) insertion and deletion at both ends of the sequence, but it provides slow (linear time) insertion and deletion in the middle of the sequence. The elements of a `deque` are not stored contiguously in memory, and thus a `deque` might be slower than a `vector`.

You could use a `deque` instead of a `vector` when you need to insert or remove elements from either end of the sequence but still need fast access to all elements. However, this requirement does not apply to many programming problems; in most cases, a `vector` is recommended.

array

The `<array>` header defines `array`, which is a replacement for standard C-style arrays. Sometimes you know the exact number of elements in your container up front and you don't need the flexibility of a `vector` or a `list`, which are able to grow dynamically to accommodate new elements. An `array` is perfect for such fixed-sized collections, and it has a bit less overhead compared to a `vector`; it's basically a thin wrapper around standard C-style arrays. There are a number of advantages in using `arrays` instead of standard C-style arrays: they always know their own size, and do not automatically get cast to a pointer to avoid certain types of bugs. Also, `arrays` do not provide insertion or deletion; they have a fixed size. The advantage of having a fixed size is that this allows an `array` to be allocated on the stack, rather than always demanding heap access as `vector` does. Access to elements is very fast (constant time), just as with `vectors`.

NOTE *The `vector`, `list`, `forward_list`, `deque`, and `array` containers are called sequential containers because they store a sequence of elements.*

queue

The name `queue` comes directly from the definition of the English word *queue*, which means a line of people or objects. The `queue` container is defined in `<queue>` and provides standard *first in, first out* (or *FIFO*) semantics. A `queue` is a container in which you insert elements at one end and take them out at the other end. Both insertion (amortized constant time) and removal (constant time) of elements are quick.

You should use a `queue` structure when you want to model real-life “first-come, first-served” semantics. For example, consider a bank. As customers arrive at the bank, they get in line. As tellers become available, they serve the next customer in line, thus providing “first-come, first-served” behavior. You could implement a bank simulation by storing customer objects in a `queue`. As customers arrive at the bank, they are added to the end of the `queue`. As tellers serve customers, they start with customers at the front of the `queue`.

priority_queue

A `priority_queue`, also defined in `<queue>`, provides `queue` functionality in which each element has a priority. Elements are removed from the queue in priority order. In the case of priority ties, the

order in which elements are removed is undefined. `priority_queue` insertion and deletion are generally slower than simple `queue` insertion and deletion, because the elements must be reordered to support the priority ordering.

You can use `priority_queues` to model “queues with exceptions.” For example, in the preceding bank simulation, suppose that customers with business accounts take priority over regular customers. Many real-life banks implement this behavior with two separate lines: one for business customers and one for everyone else. Any customers in the business queue are taken before customers in the other line. However, banks could also provide this behavior with a single line in which business customers move to the front of the line ahead of any non-business customers. In your program, you could use a `priority_queue` in which customers have one of two priorities: business or regular. All business customers would be serviced before all regular customers.

stack

The `<stack>` header defines the `stack` class, which provides standard *first-in, last-out (FILO)* semantics, also known as *last-in, first-out (LIFO)*. Like a `queue`, elements are inserted and removed from the container. However, in a `stack`, the most recent element inserted is the first one removed. The name `stack` derives from a visualization of this structure as a stack of objects in which only the top object is visible. When you add an object to the stack, you hide all the objects underneath it.

The `stack` container provides fast (constant time) insertion and removal of elements. You should use the `stack` structure when you want FILO semantics. For example, an error-processing tool might want to store errors on a `stack` so that the most recent error is the first one available for a human administrator to read. Processing errors in a FILO order is often useful because newer errors sometimes obviate older ones.

NOTE *Technically, the `queue`, `priority_queue`, and `stack` containers are container adaptors. They are simple interfaces built on top of one of the standard sequential containers `vector`, `list`, or `deque`.*

set and multiset

The `set` class template is defined in the `<set>` header file, and, as the name suggests, it is a set of elements, loosely analogous to the notion of a mathematical set: each element is unique, and there is at most one instance of the element in the set. One difference between the mathematical concept of set, and `set` as implemented in the Standard Library, is that in the Standard Library the elements are kept in an order. The reason for the order is that when the client enumerates the elements, they come out in the ordering imposed by the type's `operator<` or a user-defined comparator. The `set` provides logarithmic insertion, deletion, and lookup. This means that, in theory, insertions and deletions are faster than for a `vector` but slower than for a `list`; while lookups are faster than for a `list`, but slower than for a `vector`. As always, use a profiler to make sure which container is faster for your use case.

You could use a `set` when you need the elements to be in an order, to have equal amounts of insertion/deletion and lookups, and you want to optimize performance for both as much as possible.

For example, an inventory-tracking program in a busy bookstore might want to use a `set` to store the books. The list of books in stock must be updated whenever books arrive or are sold, so insertion and deletion should be quick. Customers also need the ability to look for a specific book, so the program should provide fast lookup as well.

NOTE *A `set` could be an option instead of a `vector` or `list` if you need order and want equal performance for insertion, deletion, and lookup. It could also be an option if you want to enforce that there are no duplicate elements.*

Note that a `set` does not allow duplicate elements. That is, each element in a `set` must be unique. If you want to store duplicate elements, you must use a `multiset`, also defined in the `<set>` header file.

map and multimap

The `<map>` header defines the `map` class template, which is an *associative array*. You can use it as an array in which the index can be any type; for example, a `string`. A `map` stores key/value pairs, and keeps its elements in sorted order, based on the keys, not the values. It also provides an operator `[]`, which a `set` does not provide. In most other respects, it is identical to a `set`. You could use a `map` when you want to associate keys and values. For example, in the preceding bookstore example, you might want to store the books in a `map` where the key is the ISBN number of the book and the value is a `Book` object containing detailed information for that specific book.

A `multimap`, also defined in `<map>`, has the same relation to a `map` as a `multiset` does to a `set`. Specifically, a `multimap` is a `map` that allows duplicate keys.

NOTE *The `set` and `map` containers are called associative containers because they associate keys and values. This term is confusing when applied to `sets`, because in `sets` the keys are themselves the values. Both containers sort their elements, so they are called sorted or ordered associative containers.*

Unordered Associative Containers / Hash Tables

The Standard Library supports *hash tables*, also called *unordered associative containers*. There are four unordered associative containers:

- `unordered_map`
- `unordered_multimap`
- `unordered_set`
- `unordered_multiset`

The first two containers are defined in `<unordered_map>`, and the other two containers in `<unordered_set>`. Better names would have been `hash_map`, `hash_set`, and so on. Unfortunately, hash tables were not part of the C++ Standard Library before C++11, which means a lot of third-party libraries implemented hash tables themselves by using names with “hash” as a prefix, like `hash_map`. Because of this, the C++ standard committee decided to use the prefix “unordered” instead of “hash” to avoid name clashes.

These unordered associative containers behave similar to their ordered counterparts. An `unordered_map` is similar to a standard `map` except that the standard `map` sorts its elements while the `unordered_map` doesn’t sort its elements.

Insertion, deletion, and lookup with these unordered associative containers can be done on average in constant time. In a worst-case scenario, it will be in linear time. Lookup of elements in an unordered container can be much faster than with a normal `map` or `set`, especially when there are a lot of elements in the container.

Chapter 17 explains how these unordered associative containers work and why they are also called hash tables.

bitset

C and C++ programmers commonly store a set of flags in a single `int` or `long`, using one bit for each flag. They set and access these bits with the bitwise operators: `&`, `|`, `^`, `~`, `<<`, and `>>`. The C++ Standard Library provides a `bitset` class that abstracts this bit field manipulation, so you shouldn’t need to use the bit manipulation operators anymore.

The `<bitset>` header file defines the `bitset` container, but this is not a container in the normal sense, in that it does not implement a specific data structure in which you insert and remove elements. A `bitset` has a fixed size and does not support iterators. You can think of them as a sequence of Boolean values that you can read and write. However, unlike the C-style way of handling bits, the `bitset` is not limited to the size of an `int` or other elementary data types. Thus, you can have a 40-bit `bitset`, or a 213-bit `bitset`. The implementation will use as much storage as it needs to implement N bits when you declare your `bitset` with `bitset<N>`.

Summary of Standard Library Containers

The following table summarizes the containers provided by the Standard Library. It uses the big-O notation introduced in Chapter 4 to present the performance characteristics on a container of N elements. An N/A entry in the table means that the operation is not part of the container semantics.

CONTAINER CLASS NAME	CONTAINER TYPE	INSERT PERFORMANCE	DELETE PERFORMANCE	LOOKUP PERFORMANCE
<code>vector</code>	Sequential	Amortized $O(1)$ at the end; $O(N)$ otherwise.	$O(1)$ at the end; $O(N)$ otherwise.	$O(1)$
When to Use: This should be your default container. Only use another container after using a profiler to confirm it is faster than a <code>vector</code> .				

continues

TABLE (continued)

CONTAINER CLASS NAME	CONTAINER TYPE	INSERT PERFORMANCE	DELETE PERFORMANCE	LOOKUP PERFORMANCE
<code>list</code>	Sequential	$O(1)$ at the beginning and the end, and once you are at the position where you want to insert the element.	$O(1)$ at the beginning and the end, and once you are at the position where you want to delete the element.	$O(1)$ to access the first or last element; $O(N)$ otherwise.
When to Use: Rarely. You should use a <code>vector</code> , unless a profiler tells you a <code>list</code> is faster for your use case.				
<code>forward_list</code>	Sequential	$O(1)$ at the beginning, and once you are at the position where you want to insert the element.	$O(1)$ at the beginning, and once you are at the position where you want to delete the element.	$O(1)$ to access the first element; $O(N)$ otherwise.
When to Use: Rarely. You should use a <code>vector</code> , unless a profiler tells you a <code>forward_list</code> is faster for your use case.				
<code>deque</code>	Sequential	$O(1)$ at the beginning or end; $O(N)$ otherwise.	$O(1)$ at the beginning or end; $O(N)$ otherwise.	$O(1)$
When to Use: Not usually needed; use a <code>vector</code> instead.				
<code>array</code>	Sequential	N/A	N/A	$O(1)$
When to Use: When you need a fixed-size array to replace a standard C-style array.				
<code>queue</code>	Container adaptor	Depends on the underlying container; $O(1)$ for <code>list</code> and <code>deque</code> .	Depends on the underlying container; $O(1)$ for <code>list</code> and <code>deque</code> .	N/A
When to Use: When you want a FIFO structure.				
<code>priority_queue</code>	Container adaptor	Depends on the underlying container; amortized $O(\log(N))$ for <code>vector</code> , $O(\log(N))$ for <code>deque</code> .	Depends on the underlying container; $O(\log(N))$ for <code>vector</code> and <code>deque</code> .	N/A
When to Use: When you want a queue with priority.				

CONTAINER CLASS NAME	CONTAINER TYPE	INSERT PERFORMANCE	DELETE PERFORMANCE	LOOKUP PERFORMANCE
stack	Container adaptor	Depends on the underlying container; $O(1)$ for <code>list</code> and <code>deque</code> , amortized $O(1)$ for <code>vector</code> .	Depends on the underlying container; $O(1)$ for <code>list</code> , <code>vector</code> , and <code>deque</code> .	N/A
	When to Use: When you want a FILO/LIFO structure.			
set multiset	Sorted associative	$O(\log(N))$	$O(\log(N))$	$O(\log(N))$
	When to Use: When you want a sorted collection of elements with equal lookup, insertion, and deletion times. Use a <code>set</code> when you want a collection of elements without duplicates.			
map multimap	Sorted associative	$O(\log(N))$	$O(\log(N))$	$O(\log(N))$
	When to Use: When you want a sorted collection to associate keys with values, that is, an associative array, with equal lookup, insertion, and deletion times.			
unordered_map unordered_multimap	Unordered associative / hash table	Average case $O(1)$; worst case $O(N)$.	Average case $O(1)$; worst case $O(N)$.	Average case $O(1)$; worst case $O(N)$.
	When to Use: When you want to associate keys with values with equal lookup, insertion, and deletion times, and you don't require the elements to be sorted. Performance can be better than with a normal <code>map</code> , but that depends on the elements.			
unordered_set unordered_multiset	Unordered associative/hash table	Average case $O(1)$; worst case $O(N)$.	Average case $O(1)$; worst case $O(N)$.	Average case $O(1)$; worst case $O(N)$.
	When to Use: When you want a collection of elements with equal lookup, insertion, and deletion times, and you don't require the elements to be sorted. Performance can be better than with a normal <code>set</code> , but that depends on the elements.			
bitset	Special	N/A	N/A	$O(1)$
	When to Use: When you want a collection of flags.			

Note that `strings` are technically containers as well. They can be thought of as vectors of characters. Thus, some of the algorithms described in the material that follows also work on `strings`.

NOTE *vector should be your default container! In practice, insertion and deletion in a vector are often faster than in a list or forward_list. This is because of how memory and caches work on modern CPUs, and because of the fact that for a list or forward_list, you first need to iterate to the position where you want to insert or delete an element. Memory for a list or forward_list might be fragmented, so iteration is slower than for a vector.*

Algorithms

In addition to containers, the Standard Library provides implementations of many generic algorithms. An *algorithm* is a strategy for performing a particular task, such as sorting or searching. These algorithms are implemented as function templates, so they work on most of the different container types. Note that the algorithms are not generally part of the containers. The Standard Library takes the approach of separating the *data* (containers) from the *functionality* (algorithms). Although this approach seems counter to the spirit of object-oriented programming, it is necessary in order to support generic programming in the Standard Library. The guiding principle of *orthogonality* maintains that algorithms and containers are independent, with (almost) any algorithm working with (almost) any container.

NOTE *Although the algorithms and containers are theoretically independent, some containers provide certain algorithms in the form of class methods because the generic algorithms do not perform well on those particular containers. For example, sets provide their own `find()` algorithm that is faster than the generic `find()` algorithm. You should use the container-specific method form of the algorithm, if provided, because it is generally more efficient or appropriate for the container at hand.*

Note that the generic algorithms do not work directly on the containers. They use an intermediary called an *iterator*. Each container in the Standard Library provides an iterator that supports traversing the elements in the container in a sequence. The different iterators for the various containers adhere to standard interfaces, so algorithms can perform their work by using iterators without worrying about the underlying container implementation. The `<iterator>` header defines the following helper functions that return specific iterators for containers.

FUNCTION NAME	FUNCTION SYNOPSIS
<code>begin()</code> <code>end()</code>	Returns a non-const iterator to the first, and one past the last, element in a sequence.
<code>cbegin()</code> <code>cend()</code>	Returns a const iterator to the first, and one past the last, element in a sequence.
<code>rbegin()</code> <code>rend()</code>	Returns a non-const reverse iterator to the last, and one before the first, element in a sequence.
<code>crbegin()</code> <code>crend()</code>	Returns a const reverse iterator to the last, and one before the first, element in a sequence.

NOTE *Iterators mediate between algorithms and containers. They provide a standard interface to traverse the elements of a container in sequence, so that any algorithm can work on any container.*

This section gives an overview of what kinds of algorithms are available in the Standard Library without going into detail. Chapter 17 goes deeper into iterators, and Chapter 18 discusses a selection of algorithms with coding examples. For the exact prototypes of all the available algorithms, consult a Standard Library Reference.

There are approximately 100 algorithms in the Standard Library, depending on how you count them. The following sections divide these algorithms into different categories. The algorithms are defined in the `<algorithm>` header file unless otherwise noted. Note that whenever the following algorithms are specified as working on a “sequence” of elements, that sequence is presented to the algorithm via iterators.

NOTE *When examining the list of algorithms, remember that the Standard Library is designed with generality in mind, so it adds generality that might never be used, but which, if required, would be essential. You may not need every algorithm, or need to worry about the more obscure parameters that are there for anticipated generality. It is important only to be aware of what’s available in case you ever find it useful.*

Non-modifying Sequence Algorithms

The non-modifying algorithms are those that look at a sequence of elements and return some information about the elements. As “non-modifying” algorithms, they cannot change the values of

elements or the order of elements within the sequence. This category contains three types of algorithms. The following tables list and provide brief summaries of the various non-modifying algorithms. With these algorithms, you should rarely need to write a `for` loop to iterate over a sequence of values.

Search Algorithms

These algorithms do not require the sequence to be sorted. N is the size of the sequence to search in, and M is the size of the pattern to find.

ALGORITHM NAME	ALGORITHM SYNOPSIS	COMPLEXITY
<code>adjacent_find()</code>	Finds the first instance of two consecutive elements that are equal to each other or are equivalent to each other as specified by a predicate.	$O(N)$
<code>find()</code> <code>find_if()</code>	Finds the first element that matches a value or causes a predicate to return <code>true</code> .	$O(N)$
<code>find_first_of()</code>	Like <code>find</code> , but searches for one of several elements at the same time.	$O(NM)$
<code>find_if_not()</code>	Finds the first element that causes a predicate to return <code>false</code> .	$O(N)$
<code>find_end()</code>	Finds the last subsequence in a sequence that matches another sequence or whose elements are equivalent, as specified by a predicate.	$O(M*(N-M))$
<code>search()</code>	Finds the first subsequence in a sequence that matches another sequence or whose elements are equivalent, as specified by a predicate.*	$O(NM)^*$
<code>search_n()</code>	Finds the first instance of n consecutive elements that are equal to a given value or relate to that value according to a predicate.	$O(N)$

*Since C++17, `search()` accepts an optional extra parameter to specify the searching algorithm to use (`default_searcher`, `boyer_moore_searcher`, or `boyer_moore_horspool_searcher`). With the Boyer-Moore searchers, the worst-case complexity is $O(N+M)$ when the pattern is not found, and $O(NM)$ when the pattern is found.

Comparison Algorithms

The following comparison algorithms are provided. None of them require the source sequences to be ordered. All of them have a linear worst-case complexity.

ALGORITHM NAME	ALGORITHM SYNOPSIS
<code>equal()</code>	Determines if two sequences are equal by checking if parallel elements are equal or match a predicate.
<code>mismatch()</code>	Returns the first element in each sequence that does not match the element in the same location in the other sequence.
<code>lexicographical_compare()</code>	Compares two sequences to determine their “lexicographical” ordering. This algorithm compares each element of the first sequence with its equivalent element in the second. If one element is less than the other, that sequence is lexicographically first. If the elements are equal, it compares the next elements in order.

Counting Algorithms

ALGORITHM NAME	ALGORITHM SYNOPSIS
<code>all_of()</code>	Returns <code>true</code> if the predicate returns <code>true</code> for all the elements in the sequence or if the sequence is empty; <code>false</code> otherwise.
<code>any_of()</code>	Returns <code>true</code> if the predicate returns <code>true</code> for at least one element in the sequence; <code>false</code> otherwise.
<code>none_of()</code>	Returns <code>true</code> if the predicate returns <code>false</code> for all the elements in the sequence or if the sequence is empty; <code>false</code> otherwise.
<code>count()</code> <code>count_if()</code>	Counts the number of elements matching a value or that cause a predicate to return <code>true</code> .

Modifying Sequence Algorithms

The modifying algorithms modify some or all of the elements in a sequence. Some of them modify elements *in place*, so that the original sequence changes. Others copy the results to a different sequence, so that the original sequence remains unchanged. All of them have a linear worst-case complexity. The following table summarizes the modifying algorithms.

ALGORITHM NAME	ALGORITHM SYNOPSIS
<code>copy()</code> <code>copy_backward()</code>	Copies elements from one sequence to another.
<code>copy_if()</code>	Copies elements for which a predicate returns <code>true</code> from one sequence to another.
<code>copy_n()</code>	Copies <i>n</i> elements from one sequence to another.

continues

TABLE (continued)

ALGORITHM NAME	ALGORITHM SYNOPSIS
<code>fill()</code>	Sets all elements in the sequence to a new value.
<code>fill_n()</code>	Sets the first n elements in the sequence to a new value.
<code>generate()</code>	Calls a specified function to generate a new value for each element in the sequence.
<code>generate_n()</code>	Calls a specified function to generate a new value for the first n elements in the sequence.
<code>move()</code> <code>move_backward()</code>	Moves elements from one sequence to another. This uses efficient move semantics (see Chapter 9).
<code>remove()</code> <code>remove_if()</code> <code>remove_copy()</code> <code>remove_copy_if()</code>	Removes elements that match a given value or that cause a predicate to return <code>true</code> , either in place or by copying the results to a different sequence.
<code>replace()</code> <code>replace_if()</code> <code>replace_copy()</code> <code>replace_copy_if()</code>	Replaces all elements matching a value or that cause a predicate to return <code>true</code> with a new element, either in place or by copying the results to a different sequence.
<code>reverse()</code> <code>reverse_copy()</code>	Reverses the order of the elements in the sequence, either in place or by copying the results to a different sequence.
<code>rotate()</code> <code>rotate_copy()</code>	Swaps the first and second “halves” of the sequence, either in place or by copying the results to a different sequence. The two subsequences to be swapped need not be equal in size.
<code>sample()</code>	Selects n random elements from the sequence.
<code>shuffle()</code> <code>random_shuffle()</code>	Shuffles the sequence by randomly reordering the elements. It is possible to specify the properties of the random number generator used for shuffling. <code>random_shuffle()</code> is deprecated since C++14, and is removed from C++17.
<code>transform()</code>	Calls a unary function on each element of a sequence or a binary function on parallel elements of two sequences. This is an in-place transformation.
<code>unique()</code> <code>unique_copy()</code>	Removes consecutive duplicates from the sequence, either in place or by copying results to a different sequence.

Operational Algorithms

Operational algorithms execute a function on individual elements of a sequence. There are two operational algorithms provided. Both have a linear complexity and do not require the source sequence to be ordered.

ALGORITHM NAME	ALGORITHM SYNOPSIS
<code>for_each()</code>	Executes a function on each element in the sequence. The sequence is specified with a begin and end iterator.
<code>for_each_n()</code>	Similar to <code>for_each()</code> but only processes the first n elements in the sequence. The sequence is specified by a begin iterator and a number of elements (n).

C++17

Swap and Exchange Algorithms

The C++ Standard Library provides the following swap and exchange algorithms.

ALGORITHM NAME	ALGORITHM SYNOPSIS
<code>iter_swap()</code> <code>swap_ranges()</code>	Swaps two elements or sequences of elements.
<code>swap()</code>	Swaps two values, defined in the <code><utility></code> header.
<code>exchange()</code>	Replaces a given value with a new value and returns the old value. Defined in the <code><utility></code> header.

C++17

Partition Algorithms

A sequence is partitioned on a certain predicate, if all elements for which the predicate returns `true` are before all elements for which it returns `false`. The first element in the sequence that does not satisfy the predicate is called the *partition point*. The Standard Library provides the following partition algorithms.

ALGORITHM NAME	ALGORITHM SYNOPSIS	COMPLEXITY
<code>is_partitioned()</code>	Returns <code>true</code> if all elements for which a predicate returns <code>true</code> are before all elements for which it returns <code>false</code> .	Linear
<code>partition()</code>	Sorts the sequence such that all elements for which a predicate returns <code>true</code> are before all elements for which it returns <code>false</code> , without preserving the original order of the elements within each partition.	Linear

continues

TABLE (continued)

ALGORITHM NAME	ALGORITHM SYNOPSIS	COMPLEXITY
<code>stable_partition()</code>	Sorts the sequence such that all elements for which a predicate returns <code>true</code> are before all elements for which it returns <code>false</code> , while preserving the original order of the elements within each partition.	Linear logarithmic
<code>partition_copy()</code>	Copies elements from one sequence to two different sequences. The target sequence is selected based on the result of a predicate, either <code>true</code> or <code>false</code> .	Linear
<code>partition_point()</code>	Returns an iterator such that all elements before this iterator return <code>true</code> for a predicate and all elements after this iterator return <code>false</code> for that predicate.	Logarithmic

Sorting Algorithms

The Standard Library provides several different sorting algorithms with varying performance guarantees.

ALGORITHM NAME	ALGORITHM SYNOPSIS	COMPLEXITY
<code>is_sorted()</code> <code>is_sorted_until()</code>	Checks if a sequence is sorted or which subsequence is sorted.	Linear
<code>nth_element()</code>	Relocates the <i>n</i> th element of the sequence such that the element in the position pointed to by <i>n</i> th is the element that would be in that position if the whole range were sorted, and it rearranges all elements such that all elements preceding the <i>n</i> th element are less than the new <i>n</i> th element, and the ones following it are greater than the new <i>n</i> th element.	Linear
<code>partial_sort()</code> <code>partial_sort_copy()</code>	Partially sorts the sequence: the first <i>n</i> elements (specified by iterators) are sorted; the rest are not. They are sorted either in place or by copying them to a new sequence.	Linear logarithmic
<code>sort()</code> <code>stable_sort()</code>	Sorts elements in place, either preserving the order of duplicate elements or not.	Linear logarithmic

Binary Search Algorithms

The following binary search algorithms are normally used on sorted sequences. Technically, they only require the sequence to be at least partitioned on the element that is searched for. This could, for example, be achieved by applying `std::partition()`. A sorted sequence also meets this requirement. All these algorithms have logarithmic complexity.

ALGORITHM NAME	ALGORITHM SYNOPSIS
<code>lower_bound()</code>	Finds the first element in a sequence not less than (that is greater or equal to) a given value.
<code>upper_bound()</code>	Finds the first element in a sequence greater than a given value.
<code>equal_range()</code>	Returns a pair containing the result of both <code>lower_bound()</code> and <code>upper_bound()</code> .
<code>binary_search()</code>	Returns <code>true</code> if a given value is found in a sequence; <code>false</code> otherwise.

Set Algorithms

Set algorithms are special modifying algorithms that perform set operations on sequences. They are most appropriate on sequences from `set` containers, but work on sorted sequences from most containers.

ALGORITHM NAME	ALGORITHM SYNOPSIS	COMPLEXITY
<code>inplace_merge()</code>	Merges two sorted sequences in place.	Linear logarithmic
<code>merge()</code>	Merges two sorted sequences by copying them to a new sequence.	Linear
<code>includes()</code>	Determines if every element from one sorted sequence is in another sorted sequence.	Linear
<code>set_union()</code> <code>set_intersection()</code> <code>set_difference()</code> <code>set_symmetric_difference()</code>	Performs the specified set operation on two sorted sequences, copying results to a third sorted sequence.	Linear

Heap Algorithms

A *heap* is a standard data structure in which the elements of an array or sequence are ordered in a semi-sorted fashion, so that finding the “top” element is quick. For example, a heap data structure is typically used to implement a `priority_queue`. Six algorithms allow you to work with heaps.

ALGORITHM NAME	ALGORITHM SYNOPSIS	COMPLEXITY
<code>is_heap()</code>	Checks if a range of elements is a heap.	Linear
<code>is_heap_until()</code>	Finds the largest subrange in the given range of elements that is a heap.	Linear
<code>make_heap()</code>	Creates a heap from a range of elements.	Linear
<code>push_heap()</code> <code>pop_heap()</code>	Adds an element to, or removes an element from a heap.	Logarithmic
<code>sort_heap()</code>	Converts a heap into a range of ascending sorted elements.	Linear logarithmic

Minimum/Maximum Algorithms

ALGORITHM NAME	ALGORITHM SYNOPSIS
<code>clamp()</code>	Makes sure a value (<i>v</i>) is between a given minimum (<i>lo</i>) and maximum (<i>hi</i>). Returns a reference to <i>lo</i> if $v < lo$; returns a reference to <i>hi</i> if $v > hi$; otherwise returns a reference to <i>v</i> .
<code>min()</code> <code>max()</code>	Returns the minimum or maximum of two or more values.
<code>minmax()</code>	Returns the minimum and maximum of two or more values as a pair.
<code>min_element()</code> <code>max_element()</code>	Returns the minimum or maximum element in a sequence.
<code>minmax_element()</code>	Returns the minimum and maximum element in a sequence as a pair.

Numerical Processing Algorithms

The `<numeric>` header provides the following numerical processing algorithms. None of them require the source sequences to be ordered. All of them have a linear complexity.

ALGORITHM NAME	ALGORITHM SYNOPSIS
<code>iota()</code>	Fills a sequence with successively incrementing values starting with a given value.
<code>gcd()</code>	Returns the <i>greatest common divisor</i> of two integer types.

	ALGORITHM NAME	ALGORITHM SYNOPSIS
C++17	<code>lcm()</code>	Returns the <i>least common multiple</i> of two integer types.
	<code>adjacent_difference()</code>	Generates a new sequence in which each element is the difference (or other binary operation) of the second and first of each adjacent pair of elements in the source sequence.
	<code>partial_sum()</code>	Generates a new sequence in which each element is the sum (or other binary operation) of an element and all its preceding elements in the source sequence.
C++17	<code>exclusive_scan()</code> <code>inclusive_scan()</code>	<p>These are similar to <code>partial_sum()</code>. An inclusive scan is identical to a partial sum if the given summation operation is associative. However, <code>inclusive_scan()</code> sums in a non-deterministic order, while <code>partial_sum()</code> left to right, so for non-associative summation operations the result of the former is non-deterministic. The <code>exclusive_scan()</code> algorithm also sums in a non-deterministic order.</p> <p>For <code>inclusive_scan()</code>, the <i>i</i>th element is included in the <i>i</i>th sum, just as for <code>partial_sum()</code>. For <code>exclusive_scan()</code>, the <i>i</i>th element is not included in the <i>i</i>th sum.</p>
	C++17	<code>transform_exclusive_scan()</code> <code>transform_inclusive_scan()</code>
<code>accumulate()</code>		“Accumulates” the values of all the elements in a sequence. The default behavior is to sum the elements, but the caller can supply a different binary function instead.
<code>inner_product()</code>		Similar to <code>accumulate()</code> , but works on two sequences. This algorithm calls a binary function (multiplication by default) on parallel elements in the sequences, accumulating the result using another binary function (addition by default). If the sequences represent mathematical vectors, the algorithm calculates the dot product of the vectors.
C++17	<code>reduce()</code>	Similar to <code>accumulate()</code> , but supports parallel execution. The order of evaluation for <code>reduce()</code> is non-deterministic, while it’s from left to right for <code>accumulate()</code> . This means that the behavior of the former is non-deterministic if the given binary operation is not associative or not commutative.
C++17	<code>transform_reduce()</code>	Applies a transformation to each element in a sequence, then performs a <code>reduce()</code> .

Permutation Algorithms

A *permutation* of a sequence contains the same elements but in a different order. The following algorithms are provided to work with permutations.

ALGORITHM NAME	ALGORITHM SYNOPSIS	COMPLEXITY
<code>is_permutation()</code>	Returns <code>true</code> if the elements in one range are a permutation of the elements in another range.	Quadratic
<code>next_permutation()</code> <code>prev_permutation()</code>	Modifies the sequence by transforming it into its “next” or “previous” lexicographical permutation. Successive calls to one or the other will permute the sequence into all possible permutations of its elements, if you start with a properly sorted sequence. This algorithm returns <code>false</code> if no more permutations exist.	Linear

Choosing an Algorithm

The number and capabilities of the algorithms might overwhelm you at first. It can also be difficult to see how to apply them in the beginning. However, now that you have an idea of the available options, you are better able to tackle your program designs. The following chapters cover the details of how to use these algorithms in your code.

What’s Missing from the Standard Library

The Standard Library is powerful, but it’s not perfect. Here are two examples of missing functionality:

- The Standard Library does not guarantee any thread safety for accessing containers simultaneously from multiple threads.
- The Standard Library does not provide any generic tree or graph structures. Although `maps` and `sets` are generally implemented as balanced binary trees, the Standard Library does not expose this implementation in the interface. If you need a tree or graph structure for something like writing a parser, you need to implement your own or find an implementation in another library.

It is important to keep in mind that the Standard Library is *extensible*. You can write your own containers or algorithms that work with existing algorithms or containers. So, if the Standard Library doesn’t provide exactly what you need, consider writing your desired code such that it works with the Standard Library. Chapter 21 covers the topic of customizing and extending the Standard Library.

SUMMARY

This chapter provided an overview of the C++ Standard Library, which is the most important library that you will use in your code. It subsumes the C library, and includes additional facilities for strings, I/O, error handling, and other tasks. It also includes generic containers and algorithms. The following chapters describe the Standard Library in more detail.

17

Understanding Containers and Iterators

WHAT'S IN THIS CHAPTER?

- Details on iterators
- Containers overview: Requirements on elements, general error handling, and iterators
- Sequential containers: `vector`, `deque`, `list`, `forward_list`, and `array`
- Container adaptors: `queue`, `priority_queue`, and `stack`
- Associative containers: The `pair` utility, `map`, `multimap`, `set`, and `multiset`
- Unordered associative containers or hash tables: `unordered_map`, `unordered_multimap`, `unordered_set`, and `unordered_multiset`
- Other containers: Standard C-style arrays, `strings`, `streams`, and `bitset`

WROX.COM DOWNLOADS FOR THIS CHAPTER

Please note that all the code examples for this chapter are available as a part of this chapter's code download on the book's website at www.wrox.com/go/proc++4e on the Download Code tab.

Chapter 16 introduces the Standard Library, describes its basic philosophy, and provides an overview of the provided functionality. This chapter begins a more-in-depth tour of the Standard Library by covering the available containers. It is not the goal of this book to include

and explain every available class or class method. For a detailed list of available classes and methods, consult a Standard Library Reference, see the annotated bibliography in Appendix B.

The following chapters go deeper into topics such as algorithms, regular expressions, and how you can customize and extend the Standard Library.

CONTAINERS OVERVIEW

Containers in the Standard Library are generic data structures that are useful for storing collections of data. You should rarely need to use a standard C-style array, write a linked list, or design a stack when you use the Standard Library. The containers are implemented as class templates, so you can instantiate them for any type that meets certain basic conditions outlined in the next section. Most of the Standard Library containers, except for `array` and `bitset`, are flexible in size and automatically grow or shrink to accommodate more or fewer elements. This is a huge benefit compared to the old, standard C-style arrays, which had a fixed size. Because of the fixed-size nature of standard C-style arrays, they are more vulnerable to overruns, which in the simplest cases merely cause the program to crash because data has been corrupted, but in the worst cases allow certain kinds of security attacks. By using Standard Library containers, you ensure that your programs will be less vulnerable to these kinds of problems.

The Standard Library provides 16 containers, divided into four categories.

➤ Sequential containers

- `vector` (dynamic array)
- `deque`
- `list`
- `forward_list`
- `array`

➤ Associative containers

- `map`
- `multimap`
- `set`
- `multiset`

➤ Unordered associative containers or hash tables

- `unordered_map`
- `unordered_multimap`
- `unordered_set`
- `unordered_multiset`

➤ Container adaptors

- `queue`
- `priority_queue`
- `stack`

Additionally, C++ `strings` and streams can also be used as Standard Library containers to a certain degree, and `bitset` can be used to store a fixed number of bits.

Everything in the Standard Library is in the `std` namespace. The examples in this book usually use the blanket `using namespace std;` statement in source files (never use this in header files!), but you can be more selective in your own programs about which symbols from `std` to use.

Requirements on Elements

Standard Library containers use value semantics on elements. That is, they store a copy of elements that they are given, assign to elements with the assignment operator, and destroy elements with the destructor. Thus, when you write classes that you intend to use with the Standard Library, you need to make sure they are copyable. When requesting an element from the container, a reference to the stored copy is returned.

If you prefer reference semantics, you can store pointers to elements instead of the elements themselves. When the containers copy a pointer, the result still refers to the same element. An alternative is to store `std::reference_wrapper`s in the container. A `reference_wrapper` can be created using `std::ref()` or `std::cref()`, and basically exist to make references copyable. The `reference_wrapper` class template, and the `ref()` and `cref()` function templates are defined in the `<functional>` header. An example of this is given in the section “Storing references in a vector.”

It is possible to store move-only types, that is non-copyable types, in a container, but when doing so, some operations on the container might not compile. An example of a move-only type is `std::unique_ptr`.

WARNING *If you want to store pointers in containers, use `unique_ptr` if the container becomes owner of the pointed-to object, or `shared_ptr` if the container shares ownership with other owners. Do not use the old, deprecated (removed in C++17) `auto_ptr` class in containers because it does not implement copying correctly (as far as the Standard Library is concerned).*

One of the template type parameters for Standard Library containers is a so-called allocator. The container can use this allocator to allocate and deallocate memory for elements. The allocator type parameter has a default value, so you can almost always just ignore it.

Some containers, such as a `map`, also accept a comparator as one of the template type parameters. This comparator is used to order elements. It has a default value, so you don’t always have to specify it.

The specific requirements on elements in containers using the default allocator and comparator are shown in the following table.

METHOD	DESCRIPTION	NOTES
Copy Constructor	Creates a new element that is “equal” to the old one, but that can safely be destroyed without affecting the old one.	Used every time you insert an element, except when using an <code>emplace</code> method (discussed later).

continues

(continued)

METHOD	DESCRIPTION	NOTES
Move Constructor	Creates a new element by moving all content from a source element to the new element.	Used when the source element is an rvalue, and will be destroyed after the construction of the new element; also used when a <code>vector</code> grows in size. The move constructor should be <code>noexcept</code> , otherwise it won't be used!
Assignment Operator	Replaces the contents of an element with a copy of the source element.	Used every time you modify an element.
Move Assignment Operator	Replaces the contents of an element by moving all content from a source element.	Used when the source element is an rvalue, and will be destroyed after the assignment operation. The move assignment operator should be <code>noexcept</code> , otherwise it won't be used!
Destructor	Cleans up an element.	Used every time you remove an element, or when a <code>vector</code> grows in size and the elements are not <code>noexcept</code> movable.
Default Constructor	Constructs an element without any arguments.	Required only for certain operations, such as the <code>vector::resize()</code> method with one argument, and the <code>map::operator[]</code> access.
<code>operator==</code>	Compares two elements for equality.	Required for keys in unordered associative containers, and for certain operations, such as <code>operator==</code> on two containers.
<code>operator<</code>	Determines if one element is less than another.	Required for keys in ordered associative containers, and for certain operations, such as <code>operator<</code> on two containers.

Chapter 9 shows you how to write these methods, and discusses move semantics. For move semantics to work properly with Standard Library containers, the move constructor and the move assignment operator must be marked as `noexcept`!

WARNING *The Standard Library containers often call the copy constructor and copy assignment operator for elements, so make those operations efficient. You can also increase performance by implementing move semantics for your elements, as described in Chapter 9.*

Exceptions and Error Checking

The Standard Library containers provide limited error checking. Clients are expected to ensure that their uses are valid. However, some container methods and functions throw exceptions in certain conditions, such as out-of-bounds indexing. Of course, it is impossible to list exhaustively the exceptions that can be thrown from these methods because they perform operations on user-specified types with unknown exception characteristics. This chapter mentions exceptions where appropriate. Consult a Standard Library Reference for a list of possible exceptions thrown from each method.

Iterators

The Standard Library uses the iterator pattern to provide a generic abstraction for accessing the elements of a container. Each container provides a container-specific iterator, which is a glorified smart pointer that knows how to iterate over the elements of that specific container. The iterators for all the different containers adhere to a specific interface defined by the C++ standard. Thus, even though the containers provide different functionality, the iterators present a common interface to code that wishes to work with elements of the containers.

You can think of an iterator as a pointer to a specific element of the container. Like pointers to elements in an array, iterators can move to the next element with `operator++`. Similarly, you can usually use `operator*` and `operator->` on the iterator to access the actual element or field of the element. Some iterators allow comparison with `operator==` and `operator!=`, and support `operator--` for moving to previous elements.

All iterators must be copy constructible, copy assignable, and destructible. Lvalues of iterators must be swappable. Different containers provide iterators with slightly different additional capabilities. The standard defines five categories of iterators, as summarized in the following table.

ITERATOR CATEGORY	OPERATIONS REQUIRED	COMMENTS
Input (also known as Read)	<code>operator++</code> <code>operator*</code> <code>operator-></code> copy constructor <code>operator=</code> <code>operator==</code> <code>operator!=</code>	Provides read-only access, forward only (no <code>operator--</code> to move backward). Iterators can be assigned, copied, and compared for equality.
Output (also known as Write)	<code>operator++</code> <code>operator*</code> copy constructor <code>operator=</code>	Provides write-only access, forward only. Iterators can be assigned, but cannot be compared for equality. Specific to output iterators is that you can do <code>*iter = value</code> . Note the absence of <code>operator-></code> . Provides both prefix and postfix <code>operator++</code> .

continues

(continued)

ITERATOR CATEGORY	OPERATIONS REQUIRED	COMMENTS
Forward	Capabilities of input iterators, plus default constructor	Provides read access, forward only. Iterators can be assigned, copied, and compared for equality.
Bidirectional	Capabilities of forward iterators, plus <code>operator--</code>	Provides everything a forward iterator provides. Iterators can also move backward to a previous element. Provides both prefix and postfix <code>operator--</code> .
Random Access	Bidirectional capability, plus the following: <code>operator+</code> <code>operator-</code> <code>operator+=</code> <code>operator-=</code> <code>operator<</code> <code>operator></code> <code>operator<=</code> <code>operator>=</code> <code>operator[]</code>	Equivalent to raw pointers: support pointer arithmetic, array index syntax, and all forms of comparison.

Additionally, iterators that satisfy the requirements for output iterators are called *mutable iterators*, otherwise they are called *constant iterators*.

You can use `std::distance()` to compute the distance between two iterators of a container.

Iterators are implemented similarly to smart pointer classes in that they overload the specific desired operators. Consult Chapter 15 for details on operator overloading.

The basic iterator operations are similar to those supported by raw pointers, so a raw pointer can be a legitimate iterator for certain containers. In fact, the `vector` iterator could technically be implemented as a simple raw pointer. However, as a client of the containers, you need not worry about the implementation details; you can simply use the iterator abstraction.

NOTE *Iterators might, or might not, be implemented internally as pointers, so this text uses the term “refers to” instead of “points to” when discussing the elements accessible via an iterator.*

This chapter shows you the basics of using the iterators for each container. Chapter 18 delves into more detail about iterators and the Standard Library algorithms that use them.

NOTE *Only the sequential containers, ordered associative containers, and unordered associative containers provide iterators. The container adaptors and `bitset` class do not support iteration over their elements.*

Every container class in the Standard Library that supports iterators provides public type aliases for its iterator types, called `iterator` and `const_iterator`. For example, a `const` iterator for a vector of ints has as type `std::vector<int>::const_iterator`. Containers that allow you to iterate over their elements in reverse order also provide public type aliases called `reverse_iterator` and `const_reverse_iterator`. This way, clients can use the container iterators without worrying about the actual types.

NOTE *`const_iterator`s and `const_reverse_iterator`s provide read-only access to elements of the container.*

The containers also provide a method `begin()` that returns an iterator referring to the first element in the container. The `end()` method returns an iterator to the “past-the-end” value of the sequence of elements. That is, `end()` returns an iterator that is equal to the result of applying `operator++` to an iterator referring to the last element in the sequence. Together, `begin()` and `end()` provide a *half-open range* that includes the first element but not the last. The reason for this apparent complication is to support empty ranges (containers without any elements), in which case `begin()` is equal to `end()`. The half-open range bounded by iterators `begin()` and `end()` is often written mathematically like this: `[begin, end)`.

NOTE *The half-open range concept also applies to iterator ranges that are passed to container methods such as `insert()` and `erase()`. See the specific container discussions later in this chapter for details.*

Similarly, there are

- `cbegin()` and `cend()` methods that return `const` iterators.
- `rbegin()` and `rend()` methods that return reverse iterators.
- `crbegin()` and `crend()` methods that return `const` reverse iterators.

NOTE *The Standard Library also provides global non-member functions called `std::begin()`, `std::end()`, `std::cbegin()`, `std::cend()`, `std::rbegin()`, `std::rend()`, `std::crbegin()`, and `std::crend()`. It's recommended to use these non-member functions instead of the member versions.*

Examples of using iterators are given throughout the remainder of this chapter, and in subsequent chapters.

SEQUENTIAL CONTAINERS

`vector`, `deque`, `list`, `forward_list`, and `array` are called *sequential containers*. The best way to learn about sequential containers is to jump in with an example of the `vector` container, which should be your default container. The next section describes the `vector` container in detail, followed by briefer descriptions of `deque`, `list`, `forward_list`, and `array`. Once you become familiar with the sequential containers, it's trivial to switch between them.

vector

The Standard Library `vector` container is similar to a standard C-style array: the elements are stored in contiguous memory, each in its own “slot.” You can index into a `vector`, as well as add new elements to the back or insert them anywhere else. Inserting and deleting elements into and from a `vector` generally takes linear time, though these operations actually run in *amortized constant* time at the end of a `vector`, as explained in the section “The `vector` Memory Allocation Scheme,” later in this chapter. Random access of individual elements has a constant complexity.

vector Overview

`vector` is defined in the `<vector>` header file as a class template with two type parameters: the element type to store and an *allocator* type.

```
template <class T, class Allocator = allocator<T>> class vector;
```

The `Allocator` parameter specifies the type for a memory allocator object that the client can set in order to use custom memory allocation. This template parameter has a default value.

NOTE *The default value for the `Allocator` type parameter is sufficient for most applications. This chapter assumes that you always use the default allocator. Chapter 21 provides more details in case you are interested.*

Fixed-Length vectors

The simplest way to use a `vector` is as a fixed-length array. `vector` provides a constructor that allows you to specify the number of elements, and provides an overloaded `operator[]` in order to access and modify those elements. The C++ standard states that the result of `operator[]` is undefined when used to access an element outside the `vector` bounds. This means that any compiler can decide how to behave in that case. For example, the default behavior of Microsoft Visual C++ is to give a run-time error message when your program is compiled in debug mode, and to disable any bounds checking in release mode for performance reasons. You can change these default behaviors.

WARNING *Like “real” array indexing, the `operator[]` on a `vector` does not provide bounds checking.*

In addition to using operator [], you can access vector elements via at(), front(), and back(). The at() method is identical to operator [], except that it performs bounds checking, and throws an out_of_range exception if the index is out of bounds. front() and back() return references to the first and last elements of a vector, respectively. Calling front() or back() on an empty container causes undefined behavior.

NOTE All vector element accesses run with constant complexity.

Here is a small example program to “normalize” test scores so that the highest score is set to 100, and all other scores are adjusted accordingly. The program creates a vector of ten doubles, reads in ten values from the user, divides each value by the max score (times 100), and prints out the new values. For the sake of brevity, the program forsakes error checking.

```
vector<double> doubleVector(10); // Create a vector of 10 doubles.

// Initialize max to smallest number
double max = -numeric_limits<double>::infinity();

for (size_t i = 0; i < doubleVector.size(); i++) {
    cout << "Enter score " << i + 1 << ": ";
    cin >> doubleVector[i];
    if (doubleVector[i] > max) {
        max = doubleVector[i];
    }
}

max /= 100.0;
for (auto& element : doubleVector) {
    element /= max;
    cout << element << " ";
}
}
```

As you can see from this example, you can use a vector just as you would use a standard C-style array. Note that the first for loop uses the size() method to determine the number of elements in the container. This example also demonstrates the use of a range-based for loop with a vector. Here, the range-based for loop uses auto& and not auto because a reference is required so that the element can be modified in each iteration.

NOTE The operator [] on a vector normally returns a reference to the element, which can be used on the left-hand side of assignment statements. If operator [] is called on a const vector object, it returns a reference to a const element, which cannot be used as the target of an assignment. See Chapter 15 for details on how this trick is implemented.

Dynamic-Length vectors

The real power of a `vector` lies in its ability to grow dynamically. For example, consider the test score normalization program from the previous section with the additional requirement that it should handle any number of test scores. Here is the new version:

```
vector<double> doubleVector; // Create a vector with zero elements.

// Initialize max to smallest number
double max = -numeric_limits<double>::infinity();

for (size_t i = 1; true; i++) {
    double temp;
    cout << "Enter score " << i << " (-1 to stop): ";
    cin >> temp;
    if (temp == -1) {
        break;
    }
    doubleVector.push_back(temp);
    if (temp > max) {
        max = temp;
    }
}

max /= 100.0;
for (auto& element : doubleVector) {
    element /= max;
    cout << element << " ";
}
```

This version of the program uses the default constructor to create a `vector` with zero elements. As each score is read, it's added to the `vector` with the `push_back()` method, which takes care of allocating space for the new element. The range-based `for` loop doesn't require any changes.

vector Details

Now that you've had a taste of `vectors`, it's time to delve into their details.

Constructors and Destructors

The default constructor creates a `vector` with zero elements.

```
vector<int> intVector; // Creates a vector of ints with zero elements
```

You can specify a number of elements and, optionally, a value for those elements, like this:

```
vector<int> intVector(10, 100); // Creates vector of 10 ints with value 100
```

If you omit the default value, the new objects are zero-initialized. *Zero-initialization* constructs objects with the default constructor, and initializes primitive integer types (such as `char`, `int`, and so on) to zero, primitive floating-point types to 0.0, and pointer types to `nullptr`.

You can create vectors of built-in classes like this:

```
vector<string> stringVector(10, "hello");
```

User-defined classes can also be used as vector elements:

```
class Element
{
    public:
        Element() {}
        virtual ~Element() = default;
};
...
vector<Element> elementVector;
```

A vector can be constructed with an `initializer_list` containing the initial elements:

```
vector<int> intVector({ 1, 2, 3, 4, 5, 6 });
```

`initializer_lists` can also be used for so-called *uniform initialization*, as discussed in Chapter 1. Uniform initialization works on most Standard Library containers. Here is an example:

```
vector<int> intVector1 = { 1, 2, 3, 4, 5, 6 };
vector<int> intVector2{ 1, 2, 3, 4, 5, 6 };
```

You can allocate vectors on the heap as well.

```
auto elementVector = make_unique<vector<Element>>(10);
```

Copying and Assigning vectors

A vector stores copies of the objects, and its destructor calls the destructor for each of the objects. The copy constructor and assignment operator of the `vector` class perform deep copies of all the elements in the vector. Thus, for efficiency, you should pass vectors by reference or `const` reference to functions and methods. Consult Chapter 12 for details on writing functions that take template instantiations as parameters.

In addition to normal copying and assignment, vectors provide an `assign()` method that removes all the current elements and adds any number of new elements. This method is useful if you want to reuse a vector. Here is a trivial example. `intVector` is created with ten elements having the default value zero. Then `assign()` is used to remove all ten elements and replace them with five elements with value 100.

```
vector<int> intVector(10);
// Other code . . .
intVector.assign(5, 100);
```

`assign()` can also accept an `initializer_list` as follows. `intVector` now has four elements with the given values.

```
intVector.assign({ 1, 2, 3, 4 });
```

vectors also provide a `swap()` method that allows you to swap the contents of two vectors in constant time. Here is a simple example:

```
vector<int> vectorOne(10);
vector<int> vectorTwo(5, 100);
vectorOne.swap(vectorTwo);
// vectorOne now has 5 elements with the value 100.
// vectorTwo now has 10 elements with the value 0.
```

Comparing vectors

The Standard Library provides the usual six overloaded comparison operators for vectors: `==`, `!=`, `<`, `>`, `<=`, `>=`. Two vectors are equal if they have the same number of elements and all the corresponding elements in the two vectors are equal to each other. Two vectors are compared lexicographically, that is, one vector is “less than” another if all elements `0` through `i-1` in the first vector are equal to elements `0` through `i-1` in the second vector, but element `i` in the first is less than element `i` in the second, where `i` must be in the range `0 . . n` and `n` must be less than the `size()` of the smallest of the two vectors.

NOTE Comparing two vectors with operator `==` or operator `!=` requires the individual elements to be comparable with operator `==`. Comparing two vectors with operator `<`, operator `>`, operator `<=`, or operator `>=` requires the individual elements to be comparable with operator `<`. If you intend to store objects of a custom class in a vector, make sure to write those operators.

Here is an example of a simple program that compares vectors of ints:

```
vector<int> vectorOne(10);
vector<int> vectorTwo(10);

if (vectorOne == vectorTwo) {
    cout << "equal!" << endl;
} else {
    cout << "not equal!" << endl;
}

vectorOne[3] = 50;

if (vectorOne < vectorTwo) {
    cout << "vectorOne is less than vectorTwo" << endl;
} else {
    cout << "vectorOne is not less than vectorTwo" << endl;
}
```

The output of the program is as follows:

```
equal!
vectorOne is not less than vectorTwo
```

vector Iterators

The section on “Iterators” at the beginning of this chapter explains the concepts of container iterators. The discussion can get a bit abstract, so it’s helpful to jump in and look at a code example. Here is the last `for` loop of the test score normalization program from earlier using iterators instead of a range-based `for` loop:

```
for (vector<double>::iterator iter = begin(doubleVector);
     iter != end(doubleVector); ++iter) {
    *iter /= max;
    cout << *iter << " ";
}
```

First, take a look at the `for` loop initialization statement:

```
vector<double>::iterator iter = begin(doubleVector);
```

Recall that every container defines a type named `iterator` to represent iterators for that type of container. `begin()` returns an iterator of that type referring to the first element in the container. Thus, the initialization statement obtains in the variable `iter` an iterator referring to the first element of `doubleVector`. Next, look at the `for` loop comparison:

```
iter != end(doubleVector);
```

This statement simply checks if the iterator is past the end of the sequence of elements in the `vector`. When it reaches that point, the loop terminates. The increment statement, `++iter`, increments the iterator to refer to the next element in the `vector`.

NOTE Use pre-increment instead of post-increment when possible because pre-increment is at least as efficient, and usually more efficient. `iter++` must return a new iterator object, while `++iter` can simply return a reference to `iter`. See Chapter 15 for details on implementing both versions of `operator++`.

The `for` loop body contains these two lines:

```
*iter /= max;
cout << *iter << " ";
```

As you can see, your code can both access and modify the elements over which it iterates. The first line uses `*` to dereference `iter` to obtain the element to which it refers, and assigns to that element. The second line dereferences `iter` again, but this time only to stream the element to `cout`.

The preceding `for` loop using iterators can be simplified by using the `auto` keyword:

```
for (auto iter = begin(doubleVector);
     iter != end(doubleVector); ++iter) {
    *iter /= max;
    cout << *iter << " ";
}
```

With `auto`, the compiler automatically deduces the type of the variable `iter` based on the right-hand side of the initializer, which in this case is the result of the call to `begin()`.

Accessing Fields of Object Elements

If the elements of your container are objects, you can use the `->` operator on iterators to call methods or access data members of those objects. For example, the following program creates a `vector` of ten strings, then iterates over all of them appending a new string to each one:

```
vector<string> stringVector(10, "hello");
for (auto it = begin(stringVector); it != end(stringVector); ++it) {
    it->append(" there");
}
```

Often, using a range-based for loop results in more elegant code, as in this example:

```
vector<string> stringVector(10, "hello");
for (auto& str : stringVector) {
    str.append(" there");
}
```

`const_iterator`

The normal iterator is read/write. However, if you call `begin()` or `end()` on a `const` object, or you call `cbegin()` or `cend()`, you receive a `const_iterator`. The `const_iterator` is read-only; you cannot modify the element it refers to. An iterator can always be converted to a `const_iterator`, so it's always safe to write something like this:

```
vector<type>::const_iterator it = begin(myVector);
```

However, a `const_iterator` cannot be converted to an iterator. If `myVector` is `const`, the following line doesn't compile:

```
vector<type>::iterator it = begin(myVector);
```

NOTE *If you do not need to modify the elements of a vector, you should use a `const_iterator`. This rule makes it easier to guarantee correctness of your code, and helps the compiler to perform better optimizations.*

When using the `auto` keyword, using `const_iterator`s looks a bit different. Suppose you write the following code:

```
vector<string> stringVector(10, "hello");
for (auto iter = begin(stringVector); iter != end(stringVector); ++iter) {
    cout << *iter << endl;
}
```

Because of the `auto` keyword, the compiler deduces the type of the `iter` variable automatically and makes it a normal iterator because `stringVector` is not `const`. If you want a read-only

`const_iterator` in combination with `using auto`, then you need to use `cbegin()` and `cend()` instead of `begin()` and `end()` as follows:

```
vector<string> stringVector(10, "hello");
for (auto iter = cbegin(stringVector); iter != cend(stringVector); ++iter) {
    cout << *iter << endl;
}
```

Now the compiler uses `const_iterator` as type for the variable `iter` because that's what `cbegin()` returns.

A range-based `for` loop can also be forced to use `const` iterators as follows:

```
vector<string> stringVector(10, "hello");
for (const auto& element : stringVector) {
    cout << element << endl;
}
```

Iterator Safety

Generally, iterators are about as safe as pointers—that is, extremely unsafe. For example, you can write code like this:

```
vector<int> intVector;
auto iter = end(intVector);
*iter = 10; // BUG! iter doesn't refer to a valid element.
```

Recall that the iterator returned by `end()` is one element past the end of a vector, not an iterator referring to the last element! Trying to dereference it results in undefined behavior. Iterators are not required to perform any verification.

Another problem can occur if you use mismatched iterators. For example, the following `for` loop initializes an iterator from `vectorTwo`, and tries to compare it to the end iterator of `vectorOne`. Needless to say, this loop will not do what you intended, and may never terminate. Dereferencing the iterator in the loop will likely produce undefined results.

```
vector<int> vectorOne(10);
vector<int> vectorTwo(10);

// Fill in the vectors.

// BUG! Possible infinite loop
for (auto iter = begin(vectorTwo); iter != end(vectorOne); ++iter) {
    // Loop body
}
```

NOTE Microsoft Visual C++, by default, gives an assertion error at run time for both of the preceding problems when running a debug build of your program. By default, no verification of iterators is performed for release builds. You can enable it for release builds as well, but it has a performance penalty.

Other Iterator Operations

The `vector` iterator is random access, which means that you can move it backward or forward, or jump around. For example, the following code eventually changes the fifth element (index 4) to the value 4:

```
vector<int> intVector(10);
auto it = begin(intVector);
it += 5;
--it;
*it = 4;
```

Iterators versus Indexing

Given that you can write a `for` loop that uses a simple index variable and the `size()` method to iterate over the elements of the `vector`, why should you bother using iterators? That's a valid question, for which there are three main answers:

- Iterators allow you to insert and delete elements and sequences of elements at any point in the container. See the section “Adding and Removing Elements.”
- Iterators allow you to use the Standard Library algorithms, which are discussed in Chapter 18.
- Using an iterator to access each element sequentially is often more efficient than indexing the container to retrieve each element individually. This generalization is not true for `vectors`, but applies to `lists`, `maps`, and `sets`.

Storing references in a vector

As mentioned in the beginning of this chapter, it is possible to store references in a container, such as a `vector`. To do this, you store `std::reference_wrapper`s in the container. The `std::ref()` and `cref()` function templates are used to create non-const and const `reference_wrapper` instances. You need to include the `<functional>` header file. Here is an example:

```
string str1 = "Hello";
string str2 = "World";

// Create a vector of references to strings.
vector<reference_wrapper<string>> vec{ ref(str1) };
vec.push_back(ref(str2)); // push_back() works as well.

// Modify the string referred to by the second reference in the vector.
vec[1].get() += "!";

// The end result is that str2 is actually modified.
cout << str1 << " " << str2 << endl;
```

Adding and Removing Elements

As you have already read, you can append an element to a `vector` with the `push_back()` method. The `vector` provides a parallel remove method called `pop_back()`.

WARNING `pop_back()` does not return the element that it removed. If you want that element, you must first retrieve it with `back()`.

You can also insert elements at any point in the `vector` with the `insert()` method, which adds one or more elements to a position specified by an iterator, shifting all subsequent elements down to make room for the new ones. There are five different overloaded forms of `insert()` that do the following:

- Insert a single element.
- Insert n copies of a single element.
- Insert elements from an iterator range. Recall that the iterator range is half-open, such that it includes the element referred to by the starting iterator but not the one referred to by the ending iterator.
- Insert a single element by moving the given element to a `vector` using move semantics.
- Insert a list of elements into a `vector` where the list of elements is given as an `initializer_list`.

NOTE There are versions of `push_back()` and `insert()` that take an lvalue or an rvalue as a parameter. Both versions allocate memory as needed to store the new elements. The lvalue versions store copies of the given elements, while the rvalue versions use move semantics to move ownership of the given elements to the `vector` instead of copying them.

You can remove elements from any point in a `vector` with `erase()`, and you can remove all elements with `clear()`. There are two forms of `erase()`: one accepting a single iterator to remove a single element, and one accepting two iterators specifying a range of elements to remove.

If you want to remove a number of elements that satisfy a certain condition, one solution would be to write a loop iterating over all the elements and erasing every element that matches the condition. However, this solution has quadratic complexity, which is very bad for performance. In this case, the quadratic complexity can be avoided by using the *remove-erase-idiom*, which has a linear complexity. The *remove-erase-idiom* is discussed in Chapter 18.

Here is a small program that demonstrates the methods for adding and removing elements. It uses a helper function template `printVector()` to print the contents of a `vector` to `cout` as follows. See Chapter 12 for details on writing function templates.

```
template<typename T>
void printVector(const vector<T>& v)
{
    for (auto& element : v) { cout << element << " "; }
    cout << endl;
}
```

The example includes demonstrations of the two-argument version of `erase()` and the following versions of `insert()`:

- `insert(const_iterator pos, const T& x)`: the value `x` is inserted at position `pos`.
- `insert(const_iterator pos, size_type n, const T& x)`: the value `x` is inserted `n` times at position `pos`.
- `insert(const_iterator pos, InputIterator first, InputIterator last)`: the elements in the range `[first, last)` are inserted at position `pos`.

The code for the example is as follows:

```
vector<int> vectorOne = { 1, 2, 3, 5 };
vector<int> vectorTwo;

// Oops, we forgot to add 4. Insert it in the correct place
vectorOne.insert(cbegin(vectorOne) + 3, 4);

// Add elements 6 through 10 to vectorTwo
for (int i = 6; i <= 10; i++) {
    vectorTwo.push_back(i);
}
printVector(vectorOne);
printVector(vectorTwo);

// Add all the elements from vectorTwo to the end of vectorOne
vectorOne.insert(cend(vectorOne), cbegin(vectorTwo), cend(vectorTwo));
printVector(vectorOne);

// Now erase the numbers 2 through 5 in vectorOne
vectorOne.erase(cbegin(vectorOne) + 1, cbegin(vectorOne) + 5);
printVector(vectorOne);

// Clear vectorTwo entirely
vectorTwo.clear();

// And add 10 copies of the value 100
vectorTwo.insert(cbegin(vectorTwo), 10, 100);

// Decide we only want 9 elements
vectorTwo.pop_back();
printVector(vectorTwo);
```

The output of the program is as follows:

```
1 2 3 4 5
6 7 8 9 10
1 2 3 4 5 6 7 8 9 10
1 6 7 8 9 10
100 100 100 100 100 100 100 100 100
```

Recall that iterator pairs represent half-open ranges, and `insert()` adds elements before the element referred to by a given iterator position. Thus, you can insert the entire contents of `vectorTwo` into the end of `vectorOne`, like this:

```
vectorOne.insert(cend(vectorOne), cbegin(vectorTwo), cend(vectorTwo));
```

WARNING *Methods such as `insert()` and `erase()` that take a vector range as arguments assume that the beginning and ending iterators refer to elements in the same container, and that the end iterator refers to an element at or past the begin iterator. The methods will not work correctly if these preconditions are not met!*

Move Semantics

All Standard Library containers implement move semantics by including a move constructor and move assignment operator. See Chapter 9 for details on move semantics. A big benefit of this is that you can easily return a Standard Library container from a function *by value* without performance penalty. Take a look at the following function:

```
vector<int> createVectorOfSize(size_t size)
{
    vector<int> vec(size);
    int contents = 0;
    for (auto& i : vec) {
        i = contents++;
    }
    return vec;
}
...
vector<int> myVector;
myVector = createVectorOfSize(123);
```

Without move semantics, assigning the result of `createVectorOfSize()` to `myVector` calls the copy assignment operator. With the move semantics support in the Standard Library containers, copying of the vector is avoided. Instead, the assignment to `myVector` triggers a call to the move assignment operator.

Similarly, push operations can also make use of move semantics to improve performance in certain situations. For example, suppose you have a vector of strings:

```
vector<string> vec;
```

You can add an element to this vector as follows:

```
string myElement(5, 'a'); // Constructs the string "aaaaa"
vec.push_back(myElement);
```

However, because `myElement` is not a temporary object, `push_back()` makes a copy of `myElement` and puts it in the vector.

The vector class also defines a `push_back(T&& val)`, which is the move equivalent of `push_back(const T& val)`. So, copying can be avoided if you call the `push_back()` method as follows:

```
vec.push_back(move(myElement));
```

Now you are explicitly saying that `myElement` should be moved into the vector. Note that after this call, `myElement` is in a valid but otherwise indeterminate state. You should not use `myElement`

anymore, unless you first bring it back to a determinate state, for example by calling `clear()` on it! You can also call `push_back()` as follows:

```
vec.push_back(string(5, 'a'));
```

The preceding call to `push_back()` triggers a call to the move version because the call to the `string` constructor results in a temporary object. The `push_back()` method moves this temporary `string` object into the `vector`, avoiding any copying.

Emplace Operations

C++ supports *emplace operations* on most Standard Library containers, including `vector`. Emplace means “to put into place.” An example is `emplace_back()` on a `vector` object, which does not copy or move anything. Instead, it makes space in the container and constructs the object *in place*, as in this example:

```
vec.emplace_back(5, 'a');
```

The `emplace` methods take a variable number of arguments as a variadic template. Variadic templates are discussed in Chapter 22, but those details are not required to understand how to use `emplace_back()`. The difference in performance between `emplace_back()` and `push_back()` using move semantics depends on how your specific compiler implements these operations. In most situations, you can pick the one based on the syntax that you prefer.

```
vec.push_back(string(5, 'a'));  
// Or  
vec.emplace_back(5, 'a');
```

Since C++17, the `emplace_back()` method returns a reference to the inserted element. Before C++17, the return type of `emplace_back()` was `void`.

There is also an `emplace()` method that constructs an object in place at a specific position in the `vector`, and returns an iterator to the inserted element.

Algorithmic Complexity and Iterator Invalidation

Inserting or erasing elements in a `vector` causes all subsequent elements to shift up or down to make room for, or fill in the holes left by, the affected elements. Thus, these operations take linear complexity. Furthermore, all iterators referring to the insertion or removal point or subsequent positions are invalid following the action. The iterators are not “magically” moved to keep up with the elements that are shifted up or down in the `vector`—that’s up to you.

Also keep in mind that an internal `vector` reallocation can cause invalidation of all iterators referring to elements in the `vector`, not just those referring to elements past the point of insertion or deletion. See the next section for details.

The `vector` Memory Allocation Scheme

A `vector` allocates memory automatically to store the elements that you insert. Recall that the `vector` requirements dictate that the elements must be in contiguous memory, like in standard C-style arrays. Because it’s impossible to request to add memory to the end of a current chunk of memory, every time a `vector` allocates more memory, it must allocate a new, larger chunk in a separate memory location and copy/move all the elements to the new chunk. This process is

time-consuming, so `vector` implementations attempt to avoid it by allocating more space than needed when they have to perform a reallocation. That way, they can avoid reallocating memory every time you insert an element.

One obvious question at this point is why you, as a client of `vector`, care how it manages its memory internally. You might think that the principle of abstraction should allow you to disregard the internals of the `vector` memory allocation scheme. Unfortunately, there are two reasons why you need to understand how it works:

1. **Efficiency.** The `vector` allocation scheme can guarantee that an element insertion runs in *amortized constant time*: most of the time the operation is constant, but once in a while (if it requires a reallocation), it's linear. If you are worried about efficiency, you can control when a `vector` performs reallocations.
2. **Iterator invalidations.** A reallocation invalidates all iterators referring to elements in a `vector`.

Thus, the `vector` interface allows you to query and control the `vector` reallocations. If you don't control the reallocations explicitly, you should assume that all insertions cause a reallocation and thus invalidate all iterators.

Size and Capacity

`vector` provides two methods for obtaining information about its size: `size()` and `capacity()`. The `size()` method returns the number of elements in a `vector`, while `capacity()` returns the number of elements that it can hold without a reallocation. Thus, the number of elements that you can insert without causing a reallocation is `capacity() - size()`.

NOTE You can query whether a `vector` is empty with the `empty()` method. A `vector` can be empty but have nonzero capacity.

C++17

C++17 introduces non-member `std::size()` and `std::empty()` global functions. These are similar to the non-member functions that are available to get iterators (`std::begin()`, `std::end()`, and so on). The non-member `size()` and `empty()` functions can be used with all containers. They can also be used with statically allocated C-style arrays not accessed through pointers, and with `initializer_lists`. Here is an example of using them with a `vector`:

```
vector<int> vec{ 1,2,3 };
cout << size(vec) << endl;
cout << empty(vec) << endl;
```

Reserving Capacity

If you don't care about efficiency or iterator invalidations, there is never a need to control the `vector` memory allocation explicitly. However, if you want to make your program as efficient as possible, or you want to guarantee that iterators will not be invalidated, you can force a `vector` to preallocate enough space to hold all of its elements. Of course, you need to know how many elements it will hold, which is sometimes impossible to predict.

One way to preallocate space is to call `reserve()`, which allocates enough memory to hold the specified number of elements. The next section shows an example of the `reserve()` method in action.

WARNING *Reserving space for elements changes the capacity, but not the size. That is, it doesn't actually create elements. Don't access elements past a vector's size.*

Another way to preallocate space is to specify, in the constructor, or with the `resize()` or `assign()` method, how many elements you want a vector to store. This method actually creates a vector of that size (and probably of that capacity).

Directly Accessing the Data

A vector stores its data contiguously in memory. You can get a pointer to this block of memory with the `data()` method.

C++17

C++17 introduces a non-member `std::data()` global function that can be used to get a pointer to the data. It works for the array and vector containers, strings, statically allocated C-style arrays not accessed through pointers, and `initializer_lists`. Here is an example for a vector:

```
vector<int> vec{ 1,2,3 };
int* data1 = vec.data();
int* data2 = data(vec);
```

vector Example: A Round-Robin Class

A common problem in computer science is distributing requests among a finite list of resources. For example, a simple operating system could keep a list of processes and assign a time slice (such as 100ms) to each process to let the process perform some of its work. After the time slice is finished, the OS suspends the process and the next process in the list is given a time slice to perform some of its work. One of the simplest algorithmic solutions to this problem is *round-robin scheduling*. When the time slice of the last process is finished, the scheduler starts over again with the first process. For example, in the case of three processes, the first time slice would go to the first process, the second slice to the second process, the third slice to the third process, and the fourth slice back to the first process. The cycle would continue in this way indefinitely.

Suppose that you decide to write a generic round-robin scheduling class that can be used with any type of resource. The class should support adding and removing resources, and should support cycling through the resources in order to obtain the next one. You could use a vector directly, but it's often helpful to write a wrapper class that provides more directly the functionality you need for your specific application. The following example shows a `RoundRobin` class template with comments explaining the code. First, here is the class definition:

```
// Class template RoundRobin
// Provides simple round-robin semantics for a list of elements.
template <typename T>
class RoundRobin
{
public:
```

```

    // Client can give a hint as to the number of expected elements for
    // increased efficiency.
    RoundRobin(size_t numExpected = 0);
    virtual ~RoundRobin() = default;

    // Prevent assignment and pass-by-value
    RoundRobin(const RoundRobin& src) = delete;
    RoundRobin& operator=(const RoundRobin& rhs) = delete;

    // Explicitly default a move constructor and move assignment operator
    RoundRobin(RoundRobin&& src) = default;
    RoundRobin& operator=(RoundRobin&& rhs) = default;

    // Appends element to the end of the list. May be called
    // between calls to getNext().
    void add(const T& element);

    // Removes the first (and only the first) element
    // in the list that is equal (with operator==) to element.
    // May be called between calls to getNext().
    void remove(const T& element);

    // Returns the next element in the list, starting with the first,
    // and cycling back to the first when the end of the list is
    // reached, taking into account elements that are added or removed.
    T& getNext();
private:
    std::vector<T> mElements;
    typename std::vector<T>::iterator mCurrentElement;
};

```

As you can see, the public interface is straightforward: only three methods plus the constructor and destructor. The resources are stored in the `vector` called `mElements`. The iterator `mCurrentElement` always refers to the element that will be returned with the next call to `getNext()`. If `getNext()` hasn't been called yet, `mCurrentElement` is equal to `begin(mElements)`. Note the use of the `typename` keyword in front of the line declaring `mCurrentElement`. So far, you've only seen that keyword used to specify template parameters, but there is another use for it. You must specify `typename` explicitly whenever you access a type based on one or more template parameters. In this case, the template parameter `T` is used to access the iterator type. Thus, you must specify `typename`. This is another example of arcane C++ syntax.

The class also prevents assignment and pass-by-value because of the `mCurrentElement` data member. To make assignment and pass-by-value work, you would have to implement an assignment operator and copy constructor and make sure `mCurrentElement` is valid in the destination object.

The implementation of the `RoundRobin` class follows with comments explaining the code. Note the use of `reserve()` in the constructor, and the extensive use of iterators in `add()`, `remove()`, and `getNext()`. The trickiest aspect is handling `mCurrentElement` in the `add()` and `remove()` methods.

```

template <typename T> RoundRobin<T>::RoundRobin(size_t numExpected)
{
    // If the client gave a guideline, reserve that much space.
    mElements.reserve(numExpected);
}

```

```
    // Initialize mCurrentElement even though it isn't used until
    // there's at least one element.
    mCurrentElement = begin(mElements);
}

// Always add the new element at the end
template <typename T> void RoundRobin<T>::add(const T& element)
{
    // Even though we add the element at the end, the vector could
    // reallocate and invalidate the mCurrentElement iterator with
    // the push_back() call. Take advantage of the random-access
    // iterator features to save our spot.
    int pos = mCurrentElement - begin(mElements);

    // Add the element.
    mElements.push_back(element);

    // Reset our iterator to make sure it is valid.
    mCurrentElement = begin(mElements) + pos;
}

template <typename T> void RoundRobin<T>::remove(const T& element)
{
    for (auto it = begin(mElements); it != end(mElements); ++it) {
        if (*it == element) {
            // Removing an element invalidates the mCurrentElement iterator
            // if it refers to an element past the point of the removal.
            // Take advantage of the random-access features of the iterator
            // to track the position of the current element after removal.
            int newPos;

            if (mCurrentElement == end(mElements) - 1 &&
                mCurrentElement == it) {
                // mCurrentElement refers to the last element in the list,
                // and we are removing that last element, so wrap back to
                // the beginning.
                newPos = 0;
            } else if (mCurrentElement <= it) {
                // Otherwise, if mCurrentElement is before or at the one
                // we're removing, the new position is the same as before.
                newPos = mCurrentElement - begin(mElements);
            } else {
                // Otherwise, it's one less than before.
                newPos = mCurrentElement - begin(mElements) - 1;
            }

            // Erase the element (and ignore the return value).
            mElements.erase(it);

            // Now reset our iterator to make sure it is valid.
            mCurrentElement = begin(mElements) + newPos;

            return;
        }
    }
}
```



```

template <typename T> T& RoundRobin<T>::getNext()
{
    // First, make sure there are elements.
    if (mElements.empty()) {
        throw std::out_of_range("No elements in the list");
    }

    // Store the current element which we need to return.
    auto& toReturn = *mCurrentElement;

    // Increment the iterator modulo the number of elements.
    ++mCurrentElement;
    if (mCurrentElement == end(mElements)) {
        mCurrentElement = begin(mElements);
    }

    // Return a reference to the element.
    return toReturn;
}

```

Here's a simple implementation of a scheduler that uses the RoundRobin class template, with comments explaining the code:

```

// Simple Process class.
class Process final
{
public:
    // Constructor accepting the name of the process.
    Process(string_view name) : mName(name) {}

    // Implementation of doWorkDuringTimeSlice() would let the process
    // perform its work for the duration of a time slice.
    // Actual implementation omitted.
    void doWorkDuringTimeSlice() {
        cout << "Process " << mName
            << " performing work during time slice." << endl;
    }

    // Needed for the RoundRobin::remove() method to work.
    bool operator==(const Process& rhs) {
        return mName == rhs.mName;
    }
private:
    string mName;
};

// Simple round-robin based process scheduler.
class Scheduler final
{
public:
    // Constructor takes a vector of processes.
    Scheduler(const vector<Process>& processes);

    // Selects the next process using a round-robin scheduling
    // algorithm and allows it to perform some work during

```

```
        // this time slice.
        void scheduleTimeSlice();

        // Removes the given process from the list of processes.
        void removeProcess(const Process& process);
    private:
        RoundRobin<Process> mProcesses;
};

Scheduler::Scheduler(const vector<Process>& processes)
{
    // Add the processes
    for (auto& process : processes) {
        mProcesses.add(process);
    }
}

void Scheduler::scheduleTimeSlice()
{
    try {
        mProcesses.getNext().doWorkDuringTimeSlice();
    } catch (const out_of_range&) {
        cerr << "No more processes to schedule." << endl;
    }
}

void Scheduler::removeProcess(const Process& process)
{
    mProcesses.remove(process);
}

int main()
{
    vector<Process> processes = { Process("1"), Process("2"), Process("3") };

    Scheduler scheduler(processes);
    for (int i = 0; i < 4; ++i)
        scheduler.scheduleTimeSlice();

    scheduler.removeProcess(processes[1]);
    cout << "Removed second process" << endl;

    for (int i = 0; i < 4; ++i)
        scheduler.scheduleTimeSlice();

    return 0;
}
```

The output should be as follows:

```
Process 1 performing work during time slice.
Process 2 performing work during time slice.
Process 3 performing work during time slice.
```

```

Process 1 performing work during time slice.
Removed second process
Process 3 performing work during time slice.
Process 1 performing work during time slice.
Process 3 performing work during time slice.
Process 1 performing work during time slice.

```

The `vector<bool>` Specialization

The C++ standard requires a partial specialization of `vector` for `bools`, with the intention that it optimizes space allocation by “packing” the Boolean values. Recall that a `bool` is either `true` or `false`, and thus could be represented by a single bit, which can take on exactly two values. C++ does not have a native type that stores exactly one bit. Some compilers represent a Boolean value with a type the same size as a `char`, other compilers use an `int`. The `vector<bool>` specialization is supposed to store the “array of `bools`” in single bits, thus saving space.

NOTE *You can think of the `vector<bool>` as a bit-field instead of a vector. The `bitset` container described later in this chapter provides a more full-featured bit-field implementation than does `vector<bool>`. However, the benefit of `vector<bool>` is that it can change size dynamically.*

In a half-hearted attempt to provide some bit-field routines for `vector<bool>`, there is one additional method: `flip()`. This method can be called either on the container—in which case it complements all the elements in the container—or on a single reference returned from `operator[]` or a similar method, in which case it complements that single element.

At this point, you should be wondering how you can call a method on a reference to `bool`. The answer is that you can’t. The `vector<bool>` specialization actually defines a class called `reference` that serves as a proxy for the underlying `bool` (or bit). When you call `operator[]`, `at()`, or a similar method, then `vector<bool>` returns a `reference` object, which is a proxy for the real `bool`.

WARNING *The fact that references returned from `vector<bool>` are really proxies means that you can’t take their addresses to obtain pointers to the actual elements in the container.*

In practice, the little amount of space saved by packing `bools` hardly seems worth the extra effort. Even worse, accessing and modifying elements in a `vector<bool>` is much slower than, for example, in a `vector<int>`. Many C++ experts recommend avoiding `vector<bool>` in favor of the `bitset`. If you do need a dynamically sized bit field, then it’s recommended to use something like `vector<std::int_fast8_t>` or `vector<unsigned char>`. The `std::int_fast8_t` type is defined in `<cstdint>`. It is a signed integer type for which the compiler has to use the fastest integer type it has that is at least 8 bits.

deque

`deque` (the abbreviation for *double-ended queue*) is almost identical to `vector`, but is used far less frequently. It is defined in the `<deque>` header file. The principle differences are as follows:

- Elements are not stored contiguously in memory.
- A `deque` supports true constant-time insertion and removal of elements at both the front and the back (a `vector` supports amortized constant time at just the back).
- A `deque` provides `push_front()`, `pop_front()`, and `emplace_front()`, which the `vector` omits. Since C++17, `emplace_front()` returns a reference to the inserted element, instead of `void`.
- A `deque` does not invalidate iterators when inserting elements at the front or at the back.
- A `deque` does not expose its memory management scheme via `reserve()` or `capacity()`.

`deques` are rarely used, as opposed to `vectors`, so they are not further discussed. Consult a Standard Library Reference for a detailed list of all supported methods.

list

The Standard Library `list` class template, defined in the `<list>` header file, is a standard doubly linked list. It supports constant-time insertion and deletion of elements at any point in the list, but provides slow (linear) time access to individual elements. In fact, the list does not even provide random-access operations like `operator[]`. Only through iterators can you access individual elements.

Most of the `list` operations are identical to those of `vector`, including the constructors, destructor, copying operations, assignment operations, and comparison operations. This section focuses on those methods that differ from those of `vector`.

Accessing Elements

The only methods provided by a `list` to access elements are `front()` and `back()`, both of which run in constant time. These methods return a reference to the first and last elements in a `list`. All other element access must be performed through iterators.

A `list` supports `begin()`, returning an iterator referring to the first element in the `list`, and `end()`, returning an iterator referring to one past the last element in the `list`. It also supports `cbegin()`, `cend()`, `rbegin()`, `rend()`, `crbegin()`, and `crend()`, similar to a `vector`.

WARNING *Lists do not provide random access to elements.*

Iterators

A `list` iterator is bidirectional, not random access like a `vector` iterator. That means that you cannot add and subtract `list` iterators from each other, or perform other pointer arithmetic on them.

For example, if `p` is a `list` iterator, you can traverse through the elements of the `list` by doing `++p` or `--p`, but you cannot use the addition or subtraction operator; `p+n` and `p-n` do not work.

Adding and Removing Elements

A `list` supports the same add element and remove element methods as a `vector`, including `push_back()`, `pop_back()`, `emplace()`, `emplace_back()`, the five forms of `insert()`, the two forms of `erase()`, and `clear()`. Like a `deque`, it also provides `push_front()`, `emplace_front()`, and `pop_front()`. All these methods (except for `clear()`) run in constant time, once you've found the correct position. Thus, a `list` could be appropriate for applications that perform many insertions and deletions from the data structure, but do not need quick index-based element access. And even then, a `vector` might still be faster. Use a performance profiler to make sure.

list Size

Like `deques`, and unlike `vectors`, `lists` do not expose their underlying memory model. Consequently, they support `size()`, `empty()`, and `resize()`, but not `reserve()` or `capacity()`. Note that the `size()` method on a `list` has constant complexity, which is not the case for the `size()` method on a `forward_list` (discussed later).

Special list Operations

A `list` provides several special operations that exploit its quick element insertion and deletion. This section provides an overview and examples. Consult a Standard Library Reference for a thorough reference of all the methods.

Splicing

The linked-list characteristics of a `list` allow it to *splice*, or insert, an entire `list` at any position in another `list` in constant time. The simplest version of this method works as follows:

```
// Store the a words in the main dictionary.
list<string> dictionary{ "aardvark", "ambulance" };
// Store the b words.
list<string> bWords{ "bathos", "balderdash" };
// Add the c words to the main dictionary.
dictionary.push_back("canticle");
dictionary.push_back("consumerism");
// Splice the b words into the main dictionary.
if (!bWords.empty()) {
    // Get an iterator to the last b word.
    auto iterLastB = --(cend(bWords));
    // Iterate up to the spot where we want to insert b words.
    auto it = cbegin(dictionary);
    for (; it != cend(dictionary); ++it) {
        if (*it > *iterLastB)
            break;
    }
    // Add in the b words. This action removes the elements from bWords.
    dictionary.splice(it, bWords);
}
```

```
// Print out the dictionary.
for (const auto& word : dictionary) {
    cout << word << endl;
}
```

The result from running this program looks like this:

```
aardvark
ambulance
bathos
balderdash
canticle
consumerism
```

There are also two other forms of `splice()`: one that inserts a single element from another `list`, and one that inserts a range from another `list`. Additionally, all forms of `splice()` are available with either a normal reference or an rvalue reference to the source `list`.

WARNING *Splicing is destructive to the list passed as an argument: it removes the spliced elements from one list in order to insert them into the other.*

More Efficient Versions of Algorithms

In addition to `splice()`, a `list` provides special implementations of several of the generic Standard Library algorithms. The generic forms are covered in Chapter 18. Here, only the specific versions provided by `list` are discussed.

NOTE *When you have a choice, use the list-specific methods rather than the generic Standard Library algorithms because the former are more efficient. Sometimes you don't have a choice and you must use the list-specific methods; for example, the generic `std::sort()` algorithm requires `RandomAccessIterators`, which a `list` does not provide.*

The following table summarizes the algorithms for which `list` provides special implementations as methods. See Chapter 18 for more details on the algorithms.

METHOD	DESCRIPTION
<code>remove()</code> <code>remove_if()</code>	Removes certain elements from a <code>list</code> .
<code>unique()</code>	Removes duplicate consecutive elements from a <code>list</code> , based on <code>operator==</code> or a user-supplied binary predicate.
<code>merge()</code>	Merges two <code>lists</code> . Both <code>lists</code> must be sorted to start, according to <code>operator<</code> or a user-defined comparator. Like <code>splice()</code> , <code>merge()</code> is destructive to the <code>list</code> passed as an argument.

METHOD	DESCRIPTION
<code>sort()</code>	Performs a stable sort on elements in a list.
<code>reverse()</code>	Reverses the order of the elements in a list.

list Example: Determining Enrollment

Suppose that you are writing a computer registration system for a university. One feature you might provide is the ability to generate a complete list of enrolled students in the university from lists of the students in each class. For the sake of this example, assume that you must write only a single function that takes a vector of lists of student names (as strings), plus a list of students that have been dropped from their courses because they failed to pay tuition. This method should generate a complete list of all the students in all the courses, without any duplicates, and without those students who have been dropped. Note that students might be in more than one course.

Here is the code for this method, with comments explaining the code. With the power of Standard Library lists, the method is practically shorter than its written description! Note that the Standard Library allows you to “nest” containers: in this case, you can use a vector of lists.

```
// courseStudents is a vector of lists, one for each course. The lists
// contain the students enrolled in those courses. They are not sorted.
//
// droppedStudents is a list of students who failed to pay their
// tuition and so were dropped from their courses.
//
// The function returns a list of every enrolled (non-dropped) student in
// all the courses.
list<string> getTotalEnrollment(const vector<list<string>>& courseStudents,
                               const list<string>& droppedStudents)
{
    list<string> allStudents;

    // Concatenate all the course lists onto the master list
    for (auto& lst : courseStudents) {
        allStudents.insert(cend(allStudents), cbegin(lst), cend(lst));
    }

    // Sort the master list
    allStudents.sort();

    // Remove duplicate student names (those who are in multiple courses).
    allStudents.unique();

    // Remove students who are on the dropped list.
    // Iterate through the dropped list, calling remove on the
    // master list for each student in the dropped list.
    for (auto& str : droppedStudents) {
        allStudents.remove(str);
    }

    // done!
    return allStudents;
}
```

NOTE *This example demonstrates the use of the list-specific algorithms. As stated several times before, often a vector is faster than a list. So, the recommended solution to the student enrollment problem would be to only use vectors, and to combine these with generic Standard Library algorithms, but those are discussed in the next chapter.*

forward_list

A `forward_list`, defined in the `<forward_list>` header file, is similar to a `list` except that it is a singly linked list, while a `list` is a doubly linked list. This means that `forward_list` supports only forward iteration and, because of this, ranges need to be specified differently compared to a `list`. If you want to modify any list, you need access to the element before the first element of interest. Because a `forward_list` does not have an iterator that supports going backward, there is no easy way to get to the preceding element. For this reason, ranges that will be modified—for example, ranges supplied to `erase()` and `splice()`—must be open at the beginning. The `begin()` function that was discussed earlier returns an iterator to the first element, and thus can only be used to construct a range that is closed at the beginning. The `forward_list` class therefore defines a `before_begin()` method, which returns an iterator that points to an imaginary element before the beginning of the list. You cannot dereference this iterator as it points to invalid data. However, incrementing this iterator by one makes it the same as the iterator returned by `begin()`; as a result, it can be used to make a range that is open at the beginning. The following table sums up the differences between a `list` and a `forward_list`. A filled box (■) means the container supports that operation, while an empty box (□) means the operation is not supported.

OPERATION	LIST	FORWARD_LIST
<code>assign()</code>	■	■
<code>back()</code>	■	□
<code>before_begin()</code>	□	■
<code>begin()</code>	■	■
<code>cbefore_begin()</code>	□	■
<code>cbegin()</code>	■	■
<code>cend()</code>	■	■
<code>clear()</code>	■	■
<code>crbegin()</code>	■	□
<code>crend()</code>	■	□
<code>emplace()</code>	■	□
<code>emplace_after()</code>	□	■

OPERATION	LIST	FORWARD_LIST
<code>emplace_back()</code>	■	□
<code>emplace_front()</code>	■	■
<code>empty()</code>	■	■
<code>end()</code>	■	■
<code>erase()</code>	■	□
<code>erase_after()</code>	□	■
<code>front()</code>	■	■
<code>insert()</code>	■	□
<code>insert_after()</code>	□	■
<code>iterator / const_iterator</code>	■	■
<code>max_size()</code>	■	■
<code>merge()</code>	■	■
<code>pop_back()</code>	■	□
<code>pop_front()</code>	■	■
<code>push_back()</code>	■	□
<code>push_front()</code>	■	■
<code>rbegin()</code>	■	□
<code>remove()</code>	■	■
<code>remove_if()</code>	■	■
<code>rend()</code>	■	□
<code>resize()</code>	■	■
<code>reverse()</code>	■	■
<code>reverse_iterator / const_reverse_iterator</code>	■	□
<code>size()</code>	■	□
<code>sort()</code>	■	■
<code>splice()</code>	■	□
<code>splice_after()</code>	□	■
<code>swap()</code>	■	■
<code>unique()</code>	■	■

Constructors and assignment operators are similar between a `list` and a `forward_list`. The C++ standard states that `forward_lists` should try to use minimal space. That's the reason why there is no `size()` method, because by not providing it, there is no need to store the size of the list. The following example demonstrates the use of `forward_lists`:

```
// Create 3 forward lists using an initializer_list
// to initialize their elements (uniform initialization).
forward_list<int> list1 = { 5, 6 };
forward_list<int> list2 = { 1, 2, 3, 4 };
forward_list<int> list3 = { 7, 8, 9 };

// Insert list2 at the front of list1 using splice.
list1.splice_after(list1.before_begin(), list2);

// Add number 0 at the beginning of the list1.
list1.push_front(0);

// Insert list3 at the end of list1.
// For this, we first need an iterator to the last element.
auto iter = list1.before_begin();
auto iterTemp = iter;
while (++iterTemp != end(list1)) {
    ++iter;
}
list1.insert_after(iter, cbegin(list3), cend(list3));

// Output the contents of list1.
for (auto& i : list1) {
    cout << i << ' ';
}
}
```

To insert `list3`, you need an iterator to the last element in the list. However, because this is a `forward_list`, you cannot use `--end(list1)`, so you need to iterate over the list from the beginning and stop at the last element. The output of this example is as follows:

```
0 1 2 3 4 5 6 7 8 9
```

array

An `array`, defined in the `<array>` header file, is similar to a `vector` except that it is of a fixed size; it cannot grow or shrink in size. The purpose of a fixed size is to allow an `array` to be allocated on the stack, rather than always demanding heap access as `vector` does. Just like `vectors`, `arrays` support random-access iterators, and elements are stored in contiguous memory. An `array` has support for `front()`, `back()`, `at()`, and `operator[]`. It also supports a `fill()` method to fill the array with a specific element. Because it is fixed in size, it does not support `push_back()`, `pop_back()`, `insert()`, `erase()`, `clear()`, `resize()`, `reserve()`, or `capacity()`. A disadvantage compared to a `vector` is that the `swap()` method of an `array` runs in linear time, while it has constant complexity for a `vector`. An `array` can also not be moved in constant time, while a `vector` can. An `array` has a `size()` method, which is a clear advantage over C-style arrays. The following example demonstrates how to use the `array` class. Note that the `array` declaration requires two template

parameters: the first specifies the type of the elements, and the second specifies the fixed number of elements in the array.

```
// Create an array of 3 integers and initialize them
// with the given initializer_list using uniform initialization.
array<int, 3> arr = { 9, 8, 7 };
// Output the size of the array.
cout << "Array size = " << arr.size() << endl; // or std::size(arr);
// Output the contents using a range-based for loop.
for (const auto& i : arr) {
    cout << i << endl;
}

cout << "Performing arr.fill(3)..." << endl;
// Use the fill method to change the contents of the array.
arr.fill(3);
// Output the contents of the array using iterators.
for (auto iter = cbegin(arr); iter != cend(arr); ++iter) {
    cout << *iter << endl;
}
```

The output of the preceding code is as follows:

```
Array size = 3
9
8
7

Performing arr.fill(3)...
3
3
3
```

You can use the `std::get<n>()` function template to retrieve an element from an `std::array` at the given index n . The index has to be a constant expression, so it cannot, for example, be a loop variable. The benefit of using `std::get<n>()` is that the compiler checks at compile time that the given index is valid; otherwise, it results in a compilation error, as in this example:

```
array<int, 3> myArray{ 11, 22, 33 };
cout << std::get<1>(myArray) << endl;
cout << std::get<10>(myArray) << endl; // Compilation error!
```

CONTAINER ADAPTORS

In addition to the standard sequential containers, the Standard Library provides three container adaptors: `queue`, `priority_queue`, and `stack`. Each of these adaptors is a wrapper around one of the sequential containers. They allow you to swap the underlying container without having to change the rest of the code. The intent of the adaptors is to simplify the interface and to provide only those features that are appropriate for the `stack` or `queue` abstraction. For example, the adaptors don't provide iterators or the capability to insert or erase multiple elements simultaneously.

queue

The `queue` container adaptor, defined in the header file `<queue>`, provides standard “first-in, first-out” (FIFO) semantics. As usual, it’s written as a class template, which looks like this:

```
template <class T, class Container = deque<T>> class queue;
```

The `T` template parameter specifies the type that you intend to store in the `queue`. The second template parameter allows you to stipulate the underlying container that the `queue` adapts. However, the `queue` requires the sequential container to support both `push_back()` and `pop_front()`, so you have only two built-in choices: `deque` and `list`. For most purposes, you can just stick with the default `deque`.

queue Operations

The `queue` interface is extremely simple: there are only eight methods plus the constructor and the normal comparison operators. The `push()` and `emplace()` methods add a new element to the tail of the queue, while `pop()` removes the element at the head of the queue. You can retrieve references to, without removing, the first and last elements with `front()` and `back()`, respectively. As usual, when called on `const` objects, `front()` and `back()` return `const` references; and when called on non-`const` objects, they return non-`const` (read/write) references.

WARNING `pop()` does not return the element popped. If you want to retain a copy, you must first retrieve it with `front()`.

The `queue` also supports `size()`, `empty()`, and `swap()`.

queue Example: A Network Packet Buffer

When two computers communicate over a network, they send information to each other divided up into discrete chunks called *packets*. The networking layer of the computer’s operating system must pick up the packets and store them as they arrive. However, the computer might not have enough bandwidth to process all of them at once. Thus, the networking layer usually *buffers*, or stores, the packets until the higher layers have a chance to attend to them. The packets should be processed in the order they arrive, so this problem is perfect for a `queue` structure. The following is a small `PacketBuffer` class, with comments explaining the code, which stores incoming packets in a `queue` until they are processed. It’s a class template so that different layers of the networking layer can use it for different kinds of packets, such as IP packets or TCP packets. It allows the client to specify a maximum size because operating systems usually limit the number of packets that can be stored, so as not to use too much memory. When the buffer is full, subsequently arriving packets are ignored.

```
template <typename T>
class PacketBuffer
{
public:
    // If maxSize is 0, the size is unlimited, because creating
    // a buffer of size 0 makes little sense. Otherwise only
    // maxSize packets are allowed in the buffer at any one time.
```

```

    PacketBuffer(size_t maxSize = 0);

    virtual ~PacketBuffer() = default;

    // Stores a packet in the buffer.
    // Returns false if the packet has been discarded because
    // there is no more space in the buffer, true otherwise.
    bool bufferPacket(const T& packet);

    // Returns the next packet. Throws out_of_range
    // if the buffer is empty.
    T getNextPacket();
private:
    std::queue<T> mPackets;
    size_t mMaxSize;
};

template <typename T> PacketBuffer<T>::PacketBuffer(size_t maxSize/*= 0*/)
    : mMaxSize(maxSize)
{
}

template <typename T> bool PacketBuffer<T>::bufferPacket(const T& packet)
{
    if (mMaxSize > 0 && mPackets.size() == mMaxSize) {
        // No more space. Drop the packet.
        return false;
    }
    mPackets.push(packet);
    return true;
}

template <typename T> T PacketBuffer<T>::getNextPacket()
{
    if (mPackets.empty()) {
        throw std::out_of_range("Buffer is empty");
    }
    // Retrieve the head element
    T temp = mPackets.front();
    // Pop the head element
    mPackets.pop();
    // Return the head element
    return temp;
}

```

A practical application of this class would require multiple threads. C++ provides synchronization classes to allow thread-safe access to shared objects. Without explicit synchronization, no Standard Library object can be used safely from multiple threads when at least one of the threads modifies the object. Synchronization is discussed in Chapter 23. The focus in this example is on the `queue` class, so here is a single-threaded example of using the `PacketBuffer`:

```

class IPPacket final
{
public:
    IPPacket(int id) : mID(id) {}
    int getID() const { return mID; }
}

```

```
private:
    int mID;
};

int main()
{
    PacketBuffer<IPPacket> ipPackets(3);

    // Add 4 packets
    for (int i = 1; i <= 4; ++i) {
        if (!ipPackets.bufferPacket(IPPacket(i))) {
            cout << "Packet " << i << " dropped (queue is full)." << endl;
        }
    }

    while (true) {
        try {
            IPPacket packet = ipPackets.getNextPacket();
            cout << "Processing packet " << packet.getID() << endl;
        } catch (const out_of_range&) {
            cout << "Queue is empty." << endl;
            break;
        }
    }
    return 0;
}
```

The output of this program is as follows:

```
Packet 4 dropped (queue is full).
Processing packet 1
Processing packet 2
Processing packet 3
Queue is empty.
```

priority_queue

A *priority queue* is a queue that keeps its elements in sorted order. Instead of a strict FIFO ordering, the element at the head of the queue at any given time is the one with the highest priority. This element could be the oldest on the queue or the most recent. If two elements have equal priority, their relative order in the queue is undefined.

The `priority_queue` container adaptor is also defined in `<queue>`. Its template definition looks something like this (slightly simplified):

```
template <class T, class Container = vector<T>,
          class Compare = less<T>>;
```

It's not as complicated as it looks. You've seen the first two parameters before: `T` is the element type stored in the `priority_queue` and `Container` is the underlying container on which the `priority_queue` is adapted. The `priority_queue` uses `vector` as the default, but `deque` works as well. `list` does not work because the `priority_queue` requires random access to its elements. The third parameter, `Compare`, is trickier. As you'll learn more about in Chapter 18, `less` is a class template that supports comparison of two objects of type `T` with `operator<`. What this means for you is

that the priority of elements in a `priority_queue` is determined according to `operator<`. You can customize the comparison used, but that's a topic for Chapter 18. For now, just make sure that you define `operator<` appropriately for the types stored in a `priority_queue`.

NOTE *The head element of a `priority_queue` is the one with the “highest” priority; by default, this is determined according to `operator<` such that elements that are “less” than other elements have lower priority.*

priority_queue Operations

A `priority_queue` provides even fewer operations than does a `queue`. The `push()` and `emplace()` methods allow you to insert elements, `pop()` allows you to remove elements, and `top()` returns a `const` reference to the head element.

WARNING `top()` returns a `const` reference even when called on a non-`const` object, because modifying the element might change its order, which is not allowed. A `priority_queue` provides no mechanism to obtain the tail element.

WARNING `pop()` does not return the element popped. If you want to retain a copy, you must first retrieve it with `top()`.

Like a `queue`, a `priority_queue` supports `size()`, `empty()`, and `swap()`. However, it does not provide any comparison operators.

priority_queue Example: An Error Correlator

Single failures on a system can often cause multiple errors to be generated from different components. A good error-handling system uses *error correlation* to process the most important errors first. You can use a `priority_queue` to write a very simple error correlator. Assume all error events encode their own priority. The error correlator simply sorts error events according to their priority, so that the highest-priority errors are always processed first. Here is the class definition:

```
// Sample Error class with just a priority and a string error description.
class Error final
{
public:
    Error(int priority, std::string_view errorString)
        : mPriority(priority), mErrorString(errorString) {}

    int getPriority() const { return mPriority; }
    std::string_view getErrorString() const { return mErrorString; }
```

```

    private:
        int mPriority;
        std::string mErrorString;
};

bool operator<(const Error& lhs, const Error& rhs);
std::ostream& operator<<(std::ostream& os, const Error& err);

// Simple ErrorCorrelator class that returns highest priority errors first.
class ErrorCorrelator final
{
public:
    // Add an error to be correlated.
    void addError(const Error& error);
    // Retrieve the next error to be processed.
    Error getError();
private:
    std::priority_queue<Error> mErrors;
};

```

Here are the definitions of the functions and methods:

```

bool operator<(const Error& lhs, const Error& rhs)
{
    return (lhs.getPriority() < rhs.getPriority());
}

ostream& operator<<(ostream& os, const Error& err)
{
    os << err.getErrorString() << " (priority " << err.getPriority() << ")";
    return os;
}

void ErrorCorrelator::addError(const Error& error)
{
    mErrors.push(error);
}

Error ErrorCorrelator::getError()
{
    // If there are no more errors, throw an exception.
    if (mErrors.empty()) {
        throw out_of_range("No more errors.");
    }
    // Save the top element.
    Error top = mErrors.top();
    // Remove the top element.
    mErrors.pop();
    // Return the saved element.
    return top;
}

```

Here is a simple unit test showing how to use the `ErrorCorrelator`. Realistic use would require multiple threads so that one thread adds errors, while another processes them. As mentioned earlier with the queue example, this requires explicit synchronization, which is only discussed in Chapter 23.

```

ErrorCorrelator ec;
ec.addError(Error(3, "Unable to read file"));
ec.addError(Error(1, "Incorrect entry from user"));
ec.addError(Error(10, "Unable to allocate memory!"));

while (true) {
    try {
        Error e = ec.getError();
        cout << e << endl;
    } catch (const out_of_range&) {
        cout << "Finished processing errors" << endl;
        break;
    }
}

```

The output of this program is as follows:

```

Unable to allocate memory! (priority 10)
Unable to read file (priority 3)
Incorrect entry from user (priority 1)
Finished processing errors

```

stack

A *stack* is almost identical to a queue, except that it provides *first-in, last-out (FILO)* semantics, also known as *last-in, first-out (LIFO)*, instead of FIFO. It is defined in the `<stack>` header file. The template definition looks like this:

```
template <class T, class Container = deque<T>> class stack;
```

You can use `vector`, `list`, or `deque` as the underlying container for the stack.

stack Operations

Like the queue, the stack provides `push()`, `emplace()`, and `pop()`. The difference is that `push()` adds a new element to the top of the stack, “pushing down” all elements inserted earlier, and `pop()` removes the element from the top of the stack, which is the most recently inserted element. The `top()` method returns a `const` reference to the top element if called on a `const` object, and a non-`const` reference if called on a non-`const` object.

WARNING `pop()` does not return the element popped. If you want to retain a copy, you must first retrieve it with `top()`.

The stack supports `empty()`, `size()`, `swap()`, and the standard comparison operators.

stack Example: Revised Error Correlator

You can rewrite the previous `ErrorCorrelator` class so that it gives out the most recent error instead of the one with the highest priority. The only change required is to change `mErrors` from a `priority_queue` to a `stack`. With this change, the errors are distributed in LIFO order instead

of priority order. Nothing in the method definitions needs to change because the `push()`, `pop()`, `top()`, and `empty()` methods exist on both a `priority_queue` and a `stack`.

ORDERED ASSOCIATIVE CONTAINERS

Unlike the sequential containers, the ordered associative containers do not store elements in a linear configuration. Instead, they provide a mapping of keys to values. They generally offer insertion, deletion, and lookup times that are equivalent to each other.

There are four ordered associative containers provided by the Standard Library: `map`, `multimap`, `set`, and `multiset`. Each of these containers stores its elements in a *sorted*, tree-like data structure. There are also four unordered associative containers: `unordered_map`, `unordered_multimap`, `unordered_set`, and `unordered_multiset`. These are discussed later in this chapter.

The pair Utility Class

Before learning about the ordered associative containers, you must become familiar with the `pair` class, which is defined in the `<utility>` header file. `pair` is a class template that groups together two values of possibly different types. The values are accessible through the `first` and `second` public data members. `operator==` and `operator<` are defined for pairs to compare both the `first` and `second` elements. Here are some examples:

```
// Two-argument constructor and default constructor
pair<string, int> myPair("hello", 5);
pair<string, int> myOtherPair;

// Can assign directly to first and second
myOtherPair.first = "hello";
myOtherPair.second = 6;

// Copy constructor
pair<string, int> myThirdPair(myOtherPair);

// operator<
if (myPair < myOtherPair) {
    cout << "myPair is less than myOtherPair" << endl;
} else {
    cout << "myPair is greater than or equal to myOtherPair" << endl;
}

// operator==
if (myOtherPair == myThirdPair) {
    cout << "myOtherPair is equal to myThirdPair" << endl;
} else {
    cout << "myOtherPair is not equal to myThirdPair" << endl;
}
```

The output is as follows:

```
myPair is less than myOtherPair
myOtherPair is equal to myThirdPair
```

The library also provides a utility function template, `make_pair()`, that constructs a `pair` from two values, as in this example:

```
pair<int, double> aPair = make_pair(5, 10.10);
```

Of course, in this case you could have just used the two-argument constructor. However, `make_pair()` is more useful when you want to pass a `pair` to a function, or assign it to a pre-existing variable. Unlike class templates, function templates can infer types from parameters, so you can use `make_pair()` to construct a `pair` without explicitly specifying the types. You can also use `make_pair()` in combination with the `auto` keyword as follows:

```
auto aSecondPair = make_pair(5, 10.10);
```

C++17

C++17 introduces template parameter deduction for constructors, as discussed in Chapter 12. This allows you to forget about `make_pair()`, and simply write the following:

```
auto aThirdPair = pair(5, 10.10);
```

C++17

Structured bindings is another C++17 feature introduced in Chapter 1. It can be used to decompose the elements of a `pair` into separate variables. Here’s an example:

```
pair<string, int> myPair("hello", 5);
auto[theString, theInt] = myPair; // Decompose using structured bindings
cout << "theString: " << theString << endl;
cout << "theInt: " << theInt << endl;
```

map

A `map`, defined in the `<map>` header file, stores key/value pairs instead of just single values. Insertion, lookup, and deletion are all based on the key; the value is just “along for the ride.” The term *map* comes from the conceptual understanding that the container “maps” keys to values.

A `map` keeps elements in sorted order, based on the keys, so that insertion, deletion, and lookup all take logarithmic time. Because of the order, when you enumerate the elements, they come out in the ordering imposed by the type’s `operator<` or a user-defined comparator. It is usually implemented as some form of balanced tree, such as a red-black tree. However, the tree structure is not exposed to the client.

You should use a `map` whenever you need to store and retrieve elements based on a “key” and you would like to have them in a certain order.

Constructing maps

The `map` class template takes four types: the key type, the value type, the comparison type, and the allocator type. As always, the allocator is ignored in this chapter. The comparison type is similar to the comparison type for a `priority_queue` described earlier. It allows you to specify a different comparison class than the default. In this chapter, only the default `less` comparison is used. When using the default, make sure that your keys all respond to `operator<` appropriately. If you’re interested in further detail, Chapter 18 explains how to write your own comparison classes.

If you ignore the comparison and allocator parameters, constructing a `map` is just like constructing a `vector` or a `list`, except that you specify the key and value types separately in the template

instantiation. For example, the following code constructs a map that uses ints as the key and stores objects of the Data class:

```
class Data final
{
    public:
        explicit Data(int value = 0) : mValue(value) { }
        int getValue() const { return mValue; }
        void setValue(int value) { mValue = value; }

    private:
        int mValue;
};
...
map<int, Data> dataMap;
```

A map also supports uniform initialization:

```
map<string, int> m = {
    { "Marc G.", 123 },
    { "Warren B.", 456 },
    { "Peter V.W.", 789 }
};
```

Inserting Elements

Inserting an element into sequential containers such as `vector` and `list` always requires you to specify the position at which the element is to be added. A `map`, along with the other ordered associative containers, is different. The `map`'s internal implementation determines the position in which to store the new element; you need only to supply the key and the value.

NOTE `map` and the other ordered associative containers do provide a version of `insert()` that takes an iterator position. However, that position is only a “hint” to the container as to the correct position. The container is not required to insert the element at that position.

When inserting elements, it is important to keep in mind that maps require unique keys: every element in the map must have a different key. If you want to support multiple elements with the same key, you have two options: you can either use a map and store another container such as a `vector` or an array as the value for a key, or you can use `multimaps`, described later.

The insert() Method

The `insert()` method can be used to add elements to a map, and has the advantage of allowing you to detect if a key already exists. You must specify the key/value pair as a `pair` object or as an `initializer_list`. The return type of the basic form of `insert()` is a pair of an iterator and a `bool`. The reason for the complicated return type is that `insert()` does not overwrite an element value if one already exists with the specified key. The `bool` element of the returned `pair` specifies

whether or not the `insert()` actually inserted the new key/value pair. The iterator refers to the element in the map with the specified key (with a new or old value, depending on whether the insert succeeded or failed). map iterators are discussed in more detail in the next section. Continuing the map example from the previous section, you can use `insert()` as follows:

```
map<int, Data> dataMap;

auto ret = dataMap.insert({ 1, Data(4) }); // Using an initializer_list
if (ret.second) {
    cout << "Insert succeeded!" << endl;
} else {
    cout << "Insert failed!" << endl;
}

ret = dataMap.insert(make_pair(1, Data(6))); // Using a pair object
if (ret.second) {
    cout << "Insert succeeded!" << endl;
} else {
    cout << "Insert failed!" << endl;
}
```

The type of the `ret` variable is a pair as follows:

```
pair<map<int, Data>::iterator, bool> ret;
```

The first element of the pair is a map iterator for a map with keys of type `int` and values of type `Data`. The second element of the pair is a Boolean value.

The output of the program is as follows:

```
Insert succeeded!
Insert failed!
```

C++17

With initializers for `if` statements (C++17), inserting the data into the map and checking the result can be done with a single statement as follows:

```
if (auto result = dataMap.insert({ 1, Data(4) }); result.second) {
    cout << "Insert succeeded!" << endl;
} else {
    cout << "Insert failed!" << endl;
}
```

This can even be combined with C++17 structured bindings:

```
if (auto [iter, success] = dataMap.insert({ 1, Data(4) }); success) {
    cout << "Insert succeeded!" << endl;
} else {
    cout << "Insert failed!" << endl;
}
```

C++17

The `insert_or_assign()` Method

`insert_or_assign()` has a similar return type as `insert()`. However, if an element with the given key already exists, `insert_or_assign()` overwrites the old value with the new value, while

`insert()` does not overwrite the old value in that case. Another difference with `insert()` is that `insert_or_assign()` has two separate parameters: the key and the value. Here is an example:

```
ret = dataMap.insert_or_assign(1, Data(7));
if (ret.second) {
    cout << "Inserted." << endl;
} else {
    cout << "Overwritten." << endl;
}
```

operator[]

Another method to insert elements into a map is through the overloaded operator `[]`. The difference is mainly in the syntax: you specify the key and value separately. Additionally, `operator[]` always succeeds. If no element value with the given key exists, it creates a new element with that key and value. If an element with the key already exists, `operator[]` replaces the element value with the newly specified value. Here is part of the previous example using `operator[]` instead of `insert()`:

```
map<int, Data> dataMap;
dataMap[1] = Data(4);
dataMap[1] = Data(6); // Replaces the element with key 1
```

There is, however, one major caveat to `operator[]`: it always constructs a new value object, even if it doesn't need to use it. Thus, it requires a default constructor for your element values, and can be less efficient than `insert()`.

The fact that `operator[]` creates a new element in a map if the requested element does not already exist means that this operator is not marked as `const`. This sounds obvious, but might sometimes look counterintuitive. For example, suppose you have the following function:

```
void func(const map<int, int>& m)
{
    cout << m[1] << endl; // Error
}
```

This fails to compile, even though you appear to be just reading the value `m[1]`. It fails because the variable `m` is a `const` reference to a map, and `operator[]` is not marked as `const`. Instead, you should use the `find()` method described in the section “Looking Up Elements.”

Emplace Methods

A map supports `emplace()` and `emplace_hint()` to construct elements in-place, similar to the `emplace` methods of a vector. C++17 adds a `try_emplace()` method that inserts an element in-place if the given key does not exist yet, or does nothing if the key already exists in the map.

map Iterators

map iterators work similarly to the iterators on the sequential containers. The major difference is that the iterators refer to key/value pairs instead of just the values. In order to access the value, you must retrieve the `second` field of the `pair` object. map iterators are bidirectional, meaning you can traverse them in both directions. Here is how you can iterate through the map from the previous example:

```
for (auto iter = cbegin(dataMap); iter != cend(dataMap); ++iter) {
    cout << iter->second.getValue() << endl;
}
```

Take another look at the expression used to access the value:

```
iter->second.getValue()
```

`iter` refers to a key/value pair, so you can use the `->` operator to access the second field of that pair, which is a `Data` object. You can then call the `getValue()` method on that `Data` object.

Note that the following code is functionally equivalent:

```
(*iter).second.getValue()
```

Using a range-based `for` loop, the loop can be written more readable as follows:

```
for (const auto& p : dataMap) {
    cout << p.second.getValue() << endl;
}
```

It can be implemented even more elegantly using a combination of a range-based `for` loop and C++17 structured bindings:

```
for (const auto& [key, data] : dataMap) {
    cout << data.getValue() << endl;
}
```

WARNING *You can modify element values through non-const iterators, but the compiler will generate an error if you try to modify the key of an element, even through a non-const iterator, because it would destroy the sorted order of the elements in the map.*

Looking Up Elements

A `map` provides logarithmic lookup of elements based on a supplied key. If you already know that an element with a given key is in a map, the simplest way to look it up is through `operator[]` as long as you call it on a non-const map or a non-const reference to a map. The nice thing about `operator[]` is that it returns a reference to the element that you can use and modify directly, without worrying about pulling the value out of a pair object. Here is an extension to the preceding example to call the `setValue()` method on the `Data` object value at key 1:

```
map<int, Data> dataMap;
dataMap[1] = Data(4);
dataMap[1] = Data(6);
dataMap[1].setValue(100);
```

However, if you don't know whether the element exists, you may not want to use `operator[]`, because it will insert a new element with that key if it doesn't find one already. As an alternative, `map` provides a `find()` method that returns an iterator referring to the element with the specified key, if it exists, or the `end()` iterator if it's not in the map. Here is an example using `find()` to perform the same modification to the `Data` object with key 1:

```
auto it = dataMap.find(1);
if (it != end(dataMap)) {
    it->second.setValue(100);
}
```

As you can see, using `find()` is a bit clumsier, but it's sometimes necessary.

If you only want to know whether or not an element with a certain key is in a `map`, you can use the `count()` method. It returns the number of elements in a `map` with a given key. For `maps`, the result will always be 0 or 1 because there can be no elements with duplicate keys.

Removing Elements

A `map` allows you to remove an element at a specific iterator position or to remove all elements in a given iterator range, in amortized constant and logarithmic time, respectively. From the client perspective, these two `erase()` methods are equivalent to those in the sequential containers. A great feature of a `map`, however, is that it also provides a version of `erase()` to remove an element matching a key. Here is an example:

```
map<int, Data> dataMap;
dataMap[1] = Data(4);
cout << "There are " << dataMap.count(1) << " elements with key 1" << endl;
dataMap.erase(1);
cout << "There are " << dataMap.count(1) << " elements with key 1" << endl;
```

The output is as follows:

```
There are 1 elements with key 1
There are 0 elements with key 1
```

C++17

Nodes

All the ordered and unordered associative containers are so-called *node-based* data structures. Starting with C++17, the Standard Library provides direct access to *nodes* in the form of *node handles*. The exact type is unspecified, but each container has a type alias called `node_type` that specifies the type of a node handle for that container. A node handle can only be moved, and is the owner of the element stored in a node. It provides read/write access to both the key and the value.

Nodes can be extracted from an associative container as a node handle using the `extract()` method, based either on a given iterator position or on a given key. Extracting a node from a container removes it from the container, because the returned node handle is the sole owner of the extracted element.

New `insert()` overloads are provided that allow you to insert a node handle into a container.

Using `extract()` to extract node handles, and `insert()` to insert node handles, you can effectively transfer data from one associative container to another one without any copying or moving involved. You can even move nodes from a `map` to a `multimap`, and from a `set` to a `multiset`. Continuing with the example from the previous section, the following code snippet transfers the node with key 1 to a second `map`:

```
map<int, Data> dataMap2;
auto extractedNode = dataMap.extract(1);
dataMap2.insert(std::move(extractedNode));
```

The last two lines can be combined into one:

```
dataMap2.insert(dataMap.extract(1));
```

One additional operation is available to move all nodes from one associative container to another one: `merge()`. Nodes that cannot be moved because they would cause, for example, duplicates in a target container that does not allow duplicates, are left in the source container. Here is an example:

```
map<int, int> src = { {1, 11}, {2, 22} };
map<int, int> dst = { {2, 22}, {3, 33}, {4, 44}, {5, 55} };
dst.merge(src);
```

After the merge operation, `src` still contains one element, `{2, 22}`, because the destination already contains such an element, so it cannot be moved. `dst` contains `{1, 11}`, `{2, 22}`, `{3, 33}`, `{4, 44}`, and `{5, 55}` after the operation.

map Example: Bank Account

You can implement a simple bank account database using a `map`. A common pattern is for the key to be one field of a `class` or `struct` that is stored in a `map`. In this case, the key is the account number. Here are simple `BankAccount` and `BankDB` classes:

```
class BankAccount final
{
public:
    BankAccount(int acctNum, std::string_view name)
        : mAcctNum(acctNum), mClientName(name) {}

    void setAcctNum(int acctNum) { mAcctNum = acctNum; }
    int getAcctNum() const { return mAcctNum; }

    void setClientName(std::string_view name) { mClientName = name; }
    std::string_view getClientName() const { return mClientName; }
private:
    int mAcctNum;
    std::string mClientName;
};

class BankDB final
{
public:
    // Adds account to the bank database. If an account exists already
    // with that number, the new account is not added. Returns true
    // if the account is added, false if it's not.
    bool addAccount(const BankAccount& account);

    // Removes the account acctNum from the database.
    void deleteAccount(int acctNum);

    // Returns a reference to the account represented
    // by its number or the client name.
    // Throws out_of_range if the account is not found.
    BankAccount& findAccount(int acctNum);
    BankAccount& findAccount(std::string_view name);
};
```

```
        // Adds all the accounts from db to this database.
        // Deletes all the accounts from db.
        void mergeDatabase(BankDB& db);
    private:
        std::map<int, BankAccount> mAccounts;
};
```

Here are the implementations of the BankDB methods, with comments explaining the code:

```
bool BankDB::addAccount(const BankAccount& acct)
{
    // Do the actual insert, using the account number as the key
    auto res = mAccounts.emplace(acct.getAcctNum(), acct);
    // or: auto res = mAccounts.insert(make_pair(acct.getAcctNum(), acct));

    // Return the bool field of the pair specifying success or failure
    return res.second;
}

void BankDB::deleteAccount(int acctNum)
{
    mAccounts.erase(acctNum);
}

BankAccount& BankDB::findAccount(int acctNum)
{
    // Finding an element via its key can be done with find()
    auto it = mAccounts.find(acctNum);
    if (it == end(mAccounts)) {
        throw out_of_range("No account with that number.");
    }
    // Remember that iterators into maps refer to pairs of key/value
    return it->second;
}

BankAccount& BankDB::findAccount(string_view name)
{
    // Finding an element by a non-key attribute requires a linear
    // search through the elements. Uses C++17 structured bindings.
    for (auto& [acctNum, account] : mAccounts) {
        if (account.getClientName() == name) {
            return account; // found it!
        }
    }
    // If your compiler doesn't support the above C++17 structured
    // bindings yet, you can use the following implementation
    //for (auto& p : mAccounts) {
    //    if (p.second.getClientName() == name) { return p.second; }
    //}

    throw out_of_range("No account with that name.");
}
```

```

void BankDB::mergeDatabase(BankDB& db)
{
    // Use C++17 merge().
    mAccounts.merge(db.mAccounts);
    // Or: mAccounts.insert(begin(db.mAccounts), end(db.mAccounts));

    // Now clear the source database.
    db.mAccounts.clear();
}

```

You can test the BankDB class with the following code:

```

BankDB db;
db.addAccount(BankAccount(100, "Nicholas Solter"));
db.addAccount(BankAccount(200, "Scott Kleper"));

try {
    auto& acct = db.findAccount(100);
    cout << "Found account 100" << endl;
    acct.setClientName("Nicholas A Solter");

    auto& acct2 = db.findAccount("Scott Kleper");
    cout << "Found account of Scott Kleper" << endl;

    auto& acct3 = db.findAccount(1000);
} catch (const out_of_range& caughtException) {
    cout << "Unable to find account: " << caughtException.what() << endl;
}

```

The output is as follows:

```

Found account 100
Found account of Scott Kleper
Unable to find account: No account with that number.

```

multimap

A multimap is a map that allows multiple elements with the same key. Like maps, multimaps support uniform initialization. The interface is almost identical to the map interface, with the following differences:

- multimaps do not provide operator[] and at(). The semantics of these do not make sense if there can be multiple elements with a single key.
- Inserts on multimaps always succeed. Thus, the multimap::insert() method that adds a single element returns just an iterator instead of a pair.
- The insert_or_assign() and try_emplace() methods supported by map are not supported by a multimap.

NOTE multimaps allow you to insert identical key/value pairs. If you want to avoid this redundancy, you must check explicitly before inserting a new element.

The trickiest aspect of `multimaps` is looking up elements. You can't use `operator[]`, because it is not provided. `find()` isn't very useful because it returns an iterator referring to any one of the elements with a given key (not necessarily the first element with that key).

However, `multimaps` store all elements with the same key together and provide methods to obtain iterators for this subrange of elements with the same key in the container. The `lower_bound()` and `upper_bound()` methods each return a single iterator referring to the first and one-past-the-last elements matching a given key. If there are no elements matching that key, the iterators returned by `lower_bound()` and `upper_bound()` will be equal to each other.

If you need to obtain both iterators bounding the elements with a given key, it's more efficient to use `equal_range()` instead of calling `lower_bound()` followed by calling `upper_bound()`. The `equal_range()` method returns a pair of the two iterators that would be returned by `lower_bound()` and `upper_bound()`.

NOTE *The `lower_bound()`, `upper_bound()`, and `equal_range()` methods exist for maps as well, but their usefulness is limited because a map cannot have multiple elements with the same key.*

multimap Example: Buddy Lists

Most of the numerous online chat programs allow users to have a “buddy list” or list of friends. The chat program confers special privileges on users in the buddy list, such as allowing them to send unsolicited messages to the user.

One way to implement the buddy lists for an online chat program is to store the information in a `multimap`. One `multimap` could store the buddy lists for every user. Each entry in the container stores one buddy for a user. The key is the user and the value is the buddy. For example, if Harry Potter and Ron Weasley had each other on their individual buddy lists, there would be two entries of the form “Harry Potter” maps to “Ron Weasley” and “Ron Weasley” maps to “Harry Potter.” A `multimap` allows multiple values for the same key, so the same user is allowed multiple buddies. Here is the `BuddyList` class definition:

```
class BuddyList final
{
public:
    // Adds buddy as a friend of name.
    void addBuddy(const std::string& name, const std::string& buddy);
    // Removes buddy as a friend of name
    void removeBuddy(const std::string& name, const std::string& buddy);
    // Returns true if buddy is a friend of name, false otherwise.
    bool isBuddy(const std::string& name, const std::string& buddy) const;
    // Retrieves a list of all the friends of name.
    std::vector<std::string> getBuddies(const std::string& name) const;
private:
    std::multimap<std::string, std::string> mBuddies;
};
```

Here is the implementation, with comments explaining the code. It demonstrates the use of `lower_bound()`, `upper_bound()`, and `equal_range()`:

```

void BuddyList::addBuddy(const string& name, const string& buddy)
{
    // Make sure this buddy isn't already there. We don't want
    // to insert an identical copy of the key/value pair.
    if (!isBuddy(name, buddy)) {
        mBuddies.insert({ name, buddy }); // Using initializer_list
    }
}

void BuddyList::removeBuddy(const string& name, const string& buddy)
{
    // Obtain the beginning and end of the range of elements with
    // key 'name'. Use both lower_bound() and upper_bound() to demonstrate
    // their use. Otherwise, it's more efficient to call equal_range().
    auto begin = mBuddies.lower_bound(name); // Start of the range
    auto end = mBuddies.upper_bound(name); // End of the range

    // Iterate through the elements with key 'name' looking
    // for a value 'buddy'. If there are no elements with key 'name',
    // begin equals end, so the loop body doesn't execute.
    for (auto iter = begin; iter != end; ++iter) {
        if (iter->second == buddy) {
            // We found a match! Remove it from the map.
            mBuddies.erase(iter);
            break;
        }
    }
}

bool BuddyList::isBuddy(const string& name, const string& buddy) const
{
    // Obtain the beginning and end of the range of elements with
    // key 'name' using equal_range(), and C++17 structured bindings.
    auto [begin, end] = mBuddies.equal_range(name);

    // Iterate through the elements with key 'name' looking
    // for a value 'buddy'.
    for (auto iter = begin; iter != end; ++iter) {
        if (iter->second == buddy) {
            // We found a match!
            return true;
        }
    }
    // No matches
    return false;
}

vector<string> BuddyList::getBuddies(const string& name) const
{
    // Obtain the beginning and end of the range of elements with
    // key 'name' using equal_range(), and C++17 structured bindings.

```

```
    auto [begin, end] = mBuddies.equal_range(name);

    // Create a vector with all names in the range (all buddies of name).
    vector<string> buddies;
    for (auto iter = begin; iter != end; ++iter) {
        buddies.push_back(iter->second);
    }
    return buddies;
}
```

This implementation uses C++17 structured bindings, as in this example:

```
    auto [begin, end] = mBuddies.equal_range(name);
```

If your compiler doesn't support structured bindings yet, then you can write the following:

```
    auto range = mBuddies.equal_range(name);
    auto begin = range.first; // Start of the range
    auto end = range.second;  // End of the range
```

Note that `removeBuddy()` can't simply use the version of `erase()` that erases all elements with a given key, because it should erase only one element with the key, not all of them. Note also that `getBuddies()` can't use `insert()` on the vector to insert the elements in the range returned by `equal_range()`, because the elements referred to by the `multimap` iterators are key/value pairs, not strings. The `getBuddies()` method must iterate explicitly through the range extracting the string from each key/value pair and pushing it onto the new vector to be returned.

Here is a test of the `BuddyList`:

```
BuddyList buddies;
buddies.addBuddy("Harry Potter", "Ron Weasley");
buddies.addBuddy("Harry Potter", "Hermione Granger");
buddies.addBuddy("Harry Potter", "Hagrid");
buddies.addBuddy("Harry Potter", "Draco Malfoy");
// That's not right! Remove Draco.
buddies.removeBuddy("Harry Potter", "Draco Malfoy");
buddies.addBuddy("Hagrid", "Harry Potter");
buddies.addBuddy("Hagrid", "Ron Weasley");
buddies.addBuddy("Hagrid", "Hermione Granger");

auto harrysFriends = buddies.getBuddies("Harry Potter");

cout << "Harry's friends: " << endl;
for (const auto& name : harrysFriends) {
    cout << "\t" << name << endl;
}
```

The output is as follows:

```
Harry's friends:
    Ron Weasley
    Hermione Granger
    Hagrid
```

set

A `set`, defined in `<set>`, is very similar to a `map`. The difference is that instead of storing key/value pairs, in `sets` the key is the value. `sets` are useful for storing information in which there is no explicit key, but which you want to have in sorted order without any duplicates, with quick insertion, lookup, and deletion.

The interface supplied by `set` is almost identical to that of `map`. The main difference is that `set` doesn't provide `operator[]`, `insert_or_assign()`, and `try_emplace()`.

You cannot change the key/value of elements in a `set` because modifying elements of a `set` while they are in the container would destroy the order.

set Example: Access Control List

One way to implement basic security on a computer system is through access control lists. Each entity on the system, such as a file or a device, has a list of users with permissions to access that entity. Users can generally be added to and removed from the permissions list for an entity only by users with special privileges. Internally, a `set` provides a nice way to represent the access control list. You could use one `set` for each entity, containing all the usernames who are allowed to access the entity. Here is a class definition for a simple access control list:

```
class AccessList final
{
public:
    // Default constructor
    AccessList() = default;
    // Constructor to support uniform initialization.
    AccessList(std::initializer_list<std::string_view> initlist);
    // Adds the user to the permissions list.
    void addUser(std::string_view user);
    // Removes the user from the permissions list.
    void removeUser(std::string_view user);
    // Returns true if the user is in the permissions list.
    bool isAllowed(std::string_view user) const;
    // Returns a vector of all the users who have permissions.
    std::vector<std::string> getAllUsers() const;
private:
    std::set<std::string> mAllowed;
};
```

Here are the method definitions:

```
AccessList::AccessList(initializer_list<string_view> initlist)
{
    mAllowed.insert(begin(initlist), end(initlist));
}

void AccessList::addUser(string_view user)
{
    mAllowed.emplace(user);
}
```

```
void AccessList::removeUser(string_view user)
{
    mAllowed.erase(string(user));
}

bool AccessList::isAllowed(string_view user) const
{
    return (mAllowed.count(string(user)) != 0);
}

vector<string> AccessList::getAllUsers() const
{
    return { begin(mAllowed), end(mAllowed) };
}
```

Take a look at the interesting one-line implementation of `getAllUsers()`. That one line constructs a `vector<string>` to return, by passing a `begin` and `end` iterator of `mAllowed` to the vector constructor. If you want, you can split this over two lines:

```
vector<string> users(begin(mAllowed), end(mAllowed));
return users;
```

Finally, here is a simple test program:

```
AccessList fileX = { "pvw", "mgregoire", "baduser" };
fileX.removeUser("baduser");

if (fileX.isAllowed("mgregoire")) {
    cout << "mgregoire has permissions" << endl;
}

if (fileX.isAllowed("baduser")) {
    cout << "baduser has permissions" << endl;
}

auto users = fileX.getAllUsers();
for (const auto& user : users) {
    cout << user << " ";
}
```

One of the constructors for `AccessList` uses an `initializer_list` as a parameter, so that you can use the uniform initialization syntax, as demonstrated in the test program for initializing `fileX`.

The output of this program is as follows:

```
mgregoire has permissions
mgregoire pvw
```

multiset

A `multiset` is to a set what a `multimap` is to a `map`. A `multiset` supports all the operations of a `set`, but it allows multiple elements that are equal to each other to be stored in the container simultaneously. An example of a `multiset` is not shown because it's so similar to `set` and `multimap`.

UNORDERED ASSOCIATIVE CONTAINERS OR HASH TABLES

The Standard Library has support for *unordered associative containers* or *hash tables*. There are four of them: `unordered_map`, `unordered_multimap`, `unordered_set`, and `unordered_multiset`. The `map`, `multimap`, `set`, and `multiset` containers discussed earlier sort their elements, while these unordered variants do not sort their elements.

Hash Functions

The unordered associative containers are also called *hash tables*. That is because the implementation makes use of so-called *hash functions*. The implementation usually consists of some kind of array where each element in the array is called a *bucket*. Each bucket has a specific numerical index like 0, 1, 2, up until the last bucket. A hash function transforms a key into a *hash value*, which is then transformed into a *bucket index*. The value associated with that key is then stored in that bucket.

The result of a hash function is not always unique. The situation in which two or more keys hash to the same bucket index is called a *collision*. A collision can occur when different keys result in the same hash value, or when different hash values transform to the same bucket index. There are many approaches to handling collisions, including quadratic re-hashing and linear chaining, among others. If you are interested, you can consult one of the references in the Algorithms and Data Structures section in Appendix B. The Standard Library does not specify which collision-handling algorithm is required, but most current implementations have chosen to resolve collisions by linear chaining. With linear chaining, buckets do not directly contain the data values associated with the keys, but contain a pointer to a linked list. This linked list contains all the data values for that specific bucket. Figure 17-1 shows how this works.

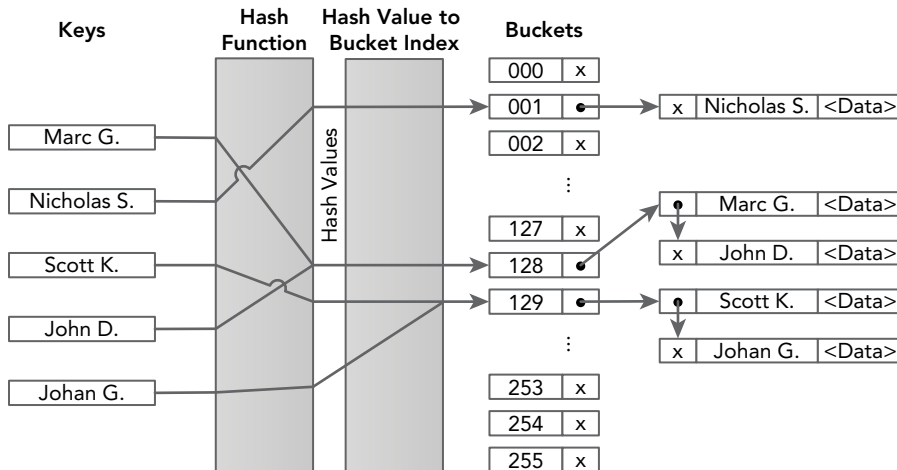

FIGURE 17-1

In Figure 17-1, there are two collisions. The first collision is because applying the hash function to the keys “Marc G.” and “John D.” results in the same hash value which maps to bucket index 128. This bucket then points to a linked list containing the keys “Marc G.” and “John D.” together with their associated data values. The second collision is caused by the hash values for “Scott K.” and “Johan G.” mapping to the same bucket index 129.

From Figure 17-1, it is also clear how lookups based on keys work and what the complexity is. A lookup involves a single hash function call to calculate the hash value. This hash value is then transformed to a bucket index. Once the bucket index is known, one or more equality operations are required to find the right key in the linked list. This shows that lookups can be much faster compared to lookups with normal maps, but it all depends on how many collisions there are.

The choice of the hash function is very important. A hash function that creates no collisions is known as a “perfect hash.” A perfect hash has a lookup time that is constant; a regular hash has a lookup time that is, on average, close to 1, independent of the number of elements. As the number of collisions increases, the lookup time increases, reducing performance. Collisions can be reduced by increasing the basic hash table size, but you need to take cache sizes into account.

The C++ standard provides hash functions for pointers and all primitive data types such as `bool`, `char`, `int`, `float`, `double`, and so on. Hash functions are also provided for `error_code`, `error_condition`, `optional`, `variant`, `bitset`, `unique_ptr`, `shared_ptr`, `type_index`, `string_view`, `vector<bool>`, and `thread::id`. If there is no standard hash function available for the type of keys you want to use, then you have to implement your own hash function. Creating a perfect hash is a nontrivial exercise, even when the set of keys is fixed and known. It requires deep mathematical analysis. However, even creating a non-perfect one, but one which is good enough and has decent performance, is still challenging. It’s outside the scope of this book to explain the mathematics behind hash functions in detail. Instead, only an example of a very simple hash function is given.

The following code demonstrates how to write a custom hash function. This implementation simply forwards the request to one of the available standard hash functions. The code defines a class `IntWrapper` that just wraps a single integer. An `operator==` is provided because that’s a requirement for keys used in unordered associative containers.

```
class IntWrapper
{
public:
    IntWrapper(int i) : mWrappedInt(i) {}
    int getValue() const { return mWrappedInt; }
private:
    int mWrappedInt;
};

bool operator==(const IntWrapper& lhs, const IntWrapper& rhs)
{
    return lhs.getValue() == rhs.getValue();
}
```

To write a hash function for `IntWrapper`, you write a specialization of the `std::hash` template for `IntWrapper`. The `std::hash` template is defined in `<functional>`. This specialization needs an implementation of the function call operator that calculates and returns the hash of a given

`IntWrapper` instance. For this example, the request is simply forwarded to the standard hash function for integers:

```
namespace std
{
    template<> struct hash<IntWrapper>
    {
        using argument_type = IntWrapper;
        using result_type = size_t;

        result_type operator()(const argument_type& f) const {
            return std::hash<int>()(f.getValue());
        }
    };
}
```

Note that you normally are not allowed to put anything in the `std` namespace; however, `std` class template specializations are an exception to this rule. The two type definitions are required by the hash class template. The implementation of the function call operator is just one line. It creates an instance of the standard hash function for integers—`std::hash<int>()`—and then calls the function call operator on it with, as argument, `f.getValue()`. Note that this forwarding works in this example because `IntWrapper` contains just one data member, an integer. If the class contained multiple data members, then a hash value would need to be calculated taking all these data members into account; however, those details fall outside the scope of this book.

unordered_map

The `unordered_map` container is defined in `<unordered_map>` as a class template:

```
template <class Key,
          class T,
          class Hash = hash<Key>,
          class Pred = std::equal_to<Key>,
          class Alloc = std::allocator<std::pair<const Key, T>>>
class unordered_map;
```

There are five template parameters: the key type, the value type, the hash type, the equal comparison type, and the allocator type. With the last three parameters you can specify your own hash function, equal comparison function, and allocator function, respectively. These parameters can usually be ignored because they have default values. I recommend you keep those default values when possible. The most important parameters are the first two. As with maps, uniform initialization can be used to initialize an `unordered_map`, as shown in the following example:

```
unordered_map<int, string> m = {
    {1, "Item 1"},
    {2, "Item 2"},
    {3, "Item 3"},
    {4, "Item 4"}
};
```

```

// Using C++17 structured bindings.
for (const auto&[key, value] : m) {
    cout << key << " = " << value << endl;
}

// Without structured bindings.
for (const auto& p : m) {
    cout << p.first << " = " << p.second << endl;
}

```

The following table summarizes the differences between a `map` and an `unordered_map`. A filled box (■) means the container supports that operation, while an empty box (□) means the operation is not supported.

OPERATION	map	unordered_map
<code>at()</code>	■	■
<code>begin()</code>	■	■
<code>begin(n)</code>	□	■
<code>bucket()</code>	□	■
<code>bucket_count()</code>	□	■
<code>bucket_size()</code>	□	■
<code>cbegin()</code>	■	■
<code>cbegin(n)</code>	□	■
<code>cend()</code>	■	■
<code>cend(n)</code>	□	■
<code>clear()</code>	■	■
<code>count()</code>	■	■
<code>crbegin()</code>	■	□
<code>crend()</code>	■	□
<code>emplace()</code>	■	■
<code>emplace_hint()</code>	■	■
<code>empty()</code>	■	■
<code>end()</code>	■	■

	<code>end(n)</code>	<input type="checkbox"/>	<input checked="" type="checkbox"/>
	<code>equal_range()</code>	<input checked="" type="checkbox"/>	<input checked="" type="checkbox"/>
	<code>erase()</code>	<input checked="" type="checkbox"/>	<input checked="" type="checkbox"/>
C++17	<code>extract()</code>	<input checked="" type="checkbox"/>	<input checked="" type="checkbox"/>
	<code>find()</code>	<input checked="" type="checkbox"/>	<input checked="" type="checkbox"/>
	<code>insert()</code>	<input checked="" type="checkbox"/>	<input checked="" type="checkbox"/>
C++17	<code>insert_or_assign()</code>	<input checked="" type="checkbox"/>	<input checked="" type="checkbox"/>
	<code>iterator / const_iterator</code>	<input checked="" type="checkbox"/>	<input checked="" type="checkbox"/>
	<code>load_factor()</code>	<input type="checkbox"/>	<input checked="" type="checkbox"/>
	<code>local_iterator / const_local_iterator</code>	<input type="checkbox"/>	<input checked="" type="checkbox"/>
	<code>lower_bound()</code>	<input checked="" type="checkbox"/>	<input type="checkbox"/>
	<code>max_bucket_count()</code>	<input type="checkbox"/>	<input checked="" type="checkbox"/>
	<code>max_load_factor()</code>	<input type="checkbox"/>	<input checked="" type="checkbox"/>
	<code>max_size()</code>	<input checked="" type="checkbox"/>	<input checked="" type="checkbox"/>
C++17	<code>merge()</code>	<input checked="" type="checkbox"/>	<input checked="" type="checkbox"/>
	<code>operator[]</code>	<input checked="" type="checkbox"/>	<input checked="" type="checkbox"/>
	<code>rbegin()</code>	<input checked="" type="checkbox"/>	<input type="checkbox"/>
	<code>rehash()</code>	<input type="checkbox"/>	<input checked="" type="checkbox"/>
	<code>rend()</code>	<input checked="" type="checkbox"/>	<input type="checkbox"/>
	<code>reserve()</code>	<input type="checkbox"/>	<input checked="" type="checkbox"/>
	<code>reverse_iterator / const_reverse_iterator</code>	<input checked="" type="checkbox"/>	<input type="checkbox"/>
	<code>size()</code>	<input checked="" type="checkbox"/>	<input checked="" type="checkbox"/>
	<code>swap()</code>	<input checked="" type="checkbox"/>	<input checked="" type="checkbox"/>
C++17	<code>try_emplace()</code>	<input checked="" type="checkbox"/>	<input checked="" type="checkbox"/>
	<code>upper_bound()</code>	<input checked="" type="checkbox"/>	<input type="checkbox"/>

As with a normal map, all keys in an `unordered_map` should be unique. The preceding table includes a number of hash-specific methods. For example, `load_factor()` returns the average number of elements per bucket to give you an indication of the number of collisions. The `bucket_count()` method returns the number of buckets in the container. It also provides a `local_iterator` and `const_local_iterator`, allowing you to iterate over the elements in a single bucket; however, these may not be used to iterate across buckets. The `bucket(key)` method returns the index of the bucket that contains the given key; `begin(n)` returns a `local_iterator` referring to the first element in the bucket with index `n`, and `end(n)` returns a `local_iterator` referring to one-past-the-last element in the bucket with index `n`. The example in the next section demonstrates how to use these methods.

unordered_map Example: Phone Book

The following example uses an `unordered_map` to represent a phone book. The name of a person is the key, while the phone number is the value associated with that key.

```
template<class T>
void printMap(const T& m)
{
    for (auto& [key, value] : m) {
        cout << key << " (Phone: " << value << ")" << endl;
    }
    cout << "-----" << endl;
}

int main()
{
    // Create a hash table.
    unordered_map<string, string> phoneBook = {
        { "Marc G.", "123-456789" },
        { "Scott K.", "654-987321" } };
    printMap(phoneBook);

    // Add/remove some phone numbers.
    phoneBook.insert(make_pair("John D.", "321-987654"));
    phoneBook["Johan G."] = "963-258147";
    phoneBook["Freddy K."] = "999-256256";
    phoneBook.erase("Freddy K.");
    printMap(phoneBook);

    // Find the bucket index for a specific key.
    const size_t bucket = phoneBook.bucket("Marc G.");
    cout << "Marc G. is in bucket " << bucket
        << " which contains the following "
        << phoneBook.bucket_size(bucket) << " elements:" << endl;
    // Get begin and end iterators for the elements in this bucket.
    // 'auto' is used here. The compiler deduces the type of
    // both as unordered_map<string, string>::const_local_iterator
    auto localBegin = phoneBook.cbegin(bucket);
    auto localEnd = phoneBook.cend(bucket);
    for (auto iter = localBegin; iter != localEnd; ++iter) {
        cout << "\t" << iter->first << " (Phone: "
            << iter->second << ")" << endl;
    }
}
```

```

cout << "-----" << endl;

// Print some statistics about the hash table
cout << "There are " << phoneBook.bucket_count() << " buckets." << endl;
cout << "Average number of elements in a bucket is "
    << phoneBook.load_factor() << endl;
return 0;
}

```

A possible output is as follows. Note that the output can be different on a different system, because it depends on the implementation of both the hash function and the `unordered_map` itself being used.

```

Scott K. (Phone: 654-987321)
Marc G. (Phone: 123-456789)
-----
Scott K. (Phone: 654-987321)
Marc G. (Phone: 123-456789)
Johan G. (Phone: 963-258147)
John D. (Phone: 321-987654)
-----
Marc G. is in bucket 1 which contains the following 2 elements:
    Scott K. (Phone: 654-987321)
    Marc G. (Phone: 123-456789)
-----
There are 8 buckets.
Average number of elements in a bucket is 0.5

```

unordered_multimap

An `unordered_multimap` is an `unordered_map` that allows multiple elements with the same key. Their interfaces are almost identical, with the following differences:

- `unordered_multimaps` do not provide operator[] and at(). The semantics of these do not make sense if there can be multiple elements with a single key.
- Inserts on `unordered_multimaps` always succeed. Thus, the `unordered_multimap::insert()` method that adds a single element returns just an iterator instead of a pair.
- The `insert_or_assign()` and `try_emplace()` methods supported by `unordered_map` are not supported by an `unordered_multimap`.

NOTE *unordered_multimaps allow you to insert identical key/value pairs. If you want to avoid this redundancy, you must check explicitly before inserting a new element.*

As discussed earlier with `multimaps`, looking up elements in `unordered_multimaps` cannot be done using operator[] because it is not provided. You can use `find()` but it returns an iterator referring to any one of the elements with a given key (not necessarily the first element with that key). Instead,

it's best to use the `equal_range()` method, which returns a pair of iterators: one referring to the first element matching a given key, and one referring to one-past-the-last element matching that key. The use of `equal_range()` is exactly the same as discussed for `multimaps`, so you can look at the example given for `multimaps` to see how it works.

unordered_set/unordered_multiset

The `<unordered_set>` header file defines `unordered_set` and `unordered_multiset`, which are very similar to `set` and `multiset`, respectively, except that they do not sort their keys but they use a hash function. The differences between `unordered_set` and `unordered_map` are similar to the differences between `set` and `map` as discussed earlier in this chapter, so they are not discussed in detail here. Consult a Standard Library Reference for a thorough summary of `unordered_set` and `unordered_multiset` operations.

OTHER CONTAINERS

There are several other parts of the C++ language that work with the Standard Library to varying degrees, including standard C-style arrays, `strings`, `streams`, and `bitset`.

Standard C-Style Arrays

Recall that “dumb”/raw pointers are bona fide iterators because they support the required operations. This point is more than just a piece of trivia. It means that you can treat standard C-style arrays as Standard Library containers by using pointers to their elements as iterators. Standard C-style arrays, of course, don't provide methods like `size()`, `empty()`, `insert()`, and `erase()`, so they aren't true Standard Library containers. Nevertheless, because they do support iterators through pointers, you can use them in the algorithms described in Chapter 18 and in some of the methods described in this chapter.

For example, you could copy all the elements of a standard C-style array into a `vector` using the `insert()` method of a `vector` that takes an iterator range from any container. This `insert()` method's prototype looks like this:

```
template <class InputIterator> iterator insert(const_iterator position,
                                             InputIterator first, InputIterator last);
```

If you want to use a standard C-style `int` array as the source, then the templated type of `InputIterator` becomes `int*`. Here is a full example:

```
const size_t count = 10;
int arr[count];    // standard C-style array
// Initialize each element of the array to the value of its index.
for (int i = 0; i < count; i++) {
    arr[i] = i;
}
```



```

// Insert the contents of the array at the end of a vector.
vector<int> vec;
vec.insert(end(vec), arr, arr + count);

// Print the contents of the vector.
for (const auto& i : vec) {
    cout << i << " ";
}

```

Note that the iterator referring to the first element of the array is the address of the first element, which is `arr` in this case. The name of an array alone is interpreted as the address of the first element. The iterator referring to the end must be one-past-the-last element, so it's the address of the first element plus `count`, or `arr+count`.

It's easier to use `std::begin()` or `std::cbegin()` to get an iterator to the first element of a statically allocated C-style array not accessed through pointers, and `std::end()` or `std::cend()` to get an iterator to one-past-the-last element of such an array. For example, the call to `insert()` in the previous example can be written as follows:

```
vec.insert(end(vec), cbegin(arr), cend(arr));
```

WARNING *Functions such as `std::begin()` and `std::end()` only work on statically allocated C-style arrays not accessed through pointers. They do not work if pointers are involved, or with dynamically allocated C-style arrays.*

Strings

You can think of a `string` as a sequential container of characters. Thus, it shouldn't be surprising to learn that a C++ `string` is a full-fledged sequential container. It contains `begin()` and `end()` methods that return iterators into the `string`, `insert()`, `push_back()`, and `erase()` methods, `size()`, `empty()`, and all the rest of the sequential container basics. It resembles a `vector` quite closely, even providing the methods `reserve()` and `capacity()`.

You can use `string` as a Standard Library container just as you would use `vector`. Here is an example:

```

string myString;
myString.insert(cend(myString), 'h');
myString.insert(cend(myString), 'e');
myString.push_back('l');
myString.push_back('l');
myString.push_back('o');

for (const auto& letter : myString) {
    cout << letter;
}

```

```
cout << endl;

for (auto it = cbegin(myString); it != cend(myString); ++it) {
    cout << *it;
}
cout << endl;
```

In addition to the Standard Library sequential container methods, `strings` provide a host of useful methods and `friend` functions. The `string` interface is actually quite a good example of a cluttered interface, one of the design pitfalls discussed in Chapter 6. The `string` class is discussed in detail in Chapter 2.

Streams

Input and output streams are not containers in the traditional sense because they do not store elements. However, they can be considered sequences of elements, and as such share some characteristics with Standard Library containers. C++ streams do not provide any Standard Library–related methods directly, but the Standard Library supplies special iterators called `istream_iterator` and `ostream_iterator` that allow you to “iterate” through input and output streams. Chapter 21 explains how to use them.

bitset

A `bitset` is a fixed-length abstraction of a sequence of bits. A bit can represent only two values, 1 and 0, which can be referred to as on/off, true/false, and so on. A `bitset` also uses the terminology *set* and *unset*. You can *toggle* or *flip* a bit from one value to the other.

A `bitset` is not a true Standard Library container: it’s of fixed size, it’s not templated on an element type, and it doesn’t support iteration. However, it’s a useful utility class, which is often lumped with the containers, so a brief introduction is provided here. Consult a Standard Library Reference for a thorough summary of the `bitset` operations.

bitset Basics

A `bitset`, defined in `<bitset>`, is templated on the number of bits it stores. The default constructor initializes all fields of a `bitset` to 0. An alternative constructor creates a `bitset` from a string of 0 and 1 characters.

You can adjust the values of individual bits with the `set()`, `reset()`, and `flip()` methods, and you can access and set individual fields with an overloaded `operator[]`. Note that `operator[]` on a non-const object returns a proxy object to which you can assign a Boolean value, call `flip()`, or complement with `operator~`. You can also access individual fields with the `test()` method. Additionally, you can stream `bitsets` with the normal insertion and extraction operators. A `bitset` is streamed as a string of 0 and 1 characters.

Here is a small example:

```
bitset<10> myBitset;

myBitset.set(3);
myBitset.set(6);
```

```

myBitset[8] = true;
myBitset[9] = myBitset[3];

if (myBitset.test(3)) {
    cout << "Bit 3 is set!"<< endl;
}
cout << myBitset << endl;

```

The output is as follows:

```

Bit 3 is set!
1101001000

```

Note that the leftmost character in the output `string` is the highest numbered bit. This corresponds to our intuitions about binary number representations, where the low-order bit representing $2^0 = 1$ is the rightmost bit in the printed representation.

Bitwise Operators

In addition to the basic bit manipulation routines, a `bitset` provides implementations of all the bitwise operators: `&`, `|`, `^`, `~`, `<<`, `>>`, `&=`, `|=`, `^=`, `<<=`, and `>>=`. They behave just as they would on a “real” sequence of bits. Here is an example:

```

auto str1 = "0011001100";
auto str2 = "0000111100";
bitset<10> bitsOne(str1);
bitset<10> bitsTwo(str2);

auto bitsThree = bitsOne & bitsTwo;
cout << bitsThree << endl;
bitsThree <<= 4;
cout << bitsThree << endl;

```

The output of the program is as follows:

```

0000001100
0011000000

```

bitset Example: Representing Cable Channels

One possible use of `bitsets` is tracking channels of cable subscribers. Each subscriber could have a `bitset` of channels associated with their subscription, with set bits representing the channels to which they actually subscribe. This system could also support “packages” of channels, also represented as `bitsets`, which represent commonly subscribed combinations of channels.

The following `CableCompany` class is a simple example of this model. It uses two maps, each of `string/bitset`. One stores the cable packages, while the other stores subscriber information.

```

const size_t kNumChannels = 10;

class CableCompany final
{
public:
    // Adds the package with the specified channels to the database.
    void addPackage(std::string_view packageName,

```

```

        const std::bitset<kNumChannels>& channels);
    // Removes the specified package from the database.
void removePackage(std::string_view packageName);
    // Retrieves the channels of a given package.
    // Throws out_of_range if the package name is invalid.
const std::bitset<kNumChannels>& getPackage(
    std::string_view packageName) const;
    // Adds customer to database with initial channels found in package.
    // Throws out_of_range if the package name is invalid.
    // Throws invalid_argument if the customer is already known.
void newCustomer(std::string_view name, std::string_view package);
    // Adds customer to database with given initial channels.
    // Throws invalid_argument if the customer is already known.
void newCustomer(std::string_view name,
    const std::bitset<kNumChannels>& channels);
    // Adds the channel to the customers profile.
    // Throws invalid_argument if the customer is unknown.
void addChannel(std::string_view name, int channel);
    // Removes the channel from the customers profile.
    // Throws invalid_argument if the customer is unknown.
void removeChannel(std::string_view name, int channel);
    // Adds the specified package to the customers profile.
    // Throws out_of_range if the package name is invalid.
    // Throws invalid_argument if the customer is unknown.
void addPackageToCustomer(std::string_view name,
    std::string_view package);
    // Removes the specified customer from the database.
void deleteCustomer(std::string_view name);
    // Retrieves the channels to which a customer subscribes.
    // Throws invalid_argument if the customer is unknown.
const std::bitset<kNumChannels>& getCustomerChannels(
    std::string_view name) const;
private:
    // Retrieves the channels for a customer. (non-const)
    // Throws invalid_argument if the customer is unknown.
std::bitset<kNumChannels>& getCustomerChannelsHelper(
    std::string_view name);

    using MapType = std::map<std::string, std::bitset<kNumChannels>>;
    MapType mPackages, mCustomers;
};

```

Here are the implementations of all methods, with comments explaining the code:

```

void CableCompany::addPackage(string_view packageName,
    const bitset<kNumChannels>& channels)
{
    mPackages.emplace(packageName, channels);
}

```

```
void CableCompany::removePackage(string_view packageName)
{
    mPackages.erase(packageName.data());
}

const bitset<kNumChannels>& CableCompany::getPackage(
    string_view packageName) const
{
    // Get a reference to the specified package.
    auto it = mPackages.find(packageName.data());
    if (it == end(mPackages)) {
        // That package doesn't exist. Throw an exception.
        throw out_of_range("Invalid package");
    }
    return it->second;
}

void CableCompany::newCustomer(string_view name, string_view package)
{
    // Get the channels for the given package.
    auto& packageChannels = getPackage(package);
    // Create the account with the bitset representing that package.
    newCustomer(name, packageChannels);
}

void CableCompany::newCustomer(string_view name,
    const bitset<kNumChannels>& channels)
{
    // Add customer to the customers map.
    auto result = mCustomers.emplace(name, channels);
    if (!result.second) {
        // Customer was already in the database. Nothing changed.
        throw invalid_argument("Duplicate customer");
    }
}

void CableCompany::addChannel(string_view name, int channel)
{
    // Get the current channels for the customer.
    auto& customerChannels = getCustomerChannelsHelper(name);
    // We found the customer; set the channel.
    customerChannels.set(channel);
}

void CableCompany::removeChannel(string_view name, int channel)
{
    // Get the current channels for the customer.
    auto& customerChannels = getCustomerChannelsHelper(name);
    // We found this customer; remove the channel.
    customerChannels.reset(channel);
}
```

```

void CableCompany::addPackageToCustomer(string_view name, string_view package)
{
    // Get the channels for the given package.
    auto& packageChannels = getPackage(package);
    // Get the current channels for the customer.
    auto& customerChannels = getCustomerChannelsHelper(name);
    // Or-in the package to the customer's existing channels.
    customerChannels |= packageChannels;
}

void CableCompany::deleteCustomer(string_view name)
{
    mCustomers.erase(name.data());
}

const bitset<kNumChannels>& CableCompany::getCustomerChannels(
    string_view name) const
{
    // Use const_cast() to forward to getCustomerChannelsHelper()
    // to avoid code duplication.
    return const_cast<CableCompany*>(this)->getCustomerChannelsHelper(name);
}

bitset<kNumChannels>& CableCompany::getCustomerChannelsHelper(
    string_view name)
{
    // Find a reference to the customer.
    auto it = mCustomers.find(name.data());
    if (it == end(mCustomers)) {
        throw invalid_argument("Unknown customer");
    }
    // Found it.
    // Note that 'it' is a reference to a name/bitset pair.
    // The bitset is the second field.
    return it->second;
}

```

Finally, here is a simple program demonstrating how to use the `CableCompany` class:

```

CableCompany myCC;
auto basic_pkg = "1111000000";
auto premium_pkg = "1111111111";
auto sports_pkg = "0000100111";

myCC.addPackage("basic", bitset<kNumChannels>(basic_pkg));
myCC.addPackage("premium", bitset<kNumChannels>(premium_pkg));
myCC.addPackage("sports", bitset<kNumChannels>(sports_pkg));

myCC.newCustomer("Marc G.", "basic");
myCC.addPackageToCustomer("Marc G.", "sports");
cout << myCC.getCustomerChannels("Marc G.") << endl;

```

The output is as follows:

```
1111100111
```

SUMMARY

This chapter introduced the Standard Library containers. It also presented sample code illustrating a variety of uses for these containers. Hopefully, you appreciate the power of `vector`, `deque`, `list`, `forward_list`, `array`, `stack`, `queue`, `priority_queue`, `map`, `multimap`, `set`, `multiset`, `unordered_map`, `unordered_multimap`, `unordered_set`, `unordered_multiset`, `string`, and `bitset`. Even if you don't incorporate them into your programs immediately, you should keep them in the back of your mind for future projects.

Now that you are familiar with the containers, the next chapter illustrates the true power of the Standard Library with a discussion of generic algorithms.

18

Mastering Standard Library Algorithms

WHAT'S IN THIS CHAPTER?

- Algorithms explained
- Lambda expressions explained
- Function objects explained
- The details of the Standard Library algorithms
- A larger example: Auditing voter registrations

WROX.COM DOWNLOADS FOR THIS CHAPTER

Please note that all the code examples for this chapter are available as a part of this chapter's code download on the book's website at www.wrox.com/go/proc++4e on the Download Code tab.

As Chapter 17 shows, the Standard Library provides an impressive collection of generic data structures. Most libraries stop there. The Standard Library, however, contains an additional assortment of generic algorithms that can, with some exceptions, be applied to elements from any container. Using these algorithms, you can find, sort, and process elements in containers, and perform a host of other operations. The beauty of the algorithms is that they are independent not only of the types of the underlying elements, but also of the types of the containers on which they operate. Algorithms perform their work using only the iterator interfaces.

Many of the algorithms accept a *callback*, which can be a function pointer or something that behaves like a function pointer, such as an object with an overloaded `operator()`, or an inline lambda expression. A class that overloads `operator()` is called a *function object*, or *functor*.

Conveniently, the Standard Library provides a set of classes that can be used to create callback objects for the algorithms.

OVERVIEW OF ALGORITHMS

The “magic” behind the algorithms is that they work on iterator intermediaries instead of on the containers themselves. In that way, they are not tied to specific container implementations. All the Standard Library algorithms are implemented as function templates, where the template type parameters are usually iterator types. The iterators themselves are specified as arguments to the function. Templated functions can usually deduce the template types from the function arguments, so you can generally call the algorithms as if they were normal functions, not templates.

The iterator arguments are usually iterator ranges. As Chapter 17 explains, iterator ranges are half-open for most containers such that they include the first element in the range, but exclude the last. The end iterator is really a “past-the-end” marker.

Algorithms pose certain requirements on iterators passed to them. For instance, `copy_backward()` is an example of an algorithm that requires a bidirectional iterator, and `stable_sort()` is an example of an algorithm requiring random access iterators. This means that such algorithms cannot work on containers that do not provide the necessary iterators. `forward_list` is an example of a container supporting only forward iterators, no bidirectional or random access iterators; thus, `copy_backward()` and `stable_sort()` cannot work on `forward_list`.

Most algorithms are defined in the `<algorithm>` header file, while some numerical algorithms are defined in `<numeric>`. All of them are in the `std` namespace.

The best way to understand the algorithms is to look at some examples first. After you’ve seen how a few of them work, it’s easy to pick up the others. This section describes the `find()`, `find_if()`, and `accumulate()` algorithms in detail. The following sections present the lambda expressions and function objects, and discuss each of the classes of algorithms with representative samples.

The `find` and `find_if` Algorithms

`find()` looks for a specific element in an iterator range. You can use it on elements in any container type. It returns an iterator referring to the element found, or the end iterator of the range in case the element is not found. Note that the range specified in the call to `find()` need not be the entire range of elements in a container; it could be a subset.

WARNING *If `find()` fails to find an element, it returns an iterator equal to the end iterator specified in the function call, not the end iterator of the underlying container.*

Here is an example using `std::find()`. Note that this example assumes that the user plays nice and enters valid numbers; it does not perform any error checking on the user input. Performing error checking on stream input is discussed in Chapter 13.

```
#include <algorithm>
#include <vector>
#include <iostream>
using namespace std;

int main()
{
    int num;
    vector<int> myVector;
    while (true) {
        cout << "Enter a number to add (0 to stop): ";
        cin >> num;
        if (num == 0) {
            break;
        }
        myVector.push_back(num);
    }

    while (true) {
        cout << "Enter a number to lookup (0 to stop): ";
        cin >> num;
        if (num == 0) {
            break;
        }
        auto endIt = cend(myVector);
        auto it = find(cbegin(myVector), endIt, num);
        if (it == endIt) {
            cout << "Could not find " << num << endl;
        } else {
            cout << "Found " << *it << endl;
        }
    }
    return 0;
}
```

The call to `find()` is made with `cbegin(myVector)` and `endIt` as arguments, where `endIt` is defined as `cend(myVector)` in order to search all the elements of the vector. If you want to search in a subrange, you can change these two iterators.

Here is a sample run of the program:

```
Enter a number to add (0 to stop): 3
Enter a number to add (0 to stop): 4
Enter a number to add (0 to stop): 5
Enter a number to add (0 to stop): 6
Enter a number to add (0 to stop): 0
Enter a number to lookup (0 to stop): 5
```

```

Found 5
Enter a number to lookup (0 to stop): 8
Could not find 8
Enter a number to lookup (0 to stop): 0

```

With initializers for `if` statements (C++17), the call to `find()` and checking the result can be done with one statement as follows:

```

if (auto it = find(cbegin(myVector), endIt, num); it == endIt) {
    cout << "Could not find " << num << endl;
} else {
    cout << "Found " << *it << endl;
}

```

Some containers, such as `map` and `set`, provide their own versions of `find()` as class methods.

WARNING *If a container provides a method with the same functionality as a generic algorithm, you should use the method instead, because it's faster. For example, the generic `find()` algorithm runs in linear time, even on a `map`, while the `find()` method on a `map` runs in logarithmic time.*

`find_if()` is similar to `find()`, except that it accepts a *predicate function callback* instead of a simple element to match. A predicate returns `true` or `false`. The `find_if()` algorithm calls the predicate on each element in the range until the predicate returns `true`, in which case `find_if()` returns an iterator referring to that element. The following program reads test scores from the user, then checks if any of the scores are “perfect.” A perfect score is a score of 100 or higher. The program is similar to the previous example. Only the major differences are in bold.

```

bool perfectScore(int num)
{
    return (num >= 100);
}

int main()
{
    int num;
    vector<int> myVector;
    while (true) {
        cout << "Enter a test score to add (0 to stop): ";
        cin >> num;
        if (num == 0) {
            break;
        }
        myVector.push_back(num);
    }

    auto endIt = cend(myVector);
    auto it = find_if(cbegin(myVector), endIt, perfectScore);
    if (it == endIt) {
        cout << "No perfect scores" << endl;
    }

```

```

    } else {
        cout << "Found a \"perfect\" score of " << *it << endl;
    }
    return 0;
}

```

This program passes a pointer to the `perfectScore()` function to `find_if()`, which the algorithm then calls on each element until it returns `true`.

The following is the same call to `find_if()`, but using a lambda expression. It gives you an initial idea about the power of lambda expressions. Don't worry about their syntax yet; they are explained in detail later in this chapter. Note the absence of the `perfectScore()` function.

```

auto it = find_if(cbegin(myVector), endIt, [](int i){ return i >= 100; });

```

The accumulate Algorithm

It's often useful to calculate the sum, or some other arithmetic quantity, of elements in a container. The `accumulate()` function—defined in `<numeric>`, not in `<algorithm>`—does just that. In its most basic form, it calculates the sum of the elements in a specified range. For example, the following function calculates the arithmetic mean of a sequence of integers in a `vector`. The arithmetic mean is simply the sum of all the elements divided by the number of elements.

```

double arithmeticMean(const vector<int>& nums)
{
    double sum = accumulate(cbegin(nums), cend(nums), 0);
    return sum / nums.size();
}

```

The `accumulate()` algorithm takes as its third parameter an initial value for the sum, which in this case should be 0 (the identity for addition) to start a fresh sum.

The second form of `accumulate()` allows the caller to specify an operation to perform instead of the default addition. This operation takes the form of a binary callback. Suppose that you want to calculate the geometric mean, which is the product of all the numbers in the sequence to the power of the inverse of the size. In that case, you would want to use `accumulate()` to calculate the product instead of the sum. You *could* write it like this:

```

int product(int num1, int num2)
{
    return num1 * num2;
}

double geometricMean(const vector<int>& nums)
{
    double mult = accumulate(cbegin(nums), cend(nums), 1, product);
    return pow(mult, 1.0 / nums.size()); // pow() needs <cmath>
}

```

Note that the `product()` function is passed as a callback to `accumulate()` and that the initial value for the accumulation is 1 (the identity for multiplication) instead of 0.

To give you a second teaser about the power of lambda expressions, the `geometricMean()` function *could* be written as follows, without using the `product()` function:

```
double geometricMeanLambda(const vector<int>& nums)
{
    double mult = accumulate(cbegin(nums), cend(nums), 1,
        [](int num1, int num2){ return num1 * num2; });
    return pow(mult, 1.0 / nums.size());
}
```

However, later in this chapter you will learn how to use `accumulate()` in the `geometricMean()` function without writing a function callback or lambda expression.

Move Semantics with Algorithms

Just like Standard Library containers, Standard Library algorithms are also optimized to use move semantics at appropriate times. This can greatly speed up certain algorithms, for example, `remove()`, discussed in detail later in this chapter. For this reason, it is highly recommended that you implement move semantics in your custom element classes that you want to store in containers. Move semantics can be added to any class by implementing a move constructor and a move assignment operator. Both should be marked as `noexcept`, because they should not throw exceptions. Consult the “Move Semantics” section in Chapter 9 for details on how to add move semantics to your classes.

STD::FUNCTION

`std::function`, defined in the `<functional>` header file, can be used to create a type that can point to a function, a function object, or a lambda expression—basically anything that is callable. `std::function` is called a *polymorphic function wrapper*. It can be used as a function pointer, or as a parameter for a function to implement callbacks. The template parameters for the `std::function` template look a bit different than most template parameters. Its syntax is as follows:

```
std::function<R(ArgTypes...)>
```

`R` is the return type of the function, and `ArgTypes` is a comma-separated list of parameter types for the function.

The following example demonstrates how to use `std::function` to implement a function pointer. It creates a function pointer `f1` to point to the function `func()`. Once `f1` is defined, you can call `func()` by using the name `func` or `f1`:

```
void func(int num, const string& str)
{
    cout << "func(" << num << ", " << str << ")" << endl;
}

int main()
{
    function<void(int, const string&)> f1 = func;
    f1(1, "test");
    return 0;
}
```

Of course, in the preceding example, it is possible to use the `auto` keyword, which removes the need to specify the exact type of `f1`. The following definition for `f1` works exactly the same and is much shorter, but the compiler-deduced type of `f1` is a function pointer, that is, `void (*f1)(int, const string&)` instead of an `std::function`.

```
auto f1 = func;
```

Because `std::function` types behave as function pointers, they can be passed to Standard Library algorithms as shown in the following example using the `find_if()` algorithm:

```
bool isEven(int num)
{
    return num % 2 == 0;
}

int main()
{
    vector<int> vec{ 1,2,3,4,5,6,7,8,9 };

    function<bool(int)> fcn = isEven;
    auto result = find_if(cbegin(vec), cend(vec), fcn);
    if (result != cend(vec)) {
        cout << "First even number: " << *result << endl;
    } else {
        cout << "No even number found." << endl;
    }
    return 0;
}
```

After the preceding examples, you might think that `std::function` is not really useful; however, `std::function` really shines when you need to store a callback as a member variable of a class. You can also use `std::function` when you need to accept a function pointer as parameter to your own function. The following example defines a function called `process()`, which accepts a reference to a vector and an `std::function`. The `process()` function iterates over all the elements in the given vector, and calls the given function `f` for each element. You can think of the parameter `f` as a callback.

The `print()` function prints a given value to the console. The `main()` function first creates a vector of integers. It then calls the `process()` function with a function pointer to `print()`. The result is that each element in the vector is printed.

The last part of the `main()` function demonstrates that you can also pass a lambda expression (discussed in detail in the next section) for the `std::function` parameter of the `process()` function; that's the power of `std::function`. You cannot get this same functionality by using a raw function pointer.

```
void process(const vector<int>& vec, function<void(int)> f)
{
    for (auto& i : vec) {
        f(i);
    }
}
```

```

void print(int num)
{
    cout << num << " ";
}

int main()
{
    vector<int> vec{ 0,1,2,3,4,5,6,7,8,9 };

    process(vec, print);
    cout << endl;

    int sum = 0;
    process(vec, [&sum](int num){sum += num;});
    cout << "sum = " << sum << endl;
    return 0;
}

```

The output of this example is as follows:

```

0 1 2 3 4 5 6 7 8 9
sum = 45

```

Instead of using `std::function` to accept callback parameters, you can also write a function template as follows:

```

template <typename F>
void processTemplate(const vector<int>& vec, F f)
{
    for (auto& i : vec) {
        f(i);
    }
}

```

This function template can be used in the same way as the non-template `process()` function, that is, `processTemplate()` can accept both raw function pointers and lambda expressions.

LAMBDA EXPRESSIONS

Lambda expressions allow you to write anonymous functions inline, removing the need to write a separate function or a function object. Lambda expressions can make code easier to read and understand.

Syntax

Let's start with a very simple lambda expression. The following example defines a lambda expression that just writes a string to the console. A lambda expression starts with square brackets `[]`, called the *lambda introducer*, followed by curly braces `{}`, which contain the body of the lambda expression. The lambda expression is assigned to the `basicLambda` auto-typed variable. The second line executes the lambda expression using normal function-call syntax.

```

auto basicLambda = []{ cout << "Hello from Lambda" << endl; };
basicLambda();

```

The output is as follows:

```
Hello from Lambda
```

A lambda expression can accept parameters. Parameters are specified between parentheses and separated by commas, just as with normal functions. Here is an example using one parameter:

```
auto parametersLambda =
    [](int value){ cout << "The value is " << value << endl; };
parametersLambda(42);
```

If a lambda expression does not accept any parameters, you can either specify empty parentheses or simply omit them.

A lambda expression can return a value. The return type is specified following an arrow, called a trailing return type. The following example defines a lambda expression accepting two parameters and returning their sum:

```
auto returningLambda = [](int a, int b) -> int { return a + b; };
int sum = returningLambda(11, 22);
```

The return type can be omitted, in which case the compiler deduces the return type of the lambda expression according to the same rules as for function return type deduction (see Chapter 1). In the previous example, the return type can be omitted as follows:

```
auto returningLambda = [](int a, int b){ return a + b; };
int sum = returningLambda(11, 22);
```

A lambda expression can capture variables from its enclosing scope. For example, the following lambda expression captures the variable `data` so that it can be used in its body:

```
double data = 1.23;
auto capturingLambda = [data]{ cout << "Data = " << data << endl; };
```

The square brackets part is called the lambda *capture block*. *Capturing* a variable means that the variable becomes available inside the body of the lambda expression. Specifying an empty capture block, `[]`, means that no variables from the enclosing scope are captured. When you just write the name of a variable in the capture block as in the preceding example, then you are capturing that variable by value.

The compiler transforms any lambda expression into some kind of unnamed functor (= function object). The captured variables become data members of this functor. Variables captured by value are copied into data members of the functor. These data members have the same constness as the captured variables. In the preceding `capturingLambda` example, the functor gets a non-const data member called `data`, because the captured variable, `data`, is non-const. However, in the following example, the functor gets a const data member called `data`, because the captured variable is const:

```
const double data = 1.23;
auto capturingLambda = [data]{ cout << "Data = " << data << endl; };
```

A functor always has an implementation of the function call operator, `operator()`. For a lambda expression, this function call operator is marked as `const` by default. That means that even if you capture a non-const variable by value in a lambda expression, the lambda expression is not able to

modify this copy. You can mark the function call operator as `non-const` by specifying the lambda expression as `mutable`, as follows:

```
double data = 1.23;
auto capturingLambda =
    [data] () mutable { data *= 2; cout << "Data = " << data << endl; };
```

In this example, the `non-const` variable `data` is captured by value; thus, the functor gets a `non-const` data member that is a copy of `data`. Because of the `mutable` keyword, the function call operator is marked as `non-const`, and so the body of the lambda expression can modify its copy of `data`. Note that if you specify `mutable`, then you have to specify the parentheses for the parameters even if they are empty.

You can prefix the name of a variable with `&` to capture it by reference. The following example captures the variable `data` by reference so that the lambda expression can directly change `data` in the enclosing scope:

```
double data = 1.23;
auto capturingLambda = [&data]{ data *= 2; };
```

When you capture a variable by reference, you have to make sure that the reference is still valid at the time the lambda expression is executed.

There are two ways to capture all variables from the enclosing scope:

- [=] captures all variables by value
- [&] captures all variables by reference

It is also possible to selectively decide which variables to capture and how, by specifying a *capture list* with an optional *capture default*. Variables prefixed with `&` are captured by reference. Variables without a prefix are captured by value. If present, the capture default should be the first element in the capture list, and be either `&` or `=`. Here are some capture block examples:

- [&x] captures only `x` by reference and nothing else.
- [x] captures only `x` by value and nothing else.
- [=, &x, &y] captures by value by default, except variables `x` and `y`, which are captured by reference.
- [&, x] captures by reference by default, except variable `x`, which is captured by value.
- [&x, &x] is illegal because identifiers cannot be repeated.
- [this] captures the current object. In the body of the lambda expression you can access this object, even without using `this->`.
- [*this] captures a copy of the current object. This can be useful in cases where the object will no longer be alive when the lambda expression is executed.

NOTE *When using a capture default, only those variables that are really used in the body of the lambda expression are captured, either by value (=) or by reference (&). Unused variables are not captured.*

WARNING *It is not recommended to use a capture default, even though a capture default only captures those variables that are really used in the body of the lambda expression. By using `a = capture default`, you might accidentally cause an expensive copy. By using an `&` capture default, you might accidentally modify a variable in the enclosing scope. I recommend to explicitly specify which variables you want to capture.*

The complete syntax of a lambda expression is as follows:

```
[capture_block] (parameters) mutable constexpr
    noexcept_specifier attributes
    -> return_type {body}
```

A lambda expression contains the following parts:

- **Capture block.** This specifies how variables from the enclosing scope are captured and made available in the body of the lambda.
- **Parameters** (optional). This is a list of parameters for the lambda expression. You can omit this list only if you do not need any parameters and you do not specify `mutable`, `constexpr`, a `noexcept` specifier, attributes, or a return type. The parameter list is similar to the parameter list for normal functions.
- **mutable** (optional). This marks the lambda expression as mutable; see earlier examples.
- **constexpr** (optional). This marks the lambda expression as `constexpr`, so it can be evaluated at compile time. Even if omitted, a lambda expression can be `constexpr` implicitly if it satisfies certain restrictions, not further discussed in this text.
- **noexcept specifier** (optional). This can be used to specify `noexcept` clauses, similar to `noexcept` clauses for normal functions.
- **Attributes** (optional). This can be used to specify attributes for the lambda expression. Attributes are explained in Chapter 11.
- **Return type** (optional). This is the type of the returned value. If this is omitted, the compiler deduces the return type according to the same rules as for function return type deduction; see Chapter 1.

C++17

Generic Lambda Expressions

It is possible to use auto type deduction for parameters of lambda expressions instead of explicitly specifying concrete types for them. To specify auto type deduction for a parameter, the type is simply specified as `auto`. The type deduction rules are the same as for template argument deduction.

The following example defines a generic lambda expression called `isGreaterThan100`. This single lambda expression is used with the `find_if()` algorithm, once for a vector of integers and once for a vector of doubles.

```
// Define a generic lambda to find values > 100.
auto isGreaterThan100 = [](auto i){ return i > 100; };
```

```

// Use the generic lambda with a vector of integers.
vector<int> ints{ 11, 55, 101, 200 };
auto it1 = find_if(cbegin(ints), cend(ints), isGreaterThan100);
if (it1 != cend(ints)) {
    cout << "Found a value > 100: " << *it1 << endl;
}

// Use exactly the same generic lambda with a vector of doubles.
vector<double> doubles{ 11.1, 55.5, 200.2 };
auto it2 = find_if(cbegin(doubles), cend(doubles), isGreaterThan100);
if (it2 != cend(doubles)) {
    cout << "Found a value > 100: " << *it2 << endl;
}

```

Lambda Capture Expressions

Lambda capture expressions allow you to initialize capture variables with any kind of expression. It can be used to introduce variables in the lambda expression that are not captured from the enclosing scope. For example, the following code creates a lambda expression. Inside this lambda expression there are two variables available: one called `myCapture`, initialized to the string “Pi:” using a lambda capture expression; and one called `pi`, which is captured by value from the enclosing scope. Note that non-reference capture variables such as `myCapture` that are initialized with a capture initializer are copy constructed, which means that `const` qualifiers are stripped.

```

double pi = 3.1415;
auto myLambda = [myCapture = "Pi: ", pi]{ cout << myCapture << pi; };

```

A lambda capture variable can be initialized with any kind of expression, thus also with `std::move()`. This is important for objects that cannot be copied, only moved, such as `unique_ptr`. By default, capturing by value uses copy semantics, so it’s impossible to capture a `unique_ptr` by value in a lambda expression. Using a lambda capture expression, it is possible to capture it by moving, as in this example:

```

auto myPtr = std::make_unique<double>(3.1415);
auto myLambda = [p = std::move(myPtr)]{ cout << *p; };

```

It is allowed, though not recommended, to have the same name for the capture variable as the name in the enclosing scope. The previous example can be written as follows:

```

auto myPtr = std::make_unique<double>(3.1415);
auto myLambda = [myPtr = std::move(myPtr)]{ cout << *myPtr; };

```

Lambda Expressions as Return Type

By using `std::function`, discussed earlier in this chapter, lambda expressions can be returned from functions. Take a look at the following definition:

```

function<int(void)> multiplyBy2Lambda(int x)
{
    return [x]{ return 2 * x; };
}

```

The body of this function creates a lambda expression that captures the variable `x` from the enclosing scope by value, and returns an integer that is two times the value passed

to `multiplyBy2Lambda()`. The return type of the `multiplyBy2Lambda()` function is `function<int(void)>`, which is a function accepting no arguments and returning an integer. The lambda expression defined in the body of the function exactly matches this prototype. The variable `x` is captured by value, and thus a copy of the value of `x` is bound to the `x` in the lambda expression before the lambda is returned from the function. The function can be called as follows:

```
function<int(void)> fn = multiplyBy2Lambda(5);
cout << fn() << endl;
```

You can use the `auto` keyword to make this easier:

```
auto fn = multiplyBy2Lambda(5);
cout << fn() << endl;
```

The output will be 10.

Function return type deduction (see Chapter 1) allows you to write the `multiplyBy2Lambda()` function more elegantly, as follows:

```
auto multiplyBy2Lambda(int x)
{
    return [x]{ return 2 * x; };
}
```

The `multiplyBy2Lambda()` function captures the variable `x` by value, `[x]`. Suppose the function is rewritten to capture the variable by reference, `[&x]`, as follows. This will not work because the lambda expression will be executed later in the program, no longer in the scope of the `multiplyBy2Lambda()` function, at which point the reference to `x` is not valid anymore.

```
auto multiplyBy2Lambda(int x)
{
    return [&x]{ return 2 * x; }; // BUG!
}
```

Lambda Expressions as Parameters

The “`std::function`” section earlier in this chapter discusses that a function parameter of type `std::function` can accept a lambda expression argument. An example in that section shows a `process()` function accepting a lambda expression as callback. The section also explains an alternative to `std::function`, that is, function templates. The `processTemplate()` function template example is also capable of accepting a lambda expression argument.

Examples with Standard Library Algorithms

This section demonstrates lambda expressions with two Standard Library algorithms: `count_if()` and `generate()`. More examples follow later in this chapter.

`count_if`

The following example uses the `count_if()` algorithm to count the number of elements in a given vector that satisfy a certain condition. The condition is given in the form of a lambda expression, which captures the `value` variable from its enclosing scope by value.

```
vector<int> vec{ 1, 2, 3, 4, 5, 6, 7, 8, 9 };
int value = 3;
int cnt = count_if(cbegin(vec), cend(vec),
                  [value](int i){ return i > value; });
cout << "Found " << cnt << " values > " << value << endl;
```

The output is as follows:

```
Found 6 values > 3
```

The example can be extended to demonstrate capturing variables by reference. The following lambda expression counts the number of times it is called by incrementing a variable in the enclosing scope that is captured by reference:

```
vector<int> vec = { 1, 2, 3, 4, 5, 6, 7, 8, 9 };
int value = 3;
int cntLambdaCalled = 0;
int cnt = count_if(cbegin(vec), cend(vec),
                  [value, &cntLambdaCalled](int i){ ++cntLambdaCalled; return i > value; });
cout << "The lambda expression was called " << cntLambdaCalled
     << " times." << endl;
cout << "Found " << cnt << " values > " << value << endl;
```

The output is as follows:

```
The lambda expression was called 9 times.
Found 6 values > 3
```

generate

The `generate()` algorithm requires an iterator range and replaces the values in that range with the values returned from the function given as a third argument. The following example uses the `generate()` algorithm together with a lambda expression to put the numbers 2, 4, 8, 16, and so on in a vector:

```
vector<int> vec(10);
int value = 1;
generate(begin(vec), end(vec), [&value]{ value *= 2; return value; });
for (const auto& i : vec) {
    cout << i << " ";
}
```

The output is as follows:

```
2 4 8 16 32 64 128 256 512 1024
```

FUNCTION OBJECTS

You can overload the function call operator in a class such that objects of the class can be used in place of function pointers. These objects are called *function objects*, or just *functors*.

Many of the Standard Library algorithms, such as `find_if()` and a version of `accumulate()`, can accept callables, for example function pointers, lambda expressions, and functors, as parameters

to modify the algorithm's behavior. C++ provides several predefined functor classes, defined in the `<functional>` header file, that perform the most commonly used callback operations.

The clumsiness of having to create a function or functor class, give it a name that does not conflict with other names, and then use this name is considerable overhead for what is fundamentally a simple concept. In these cases, using anonymous (unnamed) functions represented by lambda expressions is a big convenience. Their syntax is easier and can make your code easier to understand. They are discussed in the previous sections. However, this section explains functors and how to use the predefined functor classes because you will likely encounter them at some point.

Your `<functional>` header might also contain functions like `bind1st()`, `bind2nd()`, `mem_fun()`, `mem_fun_ref()`, and `ptr_fun()`. These functions have officially been removed from the C++17 standard, and thus are not further discussed in this book. You should avoid using them.

NOTE *It is recommended to use lambda expressions, if possible, instead of small function objects because lambda expressions are easier to use, read, and understand.*

Arithmetic Function Objects

C++ provides functor class templates for the five binary arithmetic operators: `plus`, `minus`, `multiplies`, `divides`, and `modulus`. Additionally, unary `negate` is supplied. These classes are templated on the type of the operands and are wrappers for the actual operators. They take one or two parameters of the template type, perform the operation, and return the result. Here is an example using the `plus` class template:

```
plus<int> myPlus;
int res = myPlus(4, 5);
cout << res << endl;
```

This example is silly, because there's no reason to use the `plus` class template when you could just use `operator+` directly. The benefit of the arithmetic function objects is that you can pass them as callbacks to algorithms, which you cannot do directly with the arithmetic operators. For example, the implementation of the `geometricMean()` function earlier in this chapter used the `accumulate()` function with a function pointer to the `product()` callback to multiply two integers. You could rewrite it to use the predefined `multiplies` function object:

```
double geometricMean(const vector<int>& nums)
{
    double mult = accumulate(cbegin(nums), cend(nums), 1, multiplies<int>());
    return pow(mult, 1.0 / nums.size());
}
```

The expression `multiplies<int>()` creates a new object of the `multiplies` functor class template, instantiating it with the `int` type.

The other arithmetic function objects behave similarly.

WARNING *The arithmetic function objects are just wrappers around the arithmetic operators. If you use the function objects as callbacks in algorithms, make sure that the objects in your container implement the appropriate operation, such as `operator*` or `operator+`.*

Transparent Operator Functors

C++ has support for transparent operator functors, which allow you to omit the template type argument. For example, you can just specify `multiplies<>()` instead of `multiplies<int>()`:

```
double geometricMeanTransparent(const vector<int>& nums)
{
    double mult = accumulate(cbegin(nums), cend(nums), 1, multiplies<>());
    return pow(mult, 1.0 / nums.size());
}
```

A very important feature of these transparent operators is that they are heterogeneous. That is, they are not only more concise than the non-transparent functors, but they also have real functional advantages. For instance, the following code uses a transparent operator functor and uses 1.1, a double, as the initial value, while the `vector` contains integers. `accumulate()` calculates the result as a double, and `result` will be 6.6:

```
vector<int> nums{ 1, 2, 3 };
double result = accumulate(cbegin(nums), cend(nums), 1.1, multiplies<>());
```

If this code uses a non-transparent operator functor as follows, then `accumulate()` calculates the result as an integer, and `result` will be 6. When you compile this code, the compiler will give you warnings about possible loss of data.

```
vector<int> nums{ 1, 2, 3 };
double result = accumulate(cbegin(nums), cend(nums), 1.1, multiplies<int>());
```

NOTE *It's recommended to always use the transparent operator functors.*

Comparison Function Objects

In addition to the arithmetic function object classes, the C++ language provides all the standard comparisons: `equal_to`, `not_equal_to`, `less`, `greater`, `less_equal`, and `greater_equal`. You've already seen `less` in Chapter 17 as the default comparison for elements in the `priority_queue` and the associative containers. Now you can learn how to change that criterion. Here's an example of a `priority_queue` using the default comparison operator: `std::less`.

```
priority_queue<int> myQueue;
myQueue.push(3);
myQueue.push(4);
myQueue.push(2);
```

```

myQueue.push(1);
while (!myQueue.empty()) {
    cout << myQueue.top() << " ";
    myQueue.pop();
}

```

Here is the output from the program:

```
4 3 2 1
```

As you can see, the elements of the queue are removed in descending order, according to the `less` comparison. You can change the comparison to `greater` by specifying it as the comparison template argument. The `priority_queue` template definition looks like this:

```
template <class T, class Container = vector<T>, class Compare = less<T>>;
```

Unfortunately, the `Compare` type parameter is last, which means that in order to specify it, you must also specify the container type. If you want to use a `priority_queue` that sorts the elements in ascending order using `greater`, then you need to change the definition of the `priority_queue` in the previous example to the following:

```
priority_queue<int, vector<int>, greater<>> myQueue;
```

The output now is as follows:

```
1 2 3 4
```

Note that `myQueue` is defined with a transparent operator, `greater<>`. In fact, it's recommended to always use a transparent operator for Standard Library containers that accept a comparator type. Using a transparent comparator can be a bit more performant compared to using a non-transparent operator. For example, if a `map<string>` uses a non-transparent comparator, performing a query for a key given as a string literal might cause an unwanted copy to be created, because a `string` instance has to be constructed from the string literal. When using a transparent comparator, this copying is avoided.

Several algorithms that you will learn about later in this chapter require comparison callbacks, for which the predefined comparators come in handy.

Logical Function Objects

C++ provides function object classes for the three logical operations: `logical_not` (`operator!`), `logical_and` (`operator&&`), and `logical_or` (`operator||`). These logical operations deal only with the values `true` and `false`. Bitwise function objects are covered in the next section.

Logical functors can, for example, be used to implement an `allTrue()` function that checks if all the Boolean flags in a container are `true`:

```

bool allTrue(const vector<bool>& flags)
{
    return accumulate(begin(flags), end(flags), true, logical_and<>());
}

```

Similarly, the `logical_or` functor can be used to implement an `anyTrue()` function that returns `true` if there is at least one Boolean flag in a container `true`:

```
bool anyTrue(const vector<bool>& flags)
{
    return accumulate(begin(flags), end(flags), false, logical_or<>());
}
```

NOTE *The `allTrue()` and `anyTrue()` functions are just given as examples. In fact, the Standard Library provides the `std::all_of()` and `any_of()` algorithms that perform the same operations, but that have the benefit of short-circuiting, so they are more performant.*

Bitwise Function Objects

C++ has function objects for all the bitwise operations: `bit_and` (`operator&`), `bit_or` (`operator|`), `bit_xor` (`operator^`), and `bit_not` (`operator~`). These bitwise functors can, for example, be used together with the `transform()` algorithm (discussed later in this chapter) to perform bitwise operations on all elements in a container.

Adaptor Function Objects

When you try to use the basic function objects provided by the standard, it often feels as if you're trying to put a square peg into a round hole. For example, you can't use the `less` function object with `find_if()` to find an element smaller than some value because `find_if()` passes only one argument to its callback each time, instead of two. The *adaptor function objects* attempt to rectify this problem and others. They allow you to adapt function objects, lambda expressions, function pointers, basically any callable. The adaptors provide a modicum of support for *functional composition*, that is, to combine functions together to create the exact behavior you need.

Binders

Binders can be used to *bind* parameters of callables to certain values. For this you use `std::bind()`, defined in `<functional>`, which allows you to bind parameters of a callable in a flexible way. You can bind parameters to fixed values, and you can even rearrange parameters in a different order. It is best explained with an example.

Suppose you have a function called `func()` accepting two arguments:

```
void func(int num, string_view str)
{
    cout << "func(" << num << ", " << str << ")" << endl;
}
```

The following code demonstrates how you can use `bind()` to bind the second argument of `func()` to a fixed value, `myString`. The result is stored in `f1()`. The `auto` keyword is used because the return type of `bind()` is unspecified by the C++ standard, and thus is implementation specific.

Arguments that are not bound to specific values should be specified as `_1`, `_2`, `_3`, and so on. These are defined in the `std::placeholders` namespace. In the definition of `f1()`, the `_1` specifies where the first argument to `f1()` needs to go when `func()` is called. After this, `f1()` can be called with just a single integer argument.

```
string myString = "abc";
auto f1 = bind(func, placeholders::_1, myString);
f1(16);
```

Here is the output:

```
func(16, abc)
```

`bind()` can also be used to rearrange the arguments, as shown in the following code. The `_2` specifies where the second argument to `f2()` needs to go when `func()` is called. In other words, the `f2()` binding means that the first argument to `f2()` will become the second argument to `func()`, and the second argument to `f2()` will become the first argument to `func()`.

```
auto f2 = bind(func, placeholders::_2, placeholders::_1);
f2("Test", 32);
```

The output is as follows:

```
func(32, Test)
```

As discussed in Chapter 17, the `<functional>` header file defines the `std::ref()` and `cref()` helper template functions. These can be used to bind references or `const` references, respectively. For example, suppose you have the following function:

```
void increment(int& value) { ++value; }
```

If you call this function as follows, then the value of `index` becomes 1:

```
int index = 0;
increment(index);
```

If you use `bind()` to call it as follows, then the value of `index` is not incremented because a copy of `index` is made, and a reference to this copy is bound to the first parameter of the `increment()` function:

```
int index = 0;
auto incr = bind(increment, index);
incr();
```

Using `std::ref()` to pass a proper reference correctly increments `index`:

```
int index = 0;
auto incr = bind(increment, ref(index));
incr();
```

There is a small issue with binding parameters in combination with overloaded functions. Suppose you have the following two `overloaded()` functions. One accepts an integer and the other accepts a floating-point number:

```
void overloaded(int num) {}
void overloaded(float f) {}
```

If you want to use `bind()` with these overloaded functions, you need to explicitly specify which of the two overloads you want to bind. The following will not compile:

```
auto f3 = bind(overloaded, placeholders::_1); // ERROR
```

If you want to bind the parameters of the overloaded function accepting a floating-point argument, you need the following syntax:

```
auto f4 = bind((void*)(float))overloaded, placeholders::_1); // OK
```

Another example of `bind()` is to use the `find_if()` algorithm to find the first element in a sequence that is greater than or equal to 100. To solve this problem earlier in this chapter, a pointer to a `perfectScore()` function was passed to `find_if()`. This can be rewritten using the comparison functor `greater_equal` and `bind()`. The following code uses `bind()` to bind the second parameter of `greater_equal` to a fixed value of 100:

```
// Code for inputting scores into the vector omitted, similar as earlier.
auto endIter = end(myVector);
auto it = find_if(begin(myVector), endIter,
    bind(greater_equal<>(), placeholders::_1, 100));
if (it == endIter) {
    cout << "No perfect scores" << endl;
} else {
    cout << "Found a \"perfect\" score of " << *it << endl;
}
}
```

Of course, in this case, I would recommend the solution using a lambda expression:

```
auto it = find_if(begin(myVector), endIter, [](int i){ return i >= 100; });
```

WARNING Before C++11 there was `bind2nd()` and `bind1st()`. Both are deprecated since C++11, and are actually removed from the C++17 standard. Use lambda expressions or `bind()` instead.

Negators

C++17

`not_fn`

Negators are similar to binders but they complement the result of a callable. For example, if you want to find the first element in a sequence of test scores less than 100, you can apply the `not_fn()` negator adaptor to the result of `perfectScore()` like this:

```
// Code for inputting scores into the vector omitted, similar as earlier.
auto endIter = end(myVector);
auto it = find_if(begin(myVector), endIter, not_fn(perfectScore));
if (it == endIter) {
    cout << "All perfect scores" << endl;
} else {
    cout << "Found a \"less-than-perfect\" score of " << *it << endl;
}
}
```

The `not_fn()` functor complements the result of every call to the callable it takes as a parameter. Note that in this example you could have used the `find_if_not()` algorithm.

As you can see, using functors and adaptors can become complicated. My advice is to use lambda expressions instead of functors if possible. For example, the previous `find_if()` call using the `not_fn()` negator can be written more elegantly and more readable using a lambda expression:

```
auto it = find_if(begin(myVector), endIter, [](int i){ return i < 100; });
```

not1 and not2

The `std::not_fn()` adaptor is introduced with C++17. Before C++17 you could use the `std::not1()` and `not2()` adaptors. The “1” in `not1()` refers to the fact that its operand must be a unary function (one that takes a single argument). If its operand is a binary function (which takes two arguments), you must use `not2()` instead. Here is an example:

```
// Code for inputting scores into the vector omitted, similar as earlier.
auto endIter = end(myVector);
function<bool(int)> f = perfectScore;
auto it = find_if(begin(myVector), endIter, not1(f));
```

If you wanted to use `not1()` with your own functor class, then you had to make sure your functor class definition included two typedefs: `argument_type` and `result_type`. If you wanted to use `not2()`, then your functor class definition had to provide three typedefs: `first_argument_type`, `second_argument_type`, and `result_type`. The easiest way to do that was to derive your function object class from either `unary_function` or `binary_function`, depending on whether they take one or two arguments. These two classes, defined in `<functional>`, are templated on the parameter and return types of the function they provide. For example:

```
class PerfectScore : public std::unary_function<int, bool>
{
public:
    result_type operator()(const argument_type& score) const
    {
        return score >= 100;
    }
};
```

This functor can be used as follows:

```
auto it = find_if(begin(myVector), endIter, not1(PerfectScore()));
```

NOTE `not1()` and `not2()` have been deprecated by the C++17 standard. Both `unary_function` and `binary_function` are deprecated since C++11, and are officially removed from C++17. You should avoid using any of this functionality in new code.

Calling Member Functions

If you have a container of objects, you sometimes want to pass a pointer to a class method as the callback to an algorithm. For example, you might want to find the first empty string in a vector of strings by calling `empty()` on each string in the sequence. However, if you just pass a pointer to `string::empty()` to `find_if()`, the algorithm has no way to know that it received a pointer to a method instead of a normal function pointer or functor. The code to call a method pointer is different from that to call a normal function pointer, because the former must be called in the context of an object.

C++ provides a conversion function called `mem_fn()` that you can call with a method pointer before passing it to an algorithm. The following example demonstrates this. Note that you have to specify the method pointer as `&string::empty`. The `&string::` part is not optional.

```
void findEmptyString(const vector<string>& strings)
{
    auto endIter = end(strings);
    auto it = find_if(begin(strings), endIter, mem_fn(&string::empty));
    if (it == endIter) {
        cout << "No empty strings!" << endl;
    } else {
        cout << "Empty string at position: "
             << static_cast<int>(it - begin(strings)) << endl;
    }
}
```

`mem_fn()` generates a function object that serves as the callback for `find_if()`. Each time it is called back, it calls the `empty()` method on its argument.

`mem_fn()` works exactly the same when you have a container of pointers to objects instead of objects themselves. Here is an example:

```
void findEmptyString(const vector<string*>& strings)
{
    auto endIter = end(strings);
    auto it = find_if(begin(strings), endIter, mem_fn(&string::empty));
    // Remainder of function omitted because it is the same as earlier
}
```

`mem_fn()` is not the most intuitive way to implement the `findEmptyString()` function. Using lambda expressions, it can be implemented in a much more readable and elegant way. Here is the implementation using a lambda expression working on a container of objects:

```
void findEmptyString(const vector<string>& strings)
{
    auto endIter = end(strings);
    auto it = find_if(begin(strings), endIter,
        [](const string& str){ return str.empty(); });
    // Remainder of function omitted because it is the same as earlier
}
```

Similarly, the following uses a lambda expression working on a container of pointers to objects:

```
void findEmptyString(const vector<string*>& strings)
{
    auto endIter = end(strings);
```

```

    auto it = find_if(begin(strings), endIter,
        [](const string* str){ return str->empty(); });
    // Remainder of function omitted because it is the same as earlier
}

```

C++17

Invokers

C++17 introduces `std::invoke()`, defined in `<functional>`, which you can use to call any callable object with a set of parameters. The following example uses `invoke()` three times: once to invoke a normal function, once to invoke a lambda expression, and once to invoke a member function on a string instance.

```

void printMessage(string_view message) { cout << message << endl; }

int main()
{
    invoke(printMessage, "Hello invoke.");
    invoke([](const auto& msg) { cout << msg << endl; }, "Hello invoke.");
    string msg = "Hello invoke.";
    cout << invoke(&string::size, msg) << endl;
}

```

By itself, `invoke()` is not that useful, because you might as well just call the function or the lambda expression directly. However, it is very useful in templated code where you need to invoke some arbitrary callable object.

Writing Your Own Function Objects

You can write your own function objects to perform more specific tasks than those provided by the predefined functors, and if you need to do something more complex than is suitable for a lambda expression. Here is a very simple function object example:

```

class myIsDigit
{
public:
    bool operator()(char c) const { return ::isdigit(c) != 0; }
};

bool isNumber(string_view str)
{
    auto endIter = end(str);
    auto it = find_if(begin(str), endIter, not_fn(myIsDigit()));
    return (it == endIter);
}

```

Note that the overloaded function call operator of the `myIsDigit` class must be `const` in order to pass objects of it to `find_if()`.

WARNING *The algorithms are allowed to make multiple copies of given predicates, such as functors and lambda expressions, and call different copies for different elements. This places strong restrictions on the side effects of such predicates. For functors, the function call operator needs to be `const`; thus, you cannot write functors such that they count on any internal state to the object being consistent between calls. Similar for lambda expressions, they cannot be marked as `mutable`.*

There are some exceptions, for example `generate()` and `generate_n()` can accept stateful predicates, but even these make one copy of the predicate. They don't return that copy, so, you don't have access to the changes made to the state once the algorithm is finished. The only exception is `for_each()`. It copies the given predicate once into the `for_each()` algorithm, and returns that copy when finished. You can access the changed state through this returned value.

If you need stateful predicates for other algorithms, wrap your predicate in an `std::reference_wrapper` which you can create using `std::ref()`.

Before C++11, a class defined locally in the scope of a function could not be used as a template argument. This limitation has been removed, as shown in the following example:

```
bool isNumber(string_view str)
{
    class myIsDigit
    {
    public:
        bool operator()(char c) const { return ::isdigit(c) != 0; }
    };
    auto endIter = end(str);
    auto it = find_if(begin(str), endIter, not_fn(myIsDigit()));
    return (it == endIter);
}
```

NOTE *As you can see from the previous examples, lambda expressions allow you to write more readable and more elegant code. I recommend that you use simple lambda expressions instead of function objects, and that you use function objects only when they need to do more complicated things.*

ALGORITHM DETAILS

Chapter 16 lists all available Standard Library algorithms, divided into different categories. Most of the algorithms are defined in the `<algorithm>` header file, but a few are located in `<numeric>` and in `<utility>`. They are all in the `std` namespace. I cannot discuss all available algorithms in this chapter, and so I have picked a number of categories and provided examples for them. Once you

know how to use these algorithms, you should have no problems with the other algorithms. Consult a Standard Library Reference, see Appendix B, for a full reference of *all* the algorithms.

Iterators

First, a few more words on iterators. There are five types of iterators: input, output, forward, bidirectional, and random access. These are described in Chapter 17. There is no formal class hierarchy of these iterators, because the implementations for each container are not part of the standard hierarchy. However, one can deduce a hierarchy based on the functionality they are required to provide. Specifically, every random-access iterator is also bidirectional, every bidirectional iterator is also forward, and every forward iterator is also input. Iterators that satisfy the requirements for output iterators are called *mutable iterators*; otherwise they are called *constant iterators*. Figure 18-1 shows such hierarchy. Dotted lines are used because the figure is not a real class hierarchy.

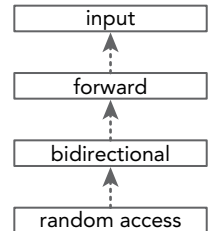

FIGURE 18-1

The standard way for the algorithms to specify what kind of iterators they need is to use the following names for the iterator template type arguments: `InputIterator`, `OutputIterator`, `ForwardIterator`, `BidirectionalIterator`, and `RandomAccessIterator`. These names are just names: they don't provide binding type checking. Therefore, you could, for example, try to call an algorithm expecting a `RandomAccessIterator` by passing a bidirectional iterator. The template cannot do type checking, so it would allow this instantiation. However, the code in the function that uses the random-access iterator capabilities would fail to compile on the bidirectional iterator. Thus, the requirement is enforced, just not where you would expect. The error message can therefore be somewhat confusing. For example, attempting to use the generic `sort()` algorithm, which requires a random access iterator, on a `list`, which provides only a bidirectional iterator, gives a cryptic error of more than 30 lines in Visual C++ 2017, of which the first two lines are as follows:

```
... \vc\tools\msvc\14.11.25301\include\algorithm(3032): error C2784: 'unknown-type
std::operator -(const std::move_iterator<_RanIt> &,const std::move_iterator<_
RanIt2> &)': could not deduce template argument for 'const std::move_iterator<_
RanIt> &' from 'std::_List_unchecked_iterator<std::_List_val<std::_List_simple
types<int>>>'
... \vc\tools\msvc\14.11.25301\include\xutility(2191): note: see declaration of
'std::operator -'
```

Non-modifying Sequence Algorithms

The non-modifying sequence algorithms include functions for searching elements in a range and for comparing two ranges to each other; they also include a number of counting algorithms.

Search Algorithms

You've already seen examples of two search algorithms: `find()` and `find_if()`. The Standard Library provides several other variations of the basic `find()` algorithm that work on sequences of elements. The section, "Search Algorithms," in Chapter 16 describes the different search algorithms that are available, including their complexity.

All the algorithms use default comparisons of `operator==` or `operator<`, but also provide over-loaded versions that allow you to specify a comparison callback.

Here are examples of some of the search algorithms:

```
// The list of elements to be searched
vector<int> myVector = { 5, 6, 9, 8, 8, 3 };
auto beginIter = cbegin(myVector);
auto endIter = cend(myVector);

// Find the first element that does not satisfy the given lambda expression
auto it = find_if_not(beginIter, endIter, [](int i){ return i < 8; });
if (it != endIter) {
    cout << "First element not < 8 is " << *it << endl;
}

// Find the first pair of matching consecutive elements
it = adjacent_find(beginIter, endIter);
if (it != endIter) {
    cout << "Found two consecutive equal elements with value " << *it << endl;
}

// Find the first of two values
vector<int> targets = { 8, 9 };
it = find_first_of(beginIter, endIter, cbegin(targets), cend(targets));
if (it != endIter) {
    cout << "Found one of 8 or 9: " << *it << endl;
}

// Find the first subsequence
vector<int> sub = { 8, 3 };
it = search(beginIter, endIter, cbegin(sub), cend(sub));
if (it != endIter) {
    cout << "Found subsequence {8,3}" << endl;
} else {
    cout << "Unable to find subsequence {8,3}" << endl;
}

// Find the last subsequence (which is the same as the first in this example)
auto it2 = find_end(beginIter, endIter, cbegin(sub), cend(sub));
if (it != it2) {
    cout << "Error: search and find_end found different subsequences "
        << "even though there is only one match." << endl;
}

// Find the first subsequence of two consecutive 8s
it = search_n(beginIter, endIter, 2, 8);
if (it != endIter) {
    cout << "Found two consecutive 8s" << endl;
} else {
    cout << "Unable to find two consecutive 8s" << endl;
}
```

Here is the output:

```
First element not < 8 is 9
Found two consecutive equal elements with value 8
Found one of 8 or 9: 9
Found subsequence {8,3}
Found two consecutive 8s
```

NOTE Remember that some of the containers have methods equivalent to generic algorithms. If that's the case, it's recommended to use the methods instead of the generic algorithms, because the methods are more efficient.

C++17

Specialized Searchers

C++17 adds an optional extra parameter to the `search()` algorithm that allows you to specify which search algorithm to use. You have three options: `default_searcher`, `boyer_moore_searcher`, or `boyer_moore_horspool_searcher`, all defined in `<functional>`. The last two options implement the well-known *Boyer-Moore* and *Boyer-Moore-Horspool* search algorithms. These are very efficient, and can be used to find a substring in a larger piece of text. The complexity of the Boyer-Moore searchers is as follows (N is the size of the sequence to search in, the haystack, and M is the size of the pattern to find, the needle):

- If the pattern is not found: worst-case complexity is $O(N+M)$
- If the pattern is found: worst-case complexity is $O(NM)$

These are the theoretical worst-case complexities. In practice, these specialized searchers are sublinear, better than $O(N)$, which means they are much faster than the default one! They are sublinear because they are able to skip characters instead of looking at each single character in the haystack. They also have an interesting property that the longer the needle is, the faster they work, as they will be able to skip more characters in the haystack. The difference between the Boyer-Moore and the Boyer-Moore-Horspool algorithm is that the latter has less constant overhead for its initialization and in each loop iteration of its algorithm; however, its worst-case complexity can be significantly higher than for the Boyer-Moore algorithm. So, which one to choose depends on your specific use case.

Here is an example of using a Boyer-Moore searcher:

```
string text = "This is the haystack to search a needle in.";
string toSearchFor = "needle";
auto searcher = std::boyer_moore_searcher(
    cbegin(toSearchFor), cend(toSearchFor));
auto result = search(cbegin(text), cend(text), searcher);
if (result != cend(text)) {
    cout << "Found the needle." << endl;
} else {
    cout << "Needle not found." << endl;
}
```

Comparison Algorithms

You can compare entire ranges of elements in three different ways: `equal()`, `mismatch()`, and `lexicographical_compare()`. These algorithms have the advantage that you can compare ranges in different containers. For example, you can compare the contents of a `vector` with the contents of a `list`. In general, these algorithms work best with sequential containers. They work by comparing the values in corresponding positions of the two collections to each other. The following list describes how each algorithm works.

- `equal()` returns `true` if all corresponding elements are equal. Originally, `equal()` accepted three iterators: `begin` and `end` iterators for the first range, and a `begin` iterator for the second range. This version required both ranges to have the same number of elements. Since C++14, there is an overload accepting four iterators: `begin` and `end` iterators for the first range, and `begin` and `end` iterators for the second range. This version can cope with ranges of different sizes. It's recommended to always use the four-iterator version because it's safer!
- `mismatch()` returns iterators, one iterator for each range, to indicate where in the range the corresponding elements mismatch. There are three-iterator and four-iterator versions available, just as with `equal()`. It's again recommended to use the four-iterator version, because of safety!
- `lexicographical_compare()` returns `true` if the first unequal element in the first range is less than its corresponding element in the second range, or, if the first range has fewer elements than the second and all elements in the first range are equal to their corresponding initial subsequence in the second set. `lexicographical_compare()` gets its name because it resembles the rules for comparing strings, but extends this set of rules to deal with objects of any type.

NOTE *If you want to compare the elements of two containers of the same type, you can use `operator==` or `operator<` instead of `equal()` or `lexicographical_compare()`. The algorithms are useful for comparing subranges, C-style arrays, sequences of elements from different container types, and so on.*

Here are some examples of these algorithms:

```
// Function template to populate a container of ints.
// The container must support push_back().
template<typename Container>
void populateContainer(Container& cont)
{
    int num;
    while (true) {
        cout << "Enter a number (0 to quit): ";
        cin >> num;
        if (num == 0) {
            break;
        }
        cont.push_back(num);
    }
}
```

```

int main()
{
    vector<int> myVector;
    list<int> myList;

    cout << "Populate the vector:" << endl;
    populateContainer(myVector);
    cout << "Populate the list:" << endl;
    populateContainer(myList);

    // Compare the two containers
    if (equal(cbegin(myVector), cend(myVector),
             cbegin(myList), cend(myList))) {
        cout << "The two containers have equal elements" << endl;
    } else {
        // If the containers were not equal, find out why not
        auto miss = mismatch(cbegin(myVector), cend(myVector),
                             cbegin(myList), cend(myList));
        cout << "The following initial elements are the same in "
              << "the vector and the list:" << endl;
        for (auto i = cbegin(myVector); i != miss.first; ++i) {
            cout << *i << '\t';
        }
        cout << endl;
    }

    // Now order them.
    if (lexicographical_compare(cbegin(myVector), cend(myVector),
                                cbegin(myList), cend(myList))) {
        cout << "The vector is lexicographically first." << endl;
    } else {
        cout << "The list is lexicographically first." << endl;
    }
    return 0;
}

```

Here is a sample run of the program:

```

Populate the vector:
Enter a number (0 to quit): 5
Enter a number (0 to quit): 6
Enter a number (0 to quit): 7
Enter a number (0 to quit): 0
Populate the list:
Enter a number (0 to quit): 5
Enter a number (0 to quit): 6
Enter a number (0 to quit): 9
Enter a number (0 to quit): 8
Enter a number (0 to quit): 0
The following initial elements are the same in the vector and the list:
5      6
The vector is lexicographically first.

```

Counting Algorithms

The non-modifying counting algorithms are `all_of()`, `any_of()`, `none_of()`, `count()`, and `count_if()`. Here are some examples of the first three algorithms. (An example of `count_if()` is given earlier in this chapter.)

```
// all_of()
vector<int> vec2 = { 1, 1, 1, 1 };
if (all_of(cbegin(vec2), cend(vec2), [](int i){ return i == 1; })) {
    cout << "All elements are == 1" << endl;
} else {
    cout << "Not all elements are == 1" << endl;
}

// any_of()
vector<int> vec3 = { 0, 0, 1, 0 };
if (any_of(cbegin(vec3), cend(vec3), [](int i){ return i == 1; })) {
    cout << "At least one element == 1" << endl;
} else {
    cout << "No elements are == 1" << endl;
}

// none_of()
vector<int> vec4 = { 0, 0, 0, 0 };
if (none_of(cbegin(vec4), cend(vec4), [](int i){ return i == 1; })) {
    cout << "All elements are != 1" << endl;
} else {
    cout << "Some elements are == 1" << endl;
}
```

The output is as follows:

```
All elements are == 1
At least one element == 1
All elements are != 1
```

Modifying Sequence Algorithms

The Standard Library provides a variety of *modifying sequence algorithms* that perform tasks such as copying elements from one range to another, removing elements, or reversing the order of elements in a range.

Some modifying algorithms use the concept of a *source* and a *destination* range. The elements are read from the source range and modified in the destination range. Other algorithms perform their work *in-place*, that is, they only require one range.

WARNING *The modifying algorithms cannot insert elements into a destination. They can only overwrite/modify whatever elements are in the destination already. Chapter 21 describes how iterator adaptors can be used to really insert elements into a destination.*

NOTE *Ranges from `maps` and `multimaps` cannot be used as destinations of modifying algorithms. These algorithms overwrite entire elements, which in a `map` consist of key/value pairs. However, `maps` and `multimaps` mark the key `const`, so it cannot be assigned to. The same holds for `set` and `multiset`. Your alternative is to use an insert iterator, described in Chapter 21.*

The section “Modifying Sequence Algorithms” in Chapter 16 lists all available modifying algorithms with a description of each one. This section provides code examples for a number of those algorithms. If you understand how to use the algorithms explained in this section, you should not have any problems using the other algorithms for which no examples are given.

transform

A first version of the `transform()` algorithm applies a callback to each element in a range and expects the callback to generate a new element, which it stores in the specified destination range. The source and destination ranges can be the same if you want `transform()` to replace each element in a range with the result from the call to the callback. The parameters are a begin and end iterator of the source sequence, a begin iterator of the destination sequence, and the callback. For example, you could add 100 to each element in a `vector` like this:

```
vector<int> myVector;
populateContainer(myVector);

cout << "The vector contains:" << endl;
for (const auto& i : myVector) { cout << i << " "; }
cout << endl;

transform(begin(myVector), end(myVector), begin(myVector),
         [](int i){ return i + 100;});

cout << "The vector contains:" << endl;
for (const auto& i : myVector) { cout << i << " "; }
```

Another version of `transform()` calls a binary function on pairs of elements in a range. It requires a begin and end iterator of the first range, a begin iterator of the second range, and a begin iterator of the destination range. The following example creates two `vectors` and uses `transform()` to calculate the sum of pairs of elements and store the result back in the first `vector`:

```
vector<int> vec1, vec2;
cout << "Vector1:" << endl; populateContainer(vec1);
cout << "Vector2:" << endl; populateContainer(vec2);

if (vec2.size() < vec1.size())
{
    cout << "Vector2 should be at least the same size as vector1." << endl;
    return 1;
}
```

```

// Create a lambda to print the contents of a container
auto printContainer = [](const auto& container) {
    for (auto& i : container) { cout << i << " "; }
    cout << endl;
};

cout << "Vector1: "; printContainer(vec1);
cout << "Vector2: "; printContainer(vec2);

transform(begin(vec1), end(vec1), begin(vec2), begin(vec1),
    [](int a, int b){return a + b;});

cout << "Vector1: "; printContainer(vec1);
cout << "Vector2: "; printContainer(vec2);

```

The output could look like this:

```

Vector1:
Enter a number (0 to quit): 1
Enter a number (0 to quit): 2
Enter a number (0 to quit): 0
Vector2:
Enter a number (0 to quit): 11
Enter a number (0 to quit): 22
Enter a number (0 to quit): 33
Enter a number (0 to quit): 0
Vector1: 1 2
Vector2: 11 22 33
Vector1: 12 24
Vector2: 11 22 33

```

NOTE `transform()` and the other modifying algorithms often return an iterator referring to the past-the-end value of the destination range. The examples in this book usually ignore that return value.

copy

The `copy()` algorithm allows you to copy elements from one range to another, starting with the first element and proceeding to the last element in the range. The source and destination ranges must be different, but, with restrictions, they can overlap. The restrictions are as follows: for `copy(b, e, d)`, overlapping is fine if `d` is before `b`, however, if `d` is within `[b, e)`, then the behavior is undefined. As with all modifying algorithms, `copy()` cannot insert elements into the destination. It just overwrites whatever elements are there already. Chapter 21 describes how to use iterator adaptors to insert elements into a container or stream with `copy()`.

Here is a simple example of `copy()` that uses the `resize()` method on a vector to ensure that there is enough space in the destination container. It copies all elements from `vec1` to `vec2`:

```

vector<int> vec1, vec2;
populateContainer(vec1);

```

```
vec2.resize(size(vec1));
copy(cbegin(vec1), cend(vec1), begin(vec2));
for (const auto& i : vec2) { cout << i << " "; }
```

There is also a `copy_backward()` algorithm, which copies the elements from the source backward to the destination. In other words, it starts with the last element of the source, puts it in the last position in the destination range, and then moves backward after each copy. Also for `copy_backward()`, the source and destination ranges must be different, but, with restrictions, they can again overlap. The restrictions this time are as follows: for `copy_backward(b, e, d)`, overlapping is fine if `d` is after `e`, however, if `d` is within `(b, e]`, then the behavior is undefined. The preceding example can be modified to use `copy_backward()` instead of `copy()`, as follows. Note that you need to specify `end(vec2)` as a third argument instead of `begin(vec2)`.

```
copy_backward(cbegin(vec1), cend(vec1), end(vec2));
```

This results in exactly the same output.

`copy_if()` works by having an input range specified by two iterators, an output destination specified by one iterator, and a predicate (for example, a function or lambda expression). The algorithm copies all elements that satisfy the given predicate to the destination. Remember, `copy` does not create or extend containers; it merely replaces existing elements, so the destination should be big enough to hold all elements to be copied. Of course, after copying the elements, it might be desirable to remove the space “beyond” where the last element was copied to. To facilitate this, `copy_if()` returns an iterator to the one-past-the-last-copied element in the destination range. This method can be used to determine how many elements should be removed from the destination container. The following example demonstrates this by copying only the even numbers to `vec2`:

```
vector<int> vec1, vec2;
populateContainer(vec1);
vec2.resize(size(vec1));
auto endIterator = copy_if(cbegin(vec1), cend(vec1),
    begin(vec2), [](int i){ return i % 2 == 0; });
vec2.erase(endIterator, end(vec2));
for (const auto& i : vec2) { cout << i << " "; }
```

`copy_n()` copies `n` elements from the source to the destination. The first parameter of `copy_n()` is the start iterator. The second parameter is an integer specifying the number of elements to copy, and the third parameter is the destination iterator. The `copy_n()` algorithm does not perform any bounds checking, so you must make sure that the start iterator, incremented by the number of elements to copy, does not exceed the `end()` of the collection or your program will have undefined behavior. Here is an example:

```
vector<int> vec1, vec2;
populateContainer(vec1);
size_t cnt = 0;
cout << "Enter number of elements you want to copy: ";
cin >> cnt;
cnt = min(cnt, size(vec1));
vec2.resize(cnt);
copy_n(cbegin(vec1), cnt, begin(vec2));
for (const auto& i : vec2) { cout << i << " "; }
```

move

There are two move-related algorithms: `move()` and `move_backward()`. They both use move semantics, which are discussed in Chapter 9. You have to provide a move assignment operator in your element classes if you want to use these algorithms on containers with elements of your own types, as demonstrated in the following example. The `main()` function creates a `vector` with three `MyClass` objects, and then moves those elements from `vecSrc` to `vecDst`. Note that the code includes two different uses of `move()`. The `move()` function accepting a single argument converts an lvalue into an rvalue and is defined in `<utility>`, while `move()` accepting three arguments is the Standard Library `move()` algorithm to move elements between containers. Consult Chapter 9 for details on implementing move assignment operators and the use of the single parameter version of `std::move()`.

```
class MyClass
{
public:
    MyClass() = default;
    MyClass(const MyClass& src) = default;
    MyClass(string_view str) : mStr(str) {}
    virtual ~MyClass() = default;

    // Move assignment operator
    MyClass& operator=(MyClass&& rhs) noexcept {
        if (this == &rhs)
            return *this;
        mStr = std::move(rhs.mStr);
        cout << "Move operator= (mStr=" << mStr << ")" << endl;
        return *this;
    }

    void setString(string_view str) { mStr = str; }
    string_view getString() const {return mStr;}
private:
    string mStr;
};

int main()
{
    vector<MyClass> vecSrc {MyClass("a"), MyClass("b"), MyClass("c")};
    vector<MyClass> vecDst(vecSrc.size());
    move(begin(vecSrc), end(vecSrc), begin(vecDst));
    for (const auto& c : vecDst) { cout << c.getString() << " "; }
    return 0;
}
```

The output is as follows:

```
Move operator= (mStr=a)
Move operator= (mStr=b)
Move operator= (mStr=c)
a b c
```

NOTE Chapter 9 explains that source objects in a move operation are left in some valid but otherwise indeterminate state. For the previous example, this means that you should not use the elements from `vecSrc` anymore after the move operation, unless you bring them back to a determinate state; for example by calling a method on them without any preconditions, such as `setString()`.

`move_backward()` uses the same move mechanism as `move()`, but it moves the elements starting from the last to the first element. For both `move()` and `move_backward()`, the source and destination ranges are allowed to overlap with certain restrictions. These restrictions are the same as discussed for `copy()` and `copy_backward()`.

replace

The `replace()` and `replace_if()` algorithms replace elements in a range matching a value or predicate, respectively, with a new value. Take `replace_if()` as an example. Its first and second parameters specify the range of elements in your container. The third parameter is a function or lambda expression that returns `true` or `false`. If it returns `true`, the value in the container is replaced with the value given as fourth parameter; if it returns `false`, it leaves the original value.

For example, you might want to replace all odd values in a container with the value zero:

```
vector<int> vec;
populateContainer(vec);
replace_if(begin(vec), end(vec), [](int i){ return i % 2 != 0; }, 0);
for (const auto& i : vec) { cout << i << " "; }
```

There are also variants of `replace()` and `replace_if()` called `replace_copy()` and `replace_copy_if()` that copy the results to a different destination range. They are similar to `copy()`, in that the destination range must already be large enough to hold the new elements.

remove

Suppose you have a range of elements and you want to remove elements matching a certain condition. The first solution that you might think of is to check the documentation to see if your container has an `erase()` method, and then iterate over all the elements and call `erase()` for each element that matches the condition. The `vector` is an example of a container that has such an `erase()` method. However, if applied to the `vector` container, this solution is very inefficient as it will cause a lot of memory operations to keep the `vector` contiguous in memory, resulting in a quadratic complexity.¹ This solution is also error-prone, because you need to be careful that you keep your iterators valid after a call to `erase()`. For example, here is a function that removes empty strings from a `vector` of strings without using algorithms. Note how `iter` is carefully manipulated inside the `for` loop:

```
void removeEmptyStringsWithoutAlgorithms(vector<string>& strings)
{
    for (auto iter = begin(strings); iter != end(strings); ) {
```

¹Quadratic complexity means that the running time is a function of the square of the input size, $O(n^2)$.

```

        if (iter->empty())
            iter = strings.erase(iter);
        else
            ++iter;
    }
}

```

This solution is inefficient and not recommended. The correct solution for this problem is the so-called *remove-erase-idiom*, which runs in linear time and is explained next.

Algorithms have access only to the iterator abstraction, not to the container. Thus, the remove algorithms cannot really remove them from the underlying container. Instead, the algorithms work by replacing the elements that match the given value or predicate with the next element that does not match the given value or predicate. It does so using move assignments. The result is that the range becomes partitioned into two sets: the elements to be kept and the elements to be erased. An iterator is returned that points to the first element in the range of elements to be erased. If you want to actually erase these elements from the container, you must first use the `remove()` algorithm, then call `erase()` on the container to erase all the elements from the returned iterator up to the end of the range. This is the *remove-erase-idiom*. Here is an example of a function that removes empty strings from a vector of strings:

```

void removeEmptyStrings(vector<string>& strings)
{
    auto it = remove_if(begin(strings), end(strings),
        [](const string& str){ return str.empty(); });
    // Erase the removed elements.
    strings.erase(it, end(strings));
}

int main()
{
    vector<string> myVector = {"", "one", "", "two", "three", "four"};
    for (auto& str : myVector) { cout << "\"" << str << "\" "; }
    cout << endl;
    removeEmptyStrings(myVector);
    for (auto& str : myVector) { cout << "\"" << str << "\" "; }
    cout << endl;
    return 0;
}

```

The output is as follows:

```

"" "one" "" "two" "three" "four"
"one" "two" "three" "four"

```

WARNING *When using the remove-erase-idiom, make sure not to forget the second argument to `erase()`! If you forget this second argument, `erase()` will only erase a single element from the container, that is, the element pointed to by the iterator passed as first argument.*

The `remove_copy()` and `remove_copy_if()` variations of `remove()` and `remove_if()` do not change the source range. Instead, they copy all kept elements to a different destination range. They are similar to `copy()`, in that the destination range must already be large enough to hold the new elements.

NOTE *The `remove()` family of functions are stable in that they maintain the order of elements remaining in the container even while moving the retained elements toward the beginning.*

unique

The `unique()` algorithm is a special case of `remove()` that removes all duplicate contiguous elements. The `list` container provides its own `unique()` method that implements the same semantics. You should generally use `unique()` on sorted sequences, but nothing prevents you from running it on unsorted sequences.

The basic form of `unique()` runs in place, but there is also a version of the algorithm called `unique_copy()` that copies its results to a new destination range.

Chapter 17 shows an example of the `list::unique()` algorithm in the section “list Example: Determining Enrollment,” so an example of the general form is omitted here.

C++17

sample

The `sample()` algorithm returns a selection of n randomly chosen elements from a given source range and stores them in a destination range. It requires five parameters:

- A begin and end iterator of the range to sample
- A begin iterator of the destination range where you want to store the randomly selected elements
- The number of elements to select
- A random number generation engine

Here is an example (details on how to use random number generation engines, and how to “seed” them are explained in Chapter 20):

```
vector<int> vec{ 1,2,3,4,5,6,7,8,9,10 };
const size_t numberOfSamples = 5;
vector<int> samples(numberOfSamples);

random_device seeder;
const auto seed = seeder.entropy() ? seeder() : time(nullptr);
default_random_engine(
    static_cast<default_random_engine::result_type>(seed));
```

```

for (int i = 0; i < 6; ++i) {
    sample(cbegin(vec), cend(vec), begin(samples), numberOfSamples, engine);

    for (const auto& sample : samples) { cout << sample << " "; }
    cout << endl;
}

```

Here is some possible output:

```

1 2 5 8 10
1 2 4 5 7
5 6 8 9 10
2 3 4 6 7
2 5 7 8 10
1 2 5 6 7

```

reverse

The `reverse()` algorithm reverses the order of the elements in a range. The first element in the range is swapped with the last, the second with the second-to-last, and so on.

The basic form of `reverse()` runs in place and requires two arguments: a start and end iterator for the range. There is also a version of the algorithm called `reverse_copy()` that copies its results to a new destination range and requires three arguments: a start and end iterator for the source range, and a start iterator for the destination range. The destination range must already be large enough to hold the new elements.

shuffle

`shuffle()` rearranges the elements of a range in a random order with a linear complexity. It's useful for implementing tasks like shuffling a deck of cards. `shuffle()` requires a start and end iterator for the range that you want to shuffle and a uniform random number generator object that specifies how the random numbers should be generated. Random number generators are discussed in detail in Chapter 20.

Operational Algorithms

There are only two algorithms in this category: `for_each()` and `for_each_n()`. The latter is introduced with C++17. They execute a callback on each element of the range, or on the first n elements of a range, respectively. You can use them with simple function callbacks or lambda expressions for things like printing elements from a container. The algorithms are mentioned here so you know they exist; however, it's often easier and more readable to use a simple range-based `for` loop instead.

for_each

Following is an example using a generic lambda expression, printing the elements from a map:

```

map<int, int> myMap = { { 4, 40 }, { 5, 50 }, { 6, 60 } };
for_each(cbegin(myMap), cend(myMap), [](const auto& p)
        { cout << p.first << "->" << p.second << endl; });

```

The type of `p` is `const pair<int, int>&`. The output is as follows:

```
4->40
5->50
6->60
```

The following example shows how to use the `for_each()` algorithm and a lambda expression to calculate the sum and the product of a range of elements at the same time. Note that the lambda expression explicitly captures only those variables it needs. It captures them by reference; otherwise, changes made to `sum` and `product` in the lambda expression would not be visible outside the lambda.

```
vector<int> myVector;
populateContainer(myVector);

int sum = 0;
int product = 1;
for_each(cbegin(myVector), cend(myVector),
        [&sum, &product](int i){
            sum += i;
            product *= i;
        });
cout << "The sum is " << sum << endl;
cout << "The product is " << product << endl;
```

This example can also be written with a functor in which you accumulate information that you can retrieve after `for_each()` has finished processing each element. For example, you could calculate both the sum and product of the elements in one pass by writing a functor `SumAndProduct` that tracks both at the same time:

```
class SumAndProduct
{
public:
    void operator()(int value);
    int getSum() const { return mSum; }
    int getProduct() const { return mProduct; }
private:
    int mSum = 0;
    int mProduct = 1;
};

void SumAndProduct::operator()(int value)
{
    mSum += value;
    mProduct *= value;
}

int main()
{
    vector<int> myVector;
    populateContainer(myVector);
```

```

SumAndProduct func;
func = for_each(cbegin(myVector), cend(myVector), func);
cout << "The sum is " << func.getSum() << endl;
cout << "The product is " << func.getProduct() << endl;
return 0;
}

```

You might be tempted to ignore the return value of `for_each()`, yet still try to read information from `func` after the call. However, that doesn't work because the functor is copied into the `for_each()`, and at the end, this copy is returned from the call. You must capture the return value in order to ensure correct behavior.

A final point about both `for_each()` and `for_each_n()`, discussed next, is that your lambda or callback is allowed to take its parameter by reference and modify it. That has the effect of changing values in the actual iterator range. The voter registration example later in this chapter shows a use of this capability.

C++17

for_each_n

The `for_each_n()` algorithm requires a begin iterator of the range, the number of elements to iterate over, and a function callback. It returns an iterator equal to `begin + n`. As usual, it does not perform any bounds checking. Here is an example that only iterates over the first two elements of a map:

```

map<int, int> myMap = { { 4, 40 }, { 5, 50 }, { 6, 60 } };
for_each_n(cbegin(myMap), 2, [](const auto& p)
    { cout << p.first << "->" << p.second << endl; });

```

Swap and Exchange Algorithms

The C++ Standard Library provides the following swap and exchange algorithms.

swap

`std::swap()` is used to efficiently swap two values, using move semantics if available. Its use is straightforward:

```

int a = 11;
int b = 22;
cout << "Before swap(): a = " << a << ", b = " << b << endl;
swap(a, b);
cout << "After swap(): a = " << a << ", b = " << b << endl;

```

The output is as follows:

```

Before swap(): a = 11, b = 22
After swap(): a = 22, b = 11

```

C++17

exchange

`std::exchange()`, defined in `<utility>`, replaces a value with a new value and returns the old value, as in this example:

```
int a = 11;
int b = 22;
cout << "Before exchange(): a = " << a << ", b = " << b << endl;
int returnedValue = exchange(a, b);
cout << "After exchange(): a = " << a << ", b = " << b << endl;
cout << "exchange() returned: " << returnedValue << endl;
```

The output is as follows:

```
Before exchange(): a = 11, b = 22
After exchange(): a = 22, b = 22
exchange() returned: 11
```

`exchange()` is useful in implementing move assignment operators. A move assignment operator needs to move the data from a source object to a destination object. Often, the data in the source object is nullified. Typically, this is done as follows. Suppose `Foo` has as data member a pointer to some raw memory, called `mPtr`:

```
Foo& operator=(Foo&& rhs) noexcept
{
    // Check for self-assignment
    if (this == &rhs) { return *this; }
    // Free the old memory
    delete mPtr; mPtr = nullptr;
    // Move data
    mPtr = rhs.mPtr; // Move data from source to destination
    rhs.mPtr = nullptr; // Nullify data in source
    return *this;
}
```

The assignments to `mPtr` and to `rhs.mPtr` near the end of the method can be implemented using `exchange()` as follows:

```
Foo& operator=(Foo&& rhs) noexcept
{
    // Check for self-assignment
    if (this == &rhs) { return *this; }
    // Free the old memory
    delete mPtr; mPtr = nullptr;
    // Move data
    mPtr = exchange(rhs.mPtr, nullptr); // Move + nullify
    return *this;
}
```

Partition Algorithms

`partition_copy()` copies elements from a source to two different destinations. The specific destination for each element is selected based on the result of a predicate, either `true` or `false`.

The returned value of `partition_copy()` is a pair of iterators: one iterator referring to one-past-the-last-copied element in the first destination range, and one iterator referring to one-past-the-last-copied element in the second destination range. These returned iterators can be used in combination with `erase()` to remove excess elements from the two destination ranges, just as in the earlier `copy_if()` example. The following example asks the user to enter a number of integers, which are then *partitioned* into two destination vectors: one for the even numbers and one for the odd numbers.

```
vector<int> vec1, vecOdd, vecEven;
populateContainer(vec1);
vecOdd.resize(size(vec1));
vecEven.resize(size(vec1));

auto pairIters = partition_copy(cbegin(vec1), cend(vec1),
    begin(vecEven), begin(vecOdd),
    [](int i){ return i % 2 == 0; });

vecEven.erase(pairIters.first, end(vecEven));
vecOdd.erase(pairIters.second, end(vecOdd));

cout << "Even numbers: ";
for (const auto& i : vecEven) { cout << i << " "; }
cout << endl << "Odd numbers: ";
for (const auto& i : vecOdd) { cout << i << " "; }
```

The output can be as follows:

```
Enter a number (0 to quit): 11
Enter a number (0 to quit): 22
Enter a number (0 to quit): 33
Enter a number (0 to quit): 44
Enter a number (0 to quit): 0
Even numbers: 22 44
Odd numbers: 11 33
```

The `partition()` algorithm sorts a sequence such that all elements for which a predicate returns `true` are before all elements for which it returns `false`, without preserving the original order of the elements within each partition. The following example demonstrates how to partition a vector into all even numbers followed by all odd numbers:

```
vector<int> vec;
populateContainer(vec);
partition(begin(vec), end(vec), [](int i){ return i % 2 == 0; });
cout << "Partitioned result: ";
for (const auto& i : vec) { cout << i << " "; }
```

The output can be as follows:

```
Enter a number (0 to quit): 55
Enter a number (0 to quit): 44
Enter a number (0 to quit): 33
Enter a number (0 to quit): 22
Enter a number (0 to quit): 11
Enter a number (0 to quit): 0
Partitioned result: 22 44 33 55 11
```

A couple of other partition algorithms are available. See Chapter 16 for a list.

Sorting Algorithms

The Standard Library provides several variations of sorting algorithms. A “sorting algorithm” reorders the contents of a container such that an ordering is maintained between sequential elements of the collection. Thus, it applies only to sequential collections. Sorting is not relevant for ordered associative containers because they already maintain elements in a sorted order. Sorting is not relevant to the unordered associative containers either, because they have no concept of ordering. Some containers, such as `list` and `forward_list`, provide their own sorting methods, because these methods can be implemented more efficiently than a generic sorting mechanism. Consequently, the generic sorting algorithms are most useful for `vectors`, `deque`s, `arrays`, and C-style arrays.

The `sort()` algorithm sorts a range of elements in $O(N \log N)$ time in general. Following the application of `sort()` to a range, the elements in the range are in nondecreasing order (lowest to highest), according to `operator<`. If you don’t like that order, you can specify a different comparator, such as `greater`.

A variant of `sort()`, called `stable_sort()`, maintains the relative order of equal elements in a range, which means that it is less efficient than the `sort()` algorithm.

Here is an example of `sort()`:

```
vector<int> vec;
populateContainer(vec);
sort(begin(vec), end(vec), greater<>());
```

There is also `is_sorted()` and `is_sorted_until()`. `is_sorted()` returns `true` if a given range is sorted, while `is_sorted_until()` returns an iterator such that everything before this iterator is sorted.

Binary Search Algorithms

There are several search algorithms that work only on sequences that are sorted, or that are at least partitioned on the element that is searched for. These algorithms are `binary_search()`, `lower_bound()`, `upper_bound()`, and `equal_range()`. The `lower_bound()`, `upper_bound()`, and `equal_range()` algorithms are similar to their method equivalents on the `map` and `set` containers. See Chapter 17 for an example on how to use them on such containers.

The `lower_bound()` algorithm finds the first element in a sorted range not less than (that is greater or equal to) a given value. It is often used to find at which position in a sorted `vector` a new value should be inserted, so that the `vector` remains sorted. Here is an example:

```
vector<int> vec;
populateContainer(vec);

// Sort the container
sort(begin(vec), end(vec));

cout << "Sorted vector: ";
for (const auto& i : vec) { cout << i << " "; }
cout << endl;
```

```
while (true) {
    int num;
    cout << "Enter a number to insert (0 to quit): ";
    cin >> num;
    if (num == 0) {
        break;
    }

    auto iter = lower_bound(begin(vec), end(vec), num);
    vec.insert(iter, num);

    cout << "New vector: ";
    for (const auto& i : vec) { cout << i << " "; }
    cout << endl;
}
```

The `binary_search()` algorithm finds a matching element in logarithmic time instead of linear time. It requires a start and end iterator specifying the range to search in, a value to search, and optionally a comparison callback. It returns `true` if the value is found in the specified range, `false` otherwise. The following example demonstrates this algorithm:

```
vector<int> vec;
populateContainer(vec);

// Sort the container
sort(begin(vec), end(vec));

while (true) {
    int num;
    cout << "Enter a number to find (0 to quit): ";
    cin >> num;
    if (num == 0) {
        break;
    }
    if (binary_search(cbegin(vec), cend(vec), num)) {
        cout << "That number is in the vector." << endl;
    } else {
        cout << "That number is not in the vector." << endl;
    }
}
```

Set Algorithms

The set algorithms work on any sorted range. The `includes()` algorithm implements standard subset determination, checking if all the elements of one sorted range are included in another sorted range, in any order.

The `set_union()`, `set_intersection()`, `set_difference()`, and `set_symmetric_difference()` algorithms implement the standard semantics of those operations. In set theory, the result of union is all the elements in either set. The result of intersection is all the elements which are in both sets. The result of difference is all the elements in the first set but not the second. The result of symmetric difference is the “exclusive or” of sets: all the elements in one, but not both, sets.

WARNING *Make sure that your result range is large enough to hold the result of the operations. For `set_union()` and `set_symmetric_difference()`, the result is at most the sum of the sizes of the two input ranges. For `set_intersection()`, the result is at most the minimum size of the two input ranges, and for `set_difference()` it's at most the size of the first range.*

WARNING *You can't use iterator ranges from associative containers, including sets, to store the results because they don't allow changes to their keys.*

Here are examples of how to use these algorithms:

```
vector<int> vec1, vec2, result;
cout << "Enter elements for set 1:" << endl;
populateContainer(vec1);
cout << "Enter elements for set 2:" << endl;
populateContainer(vec2);

// set algorithms work on sorted ranges
sort(begin(vec1), end(vec1));
sort(begin(vec2), end(vec2));

DumpRange("Set 1: ", cbegin(vec1), cend(vec1));
DumpRange("Set 2: ", cbegin(vec2), cend(vec2));

if (includes(cbegin(vec1), cend(vec1), cbegin(vec2), cend(vec2))) {
    cout << "The second set is a subset of the first." << endl;
}
if (includes(cbegin(vec2), cend(vec2), cbegin(vec1), cend(vec1))) {
    cout << "The first set is a subset of the second" << endl;
}

result.resize(size(vec1) + size(vec2));
auto newEnd = set_union(cbegin(vec1), cend(vec1), cbegin(vec2),
    cend(vec2), begin(result));
DumpRange("The union is: ", begin(result), newEnd);

newEnd = set_intersection(cbegin(vec1), cend(vec1), cbegin(vec2),
    cend(vec2), begin(result));
DumpRange("The intersection is: ", begin(result), newEnd);

newEnd = set_difference(cbegin(vec1), cend(vec1), cbegin(vec2),
    cend(vec2), begin(result));
DumpRange("The difference between set 1 and 2 is: ", begin(result), newEnd);

newEnd = set_symmetric_difference(cbegin(vec1), cend(vec1),
    cbegin(vec2), cend(vec2), begin(result));
DumpRange("The symmetric difference is: ", begin(result), newEnd);
```

`DumpRange()` is a small helper function template to write elements of a given range to the standard output stream; it is implemented as follows:

```
template<typename Iterator>
void DumpRange(string_view message, Iterator begin, Iterator end)
{
    cout << message;
    for_each(begin, end, [](const auto& element) { cout << element << " "; });
    cout << endl;
}
```

Here is a sample run of the program:

```
Enter elements for set 1:
Enter a number (0 to quit): 5
Enter a number (0 to quit): 6
Enter a number (0 to quit): 7
Enter a number (0 to quit): 8
Enter a number (0 to quit): 0
Enter elements for set 2:
Enter a number (0 to quit): 8
Enter a number (0 to quit): 9
Enter a number (0 to quit): 10
Enter a number (0 to quit): 0
Set 1: 5 6 7 8
Set 2: 8 9 10
The union is: 5 6 7 8 9 10
The intersection is: 8
The difference between set 1 and set 2 is: 5 6 7
The symmetric difference is: 5 6 7 9 10
```

The `merge()` algorithm allows you to merge two sorted ranges together, while maintaining the sorted order. The result is a sorted range containing all the elements of the two source ranges. It works in linear time. The following parameters are required:

- Start and end iterator of the first source range
- Start and end iterator of the second source range
- Start iterator of the destination range
- Optionally, a comparison callback

Without `merge()`, you could still achieve the same effect by concatenating the two ranges and applying `sort()` to the result, but that would be less efficient, $O(N \log N)$ instead of the linear complexity of `merge()`.

WARNING *Always ensure that you supply a big enough destination range to store the result of the merge!*

The following example demonstrates `merge()`:

```
vector<int> vectorOne, vectorTwo, vectorMerged;
cout << "Enter values for first vector:" << endl;
populateContainer(vectorOne);
cout << "Enter values for second vector:" << endl;
populateContainer(vectorTwo);

// Sort both containers
sort(begin(vectorOne), end(vectorOne));
sort(begin(vectorTwo), end(vectorTwo));

// Make sure the destination vector is large enough to hold the values
// from both source vectors.
vectorMerged.resize(size(vectorOne) + size(vectorTwo));

merge(cbegin(vectorOne), cend(vectorOne),
      cbegin(vectorTwo), cend(vectorTwo), begin(vectorMerged));

DumpRange("Merged vector: ", cbegin(vectorMerged), cend(vectorMerged));
```

Minimum/Maximum Algorithms

The `min()` and `max()` algorithms compare two or more elements of any type using `operator<` or a user-supplied binary predicate, returning a `const` reference to the smallest or largest element, respectively. The `minmax()` algorithm returns a pair containing the minimum and maximum value of two or more elements. These algorithms do not take iterator parameters. There is also `min_element()`, `max_element()`, and `minmax_element()` that work on iterator ranges.

The following program gives some examples:

```
int x = 4, y = 5;
cout << "x is " << x << " and y is " << y << endl;
cout << "Max is " << max(x, y) << endl;
cout << "Min is " << min(x, y) << endl;

// Using max() and min() on more than two values
int x1 = 2, x2 = 9, x3 = 3, x4 = 12;
cout << "Max of 4 elements is " << max({ x1, x2, x3, x4 }) << endl;
cout << "Min of 4 elements is " << min({ x1, x2, x3, x4 }) << endl;

// Using minmax()
auto p2 = minmax({ x1, x2, x3, x4 });
cout << "Minmax of 4 elements is <"
      << p2.first << ", " << p2.second << ">" << endl;

// Using minmax() + C++17 structured bindings
auto[min1, max1] = minmax({ x1, x2, x3, x4 });
cout << "Minmax of 4 elements is <"
      << min1 << ", " << max1 << ">" << endl;
```

```
// Using minmax_element() + C++17 structured bindings
vector<int> vec{ 11, 33, 22 };
auto[min2, max2] = minmax_element(cbegin(vec), cend(vec));
cout << "minmax_element() result: <"
    << *min2 << ", " << *max2 << ">" << endl;
```

Here is the program output:

```
x is 4 and y is 5
Max is 5
Min is 4
Max of 4 elements is 12
Min of 4 elements is 2
Minmax of 4 elements is <2,12>
Minmax of 4 elements is <2,12>
minmax_element() result: <11,33>
```

NOTE Sometimes you might encounter non-standard macros to find the minimum and maximum. For example, the GNU C Library (glibc) has macros `MIN()` and `MAX()`, while the `Windows.h` header file defines `min()` and `max()` macros. Because these are macros, they have the potential to evaluate one of their arguments twice, whereas `std::min()` and `std::max()` evaluate each argument exactly once. Make sure you always use the C++ versions, `std::min()` and `std::max()`.

It might also happen that those `min()` and `max()` macros interfere when you want to use `std::min()` and `std::max()`. In that case, you can prevent the use of the macros by using an extra set of parentheses, as follows:

```
auto maxValue = (std::max)(1, 2);
```

On Windows you can also prevent the Windows `min()` and `max()` macros by adding a `#define NOMINMAX` before you include `Windows.h`.

C++17

`std::clamp()` is a little helper function, defined in `<algorithm>`, that you can use to make sure that a value (v) is between a given minimum (*lo*) and maximum (*hi*). It returns a reference to *lo* if $v < lo$; returns a reference to *hi* if $v > hi$; otherwise returns a reference to v . Here is an example:

```
cout << clamp(-3, 1, 10) << endl;
cout << clamp(3, 1, 10) << endl;
cout << clamp(22, 1, 10) << endl;
```

The output is as follows:

```
1
3
10
```

C++17

Parallel Algorithms

C++17 adds support to more than 60 Standard Library algorithms for executing them in parallel to improve their performance. Examples include `for_each()`, `all_of()`, `copy()`, `count_if()`, `find()`, `replace()`, `search()`, `sort()`, `transform()`, and many more. Algorithms that support parallel execution have the option to accept a so-called *execution policy* as their first parameter.

The execution policy allows you to specify whether or not an algorithm is allowed to be executed in parallel or vectorized. There are three standard execution policy types, and three global instances of those types, all defined in the `<execution>` header file in the `std::execution` namespace.

EXECUTION POLICY TYPE	GLOBAL INSTANCE	DESCRIPTION
<code>sequenced_policy</code>	<code>seq</code>	The algorithm is not allowed to parallelize its execution.
<code>parallel_policy</code>	<code>par</code>	The algorithm is allowed to parallelize its execution.
<code>parallel_unsequenced_policy</code>	<code>par_unseq</code>	The algorithm is allowed to parallelize and vectorize its execution. It's also allowed to migrate its execution across threads.

A Standard Library implementation is free to add additional execution policies.

Note that for an algorithm executing with `parallel_unsequenced_policy`, function calls to callbacks are allowed to get interleaved, that is, they are unsequenced. This means that there are a lot of restrictions on what a function callback can do. For example, it cannot allocate/deallocate memory, acquire mutexes, use non-lock free `std::atomics` (see Chapter 23), and more. For the other standard policies, the function calls are sequenced, but in an indeterminate sequence. Such policies do not impose restrictions on what the function callbacks can do.

Parallel algorithms do not take any measures to prevent data races and deadlocks, so it is your responsibility to avoid them when executing an algorithm in parallel. Data race and deadlock prevention is discussed in detail in Chapter 23.

Here is an example of sorting the contents of a vector using a parallel policy:

```
sort(std::execution::par, begin(myVector), end(myVector));
```

Numerical Processing Algorithms

You've already seen an example of one numerical processing algorithm: `accumulate()`. The following sections give examples of some more numerical algorithms.

inner_product

`inner_product()`, defined in `<numeric>`, calculates the inner product of two sequences. For example, the inner product in the following example is calculated as $(1*9) + (2*8) + (3*7) + (4*6)$:

```
vector<int> v1{ 1, 2, 3, 4 };
vector<int> v2{ 9, 8, 7, 6 };
cout << inner_product(cbegin(v1), cend(v1), cbegin(v2), 0) << endl;
```

The output is 70.

iota

The `iota()` algorithm, defined in the `<numeric>` header file, generates a sequence of values in a specified range starting with a specified value and applying `operator++` to generate each successive value. The following example shows how to use this algorithm on a `vector` of integers, but note that it works on any element type that implements `operator++`:

```
vector<int> vec(10);
iota(begin(vec), end(vec), 5);
for (auto& i : vec) { cout << i << " "; }
```

The output is as follows:

```
5 6 7 8 9 10 11 12 13 14
```

C++17

gcd and lcm

The `gcd()` algorithm returns the *greatest common divisor*, while `lcm()` returns the *least common multiple* of two integer types. Both are defined in `<numeric>`. Here is an example:

```
auto g = gcd(3, 18); // g = 3
auto l = lcm(3, 18); // l = 18
```

C++17

reduce

`std::accumulate()` is one of the few algorithms that does not support parallel execution. Instead, you need to use the newly introduced `std::reduce()` algorithm to calculate a generalized sum with the option to execute it in parallel. For example, the following two lines calculate the same sum, except that `reduce()` runs a parallel and vectorized version and thus is much faster, especially on big input ranges:

```
double result1 = std::accumulate(cbegin(vec), cend(vec), 0.0);
double result2 = std::reduce(std::execution::par_unseq, cbegin(vec), cend(vec));
```

In general, both `accumulate()` and `reduce()` calculate the following sum for a range of elements $[x_0, x_n)$, with a given initial value *Init*, and a given binary operator Θ :

$$\text{Init } \Theta x_0 \Theta x_1 \Theta \dots \Theta x_{n-1}$$

C++17

transform_reduce

`std::inner_product()` is another algorithm that does not support parallel execution. Instead, you need to use the generalized `transform_reduce()`, which has the option to execute in parallel, and which you can use to calculate the inner product, among others. Its use is similar to `reduce()`, so no example is given.

`transform_reduce()` calculates the following sum for a range of elements $[x_0, x_n)$, with a given initial value *Init*, a given unary function *f*, and a given binary operator Θ :

$$\text{Init } \Theta f(x_0) \Theta f(x_1) \Theta \dots \Theta f(x_{n-1})$$

C++17

Scan Algorithms

C++17 introduces four scan algorithms: `exclusive_scan()`, `inclusive_scan()`, `transform_exclusive_scan()`, and `transform_inclusive_scan()`.

The following table shows which sums $[y_0, y_n)$ are calculated by `exclusive_scan()` and by `inclusive_scan()/partial_sum()` for a range of elements $[x_0, x_n)$, with a given initial value *Init* (0 for `partial_sum()`), and a given operator Θ .

<code>exclusive_scan()</code>	<code>inclusive_scan()/partial_sum()</code>
$y_0 = \text{Init}$	$y_0 = \text{Init } \Theta x_0$
$y_1 = \text{Init } \Theta x_0$	$y_1 = \text{Init } \Theta x_0 \Theta x_1$
$y_2 = \text{Init } \Theta x_0 \Theta x_1$...
...	$y_{n-1} = \text{Init } \Theta x_0 \Theta x_1 \Theta \dots \Theta x_{n-1}$
$y_{n-1} = \text{Init } \Theta x_0 \Theta x_1 \Theta \dots \Theta x_{n-2}$	

`transform_exclusive_scan()` and `transform_inclusive_scan()` both first apply a unary function to the elements before calculating the generalized sum, similar to how `transform_reduce()` applies a unary function to the elements before reducing.

Note that all these scan algorithms can accept an optional execution policy to execute them in parallel. The order of evaluation for these scan algorithms is non-deterministic, while it is from left to right for `partial_sum()` and `accumulate()`. That's also the reason why `partial_sum()` and `accumulate()` cannot be parallelized!

ALGORITHMS EXAMPLE: AUDITING VOTER REGISTRATIONS

Voter fraud can be a problem everywhere. People sometimes attempt to register and vote in two or more different voting districts. Additionally, some people, for example, convicted felons, are ineligible to vote, but occasionally attempt to register and vote anyway. Using your newfound algorithm skills, you could write a simple voter registration auditing function that checks the voter rolls for certain anomalies.

The Voter Registration Audit Problem Statement

The voter registration audit function should audit the voters' information. Assume that voter registrations are stored by district in a `map` that maps district names to a `vector` of voters. Your audit function should take this `map` and a `vector` of convicted felons as parameters, and should remove all convicted felons from the `vectors` of voters. Additionally, the function should find all voters who are registered in more than one district and should remove those names from all districts. Voters with duplicate registrations must have all their registrations removed, and therefore become ineligible to vote. For simplicity, assume that the `vector` of voters is simply a `vector` of `string` names. A real application would obviously require more data, such as address and party affiliation.

The `auditVoterRolls` Function

The `auditVoterRolls()` function works in three steps:

1. Find all the duplicate names in all the registration `vectors` by making a call to `getDuplicates()`.
2. Combine the `set` of duplicates and the `vector` of convicted felons.
3. Remove from every voter `vector` all the names found in the combined `set` of duplicates and convicted felons. The approach taken here is to use `for_each()` to process each `vector` in the `map`, applying a lambda expression to remove the offending names from each `vector`.

The following type aliases are used in the code:

```
using VotersMap = map<string, vector<string>>;
using DistrictPair = pair<const string, vector<string>>;
```

Here's the implementation of `auditVoterRolls()`:

```
// Expects a map of string/vector<string> pairs keyed on district names
// and containing vectors of all the registered voters in those districts.
// Removes from each vector any name on the convictedFelons vector and
// any name that is found on any other vector.
void auditVoterRolls(VotersMap& votersByDistrict,
                    const vector<string>& convictedFelons)
{
    // Get all the duplicate names.
    set<string> toRemove = getDuplicates(votersByDistrict);

    // Combine the duplicates and convicted felons -- we want
    // to remove names on both vectors from all voter rolls.
    toRemove.insert(cbegin(convictedFelons), cend(convictedFelons));

    // Now remove all the names we need to remove using
    // nested lambda expressions and the remove-erase-idiom.
    for_each(begin(votersByDistrict), end(votersByDistrict),
            [&toRemove](DistrictPair& district) {
                auto it = remove_if(begin(district.second),
                                    end(district.second), [&toRemove](const string& name) {
```

```

        return (toRemove.count(name) > 0);
    }
    );
    district.second.erase(it, end(district.second));
}
);
}

```

This implementation uses the `for_each()` algorithm to demonstrate its use. Of course, instead of `for_each()`, you could use a range-based `for` loop as follows (also uses C++17 structured bindings):

```

for (auto&[district, voters] : votersByDistrict) {
    auto it = remove_if(begin(voters), end(voters),
        [&toRemove](const string& name) {
            return (toRemove.count(name) > 0);
        });
    voters.erase(it, end(voters));
}

```

The getDuplicates Function

The `getDuplicates()` function must find any name that is on more than one voter registration list. There are several different approaches one could use to solve this problem. To demonstrate the `adjacent_find()` algorithm, this implementation combines the vectors from each district into one big vector and sorts it. At that point, any duplicate names between the different vectors will be next to each other in the big vector. Then the `adjacent_find()` algorithm can be used on the big, sorted vector to find all consecutive duplicates and store them in a set called `duplicates`. Here is the implementation:

```

// Returns a set of all names that appear in more than one vector in
// the map.
set<string> getDuplicates(const VotersMap& votersByDistrict)
{
    // Collect all the names from all the vectors into one big vector.
    vector<string> allNames;
    for (auto& district : votersByDistrict) {
        allNames.insert(end(allNames), begin(district.second),
            end(district.second));
    }

    // Sort the vector.
    sort(begin(allNames), end(allNames));

    // Now it's sorted, all duplicate names will be next to each other.
    // Use adjacent_find() to find instances of two or more identical names
    // next to each other.
    // Loop until adjacent_find() returns the end iterator.
    set<string> duplicates;
    for (auto lit = cbegin(allNames); lit != cend(allNames); ++lit) {
        lit = adjacent_find(lit, cend(allNames));
    }
}

```

```

        if (lit == cend(allNames)) {
            break;
        }
        duplicates.insert(*lit);
    }
    return duplicates;
}

```

In this implementation, `allNames` is of type `vector<string>`. That way, this example can show you how to use the `sort()` and `adjacent_find()` algorithms.

Another solution is to change the type of `allNames` to `set<string>`, which results in a more compact implementation, because a set doesn't allow duplicates. This new solution loops over all vectors and tries to insert each name into `allNames`. When this insert fails, it means that there is already an element with that name in `allNames`, so the name is added to `duplicates`. Note that this code uses C++17 structured bindings.

```

set<string> getDuplicates(const VotersMap& votersByDistrict)
{
    set<string> allNames;
    set<string> duplicates;
    for (auto&[district, voters] : votersByDistrict) {
        for (auto& name : voters) {
            if (!allNames.insert(name).second) {
                duplicates.insert(name);
            }
        }
    }
    return duplicates;
}

```

Testing the auditVoterRolls Function

That's the complete implementation of the voter roll audit functionality. Here is a small test program:

```

// Initialize map using uniform initialization
VotersMap voters = {
    {"Orange", {"Amy Aardvark", "Bob Buffalo",
               "Charles Cat", "Dwayne Dog"}},
    {"Los Angeles", {"Elizabeth Elephant", "Fred Flamingo",
                    "Amy Aardvark"}},
    {"San Diego", {"George Goose", "Heidi Hen", "Fred Flamingo"}}
};
vector<string> felons = {"Bob Buffalo", "Charles Cat"};

// Local lambda expression to print a district
auto printDistrict = [] (const DistrictPair& district) {
    cout << district.first << ":";
    for (auto& str : district.second) {
        cout << " {" << str << " }";
    }
    cout << endl;
};

```

```
cout << "Before Audit:" << endl;
for (const auto& district : voters) { printDistrict(district); }
cout << endl;

auditVoterRolls(voters, felons);

cout << "After Audit:" << endl;
for (const auto& district : voters) { printDistrict(district); }
cout << endl;
```

The output of the program is as follows:

```
Before Audit:
Los Angeles: {Elizabeth Elephant} {Fred Flamingo} {Amy Aardvark}
Orange: {Amy Aardvark} {Bob Buffalo} {Charles Cat} {Dwayne Dog}
San Diego: {George Goose} {Heidi Hen} {Fred Flamingo}

After Audit:
Los Angeles: {Elizabeth Elephant}
Orange: {Dwayne Dog}
San Diego: {George Goose} {Heidi Hen}
```

SUMMARY

This chapter concludes the basic Standard Library functionality. It provided an overview of the various algorithms and function objects that are available for your use. It also showed you how to use lambda expressions, which often make it easier to understand what your code is doing. I hope that you have gained an appreciation for the usefulness of the Standard Library containers, algorithms, and function objects. If not, think for a moment about rewriting the voter registration audit example without the Standard Library. You would need to write your own vector- and map-like classes, and your own searching, removing, iterating, and other algorithms. The program would be much longer, more error-prone, harder to debug, and more difficult to maintain.

The following chapters discuss a couple of other aspects of the C++ Standard Library. Chapter 19 discusses regular expressions. Chapter 20 covers a number of additional library utilities that are available for you to use, and Chapter 21 gives a taste of some more advanced features, such as allocators, iterator adaptors, and writing your own algorithms.

19

String Localization and Regular Expressions

WHAT'S IN THIS CHAPTER?

- ▶ How to localize your applications to reach a worldwide audience
- ▶ How to use regular expressions to do powerful pattern matching

WROX.COM DOWNLOADS FOR THIS CHAPTER

Please note that all the code examples for this chapter are available as a part of this chapter's code download on the book's website at www.wrox.com/go/proc++4e on the Download Code tab.

This chapter starts with a discussion of localization, which allows you to write software that can be localized to different regions around the world.

The second part of this chapter introduces the *regular expressions library*, which makes it easy to perform pattern matching on strings. It allows you to search for substrings matching a given pattern, but also to validate, parse, and transform strings. Regular expressions are really powerful, and it's recommended that you start using them instead of manually writing your own string processing code.

LOCALIZATION

When you're learning how to program in C or C++, it's useful to think of a character as equivalent to a byte and to treat all characters as members of the ASCII (American Standard Code for Information Interchange) character set. ASCII is a 7-bit set usually stored in an 8-bit

char type. In reality, experienced C++ programmers recognize that successful programs are used throughout the world. Even if you don't initially write your program with international audiences in mind, you shouldn't prevent yourself from *localizing*, or making the software *locale aware*, at a later date.

NOTE *This chapter gives you an introduction to localization, different character encodings, and string code portability. It is outside the scope of this book to discuss all these topics in detail, because they each warrant an entire book on their own.*

Localizing String Literals

A critical aspect of localization is that you should never put any native-language string literals in your source code, except maybe for debug strings targeted at the developer. In Microsoft Windows applications, this is accomplished by putting the strings in `STRINGTABLE` resources. Most other platforms offer similar capabilities. If you need to translate your application to another language, translating those resources should be all you need to do, without requiring any source changes. There are tools available that will help you with this translation process.

To make your source code localizable, you should not compose sentences out of string literals, even if the individual literals can be localized. Here is an example:

```
cout << "Read " << n << " bytes" << endl;
```

This statement cannot be localized to Dutch because it requires a reordering of the words. The Dutch translation is as follows:

```
cout << n << " bytes gelezen" << endl;
```

To make sure you can properly localize this string, you could implement something like this:

```
cout << Format(IDS_TRANSFERRED, n) << endl;
```

`IDS_TRANSFERRED` is the name of an entry in a string resource table. For the English version, `IDS_TRANSFERRED` could be defined as "Read %1 bytes", while the Dutch version of the resource could be defined as "%1 bytes gelezen". The `Format()` function loads the string resource, and substitutes %1 with the value of `n`.

Wide Characters

The problem with viewing a character as a byte is that not all languages, or *character sets*, can be fully represented in 8 bits, or 1 byte. C++ has a built-in type called `wchar_t` that holds a *wide character*. Languages with non-ASCII (U.S.) characters, such as Japanese and Arabic, can be represented in C++ with `wchar_t`. However, the C++ standard does not define a size for `wchar_t`. Some compilers use 16 bits while others use 32 bits. To write cross-platform code, it is not safe to assume that `wchar_t` is of a particular size.

If there is *any* chance that your program will be used in a non-Western character set context (hint: there is!), you should use wide characters from the beginning. When working with `wchar_t`, string and character literals are prefixed with the letter `L` to indicate that a wide-character encoding should be used. For example, to initialize a `wchar_t` character to the letter `m`, you write it like this:

```
wchar_t myWideCharacter = L'm';
```

There are wide-character versions of most of your favorite types and classes. The wide `string` class is `wstring`. The “prefix letter `w`” pattern applies to streams as well. Wide-character file output streams are handled with `wofstream`, and input is handled with `wifstream`. The joy of pronouncing these class names (*woof-stream?* *whiff-stream?*) is reason enough to make your programs locale aware! Streams are discussed in detail in Chapter 13.

There are also wide-versions of `cout`, `cin`, `cerr`, and `clog` available, called `wcout`, `wcin`, `wcerr`, and `wclog`. Using them is no different than using the non-wide versions:

```
wcout << L"I am a wide-character string literal." << endl;
```

Non-Western Character Sets

Wide characters are a great step forward because they increase the amount of space available to define a single character. The next step is to figure out how that space is used. In wide character sets, just like in ASCII, characters are represented by numbers, now called *code points*. The only difference is that each number does not fit in 8 bits. The map of characters to code points is quite a bit larger because it handles many different character sets in addition to the characters that English-speaking programmers are familiar with.

The Universal Character Set (UCS)—defined by the International Standard ISO 10646—and Unicode are both standardized sets of characters. They contain around one hundred thousand abstract characters, each identified by an unambiguous name and a code point. The same characters with the same numbers exist in both standards. Both have specific *encodings* that you can use. For example, UTF-8 is an example of a Unicode encoding where Unicode characters are encoded using one to four 8-bit bytes. UTF-16 encodes Unicode characters as one or two 16-bit values, and UTF-32 encodes Unicode characters as exactly 32 bits.

Different applications can use different encodings. Unfortunately, the C++ standard does not specify a size for wide characters (`wchar_t`). On Windows it is 16 bits, while on other platforms it could be 32 bits. You need to be aware of this when using wide characters for character encoding in cross-platform code. To help solve this issue, there are two other character types: `char16_t` and `char32_t`. The following list gives an overview of all available character types.

- **char**: Stores 8 bits. This type can be used to store ASCII characters, or as a basic building block for storing UTF-8 encoded Unicode characters, where one Unicode character is encoded as one to four chars.
- **char16_t**: Stores at least 16 bits. This type can be used as the basic building block for UTF-16 encoded Unicode characters, where one Unicode character is encoded as one or two `char16_t`s.

- **char32_t**: Stores at least 32 bits. This type can be used for storing UTF-32 encoded Unicode characters as one `char32_t`.
- **wchar_t**: Stores a wide character of a compiler-specific size and encoding.

The benefit of using `char16_t` and `char32_t` instead of `wchar_t` is that the size of `char16_t` is guaranteed to be at least 16 bits, and the size of `char32_t` is guaranteed to be at least 32 bits, independent of the compiler. There is no minimum size guaranteed for `wchar_t`.

The standard also defines the following macros.

- **__STDC_UTF_32__**: If defined by the compiler, then the type `char32_t` uses UTF-32 encoding. If it is not defined, `char32_t` has a compiler-dependent encoding.
- **__STDC_UTF_16__**: If defined by the compiler, then the type `char16_t` uses UTF-16 encoding. If it is not defined, `char16_t` has a compiler-dependent encoding.

String literals can have a string prefix to turn them into a specific type. The complete set of supported string prefixes is as follows.

- **u8**: A `char` string literal with UTF-8 encoding.
- **u**: A `char16_t` string literal, which can be UTF-16 if `__STDC_UTF_16__` is defined by the compiler.
- **U**: A `char32_t` string literal, which can be UTF-32 if `__STDC_UTF_32__` is defined by the compiler.
- **L**: A `wchar_t` string literal with a compiler-dependent encoding.

All of these string literals can be combined with the raw string literal prefix, `R`, discussed in Chapter 2. Here are some examples:

```
const char* s1 = u8R"(Raw UTF-8 encoded string literal)";
const wchar_t* s2 = LR"(Raw wide string literal)";
const char16_t* s3 = uR"(Raw char16_t string literal)";
const char32_t* s4 = UR"(Raw char32_t string literal)";
```

If you are using Unicode encoding, for example, by using `u8` UTF-8 string literals, or if your compiler defines `__STDC_UTF_16__` or `__STDC_UTF_32__`, you can insert a specific Unicode code point in your non-raw string literal by using the `\uABCD` notation. For example, `\u03C0` represents the `pi` character, and `\u00B2` represents the ‘squared’ character. The following formula string represents “`π r2`”:

```
const char* formula = u8"\u03C0 r\u00B2";
```

Similarly, character literals can also have a prefix to turn them into specific types. The prefixes `u`, `U`, and `L` are supported, and C++17 adds the `u8` prefix for character literals. Here are some examples: `u'a'`, `U'a'`, `L'a'`, and `u8'a'`.

Besides the `std::string` class, there is also support for `wstring`, `u16string`, and `u32string`. They are all defined as follows:

- `using string = basic_string<char>;`
- `using wstring = basic_string<wchar_t>;`
- `using u16string = basic_string<char16_t>;`
- `using u32string = basic_string<char32_t>;`

Multibyte characters are characters composed of one or more bytes with a compiler-dependent encoding, similar to how Unicode can be represented with one to four bytes using UTF-8, or with one or two 16-bit values using UTF-16. There are conversion functions to convert between `char16_t/char32_t` and multibyte characters, and vice versa: `mbrtoc16`, `c16rtomb`, `mbrtoc32`, and `c32rtomb`.

Unfortunately, the support for `char16_t` and `char32_t` doesn't go much further. There are some conversion classes available (see the next section), but, for example, there is nothing like a version of `cout` or `cin` that supports `char16_t` and `char32_t`; this makes it difficult to print such strings to a console or to read them from user input. If you want to do more with `char16_t` and `char32_t` strings, you need to resort to third-party libraries. ICU—International Components for Unicode—is one well-known library that provides Unicode and globalization support for your applications.

Conversions

The C++ standard provides the `codecvt` class template to help with converting between different encodings. The `<locale>` header defines the following four encoding conversion classes.

CLASS	DESCRIPTION
<code>codecvt<char, char, mbstate_t></code>	Identity conversion, that is, no conversion
<code>codecvt<char16_t, char, mbstate_t></code>	Conversion between UTF-16 and UTF-8
<code>codecvt<char32_t, char, mbstate_t></code>	Conversion between UTF-32 and UTF-8
<code>codecvt<wchar_t, char, mbstate_t></code>	Conversion between wide (implementation-specific) and narrow character encodings

C++17

Before C++17, the following three code conversion facets were defined in `<codecvt>`: `codecvt_utf8`, `codecvt_utf16`, and `codecvt_utf8_utf16`. These could be used with two convenience conversion interfaces: `wstring_convert` and `wbuffer_convert`. However, C++17 has deprecated those three conversion facets (the entire `<codecvt>` header) and the two convenience interfaces, so they are not further discussed in this book. The C++ Standards Committee decided to deprecate this functionality because it does not handle errors well. Ill-formed Unicode strings are a security risk, and in fact can be, and have been, used as an attack vector to compromise the security of systems.

Also, the API is too obscure, and too hard to understand. I recommend using third-party libraries, such as ICU, to work correctly with Unicode strings until the Standards Committee comes up with a suitable, safe, and easier-to-use replacement for the deprecated functionality.

Locales and Facets

Character sets are only one of the differences in data representation between countries. Even countries that use similar character sets, such as Great Britain and the United States, still differ in how they represent certain data, such as dates and money.

The standard C++ mechanism that groups specific data about a particular set of cultural parameters is called a *locale*. An individual component of a locale, such as date format, time format, number format, and so on, is called a *facet*. An example of a locale is U.S. English. An example of a facet is the format used to display a date. There are several built-in facets that are common to all locales. C++ also provides a way to customize or add facets.

There are third-party libraries available that make it easier to work with locales. One example is `boost.locale`, which is able to use ICU as its backend, supporting collations and conversions, converting strings to uppercase (instead of converting character by character to uppercase), and so on.

Using Locales

When using I/O streams, data is formatted according to a particular locale. Locales are objects that can be attached to a stream, and they are defined in the `<locale>` header file. Locale names are implementation specific. The POSIX standard is to separate a language and an area into two-letter sections with an optional encoding. For example, the locale for the English language as spoken in the U.S. is `en_US`, while the locale for the English language as spoken in Great Britain is `en_GB`. The locale for Japanese spoken in Japan with Japanese Industrial Standard encoding is `ja_JP.jis`.

Locale names on Windows can have two formats. The preferred format is very similar to the POSIX format, but uses a dash instead of an underscore. The second, old format, looks like this:

```
lang[_country_region[.code_page]]
```

Everything between the square brackets is optional. The following table lists some examples.

	POSIX	WINDOWS	WINDOWS OLD
U.S. English	<code>en_US</code>	<code>en-US</code>	<code>English_United States</code>
Great Britain English	<code>en_GB</code>	<code>en-GB</code>	<code>English_Great Britain</code>

Most operating systems have a mechanism to determine the locale as defined by the user. In C++, you can pass an empty string to the `std::locale` object constructor to create a `locale` from the user's environment. Once this object is created, you can use it to query the `locale`, possibly making programmatic decisions based on it. The following code demonstrates how to use the user's locale for a stream by calling the `imbue()` method on the stream. The result is that everything that is sent to `wcout` is formatted according to the formatting rules for your environment:

```
wcout.imbue(locale(""));
wcout << 32767 << endl;
```

This means that if your system locale is English United States and you output the number 32767, the number is displayed as 32,767; however, if your system locale is Dutch Belgium, the same number is displayed as 32.767.

The default locale is the *classic/neutral* locale, and not the user's locale. The classic locale uses ANSI C conventions, and has the name C. The classic C locale is similar to U.S. English, but there are slight differences. For example, numbers are handled without any punctuation:

```
wcout.imbue(locale("C"));
wcout << 32767 << endl;
```

The output of this code is as follows:

```
32767
```

The following code manually sets the U.S. English locale, so the number 32767 is formatted with U.S. English punctuation, independent of your system locale:

```
wcout.imbue(locale("en-US")); // "en_US" for POSIX
wcout << 32767 << endl;
```

The output of this code is as follows:

```
32,767
```

A `locale` object allows you to query information about the locale. For example, the following program creates a `locale` matching the user's environment. The `name()` method is used to get a C++ string that describes the locale. Then, the `find()` method is used on the `string` object to find a given substring, which returns `string::npos` when the given substring is not found. The code checks for the Windows name and the POSIX name. One of two messages is output, depending on whether or not the locale appears to be U.S. English:

```
locale loc("");
if (loc.name().find("en_US") == string::npos &&
    loc.name().find("en-US") == string::npos) {
    wcout << L"Welcome non-U.S. English speaker!" << endl;
} else {
    wcout << L"Welcome U.S. English speaker!" << endl;
}
```

NOTE When you have to write data to a file that is supposed to be read back by a program, it's recommended to write it using the neutral "C" locale; otherwise, parsing will be difficult. On the other hand, when displaying data in a user interface, it's recommended to format the data according to the user locale, "".

Character Classification

The `<locale>` header contains the following character classification functions: `std::isspace()`, `isblank()`, `isctrl()`, `isupper()`, `islower()`, `isalpha()`, `isdigit()`, `ispunct()`, `isxdigit()`, `isalnum()`, `isprint()`, `isgraph()`. They all accept two parameters: the character to classify, and

the locale to use for the classification. Here is an example of `isupper()` using the user's environment locale:

```
bool result = isupper('A', locale(""));
```

Character Conversion

The `<locale>` header also defines two character conversion functions: `std::toupper()` and `tolower()`. They accept two parameters: the character to convert, and the locale to use for the conversion.

Using Facets

You can use the `std::use_facet()` function to obtain a particular facet in a particular locale. The argument to `use_facet()` is a `locale`. For example, the following expression retrieves the standard monetary punctuation facet of the British English locale using the POSIX locale name:

```
use_facet<money_punct<wchar_t>>(locale("en_GB"));
```

Note that the innermost template type determines the character type to use. This is usually `wchar_t` or `char`. The use of nested template classes is unfortunate, but once you get past the syntax, the result is an object that contains all the information you want to know about British money punctuation. The data available in the standard facets is defined in the `<locale>` header and its associated files. The following table lists the facet categories defined by the standard. Consult a Standard Library reference for details about the individual facets.

FACET	DESCRIPTION
<code>ctype</code>	Character classification facets.
<code>codecvt</code>	Conversion facets, see earlier in this chapter.
<code>collate</code>	Comparing strings lexicographically.
<code>time_get</code>	Parsing dates and times.
<code>time_put</code>	Formatting dates and times.
<code>num_get</code>	Parsing numeric values.
<code>num_put</code>	Formatting numeric values.
<code>num_punct</code>	Defines the formatting parameters for numeric values.
<code>money_get</code>	Parsing monetary values.
<code>money_put</code>	Formatting monetary values.
<code>money_punct</code>	Defines formatting parameters for monetary values.

The following program brings together locales and facets by printing out the currency symbol in both U.S. English and British English. Note that, depending on your environment, the British currency symbol may appear as a question mark, a box, or not at all. If your environment is set up to handle it, you may actually get the British pound symbol:

```

locale locUSEng("en-US");      // For Windows
//locale locUSEng("en_US");    // For Linux
locale locBritEng("en-GB");    // For Windows
//locale locBritEng("en_GB");  // For Linux

wstring dollars = use_facet<money_punct<wchar_t>>(locUSEng).curr_symbol();
wstring pounds = use_facet<money_punct<wchar_t>>(locBritEng).curr_symbol();

wcout << L"In the US, the currency symbol is " << dollars << endl;
wcout << L"In Great Britain, the currency symbol is " << pounds << endl;

```

REGULAR EXPRESSIONS

Regular expressions, defined in the `<regex>` header, are a powerful feature of the Standard Library. They are a special mini-language for string processing. They might seem complicated at first, but once you get to know them, they make working with strings easier. Regular expressions can be used for several string-related operations.

- **Validation:** Check if an input string is well formed.
For example: Is the input string a well-formed phone number?
- **Decision:** Check what kind of string an input represents.
For example: Is the input string the name of a JPEG or a PNG file?
- **Parsing:** Extract information from an input string.
For example: From a full filename, extract the filename part without the full path and without its extension.
- **Transformation:** Search substrings and replace them with a new formatted substring.
For example: Search all occurrences of “C++17” and replace them with “C++”.
- **Iteration:** Search all occurrences of a substring.
For example: Extract all phone numbers from an input string.
- **Tokenization:** Split a string into substrings based on a set of delimiters.
For example: Split a string on whitespace, commas, periods, and so on to extract the individual words.

Of course, you could write your own code to perform any of the preceding operations on your strings, but using the regular expressions functionality is highly recommended, because writing correct and safe code to process strings can be tricky.

Before I can go into more detail on regular expressions, there is some important terminology you need to know. The following terms are used throughout the discussion.

- **Pattern:** The actual regular expression is a pattern represented by a string.
- **Match:** Determines whether there is a match between a given regular expression and all of the characters in a given sequence [first, last).
- **Search:** Determines whether there is some substring within a given sequence [first, last) that matches a given regular expression.
- **Replace:** Identifies substrings in a given sequence, and replaces them with a corresponding new substring computed from another pattern, called a *substitution pattern*.

If you look around on the Internet, you will find several different grammars for regular expressions. For this reason, C++ includes support for several of these grammars:

- **ECMAScript:** The grammar based on the ECMAScript standard. ECMAScript is a scripting language standardized by ECMA-262. The core of JavaScript, ActionScript, Jscript, and so on, all use the ECMAScript language standard at their core.
- **basic:** The basic POSIX grammar.
- **extended:** The extended POSIX grammar.
- **awk:** The grammar used by the POSIX awk utility.
- **grep:** The grammar used by the POSIX grep utility.
- **egrep:** The grammar used by the POSIX grep utility with the -E parameter.

If you already know any of these regular expression grammars, you can use it straight away in C++ by telling the regular expression library to use that specific syntax (`syntax_option_type`). The default grammar in C++ is ECMAScript, whose syntax is explained in detail in the following section. It is also the most powerful grammar, so it's recommended to use ECMAScript instead of one of the other more limited grammars. Explaining the other regular expression grammars falls outside the scope of this book.

NOTE *If this is the first time you're hearing about regular expressions, just use the default ECMAScript syntax.*

ECMAScript Syntax

A regular expression pattern is a sequence of characters representing what you want to match. Any character in the regular expression matches itself except for the following special characters:

```
^ $ \ . * + ? ( ) [ ] { } |
```

These special characters are explained throughout the following discussion. If you need to match one of these special characters, you need to escape it using the `\` character, as in this example:

```
\[ or \. or \* or \|
```

Anchors

The special characters `^` and `$` are called *anchors*. The `^` character matches the position immediately following a line termination character, and `$` matches the position of a line termination character. By default, `^` and `$` also match the beginning and ending of a string, respectively, but this behavior can be disabled.

For example, `^test$` matches only the string `test`, and not strings that contain `test` somewhere in the line, such as `1test`, `test2`, `test abc`, and so on.

Wildcards

The *wildcard* character `.` can be used to match any character except a newline character. For example, the regular expression `a.c` will match `abc`, and `a5c`, but will not match `ab5c`, `ac`, and so on.

Alternation

The `|` character can be used to specify the “or” relationship. For example, `a|b` matches `a` or `b`.

Grouping

Parentheses `()` are used to mark *subexpressions*, also called *capture groups*. Capture groups can be used for several purposes:

- Capture groups can be used to identify individual subsequences of the original string; each marked subexpression (capture group) is returned in the result. For example, take the following regular expression: `(.) (ab|cd) (.)`. It has three marked subexpressions. Running a `regex_search()` with this regular expression on `1cd4` results in a match with four entries. The first entry is the entire match, `1cd4`, followed by three entries for the three marked subexpressions. These three entries are `1`, `cd`, and `4`. The details on how to use the `regex_search()` algorithm are shown in a later section.
- Capture groups can be used during matching for a purpose called *back references* (explained later).
- Capture groups can be used to identify components during *replace operations* (explained later).

Repetition

Parts of a regular expression can be repeated by using one of four *repeats*:

- `*` matches the preceding part *zero or more* times. For example, `a*b` matches `b`, `ab`, `aab`, `aaaab`, and so on.
- `+` matches the preceding part *one or more* times. For example, `a+b` matches `ab`, `aab`, `aaaab`, and so on, but not `b`.
- `?` matches the preceding part *zero or one* time. For example, `a?b` matches `b` and `ab`, but nothing else.
- `{...}` represents a *bounded repeat*. `a{n}` matches `a` repeated *exactly* `n` times; `a{n,}` matches `a` repeated *n times or more*; and `a{n,m}` matches `a` repeated *between n and m* times inclusive. For example, `a{3,4}` matches `aaa` and `aaaa` but not `a`, `aa`, `aaaaa`, and so on.

The repeats described in the previous list are called *greedy* because they find the longest match while still matching the remainder of the regular expression. To make them *non-greedy*, a `?` can be added behind the repeat, as in `*?`, `+?`, `??`, and `{...}?`. A non-greedy repetition repeats its pattern as few times as possible while still matching the remainder of the regular expression.

For example, the following table shows a greedy and a non-greedy regular expression, and the resulting submatches when running them on the input sequence `aaabbb`.

REGULAR EXPRESSION	SUBMATCHES
Greedy: <code>(a+)(ab)*(b+)</code>	"aaa" "" "bbb"
Non-greedy: <code>(a+?)(ab)*(b+)</code>	"aa" "ab" "bb"

Precedence

Just as with mathematical formulas, it's important to know the precedence of regular expression elements. Precedence is as follows:

- **Elements** like `a` are the basic building blocks of a regular expression.
- **Quantifiers** like `+`, `*`, `?`, and `{...}` bind tightly to the element on the left; for example, `b+`.
- **Concatenation** like `ab+c` binds after quantifiers.
- **Alternation** like `|` binds last.

For example, take the regular expression `ab+c|d`. This matches `abc`, `abbc`, `abbbc`, and so on, and also `d`. Parentheses can be used to change these precedence rules. For example, `ab+(c|d)` matches `abc`, `abbc`, `abbbc`, ..., `abd`, `abbd`, `abbbd`, and so on. However, by using parentheses you also mark it as a subexpression or capture group. It is possible to change the precedence rules without creating new capture groups by using `(?:...)`. For example, `ab+(?:c|d)` matches the same as the preceding `ab+(c|d)` but does not create an additional capture group.

Character Set Matches

Instead of having to write `(a|b|c|...|z)`, which is clumsy and introduces a capture group, a special syntax for specifying sets of characters or ranges of characters is available. In addition, a “not” form of the match is also available. A *character set* is specified between square brackets, and allows you to write `[c1c2...cn]`, which matches any of the characters `c1`, `c2`, ..., or `cn`. For example, `[abc]` matches any character `a`, `b`, or `c`. If the first character is `^`, it means “any but”:

- `ab[cde]` matches `abc`, `abd`, and `abe`.
- `ab[^cde]` matches `abf`, `abp`, and so on but not `abc`, `abd`, and `abe`.

If you need to match the `^`, `[`, or `]` characters themselves, you need to escape them; for example, `[\[\^\]]` matches the characters `[`, `^`, or `]`.

If you want to specify all letters, you could use a character set like `[abcdefghijklmnopqrstuvwxyzABCDEFGHIJKLMNOPQRSTUVWXYZ]`; however, this is clumsy and doing this several times is awkward, especially if you make a typo and omit one of the letters accidentally. There are two solutions to this.

One solution is to use the *range specification* in square brackets; this allows you to write `[a-zA-Z]`, which recognizes all the letters in the range a to z and A to Z. If you need to match a hyphen, you need to escape it; for example, `[a-zA-Z\ -]+` matches any word including a hyphenated word.

Another solution is to use one of the *character classes*. These are used to denote specific types of characters and are represented as `[:name:]`. Which character classes are available depends on the locale, but the names listed in the following table are always recognized. The exact meaning of these character classes is also dependent on the locale. This table assumes the standard C locale.

CHARACTER CLASS NAME	DESCRIPTION
<code>digit</code>	Digits
<code>d</code>	Same as <code>digit</code>
<code>xdigit</code>	Digits (<code>digit</code>) and the following letters used in hexadecimal numbers: 'a', 'b', 'c', 'd', 'e', 'f', 'A', 'B', 'C', 'D', 'E', 'F'.
<code>alpha</code>	Alphabetic characters. For the C locale, these are all lowercase and uppercase letters.
<code>alnum</code>	A combination of the <code>alpha</code> class and the <code>digit</code> class
<code>w</code>	Same as <code>alnum</code>
<code>lower</code>	Lowercase letters, if applicable to the locale
<code>upper</code>	Uppercase letters, if applicable to the locale
<code>blank</code>	A blank character is a whitespace character used to separate words within a line of text. For the C locale, these are ' ' and '\t' (tab).
<code>space</code>	Whitespace characters. For the C locale, these are ' ', '\t', '\n', '\r', '\v', and '\f'.
<code>s</code>	Same as <code>space</code>
<code>print</code>	Printable characters. These occupy a printing position—for example, on a display—and are the opposite of control characters (<code>cntrl</code>). Examples are lowercase letters, uppercase letters, digits, punctuation characters, and space characters.
<code>cntrl</code>	Control characters. These are the opposite of printable characters (<code>print</code>), and don't occupy a printing position, for example, on a display. Some examples for the C locale are '\f' (form feed), '\n' (new line), and '\r' (carriage return).
<code>graph</code>	Characters with a graphical representation. These are all characters that are printable (<code>print</code>), except the space character ' '.
<code>punct</code>	Punctuation characters. For the C locale, these are all graphical characters (<code>graph</code>) that are not alphanumeric (<code>alnum</code>). Some examples are '!', '#', '@', '}', and so on.

Character classes are used within character sets; for example, `[[:alpha:]]*` in English means the same as `[a-zA-Z]*`.

Because certain concepts like matching digits are so common, there are shorthand patterns for them. For example, `[[:digit:]]` and `[[:d:]]` mean the same thing as `[0-9]`. Some classes have an even shorter pattern using the escape notation `\`. For example, `\d` means `[[:digit:]]`. Therefore, to recognize a sequence of one or more numbers, you can write any of the following patterns:

- `[0-9]+`
- `[[:digit:]]+`
- `[[:d:]]+`
- `\d+`

The following table lists the available escape notations for character classes.

ESCAPE NOTATION	EQUIVALENT TO
<code>\d</code>	<code>[[:d:]]</code>
<code>\D</code>	<code>[^[:d:]]</code>
<code>\s</code>	<code>[[:s:]]</code>
<code>\S</code>	<code>[^[:s:]]</code>
<code>\w</code>	<code>[_[:w:]]</code>
<code>\W</code>	<code>[^_[:w:]]</code>

Here are some examples:

- `Test[5-8]` matches `Test5`, `Test6`, `Test7`, and `Test8`.
- `[[:lower:]]` matches `a`, `b`, and so on, but not `A`, `B`, and so on.
- `[^[:lower:]]` matches any character except lowercase letters like `a`, `b`, and so on.
- `[[:lower:]]5-7` matches any lowercase letter like `a`, `b`, and so on, and the numbers `5`, `6`, and `7`.

Word Boundaries

A *word boundary* can mean the following:

- The beginning of the source string if the first character of the source string is one of the word characters, that is, a letter, digit, or an underscore. For the standard C locale this is equal to `[A-Za-z0-9_]`. Matching the beginning of the source string is enabled by default, but you can disable it (`regex_constants::match_not_bow`).
- The end of the source string if the last character of the source string is one of the word characters. Matching the end of the source string is enabled by default, but you can disable it (`regex_constants::match_not_eow`).

- The first character of a word, which is one of the word characters, while the preceding character is not a word character.
- The end of a word, which is a non-word character, while the preceding character is a word character.

You can use `\b` to match a word boundary, and `\B` to match anything except a word boundary.

Back References

Back references allow you to reference a captured group inside the regular expression itself: `\n` refers to the *n*-th captured group, with *n* > 0. For example, the regular expression `(\d+) - . * - \1` matches a string that has the following format:

- one or more digits captured in a capture group `(\d+)`
- followed by a dash `-`
- followed by zero or more characters `. *`
- followed by another dash `-`
- followed by exactly the same digits captured by the first capture group `\1`

This regular expression matches `123-abc-123`, `1234-a-1234`, and so on but does not match `123-abc-1234`, `123-abc-321`, and so on.

Lookahead

Regular expressions support *positive lookahead* (which uses `?=pattern`) and *negative lookahead* (which uses `?!pattern`). The characters following the lookahead must match (positive), or not match (negative) the lookahead pattern, but those characters are not yet consumed.

For example: the pattern `a(?!b)` contains a negative lookahead to match a letter `a` not followed by a `b`. The pattern `a(=b)` contains a positive lookahead to match a letter `a` followed by a `b`, but `b` is not consumed so it does not become part of the match.

The following is a more complicated example. The regular expression matches an input sequence that consists of at least one lowercase letter, at least one uppercase letter, at least one punctuation character, and is at least eight characters long. Such a regular expression can, for example, be used to enforce that passwords satisfy certain criteria.

```
(?=.*[[:lower:]]) (?=.*[[:upper:]]) (?=.*[[:punct:]]) .{8,}
```

Regular Expressions and Raw String Literals

As you saw in the preceding sections, regular expressions often use special characters that should be escaped in normal C++ string literals. For example, if you write `\d` in a regular expression, it matches any digit. However, because `\` is a special character in C++, you need to escape it in your regular expression string literal as `\\d`; otherwise, your C++ compiler tries to interpret the `\d`. It can get more complicated if you want your regular expression to match a single back-slash character `\`. Because `\` is a special character in the regular expression syntax itself, you need to escape it as `\\`.

The `\` character is also a special character in C++ string literals, so you need to escape it in your C++ string literal, resulting in `\\`.

You can use raw string literals to make a complicated regular expression easier to read in your C++ source code. (Raw string literals are discussed in Chapter 2.) For example, take the following regular expression:

```
"( |\n|\r|\\)"
```

This regular expression matches spaces, newlines, carriage returns, and back slashes. As you can see, you need a lot of escape characters. Using raw string literals, this can be replaced with the following more readable regular expression:

```
R"(( |\n|\r|\\))"
```

The raw string literal starts with `R" (` and ends with `) "`. Everything in between is the regular expression. Of course, you still need a double back slash at the end because the back slash needs to be escaped in the regular expression itself.

This concludes a brief description of the ECMAScript grammar. The following sections explain how to actually use regular expressions in your C++ code.

The regex Library

Everything for the regular expression library is in the `<regex>` header file and in the `std` namespace. The basic template types defined by the regular expression library are

- **basic_regex:** An object representing a specific regular expression.
- **match_results:** A substring that matched a regular expression, including all the captured groups. It is a collection of `sub_matches`.
- **sub_match:** An object containing a pair of iterators into the input sequence. These iterators represent the matched capture group. The pair is an iterator pointing to the first character of a matched capture group and an iterator pointing to one-past-the-last character of the matched capture group. It has an `str()` method that returns the matched capture group as a string.

The library provides three key algorithms: `regex_match()`, `regex_search()`, and `regex_replace()`. All of these algorithms have different versions that allow you to specify the source string as a `string`, a character array, or as a begin/end iterator pair. The iterators can be any of the following:

- `const char*`
- `const wchar_t*`
- `string::const_iterator`
- `wstring::const_iterator`

In fact, any iterator that behaves as a bidirectional iterator can be used. See Chapters 17 and 18 for details on iterators.

The library also defines the following two types for *regular expression iterators*, which are very important if you want to find all occurrences of a pattern in a source string.

- **regex_iterator**: iterates over all the occurrences of a pattern in a source string.
- **regex_token_iterator**: iterates over all the capture groups of all occurrences of a pattern in a source string.

To make the library easier to use, the standard defines a number of type aliases for the preceding templates:

```
using regex    = basic_regex<char>;
using wregex  = basic_regex<wchar_t>;

using csub_match = sub_match<const char*>;
using wsub_match = sub_match<const wchar_t*>;
using ssub_match = sub_match<string::const_iterator>;
using wssub_match = sub_match<wstring::const_iterator>;

using cmatch    = match_results<const char*>;
using wcmatch   = match_results<const wchar_t*>;
using smatch    = match_results<string::const_iterator>;
using wsmatch   = match_results<wstring::const_iterator>;

using cregex_iterator = regex_iterator<const char*>;
using wcregex_iterator = regex_iterator<const wchar_t*>;
using sregex_iterator = regex_iterator<string::const_iterator>;
using wsregex_iterator = regex_iterator<wstring::const_iterator>;

using cregex_token_iterator = regex_token_iterator<const char*>;
using wcregex_token_iterator = regex_token_iterator<const wchar_t*>;
using sregex_token_iterator = regex_token_iterator<string::const_iterator>;
using wsregex_token_iterator = regex_token_iterator<wstring::const_iterator>;
```

The following sections explain the `regex_match()`, `regex_search()`, and `regex_replace()` algorithms, and the `regex_iterator` and `regex_token_iterator` classes.

regex_match()

The `regex_match()` algorithm can be used to compare a given source string with a regular expression pattern. It returns `true` if the pattern matches the entire source string, and `false` otherwise. It is very easy to use. There are six versions of the `regex_match()` algorithm accepting different kinds of arguments. They all have the following form:

```
template<...>
bool regex_match(InputSequence[, MatchResults], RegEx[, Flags]);
```

The `InputSequence` can be represented as follows:

- A start and end iterator into a source string
- An `std::string`
- A C-style string

The optional `MatchResults` parameter is a reference to a `match_results` and receives the match. If `regex_match()` returns `false`, you are only allowed to call `match_results::empty()` or `match_results::size()`; anything else is undefined. If `regex_match()` returns `true`, a match is found and you can inspect the `match_results` object for what exactly got matched. This is explained with examples in the following subsections.

The `Regex` parameter is the regular expression that needs to be matched. The optional `Flags` parameter specifies options for the matching algorithm. In most cases you can keep the default. For more details, consult a Standard Library Reference, see Appendix B.

regex_match() Example

Suppose you want to write a program that asks the user to enter a date in the format year/month/day, where year is four digits, month is a number between 1 and 12, and day is a number between 1 and 31. You can use a regular expression together with the `regex_match()` algorithm to validate the user input as follows. The details of the regular expression are explained after the code.

```
regex r("\\d{4}/(?:0?[1-9]|1[0-2])/(?:0?[1-9]|[1-2][0-9]|3[0-1])");
while (true) {
    cout << "Enter a date (year/month/day) (q=quit): ";
    string str;
    if (!getline(cin, str) || str == "q")
        break;

    if (regex_match(str, r))
        cout << " Valid date." << endl;
    else
        cout << " Invalid date!" << endl;
}
```

The first line creates the regular expression. The expression consists of three parts separated by a forward slash (/) character: one part for year, one for month, and one for day. The following list explains these parts.

- `\d{4}`: This matches any combination of four digits; for example, 1234, 2010, and so on.
- `(?:0?[1-9]|1[0-2])`: This subpart of the regular expression is wrapped inside parentheses to make sure the precedence is correct. You don't need a capture group, so `(?:...)` is used. The inner expression consists of an alternation of two parts separated by the `|` character.
 - `0?[1-9]`: This matches any number from 1 to 9 with an optional 0 in front of it. For example, it matches 1, 2, 9, 03, 04, and so on. It does not match 0, 10, 11, and so on.
 - `1[0-2]`: This matches 10, 11, or 12, and nothing else.
- `(?:0?[1-9]|[1-2][0-9]|3[0-1])`: This subpart is also wrapped inside a non-capture group and consists of an alternation of three parts.
 - `0?[1-9]`: This matches any number from 1 to 9 with an optional 0 in front of it. For example, it matches 1, 2, 9, 03, 04, and so on. It does not match 0, 10, 11, and so on.

- `[1-2][0-9]`: This matches any number between 10 and 29 inclusive and nothing else.
- `3[0-1]`: This matches 30 or 31 and nothing else.

The example then enters an infinite loop to ask the user to enter a date. Each date entered is given to the `regex_match()` algorithm. When `regex_match()` returns `true`, the user has entered a date that matches the date regular expression pattern.

This example can be extended a bit by asking the `regex_match()` algorithm to return captured subexpressions in a results object. You first have to understand what a capture group does. By specifying a `match_results` object like `smatch` in a call to `regex_match()`, the elements of the `match_results` object are filled in when the regular expression matches the input string. To be able to extract these substrings, you must create capture groups using parentheses.

The first element, `[0]`, in a `match_results` object contains the string that matched the entire pattern. When using `regex_match()` and a match is found, this is the entire source sequence. When using `regex_search()`, discussed in the next section, this is a substring in the source sequence that matches the regular expression. Element `[1]` is the substring matched by the first capture group, `[2]` by the second capture group, and so on. To get a string representation of a capture group, you can write `m[i]` as in the following code, or write `m[i].str()`, where `i` is the index of the capture group and `m` is a `match_results` object.

The following code extracts the year, month, and day digits into three separate integer variables. The regular expression in the revised example has a few small changes. The first part matching the year is wrapped in a capture group, while the month and day parts are now also capture groups instead of non-capture groups. The call to `regex_match()` includes a `smatch` parameter, which receives the matched capture groups. Here is the adapted example:

```
regex r("(\\d{4})/(0?[1-9]|1[0-2])/(0?[1-9]| [1-2][0-9]|3[0-1])");
while (true) {
    cout << "Enter a date (year/month/day) (q=quit): ";
    string str;
    if (!getline(cin, str) || str == "q")
        break;

    smatch m;
    if (regex_match(str, m, r)) {
        int year = stoi(m[1]);
        int month = stoi(m[2]);
        int day = stoi(m[3]);
        cout << " Valid date: Year=" << year
             << ", month=" << month
             << ", day=" << day << endl;
    } else {
        cout << " Invalid date!" << endl;
    }
}
```

In this example, there are four elements in the `smatch` results objects:

- [0] : the string matching the full regular expression, which is the full date in this example
- [1] : the year
- [2] : the month
- [3] : the day

When you execute this example, you can get the following output:

```
Enter a date (year/month/day) (q=quit): 2011/12/01
Valid date: Year=2011, month=12, day=1
Enter a date (year/month/day) (q=quit): 11/12/01
Invalid date!
```

NOTE *These date-matching examples only check if the date consists of a year (four digits), a month (1–12), and a day (1–31). They do not perform any validation for the number of days in a month, or for leap years, and so on. If you need to do that, you have to write code to validate the year, month, and day values that are extracted by `regex_match()`. If you validate the year, month, and day in code, then the regular expression can be simplified to just match 4 digits for the year, 1 or 2 digits for the month, and 1 or 2 digits for the day:*

```
regex r("(\\d{4})/(\\d{1,2})/(\\d{1,2})");
```

regex_search()

The `regex_match()` algorithm discussed in the previous section returns `true` if the entire source string matches the regular expression, and `false` otherwise. It cannot be used to find a matching substring. Instead, you need to use the `regex_search()` algorithm, which allows you to search for a substring that matches a certain pattern. There are six versions of the `regex_search()` algorithm, and they all have the following form:

```
template<...>
bool regex_search(InputSequence[, MatchResults], RegEx[, Flags]);
```

All variations return `true` when a match is found somewhere in the input sequence, and `false` otherwise. The parameters are similar to the parameters for `regex_match()`.

Two versions of the `regex_search()` algorithm accept a begin and end iterator as the input sequence that you want to process. You might be tempted to use this version of `regex_search()` in a loop to find all occurrences of a pattern in a source string by manipulating these begin and end iterators for each `regex_search()` call. Never do this! It can cause problems when your regular expression uses anchors (`^` or `$`), word boundaries, and so on. It can also cause an infinite loop due to empty matches. Use the `regex_iterator` or `regex_token_iterator` as explained later in this chapter to extract all occurrences of a pattern from a source string.

WARNING *Never use `regex_search()` in a loop to find all occurrences of a pattern in a source string. Instead, use a `regex_iterator` or `regex_token_iterator`.*

regex_search() Example

The `regex_search()` algorithm can be used to extract matching substrings from an input sequence. The following example extracts code comments from input lines. The regular expression searches for a substring that starts with `//` followed by some optional whitespace `\s*` followed by one or more characters captured in a capture group `(.+)`. This capture group captures only the comment substring. The `smatch` object `m` receives the search results. If successful, `m[1]` contains the comment that was found. You can check the `m[1].first` and `m[1].second` iterators to see where exactly the comment was found in the source string.

```
regex r("//\\s*(.+)");
while (true) {
    cout << "Enter a string with optional code comments (q=quit): ";
    string str;
    if (!getline(cin, str) || str == "q")
        break;

    smatch m;
    if (regex_search(str, m, r))
        cout << " Found comment '" << m[1] << "'" << endl;
    else
        cout << " No comment found!" << endl;
}
```

The output of this program can look as follows:

```
Enter a string (q=quit): std::string str; // Our source string
Found comment 'Our source string'
Enter a string (q=quit): int a; // A comment with // in the middle
Found comment 'A comment with // in the middle'
Enter a string (q=quit): float f; // A comment with a      (tab) character
Found comment 'A comment with a      (tab) character'
```

The `match_results` object also has a `prefix()` and `suffix()` method, which return the string preceding or following the match, respectively.

regex_iterator

As explained in the previous section, you should never use `regex_search()` in a loop to extract all occurrences of a pattern from a source sequence. Instead, you should use a `regex_iterator` or `regex_token_iterator`. They work similarly to iterators for Standard Library containers.

regex_iterator Example

The following example asks the user to enter a source string, extracts every word from the string, and prints all words between quotes. The regular expression in this case is `[\w]+`, which searches for one or more word-letters. This example uses `std::string` as source, so it uses `sregex_iterator` for the iterators. A standard iterator loop is used, but in this case, the end iterator is done slightly differently from the end iterators of ordinary Standard Library containers. Normally, you specify an end iterator for a particular container, but for `regex_iterator`, there is only one “end” iterator. You can get this end iterator by declaring a `regex_iterator` type using the default constructor.

The `for` loop creates a start iterator called `iter`, which accepts a begin and end iterator into the source string together with the regular expression. The loop body is called for every match found, which is every word in this example. The `sregex_iterator` iterates over all the matches. By dereferencing an `sregex_iterator`, you get a `smatch` object. Accessing the first element of this `smatch` object, `[0]`, gives you the matched substring:

```
regex reg("[\\w]+");
while (true) {
    cout << "Enter a string to split (q=quit): ";
    string str;
    if (!getline(cin, str) || str == "q")
        break;

    const sregex_iterator end;
    for (sregex_iterator iter(cbegin(str), cend(str), reg);
         iter != end; ++iter) {
        cout << "\"" << (*iter)[0] << "\"" << endl;
    }
}
```

The output of this program can look as follows:

```
Enter a string to split (q=quit): This, is    a test.
"This"
"is"
"a"
"test"
```

As this example demonstrates, even simple regular expressions can do some powerful string manipulation!

Note that both a `regex_iterator` and a `regex_token_iterator` internally contain a pointer to the given regular expression. They both explicitly delete constructors accepting an rvalue regular expression, so you cannot construct them with a temporary `regex` object. For example, the following does not compile:

```
for (sregex_iterator iter(cbegin(str), cend(str), regex("[\\w]+"));
     iter != end; ++iter) { ... }
```

regex_token_iterator

The previous section describes `regex_iterator`, which iterates through every matched pattern. In each iteration of the loop you get a `match_results` object, which you can use to extract subexpressions for that match that are captured by capture groups.

A `regex_token_iterator` can be used to automatically iterate over all or selected capture groups across all matched patterns. There are four constructors with the following format:

```
regex_token_iterator(BidirectionalIterator a,
                    BidirectionalIterator b,
                    const regex_type& re
                    [, SubMatches
                    [, Flags]]);
```

All of them require a begin and end iterator as input sequence, and a regular expression. The optional `SubMatches` parameter is used to specify which capture groups should be iterated over. `SubMatches` can be specified in four ways:

- As a single integer representing the index of the capture group that you want to iterate over.
- As a vector with integers representing the indices of the capture groups that you want to iterate over.
- As an `initializer_list` with capture group indices.
- As a C-style array with capture group indices.

When you omit `SubMatches` or when you specify a 0 for `SubMatches`, you get an iterator that iterates over all capture groups with index 0, which are the substrings matching the full regular expression. The optional `Flags` parameter specifies options for the matching algorithm. In most cases you can keep the default. Consult a Standard Library Reference for more details.

regex_token_iterator Examples

The previous `regex_iterator` example can be rewritten using a `regex_token_iterator` as follows. Note that `*iter` is used in the loop body instead of `(*iter)[0]` as in the `regex_iterator` example, because the token iterator with 0 as the default `submatch` index automatically iterates over all capture groups with index 0. The output of this code is exactly the same as the output generated by the `regex_iterator` example:

```
regex reg("[\\w]+");
while (true) {
    cout << "Enter a string to split (q=quit): ";
    string str;
    if (!getline(cin, str) || str == "q")
        break;
```

```

    const sregex_token_iterator end;
    for (sregex_token_iterator iter(cbegin(str), cend(str), reg);
         iter != end; ++iter) {
        cout << "\"" << *iter << "\"" << endl;
    }
}

```

The following example asks the user to enter a date and then uses a `sregex_token_iterator` to iterate over the second and third capture groups (month and day), which are specified as a vector of integers. The regular expression used for dates is explained earlier in this chapter. The only difference is that `^` and `$` anchors are added since we want to match the entire source sequence. Earlier, that was not necessary, because `sregex_match()` automatically matches the entire input string.

```

regex reg("^(\d{4})/(0?[1-9]|1[0-2])/(0?[1-9]|[1-2][0-9]|3[0-1])$");
while (true) {
    cout << "Enter a date (year/month/day) (q=quit): ";
    string str;
    if (!getline(cin, str) || str == "q")
        break;

    vector<int> indices{ 2, 3 };
    const sregex_token_iterator end;
    for (sregex_token_iterator iter(cbegin(str), cend(str), reg, indices);
         iter != end; ++iter) {
        cout << "\"" << *iter << "\"" << endl;
    }
}

```

This code prints only the month and day of valid dates. Output generated by this example can look like this:

```

Enter a date (year/month/day) (q=quit): 2011/1/13
"1"
"13"
Enter a date (year/month/day) (q=quit): 2011/1/32
Enter a date (year/month/day) (q=quit): 2011/12/5
"12"
"5"

```

The `sregex_token_iterator` can also be used to perform a so-called *field splitting* or *tokenization*. It is a much safer and more flexible alternative to using the old `strtok()` function from C. Tokenization is triggered in the `sregex_token_iterator` constructor by specifying `-1` as the capture group index to iterate over. When in tokenization mode, the iterator iterates over all substrings of the input sequence that *do not match* the regular expression. The following code demonstrates this by tokenizing a string on the delimiters `,` and `;` with zero or more whitespace characters before or after the delimiters:

```

regex reg(R"(\s*[;,]\s*)");
while (true) {
    cout << "Enter a string to split on ',' and ';' (q=quit): ";
    string str;
    if (!getline(cin, str) || str == "q")
        break;
}

```

```

const sregex_token_iterator end;
for (sregex_token_iterator iter(cbegin(str), cend(str), reg, -1);
     iter != end; ++iter) {
    cout << "\"" << *iter << "\"" << endl;
}
}

```

The regular expression in this example is specified as a raw string literal and searches for patterns that match the following:

- zero or more whitespace characters
- followed by a , or ; character
- followed by zero or more whitespace characters

The output can be as follows:

```

Enter a string to split on ',' and ';' (q=quit): This is, a; test string.
"This is"
"a"
"test string."

```

As you can see from this output, the string is split on , and ;. All whitespace characters around the , and ; are removed, because the tokenization iterator iterates over all substrings that *do not match* the regular expression, and because the regular expression matches , and ; *with* whitespace around them.

regex_replace()

The `regex_replace()` algorithm requires a regular expression, and a formatting string that is used to replace matching substrings. This formatting string can reference part of the matched substrings by using the escape sequences in the following table.

ESCAPE SEQUENCE	REPLACED WITH
<code>\$n</code>	The string matching the <i>n</i> -th capture group; for example, <code>\$1</code> for the first capture group, <code>\$2</code> for the second, and so on. <i>n</i> must be greater than 0.
<code>&</code>	The string matching the entire regular expression.
<code>^</code>	The part of the input sequence that appears to the left of the substring matching the regular expression.
<code>`</code>	The part of the input sequence that appears to the right of the substring matching the regular expression.
<code>\$</code>	A single dollar sign.

There are six versions of the `regex_replace()` algorithm. The difference between them is in the type of arguments. Four of them have the following format:

```
string regex_replace(InputSequence, RegEx, FormatString[, Flags]);
```

These four versions return the resulting string after performing the replacement. Both the `InputSequence` and the `FormatString` can be an `std::string` or a C-style string. The `RegEx` parameter is the regular expression that needs to be matched. The optional `Flags` parameter specifies options for the replace algorithm.

Two versions of the `regex_replace()` algorithm have the following format:

```
OutputIterator regex_replace(OutputIterator,
                             BidirectionalIterator first,
                             BidirectionalIterator last,
                             RegEx, FormatString[, Flags]);
```

These two versions write the resulting string to the given output iterator and return this output iterator. The input sequence is given as a begin and end iterator. The other parameters are identical to the other four versions of `regex_replace()`.

regex_replace() Examples

As a first example, take the following HTML source string,

```
<body><h1>Header</h1><p>Some text</p></body>
```

and the regular expression,

```
<h1>(.*?)</h1><p>(.*?)</p>
```

The following table shows the different escape sequences and what they will be replaced with.

ESCAPE SEQUENCE	REPLACED WITH
<code>\$1</code>	Header
<code>\$2</code>	Some text
<code>\$&</code>	<code><h1>Header</h1><p>Some text</p></code>
<code>\$`</code>	<code><body></code>
<code>\$^</code>	<code></body></code>

The following code demonstrates the use of `regex_replace()`:

```
const string str("<body><h1>Header</h1><p>Some text</p></body>");
regex r("<h1>(.*?)</h1><p>(.*?)</p>");

const string format("H1=$1 and P=$2"); // See above table
string result = regex_replace(str, r, format);

cout << "Original string: '" << str << "'" << endl;
cout << "New string      : '" << result << "'" << endl;
```

The output of this program is as follows:

```
Original string: '<body><h1>Header</h1><p>Some text</p></body>'
New string      : '<body>H1=Header and P=Some text</body>'
```

The `regex_replace()` algorithm accepts a number of flags that can be used to manipulate how it is working. The most important flags are given in the following table.

FLAG	DESCRIPTION
<code>format_default</code>	The default is to replace all occurrences of the pattern, and to also copy everything to the output that does not match the pattern.
<code>format_no_copy</code>	Replaces all occurrences of the pattern, but does not copy anything to the output that does not match the pattern.
<code>format_first_only</code>	Replaces only the first occurrence of the pattern.

The following example modifies the previous code to use the `format_no_copy` flag:

```
const string str("<body><h1>Header</h1><p>Some text</p></body>");
regex r("<h1>(.*?)</h1><p>(.*?)</p>");

const string format("H1=$1 and P=$2");
string result = regex_replace(str, r, format,
    regex_constants::format_no_copy);

cout << "Original string: '" << str << "' << endl;
cout << "New string      : '" << result << "' << endl;
```

The output is as follows. Compare this with the output of the previous version.

```
Original string: '<body><h1>Header</h1><p>Some text</p></body>'
New string      : 'H1=Header and P=Some text'
```

Another example is to get an input string and replace each word boundary with a newline so that the output contains only one word per line. The following example demonstrates this without using any loops to process a given input string. The code first creates a regular expression that matches individual words. When a match is found, it is replaced with `$1\n` where `$1` is replaced with the matched word. Note also the use of the `format_no_copy` flag to prevent copying whitespace and other non-word characters from the source string to the output.

```
regex reg("[\\w]+");
const string format("$1\n");
while (true) {
    cout << "Enter a string to split over multiple lines (q=quit): ";
    string str;
    if (!getline(cin, str) || str == "q")
        break;

    cout << regex_replace(str, reg, format,
        regex_constants::format_no_copy) << endl;
}
```

The output of this program can be as follows:

```
Enter a string to split over multiple lines (q=quit):  This is  a test.  
This  
is  
a  
test
```

SUMMARY

This chapter gave you an appreciation for coding with localization in mind. As anyone who has been through a localization effort will tell you, adding support for a new language or locale is infinitely easier if you have planned ahead; for example, by using Unicode characters and being mindful of locales.

The second part of this chapter explained the regular expressions library. Once you know the syntax of regular expressions, it becomes much easier to work with strings. Regular expressions allow you to validate strings, search for substrings inside an input sequence, perform find-and-replace operations, and so on. It is highly recommended that you get to know regular expressions and start using them instead of writing your own string manipulation routines. They will make your life easier.

20

Additional Library Utilities

WHAT'S IN THIS CHAPTER?

- How to work with compile-time rational numbers
- How to work with time
- How to generate random numbers
- How to work with `optional` values
- How to use the `variant` and `any` data types
- What tuples are and how to use them
- How to use the filesystem support library

WROX.COM DOWNLOADS FOR THIS CHAPTER

Please note that all the code examples for this chapter are available as a part of this chapter's code download on the book's website at www.wrox.com/go/proc++4e on the Download Code tab.

This chapter discusses some additional library functionality that is available in the C++ Standard Library and that does not naturally fit into other chapters.

RATIOS

The Ratio library allows you to exactly represent any finite rational number that you can use at compile time. Ratios are used in the `std::chrono::duration` class discussed in the next section. Everything is defined in the `<ratio>` header file and is in the `std` namespace.

The numerator and denominator of a rational number are represented as compile-time constants of type `std::intmax_t`, which is a signed integer type with the maximum width supported by a compiler. Because of the compile-time nature of these rational numbers, using them might look a bit complicated and different than what you are used to. You cannot define a `ratio` object the same way as you define normal objects, and you cannot call methods on it. Instead, you need to use type aliases. For example, the following line defines a rational compile-time constant representing the fraction $1/60$:

```
using r1 = ratio<1, 60>;
```

The numerator and denominator of the `r1` rational number are compile-time constants and can be accessed as follows:

```
intmax_t num = r1::num;
intmax_t den = r1::den;
```

Remember that a `ratio` is a *compile-time constant*, which means that the numerator and denominator need to be known at compile time. The following generates a compilation error:

```
intmax_t n = 1;
intmax_t d = 60;
using r1 = ratio<n, d>; // Error
```

Making `n` and `d` constants removes the error:

```
const intmax_t n = 1;
const intmax_t d = 60;
using r1 = ratio<n, d>; // Ok
```

Rational numbers are always normalized. For a rational number `ratio<n, d>`, the greatest common divisor, `gcd`, is calculated and the numerator, `num`, and denominator, `den`, are then defined as follows:

- `num = sign(n) * sign(d) * abs(n) / gcd`
- `den = abs(d) / gcd`

The library supports adding, subtracting, multiplying, and dividing rational numbers. Because all these operations are also happening at compile time, you cannot use the standard arithmetic operators. Instead, you need to use specific templates in combination with type aliases. The following arithmetic `ratio` templates are available: `ratio_add`, `ratio_subtract`, `ratio_multiply`, and `ratio_divide`. These templates calculate the result as a new `ratio` type. This type can be accessed with the embedded type alias called `type`. For example, the following code first defines two `ratios`, one representing $1/60$ and the other representing $1/30$. The `ratio_add` template adds those two rational numbers together to produce the `result` rational number, which, after normalization, is $1/20$.

```
using r1 = ratio<1, 60>;
using r2 = ratio<1, 30>;
using result = ratio_add<r1, r2>::type;
```

The standard also defines a number of `ratio` comparison templates: `ratio_equal`, `ratio_not_equal`, `ratio_less`, `ratio_less_equal`, `ratio_greater`, and `ratio_greater_equal`. Just like the arithmetic `ratio` templates, the `ratio` comparison templates are all evaluated at compile time.

These comparison templates define a new type that is an `std::bool_constant`, representing the result. `bool_constant` is an `std::integral_constant`, a struct template that stores a type and a compile-time constant value. For example, `integral_constant<int, 15>` stores an integer with value 15. `bool_constant` is an `integral_constant` with type `bool`. For instance, `bool_constant<true>` is `integral_constant<bool, true>`, which stores a Boolean with value `true`. The result of the ratio comparison templates is either `bool_constant<true>` or `bool_constant<false>`. The value associated with a `bool_constant` or an `integral_constant` can be accessed using the `value` data member. The following example demonstrates the use of `ratio_less`. Chapter 13 discusses the use of `boolalpha` to output `true` or `false` for Boolean values.

```
using r1 = ratio<1, 60>;
using r2 = ratio<1, 30>;
using res = ratio_less<r2, r1>;
cout << boolalpha << res::value << endl;
```

The following example combines everything I have just covered. Note that because ratios are compile-time constants, you cannot do something like `cout << r1`; you need to get the numerator and denominator and print them separately.

```
// Define a compile-time rational number
using r1 = ratio<1, 60>;
cout << "1) " << r1::num << "/" << r1::den << endl;

// Get numerator and denominator
intmax_t num = r1::num;
intmax_t den = r1::den;
cout << "2) " << num << "/" << den << endl;

// Add two rational numbers
using r2 = ratio<1, 30>;
cout << "3) " << r2::num << "/" << r2::den << endl;
using result = ratio_add<r1, r2>::type;
cout << "4) " << result::num << "/" << result::den << endl;

// Compare two rational numbers
using res = ratio_less<r2, r1>;
cout << "5) " << boolalpha << res::value << endl;
```

The output is as follows:

```
1) 1/60
2) 1/60
3) 1/30
4) 1/20
5) false
```

The library provides a number of SI (*Système International*) type aliases for your convenience. They are as follows:

```
using yocto = ratio<1, 1'000'000'000'000'000'000'000'000>; // *
using zepto = ratio<1, 1'000'000'000'000'000'000'000>; // *
using atto = ratio<1, 1'000'000'000'000'000'000>;
using femto = ratio<1, 1'000'000'000'000'000>;
using pico = ratio<1, 1'000'000'000'000>;
```

```

using nano = ratio<1, 1'000'000'000>;
using micro = ratio<1, 1'000'000>;
using milli = ratio<1, 1'000>;
using centi = ratio<1, 100>;
using deci = ratio<1, 10>;
using deca = ratio<10, 1>;
using hecto = ratio<100, 1>;
using kilo = ratio<1'000, 1>;
using mega = ratio<1'000'000, 1>;
using giga = ratio<1'000'000'000, 1>;
using tera = ratio<1'000'000'000'000, 1>;
using peta = ratio<1'000'000'000'000'000, 1>;
using exa = ratio<1'000'000'000'000'000'000, 1>;
using zetta = ratio<1'000'000'000'000'000'000'000, 1>; // *
using yotta = ratio<1'000'000'000'000'000'000'000'000, 1>; // *

```

The SI units with an asterisk at the end are defined only if your compiler can represent the constant numerator and denominator values for those type aliases as an `intmax_t`. An example of how to use these predefined SI units is given in the discussion of `durations` in the next section.

THE CHRONO LIBRARY

The `chrono` library is a collection of classes that work with times. The library consists of the following components:

- Durations
- Clocks
- Time points

Everything is defined in the `std::chrono` namespace and requires you to include the `<chrono>` header file. The following sections explain each component.

Duration

A *duration* is an interval between two points in time. It is represented by the `duration` class template, which stores a number of *ticks* and a *tick period*. The tick period is the time in seconds between two ticks and is represented as a compile-time `ratio` constant, which means it could be a fraction of a second. Ratios are discussed in the previous section. The `duration` template accepts two template parameters and is defined as follows:

```
template <class Rep, class Period = ratio<1>> class duration {...}
```

The first template parameter, `Rep`, is the type of variable storing the number of ticks and should be an arithmetic type, for example `long`, `double`, and so on. The second template parameter, `Period`, is the rational constant representing the period of a tick. If you don't specify the tick period, the default value `ratio<1>` is used, which represents a tick period of one second.

Three constructors are provided: the default constructor; one that accepts a single value, the number of ticks; and one that accepts another `duration`. The latter constructor can be used to convert from

one duration to another duration, for example, from minutes to seconds. An example is given later in this section.

Durations support arithmetic operations such as `+`, `-`, `*`, `/`, `%`, `++`, `--`, `+=`, `-=`, `*=`, `/=`, and `%=`, and support the comparison operators. The class also contains the methods shown in the following table.

METHOD	DESCRIPTION
<code>Rep count() const</code>	Returns the duration value as the number of ticks. The return type is the type specified as a parameter to the duration template.
<code>static duration zero()</code>	Returns a duration with a duration value equivalent to zero.
<code>static duration min()</code> <code>static duration max()</code>	Returns a duration with the minimum/maximum possible duration value representable by the type specified as a parameter to the duration template.

C++17 adds `floor()`, `ceil()`, `round()`, and `abs()` operations for durations that behave just as they behave with numerical data.

Let's see how durations can be used in actual code. A duration where each tick is one second can be defined as follows:

```
duration<long> d1;
```

Because `ratio<1>` is the default tick period, this is the same as writing the following:

```
duration<long, ratio<1>> d1;
```

The following defines a duration in minutes (tick period = 60 seconds):

```
duration<long, ratio<60>> d2;
```

To define a duration where each tick period is a sixtieth of a second, use the following:

```
duration<double, ratio<1, 60>> d3;
```

As you saw earlier in this chapter, the `<ratio>` header file defines a number of SI rational constants. These predefined constants come in handy for defining tick periods. For example, the following line of code defines a duration where each tick period is one millisecond:

```
duration<long long, milli> d4;
```

The following example demonstrates several aspects of durations. It shows you how to define durations, how to perform arithmetic operations on them, and how to convert one duration into another duration with a different tick period.

```
// Specify a duration where each tick is 60 seconds
duration<long, ratio<60>> d1(123);
cout << d1.count() << endl;
```

```
// Specify a duration represented by a double with each tick
// equal to 1 second and assign the largest possible duration to it.
duration<double> d2;
d2 = d2.max();
cout << d2.count() << endl;

// Define 2 durations:
// For the first duration, each tick is 1 minute
// For the second duration, each tick is 1 second
duration<long, ratio<60>> d3(10); // = 10 minutes
duration<long, ratio<1>> d4(14); // = 14 seconds

// Compare both durations
if (d3 > d4)
    cout << "d3 > d4" << endl;
else
    cout << "d3 <= d4" << endl;

// Increment d4 with 1 resulting in 15 seconds
++d4;

// Multiply d4 by 2 resulting in 30 seconds
d4 *= 2;

// Add both durations and store as minutes
duration<double, ratio<60>> d5 = d3 + d4;

// Add both durations and store as seconds
duration<long, ratio<1>> d6 = d3 + d4;
cout << d3.count() << " minutes + " << d4.count() << " seconds = "
    << d5.count() << " minutes or "
    << d6.count() << " seconds" << endl;

// Create a duration of 30 seconds
duration<long> d7(30);

// Convert the seconds of d7 to minutes
duration<double, ratio<60>> d8(d7);
cout << d7.count() << " seconds = " << d8.count() << " minutes" << endl;
```

The output is as follows:

```
123
1.79769e+308
d3 > d4
10 minutes + 30 seconds = 10.5 minutes or 630 seconds
30 seconds = 0.5 minutes
```

NOTE *The second line in the output represents the largest possible duration with type double. The exact value might be different depending on your compiler.*

Pay special attention to the following two lines:

```
duration<double, ratio<60>> d5 = d3 + d4;
duration<long, ratio<1>> d6 = d3 + d4;
```

They both calculate $d3+d4$ but the first line stores it as a floating point value representing minutes, while the second line stores the result as an integral value representing seconds. Conversion from minutes to seconds or vice versa happens automatically.

The following two lines from the preceding example demonstrate how to explicitly convert between different units of time:

```
duration<long> d7(30);           // seconds
duration<double, ratio<60>> d8(d7); // minutes
```

The first line defines a `duration` representing 30 seconds. The second line converts these 30 seconds into minutes, resulting in 0.5 minutes. Converting in this direction can result in a non-integral value, and thus requires you to use a `duration` represented by a floating point type; otherwise, you will get some cryptic compilation errors. The following lines, for example, do not compile because `d8` is using `long` instead of a floating point type:

```
duration<long> d7(30);           // seconds
duration<long, ratio<60>> d8(d7); // minutes // Error!
```

You can, however, force this conversion by using `duration_cast()`:

```
duration<long> d7(30);           // seconds
auto d8 = duration_cast<duration<long, ratio<60>>>(d7); // minutes
```

In this case, `d8` will be 0 minutes, because integer division is used to convert 30 seconds to minutes.

Converting in the other direction does not require floating point types if the source is an integral type, because the result is always an integral value if you started with an integral value. For example, the following lines convert ten minutes into seconds, both represented by the integral type `long`:

```
duration<long, ratio<60>> d9(10); // minutes
duration<long> d10(d9);          // seconds
```

The library provides the following standard `duration` types in the `std::chrono` namespace:

```
using nanoseconds   = duration<X 64 bits, nano>;
using microseconds = duration<X 55 bits, micro>;
using milliseconds = duration<X 45 bits, milli>;
using seconds       = duration<X 35 bits>;
using minutes       = duration<X 29 bits, ratio<60>>;
using hours         = duration<X 23 bits, ratio<3600>>;
```

The exact type of `X` depends on your compiler, but the C++ standard requires it to be a signed integer type of at least the specified size. The preceding type aliases make use of the predefined SI `ratio` type aliases that are described earlier in this chapter. With these predefined types, instead of writing this,

```
duration<long, ratio<60>> d9(10); // minutes
```

you can simply write this:

```
minutes d9(10); // minutes
```

The following code is another example of how to use these predefined durations. The code first defines a variable `t`, which is the result of 1 hour + 23 minutes + 45 seconds. The `auto` keyword is used to let the compiler automatically figure out the exact type of `t`. The second line uses the constructor of the predefined `seconds` duration to convert the value of `t` to seconds, and writes the result to the console.

```
auto t = hours(1) + minutes(23) + seconds(45);
cout << seconds(t).count() << " seconds" << endl;
```

Because the standard requires that the predefined durations use integer types, there can be compilation errors if a conversion *could* end up with a non-integral value. While integer division normally truncates, in the case of durations, which are implemented with `ratio` types, the compiler declares any computation that *could* result in a non-zero remainder as a compile-time error. For example, the following code does not compile because converting 90 seconds to minutes results in 1.5 minutes:

```
seconds s(90);
minutes m(s);
```

However, the following code does not compile either, even though 60 seconds is exactly 1 minute. It is flagged as a compile-time error because converting from seconds to minutes *could* result in non-integral values.

```
seconds s(60);
minutes m(s);
```

Converting in the other direction works perfectly fine because the `minutes` duration uses an integral type and converting it to `seconds` always results in an integral value:

```
minutes m(2);
seconds s(m);
```

You can use the standard user-defined literals “h”, “min”, “s”, “ms”, “us”, and “ns” for creating durations. Technically, these are defined in the `std::literals::chrono_literals` namespace, but also made accessible with `using namespace std::chrono`. Here is an example:

```
using namespace std::chrono;
// ...
auto myDuration = 42min; // 42 minutes
```

Clock

A `clock` is a class consisting of a `time_point` and a duration. The `time_point` type is discussed in detail in the next section, but those details are not required to understand how `clocks` work. However, `time_points` themselves depend on `clocks`, so it’s important to know the details of `clocks` first.

Three `clocks` are defined by the standard. The first one is called `system_clock` and represents the wall clock time from the system-wide real-time clock. The second one is called `steady_clock`, and it guarantees its `time_point` will never decrease, which is not guaranteed for `system_clock` because the system clock can be adjusted at any time. The third one is the `high_resolution_clock`,

which has the shortest possible tick period. Depending on your compiler, it is possible for the `high_resolution_clock` to be a synonym for `steady_clock` or `system_clock`.

Every `clock` has a static `now()` method to get the current time as a `time_point`. The `system_clock` also defines two static helper functions for converting `time_points` to and from the `time_t` C-style time representation. The first function is called `to_time_t()`, and it converts a given `time_point` to a `time_t`; the second function is called `from_time_t()`, and it returns a `time_point` initialized with a given `time_t` value. The `time_t` type is defined in the `<ctime>` header file.

The following example shows a complete program which gets the current time from the system and outputs the time in a human-readable format to the console. The `localtime()` function converts a `time_t` to a local time represented by `tm` and is defined in the `<ctime>` header file. The `put_time()` stream manipulator, defined in the `<iomanip>` header, is introduced in Chapter 13.

```
// Get current time as a time_point
system_clock::time_point tpoint = system_clock::now();
// Convert to a time_t
time_t tt = system_clock::to_time_t(tpoint);
// Convert to local time
tm* t = localtime(&tt);
// Write the time to the console
cout << put_time(t, "%H:%M:%S") << endl;
```

If you want to convert a time to a string, you can use an `std::stringstream` or the C-style `strftime()` function, defined in `<ctime>`, as follows. Using the `strftime()` function requires you to supply a buffer that is big enough to hold the human-readable representation of the given time:

```
// Get current time as a time_point
system_clock::time_point tpoint = system_clock::now();
// Convert to a time_t
time_t tt = system_clock::to_time_t(tpoint);
// Convert to local time
tm* t = localtime(&tt);
// Convert to readable format
char buffer[80] = {0};
strftime(buffer, sizeof(buffer), "%H:%M:%S", t);
// Write the time to the console
cout << buffer << endl;
```

NOTE *These examples might give you a security-related error or warning on the call to `localtime()`. With Microsoft Visual C++ you should use the safe version called `localtime_s()`, while on Linux you should use `localtime_r()`.*

The `chrono` library can also be used to time how long it takes for a piece of code to execute. The following example shows how you can do this. The actual type of the variables `start` and `end` is `high_resolution_clock::time_point`, and the actual type of `diff` is a duration.

```
// Get the start time
auto start = high_resolution_clock::now();
// Execute code that you want to time
double d = 0;
```

```

for (int i = 0; i < 1000000; ++i) {
    d += sqrt(sin(i) * cos(i));
}
// Get the end time and calculate the difference
auto end = high_resolution_clock::now();
auto diff = end - start;
// Convert the difference into milliseconds and output to the console
cout << duration<double, milli>(diff).count() << "ms" << endl;

```

The loop in this example is performing some arithmetic operations with `sqrt()`, `sin()`, and `cos()` to make sure the loop doesn't end too fast. If you get really small values for the difference in milliseconds on your system, those values will not be accurate and you should increase the number of iterations of the loop to make it last longer. Small timings will not be accurate because, while timers often have a resolution in milliseconds, on most operating systems, this timer is updated infrequently, for example, every 10 ms or 15 ms. This induces a phenomenon called *gating error*, where any event that occurs in less than one timer tick appears to take place in zero units of time; any event between one and two timer ticks appears to take place in one timer unit. For example, on a system with a 15 ms timer update, a loop that takes 44 ms will appear to take only 30 ms. When using such timers to time computations, it is important to make sure that the entire computation takes place across a fairly large number of basic timer tick units so that these errors are minimized.

Time Point

A point in time is represented by the `time_point` class and stored as a `duration` relative to the *epoch*. A `time_point` is always associated with a certain `clock` and the epoch is the origin of this associated `clock`. For example, the epoch for the classic Unix/Linux time is 1st of January 1970, and durations are measured in seconds. The epoch for Windows is 1st of January 1601 and durations are measured in 100-nanosecond units. Other operating systems have different epoch dates and duration units.

The `time_point` class contains a function called `time_since_epoch()`, which returns a `duration` representing the time between the epoch of the associated `clock` and the stored point in time.

Arithmetic operations of `time_points` and `durations` that make sense are supported. The following table lists those operations. `tp` is a `time_point` and `d` is a `duration`.

<code>tp + d = tp</code>	<code>tp - d = tp</code>
<code>d + tp = tp</code>	<code>tp - tp = d</code>
<code>tp += d</code>	<code>tp -= d</code>

An example of an operation that is not supported is `tp+tp`.

Comparison operators are also supported to compare two time points. Two static methods are provided: `min()`, which returns the smallest possible point in time, and `max()`, which returns the largest possible point in time.

The `time_point` class has three constructors.

- `time_point()`: This constructs a `time_point` initialized with `duration::zero()`. The resulting `time_point` represents the epoch of the associated `clock`.
- `time_point(const duration& d)`: This constructs a `time_point` initialized with the given duration. The resulting `time_point` represents `epoch + d`.
- `template <class Duration2> time_point(const time_point<clock, Duration2>& t)`: This constructs a `time_point` initialized with `t.time_since_epoch()`.

Each `time_point` is associated with a `clock`. To create a `time_point`, you specify the `clock` as the template parameter:

```
time_point<steady_clock> tp1;
```

Each `clock` also knows its `time_point` type, so you can also write it as follows:

```
steady_clock::time_point tp1;
```

The following example demonstrates the `time_point` class:

```
// Create a time_point representing the epoch
// of the associated steady clock
time_point<steady_clock> tp1;
// Add 10 minutes to the time_point
tp1 += minutes(10);
// Store the duration between epoch and time_point
auto d1 = tp1.time_since_epoch();
// Convert the duration to seconds and output to the console
duration<double> d2(d1);
cout << d2.count() << " seconds" << endl;
```

The output should be as follows:

```
600 seconds
```

Converting `time_points` can be done implicitly or explicitly, similar to duration conversions. Here is an example of an implicit conversion. The output is 42000 ms.

```
time_point<steady_clock, seconds> tpSeconds(42s);
// Convert seconds to milliseconds implicitly.
time_point<steady_clock, milliseconds> tpMilliseconds(tpSeconds);
cout << tpMilliseconds.time_since_epoch().count() << " ms" << endl;
```

If the implicit conversion can result in a loss of data, then you need an explicit conversion using `time_point_cast()`, just as `duration_cast()` is needed for explicit duration casts. The following example outputs 42000 ms, even though you start from 42,424ms.

```
time_point<steady_clock, milliseconds> tpMilliseconds(42'424ms);
// Convert milliseconds to seconds explicitly.
time_point<steady_clock, seconds> tpSeconds(
    time_point_cast<seconds>(tpMilliseconds));

// Convert seconds back to milliseconds and output the result.
milliseconds ms(tpSeconds.time_since_epoch());
cout << ms.count() << " ms" << endl;
```

C++17

C++17 adds `floor()`, `ceil()`, and `round()` operations for `time_points` that behave just as they behave with numerical data.

RANDOM NUMBER GENERATION

Generating good random numbers in software is a complex topic. Before C++11, the only way to generate random numbers was to use the C-style `srand()` and `rand()` functions. The `srand()` function needed to be called once in your application and was used to initialize the random number generator, also called *seeding*. Usually the current system time would be used as a seed.

WARNING *You need to make sure that you use a good-quality seed for your software-based random number generator. If you initialize the random number generator with the same seed every time, you will create the same sequence of random numbers every time. This is why the seed is usually the current system time.*

Once the generator is initialized, random numbers could be generated with `rand()`. The following example shows how to use `srand()` and `rand()`. The `time(nullptr)` call returns the system time, and is defined in the `<ctime>` header file.

```
srand(static_cast<unsigned int>(time(nullptr)));
cout << rand() << endl;
```

A random number within a certain range can be generated with the following function:

```
int getRandom(int min, int max)
{
    return (rand() % static_cast<int>(max + 1 - min)) + min;
}
```

The old C-style `rand()` function generates random numbers in the range 0 to `RAND_MAX`, which is defined by the standard to be at least 32,767. Unfortunately, the low-order bits of `rand()` are often not very random, which means that using the previous `getRandom()` function to generate a random number in a small range, such as 1 to 6, will not result in very good randomness.

NOTE *Software-based random number generators can never generate truly random numbers. They are therefore called pseudo-random number generators because they rely on mathematical formulas to give the impression of randomness.*

The old `srand()` and `rand()` functions don't offer much in terms of flexibility. You cannot, for example, change the distribution of the generated random numbers. C++11 has added a powerful library to generate random numbers by using different algorithms and distributions. The library is

defined in the `<random>` header file and has three big components: *engines*, *engine adaptors*, and *distributions*. A random number *engine* is responsible for generating the actual random numbers and storing the state for generating subsequent random numbers. The *distribution* determines the range of the generated random numbers and how they are mathematically distributed within that range. A random number *engine adaptor* modifies the results of a random number engine you associate it with.

It's highly recommended to stop using `srand()` and `rand()`, and to start using the classes from `<random>`.

Random Number Engines

The following random number engines are available:

- `random_device`
- `linear_congruential_engine`
- `mersenne_twister_engine`
- `subtract_with_carry_engine`

The `random_device` engine is not a software-based generator; it is a special engine that requires a piece of hardware attached to your computer that generates truly non-deterministic random numbers, for example, by using the laws of physics. A classic mechanism measures the decay of a radioactive isotope by counting alpha-particles-per-time-interval, but there are many other kinds of physics-based random-number generators, including measuring the “noise” of reverse-biased diodes (thus eliminating the concerns about radioactive sources in your computer). The details of these mechanisms fall outside the scope of this book.

According to the specification for `random_device`, if no such device is attached to the computer, the library is free to use one of the software algorithms. The choice of algorithm is up to the library designer.

The quality of a random number generator is referred to as its *entropy* measure. The `entropy()` method of the `random_device` class returns 0.0 if it is using a software-based pseudo-random number generator, and returns a nonzero value if there is a hardware device attached. The nonzero value is an estimate of the entropy of the attached device.

Using a `random_device` engine is rather straightforward:

```
random_device rnd;
cout << "Entropy: " << rnd.entropy() << endl;
cout << "Min value: " << rnd.min()
    << ", Max value: " << rnd.max() << endl;
cout << "Random number: " << rnd() << endl;
```

A possible output of this program could be as follows:

```
Entropy: 32
Min value: 0, Max value: 4294967295
Random number: 3590924439
```

A `random_device` is usually slower than a pseudo-random number engine. Therefore, if you need to generate a lot of random numbers, I recommend to use a pseudo-random number engine, and to use

a `random_device` to generate a seed for the pseudo-random number engine. This is demonstrated in the section “Generating Random Numbers.”

Next to the `random_device` engine, there are three pseudo-random number engines:

- The *linear congruential engine* requires a minimal amount of memory to store its state. The state is a single integer containing the last generated random number or the initial seed if no random number has been generated yet. The period of this engine depends on an algorithmic parameter and can be up to 2^{64} but is usually less. For this reason, the linear congruential engine should not be used when you need a high-quality random number sequence.
- Of the three pseudo-random number engines, the *Mersenne twister* generates the highest quality of random numbers. The period of a Mersenne twister depends on an algorithmic parameter but is much bigger than the period of a linear congruential engine. The memory required to store the state of a Mersenne twister also depends on its parameters but is much larger than the single integer state of the linear congruential engine. For example, the predefined Mersenne twister `mt19937` has a period of $2^{19937}-1$, while the state contains 625 integers or 2.5 kilobytes. It is also one of the fastest engines.
- The *subtract with carry engine* requires a state of around 100 bytes; however, the quality of the generated random numbers is less than that of the numbers generated by the Mersenne twister, and it is also slower than the Mersenne twister.

The mathematical details of the engines and of the quality of random numbers fall outside the scope of this book. If you want to know more about these topics, you can consult a reference from the “Random Numbers” section in Appendix B.

The `random_device` engine is easy to use and doesn’t require any parameters. However, creating an instance of one of the three pseudo-random number generators requires you to specify a number of mathematical parameters, which can be complicated. The selection of parameters greatly influences the quality of the generated random numbers. For example, the definition of the `mersenne_twister_engine` class looks like this:

```
template<class UIntType, size_t w, size_t n, size_t m, size_t r,
        UIntType a, size_t u, UIntType d, size_t s,
        UIntType b, size_t t, UIntType c, size_t l, UIntType f>
class mersenne_twister_engine {...}
```

It requires 14 parameters. The `linear_congruential_engine` and the `subtract_with_carry_engine` classes also require a number of such mathematical parameters. For this reason, the standard defines a couple of predefined engines. One example is the `mt19937` Mersenne twister, which is defined as follows:

```
using mt19937 = mersenne_twister_engine<uint_fast32_t, 32, 624, 397, 31,
    0x9908b0df, 11, 0xffffffff, 7, 0x9d2c5680, 15, 0xefc60000, 18,
    1812433253>;
```

These parameters are all magic, unless you understand the details of the Mersenne twister algorithm. In general, you do not want to modify any of these parameters unless you are a specialist in the mathematics of pseudo-random number generators. Instead, it is highly recommended to use one of the predefined type aliases such as `mt19937`. A complete list of predefined engines is given in a later section.

Random Number Engine Adaptors

A random number engine adaptor modifies the result of a random number engine you associate it with, which is called the *base engine*. This is an example of the *adaptor pattern* (see Chapter 29). The following three adaptor templates are defined:

```
template<class Engine, size_t p, size_t r> class
    discard_block_engine {...}
template<class Engine, size_t w, class UIntType> class
    independent_bits_engine {...}
template<class Engine, size_t k> class
    shuffle_order_engine {...}
```

The `discard_block_engine` adaptor generates random numbers by discarding some of the values generated by its base engine. It requires three parameters: the engine to adapt, the block size p , and the used block size r . The base engine is used to generate p random numbers. The adaptor then discards $p-r$ of those numbers and returns the remaining r numbers.

The `independent_bits_engine` adaptor generates random numbers with a given number of bits w by combining several random numbers generated by the base engine.

The `shuffle_order_engine` adaptor generates the same random numbers that are generated by the base engine, but delivers them in a different order.

How these adaptors internally work depends on mathematics and falls outside the scope of this book.

A number of predefined engine adaptors are available. The next section gives an overview of the predefined engines and engine adaptors.

Predefined Engines and Engine Adaptors

As mentioned earlier, it is not recommended to specify your own parameters for pseudo-random number engines and engine adaptors, but instead to use one of the standard ones. C++ defines the following predefined engines and engine adaptors, all in the `<random>` header file. They all have complicated template arguments, but it is not necessary to understand those arguments to be able to use them.

NAME	TEMPLATE
<code>minstd_rand0</code>	<code>linear_congruential_engine</code>
<code>minstd_rand</code>	<code>linear_congruential_engine</code>
<code>mt19937</code>	<code>mersenne_twister_engine</code>
<code>mt19937_64</code>	<code>mersenne_twister_engine</code>
<code>ranlux24_base</code>	<code>subtract_with_carry_engine</code>

continues

(continued)

NAME	TEMPLATE
ranlux48_base	subtract_with_carry_engine
ranlux24	discard_block_engine
ranlux48	discard_block_engine
knuth_b	shuffle_order_engine
default_random_engine	<i>implementation-defined</i>

The `default_random_engine` is compiler dependent.

The following section gives an example of how to use these predefined engines.

Generating Random Numbers

Before you can generate any random number, you first need to create an instance of an engine. If you use a software-based engine, you also need to define a distribution. A distribution is a mathematical formula describing how numbers are distributed within a certain range. The recommended way to create an engine is to use one of the predefined engines discussed in the previous section.

The following example uses the predefined engine called `mt19937`, using a Mersenne twister engine. This is a software-based generator. Just as with the old `rand()` generator, a software-based engine should be initialized with a seed. The seed used with `srand()` was often the current time. In modern C++, it's recommended to use a `random_device` to generate a seed, and to use a time-based seed as a fallback in case the `random_device` does not have any entropy.

```
random_device seeder;
const auto seed = seeder.entropy() ? seeder() : time(nullptr);
mt19937 eng(static_cast<mt19937::result_type>(seed));
```

Next, a distribution is defined. This example uses a uniform integer distribution, for the range 1 to 99. Distributions are explained in detail in the next section, but the uniform distribution is easy enough to use for this example:

```
uniform_int_distribution<int> dist(1, 99);
```

Once the engine and distribution are defined, random numbers can be generated by calling the function call operator of the distribution, and passing the engine as argument. For this example, this is written as `dist(eng)`:

```
cout << dist(eng) << endl;
```

As you can see, to generate a random number using a software-based engine, you always need to specify the engine and distribution. The `std::bind()` utility, introduced in Chapter 18 and defined in the `<functional>` header file, can be used to remove the need to specify both the distribution and the engine when generating a random number. The following example uses the same `mt19937` engine and uniform distribution as the previous example. It then defines `gen()` by using `std::bind()` to bind `eng` to the first parameter for `dist()`. This way, you can call `gen()` without any argument to generate a new random number. The example then demonstrates the use of `gen()` in combination

with the `generate()` algorithm to fill a vector of ten elements with random numbers. The `generate()` algorithm is discussed in Chapter 18 and is defined in `<algorithm>`.

```
random_device seeder;
const auto seed = seeder.entropy() ? seeder() : time(nullptr);
mt19937 eng(static_cast<mt19937::result_type>(seed));
uniform_int_distribution<int> dist(1, 99);

auto gen = std::bind(dist, eng);

vector<int> vec(10);
generate(begin(vec), end(vec), gen);

for (auto i : vec) { cout << i << " "; }
```

NOTE Remember that the `generate()` algorithm overwrites existing elements and does not insert new elements. This means that you first need to size the vector to hold the number of elements you need, and then call the `generate()` algorithm. The previous example sizes the vector by specifying the size as argument to the constructor.

Even though you don't know the exact type of `gen()`, it's still possible to pass `gen()` to another function that wants to use that generator. You have two options: use a parameter of type `std::function<int()>`, or use a function template. The previous example can be adapted to generate random numbers in a function called `fillVector()`. Here is an implementation using `std::function`:

```
void fillVector(vector<int>& vec, const std::function<int()>& generator)
{
    generate(begin(vec), end(vec), generator);
}
```

and here is a function template version:

```
template<typename T>
void fillVector(vector<int>& vec, const T& generator)
{
    generate(begin(vec), end(vec), generator);
}
```

This function is used as follows:

```
random_device seeder;
const auto seed = seeder.entropy() ? seeder() : time(nullptr);
mt19937 eng(static_cast<mt19937::result_type>(seed));
uniform_int_distribution<int> dist(1, 99);

auto gen = std::bind(dist, eng);

vector<int> vec(10);
fillVector(vec, gen);

for (auto i : vec) { cout << i << " "; }
```

Random Number Distributions

A distribution is a mathematical formula describing how numbers are distributed within a certain range. The random number generator library comes with the following distributions that can be used with pseudo-random number engines to define the distribution of the generated random numbers. It's a compacted representation. The first line of each distribution is the class name and class template parameters, if any. The next lines are a constructor for the distribution. Only one constructor for each distribution is shown to give you an idea of the class. Consult a Standard Library Reference, see Appendix B, for a detailed list of all constructors and methods of each distribution.

Available uniform distributions:

```
template<class IntType = int> class uniform_int_distribution
    uniform_int_distribution(IntType a = 0,
                          IntType b = numeric_limits<IntType>::max());
template<class RealType = double> class uniform_real_distribution
    uniform_real_distribution(RealType a = 0.0, RealType b = 1.0);
```

Available Bernoulli distributions:

```
class bernoulli_distribution
    bernoulli_distribution(double p = 0.5);
template<class IntType = int> class binomial_distribution
    binomial_distribution(IntType t = 1, double p = 0.5);
template<class IntType = int> class geometric_distribution
    geometric_distribution(double p = 0.5);
template<class IntType = int> class negative_binomial_distribution
    negative_binomial_distribution(IntType k = 1, double p = 0.5);
```

Available Poisson distributions:

```
template<class IntType = int> class poisson_distribution
    poisson_distribution(double mean = 1.0);
template<class RealType = double> class exponential_distribution
    exponential_distribution(RealType lambda = 1.0);
template<class RealType = double> class gamma_distribution
    gamma_distribution(RealType alpha = 1.0, RealType beta = 1.0);
template<class RealType = double> class weibull_distribution
    weibull_distribution(RealType a = 1.0, RealType b = 1.0);
template<class RealType = double> class extreme_value_distribution
    extreme_value_distribution(RealType a = 0.0, RealType b = 1.0);
```

Available normal distributions:

```
template<class RealType = double> class normal_distribution
    normal_distribution(RealType mean = 0.0, RealType stddev = 1.0);
template<class RealType = double> class lognormal_distribution
    lognormal_distribution(RealType m = 0.0, RealType s = 1.0);
template<class RealType = double> class chi_squared_distribution
    chi_squared_distribution(RealType n = 1);
template<class RealType = double> class cauchy_distribution
    cauchy_distribution(RealType a = 0.0, RealType b = 1.0);
template<class RealType = double> class fisher_f_distribution
    fisher_f_distribution(RealType m = 1, RealType n = 1);
```

```
template<class RealType = double> class student_t_distribution
    student_t_distribution(RealType n = 1);
```

Available sampling distributions:

```
template<class IntType = int> class discrete_distribution
    discrete_distribution(initializer_list<double> wl);
template<class RealType = double> class piecewise_constant_distribution
    template<class UnaryOperation>
        piecewise_constant_distribution(initializer_list<RealType> bl,
            UnaryOperation fw);
template<class RealType = double> class piecewise_linear_distribution
    template<class UnaryOperation>
        piecewise_linear_distribution(initializer_list<RealType> bl,
            UnaryOperation fw);
```

Each distribution requires a set of parameters. Explaining all these mathematical parameters is outside the scope of this book, but the rest of this section includes a couple of examples to explain the impact of a distribution on the generated random numbers.

Distributions are easiest to understand when you look at a graphical representation of them. For example, the following code generates one million random numbers between 1 and 99, and counts how many times a certain number is randomly chosen. The counters are stored in a map where the key is a number between 1 and 99, and the value associated with a key is the number of times that that key has been selected randomly. After the loop, the results are written to a CSV (comma-separated values) file, which can be opened in a spreadsheet application.

```
const unsigned int kStart = 1;
const unsigned int kEnd = 99;
const unsigned int kIterations = 1'000'000;

// Uniform Mersenne Twister
random_device seeder;
const auto seed = seeder.entropy() ? seeder() : time(nullptr);
mt19937 eng(static_cast<mt19937::result_type>(seed));
uniform_int_distribution<int> dist(kStart, kEnd);
auto gen = bind(dist, eng);
map<int, int> m;
for (unsigned int i = 0; i < kIterations; ++i) {
    int rnd = gen();
    // Search map for a key = rnd. If found, add 1 to the value associated
    // with that key. If not found, add the key to the map with value 1.
    ++(m[rnd]);
}

// Write to a CSV file
ofstream of("res.csv");
for (unsigned int i = kStart; i <= kEnd; ++i) {
    of << i << "," << m[i] << endl;
}
}
```

The resulting data can then be used to generate a graphical representation. The graph of the preceding uniform Mersenne twister is shown in Figure 20-1.

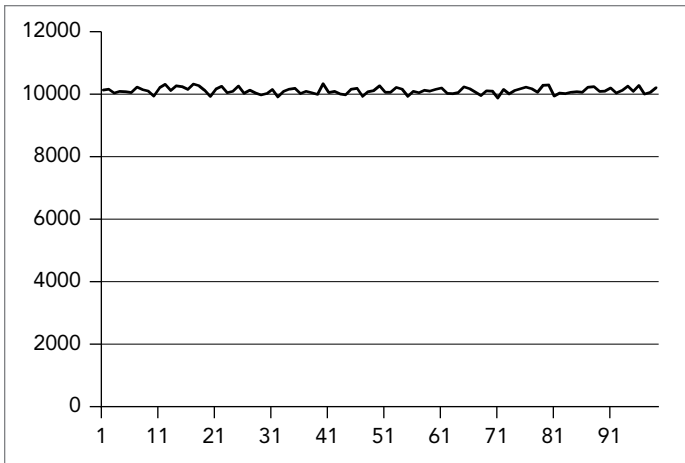

FIGURE 20-1

The horizontal axis represents the range in which random numbers are generated. The graph clearly shows that all numbers in the range 1 to 99 are randomly chosen around 10,000 times, and that the distribution of the generated random numbers is uniform across the entire range.

The example can be modified to generate random numbers according to a normal distribution instead of a uniform distribution. Only two small changes are required. First, you need to modify the creation of the distribution as follows:

```
normal_distribution<double> dist(50, 10);
```

Because normal distributions use `doubles` instead of integers, you also need to modify the call to `gen()`:

```
int rnd = static_cast<int>(gen());
```

Figure 20-2 shows a graphical representation of the random numbers generated according to this normal distribution.

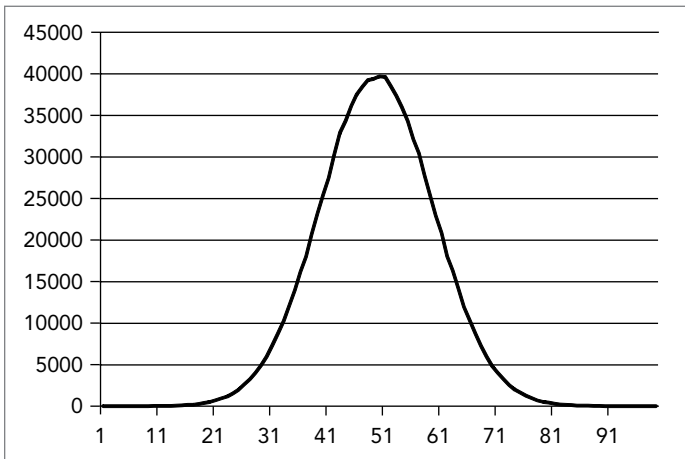

FIGURE 20-2

The graph clearly shows that most of the generated random numbers are around the center of the range. In this example, the value 50 is randomly chosen around 40,000 times, while values like 20 and 80 are chosen only around 500 times.

C++17

OPTIONAL

`std::optional`, defined in `<optional>`, holds a value of a specific type, or nothing. It can be used for parameters of a function if you want to allow for values to be optional. It is also often used as a return type from a function if the function can either return something or not. This removes the need to return “special” values from functions such as `nullptr`, `end()`, `-1`, `EOF`, and so on. It also removes the need to write the function returning a Boolean while storing the actual value in a reference output parameter, such as `bool getData(T& dataOut)`.

Here is an example of a function returning an optional:

```
optional<int> getData(bool giveIt)
{
    if (giveIt) {
        return 42;
    }
    return nullopt; // or simply return {};
}
```

You can call this function as follows:

```
auto data1 = getData(true);
auto data2 = getData(false);
```

To determine whether or not an optional has a value, use the `has_value()` method, or simply use the optional in an if statement:

```
cout << "data1.has_value = " << data1.has_value() << endl;
if (data2) {
    cout << "data2 has a value." << endl;
}
```

If an optional has a value, you can retrieve it with `value()`, or with the dereferencing operator:

```
cout << "data1.value = " << data1.value() << endl;
cout << "data1.value = " << *data1 << endl;
```

If you call `value()` on an empty optional, a `bad_optional_access` exception is thrown.

`value_or()` can be used to return either the value of an optional, or another value when the optional is empty:

```
cout << "data2.value = " << data2.value_or(0) << endl;
```

Note that you cannot store a reference in an optional, so `optional<T&>` does not work. Instead, you can use `optional<T*>`, `optional<reference_wrapper<T>>`, or `optional<reference_wrapper<const T>>`. Remember from Chapter 17 that you can use `std::ref()` or `std::cref()` to create an `std::reference_wrapper<T>` or a `reference_wrapper<const T>` respectively.

VARIANT

`std::variant`, defined in `<variant>`, can hold a single value of one of a given set of types. When you define a `variant`, you have to specify the types it can potentially contain. For example, the following code defines a `variant` that can contain an integer, a string, or a floating point value, one at a time:

```
variant<int, string, float> v;
```

This default-constructed `variant` contains a default-constructed value of its first type, `int` in this case. If you want to be able to default construct a `variant`, you have to make sure that the first type of the `variant` is default constructible. For example, the following does not compile because `Foo` is not default constructible.

```
class Foo { public: Foo() = delete; Foo(int) {} };
class Bar { public: Bar() = delete; Bar(int) {} };

int main()
{
    variant<Foo, Bar> v;
}
```

In fact, neither `Foo` nor `Bar` are default constructible. If you still want to be able to default construct such a `variant`, then you can use `std::monostate`, an empty alternative, as first type of the `variant`:

```
variant<monostate, Foo, Bar> v;
```

You can use the assignment operator to store something in a `variant`:

```
variant<int, string, float> v;
v = 12;
v = 12.5f;
v = "An std::string"s;
```

A `variant` can only contain one value at any given time. So, with these three lines of code, first the integer 12 is stored in the `variant`, then the `variant` is modified to contain a single floating-point value, and lastly, the `variant` is modified again to contain a single `string` value.

You can use the `index()` method to query the index of the value's type that is currently stored in the `variant`. The `std::holds_alternative()` function template can be used to figure out whether or not a `variant` currently contains a value of a certain type:

```
cout << "Type index: " << v.index() << endl;
cout << "Contains an int: " << holds_alternative<int>(v) << endl;
```

The output is as follows:

```
Type index: 1
Contains an int: 0
```

Use `std::get<index>()` or `std::get<T>()` to retrieve the value from a `variant`. These functions throw a `bad_variant_access` exception if you are using the index of a type, or a type, that does not match the current value in the `variant`:

```
cout << std::get<string>(v) << endl;
try {
```



```

    cout << std::get<0>(v) << endl;
} catch (const bad_variant_access& ex) {
    cout << "Exception: " << ex.what() << endl;
}

```

This is the output:

```

An std::string
Exception: bad variant access

```

To avoid exceptions, use the `std::get_if<index>()` or `std::get_if<T>()` helper functions. These functions accept a pointer to a variant, and return a pointer to the requested value, or `nullptr` on error:

```

string* theString = std::get_if<string>(&v);
int* theInt = std::get_if<int>(&v);
cout << "retrieved string: " << (theString ? *theString : "null") << endl;
cout << "retrieved int: " << (theInt ? *theInt : 0) << endl;

```

Here is the output:

```

retrieved string: An std::string
retrieved int: 0

```

There is an `std::visit()` helper function that you can use to apply the visitor pattern to a variant. Suppose you have the following class that defines a number of overloaded function call operators, one for each possible type in the variant:

```

class MyVisitor
{
public:
    void operator()(int i) { cout << "int " << i << endl; }
    void operator()(const string& s) { cout << "string " << s << endl; }
    void operator()(float f) { cout << "float " << f << endl; }
};

```

You can use this with `std::visit()` as follows.

```

visit(MyVisitor(), v);

```

The result is that the appropriate overloaded function call operator is called based on the current value stored in the variant. The output for this example is:

```

string An std::string

```

As with `optional`, you cannot store references in a variant. You can either store pointers, or store instances of `reference_wrapper<T>` or `reference_wrapper<const T>`.

ANY

`std::any`, defined in `<any>`, is a class that can contain a single value of any type. Once it is constructed, you can ask an `any` instance whether or not it contains a value, and what the type of the contained value is. To get access to the contained value, you need to use `any_cast()`, which throws an exception of type `bad_any_cast` in case of failure. Here is an example:

```

any empty;
any anInt(3);
any aString("An std::string.");

```

```

cout << "empty.has_value = " << empty.has_value() << endl;
cout << "anInt.has_value = " << anInt.has_value() << endl << endl;

cout << "anInt wrapped type = " << anInt.type().name() << endl;
cout << "aString wrapped type = " << aString.type().name() << endl << endl;

int theInt = any_cast<int>(anInt);
cout << theInt << endl;
try {
    int test = any_cast<int>(aString);
    cout << test << endl;
} catch (const bad_any_cast& ex) {
    cout << "Exception: " << ex.what() << endl;
}

```

The output is as follows. Note that the wrapped type of `aString` is compiler dependent.

```

empty.has_value = 0
anInt.has_value = 1

anInt wrapped type = int
aString wrapped type = class std::basic_string<char,struct std::char_
traits<char>,class std::allocator<char> >

3
Exception: Bad any_cast

```

You can assign a new value to an `any` instance, and even assign a new value of a different type:

```

any something(3); // Now it contains an integer.
something = "An std::string"s; // Now the same instance contains a string.

```

Instances of `any` can be stored in Standard Library containers. This allows you to have heterogeneous data in a single container. The only downside is that you have to perform explicit `any_casts` to retrieve specific values, as in this example:

```

vector<any> v;
v.push_back(any(42));
v.push_back(any("An std::string"s));

cout << any_cast<string>(v[1]) << endl;

```

As with `optional` and `variant`, you cannot store references in an `any` instance. You can either store pointers, or store instances of `reference_wrapper<T>` or `reference_wrapper<const T>`.

TUPLES

The `std::pair` class, defined in `<utility>` and introduced in Chapter 17, can store exactly two values, each with a specific type. The type of each value should be known at compile time. Here is a short example:

```

pair<int, string> p1(16, "Hello World");
pair<bool, float> p2(true, 0.123f);

```

```
cout << "p1 = (" << p1.first << ", " << p1.second << ")" << endl;
cout << "p2 = (" << p2.first << ", " << p2.second << ")" << endl;
```

The output is as follows:

```
p1 = (16, Hello World)
p2 = (1, 0.123)
```

An `std::tuple`, defined in `<tuple>`, is a generalization of a `pair`. It allows you to store any number of values, each with its own specific type. Just like a `pair`, a `tuple` has a fixed size and fixed value types, which are determined at compile time.

A `tuple` can be created with a `tuple` constructor, specifying both the template types and the actual values. For example, the following code creates a `tuple` where the first element is an integer, the second element a `string`, and the last element a `Boolean`:

```
using MyTuple = tuple<int, string, bool>;
MyTuple t1(16, "Test", true);
```

`std::get<i>()` is used to get the *i*th element from a `tuple`, where *i* is a 0-based index; that is, `<0>` is the first element of the `tuple`, `<1>` is the second element of the `tuple`, and so on. The value returned has the correct type for that index in the `tuple`:

```
cout << "t1 = (" << get<0>(t1) << ", " << get<1>(t1)
    << ", " << get<2>(t1) << ")" << endl;
// Outputs: t1 = (16, Test, 1)
```

You can check that `get<i>()` returns the correct type by using `typeid()`, from the `<typeinfo>` header. The output of the following code says that the value returned by `get<1>(t1)` is indeed an `std::string`:

```
cout << "Type of get<1>(t1) = " << typeid(get<1>(t1)).name() << endl;
// Outputs: Type of get<1>(t1) = class std::basic_string<char,
//          struct std::char_traits<char>,class std::allocator<char> >
```

NOTE *The exact string returned by `typeid()` is compiler dependent. The preceding output is from Visual C++ 2017.*

You can also retrieve an element from a `tuple` based on its type with `std::get<T>()`, where `T` is the type of the element you want to retrieve instead of the index. The compiler generates an error if the `tuple` has several elements with the requested type. For example, you can retrieve the `string` element from `t1` as follows:

```
cout << "String = " << get<string>(t1) << endl;
// Outputs: String = Test
```

Iterating over the values of a `tuple` is unfortunately not straightforward. You cannot write a simple loop and call something like `get<i>(mytuple)` because the value of *i* must be known at compile time. A possible solution is to use template metaprogramming, which is discussed in detail in Chapter 22, together with an example on how to print `tuple` values.

The size of a tuple can be queried with the `std::tuple_size` template. Note that `tuple_size` requires you to specify the type of the tuple (`MyTuple` in this case) and not an actual tuple instance like `t1`:

```
cout << "Tuple Size = " << tuple_size<MyTuple>::value << endl;
// Outputs: Tuple Size = 3
```

If you don't know the exact tuple type, you can always use `decltype()` as follows:

```
cout << "Tuple Size = " << tuple_size<decltype(t1)>::value << endl;
// Outputs: Tuple Size = 3
```

C++17

With C++17's template argument deduction for constructors, you can omit the template type parameters when constructing a tuple, and let the compiler deduce them automatically based on the type of arguments passed to the constructor. For example, the following defines the same `t1` tuple consisting of an integer, a string, and a Boolean. Note that you now have to specify "Test"s to make sure it's an `std::string`.

```
std::tuple t1(16, "Test"s, true);
```

Because of the automatic deduction of types, you cannot use `&` to specify a reference. If you want to use template argument deduction for constructors to generate a tuple containing a reference or a constant reference, then you need to use `ref()` or `cref()`, respectively, as is demonstrated in the following example. The `ref()` and `cref()` utility functions are defined in the `<functional>` header file. For example, the following construction results in a tuple of type `tuple<int, double&, const double&, string&>`:

```
double d = 3.14;
string str1 = "Test";
std::tuple t2(16, ref(d), cref(d), ref(str1));
```

To test the double reference in the `t2` tuple, the following code first writes the value of the double variable to the console. The call to `get<1>(t2)` returns a reference to `d` because `ref(d)` was used for the second (index 1) tuple element. The second line changes the value of the variable referenced, and the last line shows that the value of `d` is indeed changed through the reference stored in the tuple. Note that the third line fails to compile because `cref(d)` was used for the third tuple element, that is, it is a constant reference to `d`.

```
cout << "d = " << d << endl;
get<1>(t2) *= 2;
//get<2>(t2) *= 2; // ERROR because of cref()
cout << "d = " << d << endl;
// Outputs: d = 3.14
//           d = 6.28
```

Without C++17's template argument deduction for constructors, you can use the `std::make_tuple()` utility function to create a tuple. This helper function template also allows you to create a tuple by only specifying the actual values. The types are deduced automatically at compile time. For example:

```
auto t2 = std::make_tuple(16, ref(d), cref(d), ref(str1));
```

Decompose Tuples

There are two ways in which you can decompose a `tuple` into its individual elements: structured bindings (C++17) and `std::tie()`.

C++17

Structured Bindings

Structured bindings, introduced in C++17, make it very easy to decompose a `tuple` into separate variables. For example, the following code defines a `tuple` consisting of an integer, a string, and a Boolean value, and then uses a structured binding to decompose it into three distinct variables:

```
tuple t1(16, "Test"s, true);
auto[i, str, b] = t1;
cout << "Decomposed: i = "
      << i << ", str = \"" << str << "\", b = " << b << endl;
```

With structured bindings, you cannot ignore specific elements while decomposing. If your `tuple` has three elements, then your structured binding needs three variables. If you want to ignore elements, then you have to use `tie()`, explained next.

tie

If you want to decompose a `tuple` without structured bindings, you can use the `std::tie()` utility function, which generates a `tuple` of references. The following example first creates a `tuple` consisting of an integer, a string, and a Boolean value. It then creates three variables—an integer, a string, and a Boolean—and writes the values of those variables to the console. The `tie(i, str, b)` call creates a `tuple` containing a reference to `i`, a reference to `str`, and a reference to `b`. The assignment operator is used to assign `tuple t1` to the result of `tie()`. Because the result of `tie()` is a `tuple` of references, the assignment actually changes the values in the three separate variables, as is shown by the output of the values after the assignment.

```
tuple<int, string, bool> t1(16, "Test", true);
int i = 0;
string str;
bool b = false;
cout << "Before: i = " << i << ", str = \"" << str << "\", b = " << b << endl;
tie(i, str, b) = t1;
cout << "After: i = " << i << ", str = \"" << str << "\", b = " << b << endl;
```

The result is as follows:

```
Before: i = 0, str = "", b = 0
After: i = 16, str = "Test", b = 1
```

With `tie()` you can ignore certain elements that you do not want to be decomposed. Instead of a variable name for the decomposed value, you use the special `std::ignore` value. Here is the previous example, but now the string element of the `tuple` is ignored in the call to `tie()`:

```
tuple<int, string, bool> t1(16, "Test", true);
int i = 0;
bool b = false;
```

```
cout << "Before: i = " << i << ", b = " << b << endl;
tie(i, std::ignore, b) = t1;
cout << "After: i = " << i << ", b = " << b << endl;
```

Here is the new output:

```
Before: i = 0, b = 0
After: i = 16, b = 1
```

Concatenation

You can use `std::tuple_cat()` to concatenate two tuples into one tuple. In the following example, the type of `t3` is `tuple<int, string, bool, double, string>`:

```
tuple<int, string, bool> t1(16, "Test", true);
tuple<double, string> t2(3.14, "string 2");
auto t3 = tuple_cat(t1, t2);
```

Comparisons

Tuples also support the following comparison operators: `==`, `!=`, `<`, `>`, `<=`, and `>=`. For the comparison operators to work, the element types stored in the tuple should support them as well. Here is an example:

```
tuple<int, string> t1(123, "def");
tuple<int, string> t2(123, "abc");
if (t1 < t2) {
    cout << "t1 < t2" << endl;
} else {
    cout << "t1 >= t2" << endl;
}
```

The output is as follows:

```
t1 >= t2
```

Tuple comparisons can be used to easily implement lexicographical comparison operators for custom types that have several data members. For example, suppose you have a simple structure with three data members:¹

```
struct Foo
{
    int mInt;
    string mStr;
    bool mBool;
};
```

¹Of course, in production-quality code, you should have private data members with public getters and possibly public setters. A public struct is used in this example to keep the code compact and to the point.

Implementing a correct `operator<` for `Foo` is not trivial! However, using `std::tie()` and tuple comparisons, this becomes a simple one-liner:

```
bool operator<(const Foo& f1, const Foo& f2)
{
    return tie(f1.mInt, f1.mStr, f1.mBool) <
           tie(f2.mInt, f2.mStr, f2.mBool);
}
```

Here is an example of its use:

```
Foo f1{ 42, "Hello", 0 };
Foo f2{ 32, "World", 0 };
cout << (f1 < f2) << endl;
cout << (f2 < f1) << endl;
```

C++17

make_from_tuple

`std::make_from_tuple()` constructs an object of a given type `T`, passing the elements of a given tuple as arguments to the constructor of `T`. For example, suppose you have the following class:

```
class Foo
{
public:
    Foo(string str, int i) : mStr(str), mInt(i) {}
private:
    string mStr;
    int mInt;
};
```

You can use `make_from_tuple()` as follows:

```
auto myTuple = make_tuple("Hello world.", 42);
auto foo = make_from_tuple<Foo>(myTuple);
```

The argument given to `make_from_tuple()` does not have to be a tuple, but it has to be something that supports `std::get<>()` and `std::tuple_size`. Both `std::array` and `std::pair` satisfy these requirements as well.

This function is not that practical for everyday use, but it comes in handy when writing very generic code using templates and template metaprogramming.

C++17

apply

`std::apply()` calls a given callable (function, lambda expression, function object, and so on), passing the elements of a given tuple as arguments. Here is an example:

```
int add(int a, int b) { return a + b; }
...
cout << apply(add, std::make_tuple(39, 3)) << endl;
```

As with `make_from_tuple()`, this function is also meant more for use with generic code using templates and template metaprogramming, than for everyday use.

C++17

FILESYSTEM SUPPORT LIBRARY

C++17 introduces a filesystem support library. Everything is defined in the `<filesystem>` header, and lives in the `std::filesystem` namespace. It allows you to write portable code to work with the filesystem. You can use it for querying whether something is a directory or a file, iterating over the contents of a directory, manipulating paths, and retrieving information about files such as their size, extension, creation time, and so on. The two most important parts of the library—paths and directory entries—are introduced in the next sections.

Path

The basic component of the library is a path. A path can be an absolute or a relative path, and can include a filename or not. For example, the following code defines a couple of paths. Note the use of a raw string literal to avoid having to escape the backslashes.

```
path p1(LR"(D:\Foo\Bar)");
path p2(L"D:/Foo/Bar");
path p3(L"D:/Foo/Bar/MyFile.txt");
path p4(LR"..\\SomeFolder");
path p5(L"/usr/lib/X11");
```

When a path is converted to a string (for example by using the `c_str()` method), or inserted into a stream, it is converted to the native format of the system on which the code is running. For example:

```
path p1(LR"(D:\Foo\Bar)");
path p2(L"D:/Foo/Bar");
cout << p1 << endl;
cout << p2 << endl;
```

The output is as follows:

```
D:\Foo\Bar
D:\Foo\Bar
```

You can append a component to a path with the `append()` method, or with operator `/=`. A path separator is automatically included. For example:

```
path p(L"D:\\Foo");
p.append("Bar");
p /= "Bar";
cout << p << endl;
```

The output is `D:\Foo\Bar\Bar`.

You can use `concat()`, or operator `+=`, to concatenate a string to an existing path. This does not add any path separator! For example:

```
path p(L"D:\\Foo");
p.concat("Bar");
p += "Bar";
cout << p << endl;
```

The output now is `D:\FooBarBar`.

WARNING `append()` and operator `/=` automatically add a path separator, while `concat()` and operator `+=` do not.

A path supports iterators to iterate over its different components. Here is an example:

```
path p(LR"(C:\Foo\Bar)");
for (const auto& component : p) {
    cout << component << endl;
}
```

The output is as follows:

```
C:
\
Foo
Bar
```

The path interface supports operations such as `remove_filename()`, `replace_filename()`, `replace_extension()`, `root_name()`, `parent_path()`, `extension()`, `has_extension()`, `is_absolute()`, `is_relative()`, and more. Consult a Standard Library reference, see Appendix B, for a full list of all available functionality.

Directory Entry

A path just represents a directory or a file on a filesystem. A path may refer to a non-existing directory or file. If you want to query an actual directory or file on the filesystem, you need to construct a `directory_entry` from a path. This construction can fail if the given directory or file does not exist. The `directory_entry` interface supports operations like `is_directory()`, `is_regular_file()`, `is_socket()`, `is_symlink()`, `file_size()`, `last_write_time()`, and others.

The following example constructs a `directory_entry` from a path to query the size of a file:

```
path myPath(L"c:/windows/win.ini");
directory_entry dirEntry(myPath);
if (dirEntry.exists() && dirEntry.is_regular_file()) {
    cout << "File size: " << dirEntry.file_size() << endl;
}
```

Helper Functions

An entire collection of helper functions is available. For example, you can use `copy()` to copy files or directories, `create_directory()` to create a new directory on the filesystem, `exists()` to query whether or not a given directory or file exists, `file_size()` to get the size of a file, `last_write_time()` to get the time the file was last modified, `remove()` to delete a file, `temp_directory_path()` to get a directory suitable for storing temporary files, `space()` to query the available space on a filesystem, and more. Consult a Standard Library reference, see Appendix B, for a full list.

The following example prints out the capacity of a filesystem and how much space is still free:

```
space_info s = space("c:\\");
cout << "Capacity: " << s.capacity << endl;
cout << "Free: " << s.free << endl;
```

You can find more examples of these helper functions in the following section on directory iteration.

Directory Iteration

If you want to recursively iterate over all files and subdirectories in a given directory, you can use the `recursive_directory_iterator` as follows:

```
void processPath(const path& p)
{
    if (!exists(p)) {
        return;
    }

    auto begin = recursive_directory_iterator(p);
    auto end = recursive_directory_iterator();
    for (auto iter = begin; iter != end; ++iter) {
        const string spacer(iter.depth() * 2, ' ');

        auto& entry = *iter;

        if (is_regular_file(entry)) {
            cout << spacer << "File: " << entry;
            cout << " (" << file_size(entry) << " bytes)" << endl;
        } else if (is_directory(entry)) {
            std::cout << spacer << "Dir: " << entry << endl;
        }
    }
}
```

This function can be called as follows:

```
path p(LR"(D:\Foo\Bar)");
processPath(p);
```

You can also use a `directory_iterator` to iterate over the contents of a directory and implement the recursion yourself. Here is an example that does the same thing as the previous example but using a `directory_iterator` instead of a `recursive_directory_iterator`:

```
void processPath(const path& p, size_t level = 0)
{
    if (!exists(p)) {
        return;
    }

    const string spacer(level * 2, ' ');

    if (is_regular_file(p)) {
        cout << spacer << "File: " << p;
        cout << " (" << file_size(p) << " bytes)" << endl;
    }
}
```

```
    } else if (is_directory(p)) {  
        std::cout << spacer << "Dir: " << p << endl;  
        for (auto& entry : directory_iterator(p)) {  
            processPath(entry, level + 1);  
        }  
    }  
}
```

SUMMARY

This chapter gave an overview of additional functionality provided by the C++ standard that did not fit naturally in other chapters. You learned how to use the `ratio` template to define compile-time rational numbers; the `chrono` library; the random number generation library; and the `optional`, `variant`, and any data types. You also learned about `tuples`, which are a generalization of `pairs`. The chapter finished with an introduction to the filesystem support library.

This chapter concludes Part 3 of the book. The next part discusses some more advanced topics and starts with a chapter showing you how to customize and extend the functionality provided by the C++ Standard Library.

PART IV

Mastering Advanced Features of C++

- ▶ CHAPTER 21: Customizing and Extending the Standard Library
- ▶ CHAPTER 22: Advanced Templates
- ▶ CHAPTER 23: Multithreaded Programming with C++

21

Customizing and Extending the Standard Library

WHAT'S IN THIS CHAPTER?

- What allocators are
- How to use stream iterators
- What iterator adaptors are, and how to use the standard iterator adaptors
- How to extend the Standard Library
 - How to write your own algorithms
 - How to write your own containers
 - How to write your own iterators

WROX.COM DOWNLOADS FOR THIS CHAPTER

Please note that all the code examples for this chapter are available as a part of this chapter's code download on the book's website at www.wrox.com/go/proc++4e on the Download Code tab.

Chapters 16, 17, and 18 show that the Standard Library contains a powerful general-purpose collection of containers and algorithms. The information covered so far should be sufficient for most applications. However, those chapters show only the basic functionality of the library. The Standard Library can be customized and extended however you like. For example, you can apply iterators to input and output streams; write your own containers, algorithms, and iterators; and even specify your own memory allocation schemes for containers to use.

This chapter provides a taste of these advanced features, primarily through the development of a `hash_map` container.

NOTE *Customizing and extending the Standard Library is rarely necessary. If you're happy with the Standard Library containers and algorithms, you can skip this chapter. However, if you really want to understand the Standard Library, not just use it, give this chapter a chance. You should be comfortable with the operator-overloading material in Chapter 15, and because this chapter uses templates extensively, you should also be comfortable with the template material from Chapter 12 before continuing!*

ALLOCATORS

Every Standard Library container takes an `Allocator` type as a template parameter, for which the default usually suffices. For example, the `vector` template definition looks like this:

```
template <class T, class Allocator = allocator<T>> class vector;
```

The container constructors then allow you to specify an object of type `Allocator`. This permits you to customize the way the containers allocate memory. Every memory allocation performed by a container is made with a call to the `allocate()` method of the `Allocator` object. Conversely, every deallocation is performed with a call to the `deallocate()` method of the `Allocator` object. The Standard Library provides a default `Allocator` class called `allocator`, which implements these methods as wrappers for `operator new` and `operator delete`.

If you want containers in your program to use a custom memory allocation and deallocation scheme, you can write your own `Allocator` class. There are several reasons for using custom allocators. For example, if the underlying allocator has unacceptable performance, there are alternatives that can be constructed. Or, if memory fragmentation is a problem (a lot of different allocations and deallocations leaving unusable, small holes in memory), a single “pool” of objects of one type can be created, called a *memory pool*. When OS-specific capabilities, such as shared memory segments, must be allocated, using custom allocators allows the use of Standard Library containers in those shared memory segments. The use of custom allocators is complex, and there are many potential problems if you are not careful, so this should not be approached lightly.

Any class that provides `allocate()`, `deallocate()`, and several other required methods and type aliases can be used in place of the default `allocator` class.

C++17

C++17 introduces the concept of *polymorphic memory allocators*. Basically, the problem with the allocator for a container being specified as a template type parameter is that two containers that are similar but have different allocator types are completely different. For example, two `vector<int>` containers with different `Allocator` template type parameters are different, and so cannot be assigned to one another.

The polymorphic memory allocators, defined in `<memory_resource>` in the `std::pmr` namespace, help to solve this problem. The class `std::pmr::polymorphic_allocator` is a proper `Allocator`

class because it satisfies all the requirements, such as having an `allocate()` and `deallocate()` method. The allocation behavior of a `polymorphic_allocator` depends on the `memory_resource` it's given during construction, and not on any template type parameters. As such, different `polymorphic_allocator`s can behave in completely different ways when allocating and deallocating memory, even though they all have the same type, that is, `polymorphic_allocator`. The standard provides some built-in memory resources that you can use to initialize a polymorphic memory allocator: `synchronized_pool_resource`, `unsynchronized_pool_resource`, and `monotonic_buffer_resource`.

However, in my experience, both custom allocators and polymorphic memory allocators are rather advanced and rarely used features. I've never used them myself, so a detailed discussion falls outside the scope of this book. For more information, consult one of the books listed in Appendix B that specifically covers the C++ Standard Library.

STREAM ITERATORS

The Standard Library provides four *stream iterators*. These are iterator-like class templates that allow you to treat input and output streams as input and output iterators. Using these stream iterators, you can adapt input and output streams so that they can serve as sources and destinations, respectively, for various Standard Library algorithms. The following stream iterators are available:

- `ostream_iterator`—an output stream iterator
- `istream_iterator`—an input stream iterator

There is also an `ostreambuf_iterator` and an `istreambuf_iterator`, but these are rarely used and are not further discussed here.

Output Stream Iterator

The `ostream_iterator` class is an *output stream iterator*. It is a class template that takes the element type as a type parameter. Its constructor takes an output stream and a delimiter string to write to the stream following each element. The `ostream_iterator` class writes elements using `operator<<`.

For example, you can use the `ostream_iterator` with the `copy()` algorithm to print the elements of a container with only one line of code. The first parameter of `copy()` is the start iterator of the range to copy, the second parameter is the end iterator of the range, and the third parameter is the destination iterator:

```
vector<int> myVector(10);
iota(begin(myVector), end(myVector), 1); // Fill vector with 1,2,3...10

// Print the contents of the vector.
copy(cbegin(myVector), cend(myVector), ostream_iterator<int>(cout, " "));
```

The output is as follows:

```
1 2 3 4 5 6 7 8 9 10
```

Input Stream Iterator

You can use the *input stream iterator*, `istream_iterator`, to read values from an input stream using the iterator abstraction. It is a class template that takes the element type as a type parameter. Elements are read using `operator>>`. You can use an `istream_iterator` as a source for algorithms and container methods.

For example, the following piece of code reads integers from the console until the end of the stream is reached. On Windows, this happens when you press Ctrl+Z followed by Enter, while on Linux you press Enter followed by Ctrl+D. The `accumulate()` algorithm is used to sum all the integers together. Note that the default constructor of `istream_iterator` creates an end iterator.

```
cout << "Enter numbers separated by white space." << endl;
cout << "Press Ctrl+Z followed by Enter to stop." << endl;
istream_iterator<int> numbersIter(cin);
istream_iterator<int> endIter;
int sum = accumulate(numbersIter, endIter, 0);
cout << "Sum: " << sum << endl;
```

Take a moment to reflect on this code. If you remove all the output statements and the variable declarations, the only line left is the call to `accumulate()`. Thanks to algorithms and input stream iterators, this single line of code reads any number of integers from the console and sums them together, without using any explicit loops.

ITERATOR ADAPTORS

The Standard Library provides three *iterator adaptors*, which are special iterators built on top of other iterators. All three are defined in the `<iterator>` header. It's also possible to write your own iterator adaptors, but this is not covered in this book. Consult one of the books on the Standard Library listed in Appendix B for details.

Reverse Iterators

The Standard Library provides an `std::reverse_iterator` class template that iterates through a bidirectional or random access iterator in a reverse direction. Every reversible container in the Standard Library, which happens to be every container that's part of the standard except `forward_list` and the unordered associative containers, supplies a `reverse_iterator` type alias and methods called `rbegin()` and `rend()`. These `reverse_iterator` type aliases are of type `std::reverse_iterator<T>` with `T` equal to the iterator type alias of the container. The method `rbegin()` returns a `reverse_iterator` pointing to the last element of the container, and `rend()` returns a `reverse_iterator` pointing to the element before the first element of the container. Applying `operator++` to a `reverse_iterator` calls `operator--` on the underlying container iterator, and vice versa. For example, iterating over a collection from the beginning to the end can be done as follows:

```
for (auto iter = begin(collection); iter != end(collection); ++iter) {}
```

Iterating over the elements in the collection from the end to the beginning can be done using a `reverse_iterator` by calling `rbegin()` and `rend()`. Note that you still call `++iter`:

```
for (auto iter = rbegin(collection); iter != rend(collection); ++iter) {}
```

An `std::reverse_iterator` is useful mostly with algorithms in the Standard Library that have no equivalents that work in reverse order. For example, the basic `find()` algorithm searches for the first element in a sequence. If you want to find the last element in the sequence, you can use a `reverse_iterator` instead. Note that when you call an algorithm such as `find()` with a `reverse_iterator`, it returns a `reverse_iterator` as well. You can always obtain the underlying iterator from a `reverse_iterator` by calling the `base()` method on the `reverse_iterator`. However, due to the implementation details of `reverse_iterator`, the iterator returned from `base()` always refers to one element past the element referred to by the `reverse_iterator` on which it's called. In order to get to the same element, you must subtract one.

Here is an example of `find()` with a `reverse_iterator`:

```
// The implementation of populateContainer() is identical to that shown in
// Chapter 18, so it is omitted here.

vector<int> myVector;
populateContainer(myVector);

int num;
cout << "Enter a number to find: ";
cin >> num;

auto it1 = find(begin(myVector), end(myVector), num);
auto it2 = find(rbegin(myVector), rend(myVector), num);
if (it1 != end(myVector)) {
    cout << "Found " << num << " at position " << it1 - begin(myVector)
        << " going forward." << endl;
    cout << "Found " << num << " at position "
        << it2.base() - 1 - begin(myVector) << " going backward." << endl;
} else {
    cout << "Failed to find " << num << endl;
}
```

A possible output of this program is as follows:

```
Enter a number (0 to quit): 11
Enter a number (0 to quit): 22
Enter a number (0 to quit): 33
Enter a number (0 to quit): 22
Enter a number (0 to quit): 11
Enter a number (0 to quit): 0
Enter a number to find: 22
Found 22 at position 1 going forward.
Found 22 at position 3 going backward.
```

Insert Iterators

As Chapter 18 mentions, algorithms like `copy()` don't insert elements into a container; they simply replace old elements in a range with new ones. In order to make algorithms like `copy()` more useful, the Standard Library provides three *insert iterator adaptors* that actually insert elements into a container: `insert_iterator`, `back_insert_iterator`, and `front_insert_iterator`. They are all templated on a container type, and take the actual container reference in their constructor. Because they supply the necessary iterator interfaces, these adaptors can be used as the destination

iterators of algorithms like `copy()`. However, instead of replacing elements in the container, they make calls on their container to actually insert new elements.

The basic `insert_iterator` calls `insert(position, element)` on the container, the `back_insert_iterator` calls `push_back(element)`, and the `front_insert_iterator` calls `push_front(element)`.

The following example uses a `back_insert_iterator` with the `copy_if()` algorithm to populate `vectorTwo` with all elements from `vectorOne` that are not equal to 100:

```
vector<int> vectorOne, vectorTwo;
populateContainer(vectorOne);

back_insert_iterator<vector<int>> inserter(vectorTwo);
copy_if(cbegin(vectorOne), cend(vectorOne), inserter,
        [](int i){ return i != 100; });

copy(cbegin(vectorTwo), cend(vectorTwo), ostream_iterator<int>(cout, " "));
```

As you can see, when you use insert iterators, you don't need to size the destination containers ahead of time.

You can also use the `std::back_inserter()` utility function to create a `back_insert_iterator`. In the previous example, you can remove the line that defines the `inserter` variable, and rewrite the `copy_if()` call as follows. The result is exactly the same as the previous implementation:

```
copy_if(cbegin(vectorOne), cend(vectorOne),
        back_inserter(vectorTwo), [](int i){ return i != 100; });
```

With C++17's template argument deduction for constructors, this can also be written as follows:

```
copy_if(cbegin(vectorOne), cend(vectorOne),
        back_insert_iterator(vectorTwo), [](int i) { return i != 100; });
```

The `front_insert_iterator` and `insert_iterator` work similarly, except that the `insert_iterator` also takes an initial iterator position in its constructor, which it passes to the first call to `insert(position, element)`. Subsequent iterator position hints are generated based on the return value from each `insert()` call.

One benefit of using an `insert_iterator` is that it allows you to use associative containers as destinations of the modifying algorithms. Chapter 18 explains that the problem with associative containers is that you are not allowed to modify the elements over which you iterate. By using an `insert_iterator`, you can instead insert elements. Associative containers actually support a form of `insert()` that takes an iterator position, and are supposed to use the position as a "hint," which they can ignore. When you use an `insert_iterator` on an associative container, you can pass the `begin()` or `end()` iterator of the container to use as the hint. The `insert_iterator` modifies the iterator hint that it passes to `insert()` after each call to `insert()`, such that the position is one past the just-inserted element.

Here is the previous example modified so that the destination container is a set instead of a vector:

```
vector<int> vectorOne;
set<int> setOne;
```

```

populateContainer(vectorOne);

insert_iterator<set<int>> inserter(setOne, begin(setOne));
copy_if(cbegin(vectorOne), cend(vectorOne), inserter,
        [](int i){ return i != 100; });

copy(cbegin(setOne), cend(setOne), ostream_iterator<int>(cout, " "));

```

Similar to the `back_insert_iterator` example, you can use the `std::inserter()` utility function to create an `insert_iterator`:

```

copy_if(cbegin(vectorOne), cend(vectorOne),
        inserter(setOne, begin(setOne)),
        [](int i){ return i != 100; });

```

Or, you can use C++17's template argument deduction for constructors:

```

copy_if(cbegin(vectorOne), cend(vectorOne),
        insert_iterator(setOne, begin(setOne)),
        [](int i) { return i != 100; });

```

Move Iterators

Chapter 9 discusses *move semantics*, which can be used to prevent unnecessary copying in cases where you know that the source object will be destroyed after an assignment operation or copy construction. There is an iterator adaptor called `std::move_iterator`. The dereferencing operator for a `move_iterator` automatically converts the value to an *rvalue reference*, which means that the value can be moved to a new destination without the overhead of copying. Before you can use move semantics, you need to make sure your objects are supporting it. The following `MoveableClass` supports move semantics. For more details, see Chapter 9.

```

class MoveableClass
{
public:
    MoveableClass() {
        cout << "Default constructor" << endl;
    }
    MoveableClass(const MoveableClass& src) {
        cout << "Copy constructor" << endl;
    }
    MoveableClass(MoveableClass&& src) noexcept {
        cout << "Move constructor" << endl;
    }
    MoveableClass& operator=(const MoveableClass& rhs) {
        cout << "Copy assignment operator" << endl;
        return *this;
    }
    MoveableClass& operator=(MoveableClass&& rhs) noexcept {
        cout << "Move assignment operator" << endl;
        return *this;
    }
};

```

EXTENDING THE STANDARD LIBRARY

The Standard Library includes many useful containers, algorithms, and iterators that you can use in your applications. It is impossible, however, for any library to include all possible utilities that all potential clients might need. Thus, the best libraries are extensible: they allow clients to adapt and add to the basic capabilities to obtain exactly the functionality they require. The Standard Library is inherently extensible because of its fundamental structure of separating data from the algorithms that operate on them. You can write your own containers that can work with the Standard Library algorithms by providing iterators that conforms to the Standard Library guidelines. Similarly, you can write your own algorithms that work with iterators from the standard containers. Note that you are not allowed to put your own containers and algorithms in the `std` namespace.

Why Extend the Standard Library?

If you sit down to write an algorithm or container in C++, you can either make it adhere to the Standard Library conventions or not. For simple containers and algorithms, it might not be worth the extra effort to follow the Standard Library requirements. However, for substantial code that you plan to reuse, the effort pays off. First, the code will be easier for other C++ programmers to understand, because you follow well-established interface guidelines. Second, you will be able to use your container or algorithm with the other parts of the Standard Library (algorithms or containers) without needing to provide special hacks or adaptors. Finally, it will force you to employ the necessary rigor required to develop solid code.

Writing a Standard Library Algorithm

Chapter 18 describes a useful set of algorithms that are part of the Standard Library, but you will inevitably encounter situations in your programs for which you need new algorithms. When that happens, it is usually not difficult to write your own algorithm that works with Standard Library iterators just like the standard algorithms.

`find_all()`

Suppose that you want to find all the elements matching a predicate in a given range. The `find()` and `find_if()` algorithms are the most likely candidates, but each returns an iterator referring to only one element. You can use `copy_if()` to find all elements matching a given predicate, but it fills the output with copies of the found elements. If you want to avoid copies, you can use `copy_if()` with a `back_insert_iterator` into a `vector<reference_wrapper<T>>`, but this does not give you the position of the found elements. In fact, there is no standard algorithm to get iterators to all the elements matching a predicate. However, you can write your own version of this functionality called `find_all()`.

The first task is to define the function prototype. You can follow the model established by `copy_if()`, that is, a function template with three template type parameters: the input iterator type, the output iterator type, and the predicate type. The arguments of the function are start and end iterators of the input sequence, a start iterator of the output sequence, and a predicate object. As with

`copy_if()`, the algorithm returns an iterator into the output sequence that is one-past-the-last element stored in the output sequence. Here is the prototype:

```
template <typename InputIterator, typename OutputIterator, typename Predicate>
OutputIterator find_all(InputIterator first, InputIterator last,
                      OutputIterator dest, Predicate pred);
```

Another option would be to omit the output iterator, and to return an iterator into the input sequence that iterates over all the matching elements in the input sequence. This would require you to write your own iterator class, which is discussed later in this chapter.

The next task is to write the implementation. The `find_all()` algorithm iterates over all elements in the input sequence, calls the predicate on each element, and stores iterators of matching elements in the output sequence. Here is the implementation:

```
template <typename InputIterator, typename OutputIterator, typename Predicate>
OutputIterator find_all(InputIterator first, InputIterator last,
                      OutputIterator dest, Predicate pred)
{
    while (first != last) {
        if (pred(*first)) {
            *dest = first;
            ++dest;
        }
        ++first;
    }
    return dest;
}
```

Similar to `copy_if()`, the algorithm only overwrites existing elements in the output sequence, so make sure the output sequence is large enough to hold the result, or use an iterator adaptor such as `back_insert_iterator`, as demonstrated in the following code. After finding all matching elements, the code counts the number of elements found, which is the number of iterators in `matches`. Then, it iterates through the result, printing each element.

```
vector<int> vec{ 3, 4, 5, 4, 5, 6, 5, 8 };
vector<vector<int>::iterator> matches;

find_all(begin(vec), end(vec), back_inserter(matches),
        [](int i){ return i == 5; });

cout << "Found " << matches.size() << " matching elements: " << endl;
for (const auto& it : matches) {
    cout << *it << " at position " << (it - cbegin(vec)) << endl;;
}
```

The output is as follows:

```
Found 3 matching elements:
5 at position 2
5 at position 4
5 at position 6
```

Iterator Traits

Some algorithm implementations need additional information about their iterators. For example, they might need to know the type of the elements referred to by the iterator in order to store temporary values, or perhaps they want to know whether the iterator is bidirectional or random access.

C++ provides a class template called `iterator_traits` that allows you to find this information. You instantiate the `iterator_traits` class template with the iterator type of interest, and access one of five type aliases: `value_type`, `difference_type`, `iterator_category`, `pointer`, or `reference`. For example, the following function template declares a temporary variable of the type that an iterator of type `IteratorType` refers to. Note the use of the `typename` keyword in front of the `iterator_traits` line. You must specify `typename` explicitly whenever you access a type based on one or more template parameters. In this case, the template parameter `IteratorType` is used to access the `value_type` type.

```
#include <iterator>

template <typename IteratorType>
void iteratorTraitsTest(IteratorType it)
{
    typename std::iterator_traits<IteratorType>::value_type temp;
    temp = *it;
    cout << temp << endl;
}
```

This function can be tested with the following code:

```
vector<int> v{ 5 };
iteratorTraitsTest(cbegin(v));
```

With this code, the variable `temp` in `iteratorTraitsTest()` is of type `int`. The output is 5.

In this example, the `auto` keyword could be used to simplify the code, but that wouldn't show you how to use `iterator_traits`.

Writing a Standard Library Container

The C++ standard contains a list of requirements that any container must fulfill in order to qualify as a Standard Library container.

Additionally, if you want your container to be sequential (like a `vector`), ordered associative (like a `map`), or unordered associative (like an `unordered_map`), it must conform to supplementary requirements.

My suggestion when writing a new container is to write the basic container first, following the general Standard Library rules such as making it a class template, but without worrying too much yet about the specific details of Standard Library conformity. After you've developed the basic implementation, you can add the iterator and methods so that it can work with the Standard Library framework. This chapter takes that approach to develop a *hash map*.

WARNING *It is recommended to use the standard C++ unordered associative containers, also called hash tables, instead of implementing your own. These unordered associative containers, explained in Chapter 17, are called `unordered_map`, `unordered_multimap`, `unordered_set`, and `unordered_multiset`. The `hash_map` in this chapter is only used to demonstrate writing Standard Library containers.*

A Basic Hash Map

C++11 added support for hash tables, which are discussed in Chapter 17. However, pre-C++11 did not include hash tables. Unlike the Standard Library `map` and `set`, which provide logarithmic insertion, lookup, and deletion times, a hash table provides constant time insertion, deletion, and lookup in the average case, linear in the worst case. Instead of storing elements in sorted order, a hash table *hashes*, or maps, each element to a particular *bucket*. As long as the number of elements stored isn't significantly greater than the number of buckets, and the *hash function* distributes the elements uniformly between the buckets, the insertion, deletion, and lookup operations all run in constant time.

NOTE *This section assumes that you are familiar with hashed data structures. If you are not, consult Chapter 17, which includes a discussion on hash tables, or one of the standard data structure texts listed in Appendix B.*

This section implements a simple, but fully functional, `hash_map`. Like a `map`, a `hash_map` stores key/value pairs. In fact, the operations it provides are almost identical to those provided by the `map`, but with different performance characteristics.

This `hash_map` implementation uses chained hashing (also called open hashing), and does not attempt to provide advanced features such as rehashing. Chapter 17 explains the concept of chained hashing in the section on unordered associative containers.

The Hash Function

The first choice when writing a `hash_map` is how to handle hash functions. Recalling the adage that a good abstraction makes the easy case easy and the hard case possible, a good `hash_map` interface allows clients to specify their own hash function and number of buckets in order to customize the hashing behavior for their particular workload. On the other hand, clients that do not have the desire, or ability, to write a good hash function and choose a number of buckets should still be able to use the container without doing so. One solution is to allow clients to provide a hash function and number of buckets in the `hash_map` constructor, but also to provide default values. In this implementation, the hash function is a simple function object containing just a single function call operator. The function object is templated on the key type that it hashes in order to support a templated `hash_map` container. Template specialization can be used to write custom hash functions for certain types. Here is the basic `hash` function object:

```
template <typename T>
class hash
{
```



```

    public:
        size_t operator()(const T& key) const;
};

```

Note that everything for the `hash_map` implementation is inside a `ProCpp` namespace so that names don't clash with already existing names. The implementation of the `hash` function call operator is tricky because it must apply to keys of any type. The following implementation computes an integer-sized hash value by simply treating the key as a sequence of bytes:

```

// Calculate a hash by treating the key as a sequence
// of bytes and summing the ASCII values of the bytes.
template <typename T>
size_t hash<T>::operator()(const T& key) const
{
    const size_t bytes = sizeof(key);
    size_t sum = 0;
    for (size_t i = 0; i < bytes; ++i) {
        unsigned char b = *(reinterpret_cast<const unsigned char*>(&key) + i);
        sum += b;
    }
    return sum;
}

```

Unfortunately, when using this hashing method on `strings`, the function calculates the hash of the entire `string` object, and not just of the actual text. The actual text is probably on the heap, and the `string` object only contains a length and a pointer to the text on the heap. The pointer will be different, even if the text it refers to is the same. The result is that two `string` objects with the same text will generate different hash values. Therefore, it's a good idea to provide a specialization of the `hash` template for `strings`, and in general for any class that contains dynamically allocated memory. Template specialization is discussed in detail in Chapter 12.

```

// A hash specialization for strings
template <>
class hash<std::string>
{
    public:
        size_t operator()(const std::string& key) const;
};

// Calculate a hash by summing the ASCII values of all characters.
size_t hash<std::string>::operator()(const std::string& key) const
{
    size_t sum = 0;
    for (auto c : key) {
        sum += static_cast<unsigned char>(c);
    }
    return sum;
}

```

If you want to use other pointer types or objects as the key, you should write your own `hash` specialization for those types.

WARNING *The hash functions shown in this section are very basic. They do not guarantee uniform hashing for all key universes. If you need more mathematically rigorous hash functions, or if you don't know what uniform hashing is, consult an algorithm's reference from Appendix B.*

The Hash Map Interface

A `hash_map` supports three basic operations: insertion, deletion, and lookup. It is also swappable. Of course, it provides a constructor and destructor as well. The copy and move constructors are explicitly defaulted, and the copy and move assignment operators are provided. Here is the public portion of the `hash_map` class template:

```
template <typename Key, typename T, typename KeyEqual = std::equal_to<>,
         typename Hash = hash<Key>>
class hash_map
{
public:
    using key_type = Key;
    using mapped_type = T;
    using value_type = std::pair<const Key, T>;

    virtual ~hash_map() = default; // Virtual destructor

    // Throws invalid_argument if the number of buckets is illegal.
    explicit hash_map(const KeyEqual& equal = KeyEqual(),
                     size_t numBuckets = 101, const Hash& hash = Hash());

    // Copy constructor
    hash_map(const hash_map<Key, T, KeyEqual, Hash>& src) = default;
    // Move constructor
    hash_map(hash_map<Key, T, KeyEqual, Hash>&& src) noexcept = default;

    // Copy assignment operator
    hash_map<Key, T, KeyEqual, Hash>& operator=(
        const hash_map<Key, T, KeyEqual, Hash>& rhs);
    // Move assignment operator
    hash_map<Key, T, KeyEqual, Hash>& operator=(
        hash_map<Key, T, KeyEqual, Hash>&& rhs) noexcept;

    // Inserts the key/value pair x.
    void insert(const value_type& x);

    // Removes the element with key k, if it exists.
    void erase(const key_type& k);

    // Removes all elements.
    void clear() noexcept;
```

```

    // Find returns a pointer to the element with key k.
    // Returns nullptr if no element with that key exists.
    value_type* find(const key_type& k);
    const value_type* find(const key_type& k) const;

    // operator[] finds the element with key k, or inserts an
    // element with that key if none exists yet. Returns a reference to
    // the value corresponding to that key.
    T& operator[] (const key_type& k);

    // Swaps two hash_maps.
    void swap(hash_map<Key, T, KeyEqual, Hash>& other) noexcept;
private:
    // Implementation details not shown yet
};

```

As you can see, the key and value types are both template parameters, similar as for the Standard Library `map`. A `hash_map` stores `pair<const Key, T>` as the actual elements in the container. The `insert()`, `erase()`, `find()`, `clear()`, and `operator[]` methods are straightforward. However, a few aspects of this interface require further explanation.

The KeyEqual Template Parameter

Like a `map`, `set`, and other standard containers, a `hash_map` allows the client to specify the comparison type as a template parameter and to pass a specific comparison object of that type in the constructor. Unlike a `map` and `set`, a `hash_map` does not sort elements by key, but must still compare keys for equality. Thus, instead of using `less` as the default comparator, it uses the transparent `equal_to<>` comparator. The comparison object is used only to detect attempts to insert duplicate keys into the container.

The Hash Template Parameter

You should be able to change the hashing function to make it better suit the type of elements you want to store in the hash map. Thus, the `hash_map` template takes four template parameters: the key type, the value type, the comparator type, and the hash type.

The Type Aliases

The `hash_map` class template defines three type aliases:

```

using key_type = Key;
using mapped_type = T;
using value_type = std::pair<const Key, T>;

```

The `value_type`, in particular, is useful for referring to the more cumbersome `pair<const Key, T>` type. As you will see, these type aliases are required to satisfy the Standard Library container requirements.

The Implementation

After you finalize the `hash_map` interface, you need to choose the implementation model. The basic hash table structure generally consists of a fixed number of buckets, each of which can store one or more elements. The buckets should be accessible in constant time based on a bucket-id (the result of hashing a key). Thus, a `vector` is the most appropriate container for the buckets. Each bucket must

store a list of elements, so the Standard Library `list` can be used as the bucket type. Thus, the final structure is a vector of lists of `pair<const Key, T>` elements.¹ Here are the private members of the `hash_map` class:

```
private:
    using ListType = std::list<value_type>;
    std::vector<ListType> mBuckets;
    size_t mSize = 0;
    KeyEqual mEqual;
    Hash mHash;
```

Without the type aliases for `value_type` and `ListType`, the line declaring `mBuckets` would look like this:

```
std::vector<std::list<std::pair<const Key, T>>> mBuckets;
```

The `mEqual` and `mHash` members store the comparison and hashing objects, respectively, and `mSize` stores the number of elements currently in the container.

The Constructor

The constructor initializes all the fields. It constructs `mBuckets` with the correct number of buckets. Unfortunately, the template syntax is somewhat dense. If the syntax confuses you, consult Chapter 12 for details on writing class templates.

```
// Construct mBuckets with the correct number of buckets.
template <typename Key, typename T, typename KeyEqual, typename Hash>
hash_map<Key, T, KeyEqual, Hash>::hash_map(
    const KeyEqual& equal, size_t numBuckets, const Hash& hash)
    : mBuckets(numBuckets), mEqual(equal), mHash(hash)
{
    if (numBuckets == 0) {
        throw std::invalid_argument("Number of buckets must be positive");
    }
}
```

The implementation requires at least one bucket, so the constructor enforces that restriction.

Searching Elements

Each of the three major operations (lookup, insertion, and deletion) requires code to find an element with a given key. Thus, it is helpful to have a `private` helper method that performs that task. `findElement()` first uses the hash object to calculate the hash of the key and limits the calculated hash value to the number of hash buckets by taking the modulo of the calculated value. Then, it searches all the elements in that bucket for an element with a key matching the given key. The elements stored are `key/value` pairs, so the actual comparison must be done on the first field of the element. The comparison function object specified in the constructor is used to perform the comparison.

```
template <typename Key, typename T, typename KeyEqual, typename Hash>
std::pair<
    typename hash_map<Key, T, KeyEqual, Hash>::ListType::iterator, size_t>
    hash_map<Key, T, KeyEqual, Hash>::findElement(const key_type& k)
{
```

¹Because of the `const Key` in the `pair<const Key, T>` elements stored in the list, you cannot use a vector instead of a list in this case.

```

    // Hash the key to get the bucket.
    size_t bucket = mHash(k) % mBuckets.size();

    // Search for the key in the bucket.
    auto iter = find_if(begin(mBuckets[bucket]), end(mBuckets[bucket]),
        [this, &k](const auto& element) { return mEqual(element.first, k); });

    // Return a pair of the iterator and the bucket index.
    return std::make_pair(iter, bucket);
}

```

`findElement()` returns a pair containing an iterator and a bucket index. The bucket index is the index of the bucket to which the given key maps, independent of whether or not the given key is actually in the container. The returned iterator refers to an element in the bucket list, the list representing the bucket to which the key mapped. If the element is found, the iterator refers to that element; otherwise, it is the end iterator for that list.

The syntax in the function header of this method is somewhat confusing, particularly the use of the `typename` keyword. You must use the `typename` keyword whenever you are using a type that is dependent on a template parameter. Specifically, the type `ListType::iterator`, which is `list<pair<const Key, T>>::iterator`, is dependent on both the `Key` and `T` template parameters.

You can implement the `find()` method as a simple wrapper for `findElement()`:

```

template <typename Key, typename T, typename KeyEqual, typename Hash>
typename hash_map<Key, T, KeyEqual, Hash>::value_type*
    hash_map<Key, T, KeyEqual, Hash>::find(const key_type& k)
{
    // Use the findElement() helper, and C++17 structured bindings.
    auto[it, bucket] = findElement(k);
    if (it == end(mBuckets[bucket])) {
        // Element not found -- return nullptr.
        return nullptr;
    }
    // Element found -- return a pointer to it.
    return &(*it);
}

```

The `const` version of `find()` uses a `const_cast` to forward the request to the non-`const` version to avoid code duplication:

```

template <typename Key, typename T, typename KeyEqual, typename Hash>
const typename hash_map<Key, T, KeyEqual, Hash>::value_type*
    hash_map<Key, T, KeyEqual, Hash>::find(const key_type& k) const
{
    return const_cast<hash_map<Key, T, KeyEqual, Hash>*>(this)->find(k);
}

```

The operator `[]` implementation uses `findElement()` and if it does not find the element, it inserts it as follows:

```

template <typename Key, typename T, typename KeyEqual, typename Hash>
T& hash_map<Key, T, KeyEqual, Hash>::operator[] (const key_type& k)
{
    // Try to find the element. If it doesn't exist, add a new element.

```

```

    auto[it, bucket] = findElement(k);
    if (it == end(mBuckets[bucket])) {
        mSize++;
        mBuckets[bucket].push_back(std::make_pair(k, T()));
        return mBuckets[bucket].back().second;
    } else {
        return it->second;
    }
}

```

Inserting Elements

`insert()` must first check if an element with that key is already in the `hash_map`. If not, it can add the element to the list in the appropriate bucket. Note that `findElement()` returns the bucket index to which a key hashes, even if an element with that key is not found:

```

template <typename Key, typename T, typename KeyEqual, typename Hash>
void hash_map<Key, T, KeyEqual, Hash>::insert(const value_type& x)
{
    // Try to find the element.
    auto[it, bucket] = findElement(x.first);
    if (it != end(mBuckets[bucket])) {
        // The element already exists.
        return;
    } else {
        // We didn't find the element, so insert a new one.
        mSize++;
        mBuckets[bucket].push_back(x);
    }
}

```

Note that this implementation of `insert()` returns `void`, so the caller does not know whether the element was inserted or if it was already in the `hash_map`. This shortcoming is resolved later in this chapter, once iterators have been implemented for `hash_map`.

Deleting Elements

`erase()` follows the same pattern as `insert()`: It first attempts to find the element by calling `findElement()`. If the element exists, it erases it from the list in the appropriate bucket. Otherwise, it does nothing.

```

template <typename Key, typename T, typename KeyEqual, typename Hash>
void hash_map<Key, T, KeyEqual, Hash>::erase(const key_type& k)
{
    // First, try to find the element.
    auto[it, bucket] = findElement(k);
    if (it != end(mBuckets[bucket])) {
        // The element exists -- erase it.
        mBuckets[bucket].erase(it);
        mSize--;
    }
}

```

Removing All Elements

`clear()` simply clears each bucket, and sets the size of the `hash_map` to zero:

```
template <typename Key, typename T, typename KeyEqual, typename Hash>
void hash_map<Key, T, KeyEqual, Hash>::clear() noexcept
{
    // Call clear on each bucket.
    for (auto& bucket : mBuckets) {
        bucket.clear();
    }
    mSize = 0;
}
```

Swapping

The `swap()` method just swaps all data members using `std::swap()`:

```
template <typename Key, typename T, typename KeyEqual, typename Hash>
void hash_map<Key, T, KeyEqual, Hash>::swap(
    hash_map<Key, T, KeyEqual, Hash>& other) noexcept
{
    using std::swap;

    swap(mBuckets, other.mBuckets);
    swap(mSize, other.mSize);
    swap(mEqual, other.mEqual);
    swap(mHash, other.mHash);
}
```

The following standalone `swap()` function is also provided, which simply forwards to the `swap()` method:

```
template <typename Key, typename T, typename KeyEqual, typename Hash>
void swap(hash_map<Key, T, KeyEqual, Hash>& first,
          hash_map<Key, T, KeyEqual, Hash>& second) noexcept
{
    first.swap(second);
}
```

Assignment Operators

Here are the implementations of the copy and move assignment operators. See Chapter 9 for a discussion of the copy-and-swap idiom.

```
template <typename Key, typename T, typename KeyEqual, typename Hash>
hash_map<Key, T, KeyEqual, Hash>&
hash_map<Key, T, KeyEqual, Hash>::operator=(
    const hash_map<Key, T, KeyEqual, Hash>& rhs)
{
    // check for self-assignment
    if (this == &rhs) {
        return *this;
    }
}
```

```
        // Copy-and-swap idiom
        auto copy = rhs; // Do all the work in a temporary instance
        swap(copy);     // Commit the work with only non-throwing operations
        return *this;
    }

    template <typename Key, typename T, typename KeyEqual, typename Hash>
    hash_map<Key, T, KeyEqual, Hash>&
        hash_map<Key, T, KeyEqual, Hash>::operator=(
            hash_map<Key, T, KeyEqual, Hash>&& rhs) noexcept
    {
        swap(rhs);
        return *this;
    }
}
```

Using the Basic Hash Map

Here is a small test program demonstrating the basic `hash_map` class template:

```
hash_map<int, int> myHash;
myHash.insert(make_pair(4, 40));
myHash.insert(make_pair(6, 60));

// x will have type hash_map<int, int>::value_type*
auto x = myHash.find(4);
if (x != nullptr) {
    cout << "4 maps to " << x->second << endl;
} else {
    cout << "cannot find 4 in map" << endl;
}

myHash.erase(4);

auto x2 = myHash.find(4);
if (x2 != nullptr) {
    cout << "4 maps to " << x2->second << endl;
} else {
    cout << "cannot find 4 in map" << endl;
}

myHash[4] = 35;
myHash[4] = 60;

auto x3 = myHash.find(4);
if (x3 != nullptr) {
    cout << "4 maps to " << x3->second << endl;
} else {
    cout << "cannot find 4 in map" << endl;
}

// Test std::swap().
hash_map<int, int> other(std::equal_to<>(), 11);
swap(other, myHash);
```



```
// Test copy construction and copy assignment.
hash_map<int, int> myHash2(other);
hash_map<int, int> myHash3;
myHash3 = myHash2;

// Test move construction and move assignment.
hash_map<int, int> myHash4(std::move(myHash3));
hash_map<int, int> myHash5;
myHash5 = std::move(myHash4);
```

The output is as follows:

```
4 maps to 40
cannot find 4 in map
4 maps to 60
```

Making hash_map a Standard Library Container

The basic `hash_map` shown in the previous section follows the spirit, but not the letter, of the Standard Library. For most purposes, the preceding implementation is good enough. However, if you want to use the Standard Library algorithms on your `hash_map`, you must do a bit more work. The C++ standard specifies methods and type aliases that a data structure must provide in order to qualify as a Standard Library container.

Required Type Aliases

The C++ standard specifies that every Standard Library container must provide the following public type aliases.

TYPE NAME	DESCRIPTION
<code>value_type</code>	The element type stored in the container
<code>reference</code>	A reference to the element type stored in the container
<code>const_reference</code>	A <code>const</code> reference to the element type stored in the container
<code>iterator</code>	The type for iterating over elements of the container
<code>const_iterator</code>	A version of <code>iterator</code> for iterating over <code>const</code> elements of the container
<code>size_type</code>	A type that can represent the number of elements in the container; this is usually just <code>size_t</code> (from <code><cstddef></code>).
<code>difference_type</code>	A type that can represent the difference of two <code>iterator</code> s for the container; this is usually just <code>ptrdiff_t</code> (from <code><cstddef></code>).

Here are the definitions for the `hash_map` class template of all these type aliases except `iterator` and `const_iterator`. Writing an `iterator` is covered in detail in a subsequent section. Note that `value_type` (plus `key_type` and `mapped_type`, which are discussed later) was already defined in

the previous version of the `hash_map`. This implementation also adds a type alias `hash_map_type` to give a shorter name to a specific template instantiation of `hash_map`:

```
template <typename Key, typename T, typename KeyEqual = std::equal_to<>,
         typename Hash = hash<Key>>
class hash_map
{
public:
    using key_type = Key;
    using mapped_type = T;
    using value_type = std::pair<const Key, T>;
    using reference = value_type&;
    using const_reference = const value_type&;
    using size_type = size_t;
    using difference_type = ptrdiff_t;
    using hash_map_type = hash_map<Key, T, KeyEqual, Hash>;
    // Remainder of class definition omitted for brevity
};
```

Required Methods

In addition to the obligatory type aliases, every container must provide the following methods.

METHOD	DESCRIPTION	WORST-CASE COMPLEXITY
Default constructor	Constructs an empty container	Constant
Copy constructor	Performs a deep copy of the container	Linear
Move constructor	Performs a move constructing operation	Constant
Copy assignment operator	Performs a deep copy of the container	Linear
Move assignment operator	Performs a move assignment operation	Constant
Destructor	Destroys dynamically allocated memory; this method calls destructor on all elements left in the container.	Linear
iterator <code>begin()</code> ; const_iterator <code>begin() const</code> ;	Returns an iterator referring to the first element in the container	Constant
iterator <code>end()</code> ; const_iterator <code>end() const</code> ;	Returns an iterator referring to one-past-the-last element in the container	Constant
const_iterator <code>cbegin() const</code> ;	Returns a const iterator referring to the first element in the container	Constant

METHOD	DESCRIPTION	WORST-CASE COMPLEXITY
<code>const_iterator</code> <code>cend() const;</code>	Returns a <code>const</code> iterator referring to one-past-the-last element in the container	Constant
<code>operator==</code> <code>operator!=</code>	Comparison operators that compare two containers, element by element	Linear
<code>void swap(Container&)</code> <code>noexcept;</code>	Swaps the contents of the container passed to the method with the object on which the method is called	Constant
<code>size_type size()</code> <code>const;</code>	Returns the number of elements in the container	Constant
<code>size_type max_size()</code> <code>const;</code>	Returns the maximum number of elements the container can hold	Constant
<code>bool empty() const;</code>	Returns whether the container has any elements	Constant

NOTE *In this `hash_map` example, comparison operators are omitted. Implementing them would be a good exercise for you to try, but you first have to think about the semantics of equality for two `hash_maps`. One possibility could be that two `hash_maps` are equal if and only if they have exactly the same number of buckets with the same contents. Similarly, you'll have to think about what it means for a `hash_map` to be less than another `hash_map`. An option is to define it as a pairwise comparison of the elements.*

The following code snippet shows the declarations of the remaining methods except for `begin()`, `end()`, `cbegin()`, and `cend()`. Those are covered in the next section.

```
template <typename Key, typename T, typename KeyEqual = std::equal_to<>,
         typename Hash = hash<Key>>
class hash_map
{
public:
    // Type aliases omitted for brevity

    // Size methods
    bool empty() const;
    size_type size() const;
    size_type max_size() const;

    // Other methods omitted for brevity
};
```

The implementations of `size()` and `empty()` are easy because the `hash_map` implementation tracks its size in the `mSize` data member. Note that `size_type` is one of the type aliases defined in the class. Because it is a member of the class, such a return type in the implementation must be fully qualified with `typename hash_map<Key, T, KeyEqual, Hash>`:

```
template <typename Key, typename T, typename KeyEqual, typename Hash>
bool hash_map<Key, T, KeyEqual, Hash>::empty() const
{
    return mSize == 0;
}

template <typename Key, typename T, typename KeyEqual, typename Hash>
typename hash_map<Key, T, KeyEqual, Hash>::size_type
    hash_map<Key, T, KeyEqual, Hash>::size() const
{
    return mSize;
}
```

`max_size()` is a little trickier. At first, you might think the maximum size of a `hash_map` container is the sum of the maximum size of all the `lists`. However, the worst-case scenario is that all the elements hash to the same bucket. Thus, the maximum size it can claim to support is the maximum size of a single `list`:

```
template <typename Key, typename T, typename KeyEqual, typename Hash>
typename hash_map<Key, T, KeyEqual, Hash>::size_type
    hash_map<Key, T, KeyEqual, Hash>::max_size() const
{
    return mBuckets[0].max_size();
}
```

Writing an Iterator

The most important container requirement is the iterator. In order to work with the generic algorithms, every container must provide an iterator for accessing the elements in the container. Your iterator should generally provide overloaded `operator*` and `operator->`, plus some other operations depending on its specific behavior. As long as your iterator provides the basic iteration operations, everything should be fine.

The first decision to make about your iterator is what kind it will be: forward, bidirectional, or random access. Random-access iterators don't make much sense for associative containers, so bidirectional seems like the logical choice for a `hash_map` iterator. That means you must also provide `operator++`, `operator--`, `operator==`, and `operator!=`. Consult Chapter 17 for more details on the requirements for the different iterators.

The second decision is how to order the elements of your container. The `hash_map` is unsorted, so iterating in a sorted order is probably too difficult. Instead, your iterator can just step through the buckets, starting with the elements in the first bucket and progressing to those in the last bucket. This order will appear random to the client, but will be consistent and repeatable.

The third decision is how to represent your iterator internally. The implementation is usually quite dependent on the internal implementation of the container. The first purpose of an iterator is to refer to a single element in the container. In the case of a `hash_map`, each element is in a Standard Library

`list`, so perhaps a `hash_map` iterator can be a wrapper around a `list` iterator referring to the element in question. However, the second purpose of a bidirectional iterator is to allow the client to progress to the next or previous element from the current one. In order to progress from one bucket to the next, you need to track the current bucket and the `hash_map` object to which the iterator refers.

Once you've chosen your implementation, you must decide on a consistent representation for the end iterator. Recall that the end iterator should really be the “past-the-end” marker: the iterator that's reached by applying `++` to an iterator referring to the final element in the container. A `hash_map` iterator can use as its end iterator the end iterator of the `list` of the final bucket in the `hash_map`.

A container needs to provide both a `const` iterator and a non-`const` iterator. The non-`const` iterator must be convertible to a `const` iterator. This implementation defines a `const_hash_map_iterator` class with `hash_map_iterator` deriving from it.

The `const_hash_map_iterator` Class

Given the decisions made in the previous section, it's time to define the `const_hash_map_iterator` class. The first thing to note is that each `const_hash_map_iterator` object is an iterator for a specific instantiation of the `hash_map` class. In order to provide this one-to-one mapping, the `const_hash_map_iterator` must also be a class template with the hash map type as a template parameter called `HashMap`.

The main question in the class definition is how to conform to the bidirectional iterator requirements. Recall that anything that behaves like an iterator is an iterator. Your class is not required to derive from another class in order to qualify as a bidirectional iterator. However, if you want your iterator to be usable in the generic algorithms functions, you must specify its traits. The discussion earlier in this chapter explains that `iterator_traits` is a class template that defines, for each iterator type, five type aliases: `value_type`, `difference_type`, `iterator_category`, `pointer`, and `reference`. The `iterator_traits` class template could be partially specialized for your new iterator type if you want. Alternatively, the default implementation of the `iterator_traits` class template just grabs the five type aliases out of the iterator class itself. Thus, you can simply define those type aliases directly in your iterator class. The `const_hash_map_iterator` is a bidirectional iterator, so you specify `bidirectional_iterator_tag` as the iterator category. Other legal iterator categories are `input_iterator_tag`, `output_iterator_tag`, `forward_iterator_tag`, and `random_access_iterator_tag`. For the `const_hash_map_iterator`, the element type is `typename HashMap::value_type`.

Here is the basic `const_hash_map_iterator` class definition:

```
template <typename HashMap>
class const_hash_map_iterator
{
public:
    using value_type = typename HashMap::value_type;
    using difference_type = ptrdiff_t;
    using iterator_category = std::bidirectional_iterator_tag;
    using pointer = value_type*;
    using reference = value_type&;
    using list_iterator_type = typename HashMap::ListType::const_iterator;
```

```

// Bidirectional iterators must supply a default constructor.
// Using an iterator constructed with the default constructor
// is undefined, so it doesn't matter how it's initialized.
const_hash_map_iterator() = default;

const_hash_map_iterator(size_t bucket, list_iterator_type listIt,
    const HashMap* hashmap);

// Don't need to define a copy constructor or operator= because the
// default behavior is what we want.

// Don't need destructor because the default behavior
// (not deleting mHashMap) is what we want!

const value_type& operator*() const;

// Return type must be something to which -> can be applied.
// Return a pointer to a pair<const Key, T>, to which the compiler
// will apply -> again.
const value_type* operator->() const;

const_hash_map_iterator<HashMap>& operator++();
const_hash_map_iterator<HashMap> operator++(int);

const_hash_map_iterator<HashMap>& operator--();
const_hash_map_iterator<HashMap> operator--(int);

// The following are ok as member functions because we don't
// support comparisons of different types to this one.
bool operator==(const const_hash_map_iterator<HashMap>& rhs) const;
bool operator!=(const const_hash_map_iterator<HashMap>& rhs) const;
protected:
    size_t mBucketIndex = 0;
    list_iterator_type mListIterator;
    const HashMap* mHashMap = nullptr;

    // Helper methods for operator++ and operator--
    void increment();
    void decrement();
};

```

Consult Chapter 15 for details on operator overloading if the definitions and implementations (shown in the next section) of the overloaded operators confuse you.

The const_hash_map_iterator Method Implementations

The const_hash_map_iterator constructor initializes the three member variables:

```

template<typename HashMap>
const_hash_map_iterator<HashMap>::const_hash_map_iterator(size_t bucket,
    list_iterator_type listIt, const HashMap* hashmap)
    : mBucketIndex(bucket), mListIterator(listIt), mHashMap(hashmap)
{
}

```

The default constructor is defaulted so that clients can declare `const_hash_map_iterator` variables without initializing them. An iterator constructed with the default constructor does not need to refer to any value, and attempting any operations on it is allowed to have undefined results.

The implementations of the dereferencing operators are concise, but can be tricky. Chapter 15 explains that `operator*` and `operator->` are asymmetric; `operator*` returns a reference to the actual underlying value, which in this case is the element to which the iterator refers, while `operator->` must return something to which the arrow operator can be applied again. Thus, it returns a pointer to the element. The compiler then applies `->` to the pointer, which results in accessing a field of the element.

```
// Return a reference to the actual element.
template<typename HashMap>
const typename const_hash_map_iterator<HashMap>::value_type&
    const_hash_map_iterator<HashMap>::operator*() const
{
    return *mListIterator;
}

// Return a pointer to the actual element, so the compiler can
// apply -> to it to access the actual desired field.
template<typename HashMap>
const typename const_hash_map_iterator<HashMap>::value_type*
    const_hash_map_iterator<HashMap>::operator->() const
{
    return &(*mListIterator);
}
```

The increment and decrement operators are implemented as follows. They defer the actual incrementing and decrementing to the private `increment()` and `decrement()` helper methods.

```
// Defer the details to the increment() helper.
template<typename HashMap>
const_hash_map_iterator<HashMap>&
    const_hash_map_iterator<HashMap>::operator++()
{
    increment();
    return *this;
}

// Defer the details to the increment() helper.
template<typename HashMap>
const_hash_map_iterator<HashMap>
    const_hash_map_iterator<HashMap>::operator++(int)
{
    auto oldIt = *this;
    increment();
    return oldIt;
}

// Defer the details to the decrement() helper.
template<typename HashMap>
const_hash_map_iterator<HashMap>&
    const_hash_map_iterator<HashMap>::operator--()
```

```

    {
        decrement();
        return *this;
    }

    // Defer the details to the decrement() helper.
    template<typename HashMap>
    const_hash_map_iterator<HashMap>
        const_hash_map_iterator<HashMap>::operator--(int)
    {
        auto oldIt = *this;
        decrement();
        return oldIt;
    }

```

Incrementing a `const_hash_map_iterator` tells it to refer to the “next” element in the container. This method first increments the `list` iterator, then checks if it has reached the end of its bucket. If so, it finds the next non-empty bucket in the `hash_map` and sets the `list` iterator equal to the start element in that bucket. Note that it can’t simply move to the next bucket, because there might not be any elements in it. If there are no more non-empty buckets, `mListIterator` is set, by the convention chosen for this example, to the end iterator of the last bucket in the `hash_map`, which is the special “end” position of the `const_hash_map_iterator`. Iterators are not required to be any safer than dumb pointers, so error-checking for things like incrementing an iterator already at the end is not required.

```

// Behavior is undefined if mListIterator already refers to the past-the-end
// element, or is otherwise invalid.
template<typename HashMap>
void const_hash_map_iterator<HashMap>::increment()
{
    // mListIterator is an iterator into a single bucket. Increment it.
    ++mListIterator;

    // If we're at the end of the current bucket,
    // find the next bucket with elements.
    auto& buckets = mHashMap->mBuckets;
    if (mListIterator == end(buckets[mBucketIndex])) {
        for (size_t i = mBucketIndex + 1; i < buckets.size(); i++) {
            if (!buckets[i].empty()) {
                // We found a non-empty bucket.
                // Make mListIterator refer to the first element in it.
                mListIterator = begin(buckets[i]);
                mBucketIndex = i;
                return;
            }
        }
        // No more non-empty buckets. Set mListIterator to refer to the
        // end iterator of the last list.
        mBucketIndex = buckets.size() - 1;
        mListIterator = end(buckets[mBucketIndex]);
    }
}

```

Decrement is the inverse of increment: it makes the iterator refer to the “previous” element in the container. However, there is an asymmetry because of the asymmetry between the way the start and end positions are represented: start is the first element, but end is “one past” the last element. The algorithm for decrement first checks if the underlying `list` iterator is at the start of its current bucket. If not, it can just be decremented. Otherwise, the code needs to check for the first non-empty bucket before the current one. If one is found, the `list` iterator must be set to refer to the last element in that bucket, which is the end iterator decremented by one. If no non-empty buckets are found, the decrement is invalid, so the code can do anything it wants (behavior is undefined). Note that the `for` loop needs to use a signed integer type for its loop variable and not an unsigned type such as `size_t` because the loop uses `--i`:

```
// Behavior is undefined if mListIterator already refers to the first
// element, or is otherwise invalid.
template<typename HashMap>
void const_hash_map_iterator<HashMap>::decrement()
{
    // mListIterator is an iterator into a single bucket.
    // If it's at the beginning of the current bucket, don't decrement it.
    // Instead, try to find a non-empty bucket before the current one.
    auto& buckets = mHashmap->mBuckets;
    if (mListIterator == begin(buckets[mBucketIndex])) {
        for (int i = mBucketIndex - 1; i >= 0; --i) {
            if (!buckets[i].empty()) {
                mListIterator = --end(buckets[i]);
                mBucketIndex = i;
                return;
            }
        }
        // No more non-empty buckets. This is an invalid decrement.
        // Set mListIterator to refer to the end iterator of the last list.
        mBucketIndex = buckets.size() - 1;
        mListIterator = end(buckets[mBucketIndex]);
    } else {
        // We're not at the beginning of the bucket, so just move down.
        --mListIterator;
    }
}
```

Note that both `increment()` and `decrement()` access private members of the `hash_map` class. Thus, the `hash_map` class must declare `const_hash_map_iterator` to be a friend class.

After `increment()` and `decrement()`, `operator==` and `operator!=` are positively simple. They just compare each of the three data members of the objects:

```
template<typename HashMap>
bool const_hash_map_iterator<HashMap>::operator==(
    const const_hash_map_iterator<HashMap>& rhs) const
{
    // All fields, including the hash_map to which the iterators refer,
    // must be equal.
    return (mHashmap == rhs.mHashmap &&
```

```

        mBucketIndex == rhs.mBucketIndex &&
        mListIterator == rhs.mListIterator);
    }

    template<typename HashMap>
    bool const_hash_map_iterator<HashMap>::operator!=(
        const const_hash_map_iterator<HashMap>& rhs) const
    {
        return !(*this == rhs);
    }

```

The hash_map_iterator Class

The `hash_map_iterator` class derives from `const_hash_map_iterator`. It does not need to override `operator==`, `operator!=`, `increment()`, and `decrement()` because the base class versions are just fine:

```

template <typename HashMap>
class hash_map_iterator : public const_hash_map_iterator<HashMap>
{
public:
    using value_type =
        typename const_hash_map_iterator<HashMap>::value_type;
    using difference_type = ptrdiff_t;
    using iterator_category = std::bidirectional_iterator_tag;
    using pointer = value_type*;
    using reference = value_type&;
    using list_iterator_type = typename HashMap::ListType::iterator;

    hash_map_iterator() = default;
    hash_map_iterator(size_t bucket, list_iterator_type listIt,
        HashMap* hashmap);

    value_type& operator*();
    value_type* operator->();

    hash_map_iterator<HashMap>& operator++();
    hash_map_iterator<HashMap> operator++(int);

    hash_map_iterator<HashMap>& operator--();
    hash_map_iterator<HashMap> operator--(int);
};

```

The hash_map_iterator Method Implementations

The implementations of the `hash_map_iterator` methods are rather straightforward. The constructor just calls the base class constructor. The `operator*` and `operator->` use `const_cast` to return a non-const type. `operator++` and `operator--` just use the `increment()` and `decrement()` from the base class, but return a `hash_map_iterator` instead of a `const_hash_map_iterator`. Note that the C++ name lookup rules require you to explicitly use the `this` pointer to refer to data members and methods in a base class template:

```

template<typename HashMap>
hash_map_iterator<HashMap>::hash_map_iterator(size_t bucket,

```

```

    list_iterator_type listIt, HashMap* hashmap)
    : const_hash_map_iterator<HashMap>(bucket, listIt, hashmap)
{
}

// Return a reference to the actual element.
template<typename HashMap>
typename hash_map_iterator<HashMap>::value_type&
    hash_map_iterator<HashMap>::operator*()
{
    return const_cast<value_type&>(*this->mListIterator);
}

// Return a pointer to the actual element, so the compiler can
// apply -> to it to access the actual desired field.
template<typename HashMap>
typename hash_map_iterator<HashMap>::value_type*
    hash_map_iterator<HashMap>::operator->()
{
    return const_cast<value_type*>(&(*this->mListIterator));
}

// Defer the details to the increment() helper in the base class.
template<typename HashMap>
hash_map_iterator<HashMap>& hash_map_iterator<HashMap>::operator++()
{
    this->increment();
    return *this;
}

// Defer the details to the increment() helper in the base class.
template<typename HashMap>
hash_map_iterator<HashMap> hash_map_iterator<HashMap>::operator++(int)
{
    auto oldIt = *this;
    this->increment();
    return oldIt;
}

// Defer the details to the decrement() helper in the base class.
template<typename HashMap>
hash_map_iterator<HashMap>& hash_map_iterator<HashMap>::operator--()
{
    this->decrement();
    return *this;
}

// Defer the details to the decrement() helper in the base class.
template<typename HashMap>
hash_map_iterator<HashMap> hash_map_iterator<HashMap>::operator--(int)
{
    auto oldIt = *this;
    this->decrement();
    return oldIt;
}

```

Iterator Type Aliases and Access Methods

The final piece involved in providing iterator support for `hash_map` is to supply the necessary type aliases in the `hash_map` class template, and to write the `begin()`, `end()`, `cbegin()`, and `cend()` methods. The type aliases and method prototypes look like this:

```
template <typename Key, typename T, typename KeyEqual = std::equal_to<>,
         typename Hash = hash<Key>>
class hash_map
{
public:
    // Other type aliases omitted for brevity
    using iterator = hash_map_iterator<hash_map_type>;
    using const_iterator = const_hash_map_iterator<hash_map_type>;

    // Iterator methods
    iterator begin();
    iterator end();
    const_iterator begin() const;
    const_iterator end() const;
    const_iterator cbegin() const;
    const_iterator cend() const;
    // Remainder of class definition omitted for brevity
};
```

The implementation of `begin()` includes an optimization for the case when there are no elements in the `hash_map`, in which case the end iterator is returned. Here is the code:

```
template <typename Key, typename T, typename KeyEqual, typename Hash>
typename hash_map<Key, T, KeyEqual, Hash>::iterator
hash_map<Key, T, KeyEqual, Hash>::begin()
{
    if (mSize == 0) {
        // Special case: there are no elements, so return the end iterator.
        return end();
    }

    // We know there is at least one element. Find the first element.
    for (size_t i = 0; i < mBuckets.size(); ++i) {
        if (!mBuckets[i].empty()) {
            return hash_map_iterator<hash_map_type>(i,
                std::begin(mBuckets[i]), this);
        }
    }
    // Should never reach here, but if we do, return the end iterator.
    return end();
}
```

`end()` creates a `hash_map_iterator` referring to the end iterator of the last bucket:

```
template <typename Key, typename T, typename KeyEqual, typename Hash>
typename hash_map<Key, T, KeyEqual, Hash>::iterator
hash_map<Key, T, KeyEqual, Hash>::end()
{
    // The end iterator is the end iterator of the list of the last bucket.
    size_t bucket = mBuckets.size() - 1;
```

```

        return hash_map_iterator<hash_map_type>(bucket,
            std::end(mBuckets[bucket]), this);
    }

```

The implementations of the `const` versions of `begin()` and `end()` use `const_cast` to call the non-`const` versions. These non-`const` versions return a `hash_map_iterator`, which is convertible to a `const_hash_map_iterator`:

```

template <typename Key, typename T, typename KeyEqual, typename Hash>
typename hash_map<Key, T, KeyEqual, Hash>::const_iterator
    hash_map<Key, T, KeyEqual, Hash>::begin() const
{
    return const_cast<hash_map_type*>(this)->begin();
}

template <typename Key, typename T, typename KeyEqual, typename Hash>
typename hash_map<Key, T, KeyEqual, Hash>::const_iterator
    hash_map<Key, T, KeyEqual, Hash>::end() const
{
    return const_cast<hash_map_type*>(this)->end();
}

```

The `cbegin()` and `cend()` methods forward the request to the `const` versions of `begin()` and `end()`:

```

template <typename Key, typename T, typename KeyEqual, typename Hash>
typename hash_map<Key, T, KeyEqual, Hash>::const_iterator
    hash_map<Key, T, KeyEqual, Hash>::cbegin() const
{
    return begin();
}

template <typename Key, typename T, typename KeyEqual, typename Hash>
typename hash_map<Key, T, KeyEqual, Hash>::const_iterator
    hash_map<Key, T, KeyEqual, Hash>::cend() const
{
    return end();
}

```

Using the `hash_map` Iterators

Now that `hash_map` supports iteration, you can iterate over its elements just as you would on any Standard Library container, and you can pass the iterators to methods and functions. Here are some examples:

```

hash_map<string, int> myHash;
myHash.insert(make_pair("KeyOne", 100));
myHash.insert(make_pair("KeyTwo", 200));
myHash.insert(make_pair("KeyThree", 300));

for (auto it = myHash.cbegin(); it != myHash.cend(); ++it) {
    // Use both -> and * to test the operations.
    cout << it->first << " maps to " << (*it).second << endl;
}

```

```

// Print elements using a range-based for loop
for (auto& p : myHash) {
    cout << p.first << " maps to " << p.second << endl;
}

// Print elements using a range-based for loop and C++17 structured bindings
for (auto&[key, value] : myHash) {
    cout << key << " maps to " << value << endl;
}

// Create an std::map with all the elements in the hash_map.
map<string, int> myMap(cbegin(myHash), cend(myHash));
for (auto& p : myMap) {
    cout << p.first << " maps to " << p.second << endl;
}

```

The last piece of code also shows that the non-member functions such as `std::cbegin()` and `std::cend()` are working as expected.

Note on Allocators

As described earlier in this chapter, all the Standard Library containers allow you to specify a custom memory allocator. A “good citizen” `hash_map` implementation should do the same. However, those details are omitted because they obscure the main points of this implementation, and because custom allocators are rarely used.

Note on Reversible Containers

If your container supplies a bidirectional or random access iterator, it is considered *reversible*. Reversible containers are supposed to supply two additional type aliases.

TYPE NAME	DESCRIPTION
<code>reverse_iterator</code>	The type for iterating over elements of the container in reverse order
<code>const_reverse_iterator</code>	A version of <code>reverse_iterator</code> for iterating over <code>const</code> elements of the container in reverse order

Additionally, the container should provide `rbegin()` and `rend()`, which are symmetric with `begin()` and `end()`; it should also provide `crbegin()` and `crend()`, which are symmetric with `cbegin()` and `cend()`. The usual implementations just use the `std::reverse_iterator` adaptor described earlier in this chapter. These are left as an exercise for you to try.

Making `hash_map` an Unordered Associative Container

In addition to the basic container requirements that were shown already, you can also make your container adhere to additional requirements for ordered associative, unordered associative, or sequential containers. This section modifies the `hash_map` class template to satisfy a few additional unordered associative container requirements.

Unordered Associative Container Type Alias Requirements

Unordered associative containers require the following type aliases.

TYPE NAME	DESCRIPTION
<code>key_type</code>	The key type with which the container is instantiated
<code>mapped_type</code>	The element type with which the container is instantiated
<code>value_type</code>	<code>pair<const Key, T></code>
<code>hasher</code>	The hash type with which the container is instantiated
<code>key_equal</code>	The equality predicate with which the container is instantiated
<code>local_iterator</code>	An iterator type to iterate through a single bucket. Cannot be used to iterate across buckets.
<code>const_local_iterator</code>	A <code>const</code> iterator type to iterate through a single bucket. Cannot be used to iterate across buckets.
<code>node_type</code>	A type to represent a node. See Chapter 17 for a discussion on nodes. Not further discussed in this section.

Here is the `hash_map` definition with an updated set of type aliases. Note that the definition of `ListType` has been moved, because the definitions of the local iterators require `ListType`.

```
template <typename Key, typename T, typename KeyEqual = std::equal_to<>,
         typename Hash = hash<Key>>
class hash_map
{
public:
    using key_type = Key;
    using mapped_type = T;
    using value_type = std::pair<const Key, T>;
    using hasher = Hash;
    using key_equal = KeyEqual;
    using reference = value_type&;
    using const_reference = const value_type&;
    using size_type = size_t;
    using difference_type = ptrdiff_t;
    using hash_map_type = hash_map<Key, T, KeyEqual, Hash>;
    using iterator = hash_map_iterator<hash_map_type>;
    using const_iterator = const_hash_map_iterator<hash_map_type>;

private:
    using ListType = std::list<value_type>;
public:
    using local_iterator = typename ListType::iterator;
    using const_local_iterator = typename ListType::const_iterator;

    // Remainder of hash_map class definition omitted for brevity
};
```

Unordered Associative Container Method Requirements

The standard prescribes quite a few additional method requirements for unordered associative containers, as listed in the following table. In the last column, n is the number of elements in the container.

METHOD	DESCRIPTION	COMPLEXITY
Constructor taking an iterator range	Constructs the container and inserts the elements from the iterator range. The iterator range need not refer to another container of the same type. Note that all constructors of unordered associative containers must take an equality predicate. The constructors should provide a default constructed object as the default value.	On average $O(n)$, worst case $O(n^2)$
Constructor taking an <code>initializer_list<value_type></code> as parameter	Constructs the container and inserts the elements from the initializer list into the container.	On average $O(n)$, worst case $O(n^2)$
Assignment operator with an <code>initializer_list<value_type></code> as right-hand side	Replaces all elements from the container with the elements from the initializer list.	On average $O(n)$, worst case $O(n^2)$
<code>hasher hash_function() const;</code>	Returns the hash function.	Constant
<code>key_equal key_eq() const;</code>	Returns the equality predicate for comparing keys.	Constant
<code>pair<iterator, bool> insert(value_type&);</code> <code>iterator insert(const_iterator hint, value_type&);</code>	Two different forms of <code>insert</code> . The <code>hint</code> can be ignored by the implementation. Containers that allow duplicate keys return just <code>iterator</code> for the first form, because <code>insert()</code> always succeeds in that case.	On average $O(1)$, worst case $O(n)$
<code>void insert(InputIterator start, InputIterator end);</code>	Inserts a range of elements. The range need not be from a container of the same type.	On average $O(m)$ with m the number of elements to insert. Worst case $O(m*n+m)$

METHOD	DESCRIPTION	COMPLEXITY
<pre>void insert (initializer_list< value_type>);</pre>	Inserts the elements from the initializer list into the container.	On average $O(m)$ with m the number of elements to insert. Worst case $O(m*n+m)$
<pre>pair<iterator, bool> emplace(Args&&...); iterator emplace_hint (const_iterator hint, Args&&...);</pre>	Implements the emplace operations to construct objects <i>in-place</i> . In-place construction is discussed in Chapter 17.	On average $O(1)$, worst case $O(n)$
<pre>size_type erase(key_type&); iterator erase (iterator position); iterator erase (iterator start, iterator end);</pre>	Three different forms of erase. The first form returns the number of values erased (0 or 1 in containers that do not allow duplicate keys). The second and third forms erase the elements at <code>position</code> , or in the range <code>start</code> to <code>end</code> , and return an iterator to the element following the last erased element.	Worst case $O(n)$
<pre>void clear();</pre>	Erases all elements.	$O(n)$
<pre>Iterator find(key_type&); const_iterator find(key_type& const);</pre>	Finds the element with the specified key.	On average $O(1)$, worst case $O(n)$
<pre>size_type count(key_type& const);</pre>	Returns the number of elements with the specified key (0 or 1 in containers that do not allow duplicate keys).	On average $O(1)$, worst case $O(n)$
<pre>pair<iterator, iterator> equal_range (key_type&); pair<const_iterator, const_iterator> equal_range (key_type&) const;</pre>	Returns iterators referring to the first element with the specified key and one past the last element with the specified key.	Worst case $O(n)$

Note that `hash_map` does not allow duplicate keys, so `equal_range()` always returns a pair of identical iterators.

C++17 adds `extract()` and `merge()` methods to the list of requirements. These have to do with handling nodes as discussed in Chapter 17, but are omitted for this `hash_map` implementation.

Here is the complete `hash_map` class definition. The prototypes for `insert()`, `erase()`, and `find()` need to change slightly from the previous versions shown because those initial versions don't have the right return types required for unordered associative containers.

```
template <typename Key, typename T, typename KeyEqual = std::equal_to<>,
         typename Hash = hash<Key>>
class hash_map
{
public:
    using key_type = Key;
    using mapped_type = T;
    using value_type = std::pair<const Key, T>;
    using hasher = Hash;
    using key_equal = KeyEqual;
    using reference = value_type&;
    using const_reference = const value_type&;
    using size_type = size_t;
    using difference_type = ptrdiff_t;
    using hash_map_type = hash_map<Key, T, KeyEqual, Hash>;
    using iterator = hash_map_iterator<hash_map_type>;
    using const_iterator = const_hash_map_iterator<hash_map_type>;

private:
    using ListType = std::list<value_type>;
public:
    using local_iterator = typename ListType::iterator;
    using const_local_iterator = typename ListType::const_iterator;

    // The iterator classes need access to all members of the hash_map
    friend class hash_map_iterator<hash_map_type>;
    friend class const_hash_map_iterator<hash_map_type>;

    virtual ~hash_map() = default;    // Virtual destructor

    // Throws invalid_argument if the number of buckets is illegal.
    explicit hash_map(const KeyEqual& equal = KeyEqual(),
                     size_type numBuckets = 101, const Hash& hash = Hash());

    // Throws invalid_argument if the number of buckets is illegal.
    template <typename InputIterator>
    hash_map(InputIterator first, InputIterator last,
             const KeyEqual& equal = KeyEqual(),
             size_type numBuckets = 101, const Hash& hash = Hash());

    // Initializer list constructor
    // Throws invalid_argument if the number of buckets is illegal.
    explicit hash_map(std::initializer_list<value_type> il,
                     const KeyEqual& equal = KeyEqual(), size_type numBuckets = 101,
                     const Hash& hash = Hash());
```

```

// Copy constructor
hash_map(const hash_map_type& src) = default;
// Move constructor
hash_map(hash_map_type&& src) noexcept = default;

// Copy assignment operator
hash_map_type& operator=(const hash_map_type& rhs);
// Move assignment operator
hash_map_type& operator=(hash_map_type&& rhs) noexcept;
// Initializer list assignment operator
hash_map_type& operator=(std::initializer_list<value_type> il);

// Iterator methods
iterator begin();
iterator end();
const_iterator begin() const;
const_iterator end() const;
const_iterator cbegin() const;
const_iterator cend() const;

// Size methods
bool empty() const;
size_type size() const;
size_type max_size() const;

// Element insert methods
T& operator[] (const key_type& k);
std::pair<iterator, bool> insert(const value_type& x);
iterator insert(const_iterator hint, const value_type& x);
template <typename InputIterator>
void insert(InputIterator first, InputIterator last);
void insert(std::initializer_list<value_type> il);

// Element delete methods
size_type erase(const key_type& k);
iterator erase(iterator position);
iterator erase(iterator first, iterator last);

// Other modifying utilities
void swap(hash_map_type& other) noexcept;
void clear() noexcept;

// Access methods for Standard Library conformity
key_equal key_eq() const;
hasher hash_function() const;

// Lookup methods
iterator find(const key_type& k);
const_iterator find(const key_type& k) const;
std::pair<iterator, iterator> equal_range(const key_type& k);
std::pair<const_iterator, const_iterator>
equal_range(const key_type& k) const;

```

```

        size_type count(const key_type& k) const;

private:
    // Returns a pair containing an iterator to the found element with
    // a given key, and the index of that element's bucket.
    std::pair<typename ListType::iterator, size_t> findElement(
        const key_type& k);

    std::vector<ListType> mBuckets;
    size_type mSize = 0;
    KeyEqual mEqual;
    Hash mHash;
};

```

hash_map Iterator Range Constructor

The constructor accepting an iterator range is a method template so that it can take an iterator range from any container, not just other `hash_map`s. If it were not a method template, it would need to specify the `InputIterator` type explicitly as `hash_map_iterator`, limiting it to iterators from `hash_map`s. Despite the syntax, the implementation is uncomplicated: it delegates the construction to the explicit constructor to initialize all the data members, then calls `insert()` to actually insert all the elements in the specified range.

```

// Make a call to insert() to actually insert the elements.
template <typename Key, typename T, typename KeyEqual, typename Hash>
template <typename InputIterator>
hash_map<Key, T, KeyEqual, Hash>::hash_map(
    InputIterator first, InputIterator last, const KeyEqual& equal,
    size_type numBuckets, const Hash& hash)
    : hash_map(equal, numBuckets, hash)
{
    insert(first, last);
}

```

hash_map Initializer List Constructor

Initializer lists are discussed in Chapter 1. Following is the implementation of the `hash_map` constructor that takes an initializer list, which is very similar to the implementation of the constructor accepting an iterator range:

```

template <typename Key, typename T, typename KeyEqual, typename Hash>
hash_map<Key, T, KeyEqual, Hash>::hash_map(
    std::initializer_list<value_type> il,
    const KeyEqual& equal, size_type numBuckets, const Hash& hash)
    : hash_map(equal, numBuckets, hash)
{
    insert(std::begin(il), std::end(il));
}

```

With this initializer list constructor, a `hash_map` can be constructed as follows:

```

hash_map<string, int> myHash {
    { "KeyOne", 100 },
    { "KeyTwo", 200 },
    { "KeyThree", 300 } };

```

hash_map Initializer List Assignment Operator

Assignment operators can also accept an initializer list on the right-hand side. Following is an implementation of an initializer list assignment operator for `hash_map`. It uses a copy-and-swap-like algorithm to guarantee strong exception safety.

```
template <typename Key, typename T, typename KeyEqual, typename Hash>
hash_map<Key, T, KeyEqual, Hash>& hash_map<Key, T, KeyEqual, Hash>::operator=(
    std::initializer_list<value_type> il)
{
    // Do all the work in a temporary instance
    hash_map_type newHashMap(il, mEqual, mBuckets.size(), mHash);
    swap(newHashMap); // Commit the work with only non-throwing operations
    return *this;
}
```

With this assignment operator, you can write code as follows:

```
myHash = {
    { "KeyOne", 100 },
    { "KeyTwo", 200 },
    { "KeyThree", 300 } };
```

hash_map Insertion Operations

In the earlier section, “Using the Basic Hash Map,” a simple `insert()` method is given. In this version, four `insert()` methods are provided with additional features:

- The simple `insert()` operation returns a `pair<iterator, bool>`, which indicates both where the item is inserted and whether or not it was newly created.
- The version of `insert()` that takes a hint is useless for a `hash_map`, but it is provided for symmetry with other kinds of collections. The hint is ignored, and it merely calls the first version.
- The third form of `insert()` is a method template, so ranges of elements from arbitrary containers can be inserted into the `hash_map`.
- The last form of `insert()` accepts an `initializer_list<value_type>`.

Note that technically, the following versions of `insert()` can also be provided. These accept rvalue references.

```
std::pair<iterator, bool> insert(value_type&& x);
iterator insert(const_iterator hint, value_type&& x);
```

The `hash_map` does not provide these. Additionally, there are two versions of `insert()` related to handling nodes. Nodes are discussed in Chapter 17. The `hash_map` omits these as well.

The first two `insert()` methods are implemented as follows:

```
template <typename Key, typename T, typename KeyEqual, typename Hash>
std::pair<typename hash_map<Key, T, KeyEqual, Hash>::iterator, bool>
hash_map<Key, T, KeyEqual, Hash>::insert(const value_type& x)
{
    // Try to find the element.
    auto[it, bucket] = findElement(x.first);
```

```

    bool inserted = false;
    if (it == std::end(mBuckets[bucket])) {
        // We didn't find the element, so insert a new one.
        it = mBuckets[bucket].insert(it, x);
        inserted = true;
        mSize++;
    }
    return std::make_pair(
        hash_map_iterator<hash_map_type>(bucket, it, this), inserted);
}

template <typename Key, typename T, typename KeyEqual, typename Hash>
typename hash_map<Key, T, KeyEqual, Hash>::iterator
hash_map<Key, T, KeyEqual, Hash>::insert(
    const_iterator /*hint*/, const value_type& x)
{
    // Completely ignore position.
    return insert(x).first;
}

```

The third form of `insert()` is a method template for the same reason as the constructor shown earlier: it should be able to insert elements by using iterators from containers of any type. The actual implementation uses an `insert_iterator`, described earlier in this chapter.

```

template <typename Key, typename T, typename KeyEqual, typename Hash>
template <typename InputIterator>
void hash_map<Key, T, KeyEqual, Hash>::insert(
    InputIterator first, InputIterator last)
{
    // Copy each element in the range by using an insert_iterator adaptor.
    // Give begin() as a dummy position -- insert ignores it anyway.
    std::insert_iterator<hash_map_type> inserter(*this, begin());
    std::copy(first, last, inserter);
}

```

The last `insert` operation accepts an initializer list. The implementation for `hash_map` simply forwards the work to the `insert()` method accepting an iterator range:

```

template <typename Key, typename T, typename KeyEqual, typename Hash>
void hash_map<Key, T, KeyEqual, Hash>::insert(
    std::initializer_list<value_type> il)
{
    insert(std::begin(il), std::end(il));
}

```

With this `insert()` method, you can write code as follows:

```

myHash.insert({
    { "KeyFour", 400 },
    { "KeyFive", 500 } });

```

hash_map Emplace Operations

Emplace operations construct objects in-place. They are discussed in Chapter 17. The emplace methods for `hash_map` look as follows :

```
template <typename... Args>
std::pair<iterator, bool> emplace(Args&&... args);

template <typename... Args>
iterator emplace_hint(const_iterator hint, Args&&... args);
```

The ... in these lines are not typos. These are so-called variadic templates, that is, templates with a variable number of template type parameters and a variable number of function parameters. Variadic templates are discussed in Chapter 22. This `hash_map` implementation omits emplace operations.

hash_map Erase Operations

The version of `erase()` in the earlier section, “A Basic Hash Map,” is not compliant with Standard Library requirements. You need to implement the following versions:

- A version that takes as a parameter a `key_type` and returns a `size_type` for the number of elements removed from the collection (for `hash_map` there are only two possible return values, 0 and 1).
- A version that erases a value at a specific iterator position, and returns an iterator to the element following the erased element.
- A version that erases a range of elements based on two iterators, and returns an iterator to the element following the last erased element.

The first version is implemented as follows:

```
template <typename Key, typename T, typename KeyEqual, typename Hash>
typename hash_map<Key, T, KeyEqual, Hash>::size_type
hash_map<Key, T, KeyEqual, Hash>::erase(const key_type& k)
{
    // First, try to find the element.
    auto[it, bucket] = findElement(k);
    if (it != std::end(mBuckets[bucket])) {
        // The element exists -- erase it.
        mBuckets[bucket].erase(it);
        mSize--;
        return 1;
    } else {
        return 0;
    }
}
```

The second version of `erase()` must remove the element at a specific iterator position. The iterator given is, of course, a `hash_map_iterator`. Thus, `hash_map` must have some ability to obtain the underlying bucket and `list` iterator from the `hash_map_iterator`. The approach taken here is to

make the `hash_map` class a friend of the `hash_map_iterator` (not shown in the earlier class definition). Here is the implementation of this version of `erase()`:

```
template <typename Key, typename T, typename KeyEqual, typename Hash>
typename hash_map<Key, T, KeyEqual, Hash>::iterator
    hash_map<Key, T, KeyEqual, Hash>::erase(iterator position)
{
    iterator next = position;
    ++next;
    // Erase the element from its bucket.
    mBuckets[position.mBucketIndex].erase(position.mListIterator);
    mSize--;
    return next;
}
```

The final version of `erase()` removes a range of elements. It iterates from `first` to `last`, calling `erase()` on each element, thus letting the previous version of `erase()` do all the work:

```
template <typename Key, typename T, typename KeyEqual, typename Hash>
typename hash_map<Key, T, KeyEqual, Hash>::iterator
    hash_map<Key, T, KeyEqual, Hash>::erase(iterator first, iterator last)
{
    // Erase all the elements in the range.
    for (iterator next = first; next != last; ) {
        next = erase(next);
    }
    return last;
}
```

hash_map Accessor Operations

The standard requires methods called `key_eq()` and `hash_function()` to retrieve the equality predicate and the hash function respectively:

```
template <typename Key, typename T, typename KeyEqual, typename Hash>
typename hash_map<Key, T, KeyEqual, Hash>::key_equal
    hash_map<Key, T, KeyEqual, Hash>::key_eq() const
{
    return mEqual;
}

template <typename Key, typename T, typename KeyEqual, typename Hash>
typename hash_map<Key, T, KeyEqual, Hash>::hasher
    hash_map<Key, T, KeyEqual, Hash>::hash_function() const
{
    return mHash;
}
```

The `find()` method is identical to the version shown earlier for the basic `hash_map`, except for the return code. Instead of returning a pointer to the element, it constructs a `hash_map_iterator` referring to it:

```
template <typename Key, typename T, typename KeyEqual, typename Hash>
typename hash_map<Key, T, KeyEqual, Hash>::iterator
    hash_map<Key, T, KeyEqual, Hash>::find(const key_type& k)
{
```



```

    // Use the findElement() helper, and C++17 structured bindings.
    auto[it, bucket] = findElement(k);
    if (it == std::end(mBuckets[bucket])) {
        // Element not found -- return the end iterator.
        return end();
    }
    // Element found -- convert the bucket/iterator to a hash_map_iterator.
    return hash_map_iterator<hash_map_type>(bucket, it, this);
}

```

The `const` version of `find()` returns a `const_hash_map_iterator`. It uses `const_cast` to call the non-`const` version of `find()` to avoid code duplication. Note that the non-`const` `find()` returns a `hash_map_iterator`, which is convertible to a `const_hash_map_iterator`.

```

template <typename Key, typename T, typename KeyEqual, typename Hash>
typename hash_map<Key, T, KeyEqual, Hash>::const_iterator
    hash_map<Key, T, KeyEqual, Hash>::find(const key_type& k) const
{
    return const_cast<hash_map_type*>(this)->find(k);
}

```

The implementations of both versions of `equal_range()` are identical, except that one returns a pair of `hash_map_iterators` while the other returns a pair of `const_hash_map_iterators`. They both simply forward the request to `find()`. A `hash_map` cannot have elements with duplicate keys, so the result of `equal_range()` for `hash_map` is always a pair of identical iterators.

```

template <typename Key, typename T, typename KeyEqual, typename Hash>
std::pair<
    typename hash_map<Key, T, KeyEqual, Hash>::iterator,
    typename hash_map<Key, T, KeyEqual, Hash>::iterator>
    hash_map<Key, T, KeyEqual, Hash>::equal_range(const key_type& k)
{
    auto it = find(k);
    return std::make_pair(it, it);
}

```

Because `hash_map` does not allow duplicate keys, `count()` can only return 1 or 0: 1 if it finds the element, and 0 if it doesn't. The implementation just wraps a call to `find()`. The `find()` method returns the end iterator if it can't find the element. `count()` retrieves an end iterator by calling `end()` in order to compare it.

```

template <typename Key, typename T, typename KeyEqual, typename Hash>
typename hash_map<Key, T, KeyEqual, Hash>::size_type
    hash_map<Key, T, KeyEqual, Hash>::count(const key_type& k) const
{
    // There are either 1 or 0 elements matching key k.
    // If we can find a match, return 1, otherwise return 0.
    if (find(k) == end()) {
        return 0;
    } else {
        return 1;
    }
}

```

The final method, `operator[]`, is not required by the standard, but is provided for convenience of the programmer, and to be symmetric with `std::map`. The prototype is identical to the one for `std::map`. The comments explain the potentially confusing one-line implementation.

```
template <typename Key, typename T, typename KeyEqual, typename Hash>
T& hash_map<Key, T, KeyEqual, Hash>::operator[] (const key_type& k)
{
    // It's a bit cryptic, but it basically attempts to insert
    // a new key/value pair of k and a zero-initialized value. Regardless
    // of whether the insert succeeds or fails, insert() returns a pair of
    // an iterator/bool. The iterator refers to a key/value pair, the
    // second element of which is the value we want to return.
    return ((insert(std::make_pair(k, T()))).first)->second;
}
```

hash_map Bucket Operations

Unordered associative containers should also provide a number of bucket-related methods:

- `bucket_count()` returns the number of buckets in the container.
- `max_bucket_count()` returns the maximum number of buckets that are supported.
- `bucket(key)` returns the index of the bucket to which the given key maps.
- `bucket_size(n)` returns the number of elements in the bucket with given index.
- `begin(n)`, `end(n)`, `cbegin(n)`, `kend(n)` return local begin and end iterators to the bucket with given index.

Here are the implementations for the `hash_map`:

```
template <typename Key, typename T, typename KeyEqual, typename Hash>
typename hash_map<Key, T, KeyEqual, Hash>::size_type
hash_map<Key, T, KeyEqual, Hash>::bucket_count() const
{
    return mBuckets.size();
}

template <typename Key, typename T, typename KeyEqual, typename Hash>
typename hash_map<Key, T, KeyEqual, Hash>::size_type
hash_map<Key, T, KeyEqual, Hash>::max_bucket_count() const
{
    return mBuckets.max_size();
}

template <typename Key, typename T, typename KeyEqual, typename Hash>
typename hash_map<Key, T, KeyEqual, Hash>::size_type
hash_map<Key, T, KeyEqual, Hash>::bucket(const Key& k) const
{
    return const_cast<hash_map_type*>(this)->findElement(k).second;
}
```

```

template <typename Key, typename T, typename KeyEqual, typename Hash>
typename hash_map<Key, T, KeyEqual, Hash>::size_type
    hash_map<Key, T, KeyEqual, Hash>::bucket_size(size_type n) const
{
    return mBuckets[n].size();
}

template <typename Key, typename T, typename KeyEqual, typename Hash>
typename hash_map<Key, T, KeyEqual, Hash>::local_iterator
    hash_map<Key, T, KeyEqual, Hash>::begin(size_type n)
{
    return mBuckets[n].begin();
}

```

The implementations for the other `begin(n)`, `end(n)`, `cbegin(n)`, and `cead(n)` methods are similar; they simply forward the call to the correct bucket list based on the given index.

Finally, an unordered associative container should also provide `load_factor()`, `max_load_factor()`, `rehash()`, and `reserve()` methods. These are omitted for `hash_map`.

Note on Sequential Containers

The `hash_map` developed in the preceding sections is an *unordered associative container*. However, you could also write a *sequential container*, or an *ordered associative container*, in which case you would need to follow a different set of requirements. Instead of listing them here, it's easier to point out that the `deque` container follows the prescribed sequential container requirements almost exactly. The only difference is that it provides an extra `resize()` method (not required by the standard). An example of an ordered associative container is the `map`, on which you can model your own ordered associative containers.

SUMMARY

The final example in this chapter showed almost the complete development of a `hash_map` unordered associative container and its iterators. This `hash_map` implementation is given here only to teach you how to write your own Standard Library-compliant containers and iterators. C++ does include its own set of unordered associative containers. You should use those instead of your own implementation.

In the process of reading this chapter, you hopefully gained an appreciation for the steps involved in developing containers. Even if you never write another Standard Library algorithm or container, you understand better the Standard Library's mentality and capabilities, and you can put it to better use.

This chapter concludes the tour of the Standard Library. Even with all the details given in this book, some features are still omitted. If this material excited you, and you would like more information, consult some of the resources in Appendix B. Don't feel compelled to use all the features discussed here. Forcing them into your programs without a true need will just complicate your code. However, I encourage you to consider incorporating aspects of the Standard Library into your programs where they make sense. Start with the containers, maybe throw in an algorithm or two, and before you know it, you'll be a convert!

22

Advanced Templates

WHAT'S IN THIS CHAPTER?

- The different kinds of template parameters
- How to use partial specialization
- How to write recursive templates
- What variadic templates are
- How to write type-safe variable argument functions using variadic templates
- What `constexpr if` statements are
- How to use folding expressions
- What metaprogramming is and how to use it
- What type traits can be used for

WROX.COM DOWNLOADS FOR THIS CHAPTER

Please note that all the code examples for this chapter are available as a part of this chapter's code download on the book's website at www.wrox.com/go/proc++4e on the Download Code tab.

Chapter 12 covers the most widely used features of class and function templates. If you are interested in only a basic knowledge of templates so that you can better understand how the Standard Library works, or perhaps write your own simple classes, you can skip this chapter on advanced templates. However, if templates interest you and you want to uncover their full power, continue reading this chapter to learn about some of the more obscure, but fascinating, details.

MORE ABOUT TEMPLATE PARAMETERS

There are actually three kinds of template parameters: type, non-type, and template template (no, you're not seeing double: that really is the name). So far, you've seen examples of type and non-type parameters (in Chapter 12), but not template template parameters. There are also some tricky aspects to both type and non-type parameters that are not covered in Chapter 12. This section goes deeper into all three types of template parameters.

More about Template Type Parameters

Template type parameters are the main purpose of templates. You can declare as many type parameters as you want. For example, you could add to the grid template from Chapter 12 a second type parameter specifying another templated class container on which to build the grid. The Standard Library defines several templated container classes, including `vector` and `deque`. The original grid class uses a `vector` of `vectors` to store the elements of a grid. A user of the `Grid` class might want to use a `vector` of `deques` instead. With another template type parameter, you can allow the user to specify whether they want the underlying container to be a `vector` or a `deque`. Here is the class definition with the additional template parameter:

```
template <typename T, typename Container>
class Grid
{
public:
    explicit Grid(size_t width = kDefaultWidth,
                 size_t height = kDefaultHeight);
    virtual ~Grid() = default;

    // Explicitly default a copy constructor and assignment operator.
    Grid(const Grid& src) = default;
    Grid<T, Container>& operator=(const Grid& rhs) = default;

    // Explicitly default a move constructor and assignment operator.
    Grid(Grid&& src) = default;
    Grid<T, Container>& operator=(Grid&& rhs) = default;

    typename Container::value_type& at(size_t x, size_t y);
    const typename Container::value_type& at(size_t x, size_t y) const;

    size_t getHeight() const { return mHeight; }
    size_t getWidth() const { return mWidth; }

    static const size_t kDefaultWidth = 10;
    static const size_t kDefaultHeight = 10;

private:
    void verifyCoordinate(size_t x, size_t y) const;

    std::vector<Container> mCells;
    size_t mWidth = 0, mHeight = 0;
};
```

This template now has two parameters: `T` and `Container`. Thus, wherever you previously referred to `Grid<T>`, you must now refer to `Grid<T, Container>` to specify both template parameters. Another change is that `mCells` is now a vector of `Containers` instead of a vector of vectors.

Here is the constructor definition:

```
template <typename T, typename Container>
Grid<T, Container>::Grid(size_t width, size_t height)
    : mWidth(width), mHeight(height)
{
    mCells.resize(mWidth);
    for (auto& column : mCells) {
        column.resize(mHeight);
    }
}
```

This constructor assumes that the `Container` type has a `resize()` method. If you try to instantiate this template by specifying a type that has no `resize()` method, the compiler will generate an error.

The return type of the `at()` methods is the type of the elements that is stored inside the given container type. You can access this type with `typename Container::value_type`.

Here are the implementations of the remaining methods:

```
template <typename T, typename Container>
void Grid<T, Container>::verifyCoordinate(size_t x, size_t y) const
{
    if (x >= mWidth || y >= mHeight) {
        throw std::out_of_range("");
    }
}

template <typename T, typename Container>
const typename Container::value_type&
Grid<T, Container>::at(size_t x, size_t y) const
{
    verifyCoordinate(x, y);
    return mCells[x][y];
}

template <typename T, typename Container>
typename Container::value_type&
Grid<T, Container>::at(size_t x, size_t y)
{
    return const_cast<typename Container::value_type&>(
        std::as_const(*this).at(x, y));
}
```

Now you can instantiate and use `Grid` objects like this:

```
Grid<int, vector<optional<int>>> myIntVectorGrid;
Grid<int, deque<optional<int>>> myIntDequeGrid;

myIntVectorGrid.at(3, 4) = 5;
cout << myIntVectorGrid.at(3, 4).value_or(0) << endl;
```

```

myIntDequeGrid.at(1, 2) = 3;
cout << myIntDequeGrid.at(1, 2).value_or(0) << endl;

Grid<int, vector<optional<int>>> grid2(myIntVectorGrid);
grid2 = myIntVectorGrid;

```

The use of the word `Container` for the parameter name doesn't mean that the type really must be a container. You could try to instantiate the `Grid` class with an `int` instead:

```
Grid<int, int> test; // WILL NOT COMPILE
```

This line does not compile, but it also might not give you the error you expect. It does not complain that the second type argument is an `int` instead of a container. It tells you something more cryptic. For example, Microsoft Visual C++ tells you that “‘Container’: must be a class or namespace when followed by ‘:.’” That's because the compiler attempts to generate a `Grid` class with `int` as the `Container`. Everything works fine until it tries to process this line in the class template definition:

```
typename Container::value_type& at(size_t x, size_t y);
```

At that point, the compiler realizes that `Container` is an `int`, which does not have an embedded `value_type` type alias.

Just as with function parameters, you can give template parameters default values. For example, you might want to say that the default container for your `Grid` is a `vector`. The class template definition would look like this:

```

template <typename T, typename Container = std::vector<std::optional<T>>>
class Grid
{
    // Everything else is the same as before.
};

```

You can use the type `T` from the first template parameter as the argument to the `optional` template in the default value for the second template parameter. The C++ syntax requires that you do not repeat the default value in the template header line for method definitions. With this default argument, clients can now instantiate a grid with the option of specifying an underlying container:

```

Grid<int, deque<optional<int>>> myDequeGrid;
Grid<int, vector<optional<int>>> myVectorGrid;
Grid<int> myVectorGrid2(myVectorGrid);

```

This approach is used by the Standard Library. The `stack`, `queue`, and `priority_queue` class templates all take a template type parameter, with a default value, specifying the underlying container.

Introducing Template Template Parameters

There is one problem with the `Container` parameter in the previous section. When you instantiate the class template, you write something like this:

```
Grid<int, vector<optional<int>>> myIntGrid;
```

Note the repetition of the `int` type. You must specify that it's the element type both of the `Grid` and of the `optional` inside the `vector`. What if you wrote this instead:

```
Grid<int, vector<optional<SpreadsheetCell>>> myIntGrid;
```

That wouldn't work very well. It would be nice to be able to write the following, so that you couldn't make that mistake:

```
Grid<int, vector> myIntGrid;
```

The `Grid` class should be able to figure out that it wants a `vector` of optionals of ints. The compiler won't allow you to pass that argument to a normal type parameter, though, because `vector` by itself is not a type but a template.

If you want to take a template as a template parameter, you must use a special kind of parameter called a *template template parameter*. Specifying a template template parameter is sort of like specifying a function pointer parameter in a normal function. Function pointer types include the return type and parameter types of a function. Similarly, when you specify a template template parameter, the full specification of the template template parameter includes the parameters to that template.

For example, containers such as `vector` and `deque` have a template parameter list that looks something like the following. The `E` parameter is the element type. The `Allocator` parameter is covered in Chapter 17.

```
template <typename E, typename Allocator = std::allocator<E>>
class vector
{
    // Vector definition
};
```

To pass such a container as a template template parameter, all you have to do is copy and paste the declaration of the class template (in this example, `template <typename E, typename Allocator = std::allocator<E>> class vector`), replace the class name (`vector`) with a parameter name (`Container`), and use that as the template template parameter of another template declaration—`Grid` in this example—instead of a simple type name. Given the preceding template specification, here is the class template definition for the `Grid` class that takes a container template as its second template parameter:

```
template <typename T,
template <typename E, typename Allocator = std::allocator<E>> class Container
= std::vector>
class Grid
{
public:
    // Omitted code that is the same as before
    std::optional<T>& at(size_t x, size_t y);
    const std::optional<T>& at(size_t x, size_t y) const;
    // Omitted code that is the same as before
private:
    void verifyCoordinate(size_t x, size_t y) const;

    std::vector<Container<std::optional<T>>> mCells;
    size_t mWidth = 0, mHeight = 0;
};
```

What is going on here? The first template parameter is the same as before: the element type `T`. The second template parameter is now a template itself for a container such as `vector` or `deque`. As you saw earlier, this “template type” must take two parameters: an element type `E` and an allocator type.

Note the repetition of the word `class` after the nested template parameter list. The name of this parameter in the `Grid` template is `Container` (as before). The default value is now `vector`, instead of `vector<T>`, because the `Container` parameter is now a template instead of an actual type.

The syntax rule for a template template parameter, more generically, is this:

```
template <..., template <TemplateTypeParams> class ParameterName, ...>
```

NOTE Starting with C++17, you can also use the `typename` keyword instead of `class`, as in the following example:

```
template <..., template <TemplateTypeParams> typename
ParameterName, ...>
```

Instead of using `Container` by itself in the code, you must specify `Container<std::optional<T>>` as the container type. For example, the declaration of `mCells` is now as follows:

```
std::vector<Container<std::optional<T>>> mCells;
```

The method definitions don't need to change, except that you must change the template lines, for example:

```
template <typename T,
template <typename E, typename Allocator = std::allocator<E>> class Container>
void Grid<T, Container>::verifyCoordinate(size_t x, size_t y) const
{
    if (x >= mWidth || y >= mHeight) {
        throw std::out_of_range("");
    }
}
```

This `Grid` template can be used as follows:

```
Grid<int, vector> myGrid;
myGrid.at(1, 2) = 3;
cout << myGrid.at(1, 2).value_or(0) << endl;
Grid<int, vector> myGrid2(myGrid);
```

This C++ syntax is a bit convoluted because it is trying to allow for maximum flexibility. Try not to get bogged down in the syntax here, and keep the main concept in mind: you can pass templates as parameters to other templates.

More about Non-type Template Parameters

You might want to allow the user to specify a default element used to initialize each cell in the grid. Here is a perfectly reasonable approach to implement this goal. It uses `T()` as the default value for the second template parameter.

```
template <typename T, const T DEFAULT = T()>
class Grid
{
    // Identical as before.
};
```

This definition is legal. You can use the type `T` from the first parameter as the type for the second parameter, and non-type parameters can be `const` just like function parameters. You can use this initial value for `T` to initialize each cell in the grid:

```
template <typename T, const T DEFAULT>
Grid<T, DEFAULT>::Grid(size_t width, size_t height)
    : mWidth(width), mHeight(height)
{
    mCells.resize(mWidth);
    for (auto& column : mCells) {
        column.resize(mHeight);
        for (auto& element : column) {
            element = DEFAULT;
        }
    }
}
```

The other method definitions stay the same, except that you must add the second template parameter to the template lines, and all the instances of `Grid<T>` become `Grid<T, DEFAULT>`. After making those changes, you can instantiate grids with an initial value for all the elements:

```
Grid<int> myIntGrid;           // Initial value is 0
Grid<int, 10> myIntGrid2;    // Initial value is 10
```

The initial value can be any integer you want. However, suppose that you try to create a SpreadsheetCell Grid:

```
SpreadsheetCell defaultCell;
Grid<SpreadsheetCell, defaultCell> mySpreadsheet; // WILL NOT COMPILE
```

That line leads to a compiler error because you cannot pass objects as arguments to non-type parameters.

WARNING *Non-type parameters cannot be objects, or even doubles or floats. They are restricted to integral types, enums, pointers, and references.*

This example illustrates one of the vagaries of class templates: they can work correctly on one type but fail to compile for another type.

A more comprehensive way of allowing the user to specify an initial element value for a grid uses a reference to a `T` as the non-type template parameter. Here is the new class definition:

```
template <typename T, const T& DEFAULT>
class Grid
{
    // Everything else is the same as the previous example.
};
```

Now you can instantiate this class template for any type. The C++17 standard says that the reference you pass as the second template argument must be a converted constant expression of the type of the template parameter. It is not allowed to refer to a subobject, a temporary object, a string literal, the

result of a `typeid` expression, or the predefined `__func__` variable. The following example declares `int` and `SpreadsheetCell` grids using initial values:

```
int main()
{
    int defaultInt = 11;
    Grid<int, defaultInt> myIntGrid;

    SpreadsheetCell defaultCell(1.2);
    Grid<SpreadsheetCell, defaultCell> mySpreadsheet;
    return 0;
}
```

However, those are the rules of C++17, and unfortunately, most compilers do not implement those rules yet. Before C++17, an argument passed to a reference non-type template parameter could not be a temporary, and could not be a named lvalue without linkage (external or internal). So, here is the same example but using the pre-C++17 rules. The initial values are defined with internal linkage:

```
namespace {
    int defaultInt = 11;
    SpreadsheetCell defaultCell(1.2);
}

int main()
{
    Grid<int, defaultInt> myIntGrid;
    Grid<SpreadsheetCell, defaultCell> mySpreadsheet;
    return 0;
}
```

CLASS TEMPLATE PARTIAL SPECIALIZATION

The `const char*` class specialization of the `Grid` class template shown in Chapter 12 is called a *full class template specialization* because it specializes the `Grid` template for every template parameter. There are no template parameters left in the specialization. That's not the only way you can specialize a class; you can also write a *partial class specialization*, in which you specialize some template parameters but not others. For example, recall the basic version of the `Grid` template with width and height non-type parameters:

```
template <typename T, size_t WIDTH, size_t HEIGHT>
class Grid
{
public:
    Grid() = default;
    virtual ~Grid() = default;

    // Explicitly default a copy constructor and assignment operator.
    Grid(const Grid& src) = default;
    Grid& operator=(const Grid& rhs) = default;

    std::optional<T>& at(size_t x, size_t y);
    const std::optional<T>& at(size_t x, size_t y) const;

    size_t getHeight() const { return HEIGHT; }
    size_t getWidth() const { return WIDTH; }
```

```

private:
    void verifyCoordinate(size_t x, size_t y) const;

    std::optional<T> mCells[WIDTH][HEIGHT];
};

```

You could specialize this class template for `const char*` C-style strings like this:

```

#include "Grid.h" // The file containing the Grid template definition

template <size_t WIDTH, size_t HEIGHT>
class Grid<const char*, WIDTH, HEIGHT>
{
public:
    Grid() = default;
    virtual ~Grid() = default;

    // Explicitly default a copy constructor and assignment operator.
    Grid(const Grid& src) = default;
    Grid& operator=(const Grid& rhs) = default;

    std::optional<std::string>& at(size_t x, size_t y);
    const std::optional<std::string>& at(size_t x, size_t y) const;

    size_t getHeight() const { return HEIGHT; }
    size_t getWidth() const { return WIDTH; }
private:
    void verifyCoordinate(size_t x, size_t y) const;

    std::optional<std::string> mCells[WIDTH][HEIGHT];
};

```

In this case, you are not specializing all the template parameters. Therefore, your template line looks like this:

```

template <size_t WIDTH, size_t HEIGHT>
class Grid<const char*, WIDTH, HEIGHT>

```

Note that the template has only two parameters: `WIDTH` and `HEIGHT`. However, you're writing a `Grid` class for three arguments: `T`, `WIDTH`, and `HEIGHT`. Thus, your template parameter list contains two parameters, and the explicit `Grid<const char*, WIDTH, HEIGHT>` contains three arguments. When you instantiate the template, you must still specify three parameters. You can't instantiate the template with only height and width.

```

Grid<int, 2, 2> myIntGrid; // Uses the original Grid
Grid<const char*, 2, 2> myStringGrid; // Uses the partial specialization
Grid<2, 3> test; // DOES NOT COMPILE! No type specified.

```

Yes, the syntax is confusing. And it gets worse. In partial specializations, unlike in full specializations, you include the template line in front of every method definition, as in the following example:

```

template <size_t WIDTH, size_t HEIGHT>
const std::optional<std::string>&
    Grid<const char*, WIDTH, HEIGHT>::at(size_t x, size_t y) const
{
    verifyCoordinate(x, y);
    return mCells[x][y];
}

```

You need this template line with two parameters to show that this method is parameterized on those two parameters. Note that wherever you refer to the full class name, you must use `Grid<const char*, WIDTH, HEIGHT>`.

The previous example does not show the true power of partial specialization. You can write specialized implementations for a subset of possible types without specializing individual types. For example, you can write a specialization of the `Grid` class template for all pointer types. The copy constructor and assignment operator of this specialization could perform deep copies of objects to which pointers point, instead of shallow copies.

Here is the class definition, assuming that you're specializing the initial version of `Grid` with only one parameter. In this implementation, `Grid` becomes the owner of supplied data, so it automatically frees the memory when necessary.

```
#include "Grid.h"
#include <memory>

template <typename T>
class Grid<T*>
{
public:
    explicit Grid(size_t width = kDefaultWidth,
                 size_t height = kDefaultHeight);
    virtual ~Grid() = default;

    // Copy constructor and copy assignment operator.
    Grid(const Grid& src);
    Grid<T*>& operator=(const Grid& rhs);

    // Explicitly default a move constructor and assignment operator.
    Grid(Grid&& src) = default;
    Grid<T*>& operator=(Grid&& rhs) = default;

    void swap(Grid& other) noexcept;

    std::unique_ptr<T>& at(size_t x, size_t y);
    const std::unique_ptr<T>& at(size_t x, size_t y) const;

    size_t getHeight() const { return mHeight; }
    size_t getWidth() const { return mWidth; }

    static const size_t kDefaultWidth = 10;
    static const size_t kDefaultHeight = 10;

private:
    void verifyCoordinate(size_t x, size_t y) const;

    std::vector<std::vector<std::unique_ptr<T>>> mCells;
    size_t mWidth = 0, mHeight = 0;
};
```

As usual, these two lines are the crux of the matter:

```
template <typename T>
class Grid<T*>
```

The syntax says that this class is a specialization of the `Grid` template for all pointer types. You are providing the implementation only in cases where `T` is a pointer type. Note that if you instantiate a grid like `Grid<int*> myIntGrid`, then `T` will actually be `int`, not `int*`. That's a bit unintuitive, but unfortunately, that's the way it works. Here is an example of using this partial specialization:

```
Grid<int> myIntGrid; // Uses the non-specialized grid
Grid<int*> psGrid(2, 2); // Uses the partial specialization for pointer types

psGrid.at(0, 0) = make_unique<int>(1);
psGrid.at(0, 1) = make_unique<int>(2);
psGrid.at(1, 0) = make_unique<int>(3);

Grid<int*> psGrid2(psGrid);
Grid<int*> psGrid3;
psGrid3 = psGrid2;

auto& element = psGrid2.at(1, 0);
if (element) {
    cout << *element << endl;
    *element = 6;
}
cout << *psGrid.at(1, 0) << endl; // psGrid is not modified
cout << *psGrid2.at(1, 0) << endl; // psGrid2 is modified
```

Here is the output:

```
3
3
6
```

The implementations of the methods are rather straightforward, except for the copy constructor, which uses the copy constructor of individual elements to make a deep copy of them:

```
template <typename T>
Grid<T*>::Grid(const Grid& src)
    : Grid(src.mWidth, src.mHeight)
{
    // The ctor-initializer of this constructor delegates first to the
    // non-copy constructor to allocate the proper amount of memory.

    // The next step is to copy the data.
    for (size_t i = 0; i < mWidth; i++) {
        for (size_t j = 0; j < mHeight; j++) {
            // Make a deep copy of the element by using its copy constructor.
            if (src.mCells[i][j]) {
                mCells[i][j].reset(new T(*(src.mCells[i][j])));
            }
        }
    }
}
```

EMULATING FUNCTION PARTIAL SPECIALIZATION WITH OVERLOADING

The C++ standard does not permit partial template specialization of functions. Instead, you can overload the function with another template. The difference is subtle. Suppose that you want to write a specialization of the `Find()` function template, presented in Chapter 12, that dereferences the pointers to use `operator==` directly on the objects pointed to. Following the syntax for class template partial specialization, you might be tempted to write this:

```
template <typename T>
size_t Find<T*>(T* const& value, T* const* arr, size_t size)
{
    for (size_t i = 0; i < size; i++) {
        if (*arr[i] == *value) {
            return i; // Found it; return the index
        }
    }
    return NOT_FOUND; // failed to find it; return NOT_FOUND
}
```

However, that syntax declares a partial specialization of the function template, which the C++ standard does not allow. The correct way to implement the behavior you want is to write a new template for `Find()`. The difference might seem trivial and academic, but it won't compile otherwise.

```
template <typename T>
size_t Find(T* const& value, T* const* arr, size_t size)
{
    for (size_t i = 0; i < size; i++) {
        if (*arr[i] == *value) {
            return i; // Found it; return the index
        }
    }
    return NOT_FOUND; // failed to find it; return NOT_FOUND
}
```

Note that the first parameter to this version of `Find()` is `T* const&`. This is done to make it symmetric with the original `Find()` function template, which accepts a `const T&` as a first parameter. However, in this case, using `T*` instead of `T* const&` for the first parameter of the partial specialization of `Find()` works as well.

You can define in one program the original `Find()` template, the overloaded `Find()` for partial specialization on pointer types, the complete specialization for `const char*s`, and the overloaded `Find()` just for `const char*s`. The compiler selects the appropriate version to call based on its deduction rules.

NOTE *Between all overloaded versions, function template specializations, and specific function template instantiations, the compiler always chooses the “most specific” one to call. If a non-template version is just as specific as a function template instantiation, then the compiler prefers the non-template version.*

The following code calls `Find()` several times. The comments say which version of `Find()` is called.

```

size_t res = NOT_FOUND;

int myInt = 3, intArray[] = { 1, 2, 3, 4 };
size_t sizeArray = std::size(intArray);
res = Find(myInt, intArray, sizeArray); // calls Find<int> by deduction
res = Find<int>(myInt, intArray, sizeArray); // calls Find<int> explicitly

double myDouble = 5.6, doubleArray[] = { 1.2, 3.4, 5.7, 7.5 };
sizeArray = std::size(doubleArray);
// calls Find<double> by deduction
res = Find(myDouble, doubleArray, sizeArray);
// calls Find<double> explicitly
res = Find<double>(myDouble, doubleArray, sizeArray);

const char* word = "two";
const char* words[] = { "one", "two", "three", "four" };
sizeArray = std::size(words);
// calls template specialization for const char*s
res = Find<const char*>(word, words, sizeArray);
// calls overloaded Find for const char*s
res = Find(word, words, sizeArray);

int *intPointer = &myInt, *pointerArray[] = { &myInt, &myInt };
sizeArray = std::size(pointerArray);
// calls the overloaded Find for pointers
res = Find(intPointer, pointerArray, sizeArray);

SpreadsheetCell cell1(10), cellArray[] = { SpreadsheetCell(4),
SpreadsheetCell(10) };
sizeArray = std::size(cellArray);
// calls Find<SpreadsheetCell> by deduction
res = Find(cell1, cellArray, sizeArray);
// calls Find<SpreadsheetCell> explicitly
res = Find<SpreadsheetCell>(cell1, cellArray, sizeArray);

SpreadsheetCell *cellPointer = &cell1;
SpreadsheetCell *cellPointerArray[] = { &cell1, &cell1 };
sizeArray = std::size(cellPointerArray);
// Calls the overloaded Find for pointers
res = Find(cellPointer, cellPointerArray, sizeArray);

```

TEMPLATE RECURSION

Templates in C++ provide capabilities that go far beyond the simple classes and functions you have seen so far in this chapter and Chapter 12. One of these capabilities is *template recursion*. This section first provides a motivation for template recursion, and then shows how to implement it.

This section uses operator overloading, discussed in Chapter 15. If you skipped that chapter or are unfamiliar with the syntax for overloading operator [], consult Chapter 15 before continuing.

An N-Dimensional Grid: First Attempt

Up to now, the `Grid` template example supported only two dimensions, which limited its usefulness. What if you wanted to write a 3-D Tic-Tac-Toe game or write a math program with four-dimensional matrices? You could, of course, write a templated or non-templated class for each of those dimensions. However, that would repeat a lot of code. Another approach would be to write only a single-dimensional grid. Then, you could create a `Grid` of any dimension by instantiating the `Grid` with another `Grid` as its element type. This `Grid` element type could itself be instantiated with a `Grid` as its element type, and so on. Here is the implementation of the `OneDGrid` class template. It's simply a one-dimensional version of the `Grid` template from earlier examples, with the addition of a `resize()` method, and the substitution of `operator[]` for `at()`. Just as with Standard Library containers such as `vector`, the `operator[]` implementation does not perform any bounds checking. Also, for this example, `mElements` stores instances of `T` instead of instances of `std::optional<T>`.

```
template <typename T>
class OneDGrid
{
public:
    explicit OneDGrid(size_t size = kDefaultSize);
    virtual ~OneDGrid() = default;

    T& operator[] (size_t x);
    const T& operator[] (size_t x) const;

    void resize(size_t newSize);
    size_t getSize() const { return mElements.size(); }

    static const size_t kDefaultSize = 10;
private:
    std::vector<T> mElements;
};

template <typename T>
OneDGrid<T>::OneDGrid(size_t size)
{
    resize(size);
}

template <typename T>
void OneDGrid<T>::resize(size_t newSize)
{
    mElements.resize(newSize);
}

template <typename T>
T& OneDGrid<T>::operator[] (size_t x)
{
    return mElements[x];
}
```

```

template <typename T>
const T& OneDGrid<T>::operator[] (size_t x) const
{
    return mElements[x];
}

```

With this implementation of `OneDGrid`, you can create multidimensional grids like this:

```

OneDGrid<int> singleDGrid;
OneDGrid<OneDGrid<int>> twoDGrid;
OneDGrid<OneDGrid<OneDGrid<int>>> threeDGrid;
singleDGrid[3] = 5;
twoDGrid[3][3] = 5;
threeDGrid[3][3][3] = 5;

```

This code works fine, but the declarations are messy. As you will see in the next section, you can do better.

A Real N-Dimensional Grid

You can use template recursion to write a “real” N -dimensional grid because dimensionality of grids is essentially recursive. You can see that in this declaration:

```

OneDGrid<OneDGrid<OneDGrid<int>>> threeDGrid;

```

You can think of each nested `OneDGrid` as a recursive step, with the `OneDGrid` of `int` as the base case. In other words, a three-dimensional grid is a single-dimensional grid of single-dimensional grids of single-dimensional grids of ints. Instead of requiring the user to do this recursion, you can write a class template that does it for you. You can then create N -dimensional grids like this:

```

NDGrid<int, 1> singleDGrid;
NDGrid<int, 2> twoDGrid;
NDGrid<int, 3> threeDGrid;

```

The `NDGrid` class template takes a type for its element and an integer specifying its “dimensionality.” The key insight here is that the element type of the `NDGrid` is not the element type specified in the template parameter list, but is in fact another `NDGrid` of dimensionality one less than the current one. In other words, a three-dimensional grid is a vector of two-dimensional grids; the two-dimensional grids are each vectors of one-dimensional grids.

With recursion, you need a base case. You can write a partial specialization of the `NDGrid` for dimensionality of 1, in which the element type is not another `NDGrid`, but is in fact the element type specified by the template parameter.

Here is the general `NDGrid` template definition, with highlights showing where it differs from the `OneDGrid` shown in the previous section:

```

template <typename T, size_t N>
class NDGrid
{
public:
    explicit NDGrid(size_t size = kDefaultSize);
    virtual ~NDGrid() = default;

```

```

    NDGrid<T, N-1>& operator[](size_t x);
    const NDGrid<T, N-1>& operator[](size_t x) const;

    void resize(size_t newSize);
    size_t getSize() const { return mElements.size(); }

    static const size_t kDefaultSize = 10;
private:
    std::vector<NDGrid<T, N-1>> mElements;
};

```

Note that `mElements` is a vector of `NDGrid<T, N-1>`; this is the recursive step. Also, `operator[]` returns a reference to the element type, which is again `NDGrid<T, N-1>`, not `T`.

The template definition for the base case is a partial specialization for dimension 1:

```

template <typename T>
class NDGrid<T, 1>
{
public:
    explicit NDGrid(size_t size = kDefaultSize);
    virtual ~NDGrid() = default;

    T& operator[](size_t x);
    const T& operator[](size_t x) const;

    void resize(size_t newSize);
    size_t getSize() const { return mElements.size(); }

    static const size_t kDefaultSize = 10;
private:
    std::vector<T> mElements;
};

```

Here the recursion ends: the element type is `T`, not another template instantiation.

The trickiest aspect of the implementations, other than the template recursion itself, is appropriately sizing each dimension of the grid. This implementation creates the N -dimensional grid with every dimension of equal size. It's significantly more difficult to specify a separate size for each dimension. However, even with this simplification, there is still a problem: the user should have the ability to create the array with a specified size, such as 20 or 50. Thus, the constructor takes an integer size parameter. However, when you dynamically resize a vector of sub-grids, you cannot pass this size value on to the sub-grid elements because vectors create objects using their default constructor. Thus, you must explicitly call `resize()` on each grid element of the vector. That code follows. The base case doesn't need to resize its elements because the elements are `T`s, not grids.

Here are the implementations of the general `NDGrid` template, with highlights showing the differences from the `OneDGrid`:

```

template <typename T, size_t N>
NDGrid<T, N>::NDGrid(size_t size)
{
    resize(size);
}

```

```

template <typename T, size_t N>
void NDGrid<T, N>::resize(size_t newSize)
{
    mElements.resize(newSize);
    // Resizing the vector calls the 0-argument constructor for
    // the NDGrid<T, N-1> elements, which constructs
    // them with the default size. Thus, we must explicitly call
    // resize() on each of the elements to recursively resize all
    // nested Grid elements.
    for (auto& element : mElements) {
        element.resize(newSize);
    }
}

template <typename T, size_t N>
NDGrid<T, N-1>& NDGrid<T, N>::operator[](size_t x)
{
    return mElements[x];
}

template <typename T, size_t N>
const NDGrid<T, N-1>& NDGrid<T, N>::operator[](size_t x) const
{
    return mElements[x];
}

```

Now, here are the implementations of the partial specialization (base case). Note that you must rewrite a lot of the code because you don't inherit any implementations with specializations. Highlights show the differences from the non-specialized NDGrid.

```

template <typename T>
NDGrid<T, 1>::NDGrid(size_t size)
{
    resize(size);
}

template <typename T>
void NDGrid<T, 1>::resize(size_t newSize)
{
    mElements.resize(newSize);
}

template <typename T>
T& NDGrid<T, 1>::operator[](size_t x)
{
    return mElements[x];
}

template <typename T>
const T& NDGrid<T, 1>::operator[](size_t x) const
{
    return mElements[x];
}

```

Now, you can write code like this:

```
NDGrid<int, 3> my3DGrid;
my3DGrid[2][1][2] = 5;
my3DGrid[1][1][1] = 5;
cout << my3DGrid[2][1][2] << endl;
```

VARIADIC TEMPLATES

Normal templates can take only a fixed number of template parameters. *Variadic templates* can take a variable number of template parameters. For example, the following code defines a template that can accept any number of template parameters, using a *parameter pack* called `Types`:

```
template<typename... Types>
class MyVariadicTemplate { };
```

NOTE *The three dots following `typename` are not an error. This is the syntax to define a parameter pack for variadic templates. A parameter pack is something that can accept a variable number of arguments. You are allowed to put spaces before and after the three dots.*

You can instantiate `MyVariadicTemplate` with any number of types, as in this example:

```
MyVariadicTemplate<int> instance1;
MyVariadicTemplate<string, double, list<int>> instance2;
```

It can even be instantiated with zero template arguments:

```
MyVariadicTemplate<> instance3;
```

To avoid instantiating a variadic template with zero template arguments, you can write your template as follows:

```
template<typename T1, typename... Types>
class MyVariadicTemplate { };
```

With this definition, trying to instantiate `MyVariadicTemplate` with zero template arguments results in a compiler error. For example, with Microsoft Visual C++ you get the following error:

```
error C2976: 'MyVariadicTemplate' : too few template arguments
```

It is not possible to directly iterate over the different arguments given to a variadic template. The only way you can do this is with the aid of template recursion. The following sections show two examples of how to use variadic templates.

Type-Safe Variable-Length Argument Lists

Variadic templates allow you to create *type-safe variable-length* argument lists. The following example defines a variadic template called `processValues()`, allowing it to accept a variable number of arguments with different types in a type-safe manner. The `processValues()` function

processes each value in the variable-length argument list and executes a function called `handleValue()` for each single argument. This means that you have to write a `handleValue()` function for each type that you want to handle—`int`, `double`, and `string` in this example:

```
void handleValue(int value) { cout << "Integer: " << value << endl; }
void handleValue(double value) { cout << "Double: " << value << endl; }
void handleValue(string_view value) { cout << "String: " << value << endl; }

void processValues() { /* Nothing to do in this base case.*/ }

template<typename T1, typename... Tn>
void processValues(T1 arg1, Tn... args)
{
    handleValue(arg1);
    processValues(args...);
}
```

What this example also demonstrates is the double use of the triple dots `...` operator. This operator appears in three places and has two different meanings. First, it is used after `typename` in the template parameter list and after type `Tn` in the function parameter list. In both cases it denotes a *parameter pack*. A parameter pack can accept a variable number of arguments.

The second use of the `...` operator is following the parameter name `args` in the function body. In this case, it means a *parameter pack expansion*; the operator *unpacks/expands* the parameter pack into separate arguments. It basically takes what is on the left side of the operator, and repeats it for every template parameter in the pack, separated by commas. Take the following line:

```
processValues(args...);
```

This line unpacks/expands the `args` parameter pack into its separate arguments, separated by commas, and then calls the `processValues()` function with the list of expanded arguments. The template always requires at least one template parameter, `T1`. The act of recursively calling `processValues()` with `args...` is that on each call there is one template parameter less.

Because the implementation of the `processValues()` function is recursive, you need to have a way to stop the recursion. This is done by implementing a `processValues()` function that accepts no arguments.

You can test the `processValues()` variadic template as follows:

```
processValues(1, 2, 3.56, "test", 1.1f);
```

The recursive calls generated by this example are as follows:

```
processValues(1, 2, 3.56, "test", 1.1f);
  handleValue(1);
  processValues(2, 3.56, "test", 1.1f);
    handleValue(2);
    processValues(3.56, "test", 1.1f);
      handleValue(3.56);
      processValues("test", 1.1f);
        handleValue("test");
        processValues(1.1f);
          handleValue(1.1f);
          processValues();
```

It is important to remember that this method of variable-length argument lists is fully type-safe. The `processValues()` function automatically calls the correct `handleValue()` overload based on the actual type. Automatic casting can happen as usual in C++. For example, the `1.1f` in the preceding example is of type `float`. The `processValues()` function calls `handleValue(double value)` because conversion from `float` to `double` is without any loss. However, the compiler will issue an error when you call `processValues()` with an argument of a certain type for which there is no `handleValue()` defined.

There is a problem, though, with the preceding implementation. Because it's a recursive implementation, the parameters are copied for each recursive call to `processValues()`. This can become costly depending on the type of the arguments. You might think that you can avoid this copying by passing references to `processValues()` instead of using pass-by-value. Unfortunately, that also means that you cannot call `processValues()` with literals anymore, because a reference to a literal value is not allowed, unless you use `const` references.

To use non-`const` references and still allow literal values, you can use *forwarding references*. The following implementation uses forwarding references, `T&&`, and uses `std::forward()` for *perfect forwarding* of all parameters. Perfect forwarding means that if an rvalue is passed to `processValues()`, it is forwarded as an rvalue reference. If an lvalue or lvalue reference is passed, it is forwarded as an lvalue reference.

```
void processValues() { /* Nothing to do in this base case.*/ }

template<typename T1, typename... Tn>
void processValues(T1&& arg1, Tn&&... args)
{
    handleValue(std::forward<T1>(arg1));
    processValues(std::forward<Tn>(args)...);
}
```

There is one line that needs further explanation:

```
processValues(std::forward<Tn>(args)...);
```

The `...` operator is used to unpack the parameter pack. It uses `std::forward()` on each individual argument in the pack and separates them with commas. For example, suppose `args` is a parameter pack with three arguments, `a1`, `a2`, and `a3`, of three types, `A1`, `A2`, and `A3`. The expanded call then looks as follows:

```
processValues(std::forward<A1>(a1),
             std::forward<A2>(a2),
             std::forward<A3>(a3));
```

Inside the body of a function using a parameter pack, you can retrieve the number of arguments in the pack as follows:

```
int numOfArgs = sizeof...(args);
```

A practical example of using variadic templates is to write a secure and type-safe `printf()`-like function template. This would be a good practice exercise for you to try.

Variable Number of Mixin Classes

Parameter packs can be used almost everywhere. For example, the following code uses a parameter pack to define a variable number of mixin classes for `MyClass`. Chapter 5 discusses the concept of mixin classes.

```
class Mixin1
{
public:
    Mixin1(int i) : mValue(i) {}
    virtual void Mixin1Func() { cout << "Mixin1: " << mValue << endl; }
private:
    int mValue;
};

class Mixin2
{
public:
    Mixin2(int i) : mValue(i) {}
    virtual void Mixin2Func() { cout << "Mixin2: " << mValue << endl; }
private:
    int mValue;
};

template<typename... Mixins>
class MyClass : public Mixins...
{
public:
    MyClass(const Mixins&... mixins) : Mixins(mixins)... {}
    virtual ~MyClass() = default;
};
```

This code first defines two mixin classes: `Mixin1` and `Mixin2`. They are kept pretty simple for this example. Their constructor accepts an integer, which is stored, and they have a function to print information about that specific instance of the class. The `MyClass` variadic template uses a parameter pack `typename... Mixins` to accept a variable number of mixin classes. The class then inherits from all those mixin classes and the constructor accepts the same number of arguments to initialize each inherited mixin class. Remember that the `...` expansion operator basically takes what is on the left of the operator and repeats it for every template parameter in the pack, separated by commas. The class can be used as follows:

```
MyClass<Mixin1, Mixin2> a(Mixin1(11), Mixin2(22));
a.Mixin1Func();
a.Mixin2Func();

MyClass<Mixin1> b(Mixin1(33));
b.Mixin1Func();
//b.Mixin2Func(); // Error: does not compile.

MyClass<> c;
//c.Mixin1Func(); // Error: does not compile.
//c.Mixin2Func(); // Error: does not compile.
```

When you try to call `Mixin2Func()` on `b`, you will get a compilation error because `b` is not inheriting from the `Mixin2` class. The output of this program is as follows:

```
Mixin1: 11
Mixin2: 22
Mixin1: 33
```

C++17

Folding Expressions

C++17 adds supports for so-called *folding expressions*. This makes working with parameter packs in variadic templates much easier. The following table lists the four types of folds that are supported. In this table, Θ can be any of the following operators: `+ - * / % ^ & | << >> += -= *= /= %= ^= &= |= <<= >>= == != < > <= >= && || , .* ->*`.

NAME	EXPRESSION	IS EXPANDED TO
Unary right fold	<code>(pack Θ ...)</code>	<code>pack₀ Θ (... Θ (pack_{n-1} Θ pack_n))</code>
Unary left fold	<code>(... Θ pack)</code>	<code>((pack₀ Θ pack₁) Θ ...) Θ pack_n</code>
Binary right fold	<code>(pack Θ ... Θ Init)</code>	<code>pack₀ Θ (... Θ (pack_{n-1} Θ (pack_n Θ Init)))</code>
Binary left fold	<code>(Init Θ ... Θ pack)</code>	<code>((Init Θ pack₀) Θ pack₁) Θ ...) Θ pack_n</code>

Let's look at some examples. Earlier, the `processValue()` function template was defined recursively as follows:

```
void processValues() { /* Nothing to do in this base case.*/ }

template<typename T1, typename... Tn>
void processValues(T1 arg1, Tn... args)
{
    handleValue(arg1);
    processValues(args...);
}
```

Because it was defined recursively, it needs a base case to stop the recursion. With folding expressions, this can be implemented with a single function template using a unary right fold, where no base case is needed:

```
template<typename... Tn>
void processValues(const Tn&... args)
{
    (handleValue(args), ...);
}
```

Basically, the three dots in the function body trigger folding. That line is expanded to call `handleValue()` for each argument in the parameter pack, and each call to `handleValue()` is separated by a comma. For example, suppose `args` is a parameter pack with three arguments, `a1`, `a2`, and `a3`. The expansion of the unary right fold then becomes as follows:

```
(handleValue(a1), (handleValue(a2), handleValue(a3)));
```

Here is another example. The `printValues()` function template writes all its arguments to the console, separated by newlines.

```
template<typename... Values>
void printValues(const Values&... values)
{
    ((cout << values << endl), ...);
}
```

Suppose that `values` is a parameter pack with three arguments, `v1`, `v2`, and `v3`. The expansion of the unary right fold then becomes as follows:

```
((cout << v1 << endl), ((cout << v2 << endl), (cout << v3 << endl)));
```

You can call `printValues()` with as many arguments as you want, as shown here:

```
printValues(1, "test", 2.34);
```

In these examples, the folding is used with the comma operator, but it can be used with almost any kind of operator. For example, the following code defines a variadic function template using a binary left fold to calculate the sum of all the values given to it. A binary left fold always requires an *Init* value (see the overview table earlier). So, `sumValues()` has two template type parameters: a normal one to specify the type of *Init*, and a parameter pack which can accept 0 or more arguments.

```
template<typename T, typename... Values>
double sumValues(const T& init, const Values&... values)
{
    return (init + ... + values);
}
```

Suppose that `values` is a parameter pack with three arguments, `v1`, `v2`, and `v3`. Here is the expansion of the binary left fold in that case:

```
return (((init + v1) + v2) + v3);
```

The `sumValues()` function template can be used as follows:

```
cout << sumValues(1, 2, 3.3) << endl;
cout << sumValues(1) << endl;
```

The template requires at least one argument, so the following does not compile:

```
cout << sumValues() << endl;
```

METAPROGRAMMING

This section touches on *template metaprogramming*. It is a very complicated subject and there are books written about it explaining all the little details. This book doesn't have the space to go into all of these details. Instead, this section explains the most important concepts, with the aid of a couple of examples.

The goal of template metaprogramming is to perform some computation at compile time instead of at run time. It is basically a programming language on top of C++. The following section starts

the discussion with a simple example that calculates the factorial of a number at compile time and makes the result available as a simple constant at run time.

Factorial at Compile Time

Template metaprogramming allows you to perform calculations at compile time instead of at run time. The following code is a small example that calculates the factorial of a number at compile time. The code uses template recursion, explained earlier in this chapter, which requires a recursive template and a base template to stop the recursion. By mathematical definition, the factorial of 0 is 1, so that is used as the base case.

```
template<unsigned char f>
class Factorial
{
public:
    static const unsigned long long val = (f * Factorial<f - 1>::val);
};

template<>
class Factorial<0>
{
public:
    static const unsigned long long val = 1;
};

int main()
{
    cout << Factorial<6>::val << endl;
    return 0;
}
```

This calculates the factorial of 6, mathematically written as $6!$, which is $1 \times 2 \times 3 \times 4 \times 5 \times 6$ or 720.

NOTE *It is important to keep in mind that the factorial calculation is happening at compile time. At run time, you simply access the compile-time calculated value through `::val`, which is just a static constant value.*

For this specific example of calculating the factorial of a number at compile time, you don't necessarily need to use template metaprogramming. Since the introduction of `constexpr`, it can be written as follows without any templates, though the template implementation still serves as a good example on how to implement recursive templates.

```
constexpr unsigned long long factorial(unsigned char f)
{
    if (f == 0) {
        return 1;
    } else {
        return f * factorial(f - 1);
    }
}
```

If you call this version as follows, the value is calculated at compile time:

```
constexpr auto f1 = factorial(6);
```

However, you have to be careful not to forget the `constexpr` in this statement. If, instead, you write the following, then the calculation happens at run time!

```
auto f1 = factorial(6);
```

You cannot make such a mistake with the template metaprogramming version; that one always happens at compile time.

Loop Unrolling

A second example of template metaprogramming is to unroll loops at compile time instead of executing the loop at run time. Note that loop unrolling should only be done when you really need it, because the compiler is usually smart enough to unroll loops that can be unrolled for you.

This example again uses template recursion because it needs to do something in a loop at compile time. On each recursion, the `Loop` template instantiates itself with `i-1`. When it hits 0, the recursion stops.

```
template<int i>
class Loop
{
public:
    template <typename FuncType>
    static inline void Do(FuncType func) {
        Loop<i - 1>::Do(func);
        func(i);
    }
};

template<>
class Loop<0>
{
public:
    template <typename FuncType>
    static inline void Do(FuncType /* func */) { }
};
```

The `Loop` template can be used as follows:

```
void DoWork(int i) { cout << "DoWork(" << i << ")" << endl; }

int main()
{
    Loop<3>::Do(DoWork);
}
```

This code causes the compiler to unroll the loop and to call the function `DoWork()` three times in a row. The output of the program is as follows:

```
DoWork(1)
DoWork(2)
DoWork(3)
```

With a lambda expression you can use a version of `DoWork()` that accepts more than one parameter:

```
void DoWork2(string str, int i)
{
    cout << "DoWork2(" << str << ", " << i << ")" << endl;
}

int main()
{
    Loop<2>::Do([](int i) { DoWork2("TestStr", i); });
}
```

The code first implements a function that accepts a `string` and an `int`. The `main()` function uses a lambda expression to call `DoWork2()` on each iteration with a fixed string, "TestStr", as first argument. If you compile and run this code, the output is as follows:

```
DoWork2(TestStr, 1)
DoWork2(TestStr, 2)
```

Printing Tuples

This example uses template metaprogramming to print the individual elements of an `std::tuple`. Tuples are explained in Chapter 20. They allow you to store any number of values, each with its own specific type. A `tuple` has a fixed size and fixed value types, determined at compile time. However, tuples don't have any built-in mechanism to iterate over their elements. The following example shows how you could use template metaprogramming to iterate over the elements of a `tuple` at compile time.

As is often the case with template metaprogramming, this example is again using template recursion. The `tuple_print` class template has two template parameters: the `tuple` type, and an integer, initialized with the size of the `tuple`. It then recursively instantiates itself in the constructor and decrements the integer on every call. A partial specialization of `tuple_print` stops the recursion when this integer hits 0. The `main()` function shows how this `tuple_print` class template can be used.

```
template<typename TupleType, int n>
class tuple_print
{
public:
    tuple_print(const TupleType& t) {
        tuple_print<TupleType, n - 1> tp(t);
        cout << get<n - 1>(t) << endl;
    }
};

template<typename TupleType>
class tuple_print<TupleType, 0>
{
public:
    tuple_print(const TupleType&) { }
};
```

```

int main()
{
    using MyTuple = tuple<int, string, bool>;
    MyTuple t1(16, "Test", true);
    tuple_print<MyTuple, tuple_size<MyTuple>::value> tp(t1);
}

```

If you look at the `main()` function, you can see that the line to use the `tuple_print` template looks a bit complicated because it requires the exact type of the `tuple` and the size of the `tuple` as template arguments. This can be simplified a lot by introducing a helper function template that automatically deduces the template parameters. The simplified implementation is as follows:

```

template<typename TupleType, int n>
class tuple_print_helper
{
public:
    tuple_print_helper(const TupleType& t) {
        tuple_print_helper<TupleType, n - 1> tp(t);
        cout << get<n - 1>(t) << endl;
    }
};

template<typename TupleType>
class tuple_print_helper<TupleType, 0>
{
public:
    tuple_print_helper(const TupleType&) { }
};

template<typename T>
void tuple_print(const T& t)
{
    tuple_print_helper<T, tuple_size<T>::value> tph(t);
}

int main()
{
    auto t1 = make_tuple(167, "Testing", false, 2.3);
    tuple_print(t1);
}

```

The first change made here is renaming the original `tuple_print` class template to `tuple_print_helper`. The code then implements a small function template called `tuple_print()`. It accepts the `tuple`'s type as a template type parameter, and accepts a reference to the `tuple` itself as a function parameter. The body of that function instantiates the `tuple_print_helper` class template. The `main()` function shows how to use this simplified version. Because you no longer need to know the exact type of the `tuple`, you can use `make_tuple()` together with `auto`. The call to the `tuple_print()` function template is very simple:

```
tuple_print(t1);
```

You don't need to specify the function template parameter because the compiler can deduce this automatically from the supplied argument.

C++17

constexpr if

C++17 introduced `constexpr if`. These are `if` statements executed at compile time, not at run time. If a branch of a `constexpr if` statement is never taken, it is never compiled. This can be used to simplify a lot of template metaprogramming techniques, and also comes in handy for SFINAE (discussed later in this chapter).

For example, you can simplify the previous code for printing elements of a `tuple` using `constexpr if`, as follows. Note that the template recursion base case is not needed anymore, because the recursion is stopped with the `constexpr if` statement.

```
template<typename TupleType, int n>
class tuple_print_helper
{
public:
    tuple_print_helper(const TupleType& t) {
        if constexpr(n > 1) {
            tuple_print_helper<TupleType, n - 1> tp(t);
        }
        cout << get<n - 1>(t) << endl;
    }
};

template<typename T>
void tuple_print(const T& t)
{
    tuple_print_helper<T, tuple_size<T>::value> tph(t);
}
```

Now you can even get rid of the class template itself, and replace it with a simple function template called `tuple_print_helper`:

```
template<typename TupleType, int n>
void tuple_print_helper(const TupleType& t) {
    if constexpr(n > 1) {
        tuple_print_helper<TupleType, n - 1>(t);
    }
    cout << get<n - 1>(t) << endl;
}

template<typename T>
void tuple_print(const T& t)
{
    tuple_print_helper<T, tuple_size<T>::value>(t);
}
```

This can be simplified even more. Both methods can be combined into one, as follows:

```
template<typename TupleType, int n = tuple_size<TupleType>::value>
void tuple_print(const TupleType& t) {
    if constexpr(n > 1) {
        tuple_print<TupleType, n - 1>(t);
    }
    cout << get<n - 1>(t) << endl;
}
```

It can still be called the same as before:

```
auto t1 = make_tuple(167, "Testing", false, 2.3);
tuple_print(t1);
```

Using a Compile-Time Integer Sequence with Folding

C++ supports compile-time integer sequences using `std::integer_sequence`, which is defined in `<utility>`. A common use case with template metaprogramming is to generate a compile-time sequence of indices, that is, an integer sequence of type `size_t`. For this, a helper `std::index_sequence` is available. You can use `std::index_sequence_for` to generate an index sequence of the same length as the length of a given parameter pack.

The tuple printer could be implemented using variadic templates, compile-time index sequences, and C++17 folding expressions as follows:

```
template<typename Tuple, size_t... Indices>
void tuple_print_helper(const Tuple& t, index_sequence<Indices...>)
{
    ((cout << get<Indices>(t) << endl), ...);
}

template<typename... Args>
void tuple_print(const tuple<Args...>& t)
{
    tuple_print_helper(t, index_sequence_for<Args...>());
}
```

It can be called in the same way as before:

```
auto t1 = make_tuple(167, "Testing", false, 2.3);
tuple_print(t1);
```

With this call, the unary right fold expression in the `tuple_print_helper()` function template expands to the following:

```
((cout << get<0>(t) << endl),
 (cout << get<1>(t) << endl),
 (cout << get<2>(t) << endl),
 (cout << get<3>(t) << endl)))));
```

Type Traits

Type traits allow you to make decisions based on types at compile time. For example, you can write a template that requires a type that is derived from a certain type, or a type that is convertible to a certain type, or a type that is integral, and so on. The C++ standard defines several helper classes for this. All type traits-related functionality is defined in the `<type_traits>` header file. Type traits are divided into separate categories. The following list gives a few examples of the available type traits in each category. Consult a Standard Library Reference, see Appendix B, for a complete list.

- | | |
|---|---|
| <ul style="list-style-type: none">➤ Primary type categories<ul style="list-style-type: none">○ <code>is_void</code>○ <code>is_integral</code>○ <code>is_floating_point</code>○ <code>is_pointer</code>○ ...➤ Type properties<ul style="list-style-type: none">○ <code>is_const</code>○ <code>is_literal_type</code>○ <code>is_polymorphic</code>○ <code>is_unsigned</code>○ <code>is_constructible</code>○ <code>is_copy_constructible</code>○ <code>is_move_constructible</code>○ <code>is_assignable</code>○ <code>is_trivially_copyable</code>○ <code>is_swappable*</code>○ <code>is_nothrow_swappable*</code>○ <code>has_virtual_destructor</code>○ <code>has_unique_object_representations*</code>○ ...➤ Reference modifications<ul style="list-style-type: none">○ <code>remove_reference</code>○ <code>add_lvalue_reference</code>○ <code>add_rvalue_reference</code>➤ Pointer modifications<ul style="list-style-type: none">○ <code>remove_pointer</code>○ <code>add_pointer</code> | <ul style="list-style-type: none">➤ Compositing type categories<ul style="list-style-type: none">○ <code>is_reference</code>○ <code>is_object</code>○ <code>is_scalar</code>○ ...➤ Type relations<ul style="list-style-type: none">○ <code>is_same</code>○ <code>is_base_of</code>○ <code>is_convertible</code>○ <code>is_invocable*</code>○ <code>is_nothrow_invocable*</code>○ ...➤ const-volatile modifications<ul style="list-style-type: none">○ <code>remove_const</code>○ <code>add_const</code>○ ...➤ Sign modifications<ul style="list-style-type: none">○ <code>make_signed</code>○ <code>make_unsigned</code>➤ Array modifications<ul style="list-style-type: none">○ <code>remove_extent</code>○ <code>remove_all_extents</code>➤ Logical operator traits<ul style="list-style-type: none">○ <code>conjunction*</code>○ <code>disjunction*</code>○ <code>negation*</code>➤ Other transformations<ul style="list-style-type: none">○ <code>enable_if</code>○ <code>conditional</code>○ <code>invoke_result*</code>○ ... |
|---|---|

The type traits marked with an asterisk (*) are only available since C++17.

Type traits is a pretty advanced C++ feature. By just looking at the preceding list, which is already a shortened version of the list from the C++ standard, it is clear that this book cannot explain all details about all type traits. This section explains just a couple of use cases to show you how type traits can be used.

Using Type Categories

Before an example can be given for a template using type traits, you first need to know a bit more on how classes like `is_integral` work. The C++ standard defines an `integral_constant` class that looks like this:

```
template <class T, T v>
struct integral_constant {
    static constexpr T value = v;
    using value_type = T;
    using type = integral_constant<T, v>;
    constexpr operator value_type() const noexcept { return value; }
    constexpr value_type operator()() const noexcept { return value; }
};
```

It also defines `bool_constant`, `true_type`, and `false_type` type aliases:

```
template <bool B>
using bool_constant = integral_constant<bool, B>;

using true_type = bool_constant<true>;
using false_type = bool_constant<false>;
```

What this code defines is two types: `true_type` and `false_type`. When you access `true_type::value`, you get the value `true`, and when you access `false_type::value`, you get the value `false`. You can also access `true_type::type`, which results in the type of `true_type`. The same holds for `false_type`. Classes like `is_integral` and `is_class` inherit from either `true_type` or `false_type`. For example, `is_integral` can be specialized for type `bool` as follows:

```
template<> struct is_integral<bool> : public true_type { };
```

This allows you to write `is_integral<bool>::value`, which results in the value `true`. Note that you don't need to write these specializations yourself; they are part of the Standard Library.

The following code shows the simplest example of how type categories can be used:

```
if (is_integral<int>::value) {
    cout << "int is integral" << endl;
} else {
    cout << "int is not integral" << endl;
}

if (is_class<string>::value) {
    cout << "string is a class" << endl;
} else {
    cout << "string is not a class" << endl;
}
```

This example uses `is_integral` to check whether or not `int` is an integral type, and it uses `is_class` to check whether or not `string` is a class. The output is as follows:

```
int is integral
string is a class
```

C++17

For each trait that has a value member, C++17 adds a variable template that has the same name as the trait followed by `_v`. Instead of writing `some_trait<T>::value`, you can write `some_trait_v<T>`—for example, `is_integral_v<T>`, `is_const_v<T>`, and so on. Here is the previous example written using these helpers:

```
if (is_integral_v<int>) {
    cout << "int is integral" << endl;
} else {
    cout << "int is not integral" << endl;
}

if (is_class_v<string>) {
    cout << "string is a class" << endl;
} else {
    cout << "string is not a class" << endl;
}
```

Of course, you will likely never use type traits in this way. They become more useful in combination with templates to generate code based on some properties of a type. The following template functions demonstrate this. The code defines two overloaded `process_helper()` function templates that accept a type as template parameter. The first parameter to these functions is a value, and the second is an instance of either `true_type` or `false_type`. The `process()` function template accepts a single parameter and calls `process_helper()`.

```
template<typename T>
void process_helper(const T& t, true_type)
{
    cout << t << " is an integral type." << endl;
}

template<typename T>
void process_helper(const T& t, false_type)
{
    cout << t << " is a non-integral type." << endl;
}

template<typename T>
void process(const T& t)
{
    process_helper(t, typename is_integral<T>::type());
}
```

The second argument in the call to `process_helper()` is as follows:

```
typename is_integral<T>::type()
```

This argument uses `is_integral` to figure out if `T` is an integral type. You use `::type` to access the resulting `integral_constant` type, which can be `true_type` or `false_type`.

The `process_helper()` function needs an instance of `true_type` or `false_type` as a second parameter, so that is the reason for the two empty parentheses behind `::type`. Note that the two overloaded `process_helper()` functions use nameless parameters of type `true_type` and `false_type`. They are nameless because they don't use those parameters inside their function body. These parameters are only used for function overload resolution.

The code can be tested as follows:

```
process(123);
process(2.2);
process("Test"s);
```

Here is the output:

```
123 is an integral type.
2.2 is a non-integral type.
Test is a non-integral type.
```

The previous example could be written as a single function template as follows. However, that doesn't demonstrate how to use type traits to select different overloads based on a type.

```
template<typename T>
void process(const T& t)
{
    if constexpr (is_integral_v<T>) {
        cout << t << " is an integral type." << endl;
    } else {
        cout << t << " is a non-integral type." << endl;
    }
}
```

Using Type Relations

Some examples of type relations are `is_same`, `is_base_of`, and `is_convertible`. This section gives an example of how to use `is_same`; the other type relations work similarly.

The following `same()` function template uses the `is_same` type trait to figure out whether or not the two given arguments are of the same type, and outputs an appropriate message:

```
template<typename T1, typename T2>
void same(const T1& t1, const T2& t2)
{
    bool areTypesTheSame = is_same_v<T1, T2>;
    cout << "' " << t1 << "' and "' << t2 << "' are ";
    cout << (areTypesTheSame ? "the same types." : "different types.") << endl;
}

int main()
{
    same(1, 32);
    same(1, 3.01);
    same(3.01, "Test"s);
}
```

The output is as follows:

```
'1' and '32' are the same types.  
'1' and '3.01' are different types  
'3.01' and 'Test' are different types
```

Using `enable_if`

The use of `enable_if` is based on a feature called *Substitution Failure Is Not An Error* (SFINAE), a complicated feature of C++. This section only explains the basics of SFINAE.

If you have a set of overloaded functions, you can use `enable_if` to selectively disable certain overloads based on some type traits. The `enable_if` trait is usually used on the return types for your set of overloads. `enable_if` accepts two template type parameters. The first is a Boolean, and the second is a type that is `void` by default. If the Boolean is `true`, then the `enable_if` class has a nested type that you can access using `::type`. The type of this nested type is the type given as a second template type parameter. If the Boolean is `false`, then there is no nested type.

The C++ standard defines alias templates for traits that have a `type` member, such as `enable_if`. These have the same name as the trait, but are appended with `_t`. For example, instead of writing the following,

```
typename enable_if<..., bool>::type
```

you can write a much shorter version,

```
enable_if_t<..., bool>
```

The `same()` function template from the previous section can be rewritten into an overloaded `check_type()` function template by using `enable_if` as follows. In this version, the `check_type()` functions return `true` or `false` depending on whether or not the types of the given values are the same. If you don't want to return anything from `check_type()`, you can remove the return statements, and remove the second template type parameter for `enable_if` or replace it with `void`.

```
template<typename T1, typename T2>  
enable_if_t<is_same_v<T1, T2>, bool>  
    check_type(const T1& t1, const T2& t2)  
{  
    cout << "'" << t1 << "' and '" << t2 << "' ";  
    cout << "are the same types." << endl;  
    return true;  
}  
  
template<typename T1, typename T2>  
enable_if_t<!is_same_v<T1, T2>, bool>  
    check_type(const T1& t1, const T2& t2)  
{  
    cout << "'" << t1 << "' and '" << t2 << "' ";  
    cout << "are different types." << endl;  
    return false;  
}
```

```
int main()
{
    check_type(1, 32);
    check_type(1, 3.01);
    check_type(3.01, "Test"s);
}
```

The output is the same as before:

```
'1' and '32' are the same types.
'1' and '3.01' are different types.
'3.01' and 'Test' are different types.
```

The code defines two versions of `check_type()`. The return type of both versions is the nested type of `enable_if`, which is `bool`. First, `is_same_v` is used to check whether or not the two types are the same. The result is given to `enable_if_t`. When the first argument to `enable_if_t` is `true`, `enable_if_t` has type `bool`; otherwise, there is no type. This is where SFINAE comes into play.

When the compiler starts to compile the first line of `main()`, it tries to find a function `check_type()` that accepts two integer values. It finds the first `check_type()` function template overload in the source code and deduces that it can use an instance of this function template by making `T1` and `T2` both integers. It then tries to figure out the return type. Because both arguments are integers and thus the same types, `is_same_v<T1, T2>` is `true`, which causes `enable_if_t<true, bool>` to be type `bool`. With this instantiation, everything is fine and the compiler can use that version of `check_type()`.

However, when the compiler tries to compile the second line in `main()`, it again tries to find a suitable `check_type()` function. It starts with the first `check_type()` and decides it can use that overload by setting `T1` to type `int` and `T2` to type `double`. It then tries to figure out the return type. This time, `T1` and `T2` are different types, which means that `is_same_v<T1, T2>` is `false`. Because of this, `enable_if_t<false, bool>` does not represent a type, leaving the function `check_type()` without a return type. The compiler notices this error but does not yet generate a real compilation error because of SFINAE (Substitution Failure Is Not An Error). Instead, the compiler gracefully backtracks and tries to find another `check_type()` function. In this case, the second `check_type()` works out perfectly fine because `!is_same_v<T1, T2>` is `true`, and thus `enable_if_t<true, bool>` is type `bool`.

If you want to use `enable_if` on a set of constructors, you can't use it with the return type because constructors don't have a return type. In that case, you can use `enable_if` on an extra constructor parameter with a default value.

It is recommended to use `enable_if` judiciously. Use it only when you need to resolve overload ambiguities that you cannot possibly resolve using any other technique, such as specialization, partial specialization, and so on. For example, if you just want compilation to fail when you use a template with the wrong types, use `static_assert()`, explained in Chapter 27, and not SFINAE. Of course, there are legitimate use cases for `enable_if`. One such example is specializing a copy function for a custom vector-like class to perform bit-wise copying of trivially copyable types using `enable_if` and the `is_trivially_copyable` type trait. Such a specialized copy function could for example use `memcpy()`.

WARNING *Relying on SFINAE is tricky and complicated. If your use of SFINAE and `enable_if` selectively disables the wrong overloads in your overload set, you will get cryptic compiler errors, which will be hard to track down.*

C++17

Using `constexpr if` to Simplify `enable_if` Constructs

As you can see from the earlier examples, using `enable_if` can become quite complicated. The `constexpr if` feature, introduced in C++17, helps to dramatically simplify certain use cases of `enable_if`.

For example, suppose you have the following two classes:

```
class IsDoable
{
public:
    void doit() const { cout << "IsDoable::doit()" << endl; }
};

class Derived : public IsDoable { };
```

You can create a function template, `call_doit()`, that calls the `doit()` method if the method is available; otherwise, it prints an error message to the console. You can do this with `enable_if` by checking whether the given type is derived from `IsDoable`:

```
template<typename T>
enable_if_t<is_base_of_v<IsDoable, T>, void>
call_doit(const T& t)
{
    t.doit();
}

template<typename T>
enable_if_t<!is_base_of_v<IsDoable, T>, void>
call_doit(const T&)
{
    cout << "Cannot call doit()!" << endl;
}
```

The following code tests this implementation:

```
Derived d;
call_doit(d);
call_doit(123);
```

Here is the output:

```
IsDoable::doit()
Cannot call doit()!
```

You can simplify this `enable_if` implementation a lot by using C++17 `constexpr if`:

```
template<typename T>
void call_doit(const T& [[maybe_unused]] t)
{
```

```

    if constexpr(is_base_of_v<IsDoable, T>) {
        t.doit();
    } else {
        cout << "Cannot call doit()!" << endl;
    }
}

```

You cannot accomplish this using a normal `if` statement! With a normal `if` statement, both branches need to be compiled, and this will fail if you supply a type `T` that is not derived from `IsDoable`. In that case, the line `t.doit()` will fail to compile. However, with the `constexpr if` statement, if a type is supplied that is not derived from `IsDoable`, then the line `t.doit()` won't even be compiled!

Note also the use of the `[[maybe_unused]]` attribute, introduced in C++17. Because the line `t.doit()` is not compiled if the given type `T` is not derived from `IsDoable`, the parameter `t` won't be used in that instantiation of `call_doit()`. Most compilers give a warning or even an error if you have unused parameters. The attribute prevents such warnings or errors for the parameter `t`.

Instead of using the `is_base_of` type trait, you can also use the new C++17 `is_invocable` trait, which determines whether or not a given function can be called with a given set of arguments. Here is an implementation of `call_doit()` using the `is_invocable` trait:

```

template<typename T>
void call_doit(const T& [[maybe_unused]] t)
{
    if constexpr(is_invocable_v<decltype(&IsDoable::doit), T>) {
        t.doit();
    } else {
        cout << "Cannot call doit()!" << endl;
    }
}

```

C++17

Logical Operator Traits

There are three logical operator traits: conjunction, disjunction, and negation. Variable templates, ending with `_v`, are available as well. These traits accept a variable number of template type parameters, and can be used to perform logical operations on type traits, as in this example:

```

cout << conjunction_v<is_integral<int>, is_integral<short>> << " ";
cout << conjunction_v<is_integral<int>, is_integral<double>> << " ";

cout << disjunction_v<is_integral<int>, is_integral<double>,
                is_integral<short>> << " ";

cout << negation_v<is_integral<int>> << " ";

```

The output is as follows:

```
1 0 1 0
```

Metaprogramming Conclusion

As you have seen in this section, template metaprogramming can be a very powerful tool, but it can also get quite complicated. One problem with template metaprogramming, not mentioned before, is that everything happens at compile time so you cannot use a debugger to pinpoint a problem.

If you decide to use template metaprogramming in your code, make sure you write good comments to explain exactly what is going on and why you are doing something a certain way. If you don't properly document your template metaprogramming code, it might be very difficult for someone else to understand your code, and it might even make it difficult for you to understand your own code in the future.

SUMMARY

This chapter is a continuation of the template discussion from Chapter 12. These chapters show you how to use templates for generic programming, and template metaprogramming for compile-time computations. Hopefully you gained an appreciation for the power and capabilities of these features, and an idea of how you could apply these concepts to your own code. Don't worry if you didn't understand all the syntax, or didn't follow all the examples, on your first reading. The concepts can be difficult to grasp when you are first exposed to them, and the syntax is tricky whenever you want to write more complicated templates. When you actually sit down to write a class or function template, you can consult this chapter and Chapter 12 for a reference on the proper syntax.

23

Multithreaded Programming with C++

WHAT'S IN THIS CHAPTER?

- What multithreaded programming is
- How to launch multiple threads
- How to retrieve results from threads
- What deadlocks and race conditions are, and how to use mutual exclusion to prevent them
- How to use atomic types and atomic operations
- What condition variables are
- How to use futures and promises for inter-thread communication
- What thread pools are

WROX.COM DOWNLOADS FOR THIS CHAPTER

Please note that all the code examples for this chapter are available as a part of this chapter's code download on the book's website at www.wrox.com/go/proc++4e on the Download Code tab.

Multithreaded programming is important on computer systems with multiple processor units. It allows you to write a program to use all those processor units in parallel. There are multiple ways for a system to have multiple processor units. The system can have multiple discrete processor chips, each one an independent CPU (Central Processor Unit). Or, the system can have a single discrete processor chip that internally consists of multiple independent CPUs,

also called *cores*. These kinds of processors are called *multicore processors*. A system can also have a combination of both. Systems with multiple processor units have existed for a long time; however, they were rarely used in consumer systems. Today, all CPU vendors are selling multicore processors. Nowadays, multicore processors are being used for everything from servers to consumer computers to even smartphones. Because of this proliferation of multicore processors, it is important to know how to write multithreaded applications. A professional C++ programmer needs to know how to write correct multithreaded code to take full advantage of all the available processor units. Writing multithreaded applications used to rely on platform- and operating system-specific APIs. This made it difficult to write platform-independent multithreaded code. C++11 solved this problem by including a standard threading library.

Multithreaded programming is a complicated subject. This chapter introduces you to multithreaded programming using the standard threading library, but it cannot go into all of the details due to space constraints. Entire books have been written about developing multithreaded programs. If you are interested in more details, consult one of the references in the multithreading section in Appendix B.

There are also third-party C++ libraries that try to make multithreaded programming more platform independent, such as `pthread`s and the `boost::thread` library. However, because these libraries are not part of the C++ standard, they are not discussed in this book.

INTRODUCTION

Multithreaded programming allows you to perform multiple calculations in parallel. As a result, you can take advantage of the multiple processor units inside virtually all systems today. Two decades ago, the processor market was racing for the highest frequency, which is perfect for single-threaded applications. Around 2005, this race stopped due to a combination of power and heat management problems. Since then, the processor market is racing toward the most cores on a single processor chip. Dual- and quad-core processors are common, and even 12-, 16-, 18-, and more core processors are available.

Similarly, if you look at the processors on graphics cards, called *GPUs*, you'll see that they are massively-parallel processors. Today, high-end graphics cards have more than 4,000 cores, a number that will increase rapidly! These graphics cards are used not only for gaming, but also to perform computationally intensive tasks. Examples are image and video manipulation, protein folding (useful for discovering new drugs), processing signals as part of the SETI (Search for Extraterrestrial Intelligence) project, and so on.

C++98/03 did not have support for multithreaded programming, and you had to resort to third-party libraries or to the multithreading APIs of your target operating system. Because C++11 included a standard multithreading library, it became easier to write cross-platform multithreaded applications. The current C++ standard targets only CPUs and not GPUs. This might change in the future.

There are two reasons to start writing multithreaded code. First, if you have a computational problem and you manage to separate it into small pieces that can be run in parallel independently from each other, you can expect a huge performance boost when running it on multiple processor units.

Second, you can modularize computations along orthogonal axes. For example, you can do long computations in a thread instead of blocking the UI thread, so the user interface remains responsive while a long computation occurs in the background.

Figure 23-1 shows a situation that is perfectly suited for running in parallel. An example could be the processing of pixels of an image by an algorithm that does not require information about neighboring pixels. The algorithm could split the image into four parts. On a single-core processor, each part would be processed sequentially; on a dual-core processor, two parts would be processed in parallel; and on a quad-core processor, four parts would be processed in parallel, resulting in an almost linear scaling of the performance with the number of cores.

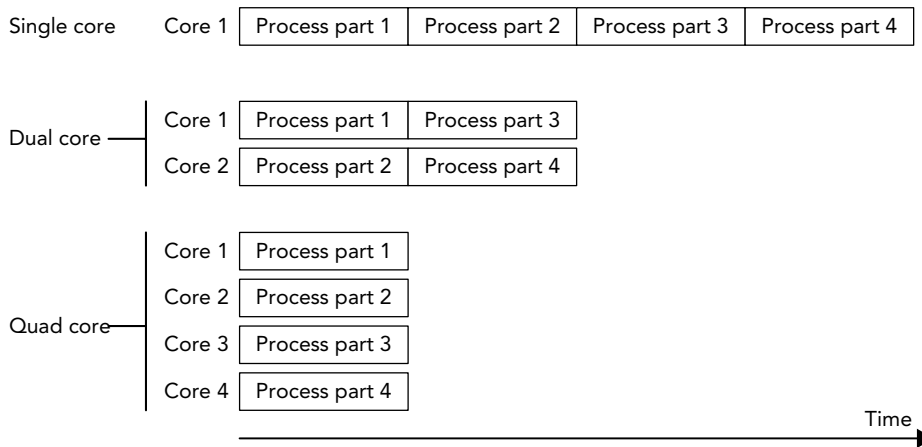

FIGURE 23-1

Of course, it's not always possible to split the problem into parts that can be executed independently of each other in parallel. However, it can often be made parallel, at least partially, resulting in a performance increase. A difficult part of multithreaded programming is making your algorithm parallel, which is highly dependent on the type of the algorithm. Other difficulties are preventing race conditions, deadlocks, tearing, and false-sharing. These are discussed in the following sections. They are usually solved using atomics or explicit synchronization mechanisms, as discussed later in this chapter.

NOTE To prevent multithreading problems, try to design your programs so that multiple threads need not read and write to shared memory. Or, use a synchronization method (as described in the section “Mutual Exclusion”) or atomic operations (as described in the section “Atomic Operations Library”).

Race Conditions

Race conditions can occur when multiple threads want to access any kind of shared resources. Race conditions in the context of shared memory are called *data races*. A data race can occur when

multiple threads access shared memory, and at least one thread writes to the shared memory. For example, suppose you have a shared variable and one thread increments this value while another thread decrements it. Incrementing and decrementing the value means that the current value needs to be retrieved from memory, incremented or decremented, and stored back in memory. On old architectures, such as PDP-11 and VAX, this used to be implemented with an `INC` processor instruction, which was atomic. On modern x86 processors, the `INC` instruction is not atomic anymore, meaning that other instructions can be executed in the middle of this operation, which might cause the code to retrieve a wrong value.

The following table shows the result when the increment is finished before the decrement starts, and assumes that the initial value is 1.

THREAD 1 (INCREMENT)	THREAD 2 (DECREMENT)
load value (value = 1)	
increment value (value = 2)	
store value (value = 2)	
	load value (value = 2)
	decrement value (value = 1)
	store value (value = 1)

The final value stored in memory is 1. When the decrement thread is finished before the increment thread starts, the final value is also 1, as shown in the following table.

THREAD 1 (INCREMENT)	THREAD 2 (DECREMENT)
	load value (value = 1)
	decrement value (value = 0)
	store value (value = 0)
load value (value = 0)	
increment value (value = 1)	
store value (value = 1)	

However, when the instructions are interleaved, the result is different, as shown in the following table.

THREAD 1 (INCREMENT)	THREAD 2 (DECREMENT)
load value (value = 1)	
increment value (value = 2)	

THREAD 1 (INCREMENT)	THREAD 2 (DECREMENT)
	load value (value = 1)
	decrement value (value = 0)
store value (value = 2)	
	store value (value = 0)

The final result in this case is 0. In other words, the effect of the increment operation is lost. This is a data race.

Tearing

Tearing is a specific case or consequence of a data race. There are two kinds of tearing: *torn read* and *torn write*. If a thread has written part of your data to memory, while another part hasn't been written yet by the same thread, any other thread reading that data at that exact moment sees inconsistent data, a torn read. If two threads are writing to the data at the same time, one thread might have written part of the data, while another thread might have written another part of the data. The final result will be inconsistent, a torn write.

Deadlocks

If you opt to solve a race condition by using a synchronization method, such as mutual exclusion, you might run into another common problem with multithreaded programming: *deadlocks*. Two threads are deadlocked if they are both waiting for the other thread to do something. This can be extended to more than two threads. For example, if two threads want to acquire access to a shared resource, they need to ask for permission to access this resource. If one of the threads currently holds the permission to access the resource, but is blocked indefinitely for some other reason, then the other thread will block indefinitely as well when trying to acquire permission for the same resource. One mechanism to acquire permission for a shared resource is called a mutual exclusion object, discussed in detail later in this chapter. For example, suppose you have two threads and two resources protected with two mutual exclusion objects, A and B. Both threads acquire permission for both resources, but they acquire the permission in different order. The following table shows this situation in pseudo-code.

THREAD 1	THREAD 2
Acquire A	Acquire B
Acquire B	Acquire A
// ... compute	// ... compute
Release B	Release A
Release A	Release B

Now, imagine that the code in the two threads is executed in the following order.

- Thread 1: Acquire A
- Thread 2: Acquire B
- Thread 1: Acquire B (waits/blocks, because B is held by thread 2)
- Thread 2: Acquire A (waits/blocks, because A is held by thread 1)

Both threads are now waiting indefinitely in a deadlock situation. Figure 23-2 shows a graphical representation of the deadlock. Thread 1 has acquired permission for resource A and is waiting to acquire permission for resource B. Thread 2 has acquired permission for resource B and is waiting to acquire permission for resource A. In this graphical representation, you see a cycle that depicts the deadlock. Both threads will wait indefinitely.

It's best to always acquire permissions in the same order to avoid these kinds of deadlocks. You can also include mechanisms in your program to break these deadlocks. One possible solution is to try for a certain time to acquire permission for a resource. If the permission could not be obtained within a certain time interval, the thread could stop waiting and possibly releases other permissions it is currently holding. The thread might then sleep

for a little bit and try again later to acquire all the resources it needs. This method might give other threads the opportunity to acquire necessary permissions and continue their execution. Whether this method works or not depends heavily on your specific deadlock case.

Instead of using a workaround as described in the previous paragraph, you should try to avoid any possible deadlock situation altogether. If you need to acquire permission to multiple resources protected with several mutual exclusion objects, instead of acquiring permission for each resource individually, the recommended way is to use the standard `std::lock()` or `std::try_lock()` functions described later in the section “Mutual Exclusion.” These functions obtain or try to obtain permission for several resources with one call.

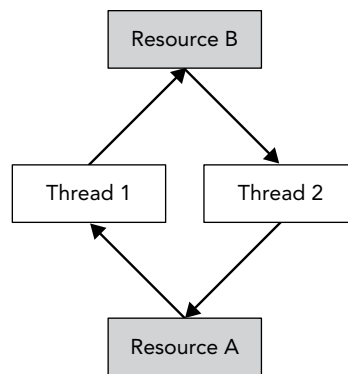

FIGURE 23-2

False-Sharing

Most caches work with so-called *cache lines*. For modern CPUs, cache lines are usually 64 bytes. If something needs to be written to a cache line, the entire line needs to be locked. This can bring a serious performance penalty for multithreaded code if your data structure is not properly designed. For example, if two threads are using two different pieces of data, but that data shares a cache line, then when one thread writes something, the other thread is blocked because the entire cache line is locked. You can optimize your data structures by using explicit memory alignments to make sure data that is worked on by multiple threads does not share any cache lines. To do this in a portable manner, C++17 introduces a constant called `hardware_destructive_interference_size`, defined in `<new>`, which returns you the minimum recommended offset between two concurrently accessed objects to avoid cache line sharing. You can use that value in combination with the `alignas` keyword to properly align your data.

THREADS

The C++ threading library, defined in the `<thread>` header file, makes it very easy to launch new threads. You can specify what needs to be executed in the new thread in several ways. You can let the new thread execute a global function, the `operator()` of a function object, a lambda expression, or even a member function of an instance of some class. The following sections give small examples of all these methods.

Thread with Function Pointer

Functions such as `CreateThread()`, `_beginthread()`, and so on, on Windows, and `pthread_create()` with the `pthreads` library, require that the thread function has only one parameter. On the other hand, a function that you want to use with the standard C++ `std::thread` class can have as many parameters as you want.

Suppose you have a `counter()` function accepting two integers: the first representing an ID and the second representing the number of iterations that the function should loop. The body of the function is a single loop that loops the given number of iterations. On each iteration, a message is printed to standard output:

```
void counter(int id, int numIterations)
{
    for (int i = 0; i < numIterations; ++i) {
        cout << "Counter " << id << " has value " << i << endl;
    }
}
```

You can launch multiple threads executing this function using `std::thread`. You can create a thread `t1`, executing `counter()` with arguments 1 and 6 as follows:

```
thread t1(counter, 1, 6);
```

The constructor of the `thread` class is a variadic template, which means that it accepts any number of arguments. Variadic templates are discussed in detail in Chapter 22. The first argument is the name of the function to execute in the new thread. The subsequent variable number of arguments are passed to this function when execution of the thread starts.

A `thread` object is said to be *joinable* if it represents or represented an active thread in the system. Even when the thread has finished executing, a `thread` object remains in the joinable state. A default constructed `thread` object is *unjoinable*. Before a joinable `thread` object is destroyed, you need to make sure to call either `join()` or `detach()` on it. A call to `join()` is a blocking call, it waits until the thread has finished its work. A call to `detach()` detaches a `thread` object from its underlying OS thread, in which case the OS thread keeps running independently. Both methods cause the thread to become unjoinable. If a `thread` object that is still joinable is destroyed, the destructor will call `std::terminate()`, which abruptly terminates all threads and the application itself.

The following code launches two threads executing the `counter()` function. After launching the threads, `main()` calls `join()` on both threads.

```
thread t1(counter, 1, 6);
thread t2(counter, 2, 4);
```



```
t1.join();
t2.join();
```

A possible output of this example looks as follows:

```
Counter 2 has value 0
Counter 1 has value 0
Counter 1 has value 1
Counter 1 has value 2
Counter 1 has value 3
Counter 1 has value 4
Counter 1 has value 5
Counter 2 has value 1
Counter 2 has value 2
Counter 2 has value 3
```

The output on your system will be different and it will most likely be different every time you run it. This is because two threads are executing the `counter()` function at the same time, so the output depends on the number of processing cores in your machine and on the thread scheduling of the operating system.

By default, accessing `cout` from different threads is thread-safe and doesn't cause any data races, unless you have called `cout.sync_with_stdio(false)` before the first output or input operation. However, even though there are no data races, output from different threads can still be interleaved! This means that the output of the previous example can be mixed together as follows:

```
Counter Counter 2 has value 0
1 has value 0
Counter 1 has value 1
Counter 1 has value 2
...
```

This can be fixed using synchronization methods, which are discussed later in this chapter.

NOTE *Thread function arguments are always copied into some internal storage for the thread. Use `std::ref()` or `std::cref()` from the `<functional>` header to pass them by reference.*

Thread with Function Object

Instead of using function pointers, you can also use a function object to execute in a thread. With the function pointer technique of the previous section, the only way to pass information to the thread is by passing arguments to the function. With function objects, you can add member variables to your function object class, which you can initialize and use however you want. The following example first defines a class called `Counter`, which has two member variables: an ID and the number of iterations for the loop. Both variables are initialized with the constructor. To make the

`Counter` class a function object, you need to implement `operator()`, as discussed in Chapter 18. The implementation of `operator()` is the same as the `counter()` function from the previous section. Here is the code:

```
class Counter
{
public:
    Counter(int id, int numIterations)
        : mId(id), mNumIterations(numIterations)
    {
    }

    void operator()() const
    {
        for (int i = 0; i < mNumIterations; ++i) {
            cout << "Counter " << mId << " has value " << i << endl;
        }
    }
private:
    int mId;
    int mNumIterations;
};
```

Three methods for initializing threads with a function object are demonstrated in the following code snippet. The first method uses the uniform initialization syntax. You create an instance of `Counter` with its constructor arguments and give it to the thread constructor between curly braces.

The second method defines a named instance of `Counter` and gives this named instance to the constructor of the thread class.

The third method looks similar to the first one; it creates an instance of `Counter` and gives it to the constructor of the thread class, but uses parentheses instead of curly braces. The ramifications of this are discussed after the code.

```
// Using uniform initialization syntax
thread t1{ Counter{ 1, 20 } };

// Using named variable
Counter c(2, 12);
thread t2(c);

// Using temporary
thread t3(Counter(3, 10));

// Wait for threads to finish
t1.join();
t2.join();
t3.join();
```

If you compare the creation of `t1` with the creation of `t3`, the only difference seems to be that the first method uses curly braces while the third method uses parentheses. However, when your

function object constructor doesn't require any parameters, the third method as written earlier does not work. Here is an example:

```
class Counter
{
public:
    Counter() {}
    void operator() () const { /* Omitted for brevity */ }
};

int main()
{
    thread t1(Counter());    // Error!
    t1.join();
}
```

This results in a compilation error because C++ interprets the first line in `main()` as a declaration of a function called `t1`, which returns a `thread` object and accepts a pointer to a function without parameters returning a `Counter` object. For this reason, it's recommended to use the uniform initialization syntax:

```
thread t1{ Counter{} };    // OK
```

NOTE *Function objects are always copied into some internal storage for the thread. If you want to execute `operator()` on a specific instance of your function object instead of copying it, you should use `std::ref()` or `std::cref()` from the `<functional>` header to pass your instance by reference, for example:*

```
Counter c(2, 12);
thread t2(ref(c));
```

Thread with Lambda

Lambda expressions fit nicely with the standard C++ threading library. Here is an example that launches a thread to execute a given lambda expression:

```
int main()
{
    int id = 1;
    int numIterations = 5;
    thread t1([id, numIterations] {
        for (int i = 0; i < numIterations; ++i) {
            cout << "Counter " << id << " has value " << i << endl;
        }
    });
    t1.join();
}
```

Thread with Member Function

You can specify a member function of a class to be executed in a thread. The following example defines a basic `Request` class with a `process()` method. The `main()` function creates an instance of the `Request` class, and launches a new thread, which executes the `process()` method of the `Request` instance `req`.

```
class Request
{
public:
    Request(int id) : mId(id) { }

    void process()
    {
        cout << "Processing request " << mId << endl;
    }
private:
    int mId;
};

int main()
{
    Request req(100);
    thread t{ &Request::process, &req };
    t.join();
}
```

With this technique, you are executing a method on a specific object in a separate thread. If other threads are accessing the same object, you need to make sure this happens in a thread-safe way to avoid data races. Mutual exclusion, discussed later in this chapter, can be used as a synchronization mechanism to make it thread-safe.

Thread Local Storage

The C++ standard supports the concept of *thread local storage*. With a keyword called `thread_local`, you can mark any variable as thread local, which means that each thread will have its own unique copy of the variable and it will last for the entire duration of the thread. For each thread, the variable is initialized exactly once. For example, the following code defines two global variables. Every thread shares one—and only one—copy of `k`, while each thread has its own unique copy of `n`:

```
int k;
thread_local int n;
```

Note that if the `thread_local` variable is declared in the scope of a function, its behavior is as if it were declared `static`, except that every thread has its own unique copy and is initialized exactly once per thread, no matter how many times that function is called in that thread.

Cancelling Threads

The C++ standard does not include any mechanism for cancelling a running thread from another thread. The best way to achieve this is to provide some communication mechanism that the two threads agree upon. The simplest mechanism is to have a shared variable, which the target thread checks periodically to determine if it should terminate. Other threads can set this shared variable to indirectly instruct the thread to shut down. You have to be careful here, because this shared variable is being accessed by multiple threads, of which at least one is writing to the shared variable. It's recommended to use atomic variables or condition variables, both discussed later in this chapter.

Retrieving Results from Threads

As you saw in the previous examples, launching a new thread is pretty easy. However, in most cases you are probably interested in results produced by the thread. For example, if your thread performs some mathematical calculations, you really would like to get the results out of the thread once the thread is finished. One way is to pass a pointer or reference to a result variable to the thread in which the thread stores the results. Another method is to store the results inside class member variables of a function object, which you can retrieve later once the thread has finished executing. This only works if you use `std::ref()` to pass your function object by reference to the `thread` constructor.

However, there is another easier method to obtain a result from threads: *futures*. Futures also make it easier to handle errors that occur inside your threads. They are discussed later in this chapter.

Copying and Rethrowing Exceptions

The whole exception mechanism in C++ works perfectly fine, as long as it stays within one single thread. Every thread can throw its own exceptions, but they need to be caught within their own thread. If a thread throws an exception and it is not caught inside the thread, the C++ runtime calls `std::terminate()`, which terminates the whole application. Exceptions thrown in one thread cannot be caught in another thread. This introduces quite a few problems when you would like to use exception handling in combination with multithreaded programming.

Without the standard threading library, it's very difficult if not impossible to gracefully handle exceptions across threads. The standard threading library solves this issue with the following exception-related functions. These functions work not only with `std::exceptions`, but also with other kinds of exceptions, ints, strings, custom exceptions, and so on:

- `exception_ptr current_exception() noexcept;`

This is intended to be called from inside a catch block. It returns an `exception_ptr` object that refers to the exception currently being handled, or a copy of the currently handled exception. A null `exception_ptr` object is returned if no exception is being handled. This referenced exception object remains valid for as long as there is an object of type `exception_ptr` that is referencing it. `exception_ptr` is of type `NullablePointer`, which means it can easily be tested with a simple `if` statement, as the example later in this section will demonstrate.

- `[[noreturn]] void rethrow_exception(exception_ptr p);`

This function rethrows the exception referenced by the `exception_ptr` parameter. Rethrowing the referenced exception does not have to be done in the same thread that generated the referenced exception in the first place, which makes this feature perfectly suited for handling exceptions across different threads. The `[[noreturn]]` attribute makes it clear that this function never returns normally. Attributes are introduced in Chapter 11.

- `template<class E> exception_ptr make_exception_ptr(E e) noexcept;`

This function creates an `exception_ptr` object that refers to a copy of the given exception object. This is basically a shorthand notation for the following code:

```
try {
    throw e;
} catch (...) {
    return current_exception();
}
```

Let's see how handling exceptions across different threads can be implemented using these functions. The following code defines a function that does some work and throws an exception. This function will ultimately be running in a separate thread:

```
void doSomeWork()
{
    for (int i = 0; i < 5; ++i) {
        cout << i << endl;
    }
    cout << "Thread throwing a runtime_error exception..." << endl;
    throw runtime_error("Exception from thread");
}
```

The following `threadFunc()` function wraps the call to the preceding function in a `try/catch` block, catching all exceptions that `doSomeWork()` might throw. A single argument is supplied to `threadFunc()`, which is of type `exception_ptr&`. Once an exception is caught, the function `current_exception()` is used to get a reference to the exception being handled, which is then assigned to the `exception_ptr` parameter. After that, the thread exits normally:

```
void threadFunc(exception_ptr& err)
{
    try {
        doSomeWork();
    } catch (...) {
        cout << "Thread caught exception, returning exception..." << endl;
        err = current_exception();
    }
}
```

The following `doWorkInThread()` function is called from within the main thread. Its responsibility is to create a new thread and start executing `threadFunc()` in it. A reference to an object of type `exception_ptr` is given as argument to `threadFunc()`. Once the thread is created, the `doWorkInThread()` function waits for the thread to finish by using the `join()` method, after which the error object is examined. Because `exception_ptr` is of type `NullablePointer`, you can easily check it using an `if` statement. If it's a non-null value, the exception is rethrown in the current thread, which is the main thread in this example. Because you are rethrowing the exception in the main thread, the exception has been transferred from one thread to another thread.

```

void doWorkInThread()
{
    exception_ptr error;
    // Launch thread
    thread t{ threadFunc, ref(error) };
    // Wait for thread to finish
    t.join();
    // See if thread has thrown any exception
    if (error) {
        cout << "Main thread received exception, rethrowing it..." << endl;
        rethrow_exception(error);
    } else {
        cout << "Main thread did not receive any exception." << endl;
    }
}

```

The `main()` function is pretty straightforward. It calls `doWorkInThread()` and wraps the call in a `try/catch` block to catch exceptions thrown by the thread spawned by `doWorkInThread()`:

```

int main()
{
    try {
        doWorkInThread();
    } catch (const exception& e) {
        cout << "Main function caught: '" << e.what() << "'" << endl;
    }
}

```

The output is as follows:

```

0
1
2
3
4
Thread throwing a runtime_error exception...
Thread caught exception, returning exception...
Main thread received exception, rethrowing it...
Main function caught: 'Exception from thread'

```

To keep the examples in this chapter compact and to the point, their `main()` functions usually use `join()` to block the main thread, and to wait until threads have finished. Of course, in real-world applications you do not want to block your main thread. For example, in a GUI application, blocking your main thread means that the UI becomes unresponsive. In that case, you can use a messaging paradigm to communicate between threads. For example, the earlier `threadFunc()` function could send a message to the UI thread with as argument a copy of the result of `current_exception()`. But even then, you need to make sure to call either `join()` or `detach()` on any spawned threads, as discussed earlier in this chapter.

ATOMIC OPERATIONS LIBRARY

Atomic types allow *atomic access*, which means that concurrent reading and writing without additional synchronization is allowed. Without atomic operations, incrementing a variable is not thread-safe because the compiler first loads the value from memory into a register, increments it, and then stores the result back in memory. Another thread might touch the same memory during this increment operation, which is a data race. For example, the following code is not thread-safe and contains a data race. This type of data races is discussed in the beginning of this chapter.

```
int counter = 0;    // Global variable
++counter;        // Executed in multiple threads
```

You can use an `std::atomic` type to make this thread-safe without explicitly using any synchronization mechanism, such as mutual exclusion objects, which are discussed later in this chapter. Here is the same code using an atomic integer:

```
atomic<int> counter(0) ; // Global variable
++counter;              // Executed in multiple threads
```

You need to include the `<atomic>` header to use these atomic types. The C++ standard defines named integral atomic types for all primitive types. The following table lists a few.

NAMED ATOMIC TYPE	EQUIVALENT STD::ATOMIC TYPE
<code>atomic_bool</code>	<code>atomic<bool></code>
<code>atomic_char</code>	<code>atomic<char></code>
<code>atomic_uchar</code>	<code>atomic<unsigned char></code>
<code>atomic_int</code>	<code>atomic<int></code>
<code>atomic_uint</code>	<code>atomic<unsigned int></code>
<code>atomic_long</code>	<code>atomic<long></code>
<code>atomic_ulong</code>	<code>atomic<unsigned long></code>
<code>atomic_llong</code>	<code>atomic<long long></code>
<code>atomic_ullong</code>	<code>atomic<unsigned long long></code>
<code>atomic_wchar_t</code>	<code>atomic<wchar_t></code>

You can use atomic types without explicitly using any synchronization mechanism. However, underneath, operations on atomics of a certain type might use a synchronization mechanism such as mutual exclusion objects. This might happen, for example, when the hardware you are targeting lacks the instructions to perform an operation atomically. You can use the `is_lock_free()` method on an atomic type to query whether it supports lock-free operations, that is, its operations run without any explicit synchronization mechanism underneath.

The `std::atomic` class template can be used with all kinds of types, not only integral types. For example, you can create an `atomic<double>`, or an `atomic<MyType>`, but only if `MyType` is trivially copyable. Depending on the size of the specified type, underneath these might require explicit synchronization mechanisms. In the following example, both `Foo` and `Bar` are trivially copyable, that is, `std::is_trivially_copyable_v` is true for both. However, `atomic<Foo>` is not lock free, while `atomic<Bar>` is.

```
class Foo { private: int mArray[123]; };
class Bar { private: int mInt; };

int main()
{
    atomic<Foo> f;
    // Outputs: 1 0
    cout << is_trivially_copyable_v<Foo> << " " << f.is_lock_free() << endl;
    atomic<Bar> b;
    // Outputs: 1 1
    cout << is_trivially_copyable_v<Bar> << " " << b.is_lock_free() << endl;
}
```

When accessing a piece of data from multiple threads, atomics also solve problems such as memory ordering, compiler optimizations, and so on. Basically, it's virtually never safe to read and write to the same piece of data from multiple threads without using atomics or explicit synchronization mechanisms!

Atomic Type Example

This section explains in more detail why you should use atomic types. Suppose you have a function called `increment()` that increments an integer reference parameter in a loop. This code uses `std::this_thread::sleep_for()` to introduce a small delay in each loop. The argument to `sleep_for()` is an `std::chrono::duration`, which is explained in Chapter 20.

```
void increment(int& counter)
{
    for (int i = 0; i < 100; ++i) {
        ++counter;
        this_thread::sleep_for(1ms);
    }
}
```

Now, you would like to run several threads in parallel, all executing this `increment()` function on a shared `counter` variable. By implementing this naively without atomic types or without any kind of thread synchronization, you introduce data races. The following code launches ten threads, after which it waits for all threads to finish by calling `join()` on each thread:

```
int main()
{
    int counter = 0;
    vector<thread> threads;
    for (int i = 0; i < 10; ++i) {
        threads.push_back(thread{ increment, ref(counter) });
    }
}
```

```

        for (auto& t : threads) {
            t.join();
        }
        cout << "Result = " << counter <<endl;
    }
}

```

Because `increment()` increments its given integer 100 times, and ten threads are launched, each of which executes `increment()` on the same shared `counter`, the expected result is 1,000. If you execute this program several times, you might get the following output but with different values:

```

Result = 982
Result = 977
Result = 984

```

This code is clearly showing a data race. In this example, you can use an atomic type to fix the code. The following code highlights the required changes:

```

#include <atomic>

void increment(atomic<int>& counter)
{
    for (int i = 0; i < 100; ++i) {
        ++counter;
        this_thread::sleep_for(1ms);
    }
}

int main()
{
    atomic<int> counter(0);
    vector<thread> threads;
    for (int i = 0; i < 10; ++i) {
        threads.push_back(thread{ increment, ref(counter) });
    }

    for (auto& t : threads) {
        t.join();
    }
    cout << "Result = " << counter << endl;
}

```

The changes add the `<atomic>` header file, and change the type of the shared counter to `std::atomic<int>` instead of `int`. When you run this modified version, you always get 1,000 as the result:

```

Result = 1000
Result = 1000
Result = 1000

```

Without explicitly adding any synchronization mechanism to the code, it is now thread-safe and data-race-free because the `++counter` operation on an atomic type loads, increments, and stores the value in one atomic transaction, which cannot be interrupted.

However, there is a new problem with this modified code: a performance problem. You should try to minimize the amount of synchronization, either atomic or explicit synchronization, because it

lowers performance. For this simple example, the best and recommended solution is to let `increment()` calculate its result in a local variable, and only after the loop, add it to the `counter` reference. Note that it is still required to use an atomic type, because you are still writing to `counter` from multiple threads.

```
void increment(atomic<int>& counter)
{
    int result = 0;
    for (int i = 0; i < 100; ++i) {
        ++result;
        this_thread::sleep_for(1ms);
    }
    counter += result;
}
```

Atomic Operations

The C++ standard defines a number of atomic operations. This section describes a few of those operations. For a full list, consult a Standard Library Reference, see Appendix B.

A first example of an atomic operation is the following:

```
bool atomic<T>::compare_exchange_strong(T& expected, T desired);
```

The logic implemented atomically by this operation is as follows, in pseudo-code:

```
if (*this == expected) {
    *this = desired;
    return true;
} else {
    expected = *this;
    return false;
}
```

Although this logic might seem fairly strange on first sight, this operation is a key building block for writing lock-free concurrent data structures. Lock-free concurrent data structures allow operations on their data without requiring any synchronization mechanisms. However, implementing such data structures is an advanced topic, outside the scope of this book.

A second example is `atomic<T>::fetch_add()`, which works for integral atomic types. It fetches the current value of the atomic type, adds the given increment to the atomic value, and returns the original non-incremented value. Here is an example:

```
atomic<int> value(10);
cout << "Value = " << value << endl;
int fetched = value.fetch_add(4);
cout << "Fetched = " << fetched << endl;
cout << "Value = " << value << endl;
```

If no other threads are touching the contents of the `fetched` and `value` variables, the output is as follows:

```
Value = 10
Fetched = 10
Value = 14
```

Atomic integral types support the following atomic operations: `fetch_add()`, `fetch_sub()`, `fetch_and()`, `fetch_or()`, `fetch_xor()`, `++`, `--`, `+=`, `-=`, `&=`, `^=`, and `|=`. Atomic pointer types support `fetch_add()`, `fetch_sub()`, `++`, `--`, `+=`, and `-=`.

Most of the atomic operations can accept an extra parameter specifying the memory ordering that you would like. Here is an example:

```
T atomic<T>::fetch_add(T value, memory_order = memory_order_seq_cst);
```

You can change the default `memory_order`. The C++ standard provides `memory_order_relaxed`, `memory_order_consume`, `memory_order_acquire`, `memory_order_release`, `memory_order_acq_rel`, and `memory_order_seq_cst`, all of which are defined in the `std` namespace. However, you will rarely want to use them instead of the default. While another memory order may perform better than the default, according to some metrics, if you use them in a slightly incorrect way, you will again introduce data races or other difficult-to-track threading-related problems. If you do want to know more about memory ordering, consult one of the multithreading references in Appendix B.

MUTUAL EXCLUSION

If you are writing multithreaded applications, you have to be sensitive to sequencing of operations. If your threads read and write shared data, this can be a problem. There are many ways to avoid this problem, such as never actually sharing data between threads. However, if you can't avoid sharing data, you must provide for synchronization so that only one thread at a time can change the data.

Scalars such as Booleans and integers can often be synchronized properly with atomic operations, as described earlier; however, when your data is more complex, and you need to use that data from multiple threads, you must provide explicit synchronization.

The Standard Library has support for mutual exclusion in the form of *mutex* and *lock* classes. These can be used to implement synchronization between threads and are discussed in the following sections.

Mutex Classes

Mutex stands for *mutual exclusion*. The basic mechanism of using a mutex is as follows:

- A thread that wants to use (read/write) memory shared with other threads tries to lock a mutex object. If another thread is currently holding this lock, the new thread that wants to gain access blocks until the lock is released, or until a timeout interval expires.
- Once the thread has obtained the lock, it is free to use the shared memory. Of course, this assumes that all threads that want to use the shared data correctly acquire a lock on the mutex.
- After the thread is finished with reading/writing to the shared memory, it releases the lock to give some other thread an opportunity to obtain the lock to the shared memory. If two or more threads are waiting on the lock, there are no guarantees as to which thread will be granted the lock and thus allowed to proceed.

The C++ standard provides *non-timed mutex* and *timed mutex* classes.

Non-timed Mutex Classes

The Standard Library has three non-timed mutex classes: `std::mutex`, `recursive_mutex`, and `shared_mutex` (since C++17). The first two classes are defined in `<mutex>`, and the last one in `<shared_mutex>`. Each mutex supports the following methods.

- **lock()**: The calling thread tries to obtain the lock and blocks until the lock has been acquired. It blocks indefinitely. If there is a desire to limit the amount of time the thread blocks, you should use a timed mutex, discussed in the next section.
- **try_lock()**: The calling thread tries to obtain the lock. If the lock is currently held by another thread, the call returns immediately. If the lock has been obtained, `try_lock()` returns `true`; otherwise, it returns `false`.
- **unlock()**: The calling thread releases the lock it currently holds, making it available for another thread.

`std::mutex` is a standard mutual exclusion class with exclusive ownership semantics. There can be only one thread owning the mutex. If another thread wants to obtain ownership of this mutex, it either blocks when using `lock()`, or fails when using `try_lock()`. A thread already having ownership of a mutex is not allowed to call `lock()` or `try_lock()` again on that mutex. This might lead to a deadlock!

`std::recursive_mutex` behaves almost identically to `mutex`, except that a thread already having ownership of a recursive mutex is allowed to call `lock()` or `try_lock()` again on the same recursive mutex. The calling thread should call the `unlock()` method as many times as it obtained a lock on the recursive mutex.

The `shared_mutex` class supports the concept of *shared lock ownership*, also known as *readers-writers lock*. A thread can get either *exclusive ownership* or *shared ownership* of the lock. Exclusive ownership, also known as a *write lock*, can be acquired only when there are no other threads having exclusive or shared ownership. Shared ownership, also known as a *read lock*, can be acquired if there is no other thread having exclusive ownership, but other threads are allowed to have acquired shared ownership. The `shared_mutex` class supports `lock()`, `try_lock()`, and `unlock()`. These methods acquire and release exclusive locks. Additionally, they have the following shared ownership-related methods: `lock_shared()`, `try_lock_shared()`, and `unlock_shared()`. These work similarly to the other set of methods, but try to acquire or release shared ownership.

A thread already having a lock on a `shared_mutex` is not allowed to try to acquire a second lock on that mutex. This might lead to a deadlock!

Timed Mutex Classes

The Standard Library provides three timed mutex classes: `std::timed_mutex`, `recursive_timed_mutex`, and `shared_timed_mutex`. The first two classes are defined in `<mutex>`, and the last one in `<shared_mutex>`. They all support the `lock()`, `try_lock()`, and `unlock()` methods; and `shared_timed_mutex` also supports `lock_shared()`, `try_lock_shared()`, and `unlock_shared()`. All these methods behave the same as described in the previous section. Additionally, they support the following methods.

- `try_lock_for(rel_time)`: The calling thread tries to obtain the lock for a certain relative time. If the lock could not be obtained after the given timeout, the call fails and returns `false`. If the lock could be obtained within the timeout, the call succeeds and returns `true`. The timeout is specified as an `std::chrono::duration`, see Chapter 20.
- `try_lock_until(abs_time)`: The calling thread tries to obtain the lock until the system time equals or exceeds the specified absolute time. If the lock could be obtained before this time, the call returns `true`. If the system time passes the given absolute time, the function stops trying to obtain the lock and returns `false`. The absolute time is specified as an `std::chrono::time_point`, see Chapter 20.

A `shared_timed_mutex` also supports `try_lock_shared_for()` and `try_lock_shared_until()`.

A thread already having ownership of a `timed_mutex` or a `shared_timed_mutex` is not allowed to acquire the lock a second time on that mutex. This might lead to a deadlock!

A `recursive_timed_mutex` allows a thread to acquire a lock multiple times, just as with `recursive_mutex`.

WARNING *Do not manually call one of the previously discussed lock and unlock methods on any of the mutex classes. Mutex locks are resources, and, like all resources, they should almost exclusively be acquired using the RAI (Resource Acquisition Is Initialization) paradigm, see Chapter 28. The C++ standard defines a number of RAI lock classes, which are discussed in the next section. Using them is critical to avoid deadlocks. They automatically unlock a mutex when a lock object goes out of scope, so you don't need to manually call `unlock()` at the right time.*

Locks

A *lock* class is an RAI class that makes it easier to correctly obtain and release a lock on a mutex; the destructor of the lock class automatically releases the associated mutex. The C++ standard defines four types of locks: `std::lock_guard`, `unique_lock`, `shared_lock`, and `scoped_lock`. The latter has been introduced with C++17.

lock_guard

`lock_guard`, defined in `<mutex>`, is a simple lock with two constructors:

- `explicit lock_guard(mutex_type& m);`

This is a constructor accepting a reference `m` to a mutex. This constructor tries to obtain a lock on the mutex and blocks until the lock is obtained. The `explicit` keyword for constructors is discussed in Chapter 9.

- `lock_guard(mutex_type& m, adopt_lock_t);`

This is a constructor accepting a reference to a mutex and an instance of `std::adopt_lock_t`. There is a predefined `adopt_lock_t` instance provided, called `std::adopt_lock`. The lock assumes that the calling thread has already obtained a lock on the referenced mutex. The lock “adopts” the mutex, and automatically releases the mutex when the lock is destroyed.

unique_lock

`std::unique_lock`, defined in `<mutex>`, is a more sophisticated lock that allows you to defer lock acquisition until later in the execution, long after the declaration. You can use the `owns_lock()` method, or the `unique_lock`’s `bool` conversion operator, to see if the lock has been acquired. An example of using this conversion operator is given later in this chapter in the section “Using Timed Locks.” `unique_lock` has several constructors:

- `explicit unique_lock(mutex_type& m);`

This constructor accepts a reference to a mutex. It tries to obtain a lock on the mutex and blocks until the lock is obtained.

- `unique_lock(mutex_type& m, defer_lock_t) noexcept;`

This constructor accepts a reference to a mutex and an instance of `std::defer_lock_t`. There is a predefined `defer_lock_t` instance provided, called `std::defer_lock`. The `unique_lock` stores the reference to the mutex, but does not immediately try to obtain a lock. A lock can be obtained later.

- `unique_lock(mutex_type& m, try_to_lock_t);`

This constructor accepts a reference to a mutex and an instance of `std::try_to_lock_t`. There is a predefined `try_to_lock_t` instance provided, called `std::try_to_lock`. The lock tries to obtain a lock to the referenced mutex, but if it fails, it does not block, in which case, a lock can be obtained later.

- `unique_lock(mutex_type& m, adopt_lock_t);`

This constructor accepts a reference to a mutex and an instance of `std::adopt_lock_t`, for example `std::adopt_lock`. The lock assumes that the calling thread has already obtained a lock on the referenced mutex. The lock “adopts” the mutex, and automatically releases the mutex when the lock is destroyed.

- `unique_lock(mutex_type& m, const chrono::time_point<Clock, Duration>& abs_time);`

This constructor accepts a reference to a mutex and an absolute time. The constructor tries to obtain a lock until the system time passes the given absolute time. The `chrono` library is discussed in Chapter 20.

- `unique_lock(mutex_type& m, const chrono::duration<Rep, Period>& rel_time);`

This constructor accepts a reference to a mutex and a relative time. The constructor tries to get a lock on the mutex with the given relative timeout.

The `unique_lock` class also has the methods `lock()`, `try_lock()`, `try_lock_for()`, `try_lock_until()`, and `unlock()`, which behave as explained in the section “Timed Mutex Classes,” earlier in this chapter.

shared_lock

The `shared_lock` class, defined in `<shared_mutex>`, has the same type of constructors and the same methods as `unique_lock`. The difference is that the `shared_lock` class calls the shared ownership-related methods on the underlying shared mutex. Thus, the methods of `shared_lock` are called `lock()`, `try_lock()`, and so on, but on the underlying shared mutex they call `lock_shared()`, `try_lock_shared()`, and so on. This is done to give `shared_lock` the same interface as `unique_lock`, so it can be used as a stand-in replacement for `unique_lock`, but acquires a shared lock instead of an exclusive lock.

Acquiring Multiple Locks at Once

C++ has two generic lock functions that you can use to obtain locks on multiple mutex objects at once without the risk of creating deadlocks. Both functions are defined in the `std` namespace, and both are variadic template functions, as discussed in Chapter 22.

The first function, `lock()`, locks all the given mutex objects in an unspecified order without the risk of deadlocks. If one of the mutex lock calls throws an exception, `unlock()` is called on all locks that have already been obtained. Its prototype is as follows:

```
template <class L1, class L2, class... L3> void lock(L1&, L2&, L3&...);
```

`try_lock()` has a similar prototype, but it tries to obtain a lock on all the given mutex objects by calling `try_lock()` on each of them in sequence. It returns `-1` if all calls to `try_lock()` succeed. If any `try_lock()` fails, `unlock()` is called on all locks that have already been obtained, and the return value is the zero-based index of the parameter position of the mutex on which `try_lock()` failed.

The following example demonstrates how to use the generic `lock()` function. The `process()` function first creates two locks, one for each mutex, and gives an instance of `std::defer_lock_t` as a second argument to tell `unique_lock` not to acquire the lock during construction. The call to `std::lock()` then acquires both locks without the risk of deadlocks.

```
mutex mut1;
mutex mut2;

void process()
{
    unique_lock lock1(mut1, defer_lock); // C++17
    unique_lock lock2(mut2, defer_lock); // C++17
    //unique_lock<mutex> lock1(mut1, defer_lock);
    //unique_lock<mutex> lock2(mut2, defer_lock);
    lock(lock1, lock2);
    // Locks acquired
} // Locks automatically released
```

C++17

scoped_lock

`std::scoped_lock`, defined in `<mutex>`, is similar to `lock_guard`, except that it accepts a variable number of mutexes. This greatly simplifies acquiring multiple locks. For instance, the example with the `process()` function in the previous section can be written using a `scoped_lock` as follows:

```
mutex mut1;
mutex mut2;
```



```

void process()
{
    scoped_lock locks(mut1, mut2);
    // Locks acquired
} // Locks automatically released

```

This uses C++17's template argument deduction for constructors. If your compiler does not support this feature yet, you have to write the following:

```
scoped_lock<mutex, mutex> locks(mut1, mut2);
```

std::call_once

You can use `std::call_once()` in combination with `std::once_flag` to make sure a certain function or method is called exactly one time, no matter how many threads try to call `call_once()` with the same `once_flag`. Only one `call_once()` invocation actually calls the given function or method. If the given function does not throw any exceptions, then this invocation is called the *effective* `call_once()` invocation. If the given function does throw an exception, the exception is propagated back to the caller, and another caller is selected to execute the function. The effective invocation on a specific `once_flag` instance finishes before all other `call_once()` invocations on the same `once_flag`. Other threads calling `call_once()` on the same `once_flag` block until the effective call is finished. Figure 23-3 illustrates this with three threads. Thread 1 performs the effective `call_once()` invocation, thread 2 blocks until the effective invocation is finished, and thread 3 doesn't block because the effective invocation from thread 1 has already finished.

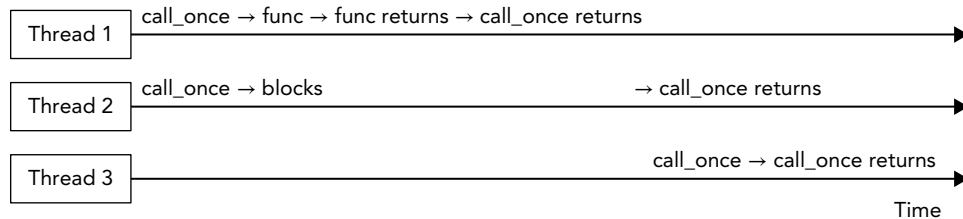

FIGURE 23-3

The following example demonstrates the use of `call_once()`. The example launches three threads running `processingFunction()` that use some shared resources. These shared resources should be initialized only once by calling `initializeSharedResources()` once. To accomplish this, each thread calls `call_once()` with a global `once_flag`. The result is that only one thread effectively executes `initializeSharedResources()`, and exactly one time. While this `call_once()` call is in progress, other threads block until `initializeSharedResources()` returns.

```

once_flag gOnceFlag;

void initializeSharedResources()
{
    // ... Initialize shared resources to be used by multiple threads.
    cout << "Shared resources initialized." << endl;
}

```

```

void processingFunction()
{
    // Make sure the shared resources are initialized.
    call_once(gOnceFlag, initializeSharedResources);

    // ... Do some work, including using the shared resources
    cout << "Processing" << endl;
}

int main()
{
    // Launch 3 threads.
    vector<thread> threads(3);
    for (auto& t : threads) {
        t = thread{ processingFunction };
    }
    // Join on all threads
    for (auto& t : threads) {
        t.join();
    }
}

```

The output of this code is as follows:

```

Shared resources initialized.
Processing
Processing
Processing

```

Of course, in this example, you could call `initializeSharedResources()` once in the beginning of the `main()` function before the threads are launched; however, that wouldn't demonstrate the use of `call_once()`.

Examples Using Mutual Exclusion Objects

The following sections give a couple of examples on how to use mutual exclusion objects to synchronize multiple threads.

Thread-Safe Writing to Streams

Earlier in this chapter, in the “Threads” section, there is an example with a class called `Counter`. That example mentions that C++ streams are data-race free by default, but that the output from multiple threads can be interleaved. To solve this interleaving issue, you can use a mutual exclusion object to make sure that only one thread at a time is reading/writing to the stream object.

The following example synchronizes all accesses to `cout` in the `Counter` class. For this, a `static mutex` object is added. It should be `static`, because all instances of the class should use the same `mutex` instance. `lock_guard` is used to obtain a lock on the `mutex` before writing to `cout`. Changes compared to the earlier version are shown in bold.

```

class Counter
{
    public:

```

```

    Counter(int id, int numIterations)
        : mId(id), mNumIterations(numIterations)
    {
    }

    void operator() () const
    {
        for (int i = 0; i < mNumIterations; ++i) {
            lock_guard lock(sMutex);
            cout << "Counter " << mId << " has value " << i << endl;
        }
    }
private:
    int mId;
    int mNumIterations;
    static mutex sMutex;
};

mutex Counter::sMutex;

```

This code creates a `lock_guard` instance on each iteration of the `for` loop. It is recommended to limit the time a lock is held as much as possible; otherwise, you are blocking other threads for too long. For example, if the `lock_guard` instance was created once right before the `for` loop, then you would basically lose all multithreading in this code because one thread would hold a lock for the entire duration of its `for` loop, and all other threads would wait for this lock to be released.

Using Timed Locks

The following example demonstrates how to use a timed mutex. It is the same `Counter` class as before, but this time it uses a `timed_mutex` in combination with a `unique_lock`. A relative time of 200 milliseconds is given to the `unique_lock` constructor, causing it to try to obtain a lock for 200 milliseconds. If the lock cannot be obtained within this timeout interval, the constructor returns. Afterward, you can check whether or not the lock has been acquired. You can do this with an `if` statement on the `lock` variable, because `unique_lock` defines a `bool` conversion operator. The timeout is specified using the `chrono` library, discussed in Chapter 20.

```

class Counter
{
public:
    Counter(int id, int numIterations)
        : mId(id), mNumIterations(numIterations)
    {
    }

    void operator() () const
    {
        for (int i = 0; i < mNumIterations; ++i) {
            unique_lock lock(sTimedMutex, 200ms);
            if (lock) {
                cout << "Counter " << mId << " has value " << i << endl;
            } else {
                // Lock not acquired in 200ms, skip output.
            }
        }
    }
};

```

```

    }
}
private:
    int mId;
    int mNumIterations;
    static timed_mutex sTimedMutex;
};

timed_mutex Counter::sTimedMutex;

```

Double-Checked Locking

The *double-checked locking pattern* is actually an anti-pattern, which you should avoid! It is shown here because you might come across it in existing code bases. The idea of the double-checked locking pattern is to try to avoid the use of mutual exclusion objects. It's a half-baked attempt at trying to write more efficient code than using a mutual exclusion object. It can really go wrong when you try to make it faster than demonstrated in the upcoming example, for instance, by using relaxed atomics (not further discussed), using a regular Boolean instead of an `atomic<bool>`, and so on. The pattern becomes sensitive to data races, and it is hard to get right. The irony is that using `call_once()` will actually be faster, and using a magic static¹ (if applicable) will be even faster than that.

WARNING *Avoid the double-checked locking pattern! Instead, use other mechanisms such as simple locks, atomic variables, `call_once()`, magic statics, and so on.*

Double-checked locking could, for example, be used to make sure that resources are initialized exactly once. The following example shows how you can implement this. It is called the double-checked locking pattern because it is checking the value of the `gInitialized` variable twice, once before acquiring the lock and once right after acquiring the lock. The first `gInitialized` check is used to prevent acquiring a lock when it is not needed. The second check is required to make sure that no other thread performed the initialization between the first `gInitialized` check and acquiring the lock.

```

void initializeSharedResources()
{
    // ... Initialize shared resources to be used by multiple threads.
    cout << "Shared resources initialized." << endl;
}

atomic<bool> gInitialized(false);
mutex gMutex;

```

¹Function local `static` instances are called magic statics. C++ guarantees that such local `static` instances are initialized in a thread-safe fashion, so you don't need any manual thread synchronization. An example of using a magic static is given in Chapter 29 with the discussion of the singleton pattern.

```

void processingFunction()
{
    if (!gInitialized) {
        unique_lock lock(gMutex);
        if (!gInitialized) {
            initializeSharedResources();
            gInitialized = true;
        }
    }
    cout << "OK" << endl;
}

int main()
{
    vector<thread> threads;
    for (int i = 0; i < 5; ++i) {
        threads.push_back(thread{ processingFunction });
    }
    for (auto& t : threads) {
        t.join();
    }
}

```

The output clearly shows that only one thread initializes the shared resources:

```

Shared resources initialized.
OK
OK
OK
OK
OK

```

NOTE *For this example, it's recommended to use `call_once()` as demonstrated earlier in this chapter, instead of double-checked locking!*

CONDITION VARIABLES

Condition variables allow a thread to block until a certain condition is set by another thread, or until the system time reaches a specified time. These variables allow for explicit inter-thread communication. If you are familiar with multithreaded programming using the Win32 API, you can compare condition variables with *event objects* in Windows.

Two kinds of condition variables are available, both of which are defined in the `<condition_variable>` header file.

- **`std::condition_variable`**: A condition variable that can wait only on a `unique_lock<mutex>`, which, according to the C++ standard, allows for maximum efficiency on certain platforms.
- **`std::condition_variable_any`**: A condition variable that can wait on any kind of object, including custom lock types.

A `condition_variable` supports the following methods:

- `notify_one()`;
This method wakes up one of the threads waiting on this condition variable. This is similar to an auto-reset event in Windows.
- `notify_all()`;
This method wakes up all threads waiting on this condition variable.
- `wait(unique_lock<mutex>& lk);`
The thread calling `wait()` should already have acquired a lock on `lk`. The effect of calling `wait()` is that it atomically calls `lk.unlock()` and then blocks the thread, waiting for a notification. When the thread is unblocked by a `notify_one()` or `notify_all()` call in another thread, the function calls `lk.lock()` again, possibly blocking until the lock has been acquired, and then returns.
- `wait_for(unique_lock<mutex>& lk, const chrono::duration<Rep, Period>& rel_time);`
This method is similar to `wait()`, except that the thread is unblocked by a `notify_one()` call, a `notify_all()` call, or when the given timeout has expired.
- `wait_until(unique_lock<mutex>& lk, const chrono::time_point<Clock, Duration>& abs_time);`
This method is similar to `wait()`, except that the thread is unblocked by a `notify_one()` call, a `notify_all()` call, or when the system time passes the given absolute time.

There are also versions of `wait()`, `wait_for()`, and `wait_until()` that accept an extra predicate parameter. For instance, the version of `wait()` accepting an extra predicate is equivalent to the following:

```
while (!predicate())
    wait(lk);
```

The `condition_variable_any` class supports the same methods as `condition_variable`, except that it accepts any kind of lock class instead of only a `unique_lock<mutex>`. The lock class used should have a `lock()` and `unlock()` method.

Spurious Wake-Ups

Threads waiting on a condition variable can wake up when another thread calls `notify_one()` or `notify_all()`, with a relative timeout, or when the system time reaches a certain time. However, they can also wake up *spuriously*. This means that a thread can wake up, even if no other thread has called any notify method, and no timeouts have been reached yet. Thus, when a thread waits on a condition variable and wakes up, it needs to check why it woke up. One way to check for this is by using one of the versions of `wait()` accepting a predicate, as shown in the following example.

Using Condition Variables

As an example, condition variables can be used for background threads processing items from a queue. You can define a queue in which you insert items to be processed. A background thread waits

until there are items in the queue. When an item is inserted into the queue, the thread wakes up, processes the item, and goes back to sleep, waiting for the next item. Suppose you have the following queue:

```
queue<string> mQueue;
```

You need to make sure that only one thread is modifying this queue at any given time. You can do this with a mutex:

```
mutex mMutex;
```

To be able to notify a background thread when an item is added, you need a condition variable:

```
condition_variable mCondVar;
```

A thread that wants to add an item to the queue first acquires a lock on the mutex, then adds the item to the queue, and notifies the background thread. You can call `notify_one()` or `notify_all()` whether or not you currently have the lock; both work.

```
// Lock mutex and add entry to the queue.
unique_lock lock(mMutex);
mQueue.push(entry);
// Notify condition variable to wake up thread.
mCondVar.notify_all();
```

The background thread waits for notifications in an infinite loop, as follows. Note the use of `wait()` accepting a predicate to correctly handle spurious wake-ups. The predicate checks if there really is something in the queue. When the call to `wait()` returns, you are sure there is something in the queue.

```
unique_lock lock(mMutex);
while (true) {
    // Wait for a notification.
    mCondVar.wait(lock, [this]{ return !mQueue.empty(); });
    // Condition variable is notified, so something is in the queue.
    // Process queue item...
}
```

The section “Example: Multithreaded Logger Class,” toward the end of this chapter, provides a complete example on how to use condition variables to send notifications to other threads.

The C++ standard also defines a helper function called `std::notify_all_at_thread_exit(cond, lk)` where `cond` is a condition variable and `lk` is a `unique_lock<mutex>` instance. A thread calling this function should already have acquired the lock `lk`. When the thread exits, it automatically executes the following:

```
lk.unlock();
cond.notify_all();
```

NOTE *The lock `lk` stays locked until the thread exits. So, you need to make sure that this does not cause any deadlocks in your code, for example, due to wrong lock ordering. Deadlocks are discussed earlier in this chapter.*

FUTURES

As discussed earlier in this chapter, using `std::thread` to launch a thread that calculates a single result does not make it easy to get the computed result back once the thread has finished executing. Another problem with `std::thread` is in how it handles errors like exceptions. If a thread throws an exception and this exception is not caught by the thread itself, the C++ runtime calls `std::terminate()`, which usually terminates the entire application.

A *future* can be used to more easily get the result out of a thread, and to transport exceptions from one thread to another thread, which can then handle the exception however it wants. Of course, it's still good practice to always try to handle exceptions in the actual threads as much as possible, in order to prevent them from leaving the thread.

A *promise* is something where a thread stores its result. A future is used to get access to the result stored in a promise. That is, a promise is the input side for a result, a future is the output side. Once a function, running in the same thread or in another thread, has calculated the value that it wants to return, it can put this value in a promise. This value can then be retrieved through a future. You can think of this mechanism as an inter-thread communication channel for a result.

C++ provides a standard future, called `std::future`. You can retrieve the result from an `std::future` as follows. `T` is the type of the calculated result.

```
future<T> myFuture = ...; // Is discussed later
T result = myFuture.get();
```

The call to `get()` retrieves the result and stores it in the variable `result`. If calculating the result is not finished yet, the call to `get()` blocks until the value becomes available. You can only call `get()` once on a future. The behavior of calling it a second time is undefined by the standard.

If you want to avoid blocking, you can first ask the future if there is a result available:

```
if (myFuture.wait_for(0)) { // Value is available
    T result = myFuture.get();
} else { // Value is not yet available
    ...
}
```

`std::promise` and `std::future`

C++ provides the `std::promise` class as one way to implement the concept of a promise. You can call `set_value()` on a promise to store a result, or you can call `set_exception()` on it to store an exception in the promise. Note that you can only call `set_value()` or `set_exception()` once on a specific promise. If you call it multiple times, an `std::future_error` exception will be thrown.

A thread A that launches another thread B to calculate something can create an `std::promise` and pass this to the launched thread. Note that a promise cannot be copied, but it can be moved into a thread! Thread B uses that promise to store the result. Before moving the promise into thread B,

thread A calls `get_future()` on the created promise to be able to get access to the result once B has finished. Here is a simple example:

```
void DoWork(promise<int> thePromise)
{
    // ... Do some work ...
    // And ultimately store the result in the promise.
    thePromise.set_value(42);
}

int main()
{
    // Create a promise to pass to the thread.
    promise<int> myPromise;
    // Get the future of the promise.
    auto theFuture = myPromise.get_future();
    // Create a thread and move the promise into it.
    thread theThread{ DoWork, std::move(myPromise) };

    // Do some more work...

    // Get the result.
    int result = theFuture.get();
    cout << "Result: " << result << endl;

    // Make sure to join the thread.
    theThread.join();
}
```

NOTE *This code is just for demonstration purposes. It starts the calculation in a new thread, and then calls `get()` on the future, which blocks until the result is calculated. This sounds like a very expensive function call. In real-world applications, you can use futures by periodically checking if there is a result available or not (using `wait_for()` as discussed earlier), or by using a synchronization mechanism such as a condition variable. When the result is not yet available, you can do something else in the meantime, instead of blocking.*

std::packaged_task

An `std::packaged_task` makes it easier to work with promises than explicitly using `std::promise`, as in the previous section. The following code demonstrates this. It creates a `packaged_task` to execute `CalculateSum()`. The future is retrieved from the `packaged_task` by calling `get_future()`. A thread is launched, and the `packaged_task` is moved into it. A `packaged_task` cannot be copied! After the thread is launched, `get()` is called on the retrieved future to get the result. This blocks until the result is available.

Note that `CalculateSum()` does not need to store anything explicitly in any kind of promise. A `packaged_task` automatically creates a promise, automatically stores the result of the called

function, `CalculateSum()` in this case, in the promise, and automatically stores any exceptions thrown from the function in the promise.

```
int CalculateSum(int a, int b) { return a + b; }

int main()
{
    // Create a packaged task to run CalculateSum.
    packaged_task<int(int, int)> task(CalculateSum);
    // Get the future for the result of the packaged task.
    auto theFuture = task.get_future();
    // Create a thread, move the packaged task into it, and
    // execute the packaged task with the given arguments.
    thread theThread{ std::move(task), 39, 3 };

    // Do some more work...

    // Get the result.
    int result = theFuture.get();
    cout << result << endl;

    // Make sure to join the thread.
    theThread.join();
}
```

std::async

If you want to give the C++ runtime more control over whether or not a thread is created to calculate something, you can use `std::async()`. It accepts a function to be executed, and returns a future that you can use to retrieve the result. There are two ways in which `async()` can run your function:

- Run your function on a separate thread asynchronously
- Run your function on the calling thread synchronously at the time you call `get()` on the returned future

If you call `async()` without additional arguments, the runtime automatically chooses one of the two methods depending on factors such as the number of CPU cores in your system and the amount of concurrency already taking place. You can influence the runtime's behavior by specifying a policy argument.

- **launch::async:** forces the runtime to execute the function asynchronously on a different thread.
- **launch::deferred:** forces the runtime to execute the function synchronously on the calling thread when `get()` is called.
- **launch::async | launch::deferred:** lets the runtime choose (= default behavior).

The following example demonstrates the use of `async()`:

```

int calculate()
{
    return 123;
}

int main()
{
    auto myFuture = async(calculate);
    //auto myFuture = async(launch::async, calculate);
    //auto myFuture = async(launch::deferred, calculate);

    // Do some more work...

    // Get the result.
    int result = myFuture.get();
    cout << result << endl;
}

```

As you can see in this example, `std::async()` is one of the easiest methods to perform some calculations either asynchronously (on a different thread), or synchronously (on the same thread), and retrieve the result afterward.

WARNING A future returned by a call to `async()` blocks in its destructor until the result is available. That means that if you call `async()` without capturing the returned future, the `async()` call effectively becomes a blocking call! For example, the following line synchronously calls `calculate()`:

```
    async(calculate);
```

What happens with this statement is that `async()` creates and returns a future. This future is not captured, so it is a temporary future. Because it is a temporary future, its destructor is called before this statement is finished, and this destructor will block until the result is available.

Exception Handling

A big advantage of using futures is that they can transport exceptions between threads. Calling `get()` on a future either returns the calculated result, or rethrows any exception that has been stored in the promise linked to the future. When you use `packaged_task` or `async()`, any exception thrown from the launched function is automatically stored in the promise. If you use `std::promise` as your promise, you can call `set_exception()` to store an exception in it. Here is an example using `async()`:

```

int calculate()
{
    throw runtime_error("Exception thrown from calculate().");
}

```

```

int main()
{
    // Use the launch::async policy to force asynchronous execution.
    auto myFuture = async(launch::async, calculate);

    // Do some more work...

    // Get the result.
    try {
        int result = myFuture.get();
        cout << result << endl;
    } catch (const exception& ex) {
        cout << "Caught exception: " << ex.what() << endl;
    }
}

```

std::shared_future

`std::future<T>` only requires `T` to be move-constructible. When you call `get()` on a `future<T>`, the result is moved out of the future and returned to you. This means you can call `get()` only once on a `future<T>`.

If you want to be able to call `get()` multiple times, even from multiple threads, then you need to use an `std::shared_future<T>`, in which case `T` needs to be copy-constructible. A `shared_future` can be created by using `std::future::share()`, or by passing a future to the `shared_future` constructor. Note that a future is not copyable, so you have to move it into the `shared_future` constructor.

`shared_future` can be used to wake up multiple threads at once. For example, the following piece of code defines two lambda expressions to be executed asynchronously on different threads. The first thing each lambda expression does is set a value to their respective `promise` to signal that they have started. Then they both call `get()` on `signalFuture` which blocks until a parameter is made available through the future, after which they continue their execution. Each lambda expression captures their respective `promise` by reference, and captures `signalFuture` by value, so both lambda expressions have a copy of `signalFuture`. The main thread uses `async()` to execute both lambda expressions asynchronously on different threads, waits until both threads have started, and then sets the parameter in the `signalPromise` which wakes up both threads.

```

promise<void> thread1Started, thread2Started;

promise<int> signalPromise;
auto signalFuture = signalPromise.get_future().share();
//shared_future<int> signalFuture(signalPromise.get_future());

auto function1 = [&thread1Started, signalFuture] {
    thread1Started.set_value();
    // Wait until parameter is set.
    int parameter = signalFuture.get();
    // ...
};

auto function2 = [&thread2Started, signalFuture] {
    thread2Started.set_value();
    // Wait until parameter is set.
};

```

```

        int parameter = signalFuture.get();
        // ...
    };

    // Run both lambda expressions asynchronously.
    // Remember to capture the future returned by async()!
    auto result1 = async(launch::async, function1);
    auto result2 = async(launch::async, function2);

    // Wait until both threads have started.
    thread1Started.get_future().wait();
    thread2Started.get_future().wait();

    // Both threads are now waiting for the parameter.
    // Set the parameter to wake up both of them.
    signalPromise.set_value(42);

```

EXAMPLE: MULTITHREADED LOGGER CLASS

This section demonstrates how to use threads, mutual exclusion objects, locks, and condition variables to write a multithreaded `Logger` class. The class allows log messages to be added to a queue from different threads. The `Logger` class itself processes this queue in a background thread that serially writes the log messages to a file. The class will be designed in two iterations to show you some examples of problems you will encounter when writing multithreaded code.

The C++ standard does not have a thread-safe queue, so it is obvious that you have to protect access to the queue with some synchronization mechanism to prevent multiple threads from reading/writing to the queue at the same time. This example uses a mutual exclusion object and a condition variable to provide the synchronization. Based on that, you might define the `Logger` class as follows:

```

class Logger
{
public:
    // Starts a background thread writing log entries to a file.
    Logger();
    // Prevent copy construction and assignment.
    Logger(const Logger& src) = delete;
    Logger& operator=(const Logger& rhs) = delete;
    // Add log entry to the queue.
    void log(std::string_view entry);
private:
    // The function running in the background thread.
    void processEntries();
    // Mutex and condition variable to protect access to the queue.
    std::mutex mMutex;
    std::condition_variable mCondVar;
    std::queue<std::string> mQueue;
    // The background thread.
    std::thread mThread;
};

```

The implementation is as follows. Note that this initial design has a couple of problems and when you try to run it, it might behave strangely or even crash. This is discussed and solved in the next iteration of the `Logger` class. The inner `while` loop in the `processEntries()` method is worth looking at. It processes all messages in the queue one at a time, and acquires and releases the lock on each iteration. This is done to make sure the loop doesn't keep the lock for too long, blocking other threads.

```
Logger::Logger()
{
    // Start background thread.
    mThread = thread{ &Logger::processEntries, this };
}

void Logger::log(string_view entry)
{
    // Lock mutex and add entry to the queue.
    unique_lock lock(mMutex);
    mQueue.push(string(entry));
    // Notify condition variable to wake up thread.
    mCondVar.notify_all();
}

void Logger::processEntries()
{
    // Open log file.
    ofstream logFile("log.txt");
    if (logFile.fail()) {
        cerr << "Failed to open logfile." << endl;
        return;
    }

    // Start processing loop.
    unique_lock lock(mMutex);
    while (true) {
        // Wait for a notification.
        mCondVar.wait(lock);

        // Condition variable notified, something might be in the queue.
        lock.unlock();
        while (true) {
            lock.lock();
            if (mQueue.empty()) {
                break;
            } else {
                logFile << mQueue.front() << endl;
                mQueue.pop();
            }
            lock.unlock();
        }
    }
}
```

WARNING *As you can already see from this rather simple task, writing correct multithreaded code is hard! Unfortunately, at this moment, threads, atomics, mutual exclusion objects, condition variables, and futures, are all the C++ standard provides. C++ does not provide any concurrent data structures, at least not yet in C++17. This might change in the future though.*

The Logger class is just an example to show these basic building blocks. For production-quality code, I recommend using an appropriate third party concurrent data structure, instead of writing your own. For example, the open-source boost C++ libraries¹ have an implementation of a queue that is lock-free, and allows concurrent use without the need for any explicit synchronization.

This Logger class can be tested with the following test code. It launches a number of threads, all logging a few messages to the same Logger instance.

```
void logSomeMessages(int id, Logger& logger)
{
    for (int i = 0; i < 10; ++i) {
        stringstream ss;
        ss << "Log entry " << i << " from thread " << id;
        logger.log(ss.str());
    }
}

int main()
{
    Logger logger;
    vector<thread> threads;
    // Create a few threads all working with the same Logger instance.
    for (int i = 0; i < 10; ++i) {
        threads.emplace_back(logSomeMessages, i, ref(logger));
    }
    // Wait for all threads to finish.
    for (auto& t : threads) {
        t.join();
    }
}
```

If you build and run this naive initial version, you will notice that the application is terminated abruptly. That is caused because the application never calls `join()` or `detach()` on the background thread. Remember from earlier in this chapter that the destructor of a `thread` object which is still joinable, that is, neither `join()` nor `detach()` has been called yet, will call `std::terminate()` to terminate all running threads and the application itself. This means that messages still in the queue are not written to the file on disk. Some runtime libraries even issue an error or generate a crash

¹<http://www.boost.org/>

dump when the application is terminated like this. You need to add a mechanism to gracefully shut down the background thread and wait until the background thread is completely shut down before terminating the application. You can do this by adding a destructor and a Boolean member variable to the class. The new definition of the class is as follows:

```
class Logger
{
public:
    // Gracefully shut down background thread.
    virtual ~Logger();

    // Other public members omitted for brevity
private:
    // Boolean telling the background thread to terminate.
    bool mExit = false;

    // Other members omitted for brevity
};
```

The destructor sets `mExit` to `true`, wakes up the background thread, and then waits until the thread is shut down. The destructor acquires a lock on `mMutex` before setting `mExit` to `true` and before calling `notify_all()`. This is to prevent a race condition and deadlock with `processEntries()`. `processEntries()` could be at the beginning of its `while` loop right after having checked `mExit` and right before the call to `wait()`. If the main thread calls the `Logger` destructor at that very moment, and the destructor wouldn't acquire a lock on `mMutex`, then the destructor sets `mExit` to `true` and calls `notify_all()` after `processEntries()` has checked `mExit` and before `processEntries()` is waiting on the condition variable; thus, `processEntries()` will not see the new value of `mExit` and it will miss the notification. In that case, the application is in a deadlock situation, because the destructor is waiting on the `join()` call and the background thread is waiting on the condition variable. Note that the destructor must release the lock on `mMutex` before calling `join()`, which explains the extra code block using curly brackets.

WARNING *In general, you should always own a lock on the mutex associated with a condition variable when setting the condition it's waiting for.*

```
Logger::~~Logger()
{
    {
        unique_lock lock(mMutex);
        // Gracefully shut down the thread by setting mExit
        // to true and notifying the thread.
        mExit = true;
        // Notify condition variable to wake up thread.
        mCondVar.notify_all();
    }
}
```



```

        // Wait until thread is shut down. This should be outside the above code
        // block because the lock must be released before calling join()!
        mThread.join();
    }
}

```

The `processEntries()` method needs to check this Boolean variable and terminate the processing loop when it's true:

```

void Logger::processEntries()
{
    // Open log file.
    ofstream logFile("log.txt");
    if (logFile.fail()) {
        cerr << "Failed to open logfile." << endl;
        return;
    }

    // Start processing loop.
    unique_lock lock(mMutex);
    while (true) {
        if (!mExit) { // Only wait for notifications if we don't have to exit.
            // Wait for a notification.
            mCondVar.wait(lock);
        }

        // Condition variable is notified, so something might be in the queue
        // and/or we need to shut down this thread.
        lock.unlock();
        while (true) {
            lock.lock();
            if (mQueue.empty()) {
                break;
            } else {
                logFile << mQueue.front() << endl;
                mQueue.pop();
            }
            lock.unlock();
        }
        if (mExit) {
            break;
        }
    }
}

```

Note that you cannot just check for `mExit` in the condition for the outer `while` loop because even when `mExit` is true, there might still be log entries in the queue that need to be written.

You can add artificial delays in specific places in your multithreaded code to trigger certain behavior. Note that such delays should only be added for testing, and should be removed from your final code! For example, to test that the race condition with the destructor is solved, you can remove any calls to `log()` from the main program, causing it to almost immediately call the destructor of the `Logger` class, and add the following delay:

```

void Logger::processEntries()
{
    // Omitted for brevity

```

```

// Start processing loop.
unique_lock lock(mMutex);
while (true) {
    this_thread::sleep_for(1000ms); // Needs #include <chrono>

    if (!mExit) { // Only wait for notifications if we don't have to exit.
        // Wait for a notification.
        mCondVar.wait(lock);
    }

    // Omitted for brevity
}
}

```

THREAD POOLS

Instead of creating and deleting threads dynamically throughout your program's lifetime, you can create a pool of threads that can be used as needed. This technique is often used in programs that want to handle some kind of event in a thread. In most environments, the ideal number of threads is equal to the number of processing cores. If there are more threads than cores, threads will have to be suspended to allow other threads to run, and this will ultimately add overhead. Note that while the ideal number of threads is equal to the number of cores, this applies only in the case where the threads are compute bound and cannot block for any other reason, including I/O. When threads can block, it is often appropriate to run more threads than there are cores. Determining the optimal number of threads in such cases is hard, and may involve throughput measurements.

Because not all processing is identical, it is not uncommon to have threads from a thread pool receive, as part of their input, a function object or lambda expression that represents the computation to be done.

Because threads from a thread pool are pre-existing, it is much more efficient for the operating system to schedule a thread from the pool to run than it is to create one in response to an input. Furthermore, the use of a thread pool allows you to manage the number of threads that are created, so, depending on the platform, you may have just one thread or thousands of threads.

Several libraries are available that implement thread pools, including Intel Threading Building Blocks (TBB), Microsoft Parallel Patterns Library (PPL), and so on. It's recommended to use such a library for your thread pools instead of writing your own implementation. If you do want to implement a thread pool yourself, it can be done in a similar way to an object pool. Chapter 25 gives an example implementation of an object pool.

THREADING DESIGN AND BEST PRACTICES

This section briefly lists a few best practices related to multithreaded programming.

- **Use parallel Standard Library algorithms:** The Standard Library contains a large collection of algorithms. Since C++17, more than 60 of them support parallel execution! Whenever possible, use such parallel algorithms instead of writing your own multithreaded code. See Chapter 18 for details on how to specify parallelization options for algorithms.

- **Before closing the application, make sure all thread objects are unjoinable:** Make sure that either `join()` or `detach()` has been called on all thread objects. Destructors of threads that are still joinable will call `std::terminate()` which abruptly terminates all threads and the application.
- **The best synchronization is no synchronization:** Multithreaded programming becomes much easier if you manage to design your different threads in such a way that all threads working on shared data read only from that shared data and never write to it, or only write to parts never read by other threads. In that case, there is no need for any synchronization, and you cannot have problems like data races or deadlocks.
- **Try to use the single-thread ownership pattern:** This means that a block of data is owned by no more than one thread at a time. Owning the data means that no other thread is allowed to read from or write to the data. When the thread is finished with the data, the data can be passed off to another thread, which now has sole and complete responsibility/ownership of the data. No synchronization is necessary in this case.
- **Use atomic types and operations when possible:** Atomic types and atomic operations make it easier to write data-race and deadlock-free code, because they handle synchronization automatically. If atomic types and operations are not possible in your multithreaded design, and you need shared data, you have to use some synchronization mechanism, such as mutual exclusion, to ensure proper synchronization.
- **Use locks to protect mutable shared data:** If you need mutable shared data to which multiple threads can write, and you cannot use atomic types and operations, you have to use a locking mechanism to make sure that reads and writes between different threads are synchronized.
- **Release locks as soon as possible:** When you need to protect your shared data with a lock, make sure that you release the lock as soon as possible. While a thread is holding a lock, it is blocking other threads waiting for the same lock, possibly hurting performance.
- **Do not manually acquire multiple locks, instead use `std::lock()` or `std::try_lock()`:** If multiple threads need to acquire multiple locks, they must be acquired in the same order in all threads to prevent deadlocks. You should use the generic `std::lock()` or `std::try_lock()` functions to acquire multiple locks.
- **Use RAII lock objects:** Use the `lock_guard`, `unique_lock`, `shared_lock`, or `scoped_lock` RAII classes to automatically release locks at the right time.
- **Use a multithreading-aware profiler:** This helps to find performance bottlenecks in your multithreaded applications, and to find out if your multiple threads are indeed utilizing all available processing power in your system. An example of a multithreading-aware profiler is the profiler in certain editions of Microsoft Visual Studio.
- **Understand the multithreading support features of your debugger:** Most debuggers have at least basic support for debugging multithreaded applications. You should be able to get a list of all running threads in your application, and you should be able to switch to any one of those threads to inspect their call stack. You can use this, for example, to inspect deadlocks because you can see exactly what each thread is doing.

- **Use thread pools instead of creating and destroying a lot of threads dynamically:** Your performance decreases if you dynamically create and destroy a lot of threads. In that case, it's better to use a thread pool to reuse existing threads.
- **Use higher-level multithreading libraries:** The C++ standard, at this moment, only provides basic building blocks for writing multithreaded code. Using those correctly is not trivial. Where possible, use higher-level multithreading libraries such as Intel Threading Building Blocks (TBB), Microsoft Parallel Patterns Library (PPL), and so on, rather than reinventing the wheel. Multithreaded programming is hard to get right, and is error prone. More often than not, your wheel may not be as round as you think.

SUMMARY

This chapter gave a brief overview of multithreaded programming using the standard C++ threading support library. It explained how you can use atomic types and atomic operations to operate on shared data without having to use an explicit synchronization mechanism. In case you cannot use these atomic types and operations, you learned how to use mutual exclusion mechanisms to ensure proper synchronization between different threads that need read/write access to shared data. You also saw how promises and futures represent a simple inter-thread communication channel; you can use futures to more easily get a result back from a thread. The chapter finished with a number of best practices for multithreaded application design.

As mentioned in the introduction, this chapter tried to touch on all the basic multithreading building blocks provided by the Standard Library, but due to space constraints, it cannot go into all the details of multithreaded programming. There are books available that discuss nothing but multithreading. See Appendix B for a few references.

PART V

C++ Software Engineering

- ▶ CHAPTER 24: Maximizing Software Engineering Methods
- ▶ CHAPTER 25: Writing Efficient C++
- ▶ CHAPTER 26: Becoming Adept at Testing
- ▶ CHAPTER 27: Conquering Debugging
- ▶ CHAPTER 28: Incorporating Design Techniques and Frameworks
- ▶ CHAPTER 29: Applying Design Patterns
- ▶ CHAPTER 30: Developing Cross-Platform and Cross-Language Applications

24

Maximizing Software Engineering Methods

WHAT'S IN THIS CHAPTER?

- ▶ What a software life cycle model is, with examples of the Waterfall Model, the Sashimi Model, spiral-like models, and Agile
- ▶ What software engineering methodologies are, with examples of UP, RUP, Scrum, XP, and Software Triage
- ▶ What Source Code Control means

Chapter 24 starts the last part of this book, which is about software engineering. This part describes software engineering methods, code efficiency, testing, debugging, design techniques, design patterns, and how to target multiple platforms.

When you first learned how to program, you were probably on your own schedule. You were free to do everything at the last minute if you wanted to, and you could radically change your design during implementation. When coding in the professional world, however, programmers rarely have such flexibility. Even the most liberal engineering managers admit that some amount of process is necessary. These days, knowing the software engineering process is as important as knowing how to code.

In this chapter, I will survey various approaches to software engineering. I will not go into great depth on any one approach—there are plenty of excellent books on software engineering processes. My intention is to cover some different types of processes in broad strokes so you can compare and contrast them. I will try not to advocate or discourage any particular methodology. Rather, I hope that by learning about the tradeoffs of several different approaches, you'll be able to construct a process that works for you and the rest of your team. Whether you're a contractor working alone on projects, or your team consists of hundreds of engineers on several continents, understanding different approaches to software development will help you with your job on a daily basis.

The last part of this chapter discusses Source Code Control solutions that make it easier to manage source code and keep track of its history. A Source Code Control solution is mandatory in every company in order to avoid a source code maintenance nightmare, and it is even highly recommended for one-person projects.

THE NEED FOR PROCESS

The history of software development is filled with tales of failed projects. From over-budget and poorly marketed consumer applications to grandiose mega-hyped operating systems, it seems that no area of software development is free from this trend.

Even when software successfully reaches users, bugs have become so commonplace that end users are often forced to endure constant updates and patches. Sometimes the software does not accomplish the tasks it is supposed to do or doesn't work the way the user would expect. These issues all point to a common truism of software: writing software is hard.

You may wonder why software engineering seems to differ from other forms of engineering in its frequency of failures. For example, while cars have their share of bugs, you rarely see them stop suddenly and demand a reboot due to a buffer overflow (though as more and more car components become software-driven, you just may). Your TV may not be perfect, but you don't have to upgrade to version 2.3 to get Channel 6 to work.

Is it the case that other engineering disciplines are just more advanced than software development? Is a civil engineer able to construct a working bridge by drawing upon the long history of bridge building? Are chemical engineers able to build a compound successfully because most of the bugs were worked out in earlier generations? Is software engineering too new, or is it really a different type of discipline with inherent qualities contributing to the occurrence of bugs, unusable results, and doomed projects?

It certainly seems as if there's something different about software engineering. For one thing, computer technology changes rapidly, creating uncertainty in the software development process. Even if an earth-shattering breakthrough does not occur during your project, the pace at which the IT industry moves can lead to problems. Software also often needs to be developed quickly because competition is fierce.

Software development schedules can also be unpredictable. Accurate scheduling is nearly impossible when a single gnarly bug can take days or even weeks to fix. Even when things seem to be going according to schedule, the widespread tendency of product definition changes (*feature creep*) can throw a wrench in the process.

Software is often complex. There is no easy and accurate way to prove that a program is bug-free. Buggy or messy code can have an impact on software for years if it is maintained through several versions. Software systems are often so complex that when staff turnover occurs, nobody wants to get anywhere near some legacy messy code. This leads to a cycle of endless patching, hacks, and workarounds.

Of course, standard business risks apply to software as well. Marketing pressures and miscommunication get in the way. Many programmers try to steer clear of corporate politics, but it's not uncommon to have adversity between the development and product marketing groups.

All of these factors working against software engineering products indicate the need for some sort of process. Software projects are big, complicated, and fast-paced. To avoid failure, engineering groups need to adopt a system to control this unwieldy process.

Elegantly designed software with clean and maintainable code can be developed. I'm convinced it is possible, but it takes continuous efforts of each individual team member, and requires following proper software development processes and practices.

SOFTWARE LIFE CYCLE MODELS

Complexity in software isn't new. The need for a formalized process was recognized decades ago. Several approaches to modeling the *software life cycle* have attempted to bring some order to the chaos of software development by defining the software process in terms of steps from the initial idea to the final product. These models, refined over the years, guide much of software development today.

The Waterfall Model

A classic life cycle model for software is the *Waterfall Model*. This model is based on the idea that software can be built almost like following a recipe. There is a set of steps that, if followed correctly, will yield a mighty fine chocolate cake, or program as the case may be. Each stage must be completed before the next stage can begin, as shown in Figure 24-1. You can compare this process to a waterfall, as you can only go downward to the next phase.

The process starts with formal planning, which includes gathering an exhaustive list of requirements. This list defines feature completeness for the product. The more specific the requirements are, the more likely that the project will succeed. Next, the software is designed and fully specified. The design step, like the requirements step, needs to be as specific as possible to maximize the chance of success. All design decisions are made at this time, often including pseudo-code and the definition of specific subsystems that will need to be written. Subsystem owners work out how their code will interact, and the team agrees on the specifics of the architecture. Implementation of the design occurs next. Because the design has been fully specified, the code needs to adhere strongly to the design or else the pieces won't fit together. The final four stages are reserved for unit testing, subsystem testing, integration testing, and evaluation.

The main problem with the Waterfall Model is that, in practice, it is nearly impossible to complete one stage without at least exploring the next stage.

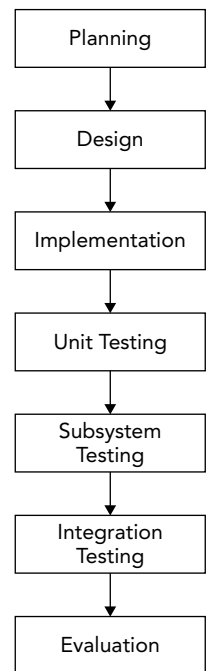

FIGURE 24-1

A design cannot be set in stone without at least writing *some* code. Furthermore, what is the point of testing if the model doesn't provide a way to go back to the coding phase?

Various incarnations have refined the process in different ways. For example, some plans include a “feasibility” step where experiments are performed before formal requirements are even gathered.

Benefits of the Waterfall Model

The value of the Waterfall Model lies in its simplicity. You, or your manager, may have followed this approach in past projects without formalizing it or recognizing it by name. The underlying assumption behind the Waterfall Model is that as long as each step is accomplished as completely and accurately as possible, subsequent steps will go smoothly. As long as all of the requirements are carefully specified in the first step, and all the design decisions and problems are hashed out in the second step, implementation in the third step should be a simple matter of translating the designs into code.

The simplicity of the Waterfall Model makes project plans based on this system organized and easy to manage. Every project is started the same way: by exhaustively listing all the features that are necessary. For example, managers using this approach can require that by the end of the design phase, all engineers in charge of a subsystem must submit their design as a formal design document or a functional subsystem specification. The benefit for the manager is that by having engineers specify requirements and designs upfront, risks are, hopefully, minimized.

From the engineer's point of view, the Waterfall Model forces resolution of major issues upfront. All engineers will need to understand their project and design their subsystem before writing a significant amount of code. Ideally, this means that code can be written once instead of being hacked together or rewritten when the pieces don't fit.

For small projects with very specific requirements, the Waterfall Model can work quite well. Particularly for consulting arrangements, it has the advantage of specifying clearly defined metrics for success at the start of the project. Formalizing requirements helps the consultant to produce exactly what the client wants, and forces the client to be specific about the goals for the project.

Drawbacks of the Waterfall Model

In many organizations, and almost all modern software engineering texts, the Waterfall Model has fallen out of favor. Critics disparage its fundamental premise that software development tasks happen in discrete, linear steps. The Waterfall Model generally does not allow backward movement. Unfortunately, in many projects today, new requirements are introduced throughout the development of the product. Often, a potential customer will request a feature that is necessary for the sale, or a competitor's product will have a new feature that requires parity.

NOTE *The upfront specification of all requirements makes the Waterfall Model unusable for many organizations because it is not dynamic enough.*

Another drawback is that in an effort to minimize risk by making decisions as formally and early as possible, the Waterfall Model may actually be hiding risk. For example, a major design issue might be undiscovered, glossed over, forgotten, or purposely avoided during the design phase. By the time integration testing reveals the mismatch, it may be too late to save the project. A major design flaw has arisen but, according to the Waterfall Model, the product is one step away from shipping! A mistake anywhere in the waterfall process will likely lead to failure at the end of the process. Early detection is difficult and occurs rarely.

If you do use the Waterfall Model, it is often necessary to make it more flexible by taking cues from other approaches.

Sashimi Model

A number of refinements to the Waterfall Model have been formalized. One such refinement is called the *Sashimi Model*. The main advancement that the Sashimi Model brought was the concept of overlap between stages. The name, Sashimi Model, comes from a Japanese fish dish, called sashimi, in which different pieces of fish are overlapping each other. While the model still stresses a rigorous process of planning, designing, coding, and testing, successive stages can partially overlap. Figure 24-2 shows an example of the Sashimi Model, illustrating the overlapping of stages. Overlap permits activities in two phases to occur simultaneously. This recognizes the fact that one stage can often not be finished completely without at least partially looking at the next stage.

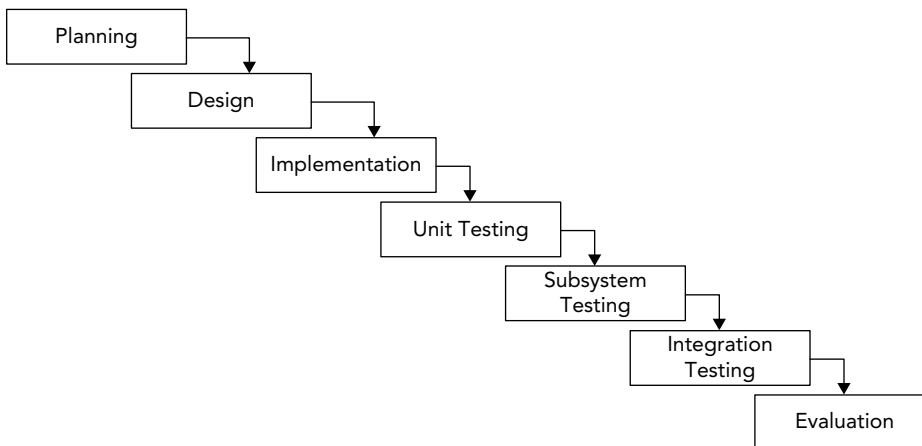
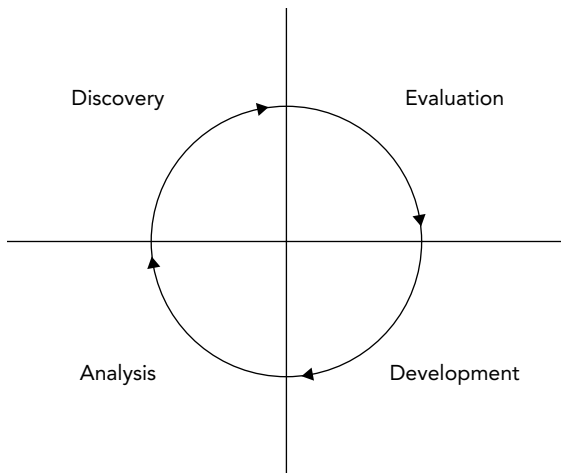

FIGURE 24-2

Spiral-Like Models

The *Spiral Model* was proposed by Barry W. Boehm in 1986 as a risk-driven software development process. Several derivatives have been formulated, which are called spiral-like models. The model discussed in this section is part of a family of techniques known as *iterative processes*. The fundamental idea is that it's okay if something goes wrong because you'll fix it the next time around. A single spin through this spiral-like model is shown in Figure 24-3.

**FIGURE 24-3**

The phases of this model are similar to the steps of the Waterfall Model. The discovery phase involves discovering requirements, determining objectives, determining alternatives (design alternatives, reuse, buying third-party libraries, and so on), and determining any constraints. During the evaluation phase, implementation alternatives are evaluated, risks are analyzed, and prototype options are considered. In a spiral-like model, particular attention is paid to evaluating and resolving risks in the evaluation phase. The tasks deemed most risky are the ones that are implemented in the current cycle of the spiral. The tasks in the development phase are determined by the risks identified in the evaluation phase. For example, if evaluation reveals a risky algorithm that may be impossible to implement, the main task for development in the current cycle will be modeling, building, and testing that algorithm. The fourth phase is reserved for analysis and planning. Based on the results of the current cycle, a plan for the subsequent cycle is formed.

Figure 24-4 shows an example of three cycles through the spiral in the development of an operating system. The first cycle yields a plan containing the major requirements for the product. The second cycle results in a prototype showing the user experience. The third cycle builds a component that is determined to be a high risk.

Benefits of a Spiral-Like Model

A spiral-like model can be viewed as the application of an iterative approach to the best that the Waterfall Model has to offer. Figure 24-5 shows a spiral-like model as a waterfall process that has been modified to allow iteration. Hidden risks and a linear development path, the main drawbacks of the Waterfall Model, are resolved through iterative cycles.

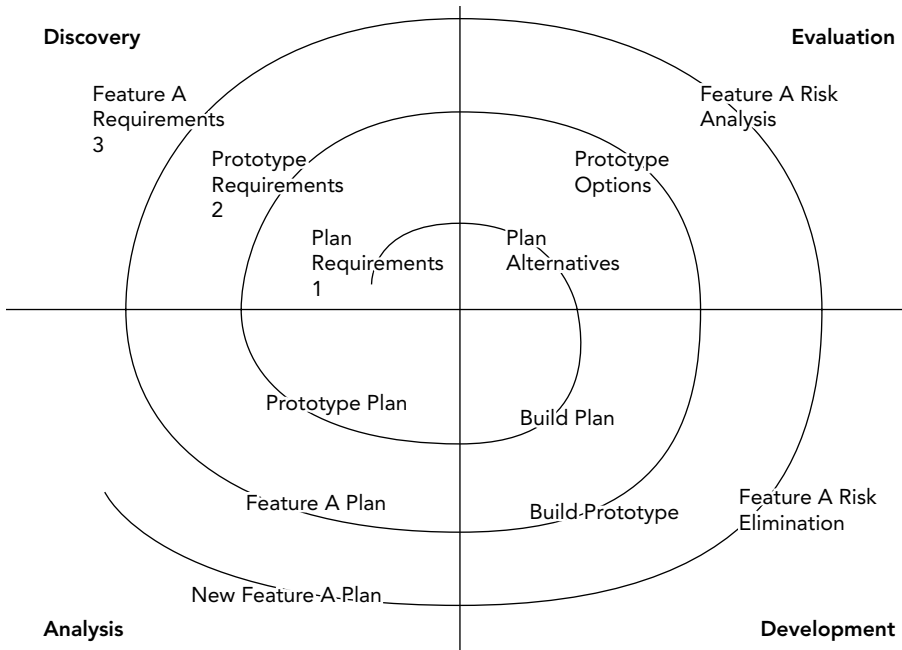

FIGURE 24-4

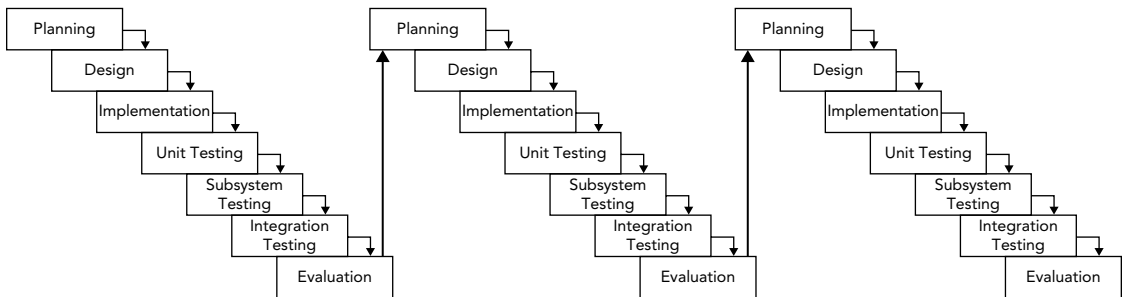

FIGURE 24-5

Performing the riskiest tasks first is another benefit. By bringing risk to the forefront and acknowledging that new conditions can arise at any time, a spiral-like model avoids the hidden time bombs that can occur with the Waterfall Model. When unexpected problems arise, they can be dealt with by using the same four-stage approach that works for the rest of the process.

This iterative approach also allows for incorporating feedback from testers. For example, an early version of the product can be released for internal or even external evaluation. Testers could, for instance, say that a certain feature is missing, or an existing feature is not working as expected. A spiral-like model has a built-in mechanism to react to such input.

Finally, by repeatedly analyzing after each cycle and building new designs, the practical difficulties with the design-then-implement approach are virtually eliminated. With each cycle, there is more knowledge of the system that can influence the design.

Drawbacks of a Spiral-Like Model

The main drawback of a spiral-like model is that it can be difficult to scope each iteration small enough to gain real benefit. In a worst-case scenario, a spiral-like model can degenerate into a Waterfall Model because the iterations are too long. Unfortunately, a spiral-like model only *models* the software life cycle; it cannot prescribe a specific way to break down a project into single-cycle iterations because that division varies from project to project.

Other possible drawbacks are the overhead of repeating all four phases for each cycle and the difficulty of coordinating cycles. Logistically, it may be difficult to assemble all the group members for design discussions at the right time. If different teams are working on different parts of the product simultaneously, they are probably operating in parallel cycles, which can get out of synch. For example, during the development of an operating system, the user interface group could be ready to start the discovery phase of the Window Manager cycle, but the core OS group could still be in the development phase of the memory subsystem.

Agile

To address the shortcomings of the Waterfall Model, the *Agile Model* was introduced in 2001 in the form of an *Agile Manifesto*.

MANIFESTO FOR AGILE SOFTWARE DEVELOPMENT

The entire manifesto, taken from <http://agilemanifesto.org/>, is as follows:

We are uncovering better ways of developing software by doing it and helping others do it. Through this work we have come to value:

- **Individuals and interactions** over processes and tools
- **Working software** over comprehensive documentation
- **Customer collaboration** over contract negotiation
- **Responding to change** over following a plan

That is, while there is value in the items on the right, we value the items on the left more.

As can be understood from this manifesto, the term *Agile* is only a high-level description. Basically, it tells you to make the process flexible so that customers' changes can easily be incorporated into the project during development. Scrum is one of the most used Agile software development methodologies, and is discussed in the next section.

SOFTWARE ENGINEERING METHODOLOGIES

Software life cycle models provide a formal way of answering the question, “What do we do next?” but are rarely able to contribute an answer to the logical follow-up question, “How do we do it?” To provide some answers to the “how” question, a number of methodologies have been developed that provide practical rules of thumb for professional software development. Books and articles on software methodologies abound, but a few of these methodologies deserve particular attention: *UP*, *RUP*, *Scrum*, *Extreme Programming*, and *Software Triage*.

The Unified Process

The *Unified Process* (UP) is an iterative and incremental software development process. The UP is not set in stone; it's a framework that you should customize to the specific needs of your project. According to the Unified Process, a project can be split into four phases.

- **Inception:** This phase is usually very short. It includes a feasibility study, writing of a business case, deciding whether the project should be developed in-house or bought from a third-party vendor, defining a rough estimate of the cost and timeline, and defining the scope.
- **Elaboration:** Most of the requirements are documented. Risk factors are addressed, and the system architecture is validated. To validate the architecture, the most important parts of the core of the architecture are built as an executable delivery. This should demonstrate that the developed architecture will be able to support the entire system.
- **Construction:** All requirements are implemented on top of the executable architecture delivery from the elaboration phase.
- **Transition:** The product is delivered to the customer. Feedback from the customer is addressed in subsequent transition iterations.

The elaboration, construction, and transition phases are split into time-boxed *iterations*, each having a tangible result. In each iteration, the teams are working on several *disciplines* of the project at the same time: business modeling, requirements, analysis and design, implementation, testing, and deployment. The amount of work done in each discipline changes with each iteration. This iterative and overlapping development is shown in Figure 24-6. In this example, the inception phase is done in one iteration, the elaboration phase in two, the construction phase in four, and the transition phase in two iterations.

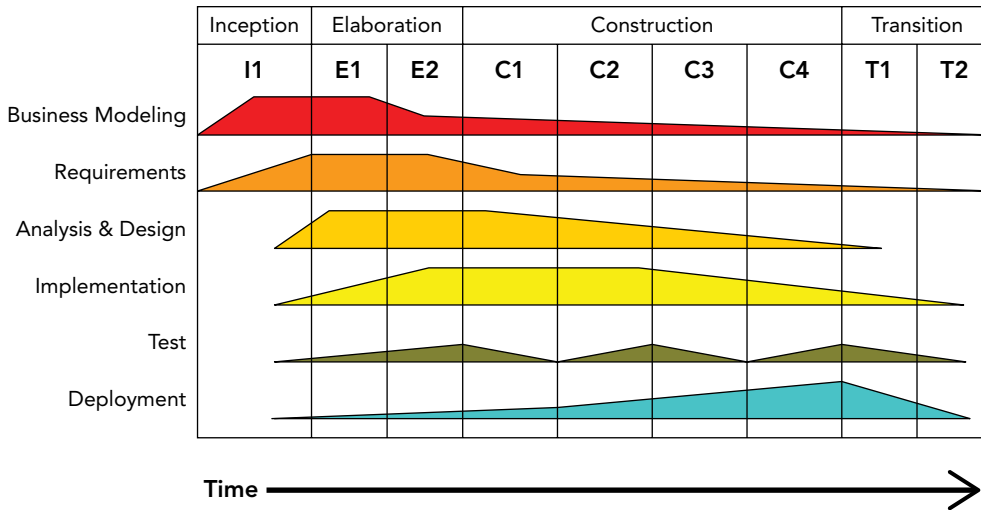

FIGURE 24-6

The Rational Unified Process

The *Rational Unified Process (RUP)* is one of the best-known refinements of the Unified Process. It is a disciplined and formal approach to managing the software development process. The most important characteristic of the RUP is that, unlike the Spiral Model or the Waterfall Model, RUP is more than just a theoretical process model. RUP is actually a software product that is sold by Rational Software, a division of IBM. Treating the process itself as software brings about some interesting advantages:

- The process itself can be updated and refined, just as software products periodically have updates.
- Rather than simply suggesting a development framework, RUP includes a set of software tools for working with that framework.
- As a product, RUP can be rolled out to the entire engineering team so that all members are using the exact same processes and tools.
- Like many software products, RUP can be customized to the needs of the users.

RUP as a Product

As a product, the RUP takes the form of a suite of software applications that guides developers through the software development process. The product also offers specific guidance for other Rational products, such as the Rational Rose visual modeling tool and the Rational ClearCase configuration management tool. Extensive groupware communication tools are included as part of the “marketplace of ideas” that allows developers to share knowledge.

One of the basic principles behind RUP is that each iteration on a development cycle should have a tangible result. During the Rational Unified Process, users will create numerous designs, requirement documents, reports, and plans. The RUP software provides visualization and development tools for the creation of these artifacts.

RUP as a Process

Defining an accurate model is the central principle of RUP. Models, according to RUP, help explain the complicated structures and relationships in the software development process. In RUP, models are often expressed in Unified Modeling Language (UML) format, see Appendix D.

RUP defines each part of the process as an individual *workflow* (called *discipline* in the earlier discussion of the Unified Process). Workflows represent each step of a process in terms of who is responsible for the step, what tasks are being performed, the artifacts or results of these tasks, and the sequence of events that drives the tasks. Almost everything about RUP is customizable, but several *core process workflows* are defined “out of the box” by RUP.

The core process workflows bear some resemblance to the stages of the Waterfall Model, but each one is iterative and more specific in definition. The *business modeling workflow* models business processes, usually with the goal of driving software requirements forward. The *requirements workflow* creates the requirements definition by analyzing the problems in the system and iterating on its assumptions. The *analysis and design workflow* deals with system architecture and subsystem design. The *implementation workflow* covers the modeling, coding, and integration of software subsystems. The *testing workflow* models the planning, implementation, and evaluation of software quality tests. The *deployment workflow* is a high-level view of overall planning, releasing, supporting, and testing workflows. The *configuration management workflow* goes from new project conception to iteration and end-of-product scenarios. Finally, the *environment workflow* supports the engineering organization through the creation and maintenance of development tools.

RUP in Practice

RUP is aimed mainly at larger organizations and offers several advantages over the adoption of traditional life cycle models. Once the team has gotten over the learning curve of using the software, all members will be using a common platform for designing, communicating, and implementing their ideas. The process can be customized to the needs of the team, and each stage reveals a wealth of valuable artifacts that document each phase of the development.

A product like RUP can be too heavyweight for some organizations. Teams with diverse development environments or tight engineering budgets might not want to, or be able to, standardize on a software-based development system. The learning curve can also be a factor; new engineers who aren't familiar with the process software will have to learn how to use it, while at the same time getting up to speed on the product and the existing code base.

Scrum

The Agile model is just a high-level foundation; it does not specify exactly how the model should be implemented in real life. That's where *Scrum* comes into play; it's an Agile methodology with precise descriptions of how to use it on a daily basis.

Scrum is an iterative process. It is very popular as a means to manage software development projects. In Scrum, each iteration is called a *sprint cycle*. The sprint cycle is the central part of the Scrum process. The length of sprints, which should be decided at the beginning of the project, is typically between two and four weeks. At the end of each sprint, the goal is to have a version of the software available that is fully working and tested, and which represents a subset of the customers' requirements. Scrum recognizes that customers will often change their minds during development, so it allows the result of each sprint to be shipped to the customer. This gives customers the opportunity to see iterative versions of the software, and allows them to give feedback to the development team about potential issues.

Roles

There are three roles in Scrum. The first role, *Product Owner* (PO), is the connection to the customer and to other people. The PO writes high-level *user stories* based on input from the customer, gives each user story a priority, and puts the stories in the Scrum product backlog. Actually, everyone on the team is allowed to write high-level user stories for the product backlog, but the Product Owner decides which user stories are kept and which are removed.

The second role, *Scrum Master* (SM), is responsible for keeping the process running and can be part of the team, although not the team leader, because with Scrum the team leads itself. The SM is the contact person for the team so that the rest of the team members can concentrate on their tasks. The SM ensures that the Scrum process is followed correctly by the team, for example, by organizing the Daily Scrum meetings, which are discussed later. The Scrum Master and Product Owner should be two different people.

The third and final role in the Scrum process is the *team* itself. Teams develop the software, and should be kept small, with preferably fewer than ten members.

The Process

The Scrum process enforces a daily meeting called the *Daily Scrum* or *Standup*. In this meeting, all team members stand together with the Scrum Master. According to the Scrum process, this meeting should start every day at exactly the same time and location, and should be no longer than 15 minutes. During this meeting, all team members get to answer three questions:

- What did you do since the last Daily Scrum?
- What are you planning to do after the current Daily Scrum?
- What problems are you facing in reaching your goal?

Problems faced by team members should be noted by the Scrum Master, who will try to solve them after the Daily Scrum meeting.

Before the start of each sprint cycle, there is a *Sprint Planning* meeting in which team members must decide which product features they will implement in the new sprint. This is formalized in a sprint *backlog*. The features are selected from a *product backlog* containing prioritized user stories, which are high-level requirements of new features. User stories from the product backlog are broken down into smaller tasks with an *effort estimation* and are put on the sprint backlog. Once a sprint is in

progress, the sprint backlog is frozen and cannot be changed during that sprint. The duration of the Sprint Planning meeting depends on the length of the sprints, typically, four hours Sprint Planning meeting for each two weeks of a sprint. The Sprint Planning meeting is usually split into two parts: meeting with the Product Owner and the team to discuss the priority of product backlog items, and meeting with only the team to complete the sprint backlog.

In a Scrum team you will sometimes find a physical board with three columns: *To Do*, *In Progress*, and *Done*. Every task for the sprint is written on a small piece of paper and stuck on the board in the correct column. Tasks are not assigned to people during a meeting; instead, every team member can go to the board, pick one of the To Do tasks, and move that paper to the In Progress column. When the team member is finished with that task, the paper is moved to the Done column. This method makes it easy for team members to quickly get an overview of the work that still needs to be done and what tasks are in progress or finished. Instead of a physical Scrum board, you can also use a software solution to work with a virtual Scrum board.

Sometimes, a burn-down chart is also created every day that displays the days of the sprint on the horizontal axis and the remaining development hours on the vertical axis. This gives a quick overview of the progress made and can be used to determine whether all planned tasks can be completed during the sprint.

Once a sprint cycle is finished, there are two meetings: the *Sprint Review* and the *Sprint Retrospective*. The duration of the Sprint Review meeting again depends on the length of the sprints, typically, two hours per two weeks of a sprint. During the Sprint Review meeting, the results of the sprint cycle are discussed, including what tasks were completed and what tasks were not completed, and why. The Sprint Retrospective typically takes around one-and-a-half hours for each two weeks of a sprint, and allows the team to think about how the last sprint cycle was executed. For example, the team can identify shortcomings in the process and adapt the process for the next sprint. Questions like “What went well?”, “What could be improved?”, “What do we want to start, continue, or stop doing?”, and so on, are answered. This is called *continuous improvement*, that is, after every sprint, the process is examined and improved.

A final step in the Scrum process is a *demo*. At the end of each sprint cycle, a demo should be given to show the sprint results to all interested stakeholders.

Benefits of Scrum

Scrum is resilient to unforeseen problems that come up during the development stage. When a problem pops up, it can be handled in one of the following sprints. The team is involved in every step of the project. They discuss user stories from the product backlog with the Product Owner and convert these user stories into smaller tasks for inclusion in a sprint backlog. The team autonomously assigns work to their members with the aid of the Scrum task board. This board makes it easy to quickly see which team member is working on which task. And finally, the Daily Scrum meeting ensures that everyone knows what is happening.

A huge benefit to the paying customer is the demo that follows each sprint, which demonstrates the new iterative version of the project. The customer quickly gets a sense of how the project is progressing, and can make changes to the requirements, which usually can be incorporated into a future sprint.

Drawbacks of Scrum

Some companies might find it difficult to accept that the team itself decides who is doing what. Tasks are not assigned to team members by a manager or a team leader. All members pick their own tasks from the Scrum task board.

The Scrum Master is a key person to make sure the team stays on track. It is very important that the SM trusts the team. Having too tight a control over the team members will cause the Scrum process to fail.

A possible problem with Scrum is called *feature creep*. Scrum allows new user stories to be added to the product backlog during development. There is a danger that project managers will keep adding new features to the product backlog. This problem is best solved by deciding on a final release date, or the end date of the last sprint.

Extreme Programming

When a friend of mine arrived home from work years ago and told his wife that his company had adopted some of the principles of Extreme Programming, she joked, “I hope you wear a safety harness for that.” Despite the somewhat hokey name, Extreme Programming (or XP) effectively bundles up the best of other software development guidelines, and adds some new material.

XP, popularized by Kent Beck in *eXtreme Programming eXplained* (Addison-Wesley, 1999), claims to take the best practices of good software development and turn them up a notch. For example, most programmers would agree that testing is a good thing. In XP, testing is deemed so good that you’re supposed to write the tests before you write the code.

XP in Theory

The Extreme Programming methodology is made up of 12 main guiding principles, grouped into four categories. These principles are manifested throughout all phases of the software development process, and have a direct impact on the daily tasks of engineers.

Fine-Scale Feedback

XP provides four fine-grained guidelines related to coding, planning, and testing.

Code in Pairs

XP suggests that all production code should be written by two people working side-by-side, a technique called *pair programming*. Obviously, only one person can actually be in control of the keyboard. The other person reviews the code his peer is writing, and takes a high-level approach, thinking about issues such as testing, necessary refactoring, and the overall model of the project.

As an example, if you are in charge of writing the user interface for a particular feature of your application, you might want to ask the original author of the feature to sit down with you. He can advise you about the correct use of the feature, warn you about any “gotchas” you should watch out for, and help oversee your efforts at a high level. Even if you can’t acquire the help of the original author, just grabbing another member of the team can help. The theory is that working in pairs

builds shared knowledge, ensures proper design, and puts an informal system of checks and balances in place.

Planning Game

In the Waterfall Model, planning happens once, at the beginning of the process. Under the Spiral Model, planning is the first phase of each iteration. Under XP, planning is more than just a step—it's a never-ending task. XP teams start with a rough plan that captures the major points of the product being developed. During each iteration of the process, there is a so-called *planning game* meeting. Throughout the development process, the plan is refined and modified as necessary. The theory is that conditions are constantly changing and new information is obtained all the time. There are two major parts in the planning process:

- *Release Planning* happens with the developers and the customers, and its goal is to determine which requirements need to be included in which upcoming releases.
- *Iteration Planning* happens only with the developers, and it plans the actual tasks for the developers.

Under XP, estimates for a given feature are always made by the person who will be implementing that particular feature. This helps to avoid situations where the implementer is forced to adhere to an unrealistic and artificial schedule. Initially, estimates are very rough, perhaps on the order of weeks for a feature. As the time horizon shortens, the estimates become more granular. Features are broken down into tasks taking no more than five days.

Test Constantly

According to *eXtreme Programming eXplained*, “Any program feature without an automated test simply doesn't exist.” Extreme Programming is zealous about testing. Part of your responsibility as an XP engineer is to write the unit tests that accompany your code. A unit test is generally a small piece of code that makes sure that an individual piece of functionality works. For example, individual unit tests for a file-based object store may include `testSaveObject`, `testLoadObject`, and `testDeleteObject`.

XP takes unit testing one step further by suggesting that unit tests should be written before the actual code is written. Of course, the tests won't pass because the code hasn't been written yet. In theory, if your tests are thorough, you should know when your code is done because all the tests will complete successfully. This is called *test-driven development*, *TDD*. I told you it was “extreme.”

Have a Customer on Site

Because an XP-savvy engineering group constantly refines its product plan and builds only what is currently necessary, having a customer contribute to the process is very valuable. Although it is not always possible to convince a customer to be physically present during development, the idea that there should be communication between engineering and the end user is clearly a valuable notion. In addition to assisting with the design of individual features, customers can help prioritize tasks by conveying their individual needs.

Continuous Process

XP advocates that you should continuously integrate subsystems so that mismatches between subsystems can be detected early. You should also refactor code whenever necessary, and aim to build and deploy small incremental releases.

Integrate Continuously

All programmers are familiar with the dreaded chore of integrating code. This task becomes necessary when you discover that your view of the object store is a complete mismatch with the way it was actually written. When subsystems come together, problems are exposed. XP recognizes this phenomenon and advocates integrating code into the project frequently as it is being developed.

XP suggests a specific method for integration. Two programmers (the pair that developed the code) sit down at a designated “integration station” and merge the code in together. The code is not checked in until it passes 100 percent of the tests. By having a single station, conflicts are avoided and integration is clearly defined as a step that must occur before a check-in.

A similar approach can still work on an individual level. Engineers run tests individually or in pairs before checking code into the repository. A designated machine continually runs automated tests. When the automated tests fail, the team receives an e-mail indicating the problem and listing the most recent check-ins.

Refactor When Necessary

Most programmers *refactor* their code from time to time. Refactoring is the process of redesigning existing working code to take into account new knowledge or alternate uses that have been discovered since the code was written. Refactoring is difficult to build into a traditional software engineering schedule because its results are not as tangible as implementing a new feature. Good managers, however, recognize its importance for long-term code maintainability.

The extreme way of refactoring is to recognize situations during development when refactoring is useful and to do the refactoring at that time. Instead of deciding at the start of a release which existing parts of the product need design work, XP programmers learn to recognize the signs of code that is ready to be refactored. While this practice will almost certainly result in unexpected and unscheduled tasks, restructuring the code when appropriate should make future development easier.

Build Small Releases

One of the theories of XP is that software projects grow risky and unwieldy when they try to accomplish too much at one time. Instead of massive software releases that involve core changes and several pages of release notes, XP advocates smaller releases with a timeframe closer to two months than 18 months. With such a short release cycle, only the most important features can make it into the product. This forces engineering and marketing to agree on what features are truly important.

Shared Understanding

Software is developed by a team. Any code written is not owned by individuals, but by the team as a whole. XP gives a couple of guidelines to make sure sharing the code and ideas is possible.

Share Common Coding Standards

Due to the collective ownership guideline and the practice of pair programming, coding in an extreme environment can be difficult if each engineer has their own naming and indenting conventions. XP doesn't advocate any particular style, but recommends that if you can look at a piece of code and immediately identify the author, your group probably needs a better definition of its coding standards.

For additional information on various approaches to coding style, see Chapter 3.

Share the Code

In many traditional development environments, code ownership is strongly defined and often enforced. A friend of mine once worked in an environment where the manager explicitly forbade checking in changes to code written by any other member of the team. XP takes the extreme opposite approach by declaring that the code is collectively owned by everybody.

Collective ownership is practical for a number of reasons. From a management point of view, it is less detrimental when a single engineer leaves suddenly because there are others who understand that part of the code. From an engineer's point of view, collective ownership builds a common view of how the system works. This helps with design tasks and frees the individual programmer to make any changes that will add value to the overall project.

One important note about collective ownership is that it is not necessary for every programmer to be familiar with every single line of code. It is more of a mindset that the project is a team effort, and there is no reason for any one person to hoard knowledge.

Simplify Your Designs

A mantra frequently sung by XP-savvy engineers is “avoid speculative generality.” This goes against the natural inclinations of many programmers. If you are given the task of designing a file-based object store, you may start down the path of creating the be-all, end-all solution to all file-based storage problems. Your design might quickly evolve to cover multiple languages and any type of object. XP says you should lean toward the other end of the generality continuum. Instead of making the ideal object store that will win awards and be celebrated by your peers, design the simplest possible object store that gets the job done. You should understand the current requirements and write your code to those specifications to avoid overly complex code.

It may be hard to get used to simplicity in design. Depending on the type of work you do, your code may need to exist for years and be used by other parts of the code that you haven't even dreamed of. As discussed in Chapter 6, the problem with building in functionality that *may* be useful in the future is that you don't know what those hypothetical use cases are, and there is no way to craft a good design that is purely speculative. Instead, XP says you should build something that is useful today and leave open the opportunity to modify it later.

Share a Common Metaphor

XP uses the term *metaphor* for the idea that all members of the team (including customers and managers) should share a common high-level view of the system. This does not refer to the specifics

of how objects will communicate, or the exact APIs that will be written. Rather, the metaphor is the mental model and naming model for the components of the system. Each component should be given a descriptive name, so that each member of the team can guess its functionality simply based on its name. Team members should use the metaphor to drive shared terminology when discussing the project.

Programmer Welfare

Obviously, the welfare of the developers is important. So, the final guideline of XP is a guidance on working sane hours.

Work Sane Hours

XP has a thing or two to say about the hours you've been putting in. The claim is that a well-rested programmer is a happy and productive programmer. XP advocates a workweek of approximately 40 hours and warns against putting in overtime for more than two consecutive weeks.

Of course, different people need different amounts of rest. The main idea, though, is that if you sit down to write code without a clear head, you're going to write poor code and abandon many of the XP principles.

XP in Practice

XP purists claim that the 12 tenets of Extreme Programming are so intertwined that adopting some of them without others would largely ruin the methodology. For example, pair programming is vital to testing because if you can't determine how to test a particular piece of code, your partner can help. Also, if you're tired one day and decide to skip the testing, your partner will be there to evoke feelings of guilt.

Some of the XP guidelines, however, can prove difficult to implement. To some engineers, the idea of writing tests before code is too abstract. For those engineers, it may be sufficient to *design* the tests without actually writing them until there is code to test. Many of the XP principles are rigidly defined, but if you understand the theory behind them, you may be able to find ways to adapt the guidelines to the needs of your project.

The collaborative aspects of XP can be challenging as well. Pair programming has measurable benefits, but it may be difficult for a manager to rationalize having half as many people actually writing code each day. Some members of the team may even feel uncomfortable with such close collaboration, perhaps finding it difficult to type while others are watching. Pair programming also has obvious challenges if the team is geographically spread out, or if members tend to telecommute regularly.

For some organizations, Extreme Programming may be too radical. Large, established companies with formal policies in place for engineering may be slow to adopt approaches like XP. However, even if your company is resistant to the implementation of XP, you can still improve your own productivity by understanding the theory behind it.

Software Triage

In the fatalistically named book *Death March* (Prentice Hall, 1997), Edward Yourdon describes the frequent and scary condition of software that is behind schedule, short on staff, over budget,

or poorly designed. Yourdon's theory is that when software projects get into this state, even the best modern software development methodologies will no longer apply. As you have learned in this chapter, many approaches to software development are built around formalized documents or taking a user-centered approach to design. In a project that's already in "death march" mode, there simply isn't time for these approaches.

The idea behind software triage is that when a project is already in a bad state, resources are scarce. Time is scarce, engineers are scarce, and money may be scarce. The main mental obstacle that managers and developers need to overcome when a project is way behind schedule is that it will be impossible to satisfy the original requirements in the allotted time. The task then becomes organizing remaining functionality into "must-have," "should-have," and "nice-to-have" lists.

Software triage is a daunting and delicate process. It often requires the leadership of an outside seasoned veteran of "death march" projects to make the tough decisions. For the engineer, the most important point is that in certain conditions, it may be necessary to throw familiar processes out the window (along with some existing code, unfortunately) to finish a project on time.

BUILDING YOUR OWN PROCESS AND METHODOLOGY

It's unlikely that any book or engineering theory will perfectly match the needs of your project or organization. I recommend that you learn from as many approaches as you can and design your own process. Combining concepts from different approaches may be easier than you think. For example, RUP optionally supports an XP-like approach. Here are some tips for building the software engineering process of your dreams.

Be Open to New Ideas

Some engineering techniques seem crazy at first or unlikely to work. Look at new innovations in software engineering methodologies as a way to refine your existing process. Try things out when you can. If XP sounds intriguing, but you're not sure if it will work in your organization, see if you can work it in slowly, taking a few of the principles at a time or trying it out with a smaller pilot project.

Bring New Ideas to the Table

Most likely, your engineering team is made up of people from varying backgrounds. You may have people who are veterans of startups, long-time consultants, recent graduates, and PhDs on your team. You all have a different set of experiences and your own ideas of how a software project should be run. Sometimes the best processes turn out to be a combination of the way things are typically done in these very different environments.

Recognize What Works and What Doesn't Work

At the end of a project (or better yet, during the project, as with the Sprint Retrospective of the Scrum methodology), get the team together to evaluate the process. Sometimes there's a major

problem that nobody notices until the entire team stops to think about it. Perhaps there's a problem that *everybody* knows about but nobody has discussed.

Consider what isn't working and see how those parts can be fixed. Some organizations require formal code reviews prior to any source code check-in. If code reviews are so long and boring that nobody does a good job, discuss code-reviewing techniques as a group.

Also consider what is going well and see how those parts can be extended. For example, if maintaining the feature tasks as a group-editable website is working, then maybe devote some time to making the website even better.

Don't Be a Renegade

Whether a process is mandated by your manager or custom-built by the team, it's there for a reason. If your process involves writing formal design documents, make sure you write them. If you think that the process is broken or too complex, talk to your manager about it. Don't just avoid the process—it will come back to haunt you.

SOURCE CODE CONTROL

Managing all source code is very important for any company, big or small, even for one-person projects. In a company, for example, it would be very impractical to store all the source code on the machines of individual developers that are not managed by any *Source Code Control* software. This would result in a maintenance nightmare because not everyone would always have the latest code. All source code must be managed by Source Code Control software. There are three kinds of Source Code Control software solutions.

- **Local:** These solutions store all source code files and their history locally on your machine and are not really suitable for use in a team. These are solutions from the '70s and '80s and shouldn't be used anymore. They are not discussed further.
- **Client/Server:** These solutions are split into a client component and a server component. For a personal developer, the client and server components can run on the same machine, but the separation makes it easy to move the server component to a dedicated physical server machine if the need arises.
- **Distributed:** These solutions go one step further than the client/server model. There is no central place where everything is stored. Every developer has a copy of all the files, including all the history. A peer-to-peer approach is used instead of a client/server approach. Code is synchronized between peers by exchanging patches.

The client/server solution consists of two parts. The first part is the server software, which is software running on the central server and which is responsible for keeping track of all source code files and their history. The second part is the client software. This client software should be installed on every developer's machine; this software is responsible for communicating with the server software to get the latest version of a source file, get a previous version of a source file, commit local changes back to the server, roll back changes to a previous version, and so on.

A distributed solution doesn't use a central server. The client software uses peer-to-peer protocols to synchronize with other peers by exchanging patches. Common operations such as committing changes, rolling back changes, and so on, are fast because no network access to a central server is involved. The disadvantage is that it requires more space on the client machine because it needs to store all the files, including the entire history.

Most Source Code Control systems have a special terminology, but unfortunately, not all systems use exactly the same terms. The following list explains a number of terms that are commonly used.

- **Branch:** The source code can be *branched*, which means that multiple versions can be developed side-by-side. For example, one branch can be created for every released version. On those branches, bug fixes can be implemented for those released versions, while new features are added to the main branch. Bug fixes created for released versions can also be merged back to the main branch.
- **Checkout:** This is the action of creating a local copy on the developer's machine, coming either from a central server or from peers.
- **Check in, Commit, or Merge:** A developer should make changes to the local copy of the source code. When everything works correctly on the local machine, the developer can check in/commit/merge those local changes back to the central server, or exchange patches with peers.
- **Conflict:** When multiple developers make changes to the same source file, a conflict might occur when committing that source file. The Source Code Control software often tries to automatically resolve these conflicts. If that is not possible, the client software asks the user to resolve any conflicts manually.
- **Label or Tag:** A label or tag can be attached to all files or to a specific commit at any given time. This makes it easy to jump back to the version of the source code at that time.
- **Repository:** The collection of all files managed by the Source Code Control software is called the repository. This also includes metadata about those files, such as commit comments.
- **Resolve:** When commit conflicts occur, the user has to resolve them before committing can continue.
- **Revision or Version:** A revision, or version, is a snapshot of the contents of a file at a specific point in time. Versions represent specific points that the code can be reverted to, or compared against.
- **Update or Sync:** Updating or synchronizing means that the local copy on the developer's machine is synchronized with a version on the central server or with peers. Note that this may require a merge, which may result in a conflict that needs to be resolved.
- **Working Copy:** The working copy is the local copy on the individual developer's machine.

Several Source Code Control software solutions are available. Some of them are free, and some are commercial. The following table lists a few available solutions.

	FREE/OPEN-SOURCE	COMMERCIAL
Local Only	SCCS, RCS	PVCS
Client/Server	CVS, Subversion	IBM Rational ClearCase, Microsoft Team Foundation Server, Perforce
Distributed	Git, Mercurial, Bazaar	TeamWare, BitKeeper, Plastic SCM

NOTE *The preceding list is definitely not an exhaustive one. It's just a small selection to give you an idea of what's available.*

This book does not recommend a particular software solution. Most software companies these days have a Source Code Control solution already in place, which every developer needs to adopt. If this is not the case, the company should definitely invest some time into researching the available solutions, and pick one that suits them. The bottom line is that it will be a maintenance nightmare without any Source Code Control solution in place. Even for your personal projects, you might want to investigate the available solutions. If you find one that you like, it will make your life easier. It will automatically keep track of different versions and a history of your changes. This makes it easy for you to roll back to an older version if a change didn't work out the way it was supposed to.

SUMMARY

This chapter introduced you to several models and methodologies for the software development process. There are certainly many other ways of building software, both formalized and informal. There probably isn't a single correct method for developing software except the method that works for your team. The best way to find this method is to do your own research, learn what you can from various methods, talk to your peers about their experiences, and iterate on your process. Remember, the only metric that matters when examining a process methodology is how much it helps your team to write code.

The last part of this chapter briefly touched on the concept of Source Code Control. This should be an integral part of any software company, big or small, and is even beneficial for personal projects at home. There are several Source Code Control software solutions available, so it is recommended that you try out a few, and see which one of them works for you.

25

Writing Efficient C++

WHAT'S IN THIS CHAPTER?

- What “efficiency” and “performance” mean
- What kind of language-level optimizations you can use
- Which design-level guidelines you can follow to design efficient programs
- What profiling tools are

WROX.COM DOWNLOADS FOR THIS CHAPTER

Please note that all the code examples for this chapter are available as a part of this chapter's code download on the book's website at www.wrox.com/go/proc++4e on the Download Code tab.

The efficiency of your programs is important regardless of your application domain. If your product competes with others in the marketplace, speed can be a major differentiator: given the choice between a slower and a faster program, which one would you choose? No one would buy an operating system that takes two weeks to boot up, unless it was the only option. Even if you don't intend to sell your products, they will have users. Those users will not be happy with you if they end up wasting time waiting for your programs to complete tasks.

Now that you understand the concepts of Professional C++ design and coding, and have tackled some of the more complex facilities that the language provides, you are ready to incorporate performance into your programs. Writing efficient programs involves thought at the design level, as well as details at the implementation level. Although this chapter falls late in this book, remember to consider performance from the beginning of your projects.

OVERVIEW OF PERFORMANCE AND EFFICIENCY

Before delving further into the details, it's helpful to define the terms performance and efficiency, as used in this book. The *performance* of a program can refer to several areas, such as speed, memory usage, disk access, and network use. This chapter focuses on speed performance. The term *efficiency*, when applied to programs, means running without wasted effort. An efficient program completes its tasks as quickly as possible within the given circumstances. A program can be efficient without being fast, if the application domain is inherently prohibitive to quick execution.

NOTE *An efficient, or high-performance, program runs as fast as is possible for the particular tasks.*

Note that the title of this chapter, “Writing Efficient C++,” means writing programs that run efficiently, not efficiently writing programs. That is, the time you learn to save by reading this chapter will be your users’, not your own!

Two Approaches to Efficiency

Language-level efficiency involves using the language as efficiently as possible, for example, passing objects by reference instead of by value. However, this will only get you so far. Much more important is *design-level efficiency*, which includes choosing efficient algorithms, avoiding unnecessary steps and computations, and selecting appropriate design optimizations. More often than not, optimizing existing code involves replacing a bad algorithm or data structure with a better, more efficient one.

Two Kinds of Programs

As I've noted, efficiency is important for all application domains. Additionally, there is a small subset of programs, such as system-level software, embedded systems, intensive computational applications, and real-time games, that require extremely high levels of efficiency. Most programs don't. Unless you write those types of high-performance applications, you probably don't need to worry about squeezing every ounce of speed out of your C++ code. Think of it as the difference between building normal family cars and building sports cars. Every car must be reasonably efficient, but sports cars require extremely high performance. You wouldn't want to waste your time optimizing family cars for speed when they'll never go faster than 70 miles per hour.

Is C++ an Inefficient Language?

C programmers often resist using C++ for high-performance applications. They claim that the language is inherently less efficient than C or a similar procedural language because C++ includes high-level concepts, such as exceptions and virtual methods. However, there are problems with this argument.

When discussing the efficiency of a language, you must separate the performance capabilities of the language itself from the effectiveness of its compilers at optimizing it, that is, you cannot ignore

the effect of compilers. Recall that the C or C++ code you write is not the code that the computer executes. A compiler first translates that code into machine language, applying optimizations in the process. This means that you can't simply run benchmarks of C and C++ programs and compare the results. You're really comparing the compiler optimizations of the languages, not the languages themselves. C++ compilers can optimize away many of the high-level constructs in the language to generate machine code similar to, or even better than, the machine code generated from a comparable C program. These days, much more research and development is poured into C++ compilers than into C compilers, so C++ code might actually get better optimized and might run faster than C code.

Critics, however, still maintain that some features of C++ cannot be optimized away. For example, as Chapter 10 explains, virtual methods require the existence of a vtable and an additional level of indirection at run time, possibly making them slower than regular non-virtual function calls. However, when you really think about it, this argument is unconvincing. Virtual method calls provide more than just a function call: they also give you a run-time choice of which function to call. A comparable non-virtual function call would need a conditional statement to decide which function to call. If you don't need those extra semantics, you can use a non-virtual function. A general design rule in the C++ language is that "if you don't use a feature, you don't need to pay for it." If you don't use virtual methods, you pay no performance penalty for the fact that you could use them. Thus, non-virtual function calls in C++ are identical to function calls in C in terms of performance. However, because virtual function calls have such a tiny overhead, I recommend making all your class methods, including destructors but not constructors, virtual for all your non-final classes.

Far more important, the high-level constructs of C++ enable you to write cleaner programs that are more efficient at the design level, are more readable, more easily maintained, and avoid accumulating unnecessary and dead code.

I believe that you will be better served in your development, performance, and maintenance by choosing C++ instead of a procedural language such as C.

There are also other higher-level object-oriented languages such as C# and Java, both of which run on top of a virtual machine. C++ code is executed directly by a CPU; there is no such thing as a virtual machine to run your code. C++ is closer to the hardware, which means that in most cases it runs faster than languages such as C# and Java.

LANGUAGE-LEVEL EFFICIENCY

Many books, articles, and programmers spend a lot of time trying to convince you to apply language-level optimizations to your code. These tips and tricks are important, and can speed up your programs in some cases. However, they are far less important than the overall design and algorithm choices in your program. You can pass-by-reference all you want, but it won't make your program fast if you perform twice as many disk writes as you need to. It's easy to get bogged down in references and pointers and forget about the big picture.

Furthermore, some of these language-level tricks can be performed automatically by good optimizing compilers. You should never spend time optimizing a particular area, unless a profiler, discussed later in this chapter, tells you that that particular area is a bottleneck.

That being said, using certain language-level optimizations, such as pass-by-reference, is just considered good coding style.

In this book, I've tried to present a balance of strategies. So, I've included here what I feel are the most useful language-level optimizations. This list is not comprehensive, but is a good start to write optimized code. However, make sure to read, and practice, the design-level efficiency advice that I offer later in this chapter as well.

WARNING *Apply language-level optimizations judiciously. I recommend making a clean, well-structured design and implementation first. Then use a profiler, and only invest time optimizing those parts that are flagged by a profiler as being a performance bottleneck.*

Handle Objects Efficiently

C++ does a lot of work for you behind the scenes, particularly with regard to objects. You should always be aware of the performance impact of the code you write. If you follow a few simple guidelines, your code will become more efficient. Note that these guidelines are only relevant for objects, and not for primitive types such as `bool`, `int`, `float`, and so on.

Pass-by-Reference

The pass-by-reference rule is discussed elsewhere in this book, but it's worth repeating here.

WARNING *Objects should rarely be passed by value to a function or method.*

When you pass an object of a derived class by value as argument for a function parameter with as type one of the base classes, then the derived object is sliced to fit into the base class type. This causes information to be lost, see Chapter 10 for details.

Pass-by-value also incurs copying costs that are avoided with pass-by-reference. One reason why this rule can be difficult to remember is that on the surface there doesn't appear to be any problem when you pass-by-value. Consider a class to represent a person that looks like this:

```
class Person
{
public:
    Person() = default;
    Person(std::string_view firstName, std::string_view lastName, int age);
    virtual ~Person() = default;

    std::string_view getFirstName() const { return mFirstName; }
    std::string_view getLastName() const { return mLastName; }
    int getAge() const { return mAge; }
```

```

private:
    std::string mFirstName, mLastName;
    int mAge = 0;
};

```

You could write a function that takes a `Person` object as follows:

```

void processPerson(Person p)
{
    // Process the person.
}

```

You can call this function like this:

```

Person me("Marc", "Gregoire", 38);
processPerson(me);

```

This doesn't look like there's any more code than if you write the function like this instead:

```

void processPerson(const Person& p)
{
    // Process the person.
}

```

The call to the function remains the same. However, consider what happens when you pass-by-value in the first version of the function. In order to initialize the `p` parameter of `processPerson()`, `me` must be copied with a call to its copy constructor. Even though you didn't write a copy constructor for the `Person` class, the compiler generates one that copies each of the data members. That still doesn't look so bad: there are only three data members. However, two of them are `strings`, which are themselves objects with copy constructors. So, each of their copy constructors will be called as well. The version of `processPerson()` that takes `p` by reference incurs no such copying costs. Thus, pass-by-reference in this example avoids three copy constructor calls when the code enters the function.

And you're still not done. Remember that `p` in the first version of `processPerson()` is a local variable to the `processPerson()` function, and so must be destroyed when the function exits. This destruction requires a call to the `Person` destructor, which will call the destructor of all of the data members. `strings` have destructors, so exiting this function (if you passed by value) incurs calls to three destructors. None of those calls are needed if the `Person` object is passed by reference.

NOTE *If a function must modify an object, you can pass the object by reference. If the function should not modify the object, you can pass it by const reference, as in the preceding example. See Chapter 11 for details on references and const.*

NOTE *Avoid using pass-by-pointer, which is a relatively obsolete method for pass-by-reference. It is a throwback to the C language, and thus rarely suitable for C++ (unless passing `nullptr` has meaning in your design).*

Return-by-Reference

Just as you should pass objects by reference to functions, you should also return them by reference from functions in order to avoid copying the objects unnecessarily. Unfortunately, it is sometimes impossible to return objects by reference, such as when you write overloaded `operator+` and other similar operators. And, you should never return a reference or a pointer to a local object that will be destroyed when the function exits!

Since C++11, the language has support for move semantics, which allows you to efficiently return objects by value, instead of using reference semantics.

Catch Exceptions by Reference

As noted in Chapter 14, you should catch exceptions by reference in order to avoid slicing and unnecessary copying. Throwing exceptions is heavy in terms of performance, so any little thing you can do to improve their efficiency will help.

Use Move Semantics

You should make sure your classes have a move constructor and move assignment operator to allow the C++ compiler to use move semantics with objects of those classes. According to the rule of zero (see Chapter 9), you should try to design your classes such that the compiler generated copy and move constructors and copy and move assignment operators are sufficient. If the compiler cannot implicitly define these for a class, try to explicitly default them if that works for your class. If that is also not an option, you should implement them yourself. With move semantics for your objects, returning them by value from a function will be efficient without incurring large copying costs. Consult Chapter 9 for details on move semantics.

Avoid Creating Temporary Objects

The compiler creates temporary, unnamed objects in several circumstances. Chapter 9 explains that after writing a global `operator+` for a class, you can add objects of that class to other types, as long as those types can be converted to objects of that class. For example, the `SpreadsheetCell` class definition looks in part like this:

```
class SpreadsheetCell
{
public:
    // Other constructors omitted for brevity
    SpreadsheetCell(double initialValue);
    // Remainder omitted for brevity
};

SpreadsheetCell operator+(const SpreadsheetCell& lhs,
    const SpreadsheetCell& rhs);
```

The constructor that takes a `double` allows you to write code like this:

```
SpreadsheetCell myCell(4), aThirdCell;
aThirdCell = myCell + 5.6;
aThirdCell = myCell + 4;
```

The second line constructs a temporary `SpreadsheetCell` object from the `5.6` argument; it then calls the `operator+` with `myCell` and this temporary object as arguments. The result is stored in `aThirdCell`. The third line does the same thing, except that `4` must be coerced to a `double` in order to call the `double` constructor of the `SpreadsheetCell`.

The important point in this example is that the compiler generates code to create an extra, unnamed `SpreadsheetCell` object for both addition operations in this example. That object must be constructed and destructed with calls to its constructor and destructor. If you're still skeptical, try inserting `cout` statements in your constructor and destructor, and watch the printout.

In general, the compiler constructs a temporary object whenever your code converts a variable of one type to another type for use in a larger expression. This rule applies mostly to function calls. For example, suppose that you write a function with the following prototype:

```
void doSomething(const SpreadsheetCell& s);
```

You can call this function like this:

```
doSomething(5.56);
```

The compiler constructs a temporary `SpreadsheetCell` object from `5.56` using the `double` constructor. This temporary object is then passed to `doSomething()`. Note that if you remove the `const` from the `s` parameter, you can no longer call `doSomething()` with a constant; you must pass a variable.

You should generally attempt to avoid cases in which the compiler is forced to construct temporary objects. Although it is impossible to avoid in some situations, you should at least be aware of the existence of this “feature” so you aren't surprised by performance and profiling results.

Move semantics is used by the compiler to make working with temporary objects more efficient. That's another reason to make sure your classes support move semantics. See Chapter 9 for details.

The Return-Value Optimization

A function that returns an object by value can cause the creation of a temporary object. Continuing with the `Person` example from earlier, consider this function:

```
Person createPerson()
{
    Person newP("Marc", "Gregoire", 38);
    return newP;
}
```

Suppose that you call it like this (assuming that `operator<<` is implemented for the `Person` class):

```
cout << createPerson();
```

Even though this call does not store the result of `createPerson()` anywhere, the result must be stored somewhere in order to pass it to `operator<<`. In order to generate code for this behavior, the compiler is allowed to create a temporary variable in which to store the `Person` object returned from `createPerson()`.

Even if the result of the function is not used anywhere, the compiler might still generate code to create the temporary object. For example, suppose that you have this code:

```
createPerson();
```

The compiler might generate code to create a temporary object for the return value, even though it is not used.

However, you usually don't need to worry about this issue because in most cases, the compiler optimizes away the temporary variable to avoid all copying and moving. For the `createPerson()` example, this optimization is called *named return value optimization* (NRVO) because the return statement returns a named variable. In the case the return statement has as argument a nameless temporary value, then this optimization is called *return value optimization* (RVO). These kinds of optimizations are usually only enabled for release builds. For NRVO to work, the argument to the return statement must be a single local variable. For example, in the following case, the compiler cannot do NRVO:

```
Person createPerson()
{
    Person person1;
    Person person2;
    return getRandomBool() ? person1 : person2;
}
```

If NRVO and RVO are not applicable, then copying or moving will happen. If the object you want to return from a function supports move semantics, then it is moved out of the function instead of copied.

Pre-allocate Memory

One of the main advantages of using containers such as those from the C++ Standard Library is that they handle all memory management for you. The containers grow automatically when you add more elements to them. However, sometimes this causes a performance penalty. For example, an `std::vector` container stores its elements contiguously in memory. If it needs to grow in size, it needs to allocate a new block of memory, and then move (or copy) all elements to this new memory. This has serious performance implications, for example, if you use `push_back()` in a loop to add millions of elements to a `vector`.

If you know in advance how many elements you are going to add to a `vector`, or if you have a rough estimate, you should pre-allocate enough memory before starting to add your elements. A `vector` has a capacity, that is, the number of elements that can be added without reallocation, and a size, that is, the actual number of elements in the container. You can pre-allocate memory by changing the capacity using the `reserve()` method, or by resizing the `vector` using `resize()`. See Chapter 17 for details.

Use Inline Methods and Functions

As described in Chapter 9, the code for an `inline` method or function is inserted directly into the code where it is called, avoiding the overhead of a function call. You should mark as `inline` all functions and methods that you think can qualify for this optimization. However, do not overuse

this feature, because it basically throws away a fundamental design principle, which states that the interface and the implementation should be separated, such that the implementation can evolve without any changes to the interface. Consider using this feature only for often-used, fundamental classes. Also, remember that inlining requests by the programmer are only a recommendation to the compiler, which is allowed to refuse them.

On the other hand, some compilers inline appropriate functions and methods during their optimization steps, even if those functions aren't marked with the `inline` keyword, and even if those functions are implemented in a source file instead of a header file. Thus, you should read your compiler documentation before wasting a lot of effort deciding which functions to inline.

DESIGN-LEVEL EFFICIENCY

The design choices in your program affect its performance far more than do language details such as pass-by-reference. For example, if you choose an algorithm for a fundamental task in your application that runs in $O(n^2)$ time instead of a simpler one that runs in $O(n)$ time, you could potentially perform the square of the number of operations that you really need. To put numbers on that, a task that uses an $O(n^2)$ algorithm and performs one million operations would perform only one thousand with an $O(n)$ algorithm. Even if that operation is optimized beyond recognition at the language level, the simple fact that you perform one million operations when a better algorithm would use only one thousand will make your program very inefficient. Always choose your algorithms carefully. Refer to Part II, specifically Chapter 4, of this book for a detailed discussion of algorithm design choices and big-O notation.

In addition to your choice of algorithms, design-level efficiency includes specific tips and tricks. Instead of writing your own data structures and algorithms, you should use existing ones, such as those from the C++ Standard Library, the Boost libraries, or other libraries, as much as possible because they are written by experts. These libraries have been, and are being, used a lot, so you can expect most bugs to have been discovered and fixed. You should also think about incorporating multithreading in your design to take full advantage of all processing power available on the machine. See Chapter 23 for more details. The remainder of this section presents two more design techniques for optimizing your program: caching and using object pools.

Cache Where Necessary

Caching means storing items for future use in order to avoid retrieving or recalculating them. You might be familiar with the principle from its use in computer hardware. Modern computer processors are built with memory caches that store recently and frequently accessed memory values in a location that is quicker to access than main memory. Most memory locations that are accessed at all are accessed more than once in a short time period, so caching at the hardware level can significantly speed up computations.

Caching in software follows the same approach. If a task or computation is particularly slow, you should make sure that you are not performing it more than necessary. Store the results in memory the first time you perform the task so that they are available for future needs. Here is a list of tasks that are usually slow.

- **Disk access:** You should avoid opening and reading the same file more than once in your program. If memory is available, save the file contents in RAM if you need to access it frequently.
- **Network communication:** Whenever you need to communicate over a network, your program is subject to the vagaries of the network load. Treat network accesses like file accesses, and cache as much static information as possible.
- **Mathematical computations:** If you need the result of a very complex computation in more than one place, perform the calculation once and share the result. However, if it's not very complex, then it's probably faster to just calculate it instead of retrieving it from a cache. Use a profiler to be sure.
- **Object allocation:** If you need to create and use a large number of short-lived objects in your program, consider using an object pool, described later in this chapter.
- **Thread creation:** Creating threads is slow. You can “cache” threads in a thread-pool, similar to caching objects in an object-pool.

One common problem with caching is that the data you store often comprises only copies of the underlying information. The original data might change during the lifetime of the cache. For example, you might want to cache the values in a configuration file so that you don't need to read it repeatedly. However, the user might be allowed to change the configuration file while your program is running, which would make your cached version of the information obsolete. In cases like this, you need a mechanism for *cache invalidation*: when the underlying data changes, you must either stop using your cached information or repopulate your cache.

One technique for cache invalidation is to request that the entity managing the underlying data notifies your program of the data change. It could do this through a *callback* that your program registers with the manager. Alternatively, your program could poll for certain events that would trigger it to repopulate the cache automatically. Regardless of your specific cache invalidation technique, make sure that you think about these issues before relying on a cache in your program.

NOTE *Always keep in mind that maintaining caches takes code, memory, and processing time. On top of that, caches can be a source of subtle bugs. You should only add caching to a particular area when a profiler clearly shows that that area is a performance bottleneck. First write clean and correct code, then profile it, and only then optimize parts of it.*

Use Object Pools

There are different kinds of object pools. One kind of object pool is where it allocates a large chunk of memory at once, in which the object pool creates smaller objects in-place. These objects can be handed out to clients, and reused when the clients are done with them, without incurring any additional calls to the memory manager to allocate or deallocate memory for individual objects.

This section describes another kind of object pool. If your program needs a large number of short-lived objects of the same type that have an expensive constructor (for example, a constructor creating a large, pre-sized vector for storing data), and a profiler confirms that allocating and deallocating these objects is a bottleneck, then you can create a *pool*, or cache, of those objects. Whenever you need an object in your code, you ask the pool for one. When you are done with the object, you return it to the pool. The object pool creates the objects only once, so their constructor is called only once, not each time they are used. Thus, object pools are appropriate when the constructor performs some setup actions that apply to many uses of the object, and when you can set instance-specific parameters on the object through non-constructor method calls.

An Object Pool Implementation

This section provides an implementation of an object pool class template that you can use in your programs. The pool hands out objects via the `acquireObject()` method. If `acquireObject()` is called but there are no free objects, then the pool allocates another instance of the object. `acquireObject()` returns an `Object` that is an `std::shared_ptr` with a custom deleter. The custom deleter doesn't actually delete the memory; it simply puts the object back on the list of free objects.

The most difficult aspect of an object pool implementation is keeping track of which objects are free and which are in use. This implementation takes the approach of storing free objects in a queue. Each time a client requests an object, the pool gives that client the top object from the queue. The code uses the `std::queue` class from the Standard Library, as discussed in Chapter 17. Because this standard data structure is used, this implementation is not thread safe. One way to make it thread safe is to use a lock-free concurrent queue. However, the Standard Library does not provide any concurrent data structures, so you'll have to use third-party libraries.

Here is the class definition, with comments that explain the details. The class template is parameterized on the class type from which the objects in the pool are to be constructed.

```
#include <queue>
#include <memory>

// Provides an object pool that can be used with any class that provides a
// default constructor.
//
// acquireObject() returns an object from the list of free objects. If
// there are no more free objects, acquireObject() creates a new instance.
// The pool only grows: objects are never removed from the pool (freed),
// until the pool is destroyed.
// acquireObject() returns an Object which is an std::shared_ptr with a
// custom deleter that automatically puts the object back into the object
// pool when the shared_ptr is destroyed and its reference reaches 0.
//
// The constructor and destructor on each object in the pool will be called
// only once each for the lifetime of the object pool, not once per
// acquisition and release.
//
// The primary use of an object pool is to avoid creating and deleting
// objects repeatedly. This object pool is most suited to applications that
```

```

// use large numbers of objects with expensive constructors for short
// periods of time, and if a profiler tells you that allocating and
// deallocating these objects is a bottleneck.
template <typename T>
class ObjectPool
{
public:
    ObjectPool() = default;
    virtual ~ObjectPool() = default;

    // Prevent assignment and pass-by-value
    ObjectPool(const ObjectPool<T>& src) = delete;
    ObjectPool<T>& operator=(const ObjectPool<T>& rhs) = delete;

    // The type of smart pointer returned by acquireObject().
    using Object = std::shared_ptr<T>;

    // Reserves and returns an object for use.
    Object acquireObject();
private:
    // Stores the objects that are not currently in use by clients.
    std::queue<std::unique_ptr<T>> mFreeList;
};

```

When using this object pool, you have to make sure that the object pool itself outlives all the objects handed out by the pool. A user of the object pool specifies through the template parameter the name of the class from which objects can be created.

`acquireObject()` returns the top object from the free list, first allocating a new object if there are no free objects:

```

template <typename T>
typename ObjectPool<T>::Object ObjectPool<T>::acquireObject()
{
    if (mFreeList.empty()) {
        mFreeList.emplace(std::make_unique<T>());
    }

    // Move next free object from the queue to a local unique_ptr.
    std::unique_ptr<T> obj(std::move(mFreeList.front()));
    mFreeList.pop();

    // Convert the object pointer to an Object (a shared_ptr with
    // a custom deleter).
    Object smartObject(obj.release(), [this](T* t){
        // The custom deleter doesn't actually deallocate the
        // memory, but simply puts the object back on the free list.
        mFreeList.emplace(t);
    });

    // Return the Object.
    return smartObject;
}

```

Using the Object Pool

Consider an application that uses a lot of short-lived objects with an expensive constructor. Let's assume the `ExpensiveObject` class definition looks as follows:

```
class ExpensiveObject
{
public:
    ExpensiveObject() { /* Expensive construction ... */ }
    virtual ~ExpensiveObject() = default;
    // Methods to populate the object with specific information.
    // Methods to retrieve the object data.
    // (not shown)
private:
    // Data members (not shown)
};
```

Instead of creating and deleting large numbers of such objects throughout the lifetime of your program, you can use the object pool developed in the previous section. Your program structure could be something like this:

```
ObjectPool<ExpensiveObject>::Object
getExpensiveObject(ObjectPool<ExpensiveObject>& pool)
{
    // Obtain an ExpensiveObject object from the pool.
    auto object = pool.acquireObject();

    // Populate the object. (not shown)

    return object;
}

void processExpensiveObject(ObjectPool<ExpensiveObject>::Object& object)
{
    // Process the object. (not shown)
}

int main()
{
    ObjectPool<ExpensiveObject> requestPool;

    {
        vector<ObjectPool<ExpensiveObject>::Object> objects;
        for (size_t i = 0; i < 10; ++i) {
            objects.push_back(getExpensiveObject(requestPool));
        }
    }

    for (size_t i = 0; i < 100; ++i) {
        auto req = getExpensiveObject(requestPool);
        processExpensiveObject(req);
    }
    return 0;
}
```

The first part of this `main()` function contains an inner code block which creates ten expensive objects and stores them in the `objects` container. Because all created `Objects` are stored in a vector and thus kept alive, the object pool is forced to create ten `ExpensiveObject` instances. At the closing brace of the inner code block, the vector goes out of scope, and all `Objects` contained in it are automatically released back to the object pool.

In the second `for` loop, the `Objects (= shared_ptrs)` returned by `getExpensiveObject()` go out of scope at the end of each iteration of the `for` loop, and so are automatically released back to the pool. If you add an output statement to the constructor of the `ExpensiveObject` class, you'll see that the constructor is only called ten times during the entire program, even though the second `for` loop in `main()` loops a hundred times.

PROFILING

It is good to think about efficiency as you design and code. There is no point in writing obviously inefficient programs if this can be avoided with some common sense, or experience-based intuition. However, I urge you not to get too obsessed with performance during the design and coding phases. It's best to first make a clean, well-structured design and implementation, then use a profiler, and only optimize parts that are flagged by the profiler as being performance bottlenecks. Remember the "90/10" rule, introduced in Chapter 4, which states that 90 percent of the running time of most programs is spent in only 10 percent of the code (Hennessy and Patterson, *Computer Architecture, A Quantitative Approach, Fourth Edition*, [Morgan Kaufmann, 2006]). This means that you could optimize 90 percent of your code, but still only improve the running time of the program by 10 percent. Obviously, you want to optimize the parts of the code that are exercised the most for the specific workload that you expect the program to run.

Consequently, it is often helpful to *profile* your program to determine which parts of the code require optimization. There are many *profiling tools* available that analyze programs as they run in order to generate data about their performance. Most profiling tools provide analysis at the function level by specifying the amount of time (or percent of total execution time) spent in each function in the program. After running a profiler on your program, you can usually tell immediately which parts of the program need optimization. Profiling before and after optimizing is essential to prove that your optimizations had an effect.

If you are using Microsoft Visual C++ 2017, you already have a great built-in profiler, which is discussed later in this chapter. If you are not using Visual C++, Microsoft has a Community edition available which is free of charge for students, open-source developers, and individual developers to create both free and paid applications. It's also free of charge for up to five users in small organizations. Another great profiling tool is Rational PurifyPlus from IBM. There are also a number of smaller free profiling tools available: Very Sleepy and Luke Stackwalker are popular profilers for Windows, Valgrind and gprof (GNU profiler) are well-known profilers for Unix/Linux systems, and there are plenty of other choices.

Profiling Example with gprof

The power of profiling can best be seen with a real coding example. As a disclaimer, the performance bugs in the first implementation shown are not subtle! Real efficiency issues would probably be more complex, but a program long enough to demonstrate them would be too lengthy for this book.

Suppose that you work for the United States Social Security Administration. Every year the administration puts up a website that allows users to look up the popularity of new baby names from the previous year. Your job is to write the back-end program that looks up names for users. Your input is a file containing the name of every new baby. This file will obviously contain redundant names. For example, in the file for boys for 2003, the name Jacob was the most popular, showing up 29,195 times. Your program must read the file to construct an in-memory database. A user may then request the absolute number of babies with a given name, or the rank of that name among all the babies.

First Design Attempt

A logical design for this program consists of a `NameDB` class with the following public methods:

```
#include <string_view>

class NameDB
{
    public:
        // Reads list of baby names in nameFile to populate the database.
        // Throws invalid_argument if nameFile cannot be opened or read.
        NameDB(std::string_view nameFile);

        // Returns the rank of the name (1st, 2nd, etc).
        // Returns -1 if the name is not found.
        int getNameRank(std::string_view name) const;

        // Returns the number of babies with this name.
        // Returns -1 if the name is not found.
        int getAbsoluteNumber(std::string_view name) const;

        // Protected and private members and methods not shown
};
```

The hard part is choosing a good data structure for the in-memory database. My first attempt is a vector of name/count pairs. Each entry in the vector stores one of the names, along with a count of the number of times that name shows up in the raw data file. Here is the complete class definition with this design:

```
#include <string_view>
#include <string>
#include <vector>
#include <utility>

class NameDB
{
```

```

public:
    NameDB(std::string_view nameFile);
    int getNameRank(std::string_view name) const;
    int getAbsoluteNumber(std::string_view name) const;
private:
    std::vector<std::pair<std::string, int>> mNames;

    // Helper methods
    bool nameExists(std::string_view name) const;
    void incrementNameCount(std::string_view name);
    void addNewName(std::string_view name);
};

```

Note the use of the Standard Library vector and pair classes, both of which are discussed in Chapter 17. A pair is a utility class that combines two values of possibly different types.

Here are the implementations of the constructor and the helper methods nameExists(), incrementNameCount(), and addNewName(). The loops in nameExists() and incrementNameCount() iterate over all the elements of the vector.

```

// Reads the names from the file and populates the database.
// The database is a vector of name/count pairs, storing the
// number of times each name shows up in the raw data.
NameDB::NameDB(string_view nameFile)
{
    // Open the file and check for errors.
    ifstream inputFile(nameFile.data());
    if (!inputFile) {
        throw invalid_argument("Unable to open file");
    }

    // Read the names one at a time.
    string name;
    while (inputFile >> name) {
        // Look up the name in the database so far.
        if (nameExists(name)) {
            // If the name exists in the database, just increment the count.
            incrementNameCount(name);
        } else {
            // If the name doesn't yet exist, add it with a count of 1.
            addNewName(name);
        }
    }
}

// Returns true if the name exists in the database, false otherwise.
bool NameDB::nameExists(string_view name) const
{
    // Iterate through the vector of names looking for the name.
    for (auto& entry : mNames) {
        if (entry.first == name) {
            return true;
        }
    }
    return false;
}

```

```

// Precondition: name exists in the vector of names.
// Postcondition: the count associated with name is incremented.
void NameDB::incrementNameCount(string_view name)
{
    for (auto& entry : mName) {
        if (entry.first == name) {
            entry.second++;
            return;
        }
    }
}

// Adds a new name to the database.
void NameDB::addNewName(string_view name)
{
    mName.push_back(make_pair(name.data(), 1));
}

```

Note that in the preceding example, you could use an algorithm like `find_if()` to accomplish the same thing as the loops in `nameExists()` and `incrementNameCount()`. The loops are shown explicitly in order to emphasize the performance problems.

You might have noticed some performance problems already. What if there are hundreds of thousands of names? The many linear searches involved in populating the database will become slow.

In order to complete the example, here are the implementations of the two public methods:

```

// Returns the rank of the name.
// First looks up the name to obtain the number of babies with that name.
// Then iterates through all the names, counting all the names with a higher
// count than the specified name. Returns that count as the rank.
int NameDB::getNameRank(string_view name) const
{
    // Make use of the getAbsoluteNumber() method.
    int num = getAbsoluteNumber(name);

    // Check if we found the name.
    if (num == -1) {
        return -1;
    }

    // Now count all the names in the vector that have a
    // count higher than this one. If no name has a higher count,
    // this name is rank number 1. Every name with a higher count
    // decreases the rank of this name by 1.
    int rank = 1;
    for (auto& entry : mName) {
        if (entry.second > num) {
            rank++;
        }
    }
    return rank;
}

```

```
// Returns the count associated with this name.
int NameDB::getAbsoluteNumber(string_view name) const
{
    for (auto& entry : mName) {
        if (entry.first == name) {
            return entry.second;
        }
    }
    return -1;
}
```

Profiling the First Design Attempt

In order to test the program, you need a `main()` function:

```
#include "NameDB.h"
#include <iostream>
using namespace std;

int main()
{
    NameDB boys("boys_long.txt");
    cout << boys.getNameRank("Daniel") << endl;
    cout << boys.getNameRank("Jacob") << endl;
    cout << boys.getNameRank("William") << endl;
    return 0;
}
```

This `main()` function creates one `NameDB` database called `boys`, telling it to populate itself with the file `boys_long.txt`, which contains 500,500 names.

There are three steps to using `gprof`:

1. Compile your program with a special flag that causes it to log raw execution information when it is run. When using GCC as your compiler, the flag is `-pg`, as in this example:

```
> gcc -lstdc++ -std=c++17 -pg -o namedb NameDB.cpp NameDBTest.cpp
```

2. Run your program. This should generate a file called `gmon.out` in the working directory. Be patient when you run the program because this first version is slow.
3. Run the `gprof` command. This final step enables you to analyze the `gmon.out` profiling information and produce a (somewhat) readable report. `gprof` outputs to standard out, so you should redirect the output to a file:

```
> gprof namedb gmon.out > gprof_analysis.out
```

Now you can analyze the data. Unfortunately, the output file is somewhat cryptic and intimidating, so it takes a little while to learn how to interpret it. `gprof` provides two separate sets of information. The first set summarizes the amount of time spent executing each function in the program. The second and more useful set summarizes the amount of time spent executing each function *and its descendants*; this set is also called a *call graph*. Here is some of the output from the `gprof_analysis.out` file, edited to make it more readable. Note that the numbers will be different on your machine.

index	%time	self	children	called	name
[1]	100.0	0.00	14.06		main [1]
		0.00	14.00	1/1	NameDB::NameDB [2]
		0.00	0.04	3/3	NameDB::getNameRank [25]
		0.00	0.01	1/1	NameDB::~NameDB [28]

The following list explains the different columns.

- `index`: an index to be able to refer to this entry in the call graph.
- `%time`: the percentage of the total execution time of the program required by this function and its descendants.
- `self`: how many seconds the function itself was executing.
- `children`: how many seconds the descendants of this function were executing.
- `called`: how often this function was called.
- `name`: the name of the function. If the name of the function is followed by a number between square brackets, that number refers to another index in the call graph.

The preceding extract tells you that `main()` and its descendants took 100 percent of the total execution time of the program, for a total of 14.06 seconds. The second line shows that the `NameDB` constructor took 14.00 seconds of the total 14.06 seconds. So, it's immediately clear where the performance issue is situated. To track down which part of the constructor is taking so long, you need to jump to the call graph entry with index 2, because that's the index in square brackets behind the name in the last column. The call graph entry with index 2 is as follows on my test system:

[2]	99.6	0.00	14.00	1	NameDB::NameDB [2]
		1.20	6.14	500500/500500	NameDB::nameExists [3]
		1.24	5.24	499500/499500	NameDB::incrementNameCount [4]
		0.00	0.18	1000/1000	NameDB::addNewName [19]
		0.00	0.00	1/1	vector::vector [69]

The nested entries below `NameDB::NameDB` show which of its descendants took the most time. Here you can see that `nameExists()` took 6.14 seconds, and `incrementNameCount()` took 5.24 seconds. These times are the sums of all the calls to the functions. The fourth column in those lines shows the number of calls to the function (500,500 to `nameExists()` and 499,500 to `incrementNameCount()`). No other function took a significant amount of time.

Without going any further in this analysis, two things should jump out at you:

1. Taking 14 seconds to populate the database of approximately 500,000 names is slow. Perhaps you need a better data structure.
2. `nameExists()` and `incrementNameCount()` take an almost identical amount of time, and are called almost the same number of times. If you think about the application domain, that makes sense: most names in the input text file are duplicates, so the vast majority of the calls to `nameExists()` are followed by a call to `incrementNameCount()`. If you look back at the code, you can see that these functions are almost identical; they could probably be combined. In addition, most of what they are doing is searching the `vector`. It would probably be better to use a sorted data structure to reduce the searching time.

Second Design Attempt

With these two observations from the gprof output, it's time to redesign the program. The new design uses a map instead of a vector. Chapter 17 explains that the Standard Library map keeps the entries sorted, and provides $O(\log n)$ lookup instead of the $O(n)$ searches in a vector. A good exercise for you to try would be to use `std::unordered_map`, which has an expected $O(1)$ for lookups, and to use a profiler to see if that is faster than `std::map` for this application.

The new version of the program also combines `nameExists()` and `incrementNameCount()` into one `nameExistsAndIncrement()` method.

Here is the new class definition:

```
#include <string_view>
#include <string>
#include <map>

class NameDB
{
public:
    NameDB(std::string_view nameFile);
    int getNameRank(std::string_view name) const;
    int getAbsoluteNumber(std::string_view name) const;
private:
    std::map<std::string, int> mNames;
    bool nameExistsAndIncrement(std::string_view name);
    void addNewName(std::string_view name);
};
```

Here are the new method implementations:

```
// Reads the names from the file and populates the database.
// The database is a map associating names with their frequency.
NameDB::NameDB(string_view nameFile)
{
    // Open the file and check for errors.
    ifstream inputFile(nameFile.data());
    if (!inputFile) {
        throw invalid_argument("Unable to open file");
    }

    // Read the names one at a time.
    string name;
    while (inputFile >> name) {
        // Look up the name in the database so far.
        if (!nameExistsAndIncrement(name)) {
            // If the name exists in the database, the
            // method incremented it, so we just continue.
            // We get here if it didn't exist, in which case
            // we add it with a count of 1.
            addNewName(name);
        }
    }
}
```

```

// Returns true if the name exists in the database, false
// otherwise. If it finds it, it increments it.
bool NameDB::nameExistsAndIncrement(string_view name)
{
    // Find the name in the map.
    auto res = mNameMap.find(name.data());
    if (res != end(mNameMap)) {
        res->second++;
        return true;
    }
    return false;
}

// Adds a new name to the database.
void NameDB::addNewName(string_view name)
{
    mNameMap[name.data()] = 1;
}

int NameDB::getNameRank(string_view name) const
{
    // Implementation omitted, same as before.
}

// Returns the count associated with this name.
int NameDB::getAbsoluteNumber(string_view name) const
{
    auto res = mNameMap.find(name.data());
    if (res != end(mNameMap)) {
        return res->second;
    }
    return -1;
}

```

Profiling the Second Design Attempt

By following the same steps shown earlier, you can obtain the gprof performance data on the new version of the program. The data is quite encouraging:

index	%time	self	children	called	name
[1]	100.0	0.00	0.21		main [1]
		0.02	0.18	1/1	NameDB::NameDB [2]
		0.00	0.01	1/1	NameDB::~NameDB [13]
		0.00	0.00	3/3	NameDB::getNameRank [28]
[2]	95.2	0.02	0.18	1	NameDB::NameDB [2]
		0.02	0.16	500500/500500	NameDB::nameExistsAndIncrement
[3]		0.00	0.00	1000/1000	NameDB::addNewName [24]
		0.00	0.00	1/1	map::map [87]

If you run this on your machine, the output will be different. It's even possible that you will not see the data for NameDB methods in your output. Because of the efficiency of this second attempt, the timings are getting so small that you might see more map methods in the output than NameDB methods.

On my test system, `main()` now takes only 0.21 seconds—a 67-fold improvement! There are certainly further improvements that you could make on this program. For example, the current constructor performs a lookup to see if the name is already in the `map`, and if not, adds it to the `map`. You could combine these two operations simply with the following single line:

```
++mNames [name];
```

If the name is already in the `map`, this statement just increments its counter. If the name is not yet in the `map`, this statement first adds an entry to the `map` with the given name as key and a zero-initialized value, and then increments the value, resulting in a counter of 1.

With this improvement, you can remove the `nameExistsAndIncrement()` and `addNewName()` methods, and change the constructor as follows:

```
NameDB::NameDB(string_view nameFile)
{
    // Open the file and check for errors
    ifstream inputFile(nameFile.data());
    if (!inputFile) {
        throw invalid_argument("Unable to open file");
    }

    // Read the names one at a time.
    string name;
    while (inputFile >> name) {
        ++mNames [name];
    }
}
```

`getNameRank()` still uses a loop that iterates over all elements in the `map`. A good exercise for you to try is to come up with another data structure so that the linear iteration in `getNameRank()` can be avoided.

Profiling Example with Visual C++ 2017

Most editions of Microsoft Visual C++ 2017 come with a great built-in profiler, which is briefly discussed in this section. The VC++ profiler has a complete graphical user interface. This book does not recommend one profiler over another, but it is always good to have an idea of what a command line–based profiler like `gprof` can provide in comparison with a GUI-based profiler like the one included with VC++.

To start profiling an application in Visual C++ 2017, you first need to open the project in Visual Studio. This example uses the same `NameDB` code as in the first inefficient design attempt from earlier in the chapter. That code is not repeated here. Once your project is opened in Visual Studio, click on the Analyze menu, and then choose Performance Profiler. A new window appears, as shown in Figure 25-1.

In this new window, enable the “Performance Wizard” option and click the Start button. This starts a wizard, as shown in Figure 25-2.

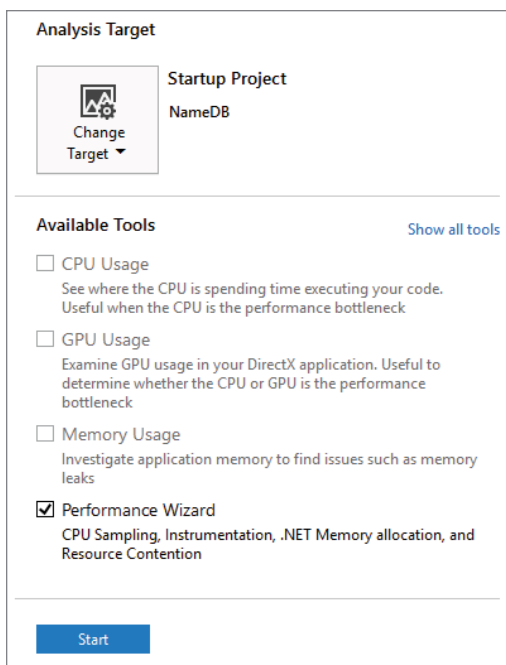

FIGURE 25-1

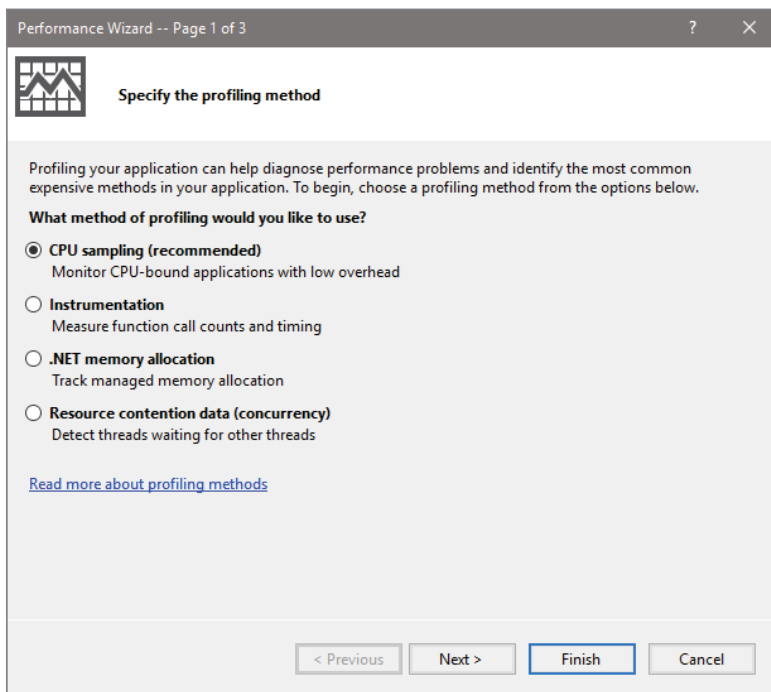

FIGURE 25-2

Depending on your version of VC++ 2017, there are a number of different profiling methods available. The following non-exhaustive list explains three of them.

- **CPU Sampling:** This method is used to monitor applications with low overhead. This means that the act of profiling the application will not have a big performance impact on the target application.
- **Instrumentation:** This method adds extra code to the application to be able to accurately count the number of function calls and to time individual function calls. However, this method has a much bigger performance impact on the application. It is recommended to use the CPU Sampling method first to get an idea about the bottlenecks in your application. If that method does not give you enough information, you can try the Instrumentation method.
- **Resource contention data (concurrency):** This method allows you to graphically monitor multithreaded applications. It allows you to see which threads are running, which threads are waiting for something, and so on.

For this profiling example, leave the default CPU sampling method selected and click the Next button. The next page of the wizard asks you to select the application that you want to profile. Here you should select your `NameDB` project and click the Next button. On the last page of the wizard, you can enable the “Launch profiling after the wizard finishes” option and then click the Finish button. You may get a message saying that you don’t have the right credentials for profiling, and asking whether you would like to upgrade your credentials. If you get this message, you should allow VC++ to upgrade your credentials; otherwise, the profiler will not work.

When the program execution is finished, Visual Studio automatically opens the profiling report. Figure 25-3 shows how this report might look like when profiling the first attempt of the `NameDB` application.

From this report, you can immediately see the hot path. Just like with `gprof`, it shows that the `NameDB` constructor takes up most of the running time of the program, and that `incrementNameCount()` and `nameExists()` both take almost the same time. The Visual Studio profiling report is interactive. For example, you can drill down the `NameDB` constructor by clicking on it. This results in a drill-down report for that function, as shown in Figure 25-4.

This drill-down view shows a graphical breakdown at the top, and the actual code of the method at the bottom. The code view shows the percentage of the running time that a line needed. The lines using up most of the time are shown in red. When you are interactively browsing the profiling report, you can always go back by using the back arrow in the top-left corner of the report.

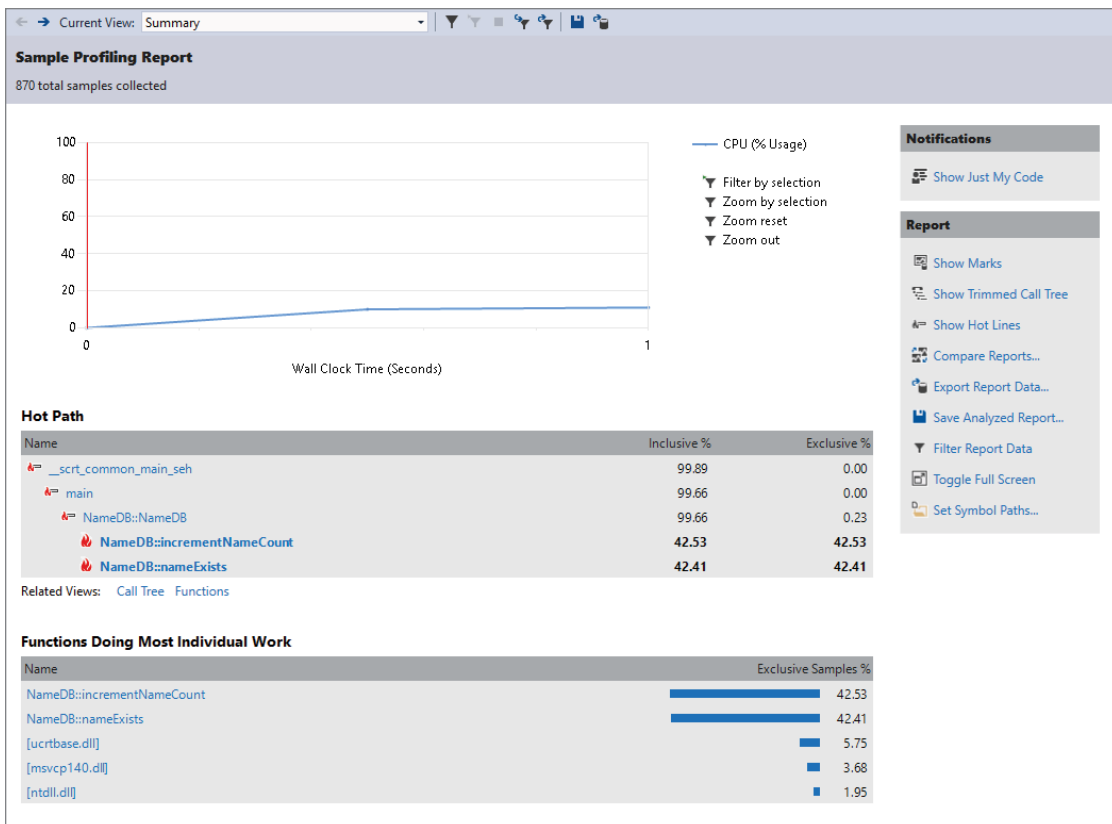

FIGURE 25-3

At the top of the report there is also a drop-down menu, which you can use to quickly jump to certain summary or details pages.

If you go back to the “Summary” page of the profiling report, you can see that there is a “Show Trimmed Call Tree” link on the right. Clicking that link displays a trimmed call tree showing you an alternative view of the hot path in your code, as shown in Figure 25-5.

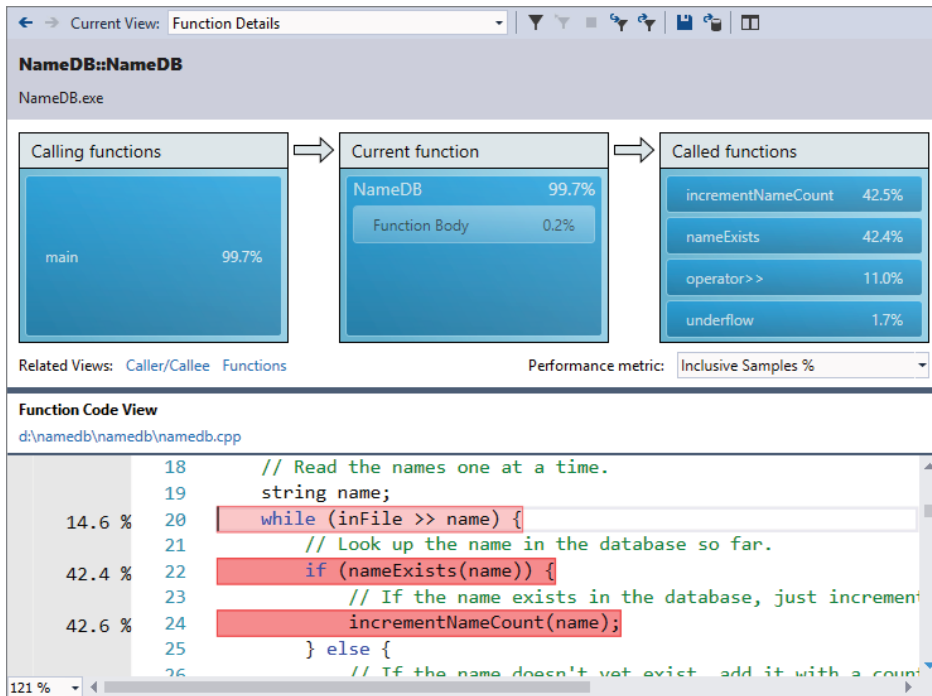

FIGURE 25-4

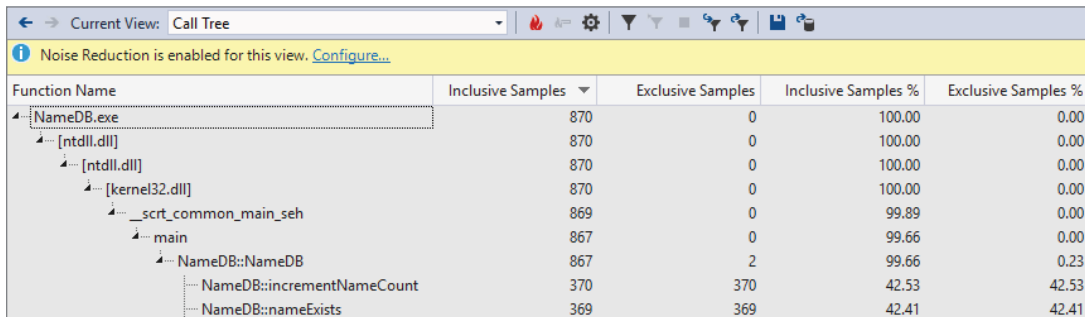

FIGURE 25-5

Also in this view, you immediately see that `main()` is calling the `NameDB` constructor, which is using up most of the running time.

SUMMARY

This chapter discussed the key aspects of efficiency and performance in C++ programs, and provided several specific tips and techniques for designing and writing more efficient applications. Hopefully you gained an appreciation for the importance of performance and for the power of profiling tools.

There are two important things to remember from this chapter. The first thing is that you should not get too obsessed with performance while designing and coding. It's recommended to first make a correct, well-structured design and implementation, then use a profiler, and only optimize those parts that are flagged by a profiler as being a performance bottleneck.

The second thing to remember is that design-level efficiency is far more important than language-level efficiency. For example, you shouldn't use algorithms or data structures with bad complexity if there are better ones available.

26

Becoming Adept at Testing

WHAT'S IN THIS CHAPTER?

- What software quality control is and how to track bugs
- What unit testing means
- Unit testing in practice using the Visual C++ Testing Framework
- What integration, system, and regression testing means

WROX.COM DOWNLOADS FOR THIS CHAPTER

Please note that all the code examples for this chapter are available as a part of this chapter's code download on the book's website at www.wrox.com/go/proc++4e on the Download Code tab.

A programmer has overcome a major hurdle in her career when she realizes that testing is a part of the software development process. Bugs are not an occasional occurrence. They are found in *every* project of significant size. A good *quality-assurance* (QA) team is invaluable, but the full burden of testing cannot be placed on QA alone. Your responsibility as a programmer is to write code that works, and to write tests to prove its correctness.

A distinction is often made between *white-box testing*, in which the tester is aware of the inner workings of the program, and *black-box testing*, which tests the program's functionality without any knowledge of its implementation. Both forms of testing are important to professional-quality projects. Black-box testing is the most fundamental approach because it typically models the behavior of a user. For example, a black-box test can examine interface components such as buttons. If the tester clicks the button and nothing happens, there is obviously a bug in the program.

Black-box testing cannot cover everything. Modern programs are too large to employ a simulation of clicking every button, providing every kind of input, and performing all combinations of commands. White-box testing is necessary, because, when you know the code when tests are written at the object or subsystem level, then it is easier to make sure all code paths in the code are exercised by tests. This helps to ensure test coverage. White-box tests are often easier to write and automate than black-box tests. This chapter focuses on topics that would generally be considered white-box testing techniques because the programmer can use these techniques during the development.

This chapter begins with a high-level discussion of quality control, including some approaches to viewing and tracking bugs. A section on unit testing, one of the simplest and most useful types of testing, follows this introduction. You then read about the theory and practice of unit testing, as well as several examples of unit tests in action. Next, higher-level tests are covered, including integration tests, system tests, and regression tests. Finally, this chapter ends with a list of tips for successful testing.

QUALITY CONTROL

Large programming projects are rarely finished when a feature-complete goal is reached. There are always bugs to find and fix, both during and after the main development phase. It is essential to understand the shared responsibility of quality control and the life cycle of a bug in order to perform well in a group.

Whose Responsibility Is Testing?

Software development organizations have different approaches to testing. In a small startup, there may not be a group of people whose full-time job is testing the product. Testing may be the responsibility of the individual developers, or all the employees of the company may be asked to lend a hand and try to break the product before its release. In larger organizations, a full-time quality assurance staff probably qualifies a release by testing it according to a set of criteria. Nonetheless, some aspects of testing may still be the responsibility of the developers. Even in organizations where the developers have no role in formal testing, you still need to be aware of what your responsibilities are in the larger process of quality assurance.

The Life Cycle of a Bug

All good engineering groups recognize that bugs will occur in software both before and after its release. There are many different ways to deal with these problems. Figure 26-1 shows a formal bug process, expressed as a flow chart. In this particular process, a bug is always filed by a member of the QA team. The bug reporting software sends a notification to the development manager, who sets the priority of the bug and assigns the bug to the appropriate module owner. The module owner can accept the bug, or explain why the bug actually belongs to a different module or is invalid, giving the development manager the opportunity to assign it to someone else.

Once the bug has found its rightful owner, a fix is made and the developer marks the bug as “fixed.” At this point, the QA engineer verifies that the bug no longer exists and marks the bug as “closed” or reopens the bug if it is still present.

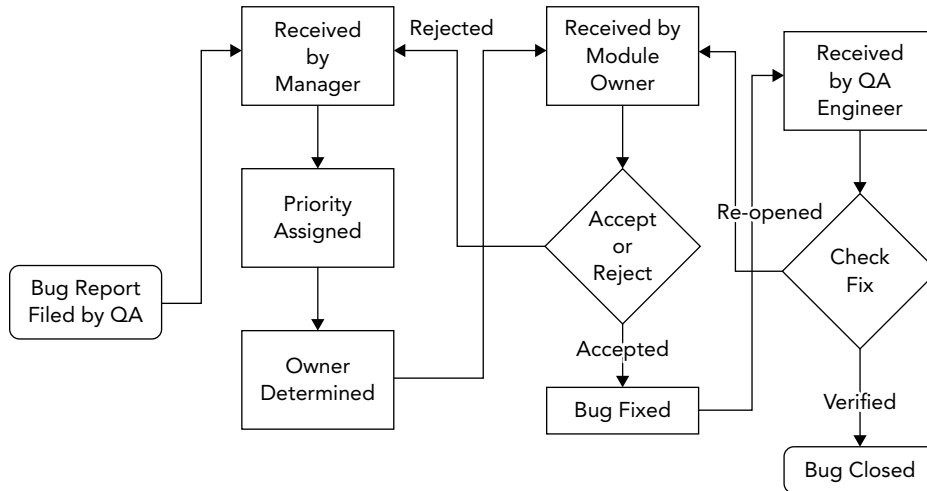

FIGURE 26-1

A less formal approach is shown in Figure 26-2. In this workflow, anybody can file a bug, and assign an initial priority and a module. The module owner receives the bug report and can either accept it or reassign it to another engineer or module. When a correction is made, the bug is marked as “fixed.” Toward the end of the testing phase, all the developers and QA engineers divide up the fixed bugs and verify that each bug is no longer present in the current build. The release is ready when all bugs are marked as “closed.”

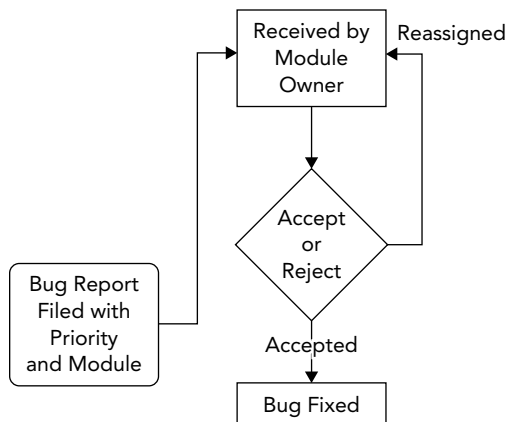

FIGURE 26-2

Bug-Tracking Tools

There are many ways to keep track of software bugs, from informal spreadsheet- or e-mail-based schemes to expensive third-party bug-tracking software. The appropriate solution for your organization depends on the group's size, the nature of the software, and the level of formality you want to build around bug fixing.

There are also a number of free open-source bug-tracking solutions available. One of the more popular free tools for bug tracking is *Bugzilla*, written by the authors of the Mozilla web browser. As an open-source project, Bugzilla has gradually accumulated a number of useful features to the point where it now rivals expensive bug-tracking software packages. Here are just a few of its many features:

- Customizable settings for a bug, including its priority, associated component, status, and so on
- E-mail notification of new bug reports or changes to an existing report
- Tracking of dependencies between bugs and resolution of duplicate bugs
- Reporting and searching tools
- A web-based interface for filing and updating bugs

Figure 26-3 shows a bug being entered into a Bugzilla project that was set up for the second edition of this book. For my purposes, each chapter was input as a Bugzilla component. The filer of the bug can specify the severity of the bug (how big of a deal it is). A summary and description are included to make it possible to search for the bug or list it in a report format.

Bug-tracking tools like Bugzilla are essential components of a professional software development environment. In addition to supplying a central list of currently open bugs, bug-tracking tools provide an important archive of previous bugs and their fixes. A support engineer, for instance, might use the tool to search for a problem similar to one reported by a customer. If a fix was made, the support person will be able to tell the customer which version they need to update to, or how to work around the problem.

Bugzilla – Enter Bug: Professional C++ Second Edition

Home | New | Browse | Search | Search [?] | Reports | My Requests | Preferences | Administration
 Help | Log out

Before reporting a bug, please read the [bug writing guidelines](#), please look at the list of [most frequently reported bugs](#), and please [search](#) for the bug.

[Show Advanced Fields](#) (* = Required Field)

Product: Professional C++ Second Edition

*** Component:**
 02 - Designing Professional C++ Programs
 03 - Designing with Objects
 04 - Designing for Reuse
 05 - Coding with Style
 06 - Gaining Proficiency with Classes and Objects
 07 - Mastering Classes and Object

Reporter: user@some-project.com

Version:

Severity: normal

Hardware: PC

OS: Windows 7

Component Description
 Chapter 6 describes the fundamental concepts involved in using classes and objects.

We've made a guess at your operating system and platform. Please check them and make any corrections if necessary.

*** Summary:**

Description:

Attachment:

FIGURE 26-3

UNIT TESTING

The only way to find bugs is through testing. One of the most important types of tests from a developer's point of view is the *unit test*. Unit tests are pieces of code that exercise specific functionality of a class or subsystem. These are the finest-grained tests that you could possibly write. Ideally, one

or more unit tests should exist for every low-level task that your code can perform. For example, imagine that you are writing a math library that can perform addition and multiplication. Your suite of unit tests might contain the following tests:

- Test a simple addition
- Test addition of large numbers
- Test addition of negative numbers
- Test addition of zero to a number
- Test the commutative property of addition
- Test a simple multiplication
- Test multiplication of large numbers
- Test multiplication of negative numbers
- Test multiplication with zero
- Test the commutative property of multiplication

Well-written unit tests protect you in many ways:

1. They prove that a piece of functionality actually works. Until you have some code that actually makes use of your class, its behavior is a major unknown.
2. They provide a first alert when a recently introduced change breaks something. This specific usage, called a *regression test*, is covered later in this chapter.
3. When used as part of the development process, they force the developer to fix problems from the start. If you are prevented from checking in your code with failed unit tests, then you're forced to address problems right away.
4. Unit tests let you try out code before other code is in place. When you first started programming, you could write an entire program and then run it for the first time. Professional programs are too big for that approach, so you need to be able to test components in isolation.
5. Last, but certainly not least, they provide an example of usage. Almost as a side effect, unit tests make great reference code for other programmers. If a co-worker wants to know how to perform matrix multiplication by using your math library, you can point her to the appropriate test.

Approaches to Unit Testing

It's hard to go wrong with unit tests, unless you don't write them or you write them poorly. In general, the more tests you have, the more coverage you have. The more coverage you have, the less likely it is for bugs to fall through the cracks and for you to have to tell your boss, or worse, your customer, "Oh, we never tested that."

There are several methodologies for writing unit tests most effectively. The Extreme Programming methodology, explained in Chapter 24, instructs its followers to write unit tests *before* writing code.

Writing tests first helps you to solidify the requirements for the component and to provide a metric that can be used to determine when it is done. However, writing tests first can be tricky and requires diligence on the part of the programmer. For some programmers, it simply doesn't mesh well with their coding style. A less rigid approach is to *design* the tests before coding, but *implement* them later in the process. This way, the programmer is still forced to understand the requirements of the module but doesn't have to write code that makes use of nonexistent classes.

In some groups, the author of a particular subsystem doesn't write the unit tests for that subsystem. The idea is that if you write the tests for your own code, you might subconsciously work around problems that you know about, or only cover certain cases that you know your code handles well. In addition, it's sometimes difficult to get excited about finding bugs in code you just wrote, so you might only put in a half-hearted effort. Having one developer write unit tests for another developer's code requires a lot of extra overhead and coordination. When such coordination is accomplished, however, this approach helps guarantee more-effective tests.

Another way to ensure that unit tests are actually testing the right parts of the code is to write them so that they maximize *code coverage*. You can use a code coverage tool, such as `gcov`, that tells you what percentage of the code is called by unit tests. The idea is that a properly tested piece of code has unit tests to test all possible code paths that can be taken through that piece of code.

The Unit Testing Process

The process of providing unit tests for your code starts from the very beginning, long before any code is written. Keeping unit-testability in mind during the design phase can influence the design decisions you make for your software. Even if you do not subscribe to the methodology of writing unit tests before you write code, you should at least take the time to consider what sorts of tests you will provide, even while still in the design phase. This way, you can break the task up into well-defined chunks, each of which has its own test-validated criteria. For example, if your task is to write a database access class, you might first write the functionality that inserts data into the database. Once that is fully tested with a suite of unit tests, you can continue to write the code to support updates, deletes, and selects, testing each piece as you go.

The following list of steps is a suggested approach for designing and implementing unit tests. As with any programming methodology, the best process is the one that yields the best results. I suggest that you experiment with different ways of using unit tests to discover what works best for you.

Define the Granularity of Your Tests

Writing unit tests takes time, there is no way around this. Software developers are often crunched for time. To reach deadlines, developers tend to skip writing unit tests, because they think they will finish faster that way. Unfortunately, this thinking does not take the whole picture into account. Omitting unit tests will back-fire in the long run. The earlier a bug is detected in the software development process, the less it costs. If a developer finds a bug during unit testing, it can be fixed immediately, before anyone else encounters it. However, if the bug is discovered by QA, then it becomes a much costlier bug. The bug can cause an extra development cycle, requires bug management, has to go back to the development team for a fix, and then back to QA to verify the fix. If a bug slips through the QA process and finds its way to the customer, then it becomes even more expensive.

The *granularity* of tests refers to their scope. As the following table illustrates, you can initially unit test a database class with just a few test functions, and then gradually add more tests to ensure that everything works as it should.

LARGE-GRAINED TESTS	MEDIUM-GRAINED TESTS	FINE-GRAINED TESTS
<code>testConnection()</code>	<code>testConnectionDropped()</code>	<code>testConnectionThroughHTTP()</code>
<code>testInsert()</code>	<code>testInsertBadData()</code>	<code>testConnectionLocal()</code>
<code>testUpdate()</code>	<code>testInsertStrings()</code>	<code>testConnectionErrorBadHost()</code>
<code>testDelete()</code>	<code>testInsertIntegers()</code>	<code>testConnectionErrorServerBusy()</code>
<code>testSelect()</code>	<code>testUpdateStrings()</code>	<code>testInsertWideCharacters()</code>
	<code>testUpdateIntegers()</code>	<code>testInsertLargeData()</code>
	<code>testDeleteNonexistentRow()</code>	<code>testInsertMalformed()</code>
	<code>testSelectComplicated()</code>	<code>testUpdateWideCharacters()</code>
	<code>testSelectMalformed()</code>	<code>testUpdateLargeData()</code>
		<code>testUpdateMalformed()</code>
		<code>testDeleteWithoutPermissions()</code>
		<code>testDeleteThenUpdate()</code>
		<code>testSelectNested()</code>
		<code>testSelectWideCharacters()</code>
		<code>testSelectLargeData()</code>

As you can see, each successive column brings in more-specific tests. As you move from large-grained tests to more finely grained tests, you start to consider error conditions, different input data sets, and different modes of operation.

Of course, the decisions you make initially when choosing the granularity of your tests are not set in stone. Perhaps the database class is just being written as a proof-of-concept and might not even be used. A few simple tests may be adequate now, and you can always add more later. Or perhaps the use cases will change at a later date. For example, the database class might not initially have been written with international characters in mind. Once such features are added, they should be tested with specific targeted unit tests.

Consider the unit tests to be part of the actual implementation of a feature. When you make a modification, don't just modify the tests so that they continue to work. Write new tests and re-evaluate the existing ones. When bugs are uncovered and fixed, add new unit tests that specifically test those fixes.

NOTE *Unit tests are part of the subsystem that they are testing. As you enhance and refine the subsystem, enhance and refine the tests.*

Brainstorm the Individual Tests

Over time, you will gain an intuition for which aspects of a piece of code should turn into a unit test. Certain methods or inputs will just feel like they should be tested. This intuition is gained through trial and error, and by looking at unit tests that other people in your group have written. It should be pretty easy to pick out which programmers are the best unit testers. Their tests tend to be organized and frequently modified.

Until unit test creation becomes second nature, approach the task of figuring out which tests to write by brainstorming. To get some ideas flowing, consider the following questions:

1. What are the things that this piece of code was written to do?
2. What are the typical ways each method would be called?
3. What preconditions of the methods could be violated by the caller?
4. How could each method be misused?
5. What kinds of data are you expecting as input?
6. What kinds of data are you *not* expecting as input?
7. What are the edge cases or exceptional conditions?

You don't need to write formal answers to those questions (unless your manager is a particularly fervent devotee of this book or of certain testing methodologies), but they should help you generate some ideas for unit tests. The table of tests for the database class contained test functions, each of which arose from one of these questions.

Once you have generated ideas for some of the tests you would like to use, consider how you might organize them into categories; the breakdown of tests will fall into place. In the database class example, the tests could be split into the following categories:

- Basic tests
- Error tests
- Localization tests
- Bad input tests
- Complicated tests

Splitting your tests into categories makes them easier to identify and augment. It might also make it easier to realize which aspects of the code are well tested and which could use a few more unit tests.

WARNING *It's easy to write a massive number of simple tests, but don't forget about the more complicated cases!*

Create Sample Data and Results

The most common trap to fall into when writing unit tests is to match the test to the behavior of the code, instead of using the test to validate the code. If you write a unit test that performs a database select for a piece of data that is definitely in the database, and the test fails, is it a problem with the code or a problem with the test? It's often easier to assume that the code is right and to modify the test to match. This approach is usually wrong.

To avoid this pitfall, you should understand the inputs to the test and the expected output before you try it out. This is sometimes easier said than done. For example, say you wrote some code to encrypt an arbitrary block of text using a particular key. A reasonable unit test would take a fixed string of text and pass it in to the encryption module. Then, it would examine the result to see if it was correctly encrypted.

When you go to write such a test, it is tempting to try out the behavior with the encryption module first and see the result. If it looks reasonable, you might write a test to look for that value. Doing so really doesn't prove anything, however! You haven't actually tested the code; you've just written a test that guarantees it will continue to return that same value. Often times, writing the test requires some real work; you would need to encrypt the text independently of your encryption module to get an accurate result.

WARNING *Decide on the correct output for your test before you ever run the test.*

Write the Tests

The exact code behind a test varies, depending on what type of test framework you have in place. One framework, the Microsoft Visual C++ Testing Framework, is discussed later in this chapter. Independent of the actual implementation, however, the following guidelines will help ensure effective tests:

- Make sure that you're testing only one thing in each test. That way, if a test fails, it will point to a specific piece of functionality.
- Be specific inside the test. Did the test fail because an exception was thrown or because the wrong value was returned?
- Use logging extensively inside of test code. If the test fails someday, you will have some insight into what happened.
- Avoid tests that depend on earlier tests or are otherwise interrelated. Tests should be as atomic and isolated as possible.
- If the test requires the use of other subsystems, consider writing *stubs* or *mocks* of those subsystems that simulate the modules' behavior so that changes in loosely related code don't cause the test to fail.

- Ask your code reviewers to look at your unit tests as well. When you do a code review, tell the other engineer where you think additional tests could be added.

As you will see later in this chapter, unit tests are usually very small and simple pieces of code. In most cases, writing a single unit test will take only a few minutes, making them one of the most productive uses of your time.

Run the Tests

When you're done writing a test, you should run it right away before the anticipation of the results becomes too much to bear. The joy of a screen full of passing unit tests shouldn't be minimized. For most programmers, this is the easiest way to see quantitative data that declares your code useful and correct.

Even if you adopt the methodology of writing tests before writing code, you should still run the tests immediately after they are written. This way, you can prove to yourself that the tests fail initially. Once the code is in place, you have tangible data that shows that it accomplished what it was supposed to accomplish.

It's unlikely that every test you write will have the expected result the first time. In theory, if you are writing tests before writing code, all of your tests should fail. If one passes, either the code magically appeared or there is a problem with the test. If the code is done and tests still fail (some would say that if tests fail, the code is actually *not* done), there are two possibilities: the code could be wrong, or the tests could be wrong.

Running unit tests must be automated. This can be done in several ways. One option is to have a dedicated system that automatically runs all unit tests after every continuous integration build, or at least once a night. Such a system must send out e-mails to notify developers when unit tests are failing. Another option is to set up your local development environment so that unit tests are executed every time you compile your code. For this, unit tests should be kept small and very efficient. If you do have longer-running unit tests, put these separate, and let these be tested by a dedicated test system.

Unit Testing in Action

Now that you've read about unit testing in theory, it's time to actually write some tests. The following example draws on the object pool implementation from Chapter 25. As a brief recap, the object pool is a class that can be used to avoid excessive object creation. By keeping track of already-created objects, the pool acts as a broker between code that needs a certain type of object and such objects that already exist.

The interface for the `ObjectPool` class is as follows; consult Chapter 25 for all the details.

```
template <typename T>
class ObjectPool
{
public:
    ObjectPool() = default;
    virtual ~ObjectPool() = default;
```

```

// Prevent assignment and pass-by-value
ObjectPool(const ObjectPool<T>& src) = delete;
ObjectPool<T>& operator=(const ObjectPool<T>& rhs) = delete;

// The type of smart pointer returned by acquireObject().
using Object = std::shared_ptr<T>;

// Reserves and returns an object for use.
Object acquireObject();

private:
// Stores the objects that are not currently in use by clients.
std::queue<std::unique_ptr<T>> mFreeList;
};

```

Introducing the Microsoft Visual C++ Testing Framework

Microsoft Visual C++ comes with a built-in testing framework. The advantage of using a unit testing framework is that it allows the developer to focus on writing tests instead of dealing with setting up tests, building logic around tests, and gathering results. The following discussion is written for Visual C++ 2017.

NOTE *If you are not using Visual C++, there are a number of open-source unit testing frameworks available. Google Test¹ is one such framework for C++, and the Boost Test Library² is another one. They both include a number of helpful utilities for test developers, and options to control the automatic output of results.*

To get started with the *Visual C++ Testing Framework*, you have to create a test project. The following steps explain how to test the `ObjectPool` class:

1. Start Visual C++, create a new project, select Visual C++ ⇨ Test ⇨ Native Unit Test Project, give the project a name, and click OK.
2. The wizard creates a new test project, which includes a file called `unittest1.cpp`. Select this file in the Solution Explorer and delete it, because you will add your own files.
3. Add empty files called `ObjectPoolTest.h` and `ObjectPoolTest.cpp` to the newly created test project.
4. Add an `#include "stdafx.h"` as the first line in `ObjectPoolTest.cpp`. (This line is required for the precompiled header feature of Visual C++.)

Now you are ready to start adding unit tests to the code.

¹<https://github.com/google/googletest>

²http://www.boost.org/doc/libs/1_65_1/libs/test/

The most common way is to divide your unit tests into logical groups of tests, called *test classes*. You will now create a test class called `ObjectPoolTest`. The basic code in `ObjectPoolTest.h` for getting started is as follows:

```
#pragma once
#include <CppUnitTest.h>

TEST_CLASS(ObjectPoolTest)
{
    public:
};
```

This code defines a test class called `ObjectPoolTest`, but the syntax is a bit different compared to standard C++. This is so that the framework can automatically discover all the tests.

If you need to perform any tasks that need to happen prior to running the tests defined in a test class, or to perform any cleanup after the tests have been executed, then you can implement an initialize method and a cleanup method. Here is an example:

```
TEST_CLASS(ObjectPoolTest)
{
    public:
        TEST_CLASS_INITIALIZE(setUp);
        TEST_CLASS_CLEANUP(tearDown);
};
```

Because the tests for `ObjectPool` are relatively simple and isolated, empty definitions will suffice for `setUp()` and `tearDown()`, or you can simply remove them altogether. If you do need them, the beginning stage of the `ObjectPoolTest.cpp` source file is as follows:

```
#include "stdafx.h"
#include "ObjectPoolTest.h"

void ObjectPoolTest::setUp() { }
void ObjectPoolTest::tearDown() { }
```

That's all the initial code you need to start developing unit tests.

NOTE *In real-world scenarios, you usually divide the testing code and the code you want to test into separate projects. In the interest of keeping this example succinct, I have not done this here.*

Writing the First Test

Because this may be your first exposure to the Visual C++ Testing Framework, or to unit tests at large, the first test will be a very simple one. It tests whether $0 < 1$.

An individual unit test is just a method of a test class. To create a simple test, add its declaration to the `ObjectPoolTest.h` file:

```
TEST_CLASS(ObjectPoolTest)
{
    public:
```

```

    TEST_CLASS_INITIALIZE(setUp);
    TEST_CLASS_CLEANUP(tearDown);

    TEST_METHOD(testSimple); // Your first test!
};

```

The implementation of this test uses `Assert::IsTrue()`, defined in the `Microsoft::VisualStudio::CppUnitTestFramework` namespace, to perform the actual test. In this case, the test claims that 0 is less than 1. Here is the updated `ObjectPoolTest.cpp` file:

```

#include "stdafx.h"
#include "ObjectPoolTest.h"

using namespace Microsoft::VisualStudio::CppUnitTestFramework;

void ObjectPoolTest::setUp() { }
void ObjectPoolTest::tearDown() { }

void ObjectPoolTest::testSimple()
{
    Assert::IsTrue(0 < 1);
}

```

That's it. Of course, most of your unit tests will do something a bit more interesting than a simple assert. As you will see, the common pattern is to perform some sort of calculation, and then assert that the result is the value you expect. With the Visual C++ Testing Framework, you don't even need to worry about exceptions; the framework catches and reports them as necessary.

Building and Running Tests

Build your solution by clicking **Build** ⇄ **Build Solution**, and open the Test Explorer (**Test** ⇄ **Windows** ⇄ **Test Explorer**), shown in Figure 26-4.

After having built the solution, the Test Explorer automatically displays all discovered unit tests. In this case, it displays the `testSimple` unit test. You can run the tests by clicking the “Run All” link in the upper-left corner of the window. When you do that, the Test Explorer shows whether the unit tests succeed or fail. In this case, the single unit test succeeds, as shown in Figure 26-5.

If you modify the code to assert that `1 < 0`, the test fails, and the Test Explorer reports the failure, as shown in Figure 26-6.

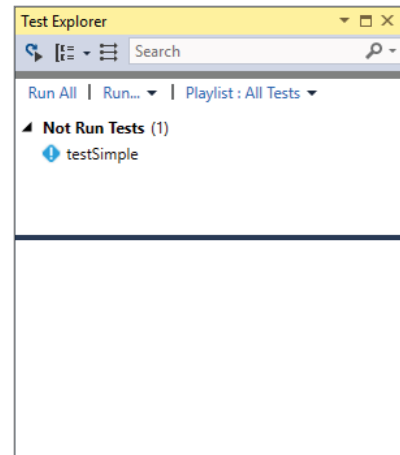

FIGURE 26-4

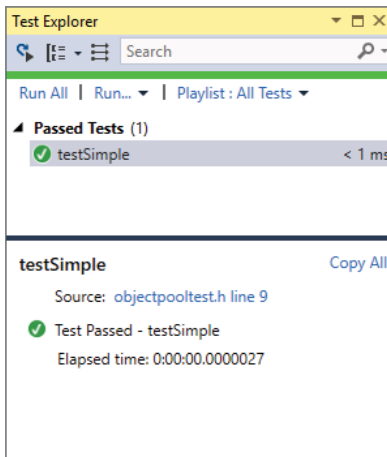

FIGURE 26-5

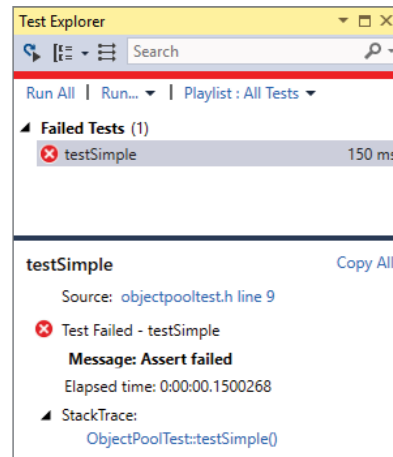

FIGURE 26-6

The lower part of the Test Explorer window displays useful information related to the selected unit test. In case of a failed unit test, it tells you exactly what failed. In this case, it says that an assertion failed. There is also a stack trace that was captured at the time the failure occurred. You can click the hyperlinks in that stack trace to jump directly to the offending line—very useful for debugging.

Negative Tests

You can write *negative tests*, tests that do something that *should* fail. For example, you can write a negative test to test that a certain method throws an expected exception. The Visual C++ Testing Framework provides the `Assert::ExpectException()` function to handle expected exceptions. For example, the following unit test uses `ExpectException()` to execute a lambda expression that throws an `std::invalid_argument` exception. The template type parameter for `ExpectException()` specifies the type of exception to expect.

```
void ObjectPoolTest::testException()
{
    Assert::ExpectException<std::invalid_argument>(
        []{throw std::invalid_argument("Error"); },
        L"Unknown exception caught.");
}
```

Adding the Real Tests

Now that the framework is all set up and a simple test is working, it's time to turn your attention to the `ObjectPool` class and write some code that actually tests it. All of the following tests will be added to `ObjectPoolTest.h` and `ObjectPoolTest.cpp`, just like the earlier initial test.

First, copy the `ObjectPool.h` header file next to the `ObjectPoolTest.h` file you created, and then add it to the project.

Before you can write the tests, you'll need a helper class to use with the `ObjectPool` class. The `ObjectPool` creates objects of a certain type and hands them out to the caller as requested. Some of the tests will need to check if a retrieved object is the same as a previously retrieved object. One way to do this is to create a pool of serial objects—objects that have a monotonically increasing serial number. The following code shows the `Serial.h` header file defining such a class:

```
#include <cstddef> // For size_t

class Serial
{
public:
    Serial();
    size_t getSerialNumber() const;
private:
    static size_t sNextSerial;
    size_t mSerialNumber;
};
```

And here are the implementations in `Serial.cpp`:

```
#include "stdafx.h"
#include "Serial.h"

size_t Serial::sNextSerial = 0; // The first serial number is 0.

Serial::Serial()
    : mSerialNumber(sNextSerial++) // A new object gets the next serial number.
{
}

size_t Serial::getSerialNumber() const
{
    return mSerialNumber;
}
```

Now, on to the tests! As an initial sanity check, you might want a test that creates an object pool. If any exceptions are thrown during creation, the Visual C++ Testing Framework will report an error:

```
void ObjectPoolTest::testCreation()
{
    ObjectPool<Serial> myPool;
}
```

Don't forget to add a `TEST_METHOD(testCreation);` statement to the header file. This holds for all subsequent tests as well. You also need to add an include for `"ObjectPool.h"` and for `"Serial.h"` to the `ObjectPoolTest.cpp` source file.

A second test, `testAcquire()`, tests a specific piece of public functionality: the ability of the `ObjectPool` to give out an object. In this case, there is not much to assert. To prove validity of the resulting `Serial` reference, the test asserts that its serial number is greater than or equal to zero:

```
void ObjectPoolTest::testAcquire()
{
    ObjectPool<Serial> myPool;
    auto serial = myPool.acquireObject();
    Assert::IsTrue(serial->getSerialNumber() >= 0);
}
```

The next test is a bit more interesting. The `ObjectPool` should not give out the same `Serial` object twice (unless it is released back to the pool). This test checks the exclusivity property of the `ObjectPool` by retrieving a number of objects from the pool. The retrieved objects are stored in a vector to make sure they aren't automatically released back to the pool at the end of each `for` loop iteration. If the pool is properly dishing out unique objects, none of their serial numbers should match. This implementation uses the `vector` and `set` containers from the Standard Library. Consult Chapter 17 for details if you are unfamiliar with these containers. The code is written according to the *AAA principle*: Arrange, Act, Assert; the test first sets up everything for the test to run, then does some work (retrieving a number of objects from the pool), and finally asserts the expected result (all serial numbers are different).

```
void ObjectPoolTest::testExclusivity()
{
    ObjectPool<Serial> myPool;
    const size_t numberOfObjectsToRetrieve = 10;
    std::vector<ObjectPool<Serial>::Object> retrievedSerials;
    std::set<size_t> seenSerialNumbers;

    for (size_t i = 0; i < numberOfObjectsToRetrieve; i++) {
        auto nextSerial = myPool.acquireObject();

        // Add the retrieved Serial to the vector to keep it 'alive',
        // and add the serial number to the set.
        retrievedSerials.push_back(nextSerial);
        seenSerialNumbers.insert(nextSerial->getSerialNumber());
    }

    // Assert that all retrieved serial numbers are different.
    Assert::AreEqual(numberOfObjectsToRetrieve, seenSerialNumbers.size());
}
```

The final test (for now) checks the release functionality. Once an object is released, the `ObjectPool` can give it out again. The pool shouldn't create additional objects until it has *recycled* all released objects.

The test first retrieves ten `Serial` objects from the pool, stores them in a vector to keep them alive, records the serial number of the last retrieved `Serial`, and finally clears the vector to return all retrieved objects back to the pool.

The second phase of the test again retrieves ten objects from the pool and stores them in a vector to keep them alive. All these retrieved objects must have a serial number less than or equal to the last serial number retrieved during the first phase of the test. After retrieving ten objects, one additional object is retrieved. This object should have a new serial number.

Finally, two assertions assert that all ten objects were recycled, and that the eleventh object had a new serial number.

```
void ObjectPoolTest::testRelease()
{
    ObjectPool<Serial> myPool;
    const size_t numberOfObjectsToRetrieve = 10;

    std::vector<ObjectPool<Serial>::Object> retrievedSerials;
    for (size_t i = 0; i < numberOfObjectsToRetrieve; i++) {
        // Add the retrieved Serial to the vector to keep it 'alive'.
        retrievedSerials.push_back(myPool.acquireObject());
    }
    size_t lastSerialNumber = retrievedSerials.back()->getSerialNumber();
    // Release all objects back to the pool.
    retrievedSerials.clear();

    // The above loop has created ten Serial objects, with serial
    // numbers 0-9, and released all ten Serial objects back to the pool.

    // The next loop first again retrieves ten Serial objects. The serial
    // numbers of these should all be <= lastSerialNumber.
    // The Serial object acquired after that should have a new serial number.

    bool wronglyNewObjectCreated = false;
    for (size_t i = 0; i < numberOfObjectsToRetrieve; i++) {
        auto nextSerial = myPool.acquireObject();
        if (nextSerial->getSerialNumber() > lastSerialNumber) {
            wronglyNewObjectCreated = true;
            break;
        }
        retrievedSerials.push_back(nextSerial);
    }

    // Acquire one more Serial object, which should have a serial
    // number > lastSerialNumber.
    auto anotherSerial = myPool.acquireObject();
    bool newObjectCreated =
        (anotherSerial->getSerialNumber() > lastSerialNumber);

    Assert::IsFalse(wronglyNewObjectCreated);
    Assert::IsTrue(newObjectCreated);
}
```

If you add all these tests and run them, the Test Explorer should look like Figure 26-7. Of course, if one or more tests fail, you are presented with the quintessential issue in unit testing: is it the test or the code that is broken?

Debugging Tests

The Visual C++ Testing Framework makes it easy to debug unit tests that are failing. The Test Explorer shows a stack trace captured at the time a unit test failed, containing hyperlinks pointing directly to offending lines.

However, sometimes it is useful to run a unit test directly in the debugger so that you can inspect variables at run time, step through the code line by line, and so on. To do this, you put a breakpoint on some line of code in your unit test. Then, you right-click the unit test in the Test Explorer and click Debug Selected Tests. The testing framework starts running the selected tests in the debugger and breaks at your breakpoint. From then on, you can step through the code however you want.

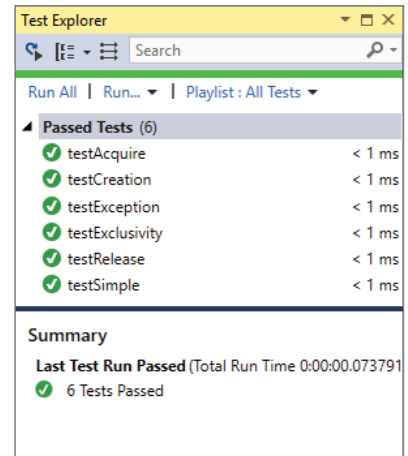

FIGURE 26-7

Basking in the Glorious Light of Unit Test Results

The tests in the previous section should have given you a good idea of how to start writing professional-quality tests for real code. It's just the tip of the iceberg, though. The previous examples should help you think of additional tests that you could write for the `ObjectPool` class. For example, you should include a test that acquires and releases objects multiple times, and tests whether such objects are properly recycled.

There is no end to the number of unit tests you could write for a given piece of code, and that's the best thing about unit tests. If you find yourself wondering how your code might react to a certain situation, that's a unit test. If a particular aspect of your subsystem seems to be presenting problems, increase unit test coverage of that particular area. Even if you simply want to put yourself in the client's shoes to see what it's like to work with your class, writing unit tests is a great way to get a different perspective.

HIGHER-LEVEL TESTING

While unit tests are the best first line of defense against bugs, they are only part of the larger testing process. Higher-level tests focus on how pieces of the product work together, as opposed to the relatively narrow focus of unit tests. In a way, higher-level tests are more challenging to write because it's less clear what tests need to be written. Still, you cannot really claim that the program works until you have tested how its pieces work together.

Integration Tests

An *integration test* covers areas where components meet. Unlike a unit test, which generally acts on the level of a single class, an integration test usually involves two or more classes. Integration tests excel at testing interactions between two components, often written by two different programmers. In fact, the process of writing an integration test often reveals important incompatibilities in designs.

Sample Integration Tests

Because there are no hard-and-fast rules to determine what integration tests you should write, some examples might help you get a sense of when integration tests are useful. The following scenarios depict cases where an integration test is appropriate, but they do not cover every possible case. Just as with unit tests, over time you will refine your intuition for useful integration tests.

A JSON-Based File Serializer

Suppose that your project includes a persistence layer that is used to save certain types of objects to disk and to read them back in. The hip way to serialize data is to use the JSON format, so a logical breakdown of components might include a JSON conversion layer sitting on top of a custom file API. Both of these components can be thoroughly unit tested. The JSON layer can have unit tests that ensure that different types of objects are correctly converted to JSON and populated from JSON. The file API can have tests that read, write, update, and delete files on disk.

When these modules start to work together, integration tests are appropriate. At the very least, you should have an integration test that saves an object to disk through the JSON layer, then reads it back in and does a comparison to the original. Because the test covers both modules, it is a basic integration test.

Readers and Writers to a Shared Resource

Imagine a program that contains a data structure shared by different components. For example, a stock-trading program can have a queue of buy-and-sell requests. Components related to receiving stock transaction requests can add orders to the queue, and components related to performing stock trades can take data off the queue. You can unit test the heck out of the queue class, but until it is tested with the actual components that will be using it, you really don't know if any of your assumptions are wrong.

A good integration test uses the stock request components and the stock trade components as clients of the queue class. You can write some sample orders and make sure that they successfully enter and exit the queue through the client components.

Wrapper around a Third-Party Library

Integration tests do not always need to occur at integration points in your own code. Many times, integration tests are written to test the interaction between your code and a third-party library.

For example, you may be using a database connection library to talk to a relational database system. Perhaps you built an object-oriented wrapper around the library that adds support for connection caching or provides a friendlier interface. This is a very important integration point to test because,

even though the wrapper probably provides a more useful interface to the database, it introduces possible misuse of the original library.

In other words, writing a wrapper is a good thing, but writing a wrapper that introduces bugs is going to be a disaster.

Methods of Integration Testing

When it comes to actually writing integration tests, there is often a fine line between integration and unit tests. If a unit test is modified so that it touches another component, is it suddenly an integration test? In a way, the answer is moot because a good test is a good test, regardless of the type of test. I recommend that you use the concepts of integration and unit testing as two *approaches* to testing, but avoid getting caught up in labeling the category of every single test.

In terms of implementation, integration tests are often written by using a unit testing framework, further blurring their distinction. As it turns out, unit testing frameworks provide an easy way to write a *yes/no* test and produce useful results. Whether the test is looking at a single unit of functionality or the intersection of two components hardly makes a difference from the framework's point of view.

However, for performance and organizational reasons, you may want to attempt to separate unit tests from integration tests. For example, your group may decide that everybody must run integration tests before checking in new code, but be a bit laxer on running unrelated unit tests. Separating the two types of tests also increases the value of results. If a test failure occurs within the JSON class tests, it will be clear that it's a bug in that class, not in the interaction between that class and the file API.

System Tests

System tests operate at an even higher level than integration tests. These tests examine the program as a whole. System tests often make use of a *virtual user* that simulates a human being working with the program. Of course, the virtual user must be programmed with a script of actions to perform. Other system tests rely on scripts or a fixed set of inputs and expected outputs.

Much like unit and integration tests, an individual system test performs a specific test and expects a specific result. It is not uncommon to use system tests to make sure that different features work in combination with one another.

In theory, a fully system-tested program would contain a test for every permutation of every feature. This approach quickly grows unwieldy, but you should still make an effort to test many features in combination. For example, a graphics program could have a system test that imports an image, rotates it, performs a blur filter, converts it to black and white, and then saves it. The test would compare the saved image to a file that contains the expected result.

Unfortunately, few specific rules can be stated about system tests because they are highly dependent on the actual application. For applications that process files with no user interaction, system tests can be written much like unit and integration tests. For graphical programs, a virtual user approach may be best. For server applications, you might need to build stub clients that simulate network traffic. The important part is that you are actually testing real use of the program, not just a piece of it.

Regression Tests

Regression testing is more of a testing concept than a specific type of test. The idea is that once a feature works, developers tend to put it aside and assume that it will continue to work. Unfortunately, new features and other code changes often conspire to break previously working functionality.

Regression tests are often put in place as a sanity check for features that are, more or less, complete and working. If the regression test is well written, it will cease to pass when a change is introduced that breaks the feature.

If your company has an army of quality-assurance testers, regression testing may take the form of manual testing. The tester acts as a user would and goes through a series of steps, gradually testing every feature that worked in the previous release. This approach is thorough and accurate if carefully performed, but is not particularly scalable.

At the other extreme, you could build a completely automated system that performs each function as a virtual user. This would be a scripting challenge, though several commercial and noncommercial packages exist to ease the scripting of various types of applications.

A middle ground is known as *smoke testing*. Some tests will only test a subset of the most important features that should work. The idea is that if something is broken, it should show up right away. If smoke tests pass, they could be followed by more rigorous manual or automated testing. The term *smoke testing* was introduced a long time ago, in electronics. After a circuit was built, with different components like vacuum tubes, resistors, and so on, the question was, “Is it assembled correctly?” A solution was to “plug it in, turn it on, and see if smoke comes out.” If smoke came out, the design might be wrong, or the assembly might be wrong. By seeing what part went up in smoke, the error could be determined.

Some bugs are like nightmares: they are both terrifying and recurring. Recurring bugs are frustrating and a poor use of engineering resources. Even if, for some reason, you decide not to write a suite of regression tests, you should *still* write regression tests for bugs that you fix.

By writing a test for a bug fix, you both prove that the bug is fixed and set up an alert that is triggered if the bug ever comes back (for example, if your change is rolled back or otherwise undone, or if two branches are not merged correctly into the main development branch). When a regression test of a previously fixed bug fails, it should be easy to fix because the regression test can refer to the original bug number and describe how it was fixed the first time.

TIPS FOR SUCCESSFUL TESTING

As a software engineer, your role in testing may range anywhere from basic unit testing responsibility to complete management of an automated test system. Because testing roles and styles vary so much, here are several tips from my experience that may help you in different testing situations:

- Spend some time designing your automated test system. A system that runs constantly throughout the day will detect failures quickly. A system that sends e-mails to engineers automatically, or sits in the middle of the room loudly playing show tunes when a failure occurs, will result in increased visibility of problems.

- Don't forget about stress testing. Even if a full suite of unit tests passes for your database access class, it could still fall down when used by several dozen threads simultaneously. You should test your product under the most extreme conditions it could face in the real world.
- Test on a variety of platforms or a platform that closely mirrors the customer's system. One method of testing on multiple operating systems is to use a virtual machine environment that allows you to run several different operating systems on the same physical machine.
- Some tests can be written to intentionally inject faults in a system. For example, you could write a test that deletes a file while it is being read, or that simulates a network outage during a network operation.
- Bugs and tests are closely related. Bug fixes should be proven by writing regression tests. A comment with a test could refer to the original bug number.
- Don't remove tests that are failing. When a co-worker is slaving over a bug and finds out you removed tests, he will come looking for you.

The most important tip I can give you is to remember that testing is a part of software development. If you agree with that and accept it before you start coding, it won't be quite as unexpected when the feature is finished, but there is still more work to do to prove that it works.

SUMMARY

This chapter covered the basic information that all professional programmers should know about testing. Unit testing in particular is the easiest and most effective way to increase the quality of your own code. Higher-level tests provide coverage of use cases, synchronicity between modules, and protection against regressions. No matter what your role is with regard to testing, you should now be able to confidently design, create, and review tests at various levels.

Now that you know how to find bugs, it's time to learn how to fix them. To that end, Chapter 27 covers techniques and strategies for effective debugging.

27

Conquering Debugging

WHAT'S IN THIS CHAPTER?

- The fundamental law of debugging, and bug taxonomies
- Tips for avoiding bugs
- How to plan for bugs
- The different kinds of memory errors
- How to use a debugger to pinpoint code causing a bug

WROX.COM DOWNLOADS FOR THIS CHAPTER

Please note that all the code examples for this chapter are available as a part of this chapter's code download on the book's website at www.wrox.com/go/proc++4e on the Download Code tab.

Your code will contain bugs. Every professional programmer would like to write bug-free code, but the reality is that few software engineers succeed in this endeavor. As computer users know, bugs are endemic in computer software. The software that you write is probably no exception. Therefore, unless you plan to bribe your co-workers into fixing all your bugs, you cannot be a professional C++ programmer without knowing how to debug C++ code. One factor that often distinguishes experienced programmers from novices is their debugging skills.

Despite the obvious importance of debugging, it is rarely given enough attention in courses and books. Debugging seems to be the type of skill that everyone wants you to know, but no one knows how to teach. This chapter attempts to provide concrete debugging guidelines and techniques.

This chapter starts with the fundamental law of debugging and bug taxonomies, followed by tips for avoiding bugs. Techniques for planning for bugs include error logging, debug traces, assertions, and crash dumps. Specific tips are given for debugging the problems that arise, including techniques for reproducing bugs, debugging reproducible bugs, debugging nonreproducible bugs, debugging memory errors, and debugging multithreaded programs. The chapter concludes with a step-by-step debugging example.

THE FUNDAMENTAL LAW OF DEBUGGING

The first rule of debugging is to be honest with yourself and admit that your code will contain bugs! This realistic assessment enables you to put your best effort into preventing bugs from crawling into your code in the first place, while you simultaneously include the necessary features to make debugging as easy as possible.

WARNING *The fundamental law of debugging states that you should avoid bugs when you're coding, but plan for bugs in your code.*

BUG TAXONOMIES

A *bug* in a computer program is incorrect run-time behavior. This undesirable behavior includes both *catastrophic* and *noncatastrophic bugs*. Examples of catastrophic bugs are program death, data corruption, operating system failures, or some other horrific outcome. A catastrophic bug can also manifest itself external to the software or computer system running the software; for example, medical software might contain a catastrophic bug causing a massive radiation overdose to a patient. Noncatastrophic bugs are bugs that cause the program to behave incorrectly in more subtle ways; for example, a web browser might return the wrong web page, or a spreadsheet application might calculate the standard deviation of a column incorrectly.

There are also so-called *cosmetic bugs*, where something is visually not correct, but otherwise works correctly. For example, a button in a user interface is kept enabled when it shouldn't be, but clicking it does nothing. All computations are perfectly correct, the program does not crash, but it doesn't look as "nice" as it should.

The underlying cause, or *root cause*, of the bug is the mistake in the program that causes this incorrect behavior. The process of debugging a program includes both determining the root cause of the bug, and fixing the code so that the bug will not occur again.

AVOIDING BUGS

It's impossible to write completely bug-free code, so debugging skills are important. However, a few tips can help you to minimize the number of bugs.

- **Read this book from cover to cover:** Learn the C++ language intimately, especially pointers and memory management. Then, recommend this book to your friends and coworkers so they avoid bugs too.
- **Design before you code:** Designing *while* you code tends to lead to convoluted designs that are harder to understand and are more error-prone. It also makes you more likely to omit possible edge cases and error conditions.
- **Do code reviews:** In a professional environment, every single line of code should be peer-reviewed. Sometimes it takes a fresh perspective to notice problems.
- **Test, test, and test again:** Thoroughly test your code, and have *others* test your code! They are more likely to find problems you haven't thought of.
- **Write automated unit tests:** Unit tests are designed to test isolated functionality. You should write unit tests for all implemented features. Run these unit tests automatically as part of your continuous integration setup, or automatically after each local compilation. Chapter 26 discusses unit testing in detail.
- **Expect error conditions, and handle them appropriately:** In particular, plan for and handle errors when working with files. They will occur. See chapters 13 and 14.
- **Use smart pointers to avoid memory leaks:** Smart pointers automatically free resources when they are not needed anymore.
- **Don't ignore compiler warnings:** Configure your compiler to compile with a high warning level. Do not blindly ignore warnings. Ideally, you should enable an option in your compiler to treat warnings as errors. This forces you to address each warning.
- **Use static code analysis:** A static code analyzer helps you to pinpoint problems in your code by analyzing your source code. Ideally, static code analysis is done automatically by your build process to detect problems early.
- **Use good coding style:** Strive for readability and clarity, use meaningful names, don't use abbreviations, add code comments (not only interface comments), use the `override` keyword, and so on. This makes it easier for other people to understand your code.

PLANNING FOR BUGS

Your programs should contain features that enable easier debugging when the inevitable bugs arise. This section describes these features and presents sample implementations, where appropriate, that you can incorporate into your own programs.

Error Logging

Imagine this scenario: You have just released a new version of your flagship product, and one of the first users reports that the program “stopped working.” You attempt to pry more information from the user, and eventually discover that the program died in the middle of an operation. The user can't

quite remember what he was doing, or if there were any error messages. How will you debug this problem?

Now imagine the same scenario, but in addition to the limited information from the user, you are also able to examine the error log on the user's computer. In the log you see a message from your program that says, "Error: unable to open config.xml file." Looking at the code near the spot where that error message was generated, you find a line in which you read from the file without checking whether the file was opened successfully. You've found the root cause of your bug!

Error logging is the process of writing error messages to persistent storage so that they will be available following an application, or even machine, death. Despite the example scenario, you might still have doubts about this strategy. Won't it be obvious by your program's behavior if it encounters errors? Won't the user notice if something goes wrong? As the preceding example shows, user reports are not always accurate or complete. In addition, many programs, such as the operating system kernel and long-running daemons like `inetd` or `syslogd` on Unix, are not interactive and run unattended on a machine. The only way these programs can communicate with users is through error logging. In many cases, a program might also want to automatically recover from certain errors, and hide those errors from the user. Still, having logs of those errors available can be invaluable to improve the overall stability of the program.

Thus, your program should log errors as it encounters them. That way, if a user reports a bug, you will be able to examine the log files on the machine to see if your program reported any errors prior to encountering the bug. Unfortunately, error logging is platform dependent: C++ does not contain a standard logging mechanism. Examples of platform-specific logging mechanisms include the `syslog` facility in Unix, and the event reporting API in Windows. You should consult the documentation for your development platform. There are also some open-source implementations of cross-platform logging frameworks. Here are two examples:

- `log4cpp` at <http://log4cpp.sourceforge.net/>
- `Boost.Log` at <http://www.boost.org/>

Now that you're convinced that logging is a great feature to add to your programs, you might be tempted to log messages every few lines in your code so that, in the event of any bug, you'll be able to trace the code path that was executing. These types of log messages are appropriately called *traces*.

However, you should not write these traces to log files for two reasons. First, writing to persistent storage is slow. Even on systems that write the logs asynchronously, logging that much information will slow down your program. Second, and most important, most of the information that you would put in your traces is not appropriate for the end user to see. It will just confuse the user, leading to unwarranted service calls. That said, tracing is an important debugging technique under the correct circumstances, as described in the next section.

Here are some specific guidelines for the types of errors your programs should log:

- Unrecoverable errors, such as a system call failing unexpectedly.
- Errors for which an administrator can take action, such as low memory, an incorrectly formatted data file, an inability to write to disk, or a network connection being down.

- Unexpected errors such as a code path that you never expected to take or variables with unexpected values. Note that your code should “expect” users to enter invalid data and should handle it appropriately. An unexpected error represents a bug in your program.
- Potential security breaches, such as a network connection attempted from an unauthorized address, or too many network connections attempted (denial of service).

It is also useful to log warnings, or recoverable errors, which allows you to investigate if you can possibly avoid them.

Most logging APIs allow you to specify a *log level* or *error level*, typically error, warning, and info. You can log non-error conditions under a log level that is less severe than “error.” For example, you might want to log significant state changes in your application, or startup and shutdown of the program. You also might consider giving your users a way to adjust the log level of your program at run time so that they can customize the amount of logging that occurs.

Debug Traces

When debugging complicated problems, public error messages generally do not contain enough information. You often need a complete trace of the code path taken, or values of variables before the bug showed up. In addition to basic messages, it’s sometimes helpful to include the following information in debug traces:

- The thread ID, if it’s a multithreaded program
- The name of the function that generates the trace
- The name of the source file in which the code that generates the trace lives

You can add this tracing to your program through a special *debug mode*, or via a *ring buffer*. Both of these methods are explained in detail in the following sections. Note that in multithreaded programs you have to make your trace logging thread-safe. See Chapter 23 for details on multithreaded programming.

NOTE *Trace files can be written in text format, but if you do, be careful with logging too much detail. You don’t want to leak intellectual property through your log files! An alternative is to write the files in a format that only you can read.*

Debug Mode

The first technique to add debug traces is to provide a debug mode for your program. In debug mode, the program writes trace output to standard error or to a file, and perhaps does extra checking during execution. There are several ways to add a debug mode to your program. Note that all these examples are writing traces in text format.

Start-Time Debug Mode

Start-time debug mode allows your application to run with or without debug mode depending on a command-line argument. This strategy includes the debug code in the “release” binary, and allows debug mode to be enabled at a customer site. However, it does require users to restart the program in order to run it in debug mode, which may prevent you from obtaining useful information about certain bugs.

The following example is a simple program implementing a start-time debug mode. This program doesn’t do anything useful; it is only for demonstrating the technique.

All logging functionality is wrapped in a `Logger` class. This class has two `static` data members: the name of the log file, and a `Boolean` saying whether logging is enabled or disabled. The class has a `static public log()` variadic template method. Variadic templates are discussed in Chapter 22. Note that the log file is opened, flushed, and closed on each call to `log()`. This might lower performance a bit; however, it does guarantee correct logging, which is more important.

```
class Logger
{
public:
    static void enableLogging(bool enable) { msLoggingEnabled = enable; }
    static bool isLoggingEnabled() { return msLoggingEnabled; }

    template<typename... Args>
    static void log(const Args&... args)
    {
        if (!msLoggingEnabled)
            return;

        ofstream logfile(msDebugFileName, ios_base::app);
        if (logfile.fail()) {
            cerr << "Unable to open debug file!" << endl;
            return;
        }
        // Use a C++17 unary right fold, see Chapter 22.
        ((logfile << args),...);
        logfile << endl;
    }
private:
    static const string msDebugFileName;
    static bool msLoggingEnabled;
};

const string Logger::msDebugFileName = "debugfile.out";
bool Logger::msLoggingEnabled = false;
```

The following helper macro is defined to make it easy to log something. It uses `__func__`, a pre-defined variable defined by the C++ standard that contains the name of the current function.

```
#define log(...) Logger::log(__func__, "(): ", __VA_ARGS__)
```

This macro replaces every call to `log()` in your code with a call to `Logger::log()`. The macro automatically includes the function name as first argument to `Logger::log()`. For example, suppose you call the macro as follows:

```
log("The value is: ", value);
```

The `log()` macro replaces this with the following:

```
Logger::log(__func__, "(): ", "The value is: ", value);
```

Start-time debug mode needs to parse the command-line arguments to find out whether or not it should enable debug mode. Unfortunately, there is no standard functionality in C++ for parsing command-line arguments. This program uses a simple `isDebugSet()` function to check for the debug flag among all the command-line arguments, but a function to parse all command-line arguments would need to be more sophisticated.

```
bool isDebugSet(int argc, char* argv[])
{
    for (int i = 1; i < argc; i++) {
        if (strcmp(argv[i], "-d") == 0) {
            return true;
        }
    }
    return false;
}
```

Some arbitrary test code is used to exercise the debug mode in this example. Two classes are defined, `ComplicatedClass` and `UserCommand`. Both classes define an `operator<<` to write instances of them to a stream. The `Logger` class uses this operator to dump objects to the log file.

```
class ComplicatedClass { /* ... */ };
ostream& operator<<(ostream& ostr, const ComplicatedClass& src)
{
    ostr << "ComplicatedClass";
    return ostr;
}

class UserCommand { /* ... */ };
ostream& operator<<(ostream& ostr, const UserCommand& src)
{
    ostr << "UserCommand";
    return ostr;
}
```

Here is some test code with a number of log calls:

```
UserCommand getNextCommand(ComplicatedClass* obj)
{
    UserCommand cmd;
    return cmd;
}
```

```
void processUserCommand(UserCommand& cmd)
{
    // details omitted for brevity
}

void trickyFunction(ComplicatedClass* obj)
{
    log("given argument: ", *obj);

    for (size_t i = 0; i < 100; ++i) {
        UserCommand cmd = getNextCommand(obj);
        log("retrieved cmd ", i, ": ", cmd);

        try {
            processUserCommand(cmd);
        } catch (const exception& e) {
            log("exception from processUserCommand(): ", e.what());
        }
    }
}

int main(int argc, char* argv[])
{
    Logger::enableLogging(isDebugSet(argc, argv));

    if (Logger::isLoggingEnabled()) {
        // Print the command-line arguments to the trace
        for (int i = 0; i < argc; i++) {
            log(argv[i]);
        }
    }

    ComplicatedClass obj;
    trickyFunction(&obj);

    // Rest of the function not shown
    return 0;
}
```

There are two ways to run this application:

```
> STDebug
> STDebug -d
```

Debug mode is activated only when the `-d` argument is specified on the command line.

WARNING *Macros in C++ should be avoided as much as possible because they can be hard to debug. However, for logging purposes, using a simple macro is acceptable, and it makes using the logging code much easier.*

Compile-Time Debug Mode

Instead of enabling or disabling debug mode through a command-line argument, you could also use a preprocessor symbol such as `DEBUG_MODE` and `#ifdefs` to selectively compile the debug code into your program. In order to generate a debug version of this program, you would have to compile it with the symbol `DEBUG_MODE` defined. Your compiler should allow you to define symbols during compilation; consult your compiler's documentation for details. For example, GCC allows you to specify `-Dsymbol` through the command-line. Microsoft VC++ allows you to specify the symbols through the Visual Studio IDE, or by specifying `/D symbol` if you use the VC++ command-line tools. Visual C++ automatically defines the `_DEBUG` symbol for debug builds. However, that symbol is Visual C++ specific, so the example in this section uses a custom symbol called `DEBUG_MODE`.

The advantage of this method is that your debug code is not compiled into the “release” binary, and so does not increase its size. The disadvantage is that there is no way to enable debugging at a customer site for testing or following the discovery of a bug.

An example implementation is given in `CTDebug.cpp` in the downloadable source code archive. One important remark on this implementation is that it contains the following definition for the `log()` macro:

```
#ifdef DEBUG_MODE
    #define log(...) Logger::log(__func__, "(): ", __VA_ARGS__)
#else
    #define log(...)
#endif
```

That is, if `DEBUG_MODE` is not defined, then all calls to `log()` are replaced with nothing, called *no-ops*.

WARNING *Be careful not to put any code that must be executed for correct program functioning inside your `log()` calls. For example, the following line of code is probably asking for trouble:*

```
log("Result: ", myFunctionCall());
```

If `DEBUG_MODE` is not defined, the preprocessor replaces all `log()` calls with no-ops, which means that the call to `myFunctionCall()` is removed as well!

Run-Time Debug Mode

The most flexible way to provide a debug mode is to allow it to be enabled or disabled at run time. One way to provide this feature is to supply an asynchronous interface that controls debug mode on the fly. This interface could be an asynchronous command that makes an interprocess call into the application (for example, using sockets, signals, or remote procedure calls). This interface could also take the form of a menu command in the user interface. C++ provides no standard way to perform interprocess communication, so an example of this technique is not shown.

Ring Buffers

Debug mode is useful for debugging reproducible problems and for running tests. However, bugs often appear when the program is running in non-debug mode, and by the time you or the customer enables debug mode, it is too late to gain any information about the bug. One solution to this problem is to enable tracing in your program at all times. You usually need only the most recent traces to debug a program, so you should store only the most recent traces at any point in a program's execution. One way to provide for this is through careful use of log file rotations.

However, for performance reasons, it is better that your program doesn't log these traces continuously to disk. Instead, it should store them in memory and provide a mechanism to dump all the trace messages to standard error or to a log file if the need arises.

A common technique is to use a *ring buffer*, also known as a *circular buffer*, to store a fixed number of messages, or messages in a fixed amount of memory. When the buffer fills up, it starts writing messages at the beginning of the buffer again, overwriting the older messages. This cycle can repeat indefinitely. The following sections provide an implementation of a ring buffer and show you how you can use it in your programs.

Ring Buffer Interface

The following `RingBuffer` class provides a simple debug ring buffer. The client specifies the number of entries in the constructor, and adds messages with the `addEntry()` method. Once the number of entries exceeds the number allowed, new entries overwrite the oldest entries in the buffer. The buffer also provides the option to output entries to a stream as they are added to the buffer. The client can specify an output stream in the constructor, and can reset it with the `setOutput()` method. Finally, the `operator<<` streams the entire buffer to an output stream. This implementation uses a variadic template method. Variadic templates are discussed in Chapter 22.

```
class RingBuffer
{
public:
    // Constructs a ring buffer with space for numEntries.
    // Entries are written to *ostr as they are queued (optional).
    explicit RingBuffer(size_t numEntries = kDefaultNumEntries,
        std::ostream* ostr = nullptr);
    virtual ~RingBuffer() = default;

    // Adds an entry to the ring buffer, possibly overwriting the
    // oldest entry in the buffer (if the buffer is full).
    template<typename... Args>
    void addEntry(const Args&... args)
    {
        std::ostringstream os;
        // Use a C++17 unary right fold, see Chapter 22.
        ((os << args), ...);
        addStringEntry(os.str());
    }

    // Streams the buffer entries, separated by newlines, to ostr.
    friend std::ostream& operator<<(std::ostream& ostr, RingBuffer& rb);
};
```

```

        // Streams entries as they are added to the given stream.
        // Specify nullptr to disable this feature.
        // Returns the old output stream.
        std::ostream* setOutput(std::ostream* newOstr);

private:
    std::vector<std::string> mEntries;
    std::vector<std::string>::iterator mNext;

    std::ostream* mOstr;
    bool mWrapped;

    static const size_t kDefaultNumEntries = 500;

    void addStringEntry(std::string&& entry);
};

```

Ring Buffer Implementation

This implementation of the ring buffer stores a fixed number of `string` objects. This approach certainly is not the most efficient solution. Other possibilities would be to provide a fixed number of bytes of memory for the buffer. However, this implementation should be sufficient unless you're writing a high-performance application.

For multithreaded programs, it's useful to add the ID of the thread and a timestamp to each trace entry. Of course, the ring buffer has to be made thread-safe before using it in a multithreaded application. See Chapter 23 for multithreaded programming.

Here are the implementations:

```

// Initialize the vector to hold exactly numEntries. The vector size
// does not need to change during the lifetime of the object.
// Initialize the other members.
RingBuffer::RingBuffer(size_t numEntries, ostream* ostr)
    : mEntries(numEntries), mOstr(ostr), mWrapped(false)
{
    if (numEntries == 0)
        throw invalid_argument("Number of entries must be > 0.");
    mNext = begin(mEntries);
}

// The addStringEntry algorithm is pretty simple: add the entry to the next
// free spot, then reset mNext to indicate the free spot after
// that. If mNext reaches the end of the vector, it starts over at 0.
//
// The buffer needs to know if the buffer has wrapped or not so
// that it knows whether to print the entries past mNext in operator<<.
void RingBuffer::addStringEntry(string&& entry)
{
    // If there is a valid ostream, write this entry to it.
    if (mOstr) {
        *mOstr << entry << endl;
    }
}

```



```
// Move the entry to the next free spot and increment
// mNext to point to the free spot after that.
*mNext = std::move(entry);
++mNext;

// Check if we've reached the end of the buffer. If so, we need to wrap.
if (mNext == end(mEntries)) {
    mNext = begin(mEntries);
    mWrapped = true;
}
}

// Set the output stream.
ostream* RingBuffer::setOutput(ostream* newOstr)
{
    return std::exchange(mOstr, newOstr);
}

// operator<< uses an ostream_iterator to "copy" entries directly
// from the vector to the output stream.
//
// operator<< must print the entries in order. If the buffer has wrapped,
// the earliest entry is one past the most recent entry, which is the entry
// indicated by mNext. So, first print from entry mNext to the end.
//
// Then (even if the buffer hasn't wrapped) print from beginning to mNext-1.
ostream& operator<<(ostream& ostr, RingBuffer& rb)
{
    if (rb.mWrapped) {
        // If the buffer has wrapped, print the elements from
        // the earliest entry to the end.
        copy(rb.mNext, end(rb.mEntries), ostream_iterator<string>(ostr, "\n"));
    }

    // Now, print up to the most recent entry.
    // Go up to mNext because the range is not inclusive on the right side.
    copy(begin(rb.mEntries), rb.mNext, ostream_iterator<string>(ostr, "\n"));

    return ostr;
}
```

Using the Ring Buffer

In order to use the ring buffer, you can create an instance of it and start adding messages to it. When you want to print the buffer, just use `operator<<` to print it to the appropriate `ostream`. Here is the earlier start-time debug mode program modified to use a ring buffer instead. Changes are highlighted. The definitions of the `ComplicatedClass` and `UserCommand` classes, and the functions `getNextCommand()`, `processUserCommand()`, and `trickyFunction()` are not shown. They are exactly the same as before.

```
RingBuffer debugBuf;

#define log(...) debugBuf.addEntry(__func__, "(): ", __VA_ARGS__)
```

```

int main(int argc, char* argv[])
{
    // Log the command-line arguments
    for (int i = 0; i < argc; i++) {
        log(argv[i]);
    }

    ComplicatedClass obj;
    trickyFunction(&obj);

    // Print the current contents of the debug buffer to cout
    cout << debugBuf;

    return 0;
}

```

Displaying the Ring Buffer Contents

Storing trace debug messages in memory is a great start, but in order for them to be useful, you need a way to access these traces for debugging.

Your program should provide a “hook” to tell it to export the messages. This hook could be similar to the interface you would use to enable debugging at run time. Additionally, if your program encounters a fatal error that causes it to exit, it could export the ring buffer automatically to a log file before exiting.

Another way to retrieve these messages is to obtain a memory dump of the program. Each platform handles memory dumps differently, so you should consult a reference or expert for your platform.

Assertions

The `<cassert>` header defines an `assert` macro. It takes a Boolean expression and, if the expression evaluates to `false`, prints an error message and terminates the program. If the expression evaluates to `true`, it does nothing.

WARNING *Normally, you should avoid any library functions or macros that can terminate your program. The `assert` macro is an exception. If an assertion triggers, it means that some assumption is wrong or that something is catastrophically, unrecoverably wrong, and the only sane thing to do is to terminate the application at that very moment, instead of continuing.*

Assertions allow you to “force” your program to exhibit a bug at the exact point where that bug originates. If you didn’t `assert` at that point, your program might proceed with those incorrect values, and the bug might not show up until much later. Thus, assertions allow you to detect bugs earlier than you otherwise would.

NOTE *The behavior of the standard `assert` macro depends on the `NDEBUG` pre-processor symbol: if the symbol is not defined, the assertion takes place; otherwise it is ignored. Compilers often define this symbol when compiling “release” builds. If you want to leave assertions in release builds, you may have to change your compiler settings, or write your own version of `assert` that isn’t affected by the value of `NDEBUG`.*

You could use assertions in your code whenever you are “assuming” something about the state of your variables. For example, if you call a library function that is supposed to return a pointer and claims never to return `nullptr`, throw in an `assert` after the function call to make sure that the pointer isn’t `nullptr`.

Note that you should assume as little as possible. For example, if you are writing a library function, don’t assert that the parameters are valid. Instead, check the parameters, and return an error code or throw an exception if they are invalid.

As a rule, assertions should only be used for cases that are truly problematic, and should therefore never be ignored when they occur during development. If you hit an assertion during development, fix it, don’t just disable the assertion.

WARNING *Be careful not to put any code that must be executed for correct program functioning inside assertions. For example, the following line of code is probably asking for trouble:*

```
assert(myFunctionCall() != nullptr);
```

If a release build of your code strips assertions, then the call to `myFunctionCall()` is stripped as well!

Crash Dumps

Make sure your programs create *crash dumps*, also called *memory dumps*, *core dumps*, and so on. A crash dump is a dump file that is created when your application crashes. It contains information about which threads were running at the time of the crash, a call stack of all the threads, and so on. How you create such dumps is platform dependent, so you should consult the documentation of your platform, or use a third-party library that takes care of it for you. Breakpad¹ is an example of such an open-source cross-platform library that can write and process crash dumps.

Also make sure you set up a *symbol server* and a *source code server*. The symbol server is used to store debugging symbols of released binaries of your software. These symbols are used later on to interpret crash dumps received from customers. The source code server, discussed in Chapter 24, stores all revisions of your source code. When debugging crash dumps, this source code server is

¹<https://github.com/google/breakpad/>

used to download the correct source code for the revision of your software that created the crash dump.

The exact procedure of analyzing crash dumps depends on your platform and compiler, so consult their documentation.

From my personal experience, I have found that a crash dump is often worth more than a thousand bug reports.

STATIC ASSERTIONS

The assertions discussed earlier in this chapter are evaluated at run time. `static_assert()` allows assertions evaluated at compile time. A call to `static_assert()` accepts two parameters: an expression to evaluate at compile time and a string. When the expression evaluates to `false`, the compiler issues an error that contains the given string. A simple example could be to check that you are compiling with a 64-bit compiler:

```
static_assert(sizeof(void*) == 8, "Requires 64-bit compilation.");
```

If you compile this with a 32-bit compiler where a pointer is four bytes, the compiler issues an error that can look like this:

```
test.cpp(3): error C2338: Requires 64-bit compilation.
```

Since C++17, the string parameter is optional, as in this example:

```
static_assert(sizeof(void*) == 8);
```

In this case, if the expression evaluates to `false`, you get a compiler-dependent error message. For example, Microsoft Visual C++ 2017 gives the following error:

```
test.cpp(3): error C2607: static assertion failed
```

Another example where `static_asserts` are pretty powerful is in combination with type traits, which are discussed in Chapter 22. For example, if you write a function template or class template, you could use `static_asserts` together with type traits to issue compiler errors when template types don't satisfy certain conditions. The following example requires that the template type for the `process()` function template has `Base1` as a base class:

```
class Base1 {};
class Base1Child : public Base1 {};

class Base2 {};
class Base2Child : public Base2 {};

template<typename T>
void process(const T& t)
{
    static_assert(is_base_of_v<Base1, T>, "Base1 should be a base for T.");
}
```

```
int main()
{
    process(Base1());
    process(Base1Child());
    //process(Base2()); // Error
    //process(Base2Child()); // Error
}
```

If you try to call `process()` with an instance of `Base2` or `Base2Child`, the compiler issues an error that could look like this:

```
test.cpp(13): error C2338: Base1 should be a base for T.
test.cpp(21) : see reference to function template
instantiation 'void process<Base2>(const T &)' being compiled
with
[
    T=Base2
]
```

DEBUGGING TECHNIQUES

Debugging a program can be incredibly frustrating. However, with a systematic approach it becomes significantly easier. Your first step in trying to debug a program should always be to reproduce the bug. Depending on whether or not you can reproduce the bug, your subsequent approach will differ. The next four sections explain how to reproduce bugs, how to debug reproducible bugs, how to debug nonreproducible bugs, and how to debug regressions. Additional sections explain details about debugging memory errors and debugging multithreaded programs.

Reproducing Bugs

If you can reproduce the bug consistently, it will be much easier to determine the root cause. Finding the root cause of bugs that are not reproducible is difficult, if not impossible.

As a first step to reproduce the bug, run the program with exactly the same inputs as the run when the bug first appeared. Be sure to include all inputs, from the program's startup to the time of the bug's appearance. A common mistake is to attempt to reproduce the bug by performing only the triggering action. This technique may not reproduce the bug because the bug might be caused by an entire sequence of actions.

For example, if your web browser program dies when you request a certain web page, it may be due to memory corruption triggered by that particular request's network address. On the other hand, it may be because your program records all requests in a queue, with space for one million entries, and this entry was number one million and one. Starting the program over and sending one request certainly wouldn't trigger the bug in that case.

Sometimes it is impossible to emulate the entire sequence of events that leads to the bug. Perhaps the bug was reported by someone who can't remember everything that she did. Alternatively, maybe the program was running for too long to emulate every input. In that case, do your best to reproduce the bug. It takes some guesswork, and can be time-consuming, but effort at this point will save time later in the debugging process. Here are some techniques you can try:

- Repeat the triggering action in the correct environment and with as many inputs as possible similar to the initial report.
- Do a quick review of the code related to the bug. More often than not, you'll find a likely cause that will guide you in reproducing the problem.
- Run automated tests that exercise similar functionality. Reproducing bugs is one benefit of automated tests. If it takes 24 hours of testing before the bug shows up, it's preferable to let those tests run on their own rather than spend 24 hours of your time trying to reproduce the bug.
- If you have the necessary hardware available, running slight variations of tests concurrently on different machines can sometimes save time.
- Run stress tests that exercise similar functionality. If your program is a web server that died on a particular request, try running as many browsers as possible simultaneously that make that request.

After you are able to reproduce the bug consistently, you should attempt to find the smallest sequence that triggers the bug. You can start with the minimum sequence, containing only the triggering action, and slowly expand the sequence to cover the entire sequence from startup until the bug is triggered. This will result in the simplest and most efficient test case to reproduce it, which makes it simpler to find the root cause of the problem, and easier to verify the fix.

Debugging Reproducible Bugs

When you can reproduce a bug consistently and efficiently, it's time to figure out the problem in the code that causes the bug. Your goal at this point is to find the exact lines of code that trigger the problem. You can use two different strategies.

1. **Logging debug messages:** By adding enough debug messages to your program and watching its output when you reproduce the bug, you should be able to pinpoint the exact lines of code where the bug occurs. If you have a debugger at your disposal, adding debug messages is usually not recommended because it requires modifications to the program and can be time-consuming. However, if you have already instrumented your program with debug messages as described earlier, you might be able to find the root cause of your bug by running your program in debug mode while reproducing the bug. Note that bugs sometimes disappear simply when you enable logging because the act of enabling logging can slightly change the timings of your application.
2. **Using a debugger:** Debuggers allow you to step through the execution of your program and to view the state of memory and the values of variables at various points. They are often indispensable tools for finding the root cause of bugs. When you have access to the source code, you will use a *symbolic debugger*: a debugger that utilizes the variable names, class names, and other symbols in your code. In order to use a symbolic debugger, you must instruct your compiler to generate debug symbols. Check the documentation of your compiler for details on how to enable symbol generation.

The debugging example at the end of this chapter demonstrates both these approaches.

Debugging Nonreproducible Bugs

Fixing bugs that are not reproducible is significantly more difficult than fixing reproducible bugs. You often have very little information and must employ a lot of guesswork. Nevertheless, a few strategies can aid you.

1. Try to turn a nonreproducible bug into a reproducible bug. By using educated guesses, you can often determine approximately where the bug lies. It's worthwhile to spend some time trying to reproduce the bug. Once you have a reproducible bug, you can figure out its root cause by using the techniques described earlier.
2. Analyze error logs. This is easy to do if you have instrumented your program with error log generation, as described earlier. You should sift through this information because any errors that were logged directly before the bug occurred are likely to have contributed to the bug itself. If you're lucky (or if you coded your program well), your program will have logged the exact reason for the bug at hand.
3. Obtain and analyze traces. Again, this is easy to do if you have instrumented your program with tracing output, for example, via a ring buffer as described earlier. At the time of the bug's occurrence, you hopefully obtained a copy of the traces. These traces should lead you right to the location of the bug in your code.
4. Examine a *crash/memory dump* file, if it exists. Some platforms generate memory dump files of applications that terminate abnormally. On Unix and Linux, these memory dumps are called *core files*. Each platform provides tools for analyzing these memory dumps. They can, for example, be used to generate a stack trace of the application, or to view the contents of its memory before the application died.
5. Inspect the code. Unfortunately, this is often the only strategy to determine the cause of a nonreproducible bug. Surprisingly, it often works. When you examine code, even code that you wrote yourself, with the perspective of the bug that just occurred, you can often find mistakes that you overlooked previously. I don't recommend spending hours staring at your code, but tracing through the code path manually can often lead you directly to the problem.
6. Use a memory-watching tool, such as one of those described in the section "Debugging Memory Problems," later in this chapter. Such tools often alert you to memory errors that don't always cause your program to misbehave, but could potentially be the cause of the bug in question.
7. File or update a bug report. Even if you can't find the root cause of the bug right away, the report will be a useful record of your attempts if the problem is encountered again.
8. If you are unable to find the root cause of the bug, be sure to add extra logging or tracing, so that you will have a better chance next time the bug occurs.

Once you have found the root cause of a nonreproducible bug, you should create a reproducible test case and move it to the "reproducible bugs" category. It is important to be able to reproduce a bug before you actually fix it. Otherwise, how will you test the fix? A common mistake when debugging

nonreproducible bugs is to fix the wrong problem in the code. Because you can't reproduce the bug, you don't know if you've really fixed it, so you shouldn't be surprised when it shows up again a month later.

Debugging Regressions

If a feature contains a *regression* bug, it means that the feature used to work correctly, but stopped working due to the introduction of a bug.

A useful debugging technique for investigating regressions is to look at the change log of relevant files. If you know at what time the feature was still working, look at all the change logs since that time. You might notice something suspicious that could lead you to the root cause.

Another approach that can save you a lot of time when debugging regressions is to use a binary search approach with older versions of the software to try and figure out when it started to go wrong. You can use binaries of older versions if you keep them, or revert the source code to an older revision. Once you know when it started to go wrong, inspect the change logs to see what changed at that time. This mechanism is only possible when you can reproduce the bug.

Debugging Memory Problems

Most catastrophic bugs, such as application death, are caused by memory errors. Many non-catastrophic bugs are triggered by memory errors as well. Some memory bugs are obvious. If your program attempts to dereference a `nullptr` pointer, the default action is to terminate the program. However, nearly every platform enables you to respond to catastrophic errors and take remedial action. The amount of effort you devote to the response depends on the importance of this kind of recovery to your end users. For example, a text editor really needs to make a best attempt to save the modified buffers (possibly under a “recovered” name), while for other programs, users may find the default behavior acceptable, even if it is unpleasant.

Some memory bugs are more insidious. If you write past the end of an array in C++, your program will probably not crash at that point. However, if that array was on the stack, you may have written into a different variable or array, changing values that won't show up until later in the program. Alternatively, if the array was on the heap, you could cause memory corruption in the heap, which will cause errors later when you attempt to allocate or free more memory dynamically.

Chapter 7 introduces some of the common memory errors from the perspective of what to avoid when you're coding. This section discusses memory errors from the perspective of identifying problems in code that exhibits bugs. You should be familiar with the discussion in Chapter 7 before continuing with this section.

WARNING *Most, if not all, of the following memory problems can be avoided by using smart pointers instead of raw pointers.*

Categories of Memory Errors

In order to debug memory problems, you should be familiar with the types of errors that can occur. This section describes the major categories of memory errors. Each category lists different types of memory errors, including a small code example demonstrating each error, and a list of possible *symptoms* that you might observe. Note that a symptom is not the same thing as a bug: a symptom is an observable behavior caused by a bug.

Memory-Freeing Errors

The following table summarizes five major errors that involve freeing memory.

ERROR TYPE	SYMPTOMS	EXAMPLE
Memory leak	<p>Process memory usage grows over time.</p> <p>Process runs more slowly over time.</p> <p>Eventually, depending on the OS, operations and system calls fail because of lack of memory.</p>	<pre>void memoryLeak() { int* p = new int[1000]; return; // Bug! Not freeing p. }</pre>
Using mismatched allocation and free operations	<p>Does not usually cause a crash immediately.</p> <p>This type of error can cause memory corruption on some platforms, which might show up as a crash later in the program.</p> <p>Certain mismatches can also cause memory leaks.</p>	<pre>void mismatchedFree() { int* p1 = (int*)malloc(sizeof(int)); int* p2 = new int; int* p3 = new int[1000]; delete p1; // BUG! Should use free() delete[] p2; // BUG! Should use delete free(p3); // BUG! Should use delete[] }</pre>
Freeing memory more than once	<p>Can cause a crash if the memory at that location has been handed out in another allocation between the two calls to delete.</p>	<pre>void doubleFree() { int* p1 = new int[1000]; delete[] p1; int* p2 = new int[1000]; delete[] p1; // BUG! freeing p1 twice } // BUG! Leaking memory of p2</pre>

ERROR TYPE	SYMPTOMS	EXAMPLE
Freeing unallocated memory	Will usually cause a crash.	<pre>void freeUnallocated() { int* p = reinterpret_cast<int*>(10000); delete p; // BUG! p not a valid pointer. }</pre>
Freeing stack memory	Technically a special case of freeing unallocated memory. This will usually cause a crash.	<pre>void freeStack() { int x; int* p = &x; delete p; // BUG! Freeing stack memory }</pre>

The crashes mentioned in this table can have different manifestations depending on your platform, such as segmentation faults, bus errors, access violations, and so on.

As you can see, some of the errors do not cause immediate program termination. These bugs are more subtle, leading to problems later in the program's execution.

Memory-Access Errors

Another category of memory errors involves the actual reading and writing of memory.

ERROR TYPE	SYMPTOMS	EXAMPLE
Accessing invalid memory	Almost always causes the program to crash immediately.	<pre>void accessInvalid() { int* p = reinterpret_cast<int*>(10000); *p = 5; // BUG! p is not a valid pointer. }</pre>
Accessing freed memory	Does not usually cause a program crash. If the memory has been handed out in another allocation, this error type can cause "strange" values to appear unexpectedly.	<pre>void accessFreed() { int* p1 = new int; delete p1; int* p2 = new int; *p1 = 5; // BUG! The memory pointed to // by p1 has been freed. }</pre>

continues

(continued)

ERROR TYPE	SYMPTOMS	EXAMPLE
Accessing memory in a different allocation	Does not cause a crash. This error type can cause “strange” and potentially dangerous values to appear unexpectedly.	<pre>void accessElsewhere() { int x, y[10], z; x = 0; z = 0; for (int i = 0; i <= 10; i++) { y[i] = 5; // BUG for i==10! element 10 // is past end of array. } }</pre>
Reading uninitialized memory	Does not cause a crash, unless you use the uninitialized value as a pointer and dereference it (as in the example). Even then, it will not always cause a crash.	<pre>void readUninitialized() { int* p; cout << *p; // BUG! p is uninitialized }</pre>

Memory-access errors don’t always cause a crash. They can instead lead to subtle errors, in which the program does not terminate but instead produces erroneous results. Erroneous results can lead to serious consequences, for example, when external devices (such as robotic arms, X-ray machines, radiation treatments, life support systems, and so on) are being controlled by the computer.

Note that the symptoms discussed here for both memory-freeing errors and memory-access errors are the default symptoms for release builds of your program. Debug builds will most likely behave differently, and when you run the program inside a debugger, the debugger might break into the code when an error occurs.

Tips for Debugging Memory Errors

Memory-related bugs often show up in slightly different places in the code each time you run the program. This is usually the case with heap memory corruption. Heap memory corruption is like a time bomb, ready to explode at some attempt to allocate, free, or use memory on the heap. So, when you see a bug that is reproducible, but that shows up in slightly different places, you should suspect memory corruption.

If you suspect a memory bug, your best option is to use a memory-checking tool for C++. Debuggers often provide options to run the program while checking for memory errors. For example, if you run a debug build of your application in the Microsoft Visual C++ debugger, it will catch almost all types of errors discussed in the previous sections. Additionally, there are some excellent third-party tools such as Purify from Rational Software (now owned by IBM) and Valgrind for Linux (discussed in Chapter 7). Microsoft also provides a free download called *Application Verifier*, which can be used with release builds of your applications in a Windows environment. It is a run-time verification tool to help you find subtle programming errors like the previously discussed memory errors. These debuggers and tools work by interposing their own memory-allocation and -freeing routines in order to check for any misuse of dynamic memory, such as freeing unallocated memory, dereferencing unallocated memory, or writing off the end of an array.

If you don't have a memory-checking tool at your disposal, and the normal strategies for debugging are not helping, you may need to resort to code inspection. First, narrow down the part of the code containing the bug. Then, as a general rule, look at all raw pointers. Provided that you work on moderate- to good-quality code, most pointers should already be wrapped in smart pointers. If you do encounter raw pointers, take a closer look at how they are used, because they might be the cause of the error. Here are some more items to look for in your code.

Object and Class-Related Errors

- Verify that your classes with dynamically allocated memory have destructors that free exactly the memory that's allocated in the object: no more, and no less.
- Ensure that your classes handle copying and assignment correctly with copy constructors and assignment operators, as described in Chapter 9. Make sure move constructors and move assignment operators properly set pointers in the source object to `nullptr` so that their destructors don't try to free that memory.
- Check for suspicious casts. If you are casting a pointer to an object from one type to another, make sure that it's valid. When possible, use `dynamic_casts`.

WARNING *Whenever you see raw pointers being used to handle ownership of resources, I highly recommend you to replace those raw pointers with smart pointers, and to try to refactor your classes to follow the rule of zero, as discussed in Chapter 9. This removes the types of errors explained in the first and second bullet in the preceding list.*

General Memory Errors

- Make sure that every call to `new` is matched with exactly one call to `delete`. Similarly, every call to `malloc`, `alloc`, or `calloc` should be matched with one call to `free`, and every call to `new[]` should be matched with one call to `delete[]`. To avoid freeing memory multiple times or using freed memory, it's recommended to set your pointer to `nullptr` after freeing its memory. Of course, the best solution is to avoid using raw pointers to handle ownership of resources, and instead use smart pointers.

- Check for buffer overruns. Whenever you iterate over an array or write into or read from a C-style string, verify that you are not accessing memory past the end of the array or string. These problems can often be avoided by using Standard Library containers and strings.
- Check for dereferencing of invalid pointers.
- When declaring a pointer on the stack, make sure you always initialize it as part of its declaration. For example, use `T* p = nullptr;` or `T* p = new T;` but never `T* p;`. Better yet, use smart pointers!
- Similarly, make sure your classes always initialize pointer data members with in-class initializers or in their constructors, by either allocating memory in the constructor or setting the pointers to `nullptr`. Also here, the best solution is to use smart pointers.

Debugging Multithreaded Programs

C++ includes a threading support library that provides mechanisms for threading and synchronization between threads. This threading support library is discussed in Chapter 23. Multithreaded C++ programs are common, so it is important to think about the special issues involved in debugging a multithreaded program. Bugs in multithreaded programs are often caused by variations in timings in the operating system scheduling, and can be difficult to reproduce. Thus, debugging multithreaded programs requires a special set of techniques.

- 1. Use a debugger:** A debugger makes it relatively easy to diagnose certain multithreaded problems, for example, deadlocks. When the deadlock appears, break into the debugger and inspect the different threads. You will be able to see which threads are blocked and on which line in the code they are blocked. Combining this with trace logs that show you how you came into the deadlock situation should be enough to fix deadlocks.
- 2. Use log-based debugging:** When debugging multithreaded programs, log-based debugging can sometimes be more effective than using a debugger to debug certain problems. You can add log statements to your program before and after critical sections, and before acquiring and after releasing locks. Log-based debugging is extremely useful in investigating race conditions. However, the act of adding log statements slightly changes run-time timings, which might hide the bug.
- 3. Insert forced sleeps and context switches:** If you are having trouble consistently reproducing the problem, or you have a hunch about the root cause but want to verify it, you can force certain thread-scheduling behavior by making your threads sleep for specific amounts of time. The `<thread>` header defines `sleep_until()` and `sleep_for()` in the `std::this_thread` namespace, which you can use to sleep. The time to sleep is specified as an `std::time_point` or an `std::duration` respectively, both part of the chrono library discussed in Chapter 20. Sleeping for several seconds right before releasing a lock, immediately before signaling a condition variable, or directly before accessing shared data can reveal race conditions that would otherwise go undetected. If this debugging technique reveals the root cause, it must be fixed, so that it works correctly after removing these forced sleeps and context switches. Never leave these forced sleeps and context switches in your code! That would be the wrong “fix” for the problem.

4. **Perform code review:** Reviewing your thread synchronization code often helps in fixing race conditions. Try to prove over and over that what happened is not possible, until you see how it is. It doesn't hurt to write down these "proofs" in code comments. Also, ask a coworker to do pair debugging; she might see something you are overlooking.

Debugging Example: Article Citations

This section presents a buggy program and shows you the steps to take in order to debug it and fix the problem.

Suppose that you're part of a team writing a web page that allows users to search for the research articles that cite a particular paper. This type of service is useful for authors who are trying to find work similar to their own. Once they find one paper representing a related work, they can look for every paper that cites that one to find other related work.

In this project, you are responsible for the code that reads the raw citation data from text files. For simplicity, assume that the citation information for each paper is found in its own file. Furthermore, assume that the first line of each file contains the author, title, and publication information for the paper; that the second line is always empty; and that all subsequent lines contain the citations from the article (one on each line). Here is an example file for one of the most important papers in computer science:

```
Alan Turing, "On Computable Numbers, with an Application to the
Entscheidungsproblem", Proceedings of the London Mathematical Society, Series 2,
Vol.42 (1936-37), 230-265.
```

```
Gödel, "Über formal unentscheidbare Sätze der Principia Mathematica und verwandter
Systeme, I", Monatshefte Math. Phys., 38 (1931), 173-198.
```

```
Alonzo Church. "An unsolvable problem of elementary number theory", American J. of
Math., 58 (1936), 345-363.
```

```
Alonzo Church. "A note on the Entscheidungsproblem", J. of Symbolic Logic, 1
(1936), 40-41.
```

```
E.W. Hobson, "Theory of functions of a real variable (2nd ed., 1921)", 87-88.
```

Buggy Implementation of an ArticleCitations Class

You may decide to structure your program by writing an `ArticleCitations` class that reads the file and stores the information. This class stores the article information from the first line in one string, and the citations in a C-style array of strings.

WARNING *The design decision to use a C-style array is a very bad one! You should opt for one of the Standard Library containers to store the citations. This is just used here as a demonstration of memory problems. There are other obvious issues with this implementation, such as using `int` instead of `size_t`, and not using the copy-and-swap idiom (see Chapter 9) to implement the assignment operator. However, for the purpose of illustrating buggy applications, it's perfect.*

The ArticleCitations class definition looks like this:

```
class ArticleCitations
{
public:
    ArticleCitations(std::string_view fileName);
    virtual ~ArticleCitations();
    ArticleCitations(const ArticleCitations& src);
    ArticleCitations& operator=(const ArticleCitations& rhs);

    std::string_view getArticle() const { return mArticle; }
    int getNumCitations() const { return mNumCitations; }
    std::string_view getCitation(int i) const { return mCitations[i]; }
private:
    void readFile(std::string_view fileName);
    void copy(const ArticleCitations& src);

    std::string mArticle;
    std::string* mCitations;
    int mNumCitations;
};
```

The implementation is as follows. Keep in mind that this program is buggy! Don't use it verbatim or as a model.

```
ArticleCitations::ArticleCitations(string_view fileName)
    : mCitations(nullptr), mNumCitations(0)
{
    // All we have to do is read the file.
    readFile(fileName);
}

ArticleCitations::ArticleCitations(const ArticleCitations& src)
{
    copy(src);
}

ArticleCitations& ArticleCitations::operator=(const ArticleCitations& rhs)
{
    // Check for self-assignment.
    if (this == &rhs) {
        return *this;
    }
    // Free the old memory.
    delete [] mCitations;
    // Copy the data
    copy(rhs);
    return *this;
}

void ArticleCitations::copy(const ArticleCitations& src)
{
    // Copy the article name, author, etc.
    mArticle = src.mArticle;
    // Copy the number of citations
    mNumCitations = src.mNumCitations;
    // Allocate an array of the correct size
```

```

        mCitations = new string[mNumCitations];
        // Copy each element of the array
        for (int i = 0; i < mNumCitations; i++) {
            mCitations[i] = src.mCitations[i];
        }
    }

ArticleCitations::~ArticleCitations()
{
    delete [] mCitations;
}

void ArticleCitations::readFile(string_view fileName)
{
    // Open the file and check for failure.
    ifstream inputFile(fileName.data());
    if (inputFile.fail()) {
        throw invalid_argument("Unable to open file");
    }
    // Read the article author, title, etc. line.
    getline(inputFile, mArticle);

    // Skip the white space before the citations start.
    inputFile >> ws;

    int count = 0;
    // Save the current position so we can return to it.
    streampos citationsStart = inputFile.tellg();
    // First count the number of citations.
    while (!inputFile.eof()) {
        // Skip white space before the next entry.
        inputFile >> ws;
        string temp;
        getline(inputFile, temp);
        if (!temp.empty()) {
            count++;
        }
    }

    if (count != 0) {
        // Allocate an array of strings to store the citations.
        mCitations = new string[count];
        mNumCitations = count;
        // Seek back to the start of the citations.
        inputFile.seekg(citationsStart);
        // Read each citation and store it in the new array.
        for (count = 0; count < mNumCitations; count++) {
            string temp;
            getline(inputFile, temp);
            if (!temp.empty()) {
                mCitations[count] = temp;
            }
        }
    } else {
        mNumCitations = -1;
    }
}

```

Testing the ArticleCitations class

The following program asks the user for a filename, constructs an `ArticleCitations` instance for that file, and passes this instance by value to the `processCitations()` function, which prints out all the information:

```
void processCitations(ArticleCitations cit)
{
    cout << cit.getArticle() << endl;
    int num = cit.getNumCitations();
    for (int i = 0; i < num; i++) {
        cout << cit.getCitation(i) << endl;
    }
}

int main()
{
    while (true) {
        cout << "Enter a file name (\\"STOP\\" to stop): ";
        string fileName;
        cin >> fileName;
        if (fileName == "STOP") {
            break;
        }

        ArticleCitations cit(fileName);
        processCitations(cit);
    }
    return 0;
}
```

You decide to test the program on the Alan Turing example (stored in a file called `paper1.txt`). Here is the output:

```
Enter a file name ("STOP" to stop): paper1.txt
Alan Turing, "On Computable Numbers, with an Application to the
Entscheidungsproblem", Proceedings of the London Mathematical Society, Series 2,
Vol.42 (1936-37), 230-265.
[ 4 empty lines omitted for brevity ]
Enter a file name ("STOP" to stop): STOP
```

That doesn't look right. There are supposed to be four citations printed instead of four blank lines.

Message-Based Debugging

For this bug, you decide to try log-based debugging, and because this is a console application, you decide to just print messages to `cout`. In this case, it makes sense to start by looking at the function that reads the citations from the file. If that doesn't work right, then obviously the object won't have the citations. You can modify `readFile()` as follows:

```
void ArticleCitations::readFile(string_view fileName)
{
    // Code omitted for brevity

    // First count the number of citations.
```

```

cout << "readFile(): counting number of citations" << endl;
while (!inputFile.eof()) {
    // Skip white space before the next entry.
    inputFile >> ws;
    string temp;
    getline(inputFile, temp);
    if (!temp.empty()) {
        cout << "Citation " << count << ": " << temp << endl;
        count++;
    }
}

cout << "Found " << count << " citations" << endl;
cout << "readFile(): reading citations" << endl;
if (count != 0) {
    // Allocate an array of strings to store the citations.
    mCitations = new string[count];
    mNumCitations = count;
    // Seek back to the start of the citations.
    inputFile.seekg(citationsStart);
    // Read each citation and store it in the new array.
    for (count = 0; count < mNumCitations; count++) {
        string temp;
        getline(inputFile, temp);
        if (!temp.empty()) {
            cout << temp << endl;
            mCitations[count] = temp;
        }
    }
} else {
    mNumCitations = -1;
}
cout << "readFile(): finished" << endl;
}

```

Running the same test with this program gives the following output:

```

Enter a file name ("STOP" to stop): paper1.txt
readFile(): counting number of citations
Citation 0: Gödel, "Über formal unentscheidbare Sätze der Principia Mathematica und
verwandter Systeme, I", Monatshefte Math. Phys., 38 (1931), 173-198.
Citation 1: Alonzo Church. "An unsolvable problem of elementary number theory",
American J. of Math., 58 (1936), 345-363.
Citation 2: Alonzo Church. "A note on the Entscheidungsproblem", J. of Symbolic
Logic, 1 (1936), 40-41.
Citation 3: E.W. Hobson, "Theory of functions of a real variable (2nd ed., 1921)",
87-88.
Found 4 citations
readFile(): reading citations
readFile(): finished
Alan Turing, "On Computable Numbers, with an Application to the
Entscheidungsproblem", Proceedings of the London Mathematical Society, Series 2,
Vol.42 (1936-37), 230-265.
[ 4 empty lines omitted for brevity ]
Enter a file name ("STOP" to stop): STOP

```

As you can see from the output, the first time the program reads the citations from the file, in order to count them, it reads them correctly. However, the second time, they are not read correctly; nothing is printed between “readFile(): reading citations” and “readFile(): finished”. Why not? One way to delve deeper into this issue is to add some debugging code to check the state of the file stream after each attempt to read a citation:

```
void printStreamState(const istream& inputStream)
{
    if (inputStream.good()) {
        cout << "stream state is good" << endl;
    }
    if (inputStream.bad()) {
        cout << "stream state is bad" << endl;
    }
    if (inputStream.fail()) {
        cout << "stream state is fail" << endl;
    }
    if (inputStream.eof()) {
        cout << "stream state is eof" << endl;
    }
}

void ArticleCitations::readFile(string_view fileName)
{
    // Code omitted for brevity

    // First count the number of citations.
    cout << "readFile(): counting number of citations" << endl;
    while (!inputFile.eof()) {
        // Skip white space before the next entry.
        inputFile >> ws;
        printStreamState(inputFile);
        string temp;
        getline(inputFile, temp);
        printStreamState(inputFile);
        if (!temp.empty()) {
            cout << "Citation " << count << ": " << temp << endl;
            count++;
        }
    }

    cout << "Found " << count << " citations" << endl;
    cout << "readFile(): reading citations" << endl;
    if (count != 0) {
        // Allocate an array of strings to store the citations.
        mCitations = new string[count];
        mNumCitations = count;
        // Seek back to the start of the citations.
        inputFile.seekg(citationsStart);
        // Read each citation and store it in the new array.
        for (count = 0; count < mNumCitations; count++) {
            string temp;
            getline(inputFile, temp);
            printStreamState(inputFile);
        }
    }
}
```

```

        if (!temp.empty()) {
            cout << temp << endl;
            mCitations[count] = temp;
        }
    }
} else {
    mNumCitations = -1;
}
cout << "readFile(): finished" << endl;
}

```

When you run your program this time, you find some interesting information:

```

Enter a file name ("STOP" to stop): paper1.txt
readFile(): counting number of citations
stream state is good
stream state is good
Citation 0: Gödel, "Über formal unentscheidbare Sätze der Principia Mathematica und
verwandter Systeme, I", Monatshefte Math. Phys., 38 (1931), 173-198.
stream state is good
stream state is good
Citation 1: Alonzo Church. "An unsolvable problem of elementary number theory",
American J. of Math., 58 (1936), 345-363.
stream state is good
stream state is good
Citation 2: Alonzo Church. "A note on the Entscheidungsproblem", J. of Symbolic
Logic, 1 (1936), 40-41.
stream state is good
stream state is good
Citation 3: E.W. Hobson, "Theory of functions of a real variable (2nd ed., 1921)",
87-88.
stream state is eof
stream state is fail
stream state is eof
Found 4 citations
readFile(): reading citations
stream state is fail
stream state is fail
stream state is fail
stream state is fail
readFile(): finished
Alan Turing, "On Computable Numbers, with an Application to the
Entscheidungsproblem", Proceedings of the London Mathematical Society, Series 2,
Vol.42 (1936-37), 230-265.
[ 4 empty lines omitted for brevity ]
Enter a file name ("STOP" to stop): STOP

```

It looks like the stream state is good until after the final citation is read for the first time. Because the `paper1.txt` file contains an empty last line, the `while` loop is executed one more time after having read the last citation. In this last loop, `inputFile >> ws` reads the white-space of the last line, which causes the stream state to become `eof`. Then, the code still tries to read a line using `getline()` which causes the stream state to become `fail` and `eof`. That is expected. What is not expected is that the stream state remains as `fail` after all attempts to read the citations a second time. That doesn't appear to make sense at first: the code uses `seekg()` to seek back to the beginning of the citations before reading them a second time.

However, Chapter 13 explains that streams maintain their error states until you clear them explicitly; `seekg()` doesn't clear the `fail` state automatically. When in an error state, streams fail to read data correctly, which explains why the stream state is also `fail` after trying to read the citations a second time. A closer look at the code reveals that it fails to call `clear()` on the `istream` after reaching the end of the file. If you modify the code by adding a call to `clear()`, it will read the citations properly.

Here is the corrected `readFile()` method without the debugging `cout` statements:

```
void ArticleCitations::readFile(string_view fileName)
{
    // Code omitted for brevity

    if (count != 0) {
        // Allocate an array of strings to store the citations.
        mCitations = new string[count];
        mNumCitations = count;
        // Clear the stream state.
        inputFile.clear();
        // Seek back to the start of the citations.
        inputFile.seekg(citationsStart);
        // Read each citation and store it in the new array.
        for (count = 0; count < mNumCitations; count++) {
            string temp;
            getline(inputFile, temp);
            if (!temp.empty()) {
                mCitations[count] = temp;
            }
        }
    } else {
        mNumCitations = -1;
    }
}
```

Running the same test again on `paper1.txt` now shows you the correct four citations.

Using the GDB Debugger on Linux

Now that your `ArticleCitations` class seems to work well on one citations file, you decide to blaze ahead and test some special cases, starting with a file with no citations. The file looks like this, and is stored in a file named `paper2.txt`:

```
Author with no citations
```

When you try to run your program on this file, depending on your version of Linux and your compiler, you might get a crash that looks something like the following:

```
Enter a file name ("STOP" to stop): paper2.txt
terminate called after throwing an instance of 'std::bad_alloc'
  what():  std::bad_alloc
Aborted (core dumped)
```

The message “core dumped” means that the program crashed. This time you decide to give the debugger a shot. The Gnu Debugger (GDB) is widely available on Unix and Linux platforms.

First, you must compile your program with debugging information (`-g` with `g++`). Then you can launch the program under GDB. Here's an example session using the debugger to find the root cause of this problem. This example assumes your compiled executable is called `buggyprogram`. Text that you have to type is shown in bold.

```
> gdb buggyprogram
[ Start-up messages omitted for brevity ]
Reading symbols from /home/marc/c++/gdb/buggyprogram...done.
(gdb) run
Starting program: buggyprogram
Enter a file name ("STOP" to stop): paper2.txt
terminate called after throwing an instance of 'std::bad_alloc'
  what():  std::bad_alloc
Program received signal SIGABRT, Aborted.
0x00007ffff7535c39 in raise () from /lib64/libc.so.6
(gdb)
```

When the program crashes, the debugger breaks the execution, and allows you to poke around in the state of the program at that time. The `backtrace` or `bt` command shows the current stack trace. The last operation is at the top, with frame number zero (#0):

```
(gdb) bt
#0  0x00007ffff7535c39 in raise () from /lib64/libc.so.6
#1  0x00007ffff7537348 in abort () from /lib64/libc.so.6
#2  0x00007ffff7b35f85 in __gnu_cxx::__verbose_terminate_handler() () from /lib64/libstdc++.so.6
#3  0x00007ffff7b33ee6 in ?? () from /lib64/libstdc++.so.6
#4  0x00007ffff7b33f13 in std::terminate() () from /lib64/libstdc++.so.6
#5  0x00007ffff7b3413f in __cxa_throw () from /lib64/libstdc++.so.6
#6  0x00007ffff7b346cd in operator new(unsigned long) () from /lib64/libstdc++.so.6
#7  0x00007ffff7b34769 in operator new[](unsigned long) () from /lib64/libstdc++.so.6
#8  0x0000000004016ea in ArticleCitations::copy (this=0x7ffffffffffe090, src=...) at ArticleCitations.cpp:40
#9  0x0000000004015b5 in ArticleCitations::ArticleCitations (this=0x7ffffffffffe090, src=...)
    at ArticleCitations.cpp:16
#10 0x000000000401d0c in main () at ArticleCitationsTest.cpp:20
```

When you get a stack trace like this, you should try to find the first stack frame from the top that is in your own code. In this example, this is stack frame #8. From this frame, you can see that there seems to be a problem in the `copy()` method of `ArticleCitations`. This method is invoked because `main()` calls `processCitations()` and passes the argument by value, which triggers a call to the copy constructor, which calls `copy()`. Of course, in production code you should pass a `const` reference, but pass-by-value is used in this example of a buggy program. You can tell the debugger to switch to stack frame #8 with the `frame` command, which requires the index of the frame to jump to:

```
(gdb) frame 8
#8  0x0000000004016ea in ArticleCitations::copy (this=0x7ffffffffffe090, src=...) at ArticleCitations.cpp:40
40      mCitations = new string[mNumCitations];
```

This output shows that the following line caused a problem:

```
mCitations = new string[mNumCitations];
```

Now, you can use the `list` command to show the code in the current stack frame around the offending line:

```
(gdb) list
35 // Copy the article name, author, etc.
36 mArticle = src.mArticle;
37 // Copy the number of citations
38 mNumCitations = src.mNumCitations;
39 // Allocate an array of the correct size
40 mCitations = new string[mNumCitations];
41 // Copy each element of the array
42 for (int i = 0; i < mNumCitations; i++) {
43     mCitations[i] = src.mCitations[i];
44 }
```

In GDB, you can print values available in the current scope with the `print` command. In order to find the root cause of the problem, you can try printing some of the variables. The error happens inside the `copy()` method, so checking the value of the `src` parameter is a good start:

```
(gdb) print src
$1 = (const ArticleCitations &) @0x7fffffff060: {
  _vptr.ArticleCitations = 0x401fb0 <vtable for ArticleCitations+16>,
  mArticle = "Author with no citations", mCitations = 0x7fffffff080, mNumCitations
  = -1}
```

Ah-ha! Here's the problem. This article isn't supposed to have any citations. Why is `mNumCitations` set to the strange value `-1`? Take another look at the code in `readFile()` for the case where there are no citations. In that case, it looks like `mNumCitations` is erroneously set to `-1`. The fix is easy: you always need to initialize `mNumCitations` to `0`, instead of setting it to `-1` when there are no citations. Another problem is that `readFile()` can be called multiple times on the same `ArticleCitations` object, so you also need to free a previously allocated `mCitations` array. Here is the fixed code:

```
void ArticleCitations::readFile(string_view fileName)
{
    // Code omitted for brevity

    delete [] mCitations; // Free previously allocated citations.
    mCitations = nullptr;
    mNumCitations = 0;
    if (count != 0) {
        // Allocate an array of strings to store the citations.
        mCitations = new string[count];
        mNumCitations = count;
        // Clear the stream state.
        inputFile.clear();
        // Seek back to the start of the citations.
        inputFile.seekg(citationsStart);

        // Code omitted for brevity
    }
}
```

As this example shows, bugs don't always show up right away. It often takes a debugger and some persistence to find them.

Using the Visual C++ 2017 Debugger

This section explains the same debugging procedure as described in the previous section, but uses the Microsoft Visual C++ 2017 debugger instead of GDB.

First, you need to create a project. Start VC++ and click File ⇨ New ⇨ Project. In the project template tree on the left, select Visual C++ ⇨ Win32 (or Windows Desktop). Then select the Win32 Console Application (or Windows Console Application) template in the list in the middle of the window. At the bottom, you can specify a name for the project and a location where to save it. Specify ArticleCitations as the name, choose a folder in which to save the project, and click OK. A wizard opens.² In this wizard, click Next, select Console application, select Empty Project, and click Finish.

Once your new project is created, you can see a list of project files in the Solution Explorer. If this docking window is not visible, go to View ⇨ Solution Explorer. There should be no files in the solution right now. Right-click the ArticleCitations project in the Solution Explorer and click Add ⇨ Existing Item. Add all the files from the 06_ArticleCitations\06_VisualStudio folder in the downloadable source code archive to the project. After this, your Solution Explorer should look similar to Figure 27-1.

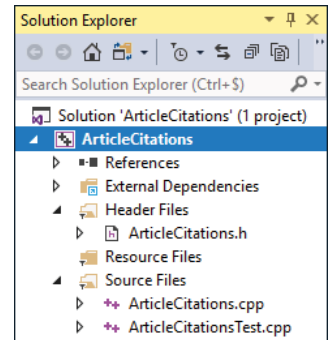

FIGURE 27-1

VC++ 2017 does not yet automatically enable C++17 features yet. Because this example uses `std::string_view` from C++17, you have to tell VC++ to enable C++17 features. In the Solution Explorer window, right-click the ArticleCitations project and click Properties. In the properties window, go to Configuration Properties ⇨ C/C++ ⇨ Language, and set the C++ Language Standard option to “ISO C++17 Standard” or “ISO C++ Latest Draft Standard”, whichever is available in your version of Visual C++.

Visual C++ supports so-called precompiled headers, a topic outside the scope of this book. In general, I recommend to use precompiled headers if your compiler supports them. However, the ArticleCitations implementation does not use precompiled headers, so you have to disable that feature for this particular project. In the Solution Explorer window, right-click the ArticleCitations project and click Properties. In the properties window, go to Configuration Properties ⇨ C/C++ ⇨ Precompiled Headers, and set the Precompiled Header option to “Not Using Precompiled Headers.”

Now you can compile the program. Click Build ⇨ Build Solution. Then copy the `paper1.txt` and `paper2.txt` test files to your ArticleCitations project folder, which is the folder containing the `ArticleCitations.vcxproj` file.

²Depending on your version of VC++ 2017, you might not see any wizard. Instead, a new project will be created automatically containing four files: `stdafx.h`, `stdafx.cpp`, `targetver.h`, and `ArticleCitations.cpp`. If that is the case, please select those files in the Solution Explorer (View ⇨ Solution Explorer) and delete them.

Run the application with Debug ⇨ Start Debugging, and test the program by first specifying the `paper1.txt` file. It should properly read the file and output the result to the console. Then, test `paper2.txt`. The debugger breaks the execution with a message similar to Figure 27-2.

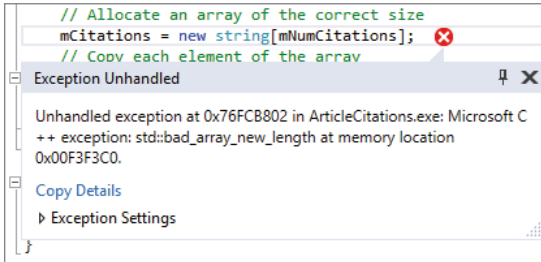

FIGURE 27-2

This immediately shows you the line where the crash happened. If you only see disassembly code, right-click anywhere on the disassembly and select `Go To Source Code`. You can now inspect variables by simply hovering your mouse over the name of a variable. If you hover over `src`, you'll notice that `mNumCitations` is `-1`. The reason and the fix are exactly the same as in the earlier example.

You can come to the same conclusion by inspecting the call stack (Debug ⇨ Windows ⇨ Call Stack). In this call stack, you need to find the first line that contains code that you wrote. This is shown in Figure 27-3.

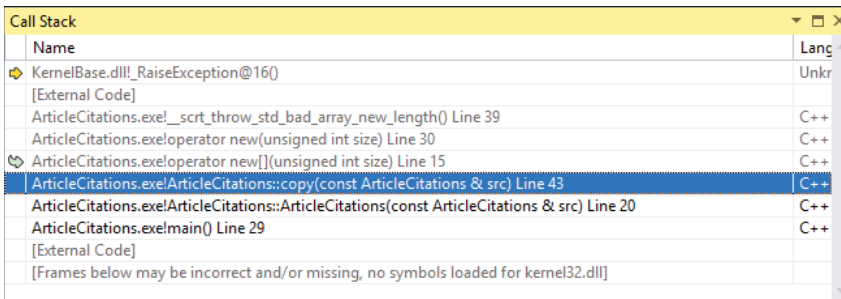

FIGURE 27-3

Just as with GDB, you see that the problem is in `copy()`. You can double-click that line in the call stack window to jump to the right place in the code.

Instead of hovering over variables to inspect their values, you can also use the Debug ⇨ Windows ⇨ Autos window, which shows a list of variables. Figure 27-4 shows this list with the `src` variable expanded to show its data members. From this window, you can also see that `mNumCitations` is `-1`.

Name	Value	Type
mCitations	0x0115fa10 <Error reading characters of stri	std::basic_string<char,std::c
mNumCitations	-1	int
src	{mArticle="Author with no citations" mCit	const ArticleCitations &
_vfptr	0x003284d8 {ArticleCitations.exe\void(* Arti	void **
mArticle	"Author with no citations"	std::basic_string<char,std::c
mCitations	0x00000000 <NULL>	std::basic_string<char,std::c
mNumCitations	-1	int
src.mNumCitations	-1	const int
this	0x0115f8b8 {mArticle="Author with no cita	ArticleCitations *

FIGURE 27-4

Lessons from the ArticleCitations Example

You might be inclined to disregard this example as too small to be representative of real debugging. Although the buggy code is not lengthy, many classes that you write will not be much bigger, even in large projects. Imagine if you had failed to test this example thoroughly before integrating it with the rest of the project. If these bugs showed up later, you and other engineers would have to spend more time narrowing down the problem before you could debug it as shown here. Additionally, the techniques shown in this example apply to all debugging, whether on a large or small scale.

SUMMARY

The most important concept in this chapter is the fundamental law of debugging: *avoid bugs when you're coding, but plan for bugs in your code*. The reality of programming is that bugs will appear. If you've prepared your program properly, with error logging, debug traces, and assertions, then the actual debugging will be significantly easier.

In addition to these techniques, this chapter also presented specific approaches for debugging bugs. The most important rule when actually debugging is to reproduce the problem. Then, you can use a symbolic debugger, or log-based debugging, to track down the root cause. Memory errors present particular difficulties, and account for the majority of bugs in legacy C++ code. This chapter described the various categories of memory bugs and their symptoms, and showed examples of debugging errors in a program.

Debugging is a hard skill to learn. To take your C++ skills to a professional level, you will have to practice debugging a lot.

28

Incorporating Design Techniques and Frameworks

WHAT'S IN THIS CHAPTER?

- An overview of C++ language features that are common, but involve easy-to-forget syntax
- What RAll is and why it is a powerful concept
- What the double dispatch technique is and how to use it
- How to use mixin classes
- What frameworks are
- The model-view-controller paradigm

WROX.COM DOWNLOADS FOR THIS CHAPTER

Please note that all the code examples for this chapter are available as a part of this chapter's code download on the book's website at www.wrox.com/go/proc++4e on the Download Code tab.

One of the major themes of this book has been the adoption of reusable techniques and patterns. As a programmer, you tend to face similar problems repeatedly. With an arsenal of diverse approaches, you can save yourself time by applying the proper technique to a given problem.

A *design technique* is a standard approach for solving a particular problem in C++. Often, a design technique aims to overcome an annoying feature or language deficiency. Other times, a design technique is a piece of code that you use in many different programs to solve a common C++ problem.

This chapter focuses on design techniques—C++ idioms that aren't necessarily built-in parts of the language, but are nonetheless frequently used. The first part of this chapter covers the language features in C++ that are common, but involve easy-to-forget syntax. Most of this material is a review, but it is a useful reference tool when the syntax escapes you. The topics covered include the following:

- Starting a class from scratch
- Extending a class by deriving from it
- Implementing the copy-and-swap idiom
- Throwing and catching exceptions
- Reading from a file
- Writing to a file
- Defining a template class

The second part of this chapter focuses on higher-level techniques that build upon C++ language features. These techniques offer a better way to accomplish everyday programming tasks. Topics include the following:

- RAII (Resource Acquisition Is Initialization)
- The double dispatch technique
- Mixin classes

This chapter concludes with an introduction to frameworks, a coding technique that greatly eases the development of large applications.

"I CAN NEVER REMEMBER HOW TO..."

Chapter 1 compares the size of the C standard to the size of the C++ standard. It is possible, and somewhat common, for a C programmer to memorize the entire C language. The keywords are few, the language features are minimal, and the behaviors are well defined. This is not the case with C++. Even C++ experts need to look things up sometimes. With that in mind, this section presents examples of coding techniques that are used in almost all C++ programs. When you remember the concept but forgot the syntax, turn to the following sections for a refresher.

...Write a Class

Don't remember how to get started? No problem—here is the definition of a simple class:

```
#pragma once

// A simple class that illustrates class definition syntax.
class Simple
{
    public:
```

```

Simple(); // Constructor
virtual ~Simple() = default; // Defaulted virtual destructor

// Disallow assignment and pass-by-value.
Simple(const Simple& src) = delete;
Simple& operator=(const Simple& rhs) = delete;

// Explicitly default move constructor and move assignment operator.
Simple(Simple&& src) = default;
Simple& operator=(Simple&& rhs) = default;

virtual void publicMethod(); // Public method
int mPublicInteger; // Public data member

protected:
virtual void protectedMethod(); // Protected method
int mProtectedInteger = 41; // Protected data member

private:
virtual void privateMethod(); // Private method
int mPrivateInteger = 42; // Private data member
static const int kConstant = 2; // Private constant
static int sStaticInt; // Private static data member
};

```

NOTE *This class definition shows some things that are possible. However, in your own class definitions, you should try to avoid having public or protected data members. Instead, you should make them private, and provide public or protected getter and setter methods.*

As Chapter 10 explains, it's a good idea to always make at least your destructor virtual in case someone wants to derive from your class. It's allowed to leave the destructor non-virtual, but only if you mark your class as `final` so that no other classes can derive from it. If you only want to make your destructor virtual but you don't need any code inside the destructor, then you can explicitly default it, as in the `Simple` class example.

This example also demonstrates that you can explicitly delete or default special member functions. The copy constructor and copy assignment operator are deleted to prevent assignment and pass-by-value, while the move constructor and move assignment operator are explicitly defaulted.

Next, here is the implementation, including the initialization of the static data member:

```

#include "Simple.h"

int Simple::sStaticInt = 0; // Initialize static data member.

Simple::Simple() : mPublicInteger(40)
{
    // Implementation of constructor
}

```

```

void Simple::publicMethod() { /* Implementation of public method */ }

void Simple::protectedMethod() { /* Implementation of protected method */ }

void Simple::privateMethod() { /* Implementation of private method */ }

```

C++17

With C++17, you can remove the initialization of `sStaticInt` from the source file if you make it an inline variable instead, initialized in the class definition as follows:

```

static inline int sStaticInt = 0;          // Private static data member

```

Chapters 8 and 9 provide all the details for writing your own classes.

...Derive from an Existing Class

To derive from an existing class, you declare a new class that is an extension of another class. Here is the definition for a class called `DerivedSimple`, which derives from `Simple`:

```

#pragma once

#include "Simple.h"

// A derived class of the Simple class.
class DerivedSimple : public Simple
{
public:
    DerivedSimple();          // Constructor

    virtual void publicMethod() override; // Overridden method
    virtual void anotherMethod();        // Added method
};

```

The implementation is as follows:

```

#include "DerivedSimple.h"

DerivedSimple::DerivedSimple() : Simple()
{
    // Implementation of constructor
}

void DerivedSimple::publicMethod()
{
    // Implementation of overridden method
    Simple::publicMethod(); // You can access base class implementations.
}

void DerivedSimple::anotherMethod()
{
    // Implementation of added method
}

```

Consult Chapter 10 for details on inheritance techniques.

...Use the Copy-and-Swap Idiom

The copy-and-swap idiom is discussed in detail in Chapter 9. It's an idiom to implement a possibly throwing operation on an object with a strong exception-safety guarantee, that is, all-or-nothing. You simply create a copy of the object, modify that copy (can be a complex algorithm, possibly throwing exceptions), and finally, when no exceptions have been thrown, swap the copy with the original object. An assignment operator is an example of an operation for which you can use the copy-and-swap idiom. Your assignment operator first makes a local copy of the source object, then swaps this copy with the current object using only a non-throwing `swap()` implementation.

Here is a concise example of the copy-and-swap idiom used for a copy assignment operator. The class defines a copy constructor, a copy assignment operator, and a friend `swap()` function, which is marked as `noexcept`.

```
class CopyAndSwap
{
public:
    CopyAndSwap() = default;
    virtual ~CopyAndSwap(); // Virtual destructor

    CopyAndSwap(const CopyAndSwap& src); // Copy constructor
    CopyAndSwap& operator=(const CopyAndSwap& rhs); // Assignment operator

    friend void swap(CopyAndSwap& first, CopyAndSwap& second) noexcept;

private:
    // Private data members...
};
```

The implementation is as follows:

```
CopyAndSwap::~CopyAndSwap()
{
    // Implementation of destructor
}

CopyAndSwap::CopyAndSwap(const CopyAndSwap& src)
{
    // This copy constructor can first delegate to a non-copy constructor
    // if any resource allocations have to be done. See the Spreadsheet
    // implementation in Chapter 9 for an example.

    // Make a copy of all data members
}

void swap(CopyAndSwap& first, CopyAndSwap& second) noexcept
{
    using std::swap; // Requires <utility>

    // Swap each data member, for example:
    // swap(first.mData, second.mData);
}
```

```

CopyAndSwap& CopyAndSwap::operator=(const CopyAndSwap& rhs)
{
    // Check for self-assignment
    if (this == &rhs) {
        return *this;
    }

    auto copy(rhs); // Do all the work in a temporary instance
    swap(*this, copy); // Commit the work with only non-throwing operations
    return *this;
}

```

Consult Chapter 9 for a more detailed discussion.

...Throw and Catch Exceptions

If you've been working on a team that doesn't use exceptions (for shame!) or if you've gotten used to Java-style exceptions, the C++ syntax may escape you. Here's a refresher that uses the built-in exception class `std::runtime_error`. In most large programs, you will write your own exception classes.

```

#include <stdexcept>
#include <iostream>

void throwIf(bool throwIt)
{
    if (throwIt) {
        throw std::runtime_error("Here's my exception");
    }
}

int main()
{
    try {
        throwIf(false); // doesn't throw
        throwIf(true); // throws
    } catch (const std::runtime_error& e) {
        std::cerr << "Caught exception: " << e.what() << std::endl;
        return 1;
    }
    return 0;
}

```

Chapter 14 discusses exceptions in more detail.

...Read from a File

Complete details for file input are included in Chapter 13. Here is a quick sample program for file reading basics. This program reads its own source code and outputs it one token at a time:

```

#include <iostream>
#include <fstream>
#include <string>

```



```

using namespace std;

int main()
{
    ifstream inputFile("FileRead.cpp");
    if (inputFile.fail()) {
        cerr << "Unable to open file for reading." << endl;
        return 1;
    }

    string nextToken;
    while (inputFile >> nextToken) {
        cout << "Token: " << nextToken << endl;
    }
    return 0;
}

```

...Write to a File

The following program outputs a message to a file, then reopens the file and appends another message. Additional details can be found in Chapter 13.

```

#include <iostream>
#include <fstream>

using namespace std;

int main()
{
    ofstream outputFile("FileWrite.out");
    if (outputFile.fail()) {
        cerr << "Unable to open file for writing." << endl;
        return 1;
    }
    outputFile << "Hello!" << endl;
    outputFile.close();

    ofstream appendFile("FileWrite.out", ios_base::app);
    if (appendFile.fail()) {
        cerr << "Unable to open file for appending." << endl;
        return 2;
    }
    appendFile << "Append!" << endl;
    return 0;
}

```

...Write a Template Class

Template syntax is one of the messiest parts of the C++ language. The most-forgotten piece of the template puzzle is that code that uses a class template needs to be able to see the method implementations as well as the class template definition. The same holds for function templates. For class templates, the usual technique to accomplish this is to simply put the implementations directly in the header file following the class template definition, as in the following example. Another

technique is to put the implementations in a separate file, often with an `.inl` extension, and then `#include` that file as the last line in the class template header file. The following program shows a class template that wraps a reference to an object and adds *get* and *set* semantics to it. Here is the `SimpleTemplate.h` header file:

```
template <typename T>
class SimpleTemplate
{
    public:
        SimpleTemplate(T& object);

        const T& get() const;
        void set(const T& object);
    private:
        T& mObject;
};

template<typename T>
SimpleTemplate<T>::SimpleTemplate(T& object) : mObject(object)
{
}

template<typename T>
const T& SimpleTemplate<T>::get() const
{
    return mObject;
}

template<typename T>
void SimpleTemplate<T>::set(const T& object)
{
    mObject = object;
}
```

The code can be tested as follows:

```
#include <iostream>
#include <string>
#include "SimpleTemplate.h"

using namespace std;

int main()
{
    // Try wrapping an integer.
    int i = 7;
    SimpleTemplate<int> intWrapper(i);
    i = 2;
    cout << "wrapped value is " << intWrapper.get() << endl;

    // Try wrapping a string.
    string str = "test";
    SimpleTemplate<string> stringWrapper(str);
}
```

```

    str += "!";
    cout << "wrapped value is " << stringWrapper.get() << endl;
    return 0;
}

```

Details about templates can be found in Chapters 12 and 22.

THERE MUST BE A BETTER WAY

As you read this paragraph, thousands of C++ programmers throughout the world are solving problems that have already been solved. Someone in a cubicle in San Jose is writing a smart pointer implementation from scratch that uses reference counting. A young programmer on a Mediterranean island is designing a class hierarchy that could benefit immensely from the use of mixin classes.

As a Professional C++ programmer, you need to spend less of your time reinventing the wheel, and more of your time adapting reusable concepts in new ways. This section gives some examples of general-purpose approaches that you can apply directly to your own programs or customize for your needs.

Resource Acquisition Is Initialization

RAII, or Resource Acquisition Is Initialization, is a simple yet very powerful concept. It is used to automatically free acquired resources when an RAII instance goes out of scope. This happens at a deterministic point in time. Basically, the constructor of a new RAII instance *acquires ownership* of a certain resource and *initializes* the instance with that resource, hence the name Resource Acquisition Is Initialization. The destructor automatically frees the acquired resource when the RAII instance is destroyed.

Here is an example of a `File` RAII class that safely wraps a C-style file handle (`std::FILE`) and automatically closes the file when the RAII instance goes out of scope. The RAII class also provides `get()`, `release()`, and `reset()` methods that behave similar to the same methods on certain Standard Library classes, such as `std::unique_ptr`.

```

#include <cstdio>

class File final
{
public:
    File(std::FILE* file);
    ~File();

    // Prevent copy construction and copy assignment.
    File(const File& src) = delete;
    File& operator=(const File& rhs) = delete;

    // Allow move construction and move assignment.
    File(File&& src) noexcept = default;
    File& operator=(File&& rhs) noexcept = default;

```

```

        // get(), release(), and reset()
        std::FILE* get() const noexcept;
        std::FILE* release() noexcept;
        void reset(std::FILE* file = nullptr) noexcept;

    private:
        std::FILE* mFile;
};

File::File(std::FILE* file) : mFile(file)
{
}

File::~File()
{
    reset();
}

std::FILE* File::get() const noexcept
{
    return mFile;
}

std::FILE* File::release() noexcept
{
    std::FILE* file = mFile;
    mFile = nullptr;
    return file;
}

void File::reset(std::FILE* file /*= nullptr*/) noexcept
{
    if (mFile) {
        fclose(mFile);
    }
    mFile = file;
}

```

It can be used as follows:

```
File myFile(fopen("input.txt", "r"));
```

As soon as the `myFile` instance goes out of scope, its destructor is called, and the file is automatically closed.

I recommend to never include a default constructor or to explicitly delete the default constructor for RAII classes. The reason can best be explained using a Standard Library RAII class that has a default constructor, `std::unique_lock` (see Chapter 23). Proper use of `unique_lock` is as follows:

```

class Foo
{
    public:
        void setData();
    private:
        mutex mMutex;
};

```

```
void Foo::setData()
{
    unique_lock<mutex> lock(mMutex);
    // ...
}
```

The `setData()` method uses the `unique_lock` RAII object to construct a local `lock` object that locks the `mMutex` data member and automatically unlocks that mutex at the end of the method.

However, because you do not directly use the `lock` variable after it has been defined, it is easy to make the following mistake:

```
void Foo::setData()
{
    unique_lock<mutex>(mMutex);
    // ...
}
```

In this code, you accidentally forgot to give the `unique_lock` a name. This will compile, but it does not what you intended it to do! It will actually declare a local variable called `mMutex` (hiding the `mMutex` data member), and initialize it with a call to the `unique_lock`'s default constructor. The result is that the `mMutex` data member is *not* locked!

WARNING *Never include a default constructor in an RAII class.*

Double Dispatch

Double dispatch is a technique that adds an extra dimension to the concept of polymorphism. As described in Chapter 5, polymorphism lets the program determine behavior based on types at run time. For example, you could have an `Animal` class with a `move()` method. All `Animals` move, but they differ in terms of *how* they move. The `move()` method is defined for every derived class of `Animal` so that the appropriate method can be called, or dispatched, for the appropriate animal at run time without knowing the type of the animal at compile time. Chapter 10 explains how to use virtual methods to implement this run-time polymorphism.

Sometimes, however, you need a method to behave according to the run-time type of two objects, instead of just one. For example, suppose that you want to add a method to the `Animal` class that returns `true` if the animal eats another animal, and `false` otherwise. The decision is based on two factors: the type of animal doing the eating, and the type of animal being eaten. Unfortunately, C++ provides no language mechanism to choose a behavior based on the run-time type of more than one object. Virtual methods alone are insufficient for modeling this scenario because they determine a method, or behavior, depending on the run-time type of only the receiving object.

Some object-oriented languages provide the ability to choose a method at run time based on the run-time types of two or more objects. They call this feature *multi-methods*. In C++, however, there is no core language feature to support multi-methods, but you can use the *double dispatch* technique, which provides a way to make functions virtual for more than one object.

NOTE *Double dispatch is really a special case of multiple dispatch, in which a behavior is chosen depending on the run-time types of two or more objects. In practice, double dispatch, which chooses a behavior based on the run-time types of exactly two objects, is usually sufficient.*

Attempt #1: Brute Force

The most straightforward way to implement a method whose behavior depends on the run-time types of two different objects is to take the perspective of one of the objects and use a series of `if/else` constructs to check the type of the other. For example, you could implement a method called `eats()` in each class derived from `Animal` that takes the other animal as a parameter. The method is declared pure virtual in the base class as follows:

```
class Animal
{
    public:
        virtual bool eats(const Animal& prey) const = 0;
};
```

Each derived class implements the `eats()` method, and returns the appropriate value based on the type of the parameter. The implementation of `eats()` for several derived classes follows. Note that the `Dinosaur` avoids the series of `if/else` constructs because—according to the author—dinosaurs eat anything:

```
bool Bear::eats(const Animal& prey) const
{
    if (typeid(prey) == typeid(Bear)) {
        return false;
    } else if (typeid(prey) == typeid(Fish)) {
        return true;
    } else if (typeid(prey) == typeid(Dinosaur)) {
        return false;
    }
    return false;
}

bool Fish::eats(const Animal& prey) const
{
    if (typeid(prey) == typeid(Bear)) {
        return false;
    } else if (typeid(prey) == typeid(Fish)) {
        return true;
    } else if (typeid(prey) == typeid(Dinosaur)) {
        return false;
    }
    return false;
}

bool Dinosaur::eats(const Animal& prey) const
{
    return true;
}
```

This brute force approach works, and it's probably the most straightforward technique for a small number of classes. However, there are several reasons why you might want to avoid this approach:

- Object-oriented programming (OOP) purists often frown upon explicitly querying the type of an object because it implies a design that is lacking a proper object-oriented structure.
- As the number of types grows, such code can become messy and repetitive.
- This approach does not force derived classes to consider new types. For example, if you added a `Donkey`, the `Bear` class would continue to compile, but would return `false` when told to eat a `Donkey`, even though everybody knows that bears eat donkeys.

Attempt #2: Single Polymorphism with Overloading

You could attempt to use polymorphism with overloading to circumvent all of the cascading `if/else` constructs. Instead of giving each class a single `eats()` method that takes an `Animal` reference, why not overload the method for each derived class of `Animal`? The base class definition would look like this:

```
class Animal
{
    public:
        virtual bool eats(const Bear&) const = 0;
        virtual bool eats(const Fish&) const = 0;
        virtual bool eats(const Dinosaur&) const = 0;
};
```

Because the methods are pure virtual in the base class, each derived class is forced to implement the behavior for every other type of `Animal`. For example, the `Bear` class contains the following methods:

```
class Bear : public Animal
{
    public:
        virtual bool eats(const Bear&) const override { return false; }
        virtual bool eats(const Fish&) const override { return true; }
        virtual bool eats(const Dinosaur&) const override { return false; }
};
```

This approach initially appears to work, but it really solves only half of the problem. In order to call the proper `eats()` method on an `Animal`, the compiler needs to know the compile-time type of the animal being eaten. A call such as the following will be successful because the compile-time types of both the animal that eats and the animal that is eaten are known:

```
Bear myBear;
Fish myFish;
cout << myBear.eats(myFish) << endl;
```

The missing piece is that the solution is only polymorphic in one direction. You can access `myBear` through an `Animal` reference and the correct method will be called:

```
Bear myBear;
Fish myFish;
Animal& animalRef = myBear;
cout << animalRef.eats(myFish) << endl;
```

However, the reverse is not true. If you pass an `Animal` reference to the `eats()` method, you will get a compilation error because there is no `eats()` method that takes an `Animal`. The compiler cannot determine, at compile time, which version to call. The following example does not compile:

```
Bear myBear;
Fish myFish;
Animal& animalRef = myFish;
cout << myBear.eats(animalRef) << endl; // BUG! No method Bear::eats(Animal&)
```

Because the compiler needs to know which overloaded version of the `eats()` method is going to be called at compile time, this solution is not truly polymorphic. It would not work, for example, if you were iterating over an array of `Animal` references and passing each one to a call to `eats()`.

Attempt #3: Double Dispatch

The *double dispatch* technique is a truly polymorphic solution to the multiple-type problem. In C++, polymorphism is achieved by overriding methods in derived classes. At run time, methods are called based on the actual type of the object. The preceding single polymorphic attempt didn't work because it attempted to use polymorphism to determine which overloaded version of a method to call instead of using it to determine on which class to call the method.

To begin, focus on a single derived class, perhaps the `Bear` class. The class needs a method with the following declaration:

```
virtual bool eats(const Animal& prey) const override;
```

The key to double dispatch is to determine the result based on a method call on the argument. Suppose that the `Animal` class has a method called `eatenBy()`, which takes an `Animal` reference as a parameter. This method returns `true` if the current `Animal` gets eaten by the one passed in. With such a method, the definition of `eats()` becomes very simple:

```
bool Bear::eats(const Animal& prey) const
{
    return prey.eatenBy(*this);
}
```

At first, it looks like this solution adds another layer of method calls to the single polymorphic method. After all, each derived class still has to implement a version of `eatenBy()` for every derived class of `Animal`. However, there is a key difference. Polymorphism is occurring twice! When you call the `eats()` method on an `Animal`, polymorphism determines whether you are calling `Bear::eats()`, `Fish::eats()`, or one of the others. When you call `eatenBy()`, polymorphism again determines which class's version of the method to call. It calls `eatenBy()` on the run-time type of the `prey` object. Note that the run-time type of `*this` is always the same as the compile-time type so that the compiler can call the correct overloaded version of `eatenBy()` for the argument (in this case `Bear`).

Following are the class definitions for the `Animal` hierarchy using double dispatch. Note that forward class declarations are necessary because the base class uses references to the derived classes:

```
// forward declarations
class Fish;
class Bear;
class Dinosaur;
```



```

class Animal
{
    public:
        virtual bool eats(const Animal& prey) const = 0;

        virtual bool eatenBy(const Bear&) const = 0;
        virtual bool eatenBy(const Fish&) const = 0;
        virtual bool eatenBy(const Dinosaur&) const = 0;
};

class Bear : public Animal
{
    public:
        virtual bool eats(const Animal& prey) const override;

        virtual bool eatenBy(const Bear&) const override;
        virtual bool eatenBy(const Fish&) const override;
        virtual bool eatenBy(const Dinosaur&) const override;
};
// The definitions for the Fish and Dinosaur classes are identical to the
// Bear class, so they are not shown here.

```

The implementations follow. Note that each `Animal`-derived class implements the `eats()` method in the same way, but it cannot be factored up into the base class. The reason is that if you attempt to do so, the compiler won't know which overloaded version of the `eatenBy()` method to call because `*this` would be an `Animal`, not a particular derived class. Method overload resolution is determined according to the compile-time type of the object, not its run-time type.

```

bool Bear::eats(const Animal& prey) const { return prey.eatenBy(*this); }
bool Bear::eatenBy(const Bear&) const { return false; }
bool Bear::eatenBy(const Fish&) const { return false; }
bool Bear::eatenBy(const Dinosaur&) const { return true; }

bool Fish::eats(const Animal& prey) const { return prey.eatenBy(*this); }
bool Fish::eatenBy(const Bear&) const { return true; }
bool Fish::eatenBy(const Fish&) const { return true; }
bool Fish::eatenBy(const Dinosaur&) const { return true; }

bool Dinosaur::eats(const Animal& prey) const { return prey.eatenBy(*this); }
bool Dinosaur::eatenBy(const Bear&) const { return false; }
bool Dinosaur::eatenBy(const Fish&) const { return false; }
bool Dinosaur::eatenBy(const Dinosaur&) const { return true; }

```

Double dispatch is a concept that takes a bit of getting used to. I suggest playing with this code to adapt to the concept and its implementation.

Mixin Classes

Chapters 5 and 10 introduce the technique of using multiple inheritance to build *mixin classes*. Mixin classes add a small piece of extra behavior to a class in an existing hierarchy. You can usually spot a mixin class by its name, which ends in “-able”, for example, `Clickable`, `Drawable`, `Printable`, or `Lovable`.

Designing a Mixin Class

Mixin classes contain actual code that can be reused by other classes. A single mixin class implements a well-defined piece of functionality. For example, you might have a mixin class called `Playable` that is mixed into certain types of media objects. The mixin class could, for example, contain most of the code to communicate with the computer's sound drivers. By mixing in the class, the media object would get that functionality for free.

When designing a mixin class, you need to consider what behavior you are adding and whether it belongs in the object hierarchy or in a separate class. Using the previous example, if all media classes are playable, the base class should derive from `Playable` instead of mixing the `Playable` class into all of the derived classes. If only certain media classes are playable and they are scattered throughout the hierarchy, a mixin class makes sense.

One of the cases where mixin classes are particularly useful is when you have classes organized into a hierarchy on one axis, but they also contain similarities on another axis. For example, consider a war simulation game played on a grid. Each grid location can contain an `Item` with attack and defense capabilities and other characteristics. Some items, such as a `Castle`, are stationary. Others, such as a `Knight` or `FloatingCastle`, can move throughout the grid. When initially designing the object hierarchy, you might end up with something like Figure 28-1, which organizes the classes according to their attack and defense capabilities.

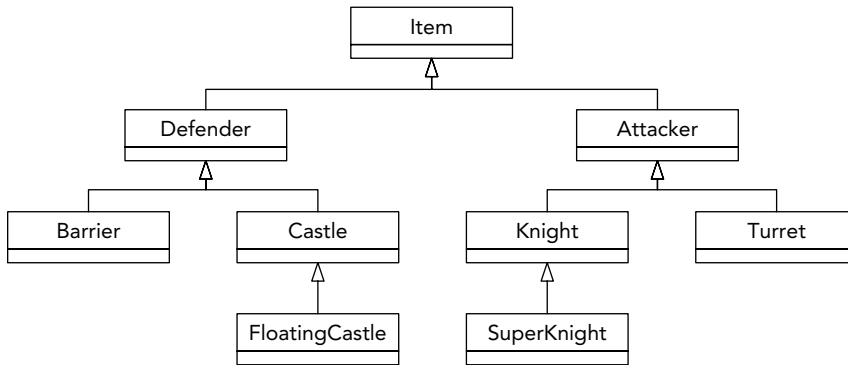

FIGURE 28-1

The hierarchy in Figure 28-1 ignores the movement functionality that certain classes contain. Building your hierarchy around movement would result in a structure similar to Figure 28-2.

Of course, the design of Figure 28-2 throws away all the organization of Figure 28-1. What's a good object-oriented programmer to do?

There are two common solutions for this problem. Assuming that you go with the first hierarchy, organized around attackers and defenders, you need some way to work movement into the equation. One possibility is that, even though only a portion of the derived classes support movement, you *could* add a `move()` method to the `Item` base class. The default implementation would do nothing. Certain derived classes would override `move()` to actually change their location on the grid.

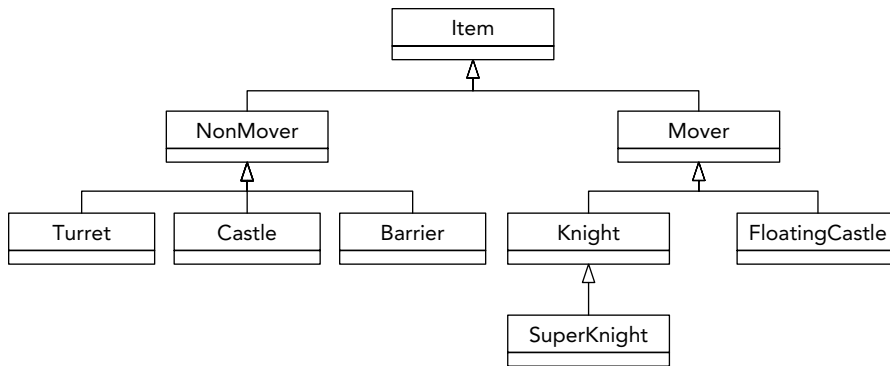

FIGURE 28-2

The other approach is to write a `Movable` mixin class. The elegant hierarchy from Figure 28-1 could be preserved, but certain classes in the hierarchy would derive from `Movable` in addition to their parent. Figure 28-3 shows this design.

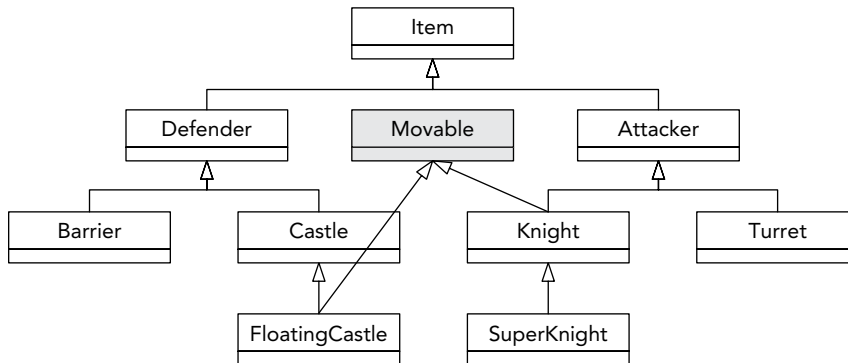

FIGURE 28-3

Implementing a Mixin Class

Writing a mixin class is no different from writing a normal class. In fact, it's usually much simpler. Using the earlier war simulation, the `Movable` mixin class might look as follows:

```

class Movable
{
    public:
        virtual void move() { /* Implementation to move an item... */ }
};
  
```

This `Movable` mixin class implements the actual code to move an item on the grid. It also provides a type for `Items` that can be moved. This allows you to create, for example, an array of all movable items without knowing or caring what actual derived class of `Item` they belong to.

Using a Mixin Class

The code for using a mixin class is syntactically equivalent to multiple inheritance. In addition to deriving from your parent class in the main hierarchy, you also derive from the mixin class:

```
class FloatingCastle : public Castle, public Movable
{
    // ...
};
```

This *mixes in* the functionality provided by the `Movable` mixin class into the `FloatingCastle` class. Now you have a class that exists in the most logical place in the hierarchy, but still shares commonality with objects elsewhere in the hierarchy.

OBJECT-ORIENTED FRAMEWORKS

When graphical operating systems first came on the scene in the 1980s, procedural programming was the norm. At the time, writing a GUI application usually involved manipulating complex data structures and passing them to OS-provided functions. For example, to draw a rectangle in a window, you might have had to populate a `Window` struct with the appropriate information and pass it to a `drawRect()` function.

As object-oriented programming (OOP) grew in popularity, programmers looked for a way to apply the OOP paradigm to GUI development. The result is known as an *object-oriented framework*. In general, a framework is a set of classes that are used collectively to provide an object-oriented interface to some underlying functionality. When talking about frameworks, programmers are usually referring to large class libraries that are used for general application development. However, a framework can really represent functionality of any size. If you write a suite of classes that provides database functionality for your application, those classes could be considered a framework.

Working with Frameworks

The defining characteristic of a framework is that it provides its own set of techniques and patterns. Frameworks usually require a bit of learning to get started with because they have their own mental model. Before you can work with a large application framework, such as the Microsoft Foundation Classes (MFC), you need to understand its view of the world.

Frameworks vary greatly in their abstract ideas and in their actual implementation. Many frameworks are built on top of legacy procedural APIs, which may affect various aspects of their design. Other frameworks are written from the ground up with object-oriented design in mind. Some frameworks might ideologically oppose certain aspects of the C++ language. For example, a framework could consciously shun the notion of multiple inheritance.

When you start working with a new framework, your first task is to find out what makes it tick. To what design principles does it subscribe? What mental model are its developers trying to convey? What aspects of the language does it use extensively? These are all vital questions, even though they may sound like things that you'll pick up along the way. If you fail to understand the design, model,

or language features of the framework, you will quickly get into situations where you overstep the bounds of the framework.

An understanding of the framework's design will also make it possible for you to extend it. For example, if the framework omits a feature, such as support for printing, you could write your own printing classes using the same model as the framework. By doing so, you retain a consistent model for your application, and you have code that can be reused by other applications.

A framework might use certain specific data types. For example, the MFC framework uses the `CString` data type to represent strings, instead of using the Standard Library `std::string` class. This does not mean that you have to switch to the data types provided by the framework for your entire code base. Instead, you should convert the data types on the boundaries between the framework code and the rest of your code.

The Model-View-Controller Paradigm

As I mentioned earlier, frameworks vary in their approaches to object-oriented design. One common paradigm is known as *model-view-controller*, or MVC. This paradigm models the notion that many applications commonly deal with a set of data, one or more views on that data, and manipulation of the data.

In MVC, a set of data is called the *model*. In a race car simulator, the model would keep track of various statistics, such as the current speed of the car and the amount of damage it has sustained. In practice, the model often takes the form of a class with many getters and setters. The class definition for the model of the race car might look as follows:

```
class RaceCar
{
public:
    RaceCar();
    virtual ~RaceCar() = default;

    virtual double getSpeed() const;
    virtual void setSpeed(double speed);

    virtual double getDamageLevel() const;
    virtual void setDamageLevel(double damage);
private:
    double mSpeed;
    double mDamageLevel;
};
```

A *view* is a particular visualization of the model. For example, there could be two views on a `RaceCar`. The first view could be a graphical view of the car, and the second could be a graph that shows the level of damage over time. The important point is that both views are operating on the same data—they are different ways of looking at the same information. This is one of the main advantages of the MVC paradigm: by keeping data separated from its display, you can keep your code more organized, and easily create additional views.

The final piece to the MVC paradigm is the *controller*. The controller is the piece of code that changes the model in response to some event. For example, when the driver of the race car simulator runs into a concrete barrier, the controller instructs the model to bump up the car's damage level and reduce its speed. The controller can also manipulate the view. For example, when the user scrolls a scrollbar in the user interface, the controller instructs the view to scroll its content.

The three components of MVC interact in a feedback loop. Actions are handled by the controller, which adjusts the model and/or views. If the model changes, it notifies the views to update them. This interaction is shown in Figure 28-4.

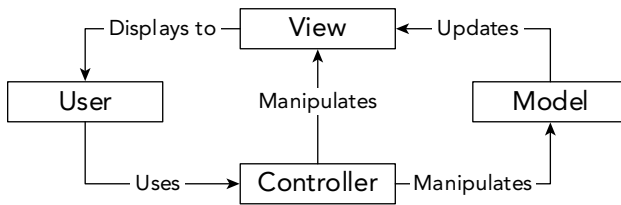

FIGURE 28-4

The model-view-controller paradigm has gained widespread support within many popular frameworks. Even nontraditional applications, such as web applications, are moving in the direction of MVC because it enforces a clear separation between data, the manipulation of data, and the displaying of data.

The MVC pattern has evolved into several different variants, such as model-view-presenter (MVP), model-view-adapter (MVA), model-view-viewmodel (MVVM), and so on.

SUMMARY

In this chapter, you read about some of the common techniques that Professional C++ programmers use consistently in their projects. As you advance as a software developer, you will undoubtedly form your own collection of reusable classes and libraries. Discovering design techniques opens the door to developing and using *patterns*, which are higher-level reusable constructs. You will experience the many applications of patterns next in Chapter 29.

29

Applying Design Patterns

WHAT'S IN THIS CHAPTER?

- What a pattern is and what the difference is with a design technique
- How to use the following patterns:
 - Iterator
 - Singleton
 - Abstract factory
 - Proxy
 - Adaptor
 - Decorator
 - Chain of responsibility
 - Observer

A *design pattern* is a standard approach to program organization that solves a general problem. C++ is an object-oriented language, so the design patterns of interest to C++ programmers are generally object-oriented patterns, which describe strategies for organizing objects and object relationships in your programs. These patterns are usually applicable to any object-oriented language, such as C++, C#, Java, or Smalltalk. In fact, if you are familiar with C# or Java programming, you will recognize many of these patterns.

Design patterns are less language-specific than are techniques. The difference between a pattern and a technique is admittedly fuzzy, and different books employ different definitions. This book defines a technique as a strategy particular to the C++ language, while a pattern is a more general strategy for object-oriented design applicable to any object-oriented language.

Note that many patterns have several different names. The distinctions between the patterns themselves can be somewhat vague, with different sources describing and categorizing them slightly differently. In fact, depending on the books or other sources you use, you may find the same name applied to different patterns. There is even disagreement as to which design approaches qualify as patterns. With a few exceptions, this book follows the terminology used in the seminal book *Design Patterns: Elements of Reusable Object-Oriented Software*, by Erich Gamma et al. (Addison-wesley Professional, 1994). However, other pattern names and variations are noted when appropriate.

The design pattern concept is a simple but powerful idea. Once you are able to recognize the recurring object-oriented interactions that occur in a program, finding an elegant solution becomes a matter of merely selecting the appropriate pattern to apply. This chapter describes several design patterns in detail and presents sample implementations.

Certain patterns go by different names or are subject to different interpretations. Any aspect of design is likely to provoke debate among programmers, and I believe that is a good thing. Don't simply accept these patterns as the only way to accomplish a task—draw on their approaches and ideas to refine them and form new patterns.

THE ITERATOR PATTERN

The *iterator* pattern provides a mechanism for separating algorithms or operations from the data on which they operate. At first glance, this pattern seems to contradict the fundamental principle in object-oriented programming of grouping together in objects data and the behaviors that operate on that data. While that argument is true on a certain level, the iterator pattern does not advocate removing fundamental behaviors from objects. Instead, it solves two problems that commonly arise with tight coupling of data and behaviors.

The first problem with tightly coupling data and behaviors is that it precludes generic algorithms that work on a variety of objects, not all of which are in the same class hierarchy. In order to write generic algorithms, you need some standard mechanism to access the contents of the objects.

The second problem with tightly coupled data and behaviors is that it's sometimes difficult to add new behaviors. At the very least, you need access to the source code for the data objects. However, what if the object hierarchy of interest is part of a third-party framework or library that you cannot change? It would be nice to be able to add an algorithm or operation that works on the data without modifying the original object hierarchy of classes that hold the data.

You've already seen an example of the iterator pattern in the Standard Library. Conceptually, *iterators* provide a mechanism for an operation or algorithm to access a container of elements in a sequence. The name comes from the English word *iterate*, which means "repeat." It applies to iterators because they repeat the action of moving forward in the sequence to reach each new element. In the Standard Library, the generic algorithms use iterators to access the elements of the containers on which they operate. By defining a standard iterator interface, the Standard Library allows you to write algorithms that can work on any container that supplies an iterator with the appropriate interface. Thus, iterators allow you to write generic algorithms without modifying the classes that hold the data. Figure 29-1 shows an iterator as the central coordinator; operations depend on iterators, and data objects provide iterators.

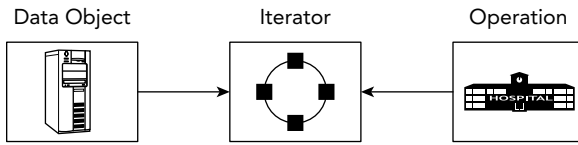

FIGURE 29-1

Chapter 21 illustrates a detailed example of how to implement an iterator for a class that conforms to the Standard Library requirements, which means that its iterator can be used by the generic Standard Library algorithms.

THE SINGLETON PATTERN

The *singleton* is one of the simplest design patterns. In English, the word *singleton* means “one of a kind” or “individual.” It has a similar meaning in programming. The singleton pattern is a strategy for enforcing the existence of exactly one instance of a class in a program. Applying the singleton pattern to a class guarantees that only one object of that class will ever be created. The singleton pattern also specifies that that one object is globally accessible from anywhere in the program. Programmers usually refer to a class following the singleton pattern as a *singleton class*.

If your program relies on the assumption that there will be exactly one instance of a class, you could enforce that assumption with the singleton pattern.

However, the singleton pattern has a number of disadvantages that you need to be aware of. If you have multiple singletons, it’s not always easy to guarantee that they are initialized in the right order at program startup. It’s also not easy to ensure a singleton is still there when callers need it during program shutdown. On top of that, singleton classes introduce hidden dependencies, cause tight coupling, and complicate unit testing. In a unit test, for example, you might want to write a stub version (see Chapter 26) of a singleton, but given the nature of a typical singleton implementation, that’s hard to do. A more appropriate design pattern could be *dependency injection*. With dependency injection, you create an interface for each service you provide, and inject the interfaces a component needs into the component. Dependency injection allows mocking (stub versions), makes it easier to introduce multiple instances later on, allows for more complicated ways of constructing the single object than a typical singleton, for example using factories, and so on. Still, the singleton pattern is discussed here because you will encounter it.

Example: A Logging Mechanism

Singletons can be useful for utility classes. Many applications have a notion of a logger—a class that is responsible for writing status information, debugging data, and errors to a central location. The ideal logging class has the following characteristics:

- It is available at all times.
- It is easy to use.
- There is only one instance.

The singleton pattern is a good match for a logger because, even though the logger could be used in many different contexts and for many different purposes, it is conceptually a single instance. Implementing the logger class as a singleton also makes it easier to use because you never have to worry about *which* logger is the current one or how to get a hold of the current logger; there's only one, so it's a moot point!

Implementation of a Singleton

There are two basic ways to implement singleton behavior in C++. The first approach uses a class with only static methods. Such a class needs no instantiation and is accessible from anywhere. The problem with this method is that it lacks a built-in mechanism for construction and destruction. However, technically, a class that uses all static methods isn't really a singleton: it's a *nothington* or a *static class*, to coin new terms. The term *singleton* implies that there is exactly one instance of the class. If all of the methods are static and the class is never instantiated at all, you cannot really call it a singleton anymore. So, this is not further discussed in this section.

The second approach uses access control levels to regulate the creation and access of one single instance of a class. This is a true singleton and discussed further with an example of a simple `Logger` class, which provides the following features:

- It can log a single string or a vector of strings.
- Each log message has an associated log level, which is prefixed to the log message.
- The logger can be set up to only log messages of a certain log level.
- Every logged message is flushed to disk so that it will appear in the file immediately.

To build a true singleton in C++, you can use the access control mechanisms as well as the `static` keyword. An actual `Logger` object exists at run time, and the class enforces that only one object is ever instantiated. Clients can always get a hold of that object through a static method called `instance()`. The class definition looks like this:

```
// Definition of a singleton logger class.
class Logger final
{
public:
    enum class LogLevel {
        Error,
        Info,
        Debug
    };

    // Returns a reference to the singleton Logger object.
    static Logger& instance();

    // Prevent copy/move construction.
    Logger(const Logger&) = delete;
    Logger(Logger&&) = delete;
```

```

    // Prevent copy/move assignment operations.
    Logger& operator=(const Logger&) = delete;
    Logger& operator=(Logger&&) = delete;

    // Sets the log level.
    void setLogLevel(LogLevel level);

    // Logs a single message at the given log level.
    void log(std::string_view message, LogLevel logLevel);

    // Logs a vector of messages at the given log level.
    void log(const std::vector<std::string>& messages,
             LogLevel logLevel);
private:
    // Private constructor and destructor.
    Logger();
    ~Logger();

    // Converts a log level to a human readable string.
    std::string_view getLogLevelString(LogLevel level) const;

    static const char* const kLogFileName;
    std::ofstream mOutputStream;
    LogLevel mLogLevel = LogLevel::Error;
};

```

This implementation is based on Scott Meyer's singleton pattern. This means that the `instance()` method contains a local `static` instance of the `Logger` class. C++ guarantees that this local `static` instance is initialized in a thread-safe fashion, so you don't need any manual thread synchronization in this version of the singleton pattern. These are so-called *magic statics*. Note that only the initialization is thread safe! If multiple threads are going to call methods on the `Logger` class, then you should make the `Logger` methods themselves thread safe as well. See Chapter 23 for a detailed discussion on synchronization mechanisms to make a class thread safe.

The implementation of the `Logger` class is fairly straightforward. Once the log file has been opened, each log message is written to it with the log level prepended. The constructor and destructor are called automatically when the `static` instance of the `Logger` class in the `instance()` method is created and destroyed. Because the constructor and destructor are private, no external code can create or delete a `Logger`. Here is the implementation:

```

#include "Logger.h"
#include <stdexcept>

using namespace std;

const char* const Logger::kLogFileName = "log.out"; /**

Logger& Logger::instance()
{
    static Logger instance;
    return instance;
}

```

```
Logger::Logger()
{
    mOutputStream.open(kLogFileName, ios_base::app);
    if (!mOutputStream.good()) {
        throw runtime_error("Unable to initialize the Logger!");
    }
}

Logger::~Logger()
{
    mOutputStream << "Logger shutting down." << endl;
    mOutputStream.close();
}

void Logger::setLogLevel(LogLevel level)
{
    mLogLevel = level;
}

string_view Logger::getLogLevelString(LogLevel level) const
{
    switch (level) {
        case LogLevel::Error:
            return "ERROR";
        case LogLevel::Info:
            return "INFO";
        case LogLevel::Debug:
            return "DEBUG";
    }
    throw runtime_error("Invalid log level.");
}

void Logger::log(string_view message, LogLevel logLevel)
{
    if (mLogLevel < logLevel) {
        return;
    }

    mOutputStream << getLogLevelString(logLevel).data()
        << ": " << message << endl;
}

void Logger::log(const vector<string>& messages, LogLevel logLevel)
{
    if (mLogLevel < logLevel) {
        return;
    }

    for (const auto& message : messages) {
        log(message, logLevel);
    }
}
```

C++17

If your compiler supports C++17 inline variables, introduced in Chapter 9, then you can remove the line marked with `/**` from the source file, and instead define it as an inline variable directly in the class definition, as follows:

```
class Logger final
{
    // Omitted for brevity

    static inline const char* const kLogFileName = "log.out";
};
```

NOTE *To focus on the actual singleton pattern, this implementation uses a hardcoded filename. Of course, in production-quality software, this filename should be configurable by the user, and you should not use relative paths, but fully qualified paths, for example, by retrieving the temporary directory for your operating system.*

Using a Singleton

The singleton `Logger` class can be tested as follows:

```
// Set log level to Debug.
Logger::instance().setLogLevel(Logger::LogLevel::Debug);

// Log some messages.
Logger::instance().log("test message", Logger::LogLevel::Debug);
vector<string> items = {"item1", "item2"};
Logger::instance().log(items, Logger::LogLevel::Error);

// Set log level to Error.
Logger::instance().setLogLevel(Logger::LogLevel::Error);
// Now that the log level is set to Error, logging a Debug
// message will be ignored.
Logger::instance().log("A debug message", Logger::LogLevel::Debug);
```

After executing, the file `log.out` contains the following lines:

```
DEBUG: test message
ERROR: item1
ERROR: item2
Logger shutting down.
```

THE ABSTRACT FACTORY PATTERN

A factory in real life constructs tangible objects, such as tables or cars. Similarly, a *factory* in object-oriented programming constructs objects. When you use factories in your program, portions of code that want to create a particular object ask the factory for an instance of the object instead of calling the object constructor themselves. For example, an interior decorating program might have

a `FurnitureFactory` object. When part of the code needs a piece of furniture such as a table, it would call the `createTable()` method of the `FurnitureFactory` object, which would return a new table.

At first glance, factories seem to lead to complicated designs without clear benefits. It appears that you're only adding another layer of complexity to the program. Instead of calling `createTable()` on a `FurnitureFactory`, you could simply create a new `Table` object directly. However, factories can actually be quite useful. Instead of creating various objects all over the program, you centralize the object creation for a particular domain.

Another benefit of factories is that you can use them alongside class hierarchies to construct objects without knowing their exact class. As you'll see in the following example, factories can run parallel to class hierarchies. This is not to say they must run parallel to class hierarchies. Factories may as well just create any number of concrete types.

Another reason to use a factory is that maybe the creation of your objects requires certain information, state, resources, and so on, owned by the factory. A factory can also be used if creating your objects requires a complex series of steps to be executed in the right order, or if all created objects need to be linked to other objects in a correct manner, and so on.

One of the main benefits is that factories abstract the object creation process; using dependency injection, you can easily substitute a different factory in your program. Just as you can use polymorphism with the created objects, you can use polymorphism with factories. The following example demonstrates this.

Example: A Car Factory Simulation

In the real world, when you talk about driving a car, you can do so without referring to the specific type of car. You could be discussing a Toyota or a Ford. It doesn't matter, because both Toyotas and Fords are drivable. Now, suppose that you want a new car. You would then need to specify whether you wanted a Toyota or a Ford, right? Not always. You could just say, "I want a car," and depending on where you were, you would get a specific car. If you said, "I want a car," in a Toyota factory, chances are you'd get a Toyota. (Or you'd get arrested, depending on how you asked.) If you said, "I want a car," in a Ford factory, you'd get a Ford.

The same concepts apply to C++ programming. The first concept, a generic car that's drivable, is nothing new; it's standard polymorphism, described in Chapter 5. You could write an abstract `Car` class that defines a virtual `drive()` method. Both `Toyota` and `Ford` could be derived classes of the `Car` class, as shown in Figure 29-2.

Your program could drive `Cars` without knowing whether they were really `Toyotas` or `Fords`. However, with standard object-oriented programming, the one place that you'd need to specify `Toyota` or `Ford` would be when you created the car. Here, you would need to call the constructor for one or the other. You couldn't just say, "I want a car." However, suppose that you also had a parallel class hierarchy of car factories. The `CarFactory` base class could define a virtual `requestCar()` method. The `ToyotaFactory` and `FordFactory` derived classes would override the `requestCar()` method to build a `Toyota` or a `Ford`. Figure 29-3 shows the `CarFactory` hierarchy.

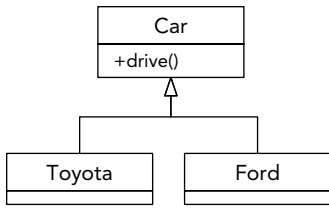

FIGURE 29-2

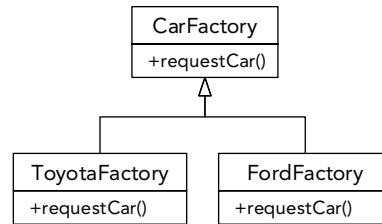

FIGURE 29-3

Now, suppose that there is one `CarFactory` object in a program. When code in the program, such as a car dealer, wants a new car, it calls `requestCar()` on the `CarFactory` object. Depending on whether that car factory is really a `ToyotaFactory` or a `FordFactory`, the code gets either a `Toyota` or a `Ford`. Figure 29-4 shows the objects in a car dealer program using a `ToyotaFactory`.

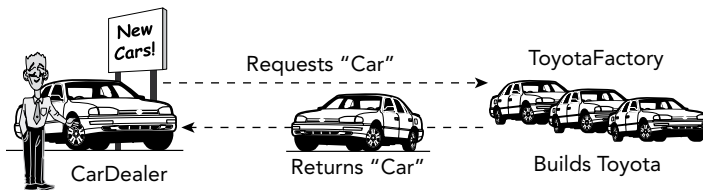

FIGURE 29-4

Figure 29-5 shows the same program, but with a `FordFactory` instead of a `ToyotaFactory`. Note that the `CarDealer` object and its relationship with the factory stay the same.

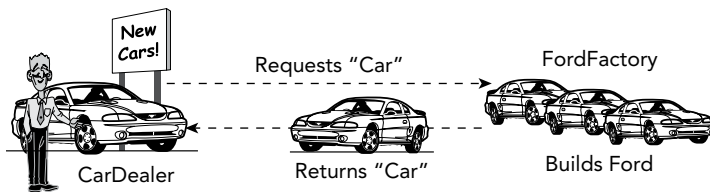

FIGURE 29-5

This example demonstrates using polymorphism with factories. When you ask the car factory for a car, you might not know whether it's a Toyota factory or a Ford factory, but either way it will give you a `Car` that you can drive. This approach leads to easily extensible programs; simply changing the factory instance can allow the program to work on a completely different set of objects and classes.

Implementation of a Factory

One reason for using factories is that the type of the object you want to create may depend on some condition. For example, if you want a car, you might want to put your order into the factory that

has received the fewest requests so far, regardless of whether the car you eventually get is a Toyota or a Ford. The following implementation shows how to write such factories in C++.

The first thing you'll need is the hierarchy of cars. To keep this example concise, the `Car` class simply has an abstract method that returns a description of the car:

```
class Car
{
public:
    virtual ~Car() = default; // Always a virtual destructor!
    virtual std::string_view info() const = 0;
};

class Ford : public Car
{
public:
    virtual std::string_view info() const override { return "Ford"; }
};

class Toyota : public Car
{
public:
    virtual std::string_view info() const override { return "Toyota"; }
};
```

The `CarFactory` base class is a bit more interesting. Each factory keeps track of the number of cars produced. When the public `requestCar()` method is called, the number of cars produced at the factory is increased by one, and the pure virtual `createCar()` method is called, which creates and returns a new car. The idea is that individual factories override `createCar()` to return the appropriate type of car. The `CarFactory` itself implements `requestCar()`, which takes care of updating the number of cars produced. The `CarFactory` also provides a public method to query the number of cars produced at each factory.

The class definitions for the `CarFactory` class and derived classes are as follows:

```
#include "Car.h"
#include <cstdint>
#include <memory>

class CarFactory
{
public:
    virtual ~CarFactory() = default; // Always a virtual destructor!
    std::unique_ptr<Car> requestCar();
    size_t getNumberOfCarsProduced() const;

protected:
    virtual std::unique_ptr<Car> createCar() = 0;

private:
    size_t mNumberOfCarsProduced = 0;
};
```



```

class FordFactory : public CarFactory
{
    protected:
        virtual std::unique_ptr<Car> createCar() override;
};

class ToyotaFactory : public CarFactory
{
    protected:
        virtual std::unique_ptr<Car> createCar() override;
};

```

As you can see, the derived classes simply override `createCar()` to return the specific type of car that they produce. The implementation of the `CarFactory` hierarchy is as follows:

```

// Increment the number of cars produced and return the new car.
std::unique_ptr<Car> CarFactory::requestCar()
{
    ++mNumberOfCarsProduced;
    return createCar();
}

size_t CarFactory::getNumberOfCarsProduced() const
{
    return mNumberOfCarsProduced;
}

std::unique_ptr<Car> FordFactory::createCar()
{
    return std::make_unique<Ford>();
}

std::unique_ptr<Car> ToyotaFactory::createCar()
{
    return std::make_unique<Toyota>();
}

```

The implementation approach used in this example is called an *abstract factory* because the type of object created depends on which *concrete* derived class of the factory class is being used. A similar pattern can be implemented in a single class instead of a class hierarchy. In that case, a single `create()` method takes a type or string parameter from which it decides which object to create. For example, a `CarFactory` class could provide a `requestCar()` method that takes a string representing the type of car to build, and constructs the appropriate car.

NOTE *Factory methods are one way to implement virtual constructors, which are methods that create objects of different types. For example, the `requestCar()` method creates both Toyotas and Fords, depending on the concrete factory object on which it is called.*

Using a Factory

The simplest way to use a factory is to instantiate it and to call the appropriate method, as in the following piece of code:

```
ToyotaFactory myFactory;
auto myCar = myFactory.requestCar();
cout << myCar->info() << endl;    // Outputs Toyota
```

A more interesting example makes use of the virtual constructor idea to build a car in the factory that has the fewest cars produced. To do this, you can create a new factory, called `LeastBusyFactory`, that derives from `CarFactory` and that accepts a number of other `CarFactory` objects in its constructor. As all `CarFactory` classes have to do, `LeastBusyFactory` overrides the `createCar()` method. Its implementation finds the least busy factory in the list of factories passed to the constructor, and asks that factory to create a car. Here is the implementation of such a factory:

```
class LeastBusyFactory : public CarFactory
{
public:
    // Constructs a LeastBusyFactory instance, taking ownership of
    // the given factories.
    explicit LeastBusyFactory(vector<unique_ptr<CarFactory>>&& factories);

protected:
    virtual unique_ptr<Car> createCar() override;

private:
    vector<unique_ptr<CarFactory>> mFactories;
};

LeastBusyFactory::LeastBusyFactory(vector<unique_ptr<CarFactory>>&& factories)
    : mFactories(std::move(factories))
{
    if (mFactories.empty())
        throw runtime_error("No factories provided.");
}

unique_ptr<Car> LeastBusyFactory::createCar()
{
    CarFactory* bestSoFar = mFactories[0].get();

    for (auto& factory : mFactories) {
        if (factory->getNumberOfCarsProduced() <
            bestSoFar->getNumberOfCarsProduced()) {
            bestSoFar = factory.get();
        }
    }

    return bestSoFar->requestCar();
}
```

The following code makes use of this factory to build ten cars, whatever brand they might be, from the factory that has produced the least number of cars.

```

vector<unique_ptr<CarFactory>> factories;

// Create 3 Ford factories and 1 Toyota factory.
factories.push_back(make_unique<FordFactory>());
factories.push_back(make_unique<FordFactory>());
factories.push_back(make_unique<FordFactory>());
factories.push_back(make_unique<ToyotaFactory>());

// To get more interesting results, preorder some cars.
factories[0]->requestCar();
factories[0]->requestCar();
factories[1]->requestCar();
factories[3]->requestCar();

// Create a factory that automatically selects the least busy
// factory from a list of given factories.
LeastBusyFactory leastBusyFactory(std::move(factories));

// Build 10 cars from the least busy factory.
for (size_t i = 0; i < 10; i++) {
    auto theCar = leastBusyFactory.requestCar();
    cout << theCar->info() << endl;
}

```

When executed, the program prints out the make of each car produced:

```

Ford
Ford
Ford
Toyota
Ford
Ford
Ford
Toyota
Ford
Ford

```

The results are rather predictable because the loop effectively iterates through the factories in a round-robin fashion. However, one could imagine a scenario where multiple dealers are requesting cars, and the current status of each factory isn't quite so predictable.

Other Uses of Factories

You can also use the factory pattern for more than just modeling real-world factories. For example, consider a word processor in which you want to support documents in different languages, where each document uses a single language. There are many aspects of the word processor in which the choice of document language requires different support: the character set used in the document (whether or not accented characters are needed), the spell checker, the thesaurus, and the way the document is displayed, to name just a few. You could use factories to design a clean word processor by writing an abstract `LanguageFactory` base class and concrete factories for each language of interest, such as `EnglishLanguageFactory` and `FrenchLanguageFactory`. When the user specifies a language for a document, the program instantiates the appropriate language factory and attaches it to the document. From then on, the program doesn't need to know which language is

supported in the document. When it needs a language-specific piece of functionality, it can just ask the `LanguageFactory`. For example, when it needs a spell checker, it can call the `createSpell-checker()` method on the factory, which will return a spell checker in the appropriate language.

THE PROXY PATTERN

The *proxy* pattern is one of several patterns that divorce the abstraction of a class from its underlying representation. A proxy object serves as a stand-in for a real object. Such objects are generally used when using the real object would be time-consuming or impossible. For example, take a document editor. A document could contain several big objects, such as images. Instead of loading all those images when opening the document, the document editor could substitute all images with image proxies. These proxies don't immediately load the images. Only when the user scrolls down in the document and reaches an image, does the document editor ask the image proxy to draw itself. At that time, the proxy delegates the work to the real image class, which loads the image.

Example: Hiding Network Connectivity Issues

Consider a networked game with a `Player` class that represents a person on the Internet who has joined the game. The `Player` class includes functionality that requires network connectivity, such as an instant messaging feature. If a player's connection becomes slow or unresponsive, the `Player` object representing that person can no longer receive instant messages.

Because you don't want to expose network problems to the user, it may be desirable to have a separate class that hides the networked parts of a `Player`. This `PlayerProxy` object would substitute for the actual `Player` object. Either clients of the class would use the `PlayerProxy` class at all times as a gatekeeper to the real `Player` class, or the system would substitute a `PlayerProxy` when a `Player` became unavailable. During a network failure, the `PlayerProxy` object could still display the player's name and last-known state, and could continue to function when the original `Player` object could not. Thus, the proxy class hides some undesirable semantics of the underlying `Player` class.

Implementation of a Proxy

The first step is defining an `IPlayer` interface containing the public interface for a `Player`.

```
class IPlayer
{
    public:
        virtual std::string getName() const = 0;
        // Sends an instant message to the player over the network and
        // returns the reply as a string.
        virtual std::string sendInstantMessage(
            std::string_view message) const = 0;
};
```

The `Player` class definition then becomes as follows. The `sendInstantMessage()` method of a `Player` requires network connectivity to properly function.

```
class Player : public IPlayer
{
    public:
```

```

        virtual std::string getName() const override;
        // Network connectivity is required.
        virtual std::string sendInstantMessage(
            std::string_view message) const override;
    };

```

The `PlayerProxy` class also derives from `IPlayer`, and contains another `IPlayer` instance (the ‘real’ `Player`):

```

class PlayerProxy : public IPlayer
{
public:
    // Create a PlayerProxy, taking ownership of the given player.
    PlayerProxy(std::unique_ptr<IPlayer> player);
    virtual std::string getName() const override;
    // Network connectivity is optional.
    virtual std::string sendInstantMessage(
        std::string_view message) const override;

private:
    std::unique_ptr<IPlayer> mPlayer;
};

```

The constructor takes ownership of the given `IPlayer`:

```

PlayerProxy::PlayerProxy(std::unique_ptr<IPlayer> player)
    : mPlayer(std::move(player))
{
}

```

The implementation of the `PlayerProxy`’s `sendInstantMessage()` method checks the network connectivity, and either returns a default string or forwards the request.

```

std::string PlayerProxy::sendInstantMessage(std::string_view message) const
{
    if (hasNetworkConnectivity())
        return mPlayer->sendInstantMessage(message);
    else
        return "The player has gone offline.";
}

```

Using a Proxy

If a proxy is well written, using it should be no different from using any other object. For the `PlayerProxy` example, the code that uses the proxy could be completely unaware of its existence. The following function, designed to be called when the `Player` has won, could be dealing with an actual `Player` or a `PlayerProxy`. The code is able to handle both cases in the same way because the proxy ensures a valid result.

```

bool informWinner(const IPlayer& player)
{
    auto result = player.sendInstantMessage("You have won! Play again?");
    if (result == "yes") {
        cout << player.getName() << " wants to play again." << endl;
        return true;
    }
}

```

```
    } else {  
        // The player said no, or is offline.  
        cout << player.getName() << " does not want to play again." << endl;  
        return false;  
    }  
}
```

THE ADAPTOR PATTERN

The motivation for changing the abstraction given by a class is not always driven by a desire to hide functionality. Sometimes, the underlying abstraction cannot be changed but it doesn't suit the current design. In this case, you can build an *adaptor* or *wrapper* class. The adaptor provides the abstraction that the rest of the code uses and serves as the bridge between the desired abstraction and the actual underlying code. Chapter 17 discusses how the Standard Library uses the adaptor pattern to implement containers like `stack` and `queue` in terms of other containers, such as `deque` and `list`.

Example: Adapting a Logger Class

For this adaptor pattern example, let's assume a very basic `Logger` class. Here is the class definition:

```
class Logger  
{  
    public:  
        enum class LogLevel {  
            Error,  
            Info,  
            Debug  
        };  
  
        Logger();  
        virtual ~Logger() = default; // Always a virtual destructor!  
  
        void log(LogLevel level, std::string message);  
    private:  
        // Converts a log level to a human readable string.  
        std::string_view getLogLevelString(LogLevel level) const;  
};
```

And here are the implementations:

```
Logger::Logger()  
{  
    cout << "Logger constructor" << endl;  
}  
  
void Logger::log(LogLevel level, std::string message)  
{  
    cout << getLogLevelString(level).data() << ": " << message << endl;  
}  
  
string_view Logger::getLogLevelString(LogLevel level) const  
{  
    // Same implementation as the Singleton logger earlier in this chapter.  
}
```

The `Logger` class has a constructor, which outputs a line of text to the standard console, and a method called `log()` that writes the given message to the console prefixed with a log level.

One reason why you might want to write a wrapper class around this basic `Logger` class is to change its interface. Maybe you are not interested in the log level and you would like to call the `log()` method with only one parameter, the actual message. You might also want to change the interface to accept an `std::string_view` instead of an `std::string` as parameter for the `log()` method.

Implementation of an Adaptor

The first step in implementing the adaptor pattern is to define the new interface for the underlying functionality. This new interface is called `NewLoggerInterface` and looks like this:

```
class NewLoggerInterface
{
public:
    virtual ~NewLoggerInterface() = default; // Always virtual destructor!
    virtual void log(std::string_view message) = 0;
};
```

This class is an abstract class, which declares the desired interface that you want for your new logger. The interface only defines one abstract method, that is, a `log()` method accepting only a single argument of type `string_view`, which needs to be implemented by any class implementing this interface.

The next step is to write the actual new logger class, `NewLoggerAdaptor`, which implements `NewLoggerInterface` so that it has the interface that you designed. The implementation wraps a `Logger` instance; it uses composition.

```
class NewLoggerAdaptor : public NewLoggerInterface
{
public:
    NewLoggerAdaptor();
    virtual void log(std::string_view message) override;
private:
    Logger mLogger;
};
```

The constructor of the new class writes a line to standard output to keep track of which constructors are being called. The code then implements the `log()` method from `NewLoggerInterface` by forwarding the call to the `log()` method of the `Logger` instance that is wrapped. In that call, the given `string_view` is converted to a `string`, and the log level is hard-coded as `Info`:

```
NewLoggerAdaptor::NewLoggerAdaptor()
{
    cout << "NewLoggerAdaptor constructor" << endl;
}

void NewLoggerAdaptor::log(string_view message)
{
    mLogger.log(Logger::LogLevel::Info, message.data());
}
```

Using an Adaptor

Because adaptors exist to provide a more appropriate interface for the underlying functionality, their use should be straightforward and specific to the particular case. Given the previous implementation, the following code snippet uses the new simplified interface for the `Logger` class:

```
NewLoggerAdaptor logger;
logger.log("Testing the logger.");
```

It produces the following output:

```
Logger constructor
NewLoggerAdaptor constructor
INFO: Testing the logger.
```

THE DECORATOR PATTERN

The *decorator* pattern is exactly what it sounds like: a “decoration” on an object. It is also often called a *wrapper*. The pattern is used to add or change the behavior of an object at run time. Decorators are a lot like derived classes, but their effects can be temporary. For example, if you have a stream of data that you are parsing and you reach data that represents an image, you could temporarily decorate the stream object with an `ImageStream` object. The `ImageStream` constructor would take the stream object as a parameter and would have built-in knowledge of image parsing. Once the image is parsed, you could continue using the original object to parse the remainder of the stream. The `ImageStream` acts as a decorator because it adds new functionality (image parsing) to an existing object (a stream).

Example: Defining Styles in Web Pages

As you may already know, web pages are written in a simple text-based structure called HyperText Markup Language (HTML). In HTML, you can apply styles to a text by using style tags, such as `` and `` for bold and `<I>` and `</I>` for italic. The following line of HTML displays the message in bold:

```
<B>A party? For me? Thanks!</B>
```

The following line displays the message in bold and italic:

```
<I><B>A party? For me? Thanks!</B></I>
```

Suppose you are writing an HTML editing application. Your users will be able to type in paragraphs of text and apply one or more styles to them. You *could* make each type of paragraph a new derived class, as shown in Figure 29-6, but that design could be cumbersome and would grow exponentially as new styles were added.

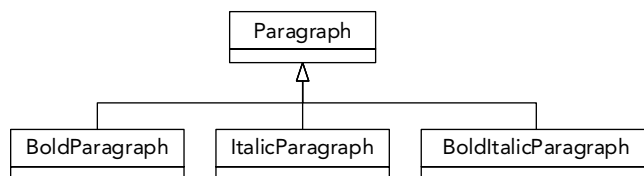

FIGURE 29-6

The alternative is to consider styled paragraphs not as *types* of paragraphs, but as *decorated* paragraphs. This leads to situations like the one shown in Figure 29-7, where an `ItalicParagraph` operates on a `BoldParagraph`, which in turn operates on a `Paragraph`. The recursive decoration of objects nests the styles in code just as they are nested in HTML.

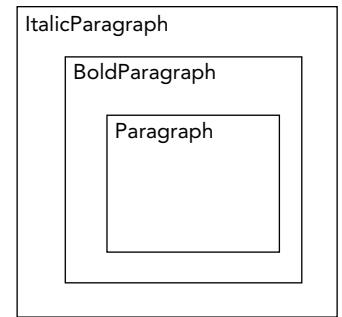

FIGURE 29-7

Implementation of a Decorator

To start, you need an `IParagraph` interface:

```
class IParagraph
{
    public:
        virtual ~IParagraph() = default; // Always a virtual destructor!
        virtual std::string getHTML() const = 0;
};
```

The `Paragraph` class implements this `IParagraph` interface:

```
class Paragraph : public IParagraph
{
    public:
        Paragraph(std::string_view text) : mText(text) {}
        virtual std::string getHTML() const override { return mText; }
    private:
        std::string mText;
};
```

To decorate a `Paragraph` with zero or more styles, you need styled `IParagraph` classes, each one constructible from an existing `IParagraph`. This way, they can all decorate a `Paragraph` or a styled `IParagraph`. The `BoldParagraph` class derives from `IParagraph` and implements `getHTML()`. However, because you only intend to use it as a decorator, its single public non-copy constructor takes a `const` reference to an `IParagraph`.

```
class BoldParagraph : public IParagraph
{
    public:
        BoldParagraph(const IParagraph& paragraph) : mWrapped(paragraph) {}

        virtual std::string getHTML() const override {
            return "<B>" + mWrapped.getHTML() + "</B>";
        }
    private:
        const IParagraph& mWrapped;
};
```

The `ItalicParagraph` class is almost identical:

```
class ItalicParagraph : public IParagraph
{
    public:
        ItalicParagraph(const IParagraph& paragraph) : mWrapped(paragraph) {}
```

```
        virtual std::string getHTML() const override {  
            return "<I>" + mWrapped.getHTML() + "</I>";  
        }  
    private:  
        const IParagraph& mWrapped;  
};
```

Using a Decorator

From the user's point of view, the decorator pattern is appealing because it is very easy to apply, and is transparent once applied. The user doesn't need to know that a decorator has been employed at all. A `BoldParagraph` behaves just like a `Paragraph`.

Here is a quick example that creates and outputs a paragraph, first in bold, then in bold and italic:

```
Paragraph p("A party? For me? Thanks!");  
// Bold  
std::cout << BoldParagraph(p).getHTML() << std::endl;  
// Bold and Italic  
std::cout << ItalicParagraph(BoldParagraph(p)).getHTML() << std::endl;
```

The output is as follows:

```
<B>A party? For me? Thanks!</B>  
<I><B>A party? For me? Thanks!</B></I>
```

THE CHAIN OF RESPONSIBILITY PATTERN

A *chain of responsibility* is used when you want a number of objects to get a crack at performing a particular action. The technique can employ polymorphism so that the most specific class gets called first and can either handle the call or pass it up to its parent. The parent then makes the same decision—it can handle the call or pass it up to its parent. A chain of responsibility does not necessarily have to follow a class hierarchy, but it typically does.

Chains of responsibility are perhaps most commonly used for event handling. Many modern applications, particularly those with graphical user interfaces, are designed as a series of events and responses. For example, when a user clicks on the *File* menu and selects *Open*, an open event has occurred. When the user moves the mouse over the drawable area of a paint program, mouse move events are generated continuously. If the user presses down a button on the mouse, a mouse down event for that button-press is generated. The program can then start paying attention to the mouse move events, allowing the user to “draw” some object, and continue doing this until the mouse up event occurs. Each operating system has its own way of naming and using these events, but the overall idea is the same: when an event occurs, it is somehow communicated to the program, which takes appropriate action.

As you know, C++ does not have any built-in facilities for graphical programming. It also has no notion of events, event transmission, or event handling. A chain of responsibility is a reasonable approach to event handling to give different objects a chance to handle certain events.

Example: Event Handling

Consider a drawing program, which has a hierarchy of Shape classes, as in Figure 29-8.

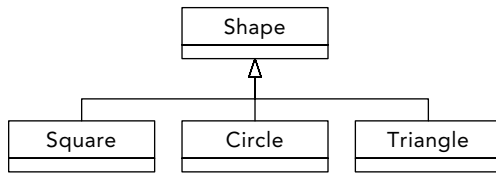

FIGURE 29-8

The leaf nodes can handle certain events. For example, `Circle` can receive mouse move events to change the radius of the circle. The parent class handles events that have the same effect, regardless of the particular shape. For example, a delete event is handled the same way, regardless of the type of shape being deleted. With a chain of responsibility, the leaf nodes get the first crack at handling a particular event. If that leaf node cannot handle the event, it explicitly forwards the event to the next handler in the chain, and so on. For example, if a mouse down event occurs on a `Square` object, first the `Square` gets a chance to handle the event. If it doesn't handle the event, it forwards the event to the next handler in the chain, which is the `Shape` class for this example. Now the `Shape` class gets a crack at handling the event. If `Shape` can't handle the event either, it could forward it to its parent if it had one, and so on. This continues all the way up the chain. It's a chain of responsibility because each handler may either handle the event, or pass the event up to the next handler in the chain.

Implementation of a Chain of Responsibility

The code for a chained messaging approach varies based on how your operating system handles events, but it tends to resemble the following code, which uses integers to represent types of events:

```

void Square::handleMessage(int message)
{
    switch (message) {
        case kMessageMouseDown:
            handleMouseDown();
            break;
        case kMessageInvert:
            handleInvert();
            break;
        default:
            // Message not recognized--chain to base class.
            Shape::handleMessage(message);
    }
}
  
```

```

void Shape::handleMessage(int message)
{
    switch (message) {
        case kMessageDelete:
            handleDelete();
            break;
        default:
            {
                stringstream ss;
                ss << __func__ << ": Unrecognized message received: " << message;
                throw invalid_argument(ss.str());
            }
    }
}

```

When the event-handling portion of the program or framework receives a message, it finds the corresponding shape and calls `handleMessage()`. Through polymorphism, the derived class's version of `handleMessage()` is called. This gives the leaf node the first chance at handling the message. If it doesn't know how to handle the message, it passes it up to its base class, which gets the next chance. In this example, the final recipient of the message throws an exception if it is unable to handle the event. You could also have your `handleMessage()` method return a Boolean indicating success or failure.

This chain of responsibility example can be tested as follows. For the chain to respond to events, there must be another class that *dispatches* the events to the correct object. Because this task varies greatly by framework or platform, the following example shows pseudo-code for handling a mouse down event, in lieu of platform-specific C++ code:

```

MouseListener loc = getClickLocation();
Shape* clickedShape = findShapeAtLocation(loc);
if (clickedShape)
    clickedShape->handleMessage(kMessageMouseDown);

```

The chained approach is flexible and has a very appealing structure for object-oriented hierarchies. The downside is that it requires diligence on the part of the programmer. If you forget to chain up to the base class from a derived class, events will effectively get lost. Worse, if you chain to the wrong class, you could end up in an infinite loop! Note that while event chains usually correlate with a class hierarchy, they do not have to. In the preceding example, the `Square` class could have just as easily passed the message to an entirely different object. An example of such a chain of responsibility is given in the next section.

Chain of Responsibility without Hierarchy

If the different handlers in a chain of responsibility are not related by a class hierarchy, you need to keep track of the chain yourself. Here is an example. First, a `Handler` mixin class is defined:

```

class Handler
{
public:
    virtual ~Handler() = default;

    Handler(Handler* nextHandler) : mNextHandler(nextHandler) { }

```

```

        virtual void handleMessage(int message)
        {
            if (mNextHandler)
                mNextHandler->handleMessage(message);
        }
    private:
        Handler* mNextHandler;
};

```

Next, two concrete handlers are defined, both deriving from the `Handler` mixin. The first handles only messages with ID 1, and the second handles only messages with ID 2. If any of the handlers receives a message it doesn't know about, it calls the next handler in the chain.

```

class ConcreteHandler1 : public Handler
{
    public:
        ConcreteHandler1(Handler* nextHandler) : Handler(nextHandler) {}

        void handleMessage(int message) override
        {
            cout << "ConcreteHandler1::handleMessage()" << endl;
            if (message == 1)
                cout << "Handling message " << message << endl;
            else {
                cout << "Not handling message " << message << endl;
                Handler::handleMessage(message);
            }
        }
};

class ConcreteHandler2 : public Handler
{
    public:
        ConcreteHandler2(Handler* nextHandler) : Handler(nextHandler) {}

        void handleMessage(int message) override
        {
            cout << "ConcreteHandler2::handleMessage()" << endl;
            if (message == 2)
                cout << "Handling message " << message << endl;
            else {
                cout << "Not handling message " << message << endl;
                Handler::handleMessage(message);
            }
        }
};

```

This implementation can be tested as follows:

```

ConcreteHandler2 handler2(nullptr);
ConcreteHandler1 handler1(&handler2);

handler1.handleMessage(1);
cout << endl;

```

```
handler1.handleMessage(2);  
cout << endl;  
  
handler1.handleMessage(3);
```

The output is as follows:

```
ConcreteHandler1::handleMessage()  
Handling message 1  
  
ConcreteHandler1::handleMessage()  
Not handling message 2  
ConcreteHandler2::handleMessage()  
Handling message 2  
  
ConcreteHandler1::handleMessage()  
Not handling message 3  
ConcreteHandler2::handleMessage()  
Not handling message 3
```

THE OBSERVER PATTERN

The *observer* pattern is used to have objects/observers get notified by observable objects. With the observer pattern, individual objects *register* themselves with the observable object they are interested in. When the observable object's state changes, it notifies all registered observers of this change.

The main benefit of using the observer pattern is that it decreases coupling. The observable class does not need to know the concrete observer types that are observing it. The observable class only needs to know about a basic interface, for example `IObserver`.

Implementation of an Observer

First, an `IObserver` interface is defined. Any object that wants to observe an observable should implement this interface:

```
class IObserver  
{  
    public:  
        virtual ~IObserver() = default; // Always a virtual destructor!  
        virtual void notify() = 0;  
};
```

Here are two concrete observers that simply print out a message in response to a notification:

```
class ConcreteObserver1 : public IObserver  
{  
    public:  
        void notify() override  
        {  
            std::cout << "ConcreteObserver1::notify()" << std::endl;  
        }  
};  
  
class ConcreteObserver2 : public IObserver  
{
```

```

public:
    void notify() override
    {
        std::cout << "ConcreteObserver2::notify()" << std::endl;
    }
};

```

Implementation of an Observable

An observable just keeps a list of `IObservers` that have registered themselves to get notified. It needs to support adding and removing observers, and should be able to notify all registered observers. All this functionality can be provided by an `Observable` mixin class. Here is the implementation:

```

class Observable
{
public:
    virtual ~Observable() = default; // Always a virtual destructor!

    // Add an observer. Ownership is not transferred.
    void addObserver(IObserver* observer)
    {
        mObservers.push_back(observer);
    }

    // Remove the given observer.
    void removeObserver(IObserver* observer)
    {
        mObservers.erase(
            std::remove(begin(mObservers), end(mObservers), observer),
            end(mObservers));
    }

protected:
    void notifyAllObservers()
    {
        for (auto* observer : mObservers)
            observer->notify();
    }

private:
    std::vector<IObserver*> mObservers;
};

```

A concrete class, `ObservableSubject`, that wants to be observable simply derives from the `Observable` mixin class to get all its functionality. Whenever the state of an `ObservableSubject` changes, it simply calls `notifyAllObservers()` to notify all registered observers.

```

class ObservableSubject : public Observable
{
public:
    void modifyData()
    {
        // ...
        notifyAllObservers();
    }
};

```

Using an Observer

Following is a very simple test that demonstrates how to use the observer pattern.

```
ObservableSubject subject;

ConcreteObserver1 observer1;
subject.addObserver(&observer1);

subject.modifyData();

std::cout << std::endl;

ConcreteObserver2 observer2;
subject.addObserver(&observer2);

subject.modifyData();
```

The output is as follows:

```
ConcreteObserver1::notify()

ConcreteObserver1::notify()
ConcreteObserver2::notify()
```

SUMMARY

This chapter has given you just a taste of how patterns can help you organize object-oriented concepts into high-level designs. A lot of design patterns are cataloged and discussed on Wikipedia¹. It's easy to get carried away and spend all your time trying to find the specific pattern that applies to your task. Instead, I recommend that you concentrate on a few patterns that interest you and focus your learning on how patterns are developed, not just the small differences between similar ones. After all, to paraphrase the old saying, "Teach me a design pattern, and I'll code for a day. Teach me how to *create* design patterns, and I'll code for a lifetime."

¹https://en.wikipedia.org/wiki/Software_design_pattern

30

Developing Cross-Platform and Cross-Language Applications

WHAT'S IN THIS CHAPTER?

- ▶ How to write code that runs on multiple platforms
- ▶ How to mix different programming languages together

C++ programs can be compiled to run on a variety of computing platforms, and the language has been rigorously defined to ensure that programming in C++ for one platform is very similar to programming in C++ for another. Yet, despite the standardization of the language, platform differences eventually come into play when writing professional-quality programs in C++. Even when development is limited to a particular platform, small differences in compilers can elicit major programming headaches. This chapter examines the necessary complication of programming in a world with multiple platforms and multiple programming languages.

The first part of this chapter surveys the platform-related issues that C++ programmers encounter. A *platform* is the collection of all of the details that make up your development and/or run-time system. For example, your platform may be the Microsoft Visual C++ 2017 compiler running on Windows 10 on an Intel Core i7 processor. Alternatively, your platform might be the GCC 7.2 compiler running on Linux on a PowerPC processor. Both of these platforms are able to compile and run C++ programs, but there are significant differences between them.

The second part of this chapter looks at how C++ can interact with other programming languages. While C++ is a general-purpose language, it may not always be the right tool for the job. Through a variety of mechanisms, you can integrate C++ with other languages that may better serve your needs.

CROSS-PLATFORM DEVELOPMENT

There are several reasons why the C++ language encounters platform issues. C++ is a high-level language, and the standard does not specify certain low-level details. For example, the layout of an object in memory is undefined by the standard and left to the compiler. Different compilers can use different memory layouts for objects. C++ also faces the challenge of providing a standard language and a Standard Library without a standard implementation. Varying interpretations of the specification among C++ compiler and library vendors can lead to trouble when moving from one system to another. Finally, C++ is selective in what the language provides as standard. Despite the presence of a Standard Library, programs often need functionality that is not provided by the language or the Standard Library. This functionality generally comes from third-party libraries or the platform, and can vary greatly.

Architecture Issues

The term *architecture* generally refers to the processor, or family of processors, on which a program runs. A standard PC running Windows or Linux generally runs on the x86 or x64 architecture, and older versions of Mac OS were usually found on the PowerPC architecture. As a high-level language, C++ shields you from the differences between these architectures. For example, a Core i7 processor may have a single instruction that performs the same functionality as six PowerPC instructions. As a C++ programmer, you don't need to know what this difference is or even that it exists. One advantage to using a high-level language is that the compiler takes care of converting your code into the processor's native assembly code format.

However, processor differences do sometimes rise up to the level of C++ code. The first one discussed, the size of integers, is very important if you are writing cross-platform code. The others you won't face often, unless you are doing particularly low-level work, but still, you should be aware that they exist.

Size of Integers

The C++ standard does not define the exact size of integer types. The standard just says the following:

There are five standard signed integer types: signed char, short int, int, long int, and long long int. In this list, each type provides at least as much storage as those preceding it in the list.

The standard does give a few additional hints for the size of these types, but never an exact size. The actual size is compiler-dependent. Thus, if you want to write cross-platform code, you cannot really rely on these types.

Besides these standard integer types, the C++ standard does define a number of types that have clearly specified sizes, all defined in the `<cstdint>` header file, although some of the types are optional. Here is an overview:

TYPE	DESCRIPTION
<code>int8_t</code> <code>int16_t</code> <code>int32_t</code> <code>int64_t</code>	Signed integers of which the size is exactly 8, 16, 32, or 64 bits. This type is defined by the standard as being optional, although most compilers support it.
<code>int_fast8_t</code> <code>int_fast16_t</code> <code>int_fast32_t</code> <code>int_fast64_t</code>	Signed integers with sizes of at least 8, 16, 32, or 64 bits. For these, the compiler should use the fastest integer type it has that satisfies the requirements.
<code>int_least8_t</code> <code>int_least16_t</code> <code>int_least32_t</code> <code>int_least64_t</code>	Signed integers with sizes of at least 8, 16, 32, or 64 bits. For these, the compiler should use the smallest integer type it has that satisfies the requirements.
<code>intmax_t</code>	An integer type with the maximum size supported by the compiler.
<code>intptr_t</code>	An integer type big enough to store a pointer. This type is also optional, but most compilers support it.

There are also unsigned versions available, such as `uint8_t`, `uint_fast8_t`, and so on.

If you want to write cross-platform code, I recommend you to use these `<cstdint>` types instead of the basic integer types.

Binary Compatibility

As you probably already know, you cannot take a program written and compiled for a Core i7 computer and run it on a PowerPC-based Mac. These two platforms are not *binary compatible* because their processors do not support the same set of instructions. When you compile a C++ program, your source code is turned into binary instructions that the computer executes. That binary format is defined by the platform, not by the C++ language.

One solution to support platforms that are not binary compatible is to build each version separately with a compiler on each target platform.

Another solution is *cross-compiling*. When you are using platform X for your development, but you want your program to run on platforms Y and Z, you can use a cross-compiler on your platform X that generates binary code for platforms Y and Z.

You can also make your program *open source*. When you make your source available to the end user, she can compile it natively on her system and build a version of the program that is in the correct binary format for her machine. As discussed in Chapter 4, open-source software has become increasingly popular. One of the major reasons is that it allows programmers to collaboratively develop software and increase the number of platforms on which it can run.

Address Sizes

When someone describes an architecture as *32-bit*, they most likely mean that the *address* size is 32 bits, or 4 bytes. In general, a system with a larger address size can handle more memory and might operate more quickly on complex programs.

Because pointers are memory addresses, they are inherently tied to address sizes. Many programmers are taught that pointers are always 4 bytes, but this is wrong. For example, consider the following code snippet, which outputs the size of a pointer:

```
int *ptr = nullptr;
cout << "ptr size is " << sizeof(ptr) << " bytes" << endl;
```

If this program is compiled and run on a 32-bit x86 system, the output will be as follows:

```
ptr size is 4 bytes
```

If you compile it with a 64-bit compiler and run it on an x64 system, the output will be as follows:

```
ptr size is 8 bytes
```

From a programmer's point of view, the upshot of varying pointer sizes is that you cannot equate a pointer with 4 bytes. More generally, you need to be aware that most sizes are not prescribed by the C++ standard. The standard only says that a short integer has as much, or less, space than an integer, which has as much, or less, space than a long integer.

The size of a pointer is also not necessarily the same as the size of an integer. For example, on a 64-bit platform, pointers are 64 bit, but integers could be 32 bit. Casting a 64-bit pointer to a 32-bit integer will result in losing 32 critical bits! The standard does define an `std::intptr_t` integer type in `<stdint.h>` which is an integer type at least big enough to hold a pointer. The definition of this type is optional according to the standard, but virtually all compilers support it.

WARNING *Never assume that a pointer is 32 bits or 4 bytes. Never cast a pointer to an integer, unless you use `std::intptr_t`.*

Byte Order

All modern computers store numbers in a binary representation, but the representation of the same number on two platforms may not be identical. This sounds contradictory, but as you'll see, there are two approaches to reading numbers that both make sense.

A single slot in your computer's memory is usually a byte because most computers are *byte addressable*. Number types in C++ are usually multiple bytes. For example, a `short` may be 2 bytes. Imagine that your program contains the following line:

```
short myShort = 513;
```

In binary, the number 513 is 0000 0010 0000 0001. This number contains 16 ones and zeros, or 16 bits. Because there are 8 bits in a byte, the computer needs 2 bytes to store the number. Because each individual memory address contains 1 byte, the computer needs to split the number up into multiple bytes. Assuming that a `short` is 2 bytes, the number is split into two even parts. The higher part of the number is put into the *high-order byte* and the lower part of the number is put into the *low-order byte*. In this case, the high-order byte is 0000 0010 and the low-order byte is 0000 0001.

Now that the number has been split up into memory-sized parts, the only question that remains is how to store them in memory. Two bytes are needed, but the order of the bytes is unclear and, in fact, depends on the architecture of the system in question.

One way to represent the number is to put the high-order byte first in memory and the low-order byte next. This strategy is called *big-endian ordering* because the bigger part of the number comes first. PowerPC and SPARC processors use a big-endian approach. Some other processors, such as x86, arrange the bytes in the opposite order, putting the low-order byte first in memory. This approach is called *little-endian ordering* because the smaller part of the number comes first. An architecture may choose one approach or the other, usually based on backward compatibility. For the curious, the terms “big-endian” and “little-endian” predate modern computers by several hundred years. Jonathan Swift coined the terms in his eighteenth-century novel *Gulliver's Travels* to describe the opposing camps of a debate about the proper end on which to break an egg.

Regardless of the *ordering* a particular architecture uses, your programs can continue to use numerical values without paying any attention to whether the machine uses big-endian ordering or little-endian ordering. The ordering only comes into play when data moves between architectures. For example, if you are sending binary data across a network, you may need to consider the ordering of the other system. One solution is to use the standard network byte ordering, which is always big-endian. So, before sending data across a network, you convert it to big-endian, and whenever you receive data from a network, you convert it from big-endian to the byte ordering of your system.

Similarly, if you are writing binary data to a file, you may need to consider what will happen when that file is opened on a system with opposite byte ordering.

Implementation Issues

When a C++ compiler is written, it is designed by a human being who attempts to adhere to the C++ standard. Unfortunately, the C++ standard is more than a thousand pages long and written in a combination of prose, language grammars, and examples. Two human beings implementing a compiler according to such a standard are unlikely to interpret every piece of prescribed information in the exact same way or to catch every single edge case. As a result, compilers will have bugs.

Compiler Quirks and Extensions

There is no simple rule for finding or avoiding compiler bugs. The best you can do is to stay up to speed on compiler updates and perhaps subscribe to a mailing list or newsgroup for your compiler.

If you suspect that you have encountered a compiler bug, a simple web search for the error message or condition you have witnessed could uncover a workaround or patch.

One area that compilers are notorious for having trouble with is language additions that are added by recent updates to the standard. Although in recent years, vendors of major compilers are pretty quick in adding support for the latest features.

Another issue to be aware of is that compilers often include their own language extensions without making it obvious to the programmer. For example, variable-length stack-based arrays (VLAs) are not part of the C++ language; however, they are part of the C language. Some compilers support both the C and the C++ standard, and can allow the use of VLAs in C++ code. One such compiler is g++. The following compiles and runs as expected with the g++ compiler:

```
int i = 4;
char myStackArray[i]; // Not a standard language feature!
```

Some compiler extensions may be useful, but if there is a chance that you will switch compilers at some point, you should see if your compiler has a strict mode where it avoids using such extensions. For example, compiling the previous code with the `-pedantic` flag passed to g++ yields the following warning:

```
warning: ISO C++ forbids variable length array 'myStackArray' [-Wvla]
```

The C++ specification allows for a certain type of compiler-defined language extension through the `#pragma` mechanism. `#pragma` is a precompiler directive whose behavior is defined by the implementation. If the implementation does not understand the directive, it ignores it. For example, some compilers allow the programmer to turn compiler warnings off temporarily with `#pragma`.

Library Implementations

Most likely, your compiler includes an implementation of the C++ Standard Library. Because the Standard Library is written in C++, however, you aren't required to use the implementation that came bundled with your compiler. You could use a third-party Standard Library that, for example, has been optimized for speed, or you could even write your own.

Of course, Standard Library implementers face the same problems that compiler writers face: the standard is subject to interpretation. In addition, certain implementations may make tradeoffs that are incompatible with your needs. For example, one implementation may optimize for speed, while another implementation may focus on using as little memory as possible for containers.

When working with a Standard Library implementation, or indeed any third-party library, it is important to consider the tradeoffs that the designers made during the development. Chapter 4 contains a more detailed discussion of the issues involved in using libraries.

Platform-Specific Features

C++ is a great general-purpose language. With the addition of the Standard Library, the language is packed full of so many features that a casual programmer could happily code in C++ for years without going beyond what is built in. However, professional programs require facilities that C++ does not provide. This section lists several important features that are provided by the platform or third-party libraries, not by the C++ language or the C++ Standard Library.

- **Graphical user interfaces:** Most commercial programs today run on an operating system that has a graphical user interface, containing such elements as clickable buttons, movable windows, and hierarchical menus. C++, like the C language, has no notion of these elements. To write a graphical application in C++, you can use platform-specific libraries that allow you to draw windows, accept input through the mouse, and perform other graphical tasks. A better option is to use a third-party library, such as wxWidgets or Qt, that provides an abstraction layer for building graphical applications. These libraries often provide support for many different target platforms.
- **Networking:** The Internet has changed the way we write applications. These days, most applications check for updates through the web, and games provide a networked multiplayer mode. C++ does not provide a mechanism for networking yet, though several standard libraries exist. The most common means of writing networking software is through an abstraction called *sockets*. A socket library implementation can be found on most platforms, and it provides a simple procedure-oriented way to transfer data over a network. Some platforms support a stream-based networking system that operates like I/O streams in C++. There are also third-party networking libraries available that provide a networking abstraction layer. These libraries often support many different target platforms. IPv6, the successor to IPv4, is gaining traction. Therefore, choosing a networking library that is IPv-independent would be a better choice than choosing one that only supports IPv4.
- **OS events and application interaction:** In pure C++ code, there is little interaction with the surrounding operating system and other applications. The command-line arguments are about all you get in a standard C++ program without platform extensions. For example, operations such as copy and paste are not directly supported in C++. You can either use platform-provided libraries, or use third-party libraries that support multiple platforms. For example, both wxWidgets and Qt are examples of libraries that abstract the copy and paste operations and support multiple platforms.
- **Low-level files:** Chapter 13 explains standard I/O in C++, including reading and writing files. Many operating systems provide their own file APIs, which are usually incompatible with the standard file classes in C++. These libraries often provide OS-specific file tools, such as a mechanism to get the home directory of the current user.
- **Threads:** Concurrent threads of execution within a single program were not directly supported in C++03 or earlier. Since C++11, a threading support library has been included with the Standard Library, as explained in Chapter 23, and C++17 has added parallel algorithms, as discussed in Chapter 18. If you need more powerful threading functionality besides what the Standard Library provides, then you need to use third-party libraries. Examples are the Intel Threading Building Blocks (TBB), and The STEllAR Group High Performance ParalleX (HPX) library.

NOTE *If you are doing cross-platform development, and you need functionality not provided by the C++ language or the Standard Library, you should try to find a third-party cross-platform library that provides the functionality you require. If you start using platform-specific APIs, then you are complicating your cross-platform application a lot, because you will have to implement the functionality for each platform you support.*

CROSS-LANGUAGE DEVELOPMENT

For certain types of programs, C++ may not be the best tool for the job. For example, if your Unix program needs to interact closely with the shell environment, you may be better off writing a shell script than a C++ program. If your program performs heavy text processing, you may decide that the Perl language is the way to go. If you need a lot of database interaction, then C# or Java might be a better choice. C# and the WPF framework might be better suited to write modern GUI applications, and so on. Still, if you do decide to use another language, you sometimes might want to be able to call into C++ code, for example, to perform some computational-expensive operations. Fortunately, there are some techniques you can use to get the best of both worlds—the unique specialty of another language combined with the power and flexibility of C++.

Mixing C and C++

As you already know, the C++ language is almost a superset of the C language. That means that almost all C programs will compile and run in C++. There are a few exceptions. Some exceptions have to do with the fact that a handful of C features are not supported by C++, for example, C supports variable-length arrays (VLAs), while C++ does not. Other exceptions usually have to do with reserved words. In C, for example, the term *class* has no particular meaning. Thus, it could be used as a variable name, as in the following C code:

```
int class = 1; // Compiles in C, not C++
printf("class is %d\n", class);
```

This program compiles and runs in C, but yields an error when compiled as C++ code. When you translate, or *port*, a program from C to C++, these are the types of errors you will face. Fortunately, the fixes are usually quite simple. In this case, rename the `class` variable to `classID` and the code will compile. The other types of errors you'll face are the handful of C features that are not supported by C++, but these are usually rare.

The ease of incorporating C code in a C++ program comes in handy when you encounter a useful library or legacy code that was written in C. Functions and classes, as you've seen many times in this book, work just fine together. A class method can call a function, and a function can make use of objects.

Shifting Paradigms

One of the dangers of mixing C and C++ is that your program may start to lose its object-oriented properties. For example, if your object-oriented web browser is implemented with a procedural networking library, the program will be mixing these two paradigms. Given the importance and quantity of networking tasks in such an application, you might consider writing an *object-oriented wrapper* around the procedural library. A typical design pattern that can be used for this is called the *façade*.

For example, imagine that you are writing a web browser in C++, but you are using a C networking library that contains the functions declared in the following code. Note that the `HostHandle` and `ConnectionHandle` data structures have been omitted for brevity.

```
// netwrklib.h
#include "HostHandle.h"
#include "ConnectionHandle.h"
```



```

// Gets the host record for a particular Internet host given
// its hostname (i.e. www.host.com)
HostHandle* lookupHostByName(char* hostName);

// Frees the given HostHandle
void freeHostHandle(HostHandle* host);

// Connects to the given host
ConnectionHandle* connectToHost(HostHandle* host);

// Closes the given connection
void closeConnection(ConnectionHandle* connection);

// Retrieves a web page from an already-opened connection
char* retrieveWebPage(ConnectionHandle* connection, char* page);

// Frees the memory pointed to by page
void freeWebPage(char* page);

```

The `netwrklib.h` interface is fairly simple and straightforward. However, it is not object-oriented, and a C++ programmer who uses such a library is bound to feel *icky*, to use a technical term. This library isn't organized into a cohesive class and it isn't even `const`-correct. Of course, a talented C programmer could have written a better interface, but as the user of a library, you have to accept what you are given. Writing a wrapper is your opportunity to customize the interface.

Before you build an object-oriented wrapper for this library, take a look at how it might be used as-is to gain an understanding of its actual usage. In the following program, the `netwrklib` library is used to retrieve the web page at `www.wrox.com/index.html`:

```

HostHandle* myHost = lookupHostByName("www.wrox.com");
ConnectionHandle* myConnection = connectToHost(myHost);
char* result = retrieveWebPage(myConnection, "/index.html");

cout << "The result is " << result << endl;

freeWebPage(result);
closeConnection(myConnection);
freeHostHandle(myHost);

```

A possible way to make the library more object-oriented is to provide a single abstraction that recognizes the links between looking up a host, connecting to the host, and retrieving a web page. A good object-oriented wrapper hides the needless complexity of the `HostHandle` and `ConnectionHandle` types.

This example follows the design principles described in Chapters 5 and 6: the new class should capture the common use case for the library. The previous example shows the most frequently used pattern: first a host is looked up, then a connection is established, and finally a page is retrieved. It is also likely that subsequent pages will be retrieved from the same host, so a good design will accommodate that mode of use as well.

To start, the `HostRecord` class wraps the functionality of looking up a host. It's an RAII class. Its constructor uses `lookupHostByName()` to perform the lookup, and its destructor automatically frees the retrieved `HostHandle`. Here is the code:

```
class HostRecord
{
public:
    // Looks up the host record for the given host
    explicit HostRecord(std::string_view host);
    // Frees the host record
    virtual ~HostRecord();
    // Returns the underlying handle.
    HostHandle* get() const noexcept;
private:
    HostHandle* mHostHandle = nullptr;
};

HostRecord::HostRecord(std::string_view host)
{
    mHostHandle = lookupHostByName(const_cast<char*>(host.data()));
}

HostRecord::~~HostRecord()
{
    if (mHostHandle)
        freeHostHandle(mHostHandle);
}

HostHandle* HostRecord::get() const noexcept
{
    return mHostHandle;
}
```

Because the `HostRecord` class deals with C++ `string_views` instead of C-style strings, it uses the `data()` method on `host` to obtain a `const char*`, then performs a `const_cast()` to make up for `netwrklib`'s `const-incorrectness`.

Next, a `WebHost` class can be implemented that uses the `HostRecord` class. The `WebHost` class creates a connection to a given host and supports retrieving webpages. It's also an RAII class. When the `WebHost` object is destroyed, it automatically closes the connection to the host. Here is the code:

```
class WebHost
{
public:
    // Connects to the given host
    explicit WebHost(std::string_view host);
    // Closes the connection to the host
    virtual ~WebHost();
    // Obtains the given page from this host
    std::string getPage(std::string_view page);
private:
    ConnectionHandle* mConnection = nullptr;
};
```

```

WebHost::WebHost(std::string_view host)
{
    HostRecord hostRecord(host);
    if (hostRecord.get()) {
        mConnection = connectToHost(hostRecord.get());
    }
}

WebHost::~WebHost()
{
    if (mConnection)
        closeConnection(mConnection);
}

std::string WebHost::getPage(std::string_view page)
{
    std::string resultAsString;
    if (mConnection) {
        char* result = retrieveWebPage(mConnection,
            const_cast<char*>(page.data()));
        resultAsString = result;
        freeWebPage(result);
    }
    return resultAsString;
}

```

The `WebHost` class effectively encapsulates the behavior of a host and provides useful functionality without unnecessary calls and data structures. The implementation of the `WebHost` class makes extensive use of the `netwrklib` library without exposing any of its workings to the user. The constructor of `WebHost` uses a `HostRecord` RAII object for the specified host. The resulting `HostRecord` is used to set up a connection to the host, which is stored in the `mConnection` data member for later use. The `HostRecord` RAII object is automatically destroyed at the end of the constructor. The `WebHost` destructor closes the connection. The `getPage()` method uses `retrieveWebPage()` to retrieve a web page, converts it to an `std::string`, uses `freeWebPage()` to free memory, and returns the `std::string`.

The `WebHost` class makes the common case easy for the client programmer:

```

WebHost myHost("www.wrox.com");
string result = myHost.getPage("/index.html");
cout << "The result is " << result << endl;

```

NOTE *Networking-savvy readers may note that keeping a connection open to a host indefinitely is considered bad practice and doesn't adhere to the HTTP specification. I've chosen elegance over etiquette in this example.*

As you can see, the `WebHost` class provides an object-oriented wrapper around the C library. By providing an abstraction, you can change the underlying implementation without affecting client code, and you can provide additional features. These features can include connection reference counting, automatically closing connections after a specific time to adhere to the HTTP specification and automatically reopening the connection on the next `getPage()` call, and so on.

Linking with C Code

The previous example assumed that you had the raw C code to work with. The example took advantage of the fact that most C code will successfully compile with a C++ compiler. If you only have compiled C code, perhaps in the form of a library, you can still use it in your C++ program, but you need to take a few extra steps.

Before you can start using compiled C code in your C++ programs, you first need to know about a concept called *name mangling*. In order to implement function overloading, the complex C++ namespace is “flattened.” For example, if you have a C++ program, it is legitimate to write the following:

```
void MyFunc(double);
void MyFunc(int);
void MyFunc(int, int);
```

However, this would mean that the linker would see several different names, all called `MyFunc`, and would not know which one you want to call. Therefore, all C++ compilers perform an operation that is referred to as *name mangling* and is the logical equivalent of generating names, as follows:

```
MyFunc_double
MyFunc_int
MyFunc_int_int
```

To avoid conflicts with other names you might have defined, the generated names usually have some characters that are legal to the linker but not legal in C++ source code. For example, Microsoft VC++ generates names as follows:

```
?MyFunc@@YAXN@Z
?MyFunc@@YAXH@Z
?MyFunc@@YAXHH@Z
```

This encoding is complex and often vendor-specific. The C++ standard does not specify how function overloading should be implemented on a given platform, so there is no standard for name mangling algorithms.

In C, function overloading is not supported (the compiler will complain about duplicate definitions). So, names generated by the C compiler are quite simple, for example, `_MyFunc`.

Now, if you compile a simple program with the C++ compiler, even if it has only one instance of the `MyFunc` name, it still generates a request to link to a mangled name. However, when you link with the C library, it cannot find the desired mangled name, and the linker complains. Therefore, it is necessary to tell the C++ compiler to not mangle that name. This is done by using the `extern "language"` qualification both in the header file (to instruct the client code to create a name compatible with the specified language) and, if your library source is in C++, at the definition site (to instruct the library code to generate a name compatible with the specified language).

Here is the syntax of `extern "language"`:

```
extern "language" declaration1();
extern "language" declaration2();
```

or it can also be like this:

```
extern "language" {
    declaration1();
    declaration2();
}
```

The C++ standard says that any language specification can be used, so in principle, the following could be supported by a compiler:

```
extern "C" MyFunc(int i);
extern "Fortran" MatrixInvert(Matrix* M);
extern "Pascal" SomeLegacySubroutine(int n);
extern "Ada" AimMissileDefense(double angle);
```

In practice, many compilers only support "C". Each compiler vendor will inform you which language designators they support.

For example, in the following code, the function prototype for `doCFunction()` is specified as an external C function:

```
extern "C" {
    void doCFunction(int i);
}

int main()
{
    doCFunction(8); // Calls the C function.
    return 0;
}
```

The actual definition for `doCFunction()` is provided in a compiled binary file attached in the link phase. The `extern` keyword informs the compiler that the linked-in code was compiled in C.

A more common pattern for using `extern` is at the header level. For example, if you are using a graphics library written in C, it probably came with an `.h` file for you to use. You can write another header file that wraps the original one in an `extern` block to specify that the entire header defines functions written in C. The wrapper `.h` file is often named with `.hpp` to distinguish it from the C version of the header:

```
// graphicslib.hpp
extern "C" {
    #include "graphicslib.h"
}
```

Another common model is to write a single header file, which is conditioned on whether it is being compiled for C or C++. A C++ compiler predefines the symbol `__cplusplus` if you are compiling for C++. The symbol is not defined for C compilations. So, you will often see header files in the following form:

```
#ifndef __cplusplus
    extern "C" {
#endif
```

```

        declaration1();
        declaration2();
#ifdef __cplusplus
    } // matches extern "C"
#endif

```

This means that `declaration1()` and `declaration2()` are functions that are in a library compiled by the C compiler. Using this technique, the same header file can be used in both C and C++ clients.

Whether you are including C code in your C++ program or linking against a compiled C library, remember that even though C++ is almost a superset of C, they are different languages with different design goals. Adapting C code to work in C++ is quite common, but providing an object-oriented C++ wrapper around procedural C code is often much better.

Calling C++ Code from C#

Even though this is a C++ book, I won't pretend that there aren't snazzier languages out there. One example is C#. By using the *Interop services* from C#, it's pretty easy to call C++ code from within your C# applications. An example scenario could be that you develop parts of your application, like the graphical user interface, in C#, but use C++ to implement certain performance-critical or computational-expensive components. To make Interop work, you need to write a library in C++, which can be called from C#. On Windows, the library will be in a .DLL file. The following C++ example defines a `FunctionInDLL()` function that will be compiled into a library. The function accepts a Unicode string and returns an integer. The implementation writes the received string to the console and returns the value 42 to the caller:

```

#include <iostream>

using namespace std;

extern "C"
{
    __declspec(dllexport) int FunctionInDLL(const wchar_t* p)
    {
        wcout << L"The following string was received by C++:\n    ";
        wcout << p << L"" << endl;
        return 42;    // Return some value...
    }
}

```

Keep in mind that you are implementing a function in a library, not writing a program, so you do not need a `main()` function. How you compile this code depends on your environment. If you are using Microsoft Visual C++, you need to go to the properties of your project and select “Dynamic Library (.dll)” as the configuration type. Note that the example uses `__declspec(dllexport)` to tell the linker that this function should be made available to clients of the library. This is the way you do it with Microsoft Visual C++. Other linkers might use a different mechanism to export functions.

Once you have the library, you can call it from C# by using the Interop services. First, you need to include the Interop namespace:

```
using System.Runtime.InteropServices;
```

Next, you define the function prototype, and tell C# where it can find the implementation of the function. This is done with the following line, assuming you have compiled the library as `HelloCpp.dll`:

```
[DllImport("HelloCpp.dll", CharSet = CharSet.Unicode)]
public static extern int FunctionInDLL(String s);
```

The first part of this line is saying that C# should import this function from a library called `HelloCpp.dll`, and that it should use Unicode strings. The second part specifies the actual prototype of the function, which is a function accepting a string as parameter and returning an integer. The following code shows a complete example of how to use the C++ library from C#:

```
using System;
using System.Runtime.InteropServices;

namespace HelloCSharp
{
    class Program
    {
        [DllImport("HelloCpp.dll", CharSet = CharSet.Unicode)]
        public static extern int FunctionInDLL(String s);

        static void Main(string[] args)
        {
            Console.WriteLine("Written by C#.");
            int result = FunctionInDLL("Some string from C#.");
            Console.WriteLine("C++ returned the value " + result);
        }
    }
}
```

The output is as follows:

```
Written by C#.
The following string was received by C++:
'Some string from C#.'
C++ returned the value 42
```

The details of the C# code are outside the scope of this C++ book, but the general idea should be clear with this example.

Calling C++ Code from Java with JNI

The *Java Native Interface*, or JNI, is a part of the Java language that allows programmers to access functionality that was not written in Java. Because Java is a cross-platform language, the original intent was to make it possible for Java programs to interact with the operating system. JNI also allows programmers to make use of libraries written in other languages, such as C++. Access to C++ libraries may be useful to a Java programmer who has a performance-critical or computationally-expensive piece of code, or who needs to use legacy code.

JNI can also be used to execute Java code within a C++ program, but such a use is far less common. Because this is a C++ book, I do not include an introduction to the Java language. This section is recommended if you already know Java and want to incorporate C++ code into your Java code.

To begin your Java cross-language adventure, start with the Java program. For this example, the simplest of Java programs will suffice:

```
public class HelloCpp {
    public static void main(String[] args)
    {
        System.out.println("Hello from Java!");
    }
}
```

Next, you need to declare a Java method that will be written in another language. To do this, you use the native keyword and leave out the implementation:

```
public class HelloCpp {
    // This will be implemented in C++.
    public static native void callCpp();

    // Remainder omitted for brevity
}
```

The C++ code will eventually be compiled into a shared library that gets dynamically loaded into the Java program. You can load this library inside a Java static block so that it is loaded when the Java program begins executing. The name of the library can be whatever you want, for example, `hellocpp.so` on Linux systems, or `hellocpp.dll` on Windows systems.

```
public class HelloCpp {
    static {
        System.loadLibrary("hellocpp");
    }

    // Remainder omitted for brevity
}
```

Finally, you need to actually call the C++ code from within the Java program. The `callCpp()` Java method serves as a placeholder for the not-yet-written C++ code. Here is the complete Java program:

```
public class HelloCpp {
    static {
        System.loadLibrary("hellocpp");
    }

    // This will be implemented in C++.
    public static native void callCpp();

    public static void main(String[] args)
    {
        System.out.println("Hello from Java!");
        callCpp();
    }
}
```

That's all for the Java side. Now, just compile the Java program as you normally would:

```
javac HelloCpp.java
```

Then use the `javah` program (I like to pronounce it as *jav-AHH!*) to create a header file for the native method:

```
javah HelloCpp
```

After running `javah`, you will find a file named `HelloCpp.h`, which is a fully working (if somewhat ugly) C/C++ header file. Inside of that header file is a C function definition for a function called `Java_HelloCpp_callCpp()`. Your C++ program will need to implement this function. The full prototype is as follows:

```
JNIEXPORT void JNICALL Java_HelloCpp_callCpp(JNIEnv*, jclass);
```

Your C++ implementation of this function can make full use of the C++ language. This example outputs some text from C++. First, you need to include the `jni.h` header file and the `HelloCpp.h` file that was created by `javah`. You also need to include any C++ headers that you intend to use:

```
#include <jni.h>
#include "HelloCpp.h"
#include <iostream>
```

The C++ function is written as normal. The parameters to the function allow interaction with the Java environment and the object that called the native code. They are beyond the scope of this example.

```
JNIEXPORT void JNICALL Java_HelloCpp_callCpp(JNIEnv*, jclass)
{
    std::cout << "Hello from C++!" << std::endl;
}
```

How to compile this code into a library depends on your environment, but you will most likely need to tweak your compiler's settings to include the JNI headers. Using the GCC compiler on Linux, your compile command might look like this:

```
g++ -shared -I/usr/java/jdk/include/ -I/usr/java/jdk/include/linux \
HelloCpp.cpp -o hellocpp.so
```

The output from the compiler is the library used by the Java program. As long as the shared library is somewhere in the Java class path, you can execute the Java program normally:

```
java HelloCpp
```

You should see the following result:

```
Hello from Java!
Hello from C++!
```

Of course, this example just scratches the surface of what is possible through JNI. You could use JNI to interface with OS-specific features or hardware drivers. For complete coverage of JNI, you should consult a Java text.

Calling Scripts from C++ Code

The original Unix OS included a rather limited C library, which did not support certain common operations. Unix programmers therefore developed the habit of launching *shell scripts* from applications to accomplish tasks that should have had API or library support.

Today, many of these Unix programmers still insist on using scripts as a form of subroutine call. Usually, they execute the `system()` C library call with a string that is the script to execute. There are significant risks to this approach. For example, if there is an error in the script, the caller may or may not get a detailed error indication. The `system()` call is also exceptionally heavy-duty, because it has to create an entire new process to execute the script. This may ultimately be a serious performance bottleneck in your application.

Using `system()` to launch scripts is not further discussed in this text. In general, you should explore the features of C++ libraries to see if there are better ways to do something. There are some platform-independent wrappers around a lot of platform-specific libraries, for example, the Boost Asio library, which provides portable networking and other low-level I/O, including sockets, timers, serial ports, and so on. If you need to work with the filesystem, C++17 now includes a platform-independent `<filesystem>` API, as discussed in Chapter 20. Concepts like launching a Perl script with `system()` to process some textual data may not be the best choice. Using techniques like the regular expressions library of C++, see Chapter 19, might be a better choice for your string processing needs.

Calling C++ Code from Scripts

C++ contains a built-in general-purpose mechanism to interface with other languages and environments. You've already used it many times, probably without paying much attention to it—it's the arguments to and return value from the `main()` function.

C and C++ were designed with command-line interfaces in mind. The `main()` function receives the arguments from the command line, and returns a status code that can be interpreted by the caller. In a scripting environment, arguments to and status codes from your program can be a powerful mechanism that allows you to interface with the environment.

A Practical Example: Encrypting Passwords

Assume that you have a system that writes everything a user sees and types to a file for auditing purposes. The file can be read only by the system administrator so that she can figure out who to blame if something goes wrong. An excerpt of such a file might look like this:

```
Login: bucky-bo
Password: feldspar

bucky-bo> mail
bucky-bo has no mail
bucky-bo> exit
```

While the system administrator may want to keep a log of all user activity, she may also want to obscure everybody's passwords in case the file is somehow obtained by a hacker. She decides to write a script to parse the log files, and to use C++ to perform the actual encryption. The script then calls out to a C++ program to perform the encryption.

The following script uses the Perl language, though almost any scripting language could accomplish this task. Note also that these days, there are libraries available for Perl that perform encryption, but, for the sake of this example, let's assume the encryption is done in C++. If you don't know Perl,

you will still be able to follow along. The most important element of the Perl syntax for this example is the ``` character. The ``` character instructs the Perl script to *shell out* to an external command. In this case, the script will shell out to a C++ program called `encryptString`.

NOTE *Launching an external process causes a big overhead because a complete new process has to be created. You shouldn't use it when you need to call the external process often. In this password encryption example, it is okay, because you can assume that a log file will only contain a few password lines.*

The strategy for the script is to loop over every line of a file, `userlog.txt`, looking for lines that contain a password prompt. The script writes a new file, `userlog.out`, which contains the same text as the source file, except that all passwords are encrypted. The first step is to open the input file for reading and the output file for writing. Then, the script needs to loop over all the lines in the file. Each line in turn is placed in a variable called `$line`.

```
open (INPUT, "userlog.txt") or die "Couldn't open input file!";
open (OUTPUT, ">userlog.out") or die "Couldn't open output file!";
while ($line = <INPUT>) {
```

Next, the current line is checked against a *regular expression* to see if this particular line contains the `Password:` prompt. If it does, Perl stores the password in the variable `$1`.

```
if ($line =~ m/^Password: (.*)/) {
```

If a match is found, the script calls the `encryptString` program with the detected password to obtain an encrypted version of it. The output of the program is stored in the `$result` variable, and the result status code from the program is stored in the variable `$?`. The script checks `$?` and quits immediately if there is a problem. If everything is okay, the password line is written to the output file with the encrypted password instead of the original one.

```
    $result = `./encryptString $1`;
    if ($? != 0) { exit(-1); }
    print OUTPUT "Password: $result\n";
} else {
```

If the current line is not a password prompt, the script writes the line as-is to the output file. At the end of the loop, it closes both files and exits.

```
    print OUTPUT "$line";
}
}
close (INPUT);
close (OUTPUT);
```

That's it. The only other required piece is the actual C++ program. Implementation of a cryptographic algorithm is beyond the scope of this book. The important piece is the `main()` function because it accepts the string that should be encrypted as an argument.

Arguments are contained in the `argv` array of C-style strings. You should always check the `argc` parameter before accessing an element of `argv`. If `argc` is 1, there is one element in the argument list

and it is accessible as `argv[0]`. The 0th element of the `argv` array is generally the name of the program, so actual parameters begin at `argv[1]`.

Following is the `main()` function for a C++ program that encrypts the input string. Notice that the program returns 0 for success and non-0 for failure, as is standard in Linux.

```
int main(int argc, char* argv[])
{
    if (argc < 2) {
        cerr << "Usage: " << argv[0] << " string-to-be-encrypted" << endl;
        return -1;
    }
    cout << encrypt(argv[1]);
    return 0;
}
```

NOTE *There is actually a blatant security hole in this code. When the to-be-encrypted string is passed to the C++ program as a command-line argument, it may be visible to other users through the process table. One example of a more secure way to get the information into the C++ program would be to send it through standard input.*

Now that you've seen how easily C++ programs can be incorporated into scripting languages, you can combine the strengths of the two languages for your own projects. You can use a scripting language to interact with the operating system and control the flow of the script, and a traditional programming language like C++ for the heavy lifting.

NOTE *This example is just to demonstrate how to use Perl and C++ together. C++ includes a regular expressions library, which makes it very easy to convert this Perl/C++ solution into a pure C++ solution. This pure C++ solution will run much faster because it avoids calling an external program. See Chapter 19 for details on this regular expressions library.*

Calling Assembly Code from C++

C++ is considered a fast language, especially relative to other languages. Yet, in some rare cases, you might want to use raw assembly code when speed is absolutely critical. The compiler generates assembly code from your source files, and this generated assembly code is fast enough for virtually all purposes. Both the compiler and the linker (when it supports link time code generation) use optimization algorithms to make the generated assembly code as fast as possible. These optimizers are getting more and more powerful by using special processor instruction sets such as MMX, SSE, and AVX. These days, it's very hard to write your own assembly code that outperforms the code generated by the compiler, unless you know all the little details of these enhanced instruction sets.

However, in case you do need it, the keyword `asm` can be used by a C++ compiler to allow the programmer to insert raw assembly code. The keyword is part of the C++ standard, but its implementation is compiler-defined. In some compilers, you can use `asm` to drop from C++ down to the level of assembly right in the middle of your program. Sometimes, the support for the `asm` keyword depends on your target architecture. For example, Microsoft VC++ 2017 supports the `asm` keyword when compiling in 32-bit mode, but `asm` is not supported when compiling in 64-bit mode.

Assembly code can be useful in some applications, but I don't recommend it for most programs. There are several reasons to avoid assembly code:

- Your code is no longer portable to another processor once you start including raw assembly code for your platform.
- Most programmers don't know assembly languages and won't be able to modify or maintain your code.
- Assembly code is not known for its readability. It can hurt your program's use of style.
- Most of the time, it is not necessary. If your program is slow, look for algorithmic problems, or consult some of the other performance suggestions from Chapter 25.

WARNING *When you encounter performance issues in your application, use a profiler to determine the real hotspot, and look into algorithmic speed-ups! Only start thinking about using assembly code if you have exhausted all other options, and even then, think about the disadvantages of assembly code.*

Practically, if you have a computationally expensive block of code, you should move it to its own C++ function. If you determine, using performance profiling (see Chapter 25), that this function is a performance bottleneck, and there is no way to write the code smaller and faster, you might use raw assembly code to try to increase its performance.

In such a case, one of the first things you want to do is declare the function `extern "C"` so the C++ name mangling is suppressed. Then, you can write a separate module in assembly code that performs the function more efficiently. The advantage of a separate module is that there is both a "reference implementation" in C++ that is platform-independent, and also a platform-specific high-performance implementation in raw assembly code. The use of `extern "C"` means that the assembly code can use a simple naming convention (otherwise, you have to reverse-engineer your compiler's name mangling algorithm). Then, you can link with either the C++ version or the assembly code version.

You would write this module in assembly code and run it through an assembler, rather than using inline `asm` directives in C++. This is particularly true in many of the popular x86-compatible 64-bit compilers, where the inline `asm` keyword is not supported.

However, you should only use raw assembly code if there are significant performance improvements. Increasing the performance by a factor of 2 might possibly justify the effort. A factor of 10 is compelling. An improvement of 10 percent is not worth the effort.

SUMMARY

If you take away one point from this chapter, it should be that C++ is a flexible language. It exists in the sweet spot between languages that are too tied to a particular platform, and languages that are too high-level and generic. Rest assured that when you develop code in C++, you aren't locking yourself into the language forever. C++ can be mixed with other technologies, and has a solid history and code base that will help guarantee its relevance in the future.

In Part V of this book, I discussed software engineering methods, writing efficient C++, testing and debugging techniques, design techniques and patterns, and cross-platform and cross-language application development. This is a terrific way to end your journey through Professional C++ programming because these topics help good C++ programmers become great C++ programmers. By thinking through your designs, experimenting with different approaches in object-oriented programming, selectively adding new techniques to your coding repertoire, and practicing testing and debugging techniques, you'll be able to take your C++ skills to the professional level.

A

C++ Interviews

Reading this book will surely give your C++ career a kick-start, but employers will want you to prove yourself before they offer the big bucks. Interview methodologies vary from company to company, but many aspects of technical interviews are predictable. A thorough interviewer will want to test your basic coding skills, your debugging skills, your design and style skills, and your problem-solving skills. The set of questions you might be asked is quite large. In this appendix, you'll read about some of the different types of questions you may encounter and the best tactics for landing that high-paying C++ programming job you're after.

This appendix iterates through the chapters of the book, discussing the aspects of each chapter that are likely to come up in an interview situation. Each section also includes a discussion of the types of questions that could be designed to test those skills, and the best ways to deal with those questions.

CHAPTER 1: A CRASH COURSE IN C++ AND THE STANDARD LIBRARY

A technical interview will often include some basic C++ questions to weed out the candidates who put C++ on their resume simply because they've heard of the language. These questions might be asked during a *phone screen*, when a developer or recruiter calls you before bringing you in for an in-person interview. They could also be asked via e-mail or in person. When answering these questions, remember that the interviewer is just trying to establish that you've actually learned and used C++. You generally don't need to get every detail right to earn high marks.

Things to Remember

- Use of functions
- Header file syntax, including the omission of “.h” for Standard Library headers
- Basic use of namespaces

- Language basics, such as loop syntax, including the range-based `for` loop, conditional statements, the conditional operator, and variables
- Enumerated types
- The difference between the stack and the heap
- Dynamically allocated arrays
- Use of `const`
- What pointers and references are, and their differences
- The `auto` keyword
- Basic use of Standard Library containers such as `std::vector`
- Structured bindings (C++17)
- The existence of more user-friendly support for nested namespaces in C++17

Types of Questions

Basic C++ questions will often come in the form of a vocabulary test. The interviewer may ask you to define C++ terms, such as `const` or `static`. She may be looking for the textbook answer, but you can often score extra points by giving sample usage or extra detail. For example, in addition to saying that one of the uses of `const` is to specify that a reference parameter cannot be changed, you can also say that a `const` reference is more efficient than a copy when passing an object into a function or method.

The other form that basic C++ competence questions can take is a short program that you write in front of the interviewer. An interviewer may give you a warm-up question, such as, “Write *Hello, World* in C++.” When you get a seemingly simple question like this, make sure that you score all the extra points you can by showing that you are namespace-savvy, you use streams instead of `printf()`, and you know which standard headers to include.

CHAPTERS 2 AND 19: WORKING WITH STRINGS AND STRING VIEWS, STRING LOCALIZATION, AND REGULAR EXPRESSIONS

Strings are very important, and are used in almost every kind of application. An interviewer will most likely ask at least one question related to string handling in C++.

Things to Remember

- The `std::string` and `std::string_view` classes
- Differences between the C++ `std::string` class and C-style strings, including why C-style strings should be avoided
- Conversion of strings to numeric types such as integers and floating point numbers, and vice versa

- Raw string literals
- The importance of localization
- Ideas behind Unicode
- The concepts of locales and facets
- What regular expressions are

Types of Questions

An interviewer could ask you to explain how you can append two strings together. With this question, he wants to find out whether you are thinking as a professional C++ programmer or as a C programmer. If you get such a question, you should explain the `std::string` class, and show how to use it to append two strings. It's also worth mentioning that the `string` class will handle all memory management for you automatically, and contrasting this to C-style strings.

Your interviewer may not ask specifically about localization, but you can show your worldwide interest by using `wchar_t` instead of `char` during the interview. If you do receive a question about your experience with localization, be sure to mention the importance of considering worldwide use from the beginning of the project.

You may also be asked about the general idea behind locales and facets. You probably will not have to explain the exact syntax, but you should explain that they allow you to format text and numbers according to the rules of a certain language or country.

You might get a question about Unicode, but most likely it will be a question to explain the ideas and the basic concepts behind Unicode instead of implementation details. So, make sure you understand the high-level concepts of Unicode and that you can explain their use in the context of localization. You should also know about the different options for encoding Unicode characters, such as UTF-8 and UTF-16, without specific details.

As discussed in Chapter 19, regular expressions can have a daunting syntax. It is unlikely that an interviewer will ask you about little details of regular expressions. However, you should be able to explain the concept of regular expressions and what kind of string manipulations you can do with them.

CHAPTER 3: CODING WITH STYLE

Anybody who's coded in the professional world has had a co-worker who codes as if they learned C++ from the back of a cereal box. Nobody wants to work with someone who writes messy code, so interviewers sometimes attempt to determine a candidate's style skills.

Things to Remember

- Style matters, even during interview questions that aren't explicitly style-related.
- Well-written code doesn't need extensive comments.

- Comments can be used to convey meta information.
- Decomposition is the practice of breaking up code into smaller pieces.
- Refactoring is the act of restructuring your code, for example to clean up previously written code.
- Naming techniques are important, so pay attention to how you name your variables, classes, and so on.

Types of Questions

Style questions can come in a few different forms. A friend of mine was once asked to write the code for a relatively complex algorithm on a whiteboard. As soon as he wrote the first variable name, the interviewer stopped him and told him he passed. The question wasn't about the algorithm; it was just a red herring to see how well he named his variables. More commonly, you may be asked to submit code that you've written, or to give your opinions on style.

You need to be careful when a potential employer asks you to submit code. You probably cannot legally submit code that you wrote for a previous employer. You also have to find a piece of code that shows off your skills without requiring too much background knowledge. For example, you wouldn't want to submit your master's thesis on high-speed image rendering to a company that is interviewing you for a database administration position.

If the company gives you a specific program to write, that's a perfect opportunity to show off what you've learned in this book. Even if the potential employer doesn't specify the program, you should consider writing a small program specifically to submit to the company. Instead of selecting some code you've already written, start from scratch to produce code that is relevant to the job and highlights good style.

If you have documentation that you have written and that can be released, meaning it is not confidential, use it to show your skills to *communicate*; it will give you extra points. Websites you have built or maintained, and articles you have submitted to places like CodeGuru, CodeProject, and so on, are very useful. This tells the interviewer that you can not only *write code*, but also *communicate* to others how to *use* that code effectively. Of course, having a book title attached to your name is also a big plus.

If you are contributing to active open-source projects, for example on GitHub, you'll score extra points. Even better would be if you have your own open-source project that you actively maintain. That's the perfect opportunity to show off your coding style and your communication skills. Profile pages on websites such as GitHub are taken as part of your resume by certain employers.

CHAPTER 4: DESIGNING PROFESSIONAL C++ PROGRAMS

Your interviewer will want to make sure that in addition to knowing the C++ language, you are skilled at applying it. You may not be asked a design question explicitly, but good interviewers have a variety of techniques to sneak design into other questions, as you'll see.

A potential employer will also want to know that you're able to work with code that you didn't write yourself. If you've listed specific libraries on your resume, then you should be prepared to answer questions about them. If you didn't list specific libraries, a general understanding of the importance of libraries will probably suffice.

Things to Remember

- Design is subjective. Be prepared to defend design decisions you make during the interview.
- Recall the details of a design you've done in the past prior to the interview in case you are asked for an example.
- Be prepared to define *abstraction* and give an example.
- Be prepared to sketch out a design visually, including class hierarchies.
- Be prepared to tout the benefits of code reuse.
- Understand the concept of libraries.
- Know the tradeoffs between building from scratch and reusing existing code.
- Know the basics of big-O notation, or at least remember that $O(n \log n)$ is better than $O(n^2)$.
- Understand the functionality that is included in the C++ Standard Library.
- Know the high-level definition of design patterns.

Types of Questions

Design questions are hard for an interviewer to come up with; any program that you could design in an interview setting is probably too simple to demonstrate real-world design skills. Design questions may come in a fuzzier form, such as, "Tell me the steps in designing a good program," or "Explain the principle of abstraction." They can also be less explicit. When discussing your previous job, the interviewer may ask, "Can you explain the design of that project to me?" Be careful not to expose intellectual property from your previous jobs though.

If the interviewer is asking you about a specific library, he will probably focus on the high-level aspects of the library as opposed to technical specifics. For example, you may be asked to explain what the strengths and weaknesses of the Standard Library are from a library design point of view. The best candidates talk about the Standard Library's breadth and standardization as strengths, and its sometimes complex usage as a drawback.

You may also be asked a design question that initially doesn't sound as if it's related to libraries. For example, the interviewer could ask how you would go about creating an application that downloads MP3 music from the web and plays it on a local computer. This question isn't explicitly related to libraries, but that's what it's getting at; the question is really asking about process.

You should begin by talking about how you would gather requirements and do initial prototypes. Because the question mentions two specific technologies, the interviewer would like to know how you would deal with them. This is where libraries come into play. If you tell the interviewer that you

would write your own web classes and MP3 playing code, you won't fail the test, but you will be challenged to justify the time and expense of reinventing these tools.

A better answer is to say that you would survey existing libraries that perform web and MP3 functionality to see if one exists that suits the project. You might want to name some technologies that you would start with, such as `libcurl` for web retrieval in Linux, or the Windows Media library for music playback in Windows.

Mentioning some websites with free libraries, and some ideas of what those websites provide, might also get you extra points. Some examples are `www.codeguru.com` and `www.codeproject.com` for Windows libraries; `www.boost.org` and `www.github.com` for platform-independent C++ libraries, and so on. Giving examples of some of the licenses that are available for open-source software, such as the GNU General Public License, Boost Software License, Creative Commons license, CodeGuru license, OpenBSD license, and so on, might score you extra credit.

CHAPTER 5: DESIGNING WITH OBJECTS

Object-oriented design questions are used to weed out C programmers who merely know what a reference is, from C++ programmers who actually use the object-oriented features of the language. Interviewers don't take anything for granted; even if you've been using object-oriented languages for years, they may still want to see evidence that you understand the methodology.

Things to Remember

- The differences between the procedural and object-oriented paradigms
- The differences between a class and an object
- Expressing classes in terms of components, properties, and behaviors
- Is-a and has-a relationships
- The tradeoffs involved in multiple inheritance

Types of Questions

There are typically two ways to ask object-oriented design questions: you can be asked to define an object-oriented concept, or you can be asked to sketch out an object-oriented hierarchy. The former is pretty straightforward. Remember that examples might earn you extra credit.

If you're asked to sketch out an object-oriented hierarchy, the interviewer will usually provide a simple application, such as a card game, for which you should design a class hierarchy. Interviewers often ask design questions about games because those are applications with which most people are already familiar. They also help lighten the mood a bit when compared to questions about things like database implementations. The hierarchy you generate will, of course, vary based on the game or application they are asking you to design. Here are some points to consider:

- The interviewer wants to see your thought process. Think aloud, brainstorm, engage the interviewer in a discussion, and don't be afraid to erase and go in a different direction.

- The interviewer may assume that you are familiar with the application. If you've never heard of blackjack and you get a question about it, ask the interviewer to clarify or change the question.
- Unless the interviewer gives you a specific format to use when describing the hierarchy, it's recommended that your class diagrams take the form of inheritance trees with rough lists of methods and data members for each class.
- You may have to defend your design or revise it to take added requirements into consideration. Try to gauge whether the interviewer sees actual flaws in your design, or whether she just wants to put you on the defensive to see your skills of persuasion.

CHAPTER 6: DESIGNING FOR REUSE

Interviewers rarely ask questions about designing reusable code. This omission is unfortunate because having programmers on staff who can write only single-purpose code can be detrimental to a programming organization. Occasionally, you'll find a company that is savvy on code reuse and asks about it in their interviews. Such a question is an indication that it might be a good company to work for.

Things to Remember

- The principle of abstraction
- The creation of subsystems and class hierarchies
- The general rules for good interface design, which are interfaces with only `public` methods and no implementation details
- When to use templates and when to use inheritance

Types of Questions

Questions about reuse will almost certainly be about previous projects on which you have worked. For example, if you worked at a company that produced both consumer and professional video-editing applications, the interviewer may ask how code was shared between the two applications. Even if you aren't explicitly asked about code reuse, you might be able to sneak it in. When you're describing some of your past work, tell the interviewer if the modules you wrote were used in other projects. Even when answering apparently straight coding questions, make sure to consider and mention the interfaces involved. As always, be careful not to expose intellectual property from your previous jobs though.

CHAPTER 7: MEMORY MANAGEMENT

You can be sure that an interviewer will ask you some questions related to memory management, including your knowledge of smart pointers. Besides smart pointers, you will also get more low-level questions. The goal is to determine whether the object-oriented aspects of C++ have distanced you

too much from the underlying implementation details. Memory management questions will give you a chance to prove that you know what's really going on.

Things to Remember

- Know how to draw the stack and the heap; this can help you understand what's going on.
- Avoid using low-level memory allocation and deallocation functions. In modern C++, there should be no calls to `new`, `delete`, `new[]`, `delete[]`, `malloc()`, `free()`, and so on. Instead, use smart pointers.
- Understand smart pointers; use `std::unique_ptr` by default, `shared_ptr` for shared ownership.
- Use `std::make_unique()` to create an `std::unique_ptr`.
- Use `std::make_shared()` to create an `std::shared_ptr`.
- Never use the deprecated `std::auto_ptr`; it has even been removed from C++17.
- If you do need to use low-level memory allocation functions, use `new`, `delete`, `new[]`, and `delete[]` instead of `malloc()` and `free()`.
- If you have an array of pointers to objects, you still need to allocate memory for each individual pointer and delete the memory—the array allocation syntax doesn't take care of pointers.
- Be aware of the existence of memory allocation problem detectors, such as Valgrind, to expose memory problems.

Types of Questions

Find-the-bug questions often contain memory issues, such as double deletion, `new/delete/new[]/delete[]` mix-up, and memory leaks. When you are tracing through code that makes heavy use of pointers and arrays, you should draw and update the state of the memory as you process each line of code.

Another good way to find out if a candidate understands memory is to ask how pointers and arrays differ. At this point, the differences may be so tacit in your mind that the question catches you off-guard for a moment. If that's the case, skim Chapter 7 again for the discussion on pointers and arrays.

When answering questions about memory allocation, it's always a good idea to mention the concept of smart pointers and their benefits for automatically cleaning up memory and other resources. You definitely should also mention that it's much better to use Standard Library containers, such as `std::vector`, instead of C-style arrays, because the Standard Library containers handle memory management for you automatically.

CHAPTERS 8 AND 9: GAINING PROFICIENCY WITH CLASSES AND OBJECTS, AND MASTERING CLASSES AND OBJECTS

There are no bounds to the types of questions you can be asked about classes and objects. Some interviewers are syntax-fixated and might throw some complicated code at you. Others are less concerned with the implementation and more interested in your design skills.

Things to Remember

- Basic class definition syntax
- Access specifiers for methods and data members
- The use of the `this` pointer
- How name resolution works
- Object creation and destruction, on both the stack and the heap
- Cases when the compiler generates a constructor for you
- Constructor initializers
- Copy constructors and assignment operators
- Delegating constructors
- The `mutable` keyword
- Method overloading and default parameters
- `const` members
- Friend classes and methods
- Managing dynamically allocated memory in objects
- `static` methods and data members
- Inline methods and the fact that the `inline` keyword is just a hint for the compiler, which can ignore the hint
- The key idea of separating interface and implementation classes, which says that interfaces should only contain `public` methods, should be as stable as possible, and should not contain any data members or `private/protected` methods. Thus, interfaces can remain stable while implementations are free to change under them.
- In-class member initializers
- Explicitly defaulted and deleted special member functions
- The difference between rvalues and lvalues
- Rvalue references
- Move semantics with move constructors and move assignment operators
- The copy-and-swap idiom and what it is used for
- The rule of zero, and the rule of five

Types of Questions

Questions such as, “What does the keyword `mutable` mean?” are great for phone screening. A recruiter may have a list of C++ terms and will move candidates to the next stage of the process based on the number of terms that they get right. You may not know all of the terms thrown at you,

but keep in mind that other candidates are facing the same questions and it's one of the few metrics available to a recruiter.

The find-the-bug style of questions is popular among interviewers and course instructors alike. You will be presented with some nonsense code and asked to point out its flaws. Interviewers struggle to find quantitative ways to analyze candidates, and this is one of the few ways to do it. In general, your approach should be to read each line of code and voice your concerns, brainstorming aloud. The types of bugs can fall into these categories.

- **Syntax errors:** These are rare; interviewers know you can find compile-time bugs with a compiler.
- **Memory problems:** These include problems such as leaks and double deletion.
- **“You wouldn't do that” problems:** This category includes things that are technically correct but are not recommended. For example, you wouldn't use C-style character arrays; you would use `std::string` instead.
- **Style errors:** Even if the interviewer doesn't count it as a bug, point out poor comments or variable names.

Here's a find-the-bug problem that demonstrates each of these areas:

```
class Buggy
{
    Buggy(int param);
    ~Buggy();
    double fjord(double val);
    int fjord(double val);
protected:
    void turtle(int i = 7, int j);
    int param;
    double* mGraphicDimension;
};

Buggy::Buggy(int param)
{
    param = param;
    mGraphicDimension = new double;
}

Buggy::~Buggy()
{
}

double Buggy::fjord(double val)
{
    return val * param;
}

int Buggy::fjord(double val)
{
    return (int)fjord(val);
}
```



```
void Buggy::turtle(int i, int j)
{
    cout << "i is " << i << ", j is " << j << endl;
}

```

Take a careful look at the code, and then consult the following corrected version for the answers:

```
#include <iostream>           // Streams are used in the implementation.
#include <memory>             // For std::unique_ptr.

class Buggy
{
public:                       // These should most likely be public.
    Buggy(int param);

    // Recommended to make destructors virtual. Also, explicitly
    // default it, because this class doesn't need to do anything
    // in it.
    virtual ~Buggy() = default;

    // Disallow copy construction and copy assignment operator.
    Buggy(const Buggy& src) = delete;
    Buggy& operator=(const Buggy& rhs) = delete;

    // Explicitly default move constructor and move assignment op.
    Buggy(Buggy&& src) noexcept = default;
    Buggy& operator=(Buggy&& rhs) noexcept = default;

    // int version won't compile. Overloaded
    // methods cannot differ only in return type.
    double fjord(double val);

private:                     // Use private by default.
    void turtle(int i, int j); // Only last parameters can have defaults.
    int mParam;                // Data member naming.
    std::unique_ptr<double> mGraphicDimension; // Use smart pointers!
};

Buggy::Buggy(int param)     // Prefer using ctor initializer
    : mParam(param)
    , mGraphicDimension(new double)
{
}

double Buggy::fjord(double val)
{
    return val * mParam;     // Changed data member name.
}

void Buggy::turtle(int i, int j)
{
    std::cout << "i is " << i << ", j is " << j << std::endl; // Namespaces.
}

```

You should explain why you should never use raw pointers that represent ownership, but smart pointers instead. You should also explain why you are explicitly defaulting the move constructor and move assignment operator, and why you opt to delete the copy constructor and copy assignment operator. Explain what impact it would have on the class if you do need to implement a copy constructor and a copy assignment operator.

CHAPTER 10: DISCOVERING INHERITANCE TECHNIQUES

Questions about inheritance usually come in the same forms as questions about classes. The interviewer might also ask you to implement a class hierarchy to show that you have worked with C++ enough to write derived classes without looking it up in a book.

Things to Remember

- The syntax for deriving a class
- The difference between `private` and `protected` from a derived class point of view
- Method overriding and `virtual`
- The difference between overloading and overriding
- The reason why destructors should be `virtual`
- Chained constructors
- The ins and outs of upcasting and downcasting
- The principle of polymorphism
- Pure `virtual` methods and abstract base classes
- Multiple inheritance
- Run-time type information (RTTI)
- Inherited constructors
- The `final` keyword on classes
- The `override` and `final` keywords on methods

Types of Questions

Many of the pitfalls in inheritance questions are related to getting the details right. When you are writing a base class, don't forget to make the methods `virtual`. If you mark all methods `virtual`, be prepared to justify that decision. You should be able to explain what `virtual` means and how it works. Also, don't forget the `public` keyword before the name of the parent class in the derived class definition (for example, `class Derived : public Base`). It's unlikely that you'll be asked to perform nonpublic inheritance during an interview.

More challenging inheritance questions have to do with the relationship between a base class and a derived class. Be sure you know how the different access levels work, and the difference between `private` and `protected`. Remind yourself of the phenomenon known as *slicing*, when certain types of casts cause a class to lose its derived class information.

CHAPTER 11: C++ QUIRKS, ODDITIES, AND INCIDENTALS

Many interviewers tend to focus on the more obscure cases because that way, experienced C++ programmers can demonstrate that they have conquered the unusual parts of C++. Sometimes interviewers have difficulty coming up with interesting questions and end up asking the most obscure question they can think of.

Things to Remember

- The need for references to be bound to a variable when they are declared and the binding cannot be changed
- The advantages of pass-by-reference over pass-by-value
- The many uses of `const`
- The many uses of `static`
- The different types of casts in C++
- How type aliases and `typedefs` work
- The general idea behind attributes
- The fact that you can define your own user-defined literals, but without the syntactical details

Types of Questions

Asking a candidate to define `const` and `static` is a classic C++ interview question. Both keywords provide a sliding scale with which an interviewer can assess an answer. For example, a fair candidate will talk about `static` methods and `static` data members. A good candidate will give good examples of `static` methods and `static` data members. A great candidate will also know about `static` linkage and `static` variables in functions.

The edge cases described in this chapter also come in find-the-bug type problems. Be on the lookout for misuse of references. For example, imagine a class that contains a reference as a data member:

```
class Gwenyth
{
    private:
        int& mCaversham;
};
```

Because `mCaversham` is a reference, it needs to be bound to a variable when the class is constructed. To do that, you'd need to use a constructor initializer. The class could take the variable to be referenced as a parameter to the constructor:

```
class Gwenyth
{
public:
    Gwenyth(int& i);
private:
    int& mCaversham;
};

Gwenyth::Gwenyth(int& i) : mCaversham(i)
{
}
```

CHAPTERS 12 AND 22: WRITING GENERIC CODE WITH TEMPLATES, AND ADVANCED TEMPLATES

As one of the most arcane parts of C++, templates are a good way for interviewers to separate the C++ novices from the pros. While most interviewers will forgive you for not remembering some of the advanced template syntax, you should go into the interview knowing the basics.

Things to Remember

- How to use a class or function template
- How to write a basic class or function template
- Template argument deduction, including for constructors
- Alias templates and why they are better than `typedefs`
- The concept of variadic templates
- The ideas behind metaprogramming
- Type traits and what they can be used for

Types of Questions

Many interview questions start out with a simple problem and gradually add complexity. Often, interviewers have an endless amount of complexity that they are prepared to add, and they simply want to see how far you get. For example, an interviewer might begin a problem by asking you to create a class that provides sequential access to a fixed number of `ints`. Next, the class will need to grow to accommodate an arbitrary-sized array. Then, it will need arbitrary data types, which is where templates come in. From there, the interviewer could take the problem in a number of directions, asking you to use operator overloading to provide array-like syntax, or continuing down the template path by asking you to provide a default type.

Templates are more likely to be employed in the solution of another coding problem than to be asked about explicitly. You should brush up on the basics in case the subject comes up. However, most interviewers understand that the template syntax is difficult, and asking someone to write complex template code in an interview is rather cruel.

The interviewer might ask you high-level questions related to metaprogramming to find out whether or not you have heard about it. While explaining, you could give a small example such as calculating the factorial of a number at compile time. Don't worry if the syntax is not entirely correct. As long as you explain what it is supposed to do, you should be fine.

CHAPTER 13: DEMYSTIFYING C++ I/O

If you're interviewing for a job writing GUI applications, you probably won't get too many questions about I/O streams because GUI applications tend to use other mechanisms for I/O. However, streams can come up in other problems and, as a standard part of C++, they are fair game as far as the interviewer is concerned.

Things to Remember

- The definition of a stream
- Basic input and output using streams
- The concept of manipulators
- Types of streams (console, file, string, and so on)
- Error-handling techniques

Types of Questions

I/O may come up in the context of any question. For example, the interviewer could ask you to read in a file containing test scores and put them in a `vector`. This question tests basic C++ skills, basic Standard Library, and basic I/O. Even if I/O is only a small part of the problem you're working on, be sure to check for errors. If you don't, you're giving the interviewer an opportunity to say something negative about your otherwise perfect program.

CHAPTER 14: HANDLING ERRORS

Managers sometimes shy away from hiring recent graduates or novice programmers for vital (and high-paying) jobs because it is assumed that they don't write production-quality code. You can prove to an interviewer that your code won't keel over randomly by demonstrating your error-handling skills during an interview.

Things to Remember

- Syntax of exceptions
- Catching exceptions as `const` references
- Why hierarchies of exceptions are preferable to a few generic ones
- The basics of how stack unwinding works when an exception gets thrown
- How to handle errors in constructors and destructors
- How smart pointers help to avoid memory leaks when exceptions are thrown
- The fact that you must never use the C functions `setjmp()` and `longjmp()` in C++

Types of Questions

Interviewers will be on the lookout to see how you report and handle errors. When you are asked to write a piece of code, make sure you implement proper error handling.

You might be asked to give a high-level overview of how stack unwinding works when an exception is thrown, without implementation details.

Of course, not all programmers understand or appreciate exceptions. Some may even have a completely unfounded bias against them for performance reasons. If the interviewer asks you to do something without exceptions, you'll have to revert to traditional `nullptr` checks and error codes. That would be a good time to demonstrate your knowledge of `nothrow new`.

An interviewer can also ask questions in the form of “Would you use this?” One example question could be, “Would you use `setjmp()/longjmp()` in C++, as they are more efficient than exceptions?” Your answer should be a big no, because `setjmp()/longjmp()` do not work in C++ as they might bypass scoped destructors. The belief that exceptions have a big performance penalty is a misconception. On modern compilers, just having code that can handle potential exceptions has close to zero performance penalty.

CHAPTER 15: OVERLOADING C++ OPERATORS

It's possible, though somewhat unlikely, that you will have to perform something more difficult than a simple operator overload during an interview. Some interviewers like to have an advanced question on hand that they don't really expect anybody to answer correctly. The intricacies of operator overloading make great, nearly impossible questions because few programmers get the syntax right without looking it up. That means it's a great area to review before an interview.

Things to Remember

- Overloading stream operators, because they are commonly overloaded operators, and are conceptually unique
- What a functor is and how to create one

- Choosing between a method operator and a global function
- How some operators can be expressed in terms of others (for example, `operator<=` can be written by complementing the result of `operator>`)

Types of Questions

Let's face it: operator overloading questions (other than the simple ones) can be cruel. Anybody who is asking such questions knows this and is going to be impressed when you get it right. It's impossible to predict the exact question that you'll get, but the number of operators is finite. As long as you've seen an example of overloading each operator that makes sense to overload, you'll do fine!

Besides asking you to implement an overloaded operator, you could be asked high-level questions about operator overloading. A find-the-bug question could contain an operator that is overloaded to do something that is conceptually wrong for that particular operator. In addition to syntax, keep the use cases and theory of operator overloading in mind.

CHAPTERS 16, 17, 18, AND 21: THE STANDARD LIBRARY

As you've seen, certain aspects of the Standard Library can be difficult to work with. Few interviewers would expect you to recite the details of Standard Library classes unless you claim to be a Standard Library expert. If you know that the job you're interviewing for makes heavy use of the Standard Library, you might want to write some Standard Library code the day before to refresh your memory. Otherwise, recalling the high-level design of the Standard Library and its basic usage should suffice.

Things to Remember

- The different types of containers and their relationships with iterators
- Use of `vector`, which is the most frequently used Standard Library class
- Use of associative containers, such as `map`
- The differences between associative containers and unordered associative containers, such as `unordered_map`
- The purpose of Standard Library algorithms and some of the built-in algorithms
- The use of lambda expressions in combination with Standard Library algorithms
- The remove-erase idiom
- The fact that with C++17, a lot of the Standard Library algorithms have an option to execute in parallel
- The ways in which you can extend the Standard Library (details are most likely unnecessary)
- Your own opinions about the Standard Library

Types of Questions

If interviewers are dead set on asking detailed Standard Library questions, there really are no bounds to the types of questions they could ask. If you're feeling uncertain about syntax though, you should state the obvious during the interview: "In real life, of course, I'd look that up in *Professional C++*, but I'm pretty sure it works like this..." At least that way, the interviewer is reminded that he should forgive the details as long as you get the basic idea right.

High-level questions about the Standard Library are often used to gauge how much you've used the Standard Library without making you recall all the details. For example, casual users of the Standard Library may be familiar with associative and non-associative containers. A slightly more advanced user would be able to define an iterator, describe how iterators work with containers, and describe the remove-erase idiom. Other high-level questions could ask you about your experience with Standard Library algorithms, or whether you've customized the Standard Library. An interviewer might also gauge your knowledge about lambda expressions, and their use with Standard Library algorithms.

CHAPTER 20: ADDITIONAL LIBRARY UTILITIES

This chapter describes a number of features and additional libraries from the C++ standard that don't fit in other chapters, including some new C++17 features. An interviewer might touch on a few of those topics to see whether you are keeping up to date with the latest developments in the C++ world.

Things to Remember

- Compile-time rational numbers
- Using the chrono library to work with durations, clocks, and time points
- Using the `<random>` library as the preferred method of generating random numbers
- How to work with `std::optional` values
- The `std::variant` and `std::any` data types
- `std::tuple` as a generalization of `std::pair`
- The existence of a filesystem API

Types of Questions

You shouldn't expect detailed questions about these topics. However, knowledge of the C++17 `std::optional`, `variant`, and `any` classes will definitely score you extra points. You might also be asked to explain the basic ideas and concepts of the chrono and random number generation libraries, but without going into syntax details. If the interviewer starts focusing on random numbers, it is important to explain the differences between true random numbers and pseudo-random numbers. You should also explain how the random number generation library uses the concepts of generators and distributions.

CHAPTER 23: MULTITHREADED PROGRAMMING WITH C++

Multithreaded programming is becoming more and more important with the release of multicore processors for everything from servers to consumer computers. Even smartphones have multicore processors. An interviewer might ask you a couple of multithreading questions. C++ includes a standard threading support library, so it's a good idea to know how it works.

Things to Remember

- Race conditions and deadlocks and how to prevent them
- `std::thread` to spawn threads
- The atomic types and atomic operations
- The concept of mutual exclusion, including the use of the different mutex and lock classes, to provide synchronization between threads
- Condition variables and how to use them to signal other threads
- Futures and promises
- Copying and rethrowing of exceptions across thread boundaries

Types of Questions

Multithreaded programming is a complicated subject, so you don't need to expect detailed questions, unless you are interviewing for a specific multithreading programming position.

Instead, an interviewer might ask you to explain the different kinds of problems you can encounter with multithreaded code: problems such as race conditions, deadlocks, and tearing. You may also be asked to explain the general concepts behind multithreaded programming. This is a very broad question, but it allows the interviewer to get an idea of your multithreading knowledge. You can also mention that with C++17, a lot of the Standard Library algorithms have an option to run in parallel.

CHAPTER 24: MAXIMIZING SOFTWARE ENGINEERING METHODS

You should be suspicious if you go through the complete interview process with a company, and the interviewers do *not* ask any process questions—it may mean that they don't have any process or that they don't care about it. Alternatively, they might not want to scare you away with their process behemoth. Another important aspect of any development process is Source Code Control.

Most of the time, you'll get a chance to ask questions regarding the company. I suggest you consider asking about engineering processes and Source Code Control solutions as one of your standard questions.

Things to Remember

- Traditional life-cycle models
- The tradeoffs of different models
- The main principles behind Extreme Programming
- Scrum as an example of an Agile process
- Other processes you have used in the past
- Principles behind Source Code Control solutions

Types of Questions

The most common question you'll be asked is to describe the process that your previous employer used. Be careful, though, not to disclose any confidential information. When answering, you should mention what worked well and what failed, but try not to denounce any particular methodology. The methodology you criticize could be the one that your interviewer uses.

Almost every candidate is listing Scrum/Agile as a skill these days. If the interviewer asks you about Scrum, he probably doesn't want you to simply recite the textbook definition—the interviewer knows that you can read the table of contents of a Scrum book. Instead, pick a few ideas from Scrum that you find appealing. Explain each one to the interviewer along with your thoughts on it. Try to engage the interviewer in a conversation, proceeding in a direction in which he is interested based on the cues that he gives.

If you get a question regarding Source Code Control, it will most likely be a high-level question. You should explain the general principles behind Source Code Control solutions, mention the fact that there are commercial and free open-source solutions available, and possibly explain how Source Code Control was implemented by your previous employer.

CHAPTER 25: WRITING EFFICIENT C++

Efficiency questions are quite common in interviews because many organizations are facing scalability issues with their code and need programmers who are savvy about performance.

Things to Remember

- Language-level efficiency is important, but it can only go so far; design-level choices are ultimately much more significant.
- Algorithms with bad complexity, such as quadratic algorithms, should be avoided.
- Reference parameters are more efficient because they avoid copying.
- Object pools can help avoid the overhead of creating and destroying objects.
- Profiling is vital to determine which operations are really consuming the most time, so you don't waste effort trying to optimize code that is not a performance bottleneck.

Types of Questions

Often, the interviewer will use her own product as an example to drive efficiency questions. Sometimes the interviewer will describe an older design and some performance-related symptoms she experienced. The candidate is supposed to come up with a new design that alleviates the problem. Unfortunately, there is a major problem with a question like this: what are the odds that you're going to come up with the same solution that the company did when the problem was actually solved? Because the odds are slim, you need to be extra careful to justify your designs. You may not come up with the actual solution, but you could still have an answer that is correct or even better than the company's newer design.

Other types of efficiency questions may ask you to tweak some C++ code for performance or iterate on an algorithm. For example, the interviewer could show you code that contains extraneous copies or inefficient loops.

The interviewer might also ask you for a high-level description of profiling tools and what their benefits are.

CHAPTER 26: BECOMING ADEPT AT TESTING

Potential employers value strong testing abilities. Because your resume probably doesn't indicate your testing skills, unless you have explicit quality assurance (QA) experience, you might face interview questions about testing.

Things to Remember

- The difference between black-box and white-box testing
- The concept of unit testing, integration testing, system testing, and regression testing
- Techniques for higher-level tests
- Testing and QA environments in which you've worked before: what worked and what didn't?

Types of Questions

An interviewer could ask you to write some tests during the interview, but it's unlikely that a program presented during an interview would contain the depth necessary for interesting tests. It's more likely that you will be asked high-level testing questions. Be prepared to describe how testing was done at your last job, and what you liked and didn't like about it. Again, be careful not to disclose any confidential information. After you've answered the interviewer's questions about testing, a good question for you to ask the interviewer is to ask how testing is done at their company. It might start a conversation about testing and give you a better idea of the environment at your potential job.

CHAPTER 27: CONQUERING DEBUGGING

Engineering organizations look for candidates who are able to debug their own code as well as code that they've never seen before. Technical interviews often attempt to size up your debugging muscles.

Things to Remember

- Debugging doesn't start when bugs appear; you should instrument your code ahead of time, so you're prepared for bugs when they arrive.
- Logs and debuggers are your best tools.
- You should know how to use assertions.
- The symptoms that a bug exhibits may appear to be unrelated to the actual cause.
- Object diagrams can be helpful in debugging, especially during an interview.

Types of Questions

During an interview, you might be challenged with an obscure debugging problem. Remember that the process is the most important thing, and the interviewer probably knows that. Even if you don't find the bug during the interview, make sure that the interviewer knows what steps you would go through to track it down. If the interviewer hands you a function and tells you that it crashes during execution, he should award you just as many points if you properly discuss the sequence of steps to find the bug, as if you find the bug right away.

CHAPTER 28: INCORPORATING DESIGN TECHNIQUES AND FRAMEWORKS

Each of the techniques presented in Chapter 28 makes a fine interview question. Rather than repeat what you already read in the chapter, I suggest that you skim over Chapter 28 prior to an interview to make sure that you are able to understand each of the techniques.

If you are being interviewed for a GUI-based job, you should know about the existence of frameworks such as MFC, Qt, and possibly others.

CHAPTER 29: APPLYING DESIGN PATTERNS

Because design patterns are very popular in the professional world (many candidates even list them as skills), it's likely that you'll encounter an interviewer who wants you to explain a pattern, give a use case for a pattern, or implement a pattern.

Things to Remember

- The basic idea of a pattern as a reusable object-oriented design concept
- The patterns you have read about in this book, as well as others that you've used in your work
- The fact that you and your interviewer may use different words for the same pattern, given that there are hundreds of patterns with often-conflicting names

Types of Questions

Answering questions about design patterns is usually a walk in the park, unless the interviewer expects you to know the details of every single pattern known to humankind. Luckily, most interviewers who appreciate design patterns will just want to chat with you about them and get your opinions. After all, looking up concepts in a book or online instead of memorizing them is a good pattern in itself.

CHAPTER 30: DEVELOPING CROSS-PLATFORM AND CROSS-LANGUAGE APPLICATIONS

Few programmers submit resumes that list only a single language or technology, and few large applications rely on only a single language or technology. Even if you're only interviewing for a C++ position, the interviewer may still ask questions about other languages, especially as they relate to C++.

Things to Remember

- The ways in which platforms can differ (architecture, integer sizes, and so on)
- The fact that you should try to find a cross-platform library to accomplish a certain task, instead of starting to implement the functionality yourself for different kinds of platforms
- The interactions between C++ and other languages

Types of Questions

The most popular cross-language question is to compare and contrast two different languages. You should avoid saying only positive or negative things about a particular language, even if you really love or hate that language. The interviewer wants to know that you are able to see tradeoffs and make decisions based on them.

Cross-platform questions are more likely to be asked while discussing previous work. If your resume indicates that you once wrote C++ applications that ran on a custom hardware platform, you should be prepared to talk about the compiler you used and the challenges of that platform.

B

Annotated Bibliography

This appendix contains a list of books and online resources on various C++-related topics that were either consulted while writing this book, or are recommended for further or background reading.

C++

Beginning C++ Without Previous Programming Experience

- Bjarne Stroustrup. *Programming: Principles and Practice Using C++*, 2nd ed. Addison-Wesley Professional, 2014. ISBN: 0-321-99278-4.

An introduction to programming in C++ by the inventor of the language. This book assumes no previous programming experience, but even so, it is also a good read for experienced programmers.

- Steve Oualline. *Practical C++ Programming*, 2nd ed. O'Reilly Media, 2003. ISBN: 0-596-00419-2.

An introductory C++ text that assumes no prior programming experience.

- Walter Savitch. *Problem Solving with C++*, 9th ed. Pearson, 2014. ISBN: 0-133-59174-3.

Assumes no prior programming experience. This book is often used as a textbook in introductory programming courses.

Beginning C++ With Previous Programming Experience

- Bjarne Stroustrup. *A Tour of C++*. Addison-Wesley Professional, 2013. ISBN: 0-321-95831-4.

A quick (about 190 pages) tutorial-based overview of the entire C++ language and Standard Library at a moderately high level for people who already know C++ or are at least experienced programmers. This book includes C++11 features.

- Stanley B. Lippman, Josée Lajoie, and Barbara E. Moo. *C++ Primer*, 5th ed. Addison-Wesley Professional, 2012. ISBN: 0-321-71411-3.
A very thorough introduction to C++ that covers just about everything in the language in a very accessible format and in great detail.
- Andrew Koenig and Barbara E. Moo. *Accelerated C++: Practical Programming by Example*. Addison-Wesley Professional, 2000. ISBN: 0-201-70353-X.
Covers the same material as *C++ Primer*, but in much less space, because it assumes that the reader has programmed in another language before.
- Bruce Eckel. *Thinking in C++, Volume 1: Introduction to Standard C++*, 2nd ed. Prentice Hall, 2000. ISBN: 0-139-79809-9.
An excellent introduction to C++ programming that expects the reader to know C already. This text is available at no cost online at www.bruceeckel.com.

General C++

- The C++ Programming Language, at www.isocpp.org.
The home of Standard C++ on the web, containing news, status, and discussions about the C++ standard on all compilers and platforms.
- The C++ Super-FAQ, at isocpp.org/faq.
A huge collection of frequently asked questions about C++.
- Scott Meyers. *Effective Modern C++: 42 Specific Ways to Improve Your Use of C++11 and C++14*. O'Reilly, 2014. ISBN: 1-491-90399-6.
- Scott Meyers. *Effective C++: 55 Specific Ways to Improve Your Programs and Designs*, 3rd ed. Addison-Wesley Professional, 2005. ISBN: 0-321-33487-6.
- Scott Meyers. *More Effective C++: 35 New Ways to Improve Your Programs and Designs*. Addison-Wesley Professional, 1996. ISBN: 0-201-63371-X.
Three books that provide excellent tips and tricks on commonly misused and misunderstood features of C++.
- Bjarne Stroustrup. *The C++ Programming Language*, 4th ed. Addison-Wesley Professional, 2013. ISBN: 0-321-56384-0.
The “bible” of C++ books, written by the designer of C++. Every C++ programmer should own a copy of this book, although it can be a bit obscure in places for the C++ novice.
- Herb Sutter. *Exceptional C++: 47 Engineering Puzzles, Programming Problems, and Solutions*. Addison-Wesley Professional, 1999. ISBN: 0-201-61562-2.
Presented as a set of puzzles, with one of the best, most thorough discussions of proper resource management and exception safety in C++ through Resource Acquisition is Initialization (RAII). This book also includes in-depth coverage of a variety of topics, such as the `pimpl` idiom, name lookup, good class design, and the C++ memory model.

- Herb Sutter. *More Exceptional C++: 40 New Engineering Puzzles, Programming Problems, and Solutions*. Addison-Wesley Professional, 2001. ISBN: 0-201-70434-X.
Covers additional exception safety topics not covered in *Exceptional C++: 47 Engineering Puzzles, Programming Problems, and Solutions*. This book also discusses effective object-oriented programming and correct use of certain aspects of the Standard Library.
- Herb Sutter. *Exceptional C++ Style: 40 New Engineering Puzzles, Programming Problems, and Solutions*. Addison-Wesley Professional, 2004. ISBN: 0-201-76042-8.
Discusses generic programming, optimization, and resource management. This book also has an excellent exposition of how to write modular code in C++ by using nonmember functions and the single responsibility principle.
- Stephen C. Dewhurst. *C++ Gotchas: Avoiding Common Problems in Coding and Design*. Addison-Wesley Professional, 2002. ISBN: 0-321-12518-5.
Provides 99 specific tips for C++ programming.
- Bruce Eckel and Chuck Allison. *Thinking in C++, Volume 2: Practical Programming*. Prentice Hall, 2003. ISBN: 0-130-35313-2.
The second volume of Eckel's book, which covers more advanced C++ topics. The text is also available at no cost online at www.bruceeckel.com.
- Ray Lischner. *C++ in a Nutshell*. O'Reilly, 2009. ISBN: 0-596-00298-X.
A C++ reference covering everything from the basics to more-advanced material.
- Stephen Prata, *C++ Primer Plus*, 6th ed. Addison-Wesley Professional, 2011. ISBN: 0-321-77640-2.
One of the most comprehensive C++ books available.
- The C++ Reference, at www.cppreference.com.
An excellent reference of C++98, C++03, C++11, C++14, and C++17.
- *The C++ Resources Network*, at www.cplusplus.com.
A website containing a lot of information related to C++, with a complete reference of the language, including C++17.

I/O Streams and Strings

- Cameron Hughes and Tracey Hughes. *Stream Manipulators and Iterators in C++*. www.informit.com/articles/article.aspx?p=171014.
A well-written article that takes the mystery out of defining custom stream manipulators in C++.
- Philip Romanik and Amy Muntz. *Applied C++: Practical Techniques for Building Better Software*. Addison-Wesley Professional, 2003. ISBN: 0-321-10894-9.
A unique blend of software development advice and C++ specifics, as well as a very good explanation of locale and Unicode support in C++.

- Joel Spolsky. *The Absolute Minimum Every Software Developer Absolutely, Positively Must Know About Unicode and Character Sets (No Excuses!)*. www.joelonsoftware.com/articles/Unicode.html.
A treatise by Joel Spolsky on the importance of localization. After reading this, you'll want to check out the other entries on his *Joel on Software* website.
- The Unicode Consortium. *The Unicode Standard 5.0*, 5th ed. Addison-Wesley Professional, 2006. ISBN: 0-321-48091-0.
The definitive book on Unicode, which all developers using Unicode must have.
- Unicode, Inc. *Where is my Character?* www.unicode.org/standard/where.
The best resource for finding Unicode characters, charts, and tables.
- Wikipedia. *Universal Coded Character Set*. http://en.wikipedia.org/wiki/Universal_Character_Set.
An explanation of what the Universal Character Set (UCS) is, including the Unicode standard.

The C++ Standard Library

- Peter Van Weert and Marc Gregoire. *C++ Standard Library Quick Reference*. Apress, 2016. ISBN: 978-1-4842-1875-4.
This quick reference is a condensed guide to all essential data structures, algorithms, and functions provided by the C++ Standard Library
- Nicolai M. Josuttis. *The C++ Standard Library: A Tutorial and Reference*, 2nd ed. Addison-Wesley Professional, 2012. ISBN: 0-321-62321-5.
Covers the entire Standard Library, including I/O streams and strings as well as the containers and algorithms. This book is an excellent reference.
- Scott Meyers. *Effective STL: 50 Specific Ways to Improve Your Use of the Standard Template Library*. Addison-Wesley Professional, 2001. ISBN: 0-201-74962-9.
Written in the same spirit as the author's *Effective C++* books. This book provides targeted tips for using the Standard Library, but is not a reference or tutorial.
- Stephan T. Lavavej. *Standard Template Library (STL)*. <http://channel9.msdn.com/Shows/Going+Deep/C9-Lectures-Introduction-to-STL-with-Stephan-T-Lavavej>.
An interesting video lecture series on the C++ Standard Library.
- David R. Musser, Gillmer J. Derge, and Atul Saini. *STL Tutorial and Reference Guide: Programming with the Standard Template Library*, 2nd ed. Addison-Wesley Professional, 2001. ISBN: 0-321-70212-3.
Similar to the Josuttis text, but covering only parts of the Standard Library, such as containers and algorithms.

C++ Templates

- Herb Sutter. “Sutter’s Mill: Befriending Templates.” *C/C++ User’s Journal*. <http://drdobbs.com/cpp/184403853>.
An excellent explanation of making function templates friends of classes.
- David Vandevoorde, Nicolai M. Josuttis, and Douglas Gregor. *C++ Templates: The Complete Guide*, 2nd ed. Addison-Wesley Professional, 2017. ISBN: 0-321-71412-1.
Everything you ever wanted to know (or didn’t want to know) about C++ templates. This book assumes significant background in general C++.
- David Abrahams and Aleksey Gurtovoy. *C++ Template Metaprogramming: Concepts, Tools, and Techniques from Boost and Beyond*. Addison-Wesley Professional, 2004. ISBN: 0-321-22725-5.
Delivers practical metaprogramming tools and techniques into the hands of the everyday programmer.

C++11/C++14/C++17

- *C++ Standards Committee Papers*. www.open-std.org/jtc1/sc22/wg21/docs/papers.
A wealth of papers written by the C++ standards committee.
- Scott Meyers. *Presentation Materials: Overview of the New C++ (C++11/14)*. Artima, 2013. www.artima.com/shop/overview_of_the_new_cpp.
A document containing the presentation materials from a Scott Meyers’ training course. This is an excellent reference to get a list of all C++11 and select C++14 features.
- Wikipedia. *C++11*. <http://en.wikipedia.org/wiki/C%2B%2B11>.
- Wikipedia. *C++14*. <http://en.wikipedia.org/wiki/C%2B%2B14>.
- Wikipedia. *C++17*. <http://en.wikipedia.org/wiki/C%2B%2B17>.
Three Wikipedia articles with a description of new features added to C++11, C++14, and C++17.
- *ECMAScript 2017 Language Specification*. www.ecma-international.org/publications/files/ECMA-ST/ECMA-262.pdf.
One of the syntaxes of the regular expressions in C++ is the same as the regular expressions in the ECMAScript language, as described in this specification document.

UNIFIED MODELING LANGUAGE

- Russ Miles and Kim Hamilton. *Learning UML 2.0: A Pragmatic Introduction to UML*. O’Reilly Media, 2006. ISBN: 0-596-00982-8.
A very readable book on UML 2.0. The authors use Java in examples, but they are convertible to C++ without too much trouble.

ALGORITHMS AND DATA STRUCTURES

- ▶ Thomas H. Cormen, Charles E. Leiserson, Ronald L. Rivest, and Clifford Stein. *Introduction to Algorithms*, 3rd ed. The MIT Press, 2009. ISBN: 0-262-03384-4.
One of the most popular introductory algorithms books, covering all the common data structures and algorithms.
- ▶ Donald E. Knuth. *The Art of Computer Programming Volume 1: Fundamental Algorithms*, 3rd ed. Addison-Wesley Professional, 1997. ISBN: 0-201-89683-1.
- ▶ Donald E. Knuth. *The Art of Computer Programming Volume 2: Seminumerical Algorithms*, 3rd ed. Addison-Wesley Professional, 1997. ISBN: 0-201-89684-2.
- ▶ Donald E. Knuth. *The Art of Computer Programming Volume 3: Sorting and Searching*, 2nd ed. Addison-Wesley Professional, 1998. ISBN: 0-201-89685-0.
- ▶ Donald E. Knuth. *The Art of Computer Programming Volume 4A: Combinatorial Algorithms, Part 1*. Addison-Wesley Professional, 2011. ISBN: 0-201-03804-8.
Knuth's four-volume tome on algorithms and data structures. If you enjoy mathematical rigor, there is no better text on this topic. However, it is probably inaccessible without undergraduate knowledge of mathematics or theoretical computer science.
- ▶ Kyle Loudon. *Mastering Algorithms with C: Useful Techniques from Sorting to Encryption*. O'Reilly Media, 1999. ISBN: 1-565-92453-3.
An approachable reference to data structures and algorithms.

RANDOM NUMBERS

- ▶ Eric Bach and Jeffrey Shallit. *Algorithmic Number Theory, Efficient Algorithms*. The MIT Press, 1996. ISBN: 0-262-02405-5.
- ▶ Oded Goldreich. *Modern Cryptography, Probabilistic Proofs and Pseudorandomness*. Springer, 2010. ISBN: 3-642-08432-X.
Two books that explain the theory of computational pseudo-randomness.
- ▶ Wikipedia. *Mersenne Twister*. http://en.wikipedia.org/wiki/Mersenne_twister.
A mathematical explanation of the Mersenne Twister, used to generate pseudo-random numbers.

OPEN-SOURCE SOFTWARE

- ▶ The Open Source Initiative at www.opensource.org.
- ▶ The GNU Operating System—Free Software Foundation at www.gnu.org.
Websites where the two main open-source movements explain their philosophies and provide information about obtaining open-source software and contributing to its development.

- The Boost C++ Libraries at www.boost.org.
A huge number of free, peer-reviewed portable C++ source libraries. This website is definitely worth checking out.
- GitHub at www.github.com, and SourceForge at www.sourceforge.net.
Two websites that host many open-source projects. These are great resources for finding useful open-source software.
- www.codeguru.com and www.codeproject.com.
Excellent resources to find free libraries and code for reuse in your own projects.

SOFTWARE ENGINEERING METHODOLOGY

- Robert C. Martin. *Agile Software Development, Principles, Patterns, and Practices*. Pearson, 2013. ISBN: 978-1292025940.
Written for software engineers “in the trenches,” this text focuses on the technology—the principles, patterns, and process—that help software engineers effectively manage increasingly complex operating systems and applications.
- Mike Cohn. *Succeeding with Agile: Software Development Using Scrum*. Addison-Wesley Professional, 2009. ISBN: 0-321-57936-4.
An excellent guide to start with the Scrum methodology.
- Andrew Hunt and David Thomas, *The Pragmatic Programmer*. Addison Wesley, 1999. ISBN: 978-0201616224.
A classic book, and a must read for every software engineer. Almost twenty years later, its advice is still spot on. It examines the core process—what do you do, as an individual and as a team, if you want to create software that’s easy to work with and good for your users.
- Barry W. Boehm, TRW Defense Systems Group. “A Spiral Model of Software Development and Enhancement.” *IEEE Computer*, 21(5): 61–72, 1988.
A landmark paper that described the state of software development at the time and proposed the Spiral Model.
- Kent Beck and Cynthia Andres. *Extreme Programming Explained: Embrace Change*, 2nd ed. Addison-Wesley Professional, 2004. ISBN: 0-321-27865-8.
One of several books in a series that promote Extreme Programming as a new approach to software development.
- Robert T. Futrell, Donald F. Shafer, and Linda Isabell Shafer. *Quality Software Project Management*. Prentice Hall, 2002. ISBN: 0-130-91297-2.
A guidebook for anybody who is responsible for the management of software development processes.
- Robert L. Glass. *Facts and Fallacies of Software Engineering*. Addison-Wesley Professional, 2002. ISBN: 0-321-11742-5.
Discusses various aspects of the software development process and exposes hidden truisms along the way.

- Philippe Kruchten. *The Rational Unified Process: An Introduction*, 3rd ed. Addison-Wesley Professional, 2003. ISBN: 0-321-19770-4.
Provides an overview of RUP, including its mission and processes.
- Edward Yourdon. *Death March*, 2nd ed. Prentice Hall, 2003. ISBN: 0-131-43635-X.
A wonderfully enlightening book about the politics and realities of software development.
- Wikipedia. *Scrum*. [http://en.wikipedia.org/wiki/Scrum_\(software_development\)](http://en.wikipedia.org/wiki/Scrum_(software_development)).
A detailed discussion of the Scrum methodology.
- *Manifesto for Agile Software Development*. <http://agilemanifesto.org/>.
The complete Agile software development manifesto.
- Wikipedia. *Version control*. https://en.wikipedia.org/wiki/Version_control.
Explains the concepts behind revision control systems, and what kinds of solutions are available.

PROGRAMMING STYLE

- Bjarne Stroustrup and Herb Sutter. *C++ Core Guidelines*. <https://github.com/isocpp/CppCoreGuidelines/blob/master/CppCoreGuidelines.md>.
This document is a set of guidelines for using C++ well. The aim of this document is to help people to use modern C++ effectively.
- Martin Fowler, Kent Beck, John Brant, William Opdyke, and Don Roberts. *Refactoring: Improving the Design of Existing Code*. Addison-Wesley Professional, 1999. ISBN: 0-201-48567-2.
A classic book that espouses the practice of recognizing and improving bad code.
- Herb Sutter and Andrei Alexandrescu. *C++ Coding Standards: 101 Rules, Guidelines, and Best Practices*. Addison-Wesley Professional, 2004. ISBN: 0-321-11358-0.
A must-have book on C++ design and coding style. “Coding standards” here doesn’t mean “how many spaces I should indent my code.” This book contains 101 best practices, idioms, and common pitfalls that can help you to write correct, understandable, and efficient C++ code.
- Diomidis Spinellis. *Code Reading: The Open Source Perspective*. Addison-Wesley Professional, 2003. ISBN: 0-201-79940-5.
A unique book that turns the issue of programming style upside down by challenging the reader to learn to read code properly in order to become a better programmer.
- Dimitri van Heesch. *Doxygen*. www.stack.nl/~dimitri/doxygen/index.html.
A highly configurable program that generates documentation from source code and comments.

- John Aycock. *Reading and Modifying Code*. John Aycock, 2008. ISBN 0-980-95550-5.
A nice little book with advice about how to perform the most common operations on code: reading, modifying, testing, debugging, and writing.
- Wikipedia. *Code refactoring*. <http://en.wikipedia.org/wiki/Refactoring>.
A discussion of what code refactoring means, including a number of techniques for refactoring.
- Google. *Google C++ Style Guide*. <https://google.github.io/styleguide/cppguide.html>.
A discussion of the C++ style guidelines used at Google.

COMPUTER ARCHITECTURE

- David A. Patterson and John L. Hennessy. *Computer Organization and Design: The Hardware/Software Interface*, 4th ed. Morgan Kaufmann, 2011. ISBN: 0-123-74493-8.
- John L. Hennessy and David A. Patterson. *Computer Architecture: A Quantitative Approach*, 5th ed. Morgan Kaufmann, 2011. ISBN: 0-123-83872-X.
Two books that provide all the information most software engineers will ever need to know about computer architecture.

EFFICIENCY

- Dov Bulka and David Mayhew. *Efficient C++: Performance Programming Techniques*. Addison-Wesley Professional, 1999. ISBN: 0-201-37950-3.
One of the few books to focus exclusively on efficient C++ programming. This book covers both language-level and design-level efficiency.
- GNU gprof, <http://sourceware.org/binutils/docs/gprof/>.
Information about the gprof profiling tool.

TESTING

- Elfriede Dustin. *Effective Software Testing: 50 Specific Ways to Improve Your Testing*. Addison-Wesley Professional, 2002. ISBN: 0-201-79429-2.
A book aimed at quality assurance professionals, although any software engineer will benefit from this book's discussion of the software-testing process.

DEBUGGING

- Microsoft Visual Studio Community Edition, at <http://microsoft.com/vs>.
The Community Edition of Microsoft Visual Studio is a version of Visual Studio free of charge for students, open-source developers, and individual developers to create both free and paid applications. It's also free of charge for up to five users in small organizations. It comes with an excellent graphical symbolic debugger.
- The GNU Debugger (GDB), at www.gnu.org/software/gdb/gdb.html.
An excellent command-line symbolic debugger.
- Valgrind, at <http://valgrind.org/>.
An open-source memory-debugging tool for Linux.
- Microsoft Application Verifier, at <https://docs.microsoft.com/en-us/windows-hardware/drivers/debugger/application-verifier>.
A run-time verification tool for C++ code that assists in finding subtle programming errors and security issues that can be difficult to identify with normal application testing techniques.

DESIGN PATTERNS

- Erich Gamma, Richard Helm, Ralph Johnson, and John Vlissides. *Design Patterns: Elements of Reusable Object-Oriented Software*. Addison-Wesley Professional, 1994. ISBN: 0-201-63361-2.
Called the “Gang of Four” (GoF) book (because of its four authors), the seminal work on design patterns.
- Andrei Alexandrescu. *Modern C++ Design: Generic Programming and Design Patterns Applied*. Addison-Wesley Professional, 2001. ISBN: 0-201-70431-5.
Offers an approach to C++ programming that employs highly reusable code and patterns.
- John Vlissides. *Pattern Hatching: Design Patterns Applied*. Addison-Wesley Professional, 1998. ISBN: 0-201-43293-5.
A companion to the GoF book, explaining how patterns can actually be applied.
- Eric Freeman, Bert Bates, Kathy Sierra, and Elisabeth Robson. *Head First Design Patterns*. O'Reilly Media, 2004. ISBN: 0-596-00712-4.
A book that goes further than just listing design patterns. The authors show good and bad examples of using patterns, and give solid reasoning behind each pattern.
- Wikipedia. *Software design pattern*. [http://en.wikipedia.org/wiki/Design_pattern_\(computer_science\)](http://en.wikipedia.org/wiki/Design_pattern_(computer_science)).
Contains descriptions of a large number of design patterns used in computer programming.

OPERATING SYSTEMS

- Abraham Silberschatz, Peter B. Galvin, and Greg Gagne. *Operating System Concepts*, 9th ed. Wiley, 2012. ISBN: 1-118-06333-3.
A great discussion on operating systems, including multithreading issues such as deadlocks and race conditions.

MULTITHREADED PROGRAMMING

- Anthony Williams. *C++ Concurrency in Action: Practical Multithreading*. Manning Publications, 2012. ISBN: 1-933-98877-0.
An excellent book on practical multithreaded programming, including the C++ threading library.
- Cameron Hughes and Tracey Hughes. *Professional Multicore Programming: Design and Implementation for C++ Developers*. Wrox, 2008. ISBN: 0-470-28962-7.
A book for developers of various skill levels who are making the move into multicore programming.
- Maurice Herlihy and Nir Shavit. *The Art of Multiprocessor Programming*. Morgan Kaufmann, 2012. ISBN: 0-123-97337-6.
A great book on writing code for multiprocessor and multicore systems.

C

Standard Library Header Files

The interface to the C++ Standard Library consists of 87 header files, 26 of which present the C Standard Library. It's often difficult to remember which header files you need to include in your source code, so this appendix provides a brief description of the contents of each header, organized into eight categories:

- The C Standard Library
- Containers
- Algorithms, iterators, and allocators
- General utilities
- Mathematical utilities
- Exceptions
- I/O streams
- Threading support library

THE C STANDARD LIBRARY

The C++ Standard Library includes almost the entire C Standard Library. The header files are generally the same, except for two points:

- The header names are `<cname>` instead of `<name.h>`.
- All the names declared in the `<cname>` header files are in the `std` namespace.

NOTE *For backward compatibility, you can still include `<name.h>` if you want. However, that puts the names into the global namespace instead of the `std` namespace, and on top of that, the use of `<name.h>` has been deprecated. It is recommended to avoid this feature.*

The following table provides a summary of the most useful functionality. Note that it's recommended to avoid using C functionality, and instead use equivalent C++ features whenever possible.

HEADER FILENAME	CONTENTS
<cassert>	assert() macro
<ccomplex>	Only includes <complex>. This header is deprecated since C++17.
<cctype>	Character predicates and manipulation functions, such as isspace() and tolower()
<cerrno>	Defines errno expression, a macro to get the last error number for certain C functions.
<cfenv>	Supports the floating-point environment, such as floating-point exceptions, rounding, and so on.
<cfloat>	C-style defines related to floating-point arithmetic, such as FLT_MAX
< cinttypes>	Defines a number of macros to use with the printf(), scanf(), and similar functions. This header also includes a few functions to work with intmax_t.
<ciso646>	In C, the <iso646.h> file defines macros and, or, and so on. In C++, those are keywords, so this header is empty.
<climits>	C-style limit defines, such as INT_MAX. It is recommended to use the C++ equivalents from <limits> instead.
<locale>	A few localization macros and functions like LC_ALL and setlocale(). See also the C++ equivalents in <locale>.
<cmath>	Math utilities, including trigonometric functions sqrt(), fabs(), and others
<csignal>	signal() and raise(). Avoid these in C++.
<stdalign>	Alignment-related macro __alignas_is_defined. This is deprecated since C++17.
<stdarg>	Macros and types for processing variable-length argument lists
<stdbool>	Boolean type-related macro __bool_true_false_are_defined. This is deprecated since C++17.
<stddef>	Important constants such as NULL, and important types such as size_t
<stdint>	Defines a number of standard integer types such as int8_t, int64_t and so on. It also includes macros specifying minimum and maximum values of those types.

HEADER FILENAME	CONTENTS
<code><cstdio></code>	File operations, including <code>fopen()</code> and <code>fclose()</code> . Formatted I/O: <code>printf()</code> , <code>scanf()</code> , and family. Character I/O: <code>getc()</code> , <code>putc()</code> , and family. File positioning: <code>fseek()</code> and <code>ftell()</code> . It is recommended to use C++ streams instead. (See the section “I/O Streams,” later in this appendix.)
<code><cstdlib></code>	Random numbers with <code>rand()</code> and <code>srand()</code> (deprecated since C++14; use the C++ <code><random></code> instead). This header includes the <code>abort()</code> and <code>exit()</code> functions, which you should avoid; C-style memory allocation functions <code>calloc()</code> , <code>malloc()</code> , <code>realloc()</code> , and <code>free()</code> ; C-style searching and sorting with <code>qsort()</code> and <code>bsearch()</code> ; string to number conversions: <code>atof()</code> , <code>atoi()</code> ; a set of functions related to multibyte/wide string manipulation.
<code><cstring></code>	Low-level memory management functions, including <code>memcpy()</code> and <code>memset()</code> . This header includes C-style string functions, such as <code>strcpy()</code> and <code>strcmp()</code> .
<code><ctgmath></code>	Only includes <code><complex></code> and <code><cmath></code> . This header is deprecated since C++17.
<code><ctime></code>	Time-related functions, including <code>time()</code> and <code>localtime()</code>
<code><cuchar></code>	Defines a number of Unicode-related macros, and functions like <code>mbrtoc16()</code> .
<code><wchar></code>	Versions of string, memory, and I/O functions for wide characters
<code><wctype></code>	Versions of functions in <code><cctype></code> for wide characters: <code>iswspace()</code> , <code>towlower()</code> , and so on.

CONTAINERS

The definitions for the Standard Library containers can be found in 12 header files.

HEADER FILENAME	CONTENTS
<code><array></code>	The <code>array</code> class template
<code><bitset></code>	The <code>bitset</code> class template
<code><deque></code>	The <code>deque</code> class template
<code><forward_list></code>	The <code>forward_list</code> class template
<code><list></code>	The <code>list</code> class template
<code><map></code>	The <code>map</code> and <code>multimap</code> class templates
<code><queue></code>	The <code>queue</code> and <code>priority_queue</code> class templates

continues

(continued)

HEADER FILENAME	CONTENTS
<code><set></code>	The <code>set</code> and <code>multiset</code> class templates
<code><stack></code>	The <code>stack</code> class template
<code><unordered_map></code>	The <code>unordered_map</code> and <code>unordered_multimap</code> class templates
<code><unordered_set></code>	The <code>unordered_set</code> and <code>unordered_multiset</code> class templates
<code><vector></code>	The <code>vector</code> class template and the <code>vector<bool></code> specialization

Each of these header files contains all the definitions you need to use the specified container, including iterators. Chapter 17 describes these containers in detail.

ALGORITHMS, ITERATORS, AND ALLOCATORS

The following header files define the available Standard Library algorithms, iterators, and allocators.

HEADER FILENAME	CONTENTS
<code><algorithm></code>	Prototypes for most of the algorithms in the Standard Library. See Chapter 18.
<code><execution></code>	Defines the execution policy types for use with the Standard Library algorithms. See Chapter 18.
<code><functional></code>	Defines the built-in function objects, negators, binders, and adaptors. See Chapter 18.
<code><iterator></code>	Definitions of <code>iterator_traits</code> , <code>iterator</code> tags, <code>iterator</code> , <code>reverse_iterator</code> , insert iterators (such as <code>back_insert_iterator</code>), and stream iterators. See Chapter 21.
<code><memory></code>	Defines the default allocator, functions for dealing with uninitialized memory inside containers, <code>unique_ptr</code> , <code>shared_ptr</code> , <code>make_unique()</code> , and <code>make_shared()</code> , introduced in Chapter 1.
<code><memory_resource></code>	Defines polymorphic allocators and memory resources. See Chapter 21.
<code><numeric></code>	Prototypes for some numerical algorithms: <code>accumulate()</code> , <code>inner_product()</code> , <code>partial_sum()</code> , <code>adjacent_difference()</code> , and a few others. See Chapter 18.
<code><scoped_allocator></code>	An allocator that can be used with nested containers such as a vector of strings, or a vector of maps.

C++17

C++17

GENERAL UTILITIES

The Standard Library contains some general-purpose utilities in several different header files.

	HEADER FILENAME	CONTENTS
C++17	<code><any></code>	Defines the <code>any</code> class. See Chapter 20.
C++17	<code><charconv></code>	Defines the <code>chars_format</code> enumeration class, the <code>from_chars()</code> and <code>to_chars()</code> functions, and related structs.
	<code><chrono></code>	Defines the chrono library. See Chapter 20.
	<code><codecvt></code>	Provides code conversion facets for various character encodings. This header is deprecated since C++17.
C++17	<code><filesystem></code>	Defines all available classes and functions to work with the filesystem. See Chapter 20.
	<code><initializer_list></code>	Defines the <code>initializer_list</code> class. See Chapter 1.
	<code><limits></code>	Defines the <code>numeric_limits</code> class template, and specializations for most built-in types. See Chapter 16.
	<code><locale></code>	Defines the <code>locale</code> class, the <code>use_facet()</code> and <code>has_facet()</code> function templates, and the various facet families. See Chapter 19.
	<code><new></code>	Defines the <code>bad_alloc</code> exception and <code>set_new_handler()</code> function. This header also defines the prototypes for all six forms of operator <code>new</code> and operator <code>delete</code> . See Chapter 15.
C++17	<code><optional></code>	Defines the <code>optional</code> class. See Chapter 20.
	<code><random></code>	Defines the random number generation library. See Chapter 20.
	<code><ratio></code>	Defines the Ratio library to work with compile-time rational numbers. See Chapter 20.
	<code><regex></code>	Defines the regular expressions library. See Chapter 19.
	<code><string></code>	Defines the <code>basic_string</code> class template and the type aliases <code>string</code> and <code>wstring</code> . See Chapter 2.
C++17	<code><string_view></code>	Defines the <code>basic_string_view</code> class template and the type aliases <code>string_view</code> and <code>wstring_view</code> . See Chapter 2.
	<code><system_error></code>	Defines error categories and error codes.
	<code><tuple></code>	Defines the <code>tuple</code> class template as a generalization of the <code>pair</code> class template. See Chapter 20.

continues

(continued)

HEADER FILENAME	CONTENTS
<code><type_traits></code>	Defines type traits for use with template metaprogramming. See Chapter 22.
<code><typeindex></code>	Defines a simple wrapper for <code>type_info</code> , which can be used as an index type in associative containers and in unordered associative containers.
<code><typeinfo></code>	Defines the <code>bad_cast</code> and <code>bad_typeid</code> exceptions. Defines the <code>type_info</code> class, objects of which are returned by the <code>typeid</code> operator. See Chapter 10 for details on <code>typeid</code> .
<code><utility></code>	Defines the <code>pair</code> class template and <code>make_pair()</code> (see Chapter 17). This header also defines utility functions such as <code>swap()</code> , <code>exchange()</code> , <code>move()</code> , and more.
<code><variant></code>	Defines the <code>variant</code> class. See Chapter 20.

C++17

MATHEMATICAL UTILITIES

C++ provides some facilities for numeric processing. These capabilities are not described in detail in this book; for details, consult one of the Standard Library references listed in the Annotated Bibliography in Appendix B.

HEADER FILENAME	CONTENTS
<code><complex></code>	Defines the <code>complex</code> class template for working with complex numbers.
<code><valarray></code>	Defines <code>valarray</code> and related classes and class templates for working with mathematical vectors and matrices.

EXCEPTIONS

Exceptions and exception support are covered in Chapter 14. Two header files provide most of the requisite definitions, but some exceptions for other domains are defined in the header file for that domain.

HEADER FILENAME	CONTENTS
<code><exception></code>	Defines the <code>exception</code> and <code>bad_exception</code> classes, and the <code>set_unexpected()</code> , <code>set_terminate()</code> , and <code>uncaught_exception()</code> functions.
<code><stdexcept></code>	Non-domain-specific exceptions not defined in <code><exception></code> .

I/O STREAMS

The following table lists all the header files related to I/O streams in C++. However, normally your applications only need to include `<fstream>`, `<iomanip>`, `<iostream>`, `<istream>`, `<ostream>`, and `<sstream>`. Consult Chapter 13 for details.

HEADER FILENAME	CONTENTS
<code><fstream></code>	Defines the <code>basic_filebuf</code> , <code>basic_ifstream</code> , <code>basic_ofstream</code> , and <code>basic_fstream</code> classes. This header declares the <code>filebuf</code> , <code>wfilebuf</code> , <code>ifstream</code> , <code>wifstream</code> , <code>ofstream</code> , <code>wofstream</code> , <code>fstream</code> , and <code>wfstream</code> type aliases.
<code><iomanip></code>	Declares the I/O manipulators not declared elsewhere (mostly in <code><ios></code>).
<code><ios></code>	Defines the <code>ios_base</code> and <code>basic_ios</code> classes. This header declares most of the stream manipulators. You rarely have to include this header directly.
<code><iosfwd></code>	Forward declarations of the templates and type aliases found in the other I/O stream header files. You rarely need to include this header directly.
<code><iostream></code>	Declares <code>cin</code> , <code>cout</code> , <code>cerr</code> , <code>clog</code> , and the wide-character counterparts. Note that it's not just a combination of <code><istream></code> and <code><ostream></code> .
<code><istream></code>	Defines the <code>basic_istream</code> and <code>basic_iostream</code> classes. This header declares the <code>istream</code> , <code>wistream</code> , <code>iostream</code> , and <code>wiostream</code> type aliases.
<code><ostream></code>	Defines the <code>basic_ostream</code> class. This header declares the <code>ostream</code> and <code>wostream</code> type aliases.
<code><sstream></code>	Defines the <code>basic_stringbuf</code> , <code>basic_istringstream</code> , <code>basic_ostringstream</code> , and <code>basic_stringstream</code> classes. This header declares the <code>stringbuf</code> , <code>wstringbuf</code> , <code>istringstream</code> , <code>wistringstream</code> , <code>ostringstream</code> , <code>wostringstream</code> , <code>stringstream</code> , and <code>wstringstream</code> type aliases.
<code><streambuf></code>	Defines the <code>basic_streambuf</code> class. This header declares the type aliases <code>streambuf</code> and <code>wstreambuf</code> . You rarely have to include this header directly.
<code><strstream></code>	Deprecated.

THREADING SUPPORT LIBRARY

C++ includes a threading support library, which allows you to write platform-independent multi-threaded applications. See Chapter 23 for details. The threading support library consists of the following header files.

HEADER FILENAME	CONTENTS
<code><atomic></code>	Defines the atomic types, <code>atomic<T></code> , and atomic operations.
<code><condition_variable></code>	Defines the <code>condition_variable</code> and <code>condition_variable_any</code> classes.
<code><future></code>	Defines <code>future</code> , <code>promise</code> , <code>packaged_task</code> , and <code>async()</code> .
<code><mutex></code>	Defines <code>call_once()</code> and the different non-shared mutex and lock classes.
<code><shared_mutex></code>	Defines the <code>shared_mutex</code> , <code>shared_timed_mutex</code> , and <code>shared_lock</code> classes.
<code><thread></code>	Defines the <code>thread</code> class.

D

Introduction to UML

Unified Modeling Language, or UML, is the industry standard for diagrams visualizing class hierarchies, subsystem interactions, sequence diagrams, and so on. This book uses UML for its class diagrams. Explaining the entire UML standard warrants a book in itself, so this appendix is just a brief introduction to only those aspects of UML that are used throughout this book, which are class diagrams. There are different versions of the UML standard. This book uses UML 2.

TYPES OF DIAGRAMS

UML defines the following collection of types of diagrams:

- Structural UML diagrams
 - Class diagram
 - Component diagram
 - Composite structure diagram
 - Deployment diagram
 - Object diagram
 - Package diagram
 - Profile diagram
- Behavioral UML diagrams
 - Activity diagram
 - Communication diagram
 - Interaction overview diagram
 - Sequence diagram

- State diagram
- Timing diagram
- Use case diagram

Because this book only uses class diagrams, that is the only type of diagram that is discussed further in this appendix.

CLASS DIAGRAMS

Class diagrams are used to visualize individual classes and the relationships between different classes, both are discussed in the next sections.

Class Representation

A class is represented in UML as a box with a maximum of three compartments, containing the following:

- The name of the class
- The data members of the class
- The methods of the class

Figure D-1 shows an example.

`MyClass` has two data members—one of type `string`, the other of type `float`—and it has two methods. The plus and minus signs in front of each member specify its visibility. The following table lists the most commonly used visibilities.

VISIBILITY	MEANING
+	public member
-	private member
#	protected member

Depending on the goal of your class diagram, sometimes details of members are left out, in which case a class is represented with a box, as shown in Figure D-2. This can, for example, be used if you are only interested in visualizing the relationships between different classes without details of members of individual classes.

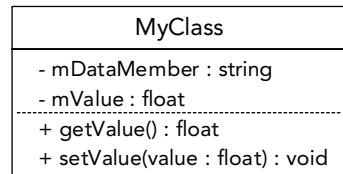

FIGURE D-1

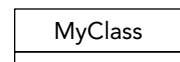

FIGURE D-2

Relationships Representation

UML 2 supports six different kinds of relationships between classes. I discuss these relationships in the following sections.

Inheritance

Inheritance is visualized using a line starting from the derived class and going to the base class. The line ends in a hollow triangle on the side of the base class, depicting the is-a relationship. Figure D-3 shows an example.

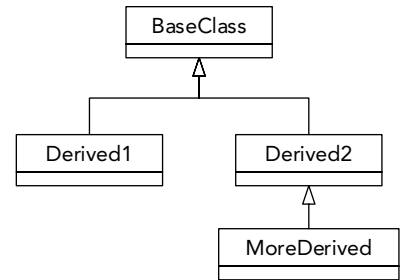

FIGURE D-3

Realization/Implementation

A class implementing a certain interface is basically inheriting from that interface (is-a relationship). However, to make a distinction between generic inheritance and interface realization, the latter is visualized similar to inheritance but using a dashed line instead of a solid line, as shown in Figure D-4. The `ListBox` class is derived from `UIElement`, and implements/realizes the `Clickable` and `Scrollable` interfaces.

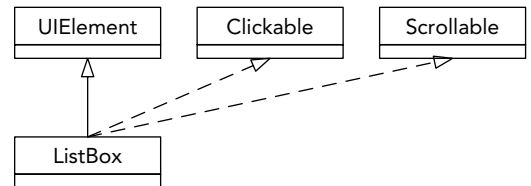

FIGURE D-4

Aggregation

Aggregation represents a has-a relationship. It is shown with a line with a hollow diamond shape on the side of the class that contains the instance or instances of the other class. In an aggregation relationship, you can also optionally specify the multiplicity of each participant in the relationship. The location of the multiplicity, that is, on which side of the line you need to write it, can be confusing at first (see Figure D-5). In this example, a `Class` can contain/aggregate one or more `Students`, and each student can follow zero or more `Classes`. An aggregation relationship means that the aggregated object or objects can continue to live when the aggregator is destroyed. For example, if a `Class` is destroyed, its `Students` are not destroyed.

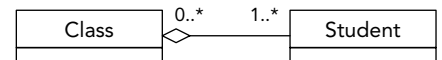

FIGURE D-5

The following table lists a few examples of possible multiplicities.

MULTIPLICITY	MEANING
N	Exactly N instances
0..1	Zero or one instance
0..*	Zero or more instances
N..*	N or more instances

Composition

Composition is very similar to aggregation, and is visually represented almost the same, except that a full diamond is used instead of a hollow diamond. With composition, in contrast to aggregation,

if the class that contains instances of the other class is destroyed, those contained instances are destroyed as well. Figure D-6 shows an example. A `Window` can contain zero or more `Buttons`, and each `Button` has to be contained by exactly one `Window`. If the `Window` is destroyed, all `Buttons` it contains are destroyed as well.

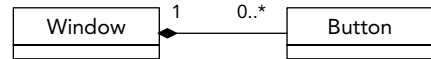

FIGURE D-6

Dependency

A dependency visualizes that a class depends on another class. It is depicted as a dashed line with an arrow pointing toward the dependent class. Usually, some text on the dashed line describes the dependency. To come back to the car factory example of Chapter 29, a `CarFactory` is dependent on a `Car` because the factory creates the cars. This is visualized in Figure D-7.

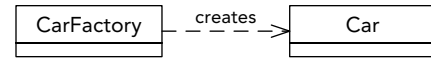

FIGURE D-7

Association

An association is a generalization of an aggregation. It represents a binary link between classes, while an aggregation is a unidirectional link. A binary link can be traversed in both directions. Figure D-8 shows an example. Every `Book` knows who its authors are, and every `Author` knows which books she wrote.

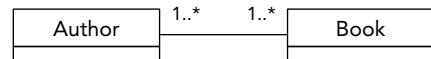

FIGURE D-8

INDEX

Symbols

< > (angle brackets), in templates, 383
|| operator, 21
character, 5
! operator, 13, 21
!= operator, 20
% operator, 13
%= operator, 13
& operator, 14
&& operator, 21
&= operator, 14
* operator, 13
*= operator, 13
+ operator, 13
++ operator, 13
+= operator, 13
-- operator, 13
-= operator, 13
/ operator, 13
/= operator, 13
<< operator, 14
 output streams and, 412
 overloading, 423–425
<<= operator, 14
<= operator, 20
= operator, 13
== operator, 20
> operator, 20
>> operator, 14
 input streams, 417–418
 overloading, 423–425
>>= operator, 14
>= operator, 20

^ operator, 14
^= operator, 14
| operator, 14
|= operator, 14

A

abs() function, 511, 695
abstract classes, 303
abstraction
 design, 141
 implementation, 138–139
 interface, 138–139
 reusable code and, 145–146
access, 201
accumulate algorithm, 611–612
adaptor function objects
 binders, 624–626
 member functions, call, calling, 628–629
 negators, 626–627
adaptor patterns, 1006–1008
adjacent_find() algorithm, 524
Agile Manifesto, 866–867
<algorithm> header, 630–631
algorithms, 630–631
 accumulate, 611–612
 auditing voter registration example,
 657–661
 binary search, 649–650
 binary_search(), 529
 equal_range(), 529
 lower_bound(), 529
 upper_bound(), 529

- callbacks, 607
- comparison, 524–525
 - equal(), 525
 - lexicographical_compare(), 525
 - mismatch(), 525
- counting, 525
 - all_of(), 525
 - any_of(), 525
 - count(), 525
 - count_if(), 525
 - none_of(), 525
- find(), 608–611
- find_all(), 735–736
- find_if(), 608–611
- header files, 1078–1079
- heap
 - is_heap, 530
 - is_heap_until(), 530
 - make_heap(), 530
 - pop_heap(), 530
 - push_heap(), 530
 - sort_heap(), 530
- iterators, 521–522, 608, 631, 737
- minimum-maximum, 653–654
 - clamp(), 530
 - max(), 530
 - max_element(), 530
 - min(), 530
 - min_element(), 530
 - minmax(), 530
 - minmax_element(), 530
- modifying sequence
 - copy(), 525, 638–639
 - copy_backward(), 525
 - copy_if(), 525
 - copy_n(), 525
 - fill(), 526
 - fill_n(), 526
 - generate(), 526
 - generate_n(), 526
 - move(), 526, 640–641
 - move_backward(), 526
 - random_shuffle(), 526
 - remove(), 526, 641–643
 - remove_copy(), 526
 - remove_copy_if(), 526
 - remove_if(), 526
 - replace(), 526, 641
 - replace_copy(), 526
 - replace_copy_if(), 526
 - replace_if(), 526
 - reverse(), 526, 644
 - reverse_copy(), 526
 - sample(), 526, 643–644
 - shuffle(), 526, 644
 - transform(), 526, 637–638
 - unique(), 526, 643
 - unique_copy(), 526
- move semantics, 612
- non-modifying, 523–524
- numerical processing, 655
 - accumulate(), 531
 - adjacent_difference(), 531
 - exclusive_scan(), 531
 - gcd(), 530, 656
 - inclusive_scan(), 531
 - inner-product(), 656
 - inner_product(), 531
 - iota(), 530, 656
 - lcm(), 531, 656
 - partial_sum(), 531
 - reduce(), 531, 656
 - transform_exclusive_scan(), 531
 - transform_inclusive_scan(), 531
 - transform_reduce(), 531, 657
- operational
 - for_each(), 527, 644–646
 - for_each_n(), 527, 646
- parallel, 655
- partition, 647–648
 - is_partitioned(), 527
 - partition(), 527
 - partition_copy(), 528
 - partition_point(), 528
 - stable_partition(), 528

- permutation
 - is-permutation(), 532
 - next-permutation(), 532
 - prev-permutation(), 532
- resources, 1068
- scan algorithms, 657
- search, 524
 - adjacent_find(), 524
 - find(), 524
 - find_end(), 524
 - find_first_if(), 524
 - find_if(), 524
 - find_if_not(), 524
 - search(), 524
 - search_n(), 524
- sequence algorithms
 - modifying, 636–644
 - non-modifying, 631–636
- set, 650–653
 - includes(), 529
 - inplace_merge(), 529
 - merge(), 529
 - set_difference(), 529
 - set_intersection(), 529
 - set_symmetric_difference(), 529
 - set_union(), 529
- sorting, 649
 - is_sorted(), 528
 - is_sorted_until(), 528
 - nth-element(), 528
 - partial_sort(), 528
 - partial_sort_copy(), 528
 - sort(), 528
 - stable_sort(), 528
- Standard Library, 507, 521
- swap and exchange
 - exchange(), 527, 647
 - iter_swap(), 527
 - swap(), 527, 646
 - swap_ranges(), 527
- writing, 735–737
- aliases, 334
 - alias templates, 399
 - namespaces, 10
- aliasing, 183, 189
- allocate() method, 728–729
- allocating arrays, dynamically, 31–32
- allocating memory, 166–168
- Allocator type, 728–729
- allocators, header files, 1078–1079
- all_of() algorithm, 525, 636
- anonymous namespaces, 349
- <any> header, 713–714
- any_of() algorithm, 525, 636
- APIs (application programming interface), 140
- architecture, crossplatform development and
 - address sizes, 1020
 - binary compatibility, 1019–1020
 - byte order, 1020–1021
 - integer size, 1018–1019
- arguments
 - default, 257–258
 - types, operator overload, 476
- arithmetic function objects, 621
- arithmetic operators
 - durations and, 695
 - overloading, 269–270
 - decrement, 483–484
 - increment, 483–484
 - unary minus, 483
 - unary plus, 483
- array container, 516, 520, 568–569
- arrays
 - allocating, dynamically, 31–32
 - associative arrays, 518
 - basic types, 168–170
 - constant expressions and, 23
 - declaring, heap, 169
 - deleting, 171
 - dynamic, 169
 - initializing, 23
 - multi-dimensional
 - heap, 173–175
 - stack, 172–173

- of objects, 170
- one-dimensional, 24
- as pointers, 177–178
- std::array container, 25
- std::vector container, 25–26
- ASCII (American Standard Code for Information Interchange), 663–664
- assertions, debugging and, 945–946
- assign() method, 545
- assignment operators, 236–242
 - copy, 228
 - declaring, 225–226
 - defaulted, explicit, 227
 - defining, 226–227
 - deleted, explicit, 227
 - move, 243, 245–246
 - swap() function, 247–248
 - objects, as return values, 228–229
- associative arrays, 518
- at() function, 376
- atan2() function, 511
- <atomic> header, 827
 - atomic operations, 830–831
 - atomic types, 827–830
- attributes
 - [[deprecated]], 364
 - [[fallthrough]], 364
 - [[maybe_unused]], 365
 - [[nodiscard]], 364–365
 - [[noreturn]], 363
 - vendor-specific, 365
- auto keyword, 40, 613
- automatic variables, 164
- auto_ptr, 192

B

- bad() method, 414–415
- base() method, 731
- base classes, 130, 278, 302–304
 - ambiguous, 311–312
 - virtual, 312, 331–332
- begin() function, 523
- behaviors, 126

- Bessel functions, 511
- beta functions, 511
- bidirectional streams, 431–432
- big-endian ordering of bytes, 1021
- binary logical operators, overloading, 484–485
- binary operators, 13
- binary_search() algorithm, 649
- bind() negator adaptor, 624–626
- binding
 - dynamic, 287
 - early, 287
 - late, 287
 - method hiding and, 287
 - static, 287
- bitset container, 519, 521, 600–601
- bitwise copying, 236
- bitwise function objects, 624
- bitwise operators, overloading, 484–485
- black-box testing, 909
- Boehm, Barry W., 863
- boolalpha input manipulator, 423
- boolalpha output manipulator, 415
- boyer_moore_horspool_searcher algorithm, 633
- boyer_moore_searcher algorithm, 633
- bridge pattern, 272
- buffered streams, 410, 413
- bugs. *See also* debugging
 - avoiding bugs, 934–935
 - Bugzilla, 912
 - life cycle, 910–911
 - root causes, 934
 - tracking, 912–913
- byte order, 1020–1021

C

- C++ resources, 1063–1064
- C++11, resources, 1067
- C++14, resources, 1067
- C++17, resources, 1067
- cache lines, 818
- callbacks, 607, 610

- calling member functions, 628–629
- casting, 299–300
 - casting variables, 12
 - pointers and, 176
- casts
 - const_cast(), 357–358, 361
 - dynamic_cast(), 360–361
 - reinterpret_cast(), 359–361
 - static_cast(), 358–359, 361
- catch exceptions, object handling and, 886
- catching exceptions, 437–439, 976
 - in class hierarchy, 448–449
 - const reference, 440–441
 - multiple, 441–443
- cbegin() function, 523
- ceil() function, 511, 695
- end() function, 523
- cerr stream, 410
- chain of responsibility pattern, 1010–1014
- chaining constructors, 295
- character classification, localization and, 669–670
- character sets, 664
 - non-Western, 665
- character types, 665
- Chrono library
 - clocks, 698–700
 - durations, 694–698
 - time points, 700–702
- cin stream, 410
- class constants, 260–261
- class templates, 514
 - < > (angle brackets), 383
 - alias templates, 399
 - compiler and, 383–384
 - instantiation, 384
 - types and, 384
 - definitions
 - in header files, 384–385
 - in source files, 385–386
 - driving from, 397–398
 - inheritance, 397–398
 - instantiation, 378, 382
 - parameters, 386
 - deduction for constructors, 389–391
 - default values, 389
 - non-type parameters, 387–388
 - writing
 - coding without templates, 375–378
 - Grid class, 378–381
 - Grid template, 382–383
- classes, 124–125
 - abstract, 303
 - access specifiers, 201–202
 - base, 278, 302–304
 - ambiguous, 311–312
 - virtual, 312
 - constructors, 201
 - data members, 200, 201
 - declarations, ordering, 203
 - defining
 - constructor initializer, 41–42
 - constructors, 41–42
 - data members, 40
 - destructors, 41–42
 - methods, 40
 - definitions, 200–201
 - Derived, 279–281
 - derived, 304–305
 - functionality, 292–294
 - parent constructors, 294–296
 - parent destructors, 296–297
 - deriving from existing, 974
 - destructors, 201
 - exceptions, writing, 449–452
 - friends, 232–233
 - Grid, 378–383
 - hash tables, 132
 - hierarchies, catching exceptions, 448–449
 - high_resolution_clock, 698–699
 - Impl, 273
 - implement class, 272–275
 - instances, 125, 201
 - interface class, 272–275
 - interviews, 1046–1050
 - istream_iterator, 730
 - Logger, 938
 - member functions, 201

- member variables, 201
- members, 201, 203
- methods, 201
- mixin, 138
- nested, 263–264
- opaque, 146
- ostream_iterator, 729
- pair, 576–577
- parent, 278
- reference_wrapper, 537
- rule of zero, 250
- statements, 201
- std::ostream, 425
- string, 509
- string_view, 509
- superclasses, 278
- system_clock, 698
- template classes, 977–979
- time_point, 698, 700–702
- types, enumerated, 264–265
- using, 43
- writing, 972–974
- cleanup() function, 248
- clocks, 698–700
 - high_resolution_clock class, 698–699
 - system_clock class, 698
 - time_point class, 698, 700–702
- clog stream, 410
- clone() method, 375
- code
 - compiled, 5
 - decomposition, 81–83
 - reuse
 - advantages, 105
 - APIs, 104
 - big-O notation, 108–109
 - capabilities, 107–108
 - design, 146–148
 - design-by-contract, 150
 - disadvantages, 105–106
 - error checking, 150
 - extensibility and, 151–153
 - frameworks, 104
 - libraries, 104
 - licensing and, 110–111
 - open-source libraries, 112–114
 - performance and, 109–110
 - platforms and, 110
 - versus polymorphism, 131–132
 - postconditions, 150
 - preconditions, 150
 - prototypes, 111–112
 - resources, 111
 - safe code, 150–151
 - SRP (Single Responsibility Principle), 146–147
 - stand-alone classes, 104
 - stand-alone functions, 104
 - Standard Library, 114
 - support and, 110–111
 - templates, 148–150
 - third-party apps, 112
 - types of code, 104
 - writing reusable, 102–103
 - code points, character sets, 665
 - coding style, 71. *See also* design
 - challenges, 90–91
 - constants, 87
 - documentation, comments, 72–81
 - exceptions, custom, 88
 - formatting
 - curly braces { }, 88–89
 - parentheses, 89–90
 - spaces, 89–90
 - tabs, 90
 - interviews, 1041–1042
 - planning, 72
 - references, 87
- collections, 126
- collisions, 591
- comments, 3–4
 - ad hoc, 80–81
 - complicated code and, 74–75
 - every line, 77–78
 - fixed-format, 79–80
 - meta-information and, 75–76
 - prefixes, 78
 - self-documenting code, 81

- usage explanation, 72–74
 - comparison algorithms, 524–525, 634–635
 - comparison function objects, 622–623
 - comparison operators, overloading, 270–271
 - compiled code, 5
 - compiler-generated constructors, 222–223
 - component interface, 140
 - components, 125
 - computer architecture, resources, 1071
 - concatenation, tuples, 718
 - condition variables, 840–842
 - conditional statements
 - if/else, 17–18
 - operator, 20
 - switch, 18–19
 - <condition_variable> header, 840
 - console, streams and, 410
 - const keyword
 - constants, 35
 - methods, 345
 - parameter protection, 35
 - parameters, 343
 - pointers, 343–345
 - references, 37, 345
 - variables, 343
 - const methods, 251–252
 - const reference data members, 262–263
 - const static data members, 260–261
 - const value, 334–335
 - constant iterators, 631
 - constants
 - class constants, 260–261
 - null pointer, 32–33
 - const_cast(), 357–358, 361, 376
 - constexpr keyword
 - constant expression, 346
 - literal type, 346
 - constructors, 209
 - chaining, 295
 - compiler-generated, 222–223, 228
 - converting constructors, 307
 - copy, 218–219
 - default, 212–215
 - compiler-generated, 213–214
 - explicitly defaulted, 214
 - explicitly deleted, 215
 - need, 212
 - writing, 212–213
 - delegating, 211, 222, 238–239
 - derived classes, 294–296
 - error handling, 462–464
 - function-try-blocks, 464–467
 - on the heap, 210
 - inherited, 316–319
 - initializer-list constructors, 220–222
 - initializers, 215–218
 - move, 245–248
 - multiple, 211
 - overloading, 211
 - parent, 294–296
 - on the stack, 210
 - typed constructors, 307
 - writing, 209–210
- container adapters
 - priority_queue, 572–575
 - queue, 570–572
 - stack, 575–576
 - containers
 - Allocator type, 728–729
 - allocators, 760
 - associative, 536, 760–773
 - bitset, 519, 600–604
 - container adapters, 536
 - error checking, 539
 - hash functions, 738–740
 - hash map interface
 - assignment operators, 745–746
 - deleting elements, 744
 - hash template parameter, 741
 - implementation, 741–742
 - inserting elements, 744
 - KeyEqual template parameter, 741
 - removing elements, 745
 - searching elements, 742–744
 - swapping elements, 745
 - type aliases, 741

- hash maps
 - buckets, 738
 - hash functions, 738–740, 746–747
 - methods, 748–750
 - type aliases, 747–748
- hash tables, 536, 591–598
- header files, 1077–1078
- interfaces, 514
- iterators, 539–541, 750–751
 - access methods, 758–759
 - const_hash_map_iterator class, 751–752
 - const_hash_map_iterator method implementations, 752–756
 - hash_map_iterator method implementations, 756–757
 - type aliases, 758–759
 - using, 759–760
- ordered associative, 576
- reversible, 760
- sequential, 536, 737, 773
 - array, 568–569
 - deque, 562
 - forwards_list, 566–568
 - list, 562–566
- standard C-style arrays, 598–599
- Standard Library, 507, 514
 - array, 516, 520
 - bitset, 521
 - deque, 516, 520
 - forward_list, 515, 520
 - list, 515, 520
 - map, 518
 - map multimap, 521
 - multimap, 518
 - multiset, 517–518
 - priority_queue, 516–517, 520
 - queue, 516, 520
 - set, 517–518
 - set multiset, 521
 - stack, 517, 521
 - unordered_map, 521
 - unordered_multimap, 521
 - unordered_multiset, 521
 - unordered_set, 521
 - vector, 342, 514–515, 519
 - strings, 599–600
 - unordered associative containers, 518–519, 536, 591–598
 - writing, 737–773
- conversions
 - implicit, 267
 - localization, 667–668
- converting constructors, 307
- cooked mode literal operators, 366
- copy() algorithm, 525
- copy() method, 732
- copy assignment operator, compiler generated, 228
- copy constructors, 218–219, 236–242
- copy list initialization, 45
- copy-and-swap idiom, 975–976
- copy_backward() algorithm, 525
- copy_if() algorithm, 525
- copy_n() algorithm, 525
- core dumps, 946–947
- count() algorithm, 525, 636
- count_if() algorithm, 525
- counting algorithms, 525, 636
- cout stream, 410
 - standard output, 412
- crash dumps, 946–947
- crbegin() function, 523
- createDocArray() function, 169
- cref() function, 537
- crend() function, 523
- cross-language development
 - C and C++, 1024
 - C code, 1028–1030
 - C++ code
 - calling assembly code from, 1036–1037
 - calling from C#, 1030–1031
 - calling from Java with JNI, 1031–1033
 - calling from scripts, 1034–1036
 - calling scripts from, 1033–1034
 - facade, 1024
 - object-oriented wrapper, 1024–1025
- cross-platform development
 - architecture and address sizes, 1020

- binary compatibility, 1019–1020
- byte order, 1020–1021
- integer size, 1018–1019
- cross-compiling, 1020
- implementation
 - compilers and, 1021–1022
 - library implementations, 1022
- platform-specific features, 1022–1023
- <stdint> header, 514
- C-style arrays, 598–599
- cylindricalNeumann functions, 511

D

- dangling pointers, 197, 238
- data members, 200
 - moving, 247
 - mutable, 253
 - pointers, type aliases, 355–356
 - references, 261–263, 336
 - static, 258
 - accessing, 259–260
 - inline variables, 259
- data races, 815–817
- data structures, resources, 1068
- deadlocks, multithreaded programming and, 817–818
- deallocate() method, 728
- deallocating memory, 166–168
- debugging
 - article citations example, 957–969
 - assertions, 945–948
 - avoiding bugs, 934–935
 - catastrophic bugs, 934
 - cosmetic bugs, 934
 - crash dumps, 946–947
 - debug traces
 - debug mode, 937–941
 - ring buffers, 942–945
 - error logging and, 935–937
 - interviews, 1060
 - memory problems, 951, 954–956
 - memory-access errors, 953–954
 - memory-freeing errors, 952–953
 - multithreaded programs, 956–957
 - noncatastrophic bugs, 934
 - regressions, 951
 - reproducing bugs, 948–949
 - debugging nonreproducible, 950–951
 - debugging reproducible, 949
 - resources, 1072
 - root causes of bugs, 934
 - tests, 927
- dec input manipulator, 423
- dec output manipulator, 415
- declaring functions, 5, 21–22
- decltype keyword, 40
- decomposing code, 21
- decomposition, 81–82
 - modular, 83
 - refactoring
 - abstraction, 82
 - breaking code apart, 82
 - locations, 82
 - names, 82
- decorator pattern, 1008–1010
- default arguments, 257–258
- default keyword, 214–215
- default_searcher algorithm, 633
- #define directive, 6
- delegating constructors, 211, 222, 238–239
- delete[], 169
- delete() operator, 32
- delete keyword, deallocating memory, 166–167
- delete operator, 500–506
 - [[deprecated]] attribute, 364
- deque container, 516, 520, 562
- dereferencing operators, overloading, 492–494
 - operator->*, 495–496
 - operator *, 494
 - operator ->, 494
- dereferencing pointers, 30, 175–176
- Derived class, 279–281
- derived classes, 304–305
 - constructors, parent, 294–296

- destructors, parent, 296–297
- functionality, 292–294
- Derived constructor, 294–296
- design. *See also* reusable code
 - abstraction and
 - benefits, 100
 - incorporating, 101
 - C++, 99–100
 - chess program, 114–115
 - algorithms, 118–120
 - class hierarchies, 118
 - classes, 118–120
 - data structures, 118–120
 - error handling, 120–121
 - patterns, 118–120
 - subsystems, 115–117
 - threading models, 117
 - frameworks and, interviews, 1060
 - functional requirements and, 96
 - importance of, 97–99
 - multithreaded programming, 853–855
 - non-functional requirements and, 96
 - object-oriented design, interviews, 1044–1045
 - patterns, 99, 103, 991
 - adaptor pattern, 1006–1008
 - chain of responsibility, 1010–1014
 - decorator pattern, 1008–1010
 - dependency injection, 993
 - factory patterns, 997–1004
 - interviews, 1060–1061
 - iterator pattern, 992–993
 - observer pattern, 1014–1016
 - proxy pattern, 1004–1006
 - resources, 1072
 - singleton, 993–997
 - program design, interviews, 1042–1044
 - software design, 96
 - stakeholders and, 96
 - Standard Library and, 114
 - techniques, 103, 971–972
- design-level efficiency, 889
 - caching, 889–890
 - object pools, 890–891, 893–894
 - implementation, 891–892
- destruction, variables, non-local, 351
- destructors, 224–225, 235–236
 - derived classes, 296–297
 - error handling and, 467
 - parent, 296–297
 - virtual keyword, 288–290
- DIP (Dependency Inversion Principle), 159
- direct list initialization, 45
- directives
 - #endif, 367–368
 - #ifndef, 367–368
 - #include, 368
 - #pragma once, 368
 - preprocessor, 6
- directories, iteration, 722–723
- DLLs (Dynamic Link Library), 354–355
- documentation
 - comments
 - ad hoc, 80–81
 - complicated code and, 74–75
 - every line, 77–78
 - fixed-format, 79–80
 - meta-information, 75–76
 - prefixes, 78
 - self-documenting code, 81
 - usage explanation, 72–74
 - man pages, 156
 - doSomething() function, 453
 - double dispatch, 981–985
 - double-ended queue, 516
 - doubleInts(), 178
 - doubly linked lists, 515
 - do/while loop, 27
 - downcasting, 300
 - doWorkInThread() function, 825
 - DumpRange() function, 652
 - durations, 694–698
 - dynamic arrays, 169
 - dynamic binding, 287
 - dynamic casts, pointers and, 176
 - dynamic memory, 164–165
 - allocation, 233–235
 - dynamic strings, 58
 - C-style
 - copyString() function, 58

- sizeof() operator, 59
- strlen() function, 58–59
- nonstandard strings, 69
- std::string class, 62–67
- std::string_view class, 67–69
- string literals
 - assigning, 60
 - literal pooling, 60
 - raw string literals, 60–62
- dynamically allocating arrays, 31–32
- dynamic_cast(), 360–361, 453

E

- earlybinding, 287
- efficiency
 - design-level, 882, 889
 - caching, 889–890
 - object pools, 890–894
 - interviews, 1058–1059
 - language, 882–883
 - language-level, 882, 883–884
 - inline functions, 888–889
 - inline methods, 888–889
 - memory allocation, 888
 - object handling, 884–888
 - profiling and, 894
 - example, Visual C++ 2017, 902–906
 - gprof and, 895–902
 - resources, 1071
- elements, value semantics, 537–538
- elliptic integrals, 511
- emplace() method, 580
- emplace operations, containers, 554
- employee records program, 46
 - Database class
 - Database.cpp file, 51–52
 - Database.h file, 50–51
 - DatabaseTest.cpp file, 52–53
 - Employee class
 - Employee.cpp file, 48–49
 - Employee.h file, 47–48
 - EmployeeTest.cpp file, 50
 - user interface, 53–55
- enable_shared_from_this, 191
- encodings, UCS, 665
- end() function, 523
- #endif directive, 6, 367–368
- enumerated types, 15–16, 264–265
 - strongly typed enumerations, 16
 - structs, 16–17
- eof() method, 414–415
- equal() algorithm, 525, 634–635
- equal_range() algorithm, 649
- erf() function, 511
- error checking, containers, 539
- error handling, 433
 - constructors, 462–464
 - destructors, 467
 - exceptions, 434–435
 - input streams, 418–419
 - interviews, 1053–1054
 - memory allocation errors, 459–461
 - output streams, 414–415
- error logging, debugging and, 935–937
- exception handling, futures, 846–847
- exceptions, 433
 - catching, 437–439, 976
 - in class hierarchy, 448–449
 - const reference, 440–441
 - multiple, 441–443
 - classes, writing, 449–452
 - cleanup and, 458
 - copying, 824–826
 - custom, 88
 - exception specification, 446
 - header files, 1081
 - nested, 452–454
 - noexcept keyword, 445–446
 - rethrowing, 454–456, 458, 824–826
 - standard, 446
 - hierarchy, 446–448
 - throw list, 446
 - throwing, 437–439
 - multiple, 441–443
 - throwing exceptions, 976
 - types, 439–440
 - uncaught, 444–445

- exchange() algorithm, 647
- exclusive_scan() algorithm, 657
- exceptions, 37–38, 434–435
 - Standard Library, 510
- execution policy, parallel algorithms, 655
- exp() function, 511
- explicit keyword, 391
- expressions, folding expressions, 796–797
- extern keyword, 349–350
- extraction operators, overloading, 485–486

F

- factory patterns, 997–999, 1002–1003
 - implementing, 999–1001
 - other uses, 1003–1004
- fail() method, 414–415
- [[fallthrough]] attribute, 364
- false-sharing, multithreaded programming and, 818
- fgets() function, 411
- file streams, 426–427
 - binary mode, 427–428
 - fgets() function and, 411
 - <fstream> header file, 426–427
 - fprintf() function and, 411
 - fputs() function and, 411
 - fread() function and, 411
 - fscanf() function and, 411
 - fwrite() function and, 411
 - ios_base::app constant, 427
 - ios_base::ate constant, 427
 - ios_base::binary constant, 427
 - ios_base::in constant, 427
 - ios_base::out constant, 427
 - ios_base::trunc constant, 427
 - text mode, 427–428
- files
 - header files, 5
 - reading from, 976–977
 - source files, 5
- <fstream> header file, 426–427
- filesystem support library, 513
 - directory entry, 721
 - directory iteration, 722–723
 - helper functions, 721–722
 - path, 720–721
- fill() algorithm, 526
- fill_n() algorithm, 526
- find() algorithm, 524, 608–611
- find_end() algorithm, 524
- find_first_if() algorithm, 524
- find_if() algorithm, 524, 608–611
- find_if_not() algorithm, 524
- findMatches() function, 355
- floor() function, 511, 695
- flush() method, 410, 413
- flush-on-access, streams, 430–431
- fma() function, 511
- folding expressions, 796–797
- for loop, 27
- for_each() algorithm, 646
- for_each_n() algorithm, 646
- forward declarations, 261, 368–369
- forward_list container, 515, 520
- forwards_list container, 566–568
- fprintf() function, 411
- fputs() function, 411
- frameworks, object-oriented
 - MFC (Microsoft Framework Classes), 988
 - MVC (Model-View-Controller), 989–990
- fread() function, 411
- freeing memory, 235–236
- friends, 232–233
- fscanf() function, 411
- full class template specialization, 782–785
- function call operator, overloading, 491–492
- function objects, 513, 607
 - arithmetic, 621
 - bitwise, 624
 - comparison, 622–623
 - invokers, 629
 - logical, 623–624
 - threads and, 820–822
 - transparent, 622
 - writing, 629–630
- function pointers
 - threads and, 819–820

- type aliases, 353–355
- function templates, 400–401
 - class templates and, 403–404
 - overloading, 402–403
 - specialization and, 403
 - return types, 405–406
 - specialization, 401–402
- functional composition, adaptor function
 - objects and, 624
- functional relationships, 135
- functionality, 130–131
- functions, 21, 374
 - abs(), 511
 - at(), 376
 - atan2(), 511
 - begin(), 523
 - cbegin(), 523
 - ceil(), 511
 - cend(), 523
 - cleanup(), 248
 - crbegin(), 523
 - createDocArray(), 169
 - crend(), 523
 - current function name, 23
 - declarations, 5, 21–22
 - definitions, 5
 - [[deprecated]] attribute, 364
 - doSomething(), 453
 - doWorkInThread(), 825
 - DumpRange(), 652
 - end(), 523
 - erf(), 511
 - exp(), 511
 - fgets(), 411
 - findMatches(), 355
 - floor(), 511
 - fma(), 511
 - fprintf(), 411
 - fputs(), 411
 - fread(), 411
 - friends, 232
 - fscanf(), 411
 - fwrite(), 411
 - getValue(), 201
 - handleMessage(), 244
 - handleValue(), 793
 - hash functions, 591–593
 - increment(), 828–829
 - intEqual(), 355
 - log(), 511, 939
 - main(), 6–7
 - make_pair(), 389–390
 - malloc(), 167
 - [[maybe_unused]] attribute, 365
 - member functions, calling, 628–629
 - mem_fn(), 628–629
 - new handler callback, 460–461
 - [[nodiscard]] attribute, 364–365
 - [[noreturn]] attribute, 363–364
 - parameters, 374
 - polymorphic function wrapper, 612
 - pow(), 511
 - predicate function callbacks, 610
 - processValues(), 792–793
 - pthread_create(), 819
 - rand(), 512, 702
 - rbegin(), 523, 730
 - realloc(), 170
 - refcall(), 339
 - remainder(), 511
 - rend(), 523, 730
 - rethrow_nested(), 453
 - return type, deduction, 22–23
 - set_terminate(), 445
 - setValue(), 201
 - sin(), 511
 - sinh(), 511
 - sprintf(), 411
 - sprintf_s(), 411
 - sqrt(), 511
 - srand(), 512, 702
 - sscanf(), 411
 - swap(), 247–248
 - terminate(), 444
 - tgamma(), 511
 - threadFunc(), 825
- function-try-blocks, 464–467
- functors, 607. *See* function objects

<future> folder, 513
futures, 843
 exception handling, 846–847
 promises, 843
 std::async, 845–846
 std::future, 843–844
 std::packaged_task, 844–845
 std::promise, 843–844
 std::shared_future, 847–848
 threads, 824
fwrite() function, 411

G

GameBoard class, error handling and, 468–472
generate() algorithm, 526
generate_n() algorithm, 526
generic programming, 374, 378
 templates and, 508
get_money input manipulator, 423
getStatus(), 85
getters, 139
get_time input manipulator, 423
getValue() function, 201
global scope, 362
good() method, 414–415
GPUs (graphics cards), 814
granularity of tests, 916
Grid class, 378, 380–381
 definition, 379–380
 methods, 380–381

H

handleMessage() function, 244
handles, 146
handleValue() function, 793
has-a relationships, 129, 132–135
hash functions, 591–593
hash tables, 518–519, 591–598
header files, 5, 1075–1077
 <algorithm>, 630–631
 algorithms, 1078–1079

 allocators, 1078–1079
 <any>, 713–714
 <array>, 516
 <atomic>, 827
 <chrono>, 512
 <condition_variable>, 840
 containers, 1077–1078
 <deque>, 516
 duplicate definitions, 367–368
 exceptions, 1081
 <fstream>, 426–427
 forward declarations, 368–369
 <forward_list>, 515
 <functional>, 621
 <future>, 513
 general utilities, 1079–1080
 initializer lists, 28
 <initializer_list>, 512
 I/O streams, 1081–1082
 <iostream>, 5, 412
 iterators, 1078–1079
 <list>, 515
 <locale>, 509
 <map>, 518
 mathematical utilities,
 1081
 <multimap>, 518
 <multiset>, 517–518
 <numeric>, 630
 <optional>, 711
 <ostream>, 412
 <priority_queue>, 516–517
 <queue>, 516
 <ratio>, 691–694
 <set>, 517–518
 <stack>, 517
 <stdint>, 514
 <string>, 509
 template definitions, 384–385
 <thread>, 513
 threading support library, 1082
 <tuple>, 512
 <type_traits>, 514
 <utility>, 512, 630

- <variant>, 712–713
 - <vector>, 514–515
 - heap
 - constructors on, 210
 - new keyword, 165
 - objects, 207
 - pointers, 30–31
 - Hello World, 3
 - helper functions, filesystem support library, 721–722
 - hex input manipulator, 423
 - hex output manipulator, 415
 - hierarchies, 136
 - catching exceptions, 448–449
 - standard exceptions, 446–448
 - high_resolution_clock class, 698–699
 - Hungarian Notation, 85
-
- ## I
- _i literal, 366
 - #ifdef directive, 6
 - if/else statements, 17–18
 - #ifndef directive, 6, 367–368
 - Impl class, 273
 - implementation class, 272–275
 - implicit conversions, 267
 - #include directive, 6, 368
 - inclusive_scan() algorithm, 657
 - increment() function, 828–829
 - inheritance
 - base classes, 130
 - virtual, 331–332
 - casts, 360–361
 - constructors, 316–319
 - derived classes
 - assignment operator, 327–329
 - copy constructors, 327–329
 - extending classes, 278–279
 - Derived class, 279–281
 - functionality, 130–131
 - multiple, 137–138, 308–309
 - base classes, ambiguous, 311–312
 - naming collisions, 309–310
 - uses, 312
 - non-public, 331
 - overridden methods
 - base class method, 324–327
 - base class method overloaded, 321–322
 - base class method private, 322–324
 - base class method protected, 322–324
 - base class method static, 320–321
 - method return type, 313–315
 - parameters, changing, 315–316
 - parent classes, 130
 - polymorphism and, 301–308
 - preventing, 281
 - properties, 131
 - reuse and, 291–300
 - RTTI (run-time type information), 329–330
 - specialization comparison, 399
 - superclasses, 130
 - templates, 397–398
 - inheritance techniques, interviews, 1050–1051
 - initialization
 - constructors, 215–218
 - RAII (Resource Acquisition is Initialization), 979–981
 - uniform, 43–45
 - copy list, 45
 - direct list, 45
 - variables, non-local, 351
 - initializer lists, 28
 - initializer-list constructors, 220–222
 - <initializer_list> header, 512
 - inline keyword, 256
 - inline methods, 255–257
 - efficiency and, 888–889
 - inline variables, static data member access, 259
 - in-memory stream, 425
 - input streams
 - >> operator, 417–418
 - error handling, 418–419
 - manipulators, 423
 - methods

- bad(), 418
- fail(), 418
- get(), 419
- getline(), 422
- good(), 418
- peek(), 421–422
- putback(), 421
- unget(), 420–421
- objects and, 423–425
- insert() method, 578–579, 732
- insertion operators, overloading, 485–486
- insert_or_assign() method, 579–580
- instances, 125, 201
- int* type declaration, 352–353
- integration, 929
 - JSON-based file serializer, 928
 - shared resources, readers/writers, 928
 - wrapper, third-party library, 928–929
- intEqual() function, 355
- interface class, 272–275
- interfaces
 - abstraction and, 138–139
 - APIs (application programming interface), 140
 - audience and, 139
 - component interface, 140
 - containers, 514
 - libraries, 140
 - planning, 141
 - purpose, 139
 - reusable, 153
 - comments, 156
 - customizability, 157
 - documentation, 156
 - ease of use and generality, 157–158
 - familiarity, 153–154
 - general-purpose, 157
 - ISP (Interface Segregation Principle), 158
 - multiple, 158
 - operator overloading, 154
 - required functionality, 155
 - uncluttered, 155–156
 - subsystems, 140
 - utility classes, 140
- interviews
 - applications, 1061
 - classes, 1046–1050
 - coding style, 1041–1042
 - debugging, 1060
 - design
 - frameworks and, 1060
 - object-oriented design, 1044–1045
 - patterns, 1060–1061
 - program design, 1042–1044
 - reuse and, 1045
 - efficiency, 1058–1059
 - error handling, 1053–1054
 - inheritance techniques, 1050–1051
 - I/O, 1053
 - library utilities, 1056
 - memory management, 1045–1046
 - multithreaded programming, 1057
 - objects, 1046–1050
 - obscure questions, 1051–1052
 - operator overload, 1054–1055
 - regular expressions, 1040–1041
 - software engineering methods, 1057–1058
 - Standard Library, 1039–1040, 1055–1056
 - strings, 1040–1041
 - localization, 1040–1041
 - views, 1040–1041
 - templates, 1052–1053
 - testing abilities, 1059
- IntPtr, 352–353
- ints array, 340–341
- invoke() adaptor, 629
- I/O
 - bidirectional, 431–432
 - interviews, 1053
- I/O streams, 7
 - header files, 1081–1082
 - Standard Library, 510
- I/O streams and strings, resources, 1065–1066
- ios_base::app constant, 427
- ios_base::ate constant, file streams, 427
- ios_base::binary constant, file streams, 427
- ios_base::in constant, file streams, 427

ios_base::out constant, file streams, 427
 ios_base::trunc constant, file streams, 427
 <iostream> header file, 5, 412
 is-a relationships, 130–135
 ISP (Interface Segregation Principle), 158, 159
 istream_iterator class, 730
 iteration, directories, 722–723
 iterative processes, 863
 iterator adaptors
 insert iterators, 731–733
 move iterators, 733–734
 reverse iterators, 730–731
 iterator design pattern, 992–993
 iterators, 521–522, 608, 737
 BidirectionalIterator, 631
 constant iterators, 631
 containers, 539–541
 ForwardIterator, 631
 header files, 1078–1079
 InputIterator, 631
 mutable, 631
 OutputIterator, 631
 RandomAccessIterator, 631
 streams
 istream_iterator class, 730
 ostream_iterator class, 729

K

keywords
 auto, 40, 613
 const, 35
 methods, 345
 parameters, 343
 pointers, 343–345
 references, 345
 variables, 343
 constexpr, 346
 decltype, 40
 default, 214–215
 explicit, 391
 extern, 349–350
 inline, 256
 new, 165

noexcept, 445–446
 override, 284–285
 static
 data members, 347
 linkage, 347–349
 methods, 347
 throw, 454–456
 try, 464–467
 virtual, 281–282, 287–290

L

lambda expressions
 capture expressions, 618
 generic expressions, 617–618
 as parameters, 619
 as return types, 618–619
 Standard Library algorithms
 count_if(), 619–620
 generate(), 620
 syntax, 614–617
 threads and, 822
 language, efficiency and, 882–883
 language-level efficiency, 882, 883–884
 inline functions, 888–889
 inline methods, 888–889
 memory allocation, 888
 object handling
 catch exceptions, 886
 move semantics, 886
 pass-by-reference, 884–885
 return-by-reference, 886
 return-value optimization, 887–888
 temporary objects, 886–887
 late binding, 287
 Legendre polynomials, 511
 lexicographical_compare() algorithm, 525, 634–635
 libraries
 filesystem support
 directory entry, 721
 directory iteration, 722–723
 helper functions, 721–722
 path, 720–721

- interfaces, 140
 - open-source
 - BSD (Berkeley Software Distribution), 113
 - CC (Creative Commons) license, 113
 - CPOL (Code Project Open License), 113
 - GPL (GNU Public License), 113
 - locating, 113
 - use guidelines, 113–114
 - Ratio library, 691–694
 - library utilities, interviews, 1056
 - linked lists, 515
 - linking streams, 430–431
 - list container, 515, 520, 562–566
 - lists
 - doubly linked, 515
 - singly linked, 515
 - literal operators, 366–367
 - literal types, 346
 - literals, 10
 - `_i` literal, 366
 - `_s` literal, 366
 - string literals, localization and, 664
 - user-defined, 365–366
 - standard, 367
 - little-endian ordering of bytes, 1021
 - local storage, threads, 823
 - `<locale>` header, 509, 667–668
 - localization, 509, 663–664
 - ASCII characters and, 663–664
 - character classification, 669–670
 - character conversion and, 670
 - character sets, 664
 - matches, 674–676
 - non-Western, 665
 - conversions, 667–668
 - facet categories, 670–671
 - facets, 668
 - locales, 668–669
 - string literals, 664
 - wide characters, 664–665
 - `log()` function, 511, 939
 - Logger class, 938
 - logical evaluation operators
 - `!`, 21
 - `!=`, 20
 - `&&`, 21
 - `<=`, 20
 - `=`, 20
 - `>`, 20
 - `>=`, 20
 - `|`, 21
 - logical expressions, short-circuit logic, 21
 - logical function objects, 623–624
 - loops
 - for, 27
 - do/while, 27
 - while, 26–27
 - `lower_bound()` algorithm, 649
 - LSP (Liskov Substitution Principle), 134, 158
 - `lvalues`, 243–245
- ## M
- macros, preprocessor and, 371–372
 - `main()` function, 6–7
 - `make_pair()` function, 389–390
 - `malloc()` function, 167
 - man pages, 156
 - map container, 518
 - element look up, 581–582
 - element removal, 582
 - example, 583–585
 - inserting elements, 578–580
 - iterators, 580–581
 - nodes, 582–583
 - map multimap container, 521
 - MatchFunction, 355
 - mathematical utilities, Standard Library, 511
 - Bessel functions, 511
 - beta functions, 511
 - complex numbers, 511
 - cylindricalNeumann functions, 511
 - elliptic integrals, 511
 - Legendre polynomials, 511
 - numeric limits and, 511
 - ratio class, 511
 - ratio class template, 511
 - valarray class, 511

- max() algorithm, 653
- [[maybe_unused]] attribute, 365
- member functions
 - calling, 628–629
 - threads and, 823
- mem_fn() function, 628–629
- memory
 - allocating
 - failure, 167–168
 - new keyword, 166–167
 - deallocating, delete keyword, 166–167
 - destructors, 235–236
 - double deleting, 197
 - dynamic, 164–165
 - freeing, 235–236
 - garbage collection, 181–182
 - heap, 29
 - new keyword, 165
 - leaks, 194–197, 238
 - low-level operations, 179–182
 - malloc() function, 167
 - object pools, 182
 - orphaned, 238
 - out-of-bounds, accessing, 193
 - pointer arithmetic, 179–180
 - pointers, 30–31
 - dangling, 197
 - polymorphic memory wrappers, 728–729
 - stack, 29
 - stack frame, 29
 - strings, underallocating, 192–193
- memory allocation
 - errors, custom failure behavior, 460–461
 - operators, overloading
 - delete expression, 501
 - delete operator, 500–506
 - new expression, 501
 - new operator, 500–506
 - pre-allocating, 888
- memory dumps, 946–947
- memory management, 163–164
 - custom, 180–181
 - interviews, 1045–1046
- memory pool, 728
- merge() algorithm, 652
- meta-information, coding style and, 75–76
- metaprogramming templates, 797–798
 - loop unrolling, 799–800
 - tuples, printing, 800–801
 - compile-time integer sequence, 803
 - constexpr if statement, 802–803
 - type traits, 803–805
 - constexpr if statement, 810–811
 - enable_if, 808–810
 - logical operators, 811
 - type categories, 805–807
 - type relations, 807–808
- methodPtr variable, 355–356
- methods, 412–413
 - :: (scope resolution operator), 204
 - access, 204
 - allocate(), 728–729
 - assign(), 545
 - bad(), 414–415, 418
 - base(), 731
 - calling others, 204–206
 - clone(), 375
 - const, 251–252
 - const keyword, 345
 - constructors, 209
 - compiler-generated, 222–223
 - copy, 218–219
 - default, 212–215
 - delegating, 211, 222
 - on the heap, 210
 - initializer-list constructors, 220–222
 - initializers, 215–218
 - multiple, 211
 - overloading, 211
 - on the stack, 210
 - writing, 209–210
 - copy(), 732
 - deallocate(), 728
 - destructors, 224–225
 - emplace(), 580
 - eof(), 414–415
 - fail(), 414–415, 418
 - flush(), 410, 413

- good(), 414–415, 418
- hiding, 286–290
- inline, 255–257
- insert(), 578–579, 732
- insert_or_assign(), 579–580
- method templates, 391–393
 - non-type parameters, 393–395
- moveFrom(), 247
- mutable data members, 253
- operator[], 580
- overloading, 253–254
 - const and, 254–255
 - deleting explicitly, 255
- overriding, 281–282
 - override keyword, 284–285
 - preventing, 290
 - syntax, 282–283
- pointers, type aliases, 355–356
- pure virtual methods, 303
- put(), 413
- resize(), 777
- seek(), 428–430
- static, 251
- std::as_const(), 358
- str(), 425
- swap(), 546
- tell(), 428–430
- this pointer, 206–207
- tie(), 430–431
- write(), 413
- min() algorithm, 653
- minimum-maximum algorithms, 653–654
- mismatch() algorithm, 525, 634–635
- mixin classes, 138, 985, 988
 - designing, 986–987
 - implementing, 987
- modifying sequence algorithms, 525–526, 636–644
 - copy(), 638–639
 - move(), 640–641
 - remove(), 641–643
 - replace(), 641
 - reverse(), 644
 - sample(), 643–644
 - shuffle(), 644
 - transform(), 637–638
 - unique(), 643
- move() algorithm, 526
- move assignment operators, 243, 245–248, 481
- move constructor, 245–248
- move semantics, 190, 243, 612, 733
 - implementing, 245–246
 - object handling and, 886
- move_backward() algorithm, 526
- moveFrom() method, 247
- multicore processors, 814
- multi-dimensional arrays
 - heap, 173–175
 - stack, 172–173
- multimap container, 518
- multiple inheritance, 137–138, 308–309
- multiset container, 517–518
- multithreaded programming, 814
 - condition variables, 840–842
 - data races, 815–817
 - deadlocks, 817–818
 - debugging, 956–957
 - false-sharing, 818
 - <future> header, 513
 - futures, 843
 - exception handling, 846–847
 - promises, 843
 - std::async, 845–846
 - std::future, 843–844
 - std::packaged_task, 844–845
 - std::promise, 843–844
 - std::shared_future, 847–848
- interviews, 1057
- logger class example, 848–853
- mutual exclusion, mutex classes, 832–840
- race conditions, 815–817
- resources, 1073
- tearing, 817
- <thread> header, 513
- thread pools, 853
- threading design, 853–855
- mutable data members, 253

- mutable iterators, 631
- mutex classes, 831
 - double-checked locking, 839–840
 - locks
 - lock_guard, 833–834
 - multiple, 835
 - scoped_lock, 835–836
 - shared_lock, 835
 - unique_lock, 834
 - non-timed
 - exclusive ownership, 832
 - lock() method, 832
 - read locks, 832
 - readers-writers lock, 832
 - shared lock ownership, 832
 - shared ownership, 832
 - shared_mutex class, 832
 - try_lock() method, 832
 - unlock() method, 832
 - std::call_once, 836–837
 - thread writing, safe streams, 837–838
 - timed, 832–833
 - timed locks, 838–839
- mutual exclusion, mutex classes, 831
 - non-timed, 832
 - timed, 832–833

N

- namespaces, 8–10
 - aliases, 10
 - anonymous, 349
 - nested, 9–10
- naming
 - conventions
 - capitalization, 86
 - counters, 84
 - getStatus(), 86
 - getters, 86
 - Hungarian Notation, 85
 - namespaced constants, 86
 - prefixes, 84–85
 - setStatus(), 86
 - setters, 86
 - selecting, 83–84
 - negative tests, 923
 - nested classes, 263–264
 - nested exceptions, 452–454
 - nested namespaces, 9–10
 - new[], 169
 - new handler callback function, 460–461
 - new keyword, 165
 - allocating memory, 166–167
 - new operator, 500–506
 - noboolalpha input manipulator, 423
 - noboolalpha output manipulator, 415
 - node handles, 582–583
 - node-based data structures, 582–583
 - [[nodiscard]] attribute, 364–365
 - noexcept keyword, 445–446
 - none_of() algorithm, 525, 636
 - non-local variables
 - destruction, 351
 - initialization order, 351
 - non-modifying algorithms, 523–524
 - non-modifying sequence algorithms
 - comparison algorithms, 634–635
 - counting algorithms, 636
 - search algorithms, 631–633
 - specialized searchers, 633
 - non-timed mutex classes
 - exclusive ownership, 832
 - lock() method, 832
 - read locks, 832
 - readers-writers lock, 832
 - shared lock ownership, 832
 - shared ownership, 832
 - shared_mutex class, 832
 - try_lock() method, 832
 - unlock() method, 832
 - non-type parameters, templates, 387–388
 - method templates, 393–395
 - [[noreturn]] attribute, 363
 - noshowpoint output manipulator, 415
 - noskipws input manipulator, 423
 - not1() negator adaptor, 627
 - not2() negator adaptor, 627

not_fn() negator adaptor, 626–627
NRVO (named return value optimization), 888
null pointers, 30–33
<numeric> header, 630

O

object files, linking, 5
object handling
 catch exceptions, 886
 move semantics, 886
 return-by-reference, 886
 return-value optimization, 887–888
 temporary objects, 886–887
objects, 127, 374
 assignment operators
 declaring, 225–226
 defining, 226–227
 explicitly defaulted, 227
 explicitly deleted, 227
 block ends, 224
 casting, 299–300
 constructors, 209
 compiler-generated, 222–223
 copy, 218–219
 default, 212–215
 delegating, 211, 222
 on the heap, 210
 initializer-list constructors, 220–222
 initializers, 215–218
 multiple, 211
 overloading, 211
 on the stack, 210
 writing, 209–210
 creating, 208–209
 data members, moving, 247
 destructors, 224–225
 functors, 513, 607
 on the heap, 207–208
 input, 423–425
 interviews, 1046–1050
 out of scope, 224
 output, 423–425
 over-objectification, 127–128
 passing by reference, 220
 as return values, 228–229
 on the stack, 207
 obscure questions in interviews, 1051–1052
 observer pattern, 1014–1016
 OCP (Open/Closed Principle), 158
 oct input manipulator, 423
 oct output manipulator, 415
 one-dimensional arrays, 24
 OOP (object-oriented programming), 40, 124
 aggregation, 129
 behaviors, 126
 classes, 124–125
 base classes, 130
 instances, 125
 collections, 126
 components, 125
 deriving, 130
 extending, 130
 frameworks, 988–989
 general, 128
 hierarchies, 136
 inheritance, 130
 base classes, 130
 functionality, 130–131
 multiple, 137–138
 parent classes, 130
 properties, 131
 superclasses, 130
 instances, 125
 MVC (Model-View-Controller), 990
 objects, 127, 374
 general, 128
 over-objectification, 127–128
 polymorphism, 131–132
 properties, 125
 relationships
 functional, 135
 has-a, 129, 132–135
 is-a, 132–135
 is-a relationship, 130–132
 mixin classes, 138
 shares-with, 138

- SOLID principles, 158–159
- state, 127–128
- subclassing, 130
- opaque classes, 146
- open-source libraries
 - BSD (Berkeley Software Distribution), 113
 - CC (Creative Commons) license, 113
 - CPOL (Code Project Open License), 113
 - GPL (GNU Public License), 113
 - locating, 113
 - use guidelines, 113–114
- operating systems, resources, 1073
- operational algorithms, 646
- operator[] method, 580
- operator overload
 - add() method, 265
 - argument types, 476
 - arithmetic operators, 269–270
 - decrement, 483–484
 - increment, 483–484
 - unary minus, 483
 - unary plus, 483
 - behavior, 477
 - binary logical operators, 484–485
 - bitwise operators, 484–485
 - comparison, 270–271
 - conversions, implicit, 267
 - dereferencing operators, 492–494
 - operator->*, 495–496
 - operator *, 494
 - operator ->, 494
 - extraction operators, 485–486
 - function call operator, 491–492
 - global functions, 475–476
 - insertion operators, 485–486
 - interviews, 1054–1055
 - limitations, 474–475
 - memory allocation operators, 500–506
 - delete expression, 501
 - delete operator, 500–506
 - new expression, 501
 - new operator, 500–506
 - methods, 475–476
 - move assignment operators, 481
 - operator+, 266–269
 - operators not to overload, 477–478
 - overloadable operators, 478–481
 - reasons, 474
 - relational operators, 482
 - return types, 477
 - rvalue references, 481–482
 - Standard Library, 509
 - subscripting operator, 486–489
 - non-integral array indices, 490
 - operator[], 489–490
 - type building and, 271–272
- operators
 - arity, 475
 - assignment operators, 240–242
 - copy, 228
 - declaring, 225–226
 - defaulted, explicit, 227
 - defining, 226–227
 - deleted, explicit, 227
 - move, 243
 - associativity, 475
 - binary, 13
 - conditional statements, 20
 - conversion, 496–497
 - Boolean expressions, 498–500
 - explicit, 497
 - delete, 32, 500–506
 - literal, 366–367
 - logical evaluation
 - !, 21
 - !=, 20
 - &&, 21
 - <, 20
 - <=, 20
 - ==, 20
 - >, 20
 - >=, 20
 - |, 21
 - move assignment operators, 481
 - new, 31–32, 500–506
 - precedence, 475
 - relational, 482

- ternary, 13
- unary, 13
- <optional> header, 711
- ordered associative containers
 - map
 - constructing, 577–578
 - element look up, 581–582
 - element removal, 582
 - example, 583–585
 - inserting elements, 578–580
 - iterators, 580–581
 - nodes, 582–583
 - multimap, 585–588
 - multiset, 590
 - set, 589–590
- orphaned memory, 238
- orthogonality, 521
- <ostream> header file, 412
- ostream_iterator class, 729
- output streams, 411–412
 - cout, 412
 - error handling, 414–415
 - manipulators, 415–417
 - methods, 412–413
 - bad(), 414–415
 - eof(), 414–415
 - fail(), 414–415
 - flush(), 413
 - good(), 414–415
 - put(), 413
 - write(), 413
 - objects and, 423–425
 - raw output, 413
- overload resolution, 254
- overloading, 211
 - methods, 253–254
 - const and, 254–255
 - deleting explicitly, 255
- override keyword, 284–285
- overriding methods, 281–282
 - override keyword, 284–285
 - preventing, 290
 - syntax, 282–283

P

- pair class, 576–577
- parallel algorithms, 655
- parameter packs, 793
- parameterization, 374
 - deduction, 404–405
 - types, 374
 - values, 374
- parameters, 257, 374
 - const keyword, 343
 - const keyword and, 35
 - cooked-mode literal operators, 366
 - references, 336–337
 - pass-by-reference, 337–338
 - pass-by-value, 337–338
 - from pointers, 337
 - template template parameters, 778–780
- templates, 386
 - deduction for constructors, 389–391
 - default values, 389
 - non-type parameters, 387–388, 780–782
 - type parameters, 778–780
- parent classes, 130, 278
- partial class template specialization, 782–787
- partial specialization, templates, 397
- partition algorithms, 647–648
- partition_copy() algorithm, 648
- passing, by reference, 220
- pimpl idiom, 272
- platform, 1017
 - binary compatibility, 1019–1020
- pointer arithmetic, 179–180
- pointers, 30–31
 - aliasing, 183
 - arrays as, 177–178
 - casting with, 176
 - const keyword, 343–345
 - dangling, 197, 238
 - to data members, type aliases, 355–356
 - dereferencing, 30, 175–176
 - function pointers, type aliases, 353–355
 - to methods, type aliases, 355–356

- models, 175–176
- null, 30
 - constant, 32–33
- reference counting, 183
- to references, 336
- versus* references, 87, 339–343
- shared ownership, 183
- smart, 33–34
 - auto_ptr, 192
 - enable_shared_from_this, 191
 - move semantics, 190
 - referencing counting and, 188–189
 - shared_ptr, 186–188
 - unique_ptr, 183–186
 - weak_ptr, 189–190
- smart pointers, 182–183
- on the stack, 210
- to structures, 31
- this, 206–207
- polymorphic function wrapper, 612
- polymorphic memory wrappers, 728–729
- polymorphism, 131–132
 - inheritance and, 301–308
- pow() function, 511
- #pragma directive, 6
- #pragma once directive, 368
- predicate function callbacks, 610
- preprocessor, 5
 - directives, 6
 - macros, 371–372
- priority_queue container, 516–517, 520
 - function objects and, 622–623
- private implementation idiom, 272
- private nested classes, 264
- procedural approach, 124
- procedures, 374
- process, software engineering and, 860–861
- processors, multicore, 814
- processValues() function, 792–793
- profiling, 894
 - gprof and, 895–902
- programming, 374. *See also* design; OOP (object-oriented programming)
 - functions, 374
 - generic, 378
 - multithreaded, 814
 - objects, 374
 - parameters, 374
 - procedures, 374
 - style, resources, 1070–1071
 - templates, 374
 - properties, 125, 131
 - protected nested classes, 264
 - proxy patterns, 1004–1006
 - pseudo-random number engines
 - linear congruential, 704
 - Mersenne twister, 704
 - subtract with carry engine, 704
 - pthread_create() function, 819
 - ptrRef, 336
 - pure virtual methods, 303
 - push_back() call, 734
 - put() method, 413
 - put_money output manipulator, 415
 - put_time output manipulator, 415

Q

- QA (quality assurance), 909
- queue container, 516, 520
- quoted input manipulator, 423
- quoted output manipulator, 415

R

- race conditions, 815–817
- RAII (Resource Acquisition Is Initialization), 979–981
- rand() function, 512, 702
- random numbers
 - distributions
 - Bernoulli, 708
 - normal, 708–709
 - Poisson, 708

- sampling, 709
- uniform, 708
- engines, 702–704, 707–711
 - adapter pattern, 705
 - adaptors, 705–706
 - base engine, 705
 - linear_congruential_engine, 703
 - mersenne_twister_engine, 703
 - predefined, 705–706
 - random_device, 703
 - subtract_with_carry_engine, 703
- generate() algorithm, 707
- generating, 702–703, 706–707
- pseudo-random number engines
 - linear congruential, 704
 - Mersenne twister, 704
 - subtract with carry engine, 704
- resources, 1068
- Standard Library, 512
- random_shuffle() algorithm, 526
- range-based for loop, 27
- <ratio> header, 691–694
- Ratio library, 691–694
- raw mode literal operators, 366
- raw pointers, 33–34
- raw string literals, 60–62
- raw-mode literal operators, 367
- rbegin() function, 523, 730
- reading from files, 976–977
- realloc() function, 170
- recursive_directory_iterator, 722
- ref() function, 537
- refcall() function, 339
- reference data members, 261–262
 - const, 262–263
- reference variables, 334–335
- references, 35–36, 334
 - const keyword, 345, 440–441
 - data members, 336
 - lvalues, 243–245
 - modifying, 335
 - parameters, 336–337
 - pass-by-reference, 337–338
 - pass-by-value, 337–338
 - from pointers, 337
 - passing by, 36–37, 220
 - passing by const reference, 37
 - to pointers, 336
 - return values, 338
 - rvalues, 243–245, 338–339
 - versus pointers, 87, 339–343
- reference_wrapper class, 537
- regression testing, 930
- regular expressions
 - alternation, 673
 - anchors, 673
 - back references, 673, 677
 - capture groups, 673
 - character sets, 674–676
 - character classes, 675–676
 - range specification, 675
 - decision making and, 671
 - ECMAScript, 672
 - grammars, 672
 - grouping, 673
 - interviews, 1040–1041
 - iteration and, 671
 - lookahead, 677
 - matches, 672
 - parsing and, 671
 - patterns, 672
 - precedence, 674
 - raw string labels, 677–678
 - regex library, 678–679
 - regex_iterator() algorithm, 683–684
 - regex_match() algorithm, 679–682
 - regex_replace() algorithm, 687–690
 - regex_search() algorithm, 682–683
 - regex_token_iterator, 685–687
 - repetition, 673–674
 - replace, 672
 - replace operations, 673
 - searches, 672
 - Standard Library, 510
 - subexpressions, 673
 - tokenization and, 671
 - transformation and, 671
 - validation and, 671

- wildcards, 673
- word boundaries, 676–677
- reinterpret_cast(), 359–361
- relational operators, 482
- relationships
 - functional, 135
 - has-a, 129, 132–135
 - is-a, 130–135
 - mixin classes, 138
 - shares-with, 138
- remainder() function, 511
- remove() algorithm, 526
- remove_copy() algorithm, 526
- remove_copy_if() algorithm, 526
- remove-erase-idiom, 642
- remove_if() algorithm, 526
- rend() function, 523, 730
- replace() algorithm, 526
- replace_copy() algorithm, 526
- replace_copy_if() algorithm, 526
- replace_if() algorithm, 526
- resize() method, 777
- resources
 - algorithms, 1068
 - beginning C++, 1063–1064
 - C++11, 1067
 - C++14, 1067
 - C++17, 1067
 - computer architecture, 1071
 - data structures, 1068
 - debugging, 1072
 - design patterns, 1072
 - efficiency, 1071
 - general C++, 1064–1065
 - I/O streams and strings, 1065–1066
 - multithreaded programming, 1073
 - operating systems, 1073
 - programming style, 1070–1071
 - random numbers, 1068
 - software
 - engineering methodology, 1069–1070
 - open-source, 1068–1069
 - Standard Library, 1066
 - templates, 1067
 - testing, 1071
 - UML (Unified Modeling Language), 1067
- rethrowing exceptions, 454–456, 458
- rethrow_nested() function, 453
- return type functions, 22–23
 - function templates, 405–406
- return values
 - optimization, object handling and, 887–888
 - references, 338
- return-by-reference, object handling and, 886
- reusable code, 101–104
 - abstraction and, 145–146
 - advantages, 105
 - APIs, 104
 - big-O notation, 108–109
 - capabilities, 107–108
 - dependency injection, 103
 - design
 - aggregation, 148
 - class hierarchies, 147–148
 - high cohesion, 146–148
 - interface dependencies, 148
 - low coupling, 147
 - subsystems, 147
 - design reuse, 103
 - design-by-contract, 150
 - disadvantages, 105–106
 - error checking, 150
 - extensibility and, 151–153
 - frameworks, 104
 - inheritance and, WeatherPrediction class, 291–294
 - interfaces, 153
 - comments, 156
 - customizability, 157
 - documentation, 156
 - ease of use and generality, 157–158
 - familiarity, 153–154
 - general-purpose, 157
 - ISP (Interface Segregation Principle), 158
 - multiple, 158
 - operator overloading, 154
 - required functionality, 155
 - uncluttered, 155–156

- interviews, 1045
- libraries, 104
- licensing and, 110–111
- mottos, 144
- open-source libraries
 - BSD (Berkeley Software Distribution), 113
 - CC (Creative Commons) license, 113
 - CPOL (Code Project Open License), 113
 - GPL (GNU Public License), 113
 - locating, 113
 - open-source software, 112
 - use guidelines, 113–114
- optimal reuse design, 146–153
- performance and, 109–110
- platforms and, 110
- versus* polymorphism, 131–132
- postconditions, 150
- preconditions, 150
- prototypes, 111–112
- resources, 111
- safe code, 150–151
- SRP (Single Responsibility Principle), 146–147
- stand-alone classes, 104
- stand-alone functions, 104
- Standard Library, 114
- support and, 110–111
- templates, 148
 - benefits, 149
 - versus* inheritance, 150
 - problems, 149
 - std::vector class, 148
- third-party apps, 112
- types of code, 104
- writing reusable code, 102–103

reverse() algorithm, 526

reverse_copy() algorithm, 526

ring buffers, debugging and, 942–945

round() function, 695

rule of zero, 250

runtime_error, 441–443

rvalues, 243–245, 733

- operator overload and, 481
- references, 338–339

RVO (Return Value Optimization), 229, 888

S

_s literal, 366

sample() algorithm, 526

Sashimi Model life cycle model, 863

scan algorithms, 657

scope, 362

- global scope, 362
- resolution, 362

search() algorithm, 524

search algorithms, 524, 631–633

- binary search, 649–650

search_n() algorithm, 524

seek() method, 428–430

sequence algorithms

- modifying, 636–644
- non-modifying
 - comparison algorithms, 634–635
 - counting algorithms, 636
 - search algorithms, 631–633
 - specialized searchers, 633

sequential containers, 773

- array, 568–569
- deque, 562
- forwards_list, 566–568
- list, 562–566
- vector
 - algorithmic complexity, 554
 - assigning, 545–546
 - comparing, 546
 - constructors, 544–545
 - copying, 545–546
 - destructors, 544–545
 - dynamic-length, 544
 - elements, 550–553
 - fixed-length, 542–543
 - iterators, 547–550, 554
 - memory allocation scheme, 554–556
 - move semantics, 553–554
 - reference storage, 550
 - round-robin schedule example, 556–561
 - vectorbool specialization, 561

set algorithms, 650–653

set container, 517–518

set multiset container, 521

- set_difference() algorithm, 650
- setfill output manipulator, 415
- set_intersection() algorithm, 650
- set_new_handler(), 461
- setprecision output manipulator, 415
- setStatus(), 85
- set_symmetric_difference() algorithm, 650
- set_terminate() function, 445
- setters, 139
- set_union() algorithm, 650
- setValue() function, 201
- setw output manipulator, 415
- shallow copying, 236
- shared_ptr pointer, 186–188
- shares-with relationships, 138
- short circuit logic, 21
- showpoint output manipulator, 415
- shuffle() algorithm, 526
- sin() function, 511
- singleton design pattern, 993–997
- singly linked lists, 515
- sinh() function, 511
- skipws input manipulator, 423
- smart pointers, 33–34, 182–183
 - auto_ptr, 192
 - enable_shared_from_this, 191
 - move semantics, 190
 - reference counting and, 188–189
 - shared_ptr pointer, 186–188
 - stack unwinding, 457–458
 - Standard Library, 510
 - unique_ptr pointer, 182–186
 - weak_ptr, 189–190
- smoke testing, 930
- software
 - design, 96
 - open-source, resources, 1068–1069
- software engineering methods
 - custom, 877–878
 - interviews, 1057–1058
 - process and, 860–861
 - resources, 1069–1070
 - RUP (Rational Unified Process), 868–869
 - Scrum, 869
 - benefits, 871
 - Daily Scrum, 870
 - drawbacks, 872
 - effort estimation, 870
 - PO (Product Owner), 870
 - product backlog, 870
 - SM (Scrum Master), 870
 - sprint cycle, 870
 - Sprint Planning, 870
- triage, 876–877
- UP (Unified Process)
 - construction phase, 867
 - disciplines, 867
 - elaboration phase, 867
 - inception phase, 867
 - iterations, 867
 - transition phase, 867
- XP (Extreme Programming), 872–876
 - integration, 874
 - iteration planning, 873
 - metaphor, 874
 - pair programming, 872–873
 - refactoring, 874
 - release planning, 873
 - small releases, 874
 - testing, 873
- software life cycle
 - Agile Model, 866–867
 - Sashimi Model, 863
 - Spiral Model, 863
 - spiral-like models, 863–866
 - Waterfall Model, 861–863
- SOLID principles
 - DIP (Dependency Inversion Principle), 159
 - ISP (Interface Segregation Principle), 159
 - LSP (Liskov Substitution Principle), 158
 - OCP (Open/Closed Principle), 158
 - SRP (Single Responsibility Principle), 158
- sorting algorithms, 649
- Source Code Control software, 878–880
- source code servers, 946–947
- source files, 5
 - template definitions, 385–386
- specialization *versus* inheritance, 399
- specialized searchers, 633

- Spiral Model life cycle model, 863
- spiral-like models, life cycle, 863–866
- spreadsheet application, 200
- `sqrt()` function, 511
- `rand()` function, 512, 702
- SRP (Single Responsibility Principle), 146–147, 158
- stack, 29
 - constructors on, 210
 - objects, 207
- stack container, 517, 521
- stack frame, 29
- stack unwinding, 456–457
 - smart pointers, 457–458
- stakeholders, design and, 96
- Standard Library, 46, 114
 - algorithms, 507, 521
 - accumulate, 611–612
 - binary search, 529
 - comparison, 524–525
 - counting, 525
 - `find()`, 608–611
 - `find_all()`, 735–736
 - `find_if()`, 608–611
 - heap, 529–530
 - iterators, 521, 737
 - lambda expressions, 619–620
 - minimum-maximum, 530
 - modifying sequence, 525–526
 - move semantics, 612
 - non-modifying, 523–524
 - numerical processing, 530–531
 - operational, 527
 - partition, 527–528
 - permutation, 532
 - search, 524
 - set, 529
 - sorting, 528
 - swap and exchange, 527
 - writing, 735–737
 - any class, 513
 - C, 5
 - containers, 507, 514
 - adapters, 569–576
 - allocators, 760
 - array, 516, 520
 - associative, 536, 760–773
 - bitset, 519, 521, 600–604
 - container adapters, 536
 - deque, 516, 520
 - element requirements, 537–538
 - error checking, 539
 - `forward_list`, 515, 520
 - hash maps, 738–760
 - hash tables, 536, 591–598
 - iterators, 539–541
 - list, 515, 520
 - map, 518
 - map multimap, 521
 - multimap, 518
 - multiset, 517–518
 - ordered associative containers, 576–590
 - `priority_queue`, 516–517, 520
 - queue, 516, 520
 - reversible, 760
 - sequential, 536, 542–569, 737
 - set, 517–518
 - set multiset, 521
 - stack, 517, 521
 - standard C-style arrays, 598–599
 - strings, 599–600
 - unordered associative containers, 536, 591–598
 - `unordered_map`, 521
 - `unordered_multimap`, 521
 - `unordered_multiset`, 521
 - `unordered_set`, 521
 - vector, 514–515, 519
 - writing, 737–773
 - exceptions, 510
 - extending, 735
 - extensibility, 532
 - filesystem support library, 513
 - function objects, 513
 - hash tables, 518–519
 - header files, 1075–1077
 - algorithms, 1078–1079
 - allocators, 1078–1079

- containers, 1077–1078
- exceptions, 1081
- general utilities, 1079–1080
- I/O streams, 1081–1082
- iterators, 1078–1079
- mathematical utilities, 1081
- threading support library, 1082
- heterogeneous elements, 512
- homogeneous elements, 512
- initializer lists, 512
- integer types, standard, 514
- interviews, 1039–1040, 1055–1056
- I/O streams, 510
- mathematical utilities, 511
 - abs() function, 511
 - atan2() function, 511
 - Bessel functions, 511
 - beta functions, 511
 - ceil() function, 511
 - complex numbers, 511
 - cylindricalNeumann functions, 511
 - elliptic integrals, 511
 - erf() function, 511
 - exp() function, 511
 - floor() function, 511
 - fma() function, 511
 - Legendre polynomials, 511
 - log() function, 511
 - numeric limits and, 511
 - pow() function, 511
 - ratio class, 511
 - remainder() function, 511
 - sin() function, 511
 - sinh() function, 511
 - sqrt() function, 511
 - tgamma() function, 511
 - valarray class, 511
- missing functionality, 532
- modifying sequence algorithms, 525–526
- multithreading, 513
- operator overloading, 509
- optional class, 512–513
- orthogonality, 521
- pair template, 512
- random number library
 - rand() function, 512
 - srand() function, 512
- regular expressions, 510
- resources, 1066
- smart pointers, 510
- stream iterators
 - istream_iterator class, 730
 - ostream_iterator class, 729
- streams, 510
- strings, 509
- templates, 508–509
- time utilities, <chrono> header file, 512
- <tuple> header file, 512
- type aliases, 353
- type traits, 513
- unordered associative containers, 518–519
- <utility> header, 512
- variant class, 513
- standard user-defined literals, 367
- state, 128
- statements
 - conditional
 - if/else, 17–18
 - operator, 20
 - switch, 18–19
 - switch, [[fallthrough]] attribute, 364
- static assertions, 947–948
- static binding, 287
- static casts, pointers and, 176
- static data members, 258
 - access, 259–260
 - const, 260–261
 - inline variables, 259
- static keyword
 - data members, 347
 - linkage, 347
 - external, 348
 - internal, 348
 - static, 348
 - methods, 347
- static methods, 251
- static variables, 350
- static_cast(), 358–359, 361

- std::array container, 25
- std::as_const() method, 358
- std::atomic type, 827
- std::back_inserter, 732
- std::bad_cast exception, 360–361
- std::condition_variable, 840
- std::condition_variable_any, 840
- std::function, 612–614
- std::make_from_tuple(), 719
- std::make_move_iterator(), 734
- std::make_pair(), 342
- std::ostringstream class, 425
- std::pair class, 714–716
- std::pair utility class, 342
- std::reverse_iterator, 730–731
- std::shared_future, 847–848
- std::string class, 62–64
 - literals, 64
 - numeric conversions
 - high level, 64–65
 - low level, 65–67
- std::string_view class, 67–69
- std::throw_with_nested(), 453
- std::tie, 717–718
- std::unique_ptr pointer, 182–183
- std::vector, 352–353
- std::vector array container, 25–26
- STL (Standard Template Library), 507
- str() method, 425
- streams, 410, 600
 - bidirectional, 431–432
 - buffered, 410, 413
 - cerr, 410
 - cin, 410
 - clog, 410
 - cout, 410
 - current position, 411, 426
 - destinations, 411
 - file streams, 426–427
 - fgets() function and, 411
 - <fstream> header file, 426–427
 - fprintf() function and, 411
 - fputs() function and, 411
 - fread() function and, 411
 - fscanf() function and, 411
 - fwrite() function and, 411
 - ios_base::app constant, 427
 - ios_base::ate constant, 427
 - ios_base::binary constant, 427
 - ios_base::in constant, 427
 - ios_base::out constant, 427
 - ios_base::trunc constant, 427
- flushes, 413
- flush-on-access, 430–431
- input
 - >> operator, 417–418
 - error handling, 418–419
 - manipulators, 423
- iterators
 - istream_iterator class, 730
 - ostream_iterator class, 729
- linking, 430–431
- output, 411–412
 - << operator, 412
 - cout, 412
 - error handling, 414–415
 - manipulators, 415–417
- seek() method, 428–430
- sources, 411
- Standard Library, 510
- string
 - in-memory stream, 425
 - sprintf() function, 411
 - sprintf_s() function, 411
 - sscanf() function, 411
- tell() method, 428–430
- tie() method, 430–431
- unbuffered, 410
- string class, 509
- <string> header, 509
- string literals, localizing, 664
- string streams
 - in-memory stream, 425
 - sprintf() function, 411
 - sprintf_s() function, 411
 - sscanf() function, 411
- strings, 29, 598–599

- dynamic, 58
 - C-style, 58–59
 - nonstandard strings, 69
 - std::string class, 62–67
 - std::string_view class, 67–69
 - string literals, 60–62
 - interviews, 1040–1041
 - time point conversion, 699
 - string_view class, 509
 - structured bindings, 26
 - structures, pointers to, 31
 - subscripting operator, overloading, 486–489
 - non-integral array indices, 490
 - operator[], 489–490
 - subsystems, interface and, 140
 - superclasses, 130, 278
 - swap() algorithm, 647
 - swap() method, 247–248, 546
 - swap and exchange algorithms, 646–647
 - switch statements, 18–19
 - [[fallthrough]] attribute, 364
 - symbol servers, 946–947
 - system tests, 929
 - system_clock class, 698
- T**
- tearing, multithreaded programming and, 817
 - tell() method, 428–430
 - template classes, writing, 977–979
 - templates, 102, 374, 514
 - class templates
 - < > (angle brackets), 383
 - alias templates, 399
 - compiler and, 383–384
 - definitions, 384–386
 - driving from, 397–398
 - inheritance, 397–398
 - instantiation, 378, 382
 - parameters, 386–391
 - writing, 375–383
 - function templates, 400–401
 - class templates and, 403–404
 - overloading, 402–403
 - return types, 405–406
 - specialization, 401–402
 - generic programming and, 508
 - interviews, 1052–1053
 - metaprogramming, 797–798
 - factorial at compile time, 798–799
 - loops, unrolling, 799–800
 - tuples, printing, 800–803
 - type traits, 803–812
 - parameterization
 - parameter deduction, 404–405
 - types, 374
 - values, 374
 - parameters, non-type, 780–782
 - recursion, 787
 - N-Dimensional grid, 788–792
 - resources, 1067
 - reusable code, 148
 - benefits, 149
 - versus inheritance, 150
 - problems, 149
 - std::vector class, 148
 - specialization, 395–397
 - full class, 782–785
 - partial class, 782–785
 - Standard Library, 508–509
 - template parameters, 778–780
 - type parameters, 776–778
 - variable templates, 407
 - variadic
 - folding expressions, 796–797
 - mixin classes, 795–796
 - type-safe variable-length argument lists, 792–794
 - temporary objects, object handling and, 886–887
 - terminate() function, 444
 - ternary operators, 13
 - testing
 - black-box, 909
 - bugs, 910–913
 - granularity, 916
 - integration, 929

- JSON-based file serializer, 928
 - shared resources, readers/writers, 928
 - wrapper, third-party library, 928–929
 - interviews, 1059
 - regression testing, 930
 - resources, 1071
 - smoke testing, 930
 - system tests, 929
 - unit testing, 913–914
 - approaches, 914–915
 - building, 922–923
 - debugging, 927
 - granularity, 915–916
 - negative tests, 923
 - planning, 917
 - results, 927
 - running, 919, 922–923
 - sample data, 918
 - Visual C++ testing framework, 920–921
 - writing, 918–919, 921–922
 - white-box, 909
 - tgamma() function, 511
 - this pointer, 206–207, 227
 - <thread> folder, 513, 819
 - thread objects, 819
 - threadFunc() function, 825
 - threading design, 853–855
 - threading support library, header files, 1082
 - threads
 - cancelling, 824
 - exceptions
 - copying, 824–826
 - rethrowing, 824–826
 - function object and, 820–822
 - function pointer and, 819–820
 - lambda expressions and, 822
 - local storage and, 823
 - member function and, 823
 - results, retrieving, 824
 - throw keyword, 454–456
 - throwing exceptions, 437–439, 976
 - multiple, 441–443
 - tie() method, 430–431
 - time points, 699–702
 - time utilities, Standard Library, 512
 - timed mutex classes, 832–833
 - time_point class, 698, 700–702
 - transform() algorithm, 526
 - transform_exclusive_scan() algorithm, 657
 - transform_inclusive_scan() algorithm, 657
 - transparent operator functors, 622
 - try keyword, 464–467
 - tuples
 - comparisons, 718–719
 - concatenation, 718
 - decompose
 - std::tie, 717–718
 - structured bindings, 717
 - std::apply, 719–720
 - std::make_from_tuple(), 719
 - std::pair class, 714–716
 - std::tuple_cat(), 718
 - <utility> header, 714–716
 - type aliases, 352–353
 - function pointers, 353–355
 - pointers
 - to data members, 355–356
 - to methods, 355–356
 - type building, operator overload and, 271–272
 - type inference, 38
 - auto keyword, 39–40
 - decltype keyword, 40
 - type parameters, templates, 776–778
 - typed constructors, 307
 - typedefs, 356–357
 - types
 - enumerated, 15–16, 264–265
 - strongly typed enumerations, 16
 - literal, 346
 - structs, 16–17
 - templates and, 384
 - <type_traits> header, 513
- ## U
- UCS (Universal Character Set), 665
 - UML (Unified Modeling Language), 96, 1067
 - unary operators, 13
 - unbuffered streams, 410

- uncaught exceptions, 444–445
 - Unicode, 509
 - uniform initialization, 43–45
 - unique() algorithm, 526
 - unique_copy() algorithm, 526
 - unique_ptr pointer, 182–186
 - unit testing, 913–914
 - approaches, 914–915
 - building, 922–923
 - debugging, 927
 - granularity, 915–916
 - negative tests, 923
 - planning, 917
 - results, 927
 - running, 919, 922–923
 - sample data, 918
 - Visual C++ testing framework, 920–921
 - writing, 918–919, 921–922
 - unordered_map container, 521
 - unordered_multimap container, 521
 - unordered_multiset container, 521
 - unordered_set container, 521
 - upcasting, 299
 - upper_bound() algorithm, 649
 - user-defined literals, 365–367
 - using declaration, 9
 - utilities
 - general, header files, 1079–1080
 - interface, 140
 - mathematical, header files, 1081
 - variable-length argument lists, 369–370
 - argument access, 370–371
 - disadvantages, 371
 - <utility> header, 630
 - tuples, 714–716
 - const keyword, 343
 - inline, static data member access, 259
 - methodPtr, 355–356
 - non-local
 - destruction, 351
 - initialization order, 351
 - static, 350
 - uninitialized, 30
 - variadic templates
 - folding expressions, 796–797
 - mixin classes, 795–796
 - parameter packs, 793
 - type-safe variable-length argument lists, 792–794
 - <variant> header, 712–713
 - vector container, 342, 514–515, 519, 542–561
 - algorithmic complexity, 554
 - allocators, 542
 - assigning, 545–546
 - comparing, 546
 - constructors, 544–545
 - copying, 545–546
 - destructors, 544–545
 - dynamic-length, 544
 - elements, 550–553
 - fixed-length, 542–543
 - iterators, 547–550, 554
 - memory allocation scheme, 554–556
 - move semantics, 553–554
 - reference storage, 550
 - round-robin schedule example, 556–561
 - vectorbool specialization, 561
 - vendor-specific attributes, 365
 - virtual base classes, 312, 331–332
 - virtual keyword, 281–282
 - destructors, 288–290
 - implementing, 287–288
 - virtual methods, 303
 - Visual C++ testing framework, 920–921
 - vtables, 287
- V**
- value semantics, elements, 537–538
 - variable templates, 407
 - variables, 10–12
 - automatic variables, 164
 - casting, 12
 - coerced, 12
 - condition variables, 840–842
- W**
- Waterfall Model life cycle model, 861–863
 - weak_ptr, 189–190

WeatherPrediction class, 291–294
while loop, 26–27
white-box testing, 909
wide characters, localization, 664–665
wifstream, 665
Windows, DLL (Dynamic Link Library),
354–355
wofstream, 665
write() method, 413

Wrox downloads, 3
ws input manipulator, 423

X-Y-Z

xRef, 334–335

zero-initialization constructs, 544