



**Pyrometry: The Papers and Discussion of a Symposium on Pyrometry Held by the American Institute of Mining and Metallurgical Engineers at Its Chicago Meeting, September, 1919 (1920)**

Pages  
718

Size  
5 x 8

ISBN  
0309339464

American Institute of Mining and Metallurgical Engineers; National Research Council; National Bureau of Standards

 [Find Similar Titles](#)

 [More Information](#)

**Visit the National Academies Press online and register for...**

- ✓ Instant access to free PDF downloads of titles from the
  - NATIONAL ACADEMY OF SCIENCES
  - NATIONAL ACADEMY OF ENGINEERING
  - INSTITUTE OF MEDICINE
  - NATIONAL RESEARCH COUNCIL
- ✓ 10% off print titles
- ✓ Custom notification of new releases in your field of interest
- ✓ Special offers and discounts

Distribution, posting, or copying of this PDF is strictly prohibited without written permission of the National Academies Press. Unless otherwise indicated, all materials in this PDF are copyrighted by the National Academy of Sciences.

To request permission to reprint or otherwise distribute portions of this publication contact our Customer Service Department at 800-624-6242.

Copyright © National Academy of Sciences. All rights reserved.

# PYROMETRY

THE PAPERS AND DISCUSSION

OF A

SYMPOSIUM ON PYROMETRY

HELD BY THE]

AMERICAN INSTITUTE OF  
**Mining and Metallurgical Engineers**

AT ITS CHICAGO MEETING, SEPTEMBER, 1919,

IN COÖPERATION WITH THE

NATIONAL RESEARCH COUNCIL

AND THE

NATIONAL BUREAU OF STANDARDS

NEW YORK CITY.

PUBLISHED BY THE INSTITUTE

AT THE OFFICE OF THE SECRETARY

1920



COPYRIGHT, 1920, BY THE  
AMERICAN INSTITUTE OF MINING AND METALLURGICAL ENGINEERS  
(INCORPORATED)

THE MAPLE PRESS YORK PA

## PREFACE

---

At the Chicago Meeting of the Institute, September, 1919, there was held a Symposium on Pyrometry which brought out a collection of papers and the correlative discussion which marked an epoch in this branch of metallurgical technique. To preserve to the profession at large as well as to our own members this unique literature on this subject, which heretofore has been distinguished by its paucity, is the object of this volume.

Both the National Research Council and the National Bureau of Standards coöperated with the Institute in this symposium. The Pyrometer Committee of the Council was formed for the specific purpose of executing certain experimental operations which are very properly described in the report of the Pyrometer Committee. Before the foundation of the Pyrometer Committee the National Bureau of Standards contemplated organizing a symposium on this subject and went so far as to complete a working organization to that end. Members of the Bureau of Standards contributed one-third of the total number of papers in this volume.

So the coöperation between the Institute and these two national bodies has been harmonious and complete and has resulted in covering the subject with a degree of fullness and finality seldom achieved in technical publication.

These papers have all been published in the monthly Bulletin, but will not be included in the Transactions of the Institute.

## CONTENTS

|   | Page |
|---|------|
| Report of Pyrometer Committee of National Research Council. By GEORGE K. BURGESS (With Discussion).....                                       | 3    |
| Temperature. By J. S. AMES.....   | 37   |
| Standard Scale of Temperature. By C. W. WAIDNER, E. F. MUELLER and PAUL D. FOOTE (With Discussion).....                                       | 46   |
| Metals for Pyrometer Standardization. By C. W. WAIDNER and GEO. K. BURGESS.....   | 61   |
| Fundamental Laws of Pyrometry. By C. E. MENDENHALL.....   | 63   |
| Present Status of Radiation Constants. By W. W. COBLENTZ.....   | 72   |
| Thermoelectric Pyrometry. By PAUL D. FOOTE, T. R. HARRISON and C. O. FAIRCHILD (With Discussion).....   | 74   |
| Potentiometers for Thermoclement Work. By WALTER P. WHITE (With Discussion).....  | 137  |
| Self-checking Galvanometer Pyrometer. By H. F. PORTER (With Discussion).....  | 149  |
| Some Factors Affecting Usefulness of Base-metal Thermocouples. By O. L. KOWALKE (With Discussion).....  | 154  |
| Tables and Curves for Use in Measuring Temperatures with Thermocouples. By L. H. ADAMS.....   | 165  |
| Reference Standard for Base-metal Thermocouples. By N. E. BONN.....   | 179  |
| Alloys Suitable for Thermocouples and Base-metal Thermoelectric Practice. By J. M. LOHR.....  | 181  |
| Recent Improvements in Pyrometry. By R. P. BROWN (With Discussion)....  | 188  |
| Automatic Compensation for Cold-junction Temperatures of Thermocouple Pyrometers. By F. WUNSCH (With Discussion).....                         | 206  |
| Use of Modified Rosenhain Furnace for Thermal Analysis. By H. SCOTT and J. R. FREEMAN, JR.....  | 214  |
| A Hot-wire Anemometer with Thermocouple. By T. S. TAYLOR.....   | 221  |
| High-temperature Thermometers. By R. M. WILHELM (With Discussion)....   | 225  |
| Porcelain for Pyrometric Purposes. By F. H. RIDDLE.....   | 240  |
| Pyrometer Porcelains and Refractories. By R. W. NEWCOMB (With Discussion)   | 251  |
| Pyrometer Protection Tubes. By F. A. HARVEY (With Discussion).....  | 255  |
| Protecting Tubes for Thermocouples. By R. B. LINCOLN.....   | 258  |
| Pyrometer Protection Tubes. By OTIS HUTCHINS.....   | 262  |
| Melting Point of Refractory Materials. By LEO I. DANA (With Discussion)...  | 267  |
| High-temperature Scale and its Application in Measurement of True, Brightness and Color Temperature. By EDWARD P. HYDE.....                   | 285  |
| Theory and Accuracy in Optical Pyrometry with Particular Reference to the Disappearing-filament Type. By W. E. FORSYTHE (With Discussion).... | 291  |
| Optical and Radiation Pyrometry. By PAUL D. FOOTE and C. O. FAIRCHILD (With Discussion).....  | 324  |
| Industrial Applications of Disappearing-filament Optical Pyrometer. By F. E. BASH.....  | 352  |
| Emissive Powers and Temperatures of Non-black Bodies. By A. G. WORTHING   | 367  |
| Recording Thermocouple Pyrometers. By LEO BEHR (With Discussion).....   | 400  |

# PAPERS



## Report of Pyrometer Committee of National Research Council

BY GEORGE K. BURGESS,\* WASHINGTON, D. C.

(Chicago Meeting, September, 1919)

THE Pyrometer Committee was formed Sept. 20, 1918, at the suggestion of Dr. H. M. Howe, Chairman of the Engineering Division of the Research Council, for the purpose of developing a pyrometric method suitable for open-hearth steel practice so that the effects of temperature in the various stages of the processes of steel making might be correlated quantitatively with the other factors influencing the production of sound steel. As finally constituted the Committee consists of:

Dr. George K. Burgess, Chief Division of Metallurgy, Bureau of Standards, *Chairman*.

Dr. Paul D. Foote, Chief of Pyrometry Section, Bureau of Standards, *Secretary*.

Dr. H. M. Howe, Chairman Engineering Division, National Research Council, *ex officio*.

Prof. G. H. Clevenger, Chairman Metallurgical Section, National Research Council, *ex officio*.

Mr. F. E. Bash, Leeds & Northrup Co., Philadelphia, Pa.

Mr. R. P. Brown, The Brown Instrument Co., Philadelphia, Pa.

Prof. G. H. Brown, Rutgers College, New Brunswick, N. J.

Mr. R. C. Driinker, metallurgical engineer, Boston, Mass.

Dr. W. E. Forsythe, Nela Research Laboratory, Cleveland, Ohio.

Mr. J. T. Hall, Taylor-Wharton Iron & Steel Co., High Bridge, N. J.

Mr. J. S. McDowell, Harbison-Walker Refractories Co., Pittsburgh, Pa.

Mr. Malcolm McNaughton, Joseph Dixon Crucible Co., Jersey City, N. J.

Mr. A. H. Miller, Midvale Steel Co., Philadelphia, Pa.

Mr. F. E. Walduck (since deceased), The Norton Co., Worcester, Mass.

The Committee has held frequent meetings and has carried out an extensive program of experimental work by means of sub-committees; in the execution of which the Committee has been aided greatly not only

---

\* Chairman of the Committee.

by the manufacturing companies of instruments, refractories, and steel with which the members are severally associated, but also by help and offers of facilities from several other companies.

In addition to the experimental work carried out by the Committee, it was decided to hold a symposium on pyrometry, and the Secretary, Dr. Foote, assisted by Dr. Forsythe, has had signal success in collecting an admirable series of monographs covering both the theoretical aspects of the subject and the applications of pyrometry to many industrial operations. The American Institute of Mining and Metallurgical Engineers has accepted the invitation to publish these papers and provide a forum for their discussion.

The report of the Committee would not be complete without this list of titles:

Temperature, by J. S. AMES.

Standard Scale of Temperature, by C. W. Waidner, E. F. Mueller and Paul D. Foote.

Metals for Pyrometer Standardization, by C. W. Waidner and Geo. K. Burgess.

Fundamental Laws of Pyrometry, by C. E. Mendenhall.

Thermoelectric Pyrometry, by Paul D. Foote, T. R. Harrison and C. O. Fairchild.

Potentiometers for Thermoelement Work, by Walter P. White.

Self-checking Galvanometer Pyrometer, by H. F. Porter.

Some Factors Affecting Usefulness of Base-metal Thermocouples, by O. L. Kowalke.

Tables and Curves for Use in Measuring Temperatures with Thermocouples, by L. H. Adams.

Reference Standard for Base-metal Thermocouples, by N. E. Bonn.

Alloys Suitable for Thermocouples and Base-metal Thermoelectric Practice, by J. M. Lohr.

Recent Improvements in Pyrometry, by R. P. Brown.

Automatic Compensation for Cold-junction Temperatures of Thermocouple Pyrometers, by F. Wunsch.

A Hot-wire Anemometer with Thermocouple, by T. S. Taylor.

Porcelain for Pyrometric Purposes, by F. H. Riddle.

Pyrometer Porcelains and Refractories, by R. W. Newcomb.

Pyrometer Protection Tubes, by F. A. Harvey.

Protecting Tubes for Thermocouples, by R. B. Lincoln.

Melting Point of Refractory Materials, by Leo I. Dana.

High Temperature Scale and its Application in Measurement of True, Brightness and Color Temperature, by Edward P. Hyde.

Theory and Accuracy in Optical Pyrometry with Particular Reference to the Disappearing-filament Type, by W. E. Forsythe.

Optical and Radiation Pyrometry, by Paul D. Foote and C. O. Fairchild.

Industrial Applications of Disappearing-filament Optical Pyrometer, by F. E. Bash.

Use of Optical Pyrometers for Control of Optical-glass Furnaces, by C. N. Fenner.

Emissive Powers and Temperatures of Non-black Bodies, by A. G. Worthing.

Recording Thermocouple Pyrometers, by Leo Behr.

Recording Pyrometry, by C. O. Fairchild and Paul D. Foote.

High-temperature Control, by C. O. Fairchild and Paul D. Foote.

Resistance Thermometry, by F. W. Robinson.

Tin, an Ideal Pyrometric Material, by E. F. Northrup.

- Resistance Thermometry for Industrial Use, by CHARLES P. FREY.  
Thermocouple Installation in Annealing Kilns for Optical Glass, by E. D. WILLIAMSON and H. S. ROBERTS.  
Annealing of Glass, by A. Q. TOOL and J. VALASEK.  
Pyrometry Applied to Bottle-glass Manufacture, by R. L. FRINK.  
Pyrometry in the Manufacture of Optical Glass, by ALBERT J. WALCOTT.  
Pyrometry as Applied to the Manufacture of Optical Glass, by CARL W. KEUFFEL.  
Pyrometer Shortcomings in Glass-house Practice, by W. M. CLARK and CHARLES D. SPENCER.  
Some Thermal Relations in the Treatment of Steel, by C. F. BRUSH.  
Forging Temperatures and Rate of Heating and Cooling of Large Ingots, by F. E. BASH.  
Pyrometry and Steel Manufacture, by A. H. MILLER.  
Pyrometry in Blast-furnace Work, by P. H. ROYSTER and T. L. JOSEPH.  
Electric, Open-hearth and Bessemer Steel Temperatures, by F. E. BASH.  
Pyrometry in the Tool-manufacturing Industry, by J. V. EMMONS.  
Pyrometry in the Manufacture of Clay Wares, by F. K. PENCE.  
Application of Pyrometry to the Manufacture of Gas-mask Carbon, by K. MARSH.  
Application of Pyrometry to the Ceramic Industries, by C. B. THWING.  
Pyrometry in Rotary Portland Cement Kilns, by LEO I. DANA and C. O. FAIRCHILD.  
Pyrometry in the Ceramic Industry, by JOHN P. GOHEEN.  
Temperatures of Incandescent-lamp Filaments, by BENJ. E. SHACKELFORD.  
Temperature Measurements of Incandescent Gas Mantles, by H. E. IVES.  
Application of Pyrometry to Problems of Lamp Design and Performance, by I. H. VAN HORN.  
Use of Modified Rosenhain Furnace for Thermal Analysis, by H. SCOTT and J. R. FREEMAN, JR.  
High-temperature Thermometers, by R. M. WILHELM.  
Temperature of a Burning Cigar, by T. S. SLIGH and H. R. KRATBILL.  
Teaching Pyrometry in our Technical Schools, by GEORGE V. WENDELL.  
Teaching Pyrometry in Technical Schools, by C. E. MENDENHALL.  
Teaching Pyrometry, by O. L. KOWALKE.  
Present Status of Radiation Constants, by W. W. COBLENTZ.  
Pyrometer Protection Tubes, by OTIS HUTCHINS.

Two previous symposia on pyrometry may be noted, that held by the Iron and Steel Institute of Great Britain in 1904, and the recent much more pretentious one, giving an excellent picture of the present industrial situation of pyrometry in England (although there were also several American contributions), held under the auspices of the Faraday Society on Nov. 7, 1917.<sup>1</sup>

It may be of interest, in order to put the experimental work of the Committee in its proper perspective, to mention briefly the papers relating to open-hearth furnace practice and conclusions reached by the symposium of the Faraday Society. These papers were: 1. Determination of the Temperature of Liquid Steel Under Industrial Conditions, by Mr. Cosmo Johns. 2. Notes on Pyrometry from the Standpoint of Ferrous Metallurgy, by Dr. W. H. Hatfield. 3. Applications of Optical Pyro-

<sup>1</sup> *Trans. Faraday Soc.* (1918) **13**, pt. 3.



metry in Steel Works Practice, by Mr. J. Neill Greenwood. 4. Temperature Determinations of Liquid Steel, by Dr. A. McCance.

In the main, the authors of these papers confirmed the results and sustained the conclusions of the investigations published by the Chairman of this Committee in May, 1917.<sup>2</sup> No new methods were experimented with by these authors nor new principles suggested, although there were developed several important details of technique, particularly by Messrs. Johns and Greenwood.

From all these researches it appears fair to conclude that the problem of measurement of the temperature of metal streams or running clean surfaces of liquid steel, has been adequately solved. It is also of interest to note that all the above observers agree that the most suitable type of pyrometer for this purpose is the optical, or to quote Mr. Johns:

"The most suitable instrument is an optical pyrometer using monochromatic light  $\lambda = 0.65\mu$ , which it is suggested should be adopted as a standard. It should have a scale that can be read, under industrial conditions, to 2° C. The observer should be able to read to  $\pm 5^\circ$  C."

The situation as regards the exploration of the temperature distribution within the open-hearth furnace and metal bath is, however, far from being satisfactory, and the Pyrometer Committee decided, at its first meeting, to concentrate its endeavors mainly on this, the most important and most difficult phase of the problem; for it is in the furnace that the steel is made and the reactions are all functions of the temperature.

Previous investigations had shown some of the difficulties to be overcome: mechanical, metallurgical and thermal. The pyrometer itself is the least of these. The greatest is a refractory that has the requisite mechanical, chemical and thermal properties; it must be robust enough, when hot and cold, to withstand abuse; it must withstand the corrosive action of basic and acid slags, flames, hot gases and liquid steel; be non-porous and not give off fumes, smoke, or water vapor when heated; it must not crack on sudden heating or cooling and must be able to withstand a temperature of nearly 1700° C.; and finally it must be capable of being manufactured into closed-end tubes of convenient size with a thickness of wall not too great, nor of too low thermal conductivity, to allow the interior to assume rapidly the temperature of the region into which it is thrust. It is no reflection on the ability of the members of the subcommittee charged with this problem to say they are still looking for a suitable refractory. When such is found the question of the pyrometer to use will answer itself.

The problem of determining open-hearth furnace temperatures, from

---

<sup>2</sup> George K. Burgess: Temperature Measurements in Bessemer and Open-hearth Practice, *Tech. Paper 91*, U. S. Bureau of Standards. Also published in condensed form in *Trans.* (1917) **56**, 432.

the point of view of measurement, appears to have two aspects similar to other cases often occurring in the application of methods of measurement:

1. A primary method must be devised which will give temperatures directly; such a method may, however, not be practicable for other than calibration purposes.

2. A secondary method may be used in practical temperature control of the operations; such a secondary method may be quite indirect in its operation and must be standardized by comparison with the primary.

It would, of course, be desirable if the primary method might also be used as the practical control method in the operation of the open-hearth furnace.

An illustration of a primary method for open-hearth temperatures would be a suitable closed-end tube thrust into the bath to the desired depths, the temperature of the inside end of the tube being measured by any suitable pyrometer as optical or thermoelectric. Practically, it has not yet been found possible to devise such a satisfactory outfit of sufficient permanence to remain intact in the bath a sufficient time to make this a practical control method. As illustrations of possible secondary methods may be mentioned that of removing a spoonful of metal and estimating the temperature of the bath from observations, either thermoelectric or optical, in the metal spooned out; this has been modified by Mr. Drinker and its use will be discussed later. Another secondary method would be to insert a pyrometer tube in the furnace lining and determine the relation of the temperature of bath to that of the end of the tube; in this case, however, due to time lag of temperature, it would be difficult, if not impossible, to realize a practical control.

One plan suggested, which it was hoped might serve as both primary and secondary method, was to insert vertically through the roof of the open hearth a closed-end refractory tube which could be lowered into the bath, and also capable of being raised free from it so as to diminish deterioration and avoid breakage while charging the furnace. No steel maker appeared to want to take the responsibility of breaking through the roof in this way, and our subsequent experience with refractory tubes showed this idea to be somewhat premature. Similar objection would apply to the permanent installation of a tube thrust diagonally into the furnace as illustrated by Greenwood.<sup>3</sup>

#### EXPERIMENTS WITH THE DRINKER METHOD

The method suggested by Mr. R. C. Drinker for determining the temperature of the metal bath in the open-hearth furnace is a modification of the "spoon" method described in *Tech. Paper 91*. This method,

---

<sup>3</sup> *Loc. cit.*

which resembles taking a fracture test, seemed to warrant the systematic study which was given it by a sub-committee consisting of Messrs. Burgess, Bash, R. P. Brown, Drinker and Miller.

In the form used by the Committee, and as constructed by the Brown Instrument Co., the Drinker molten metal pyrometer is illustrated in Fig. 1; a millivoltmeter connected to *F* with copper leads of any convenient length completes the outfit. Theoretically, the operation of this apparatus is extremely simple and consists in transferring metal from the open-hearth bath in a spoon and filling the crucible *D*, containing about 2 lb., to its lip, while taking readings of time and of the millivoltmeter until a maximum is reached, from which data the temperature of the metal in the furnace may be estimated. To empty the metal from the

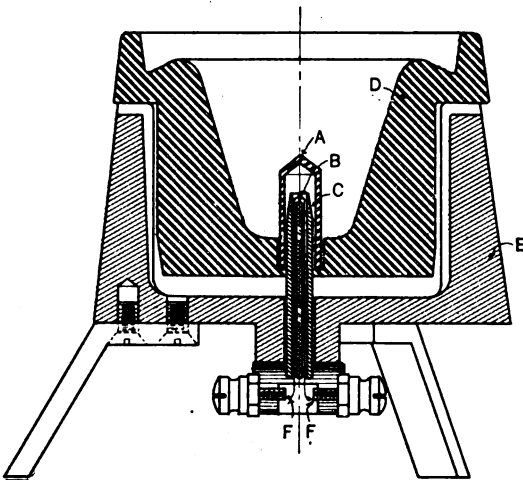

FIG. 1.—DRINKER MOLTEN METAL PYROMETER. *A*, METAL SHIELD FOR THERMOCOUPLE; *B*, PLATINUM THERMOCOUPLE; *C*, THERMOCOUPLE INSULATOR OF ALUNDUM; *D*, CRUCIBLE OF STEEL; *E*, CRUCIBLE SUPPORT; *F*, THERMOCOUPLE CONNECTIONS.

crucible, it is lifted from the support *E* and treated as is a fracture test mold; the metal shield *A* is removed with the metal and has to be replaced; the crucible is then chilled in water and reset on its support, and the apparatus is ready for second determination.

In practice, there are many factors that conspire to render readings uncertain. Some of the variables that it is necessary to control or standardize are:

1. A standard-sized spoon must be adopted of exactly the same dimensions for all tests.
2. The spoon before each test must be cooled to atmospheric temperature.
3. The spoon must be full of metal in each instance.

4. The man who skims the spoon must do this in one effort and without skimming below an inch or two of the surface.

5. The time interval between the removal of the metal from the bath and pouring into the crucible must be accurately measured and reproduced. Pouring must occur at a uniform rate into the crucible.

6. The crucible must be cooled to atmospheric temperature before each test.

In practice it seems almost impossible to have all these points carried out properly, although it is possible that if the instrument should be generally adopted and the men become familiar with its use, these operations might be performed correctly, but it is difficult to get the necessary intelligent and adequate coöperation of the furnace helpers. Of course it is also evident that the dimensions and relative positions of the crucible parts and thermocouple accessories, particularly of *A*, *B*, and *C*, must be invariable, otherwise a standard practice cannot be set up and maintained.

Tables 1, 2, and 3 show three series obtained by the sub-committee using the Drinker method, and it will be noted that, although every effort was made to develop a uniform practice, there are many serious discrepancies among the observations which were also checked by observations taken with an optical pyrometer sighting on the metal stream as it was being poured into the crucible. It is evident from the table that the optical readings are much more satisfactory than the others. Another variable of unexpected magnitude, the quantitative effect of which has not been worked out, is the variation in weight of the metal filling the crucible as dependent upon the state of the bath; this is undoubtedly associated with the gas content of the steel.

The temperatures given by the Drinker method in the column marked "maximum" in the tables cannot, of course, be true temperatures of the metal in the furnace; it would be necessary, as previously stated, to calibrate any given apparatus and practice. The order of correction to apply to such readings is shown by a comparison of this column with that of the optical pyrometer readings (which are corrected for emissivity using  $e=0.40$ , see Table 4) for this pyrometer sighted on the metal stream, which also are low.

The Committee is forced to the conclusion that the Drinker method, as above described, which gave promise of reliability and looked particularly attractive in that its manipulation was almost identical with an operation familiar to the furnace man, is nevertheless not suited for measurements exact to  $10^{\circ}$  C. or  $20^{\circ}$  C., an accuracy that is required and, moreover, can be obtained by use of the optical pyrometer.

REPORT OF PYROMETER COMMITTEE

TABLE 1.—*Test on Drinker Method of Obtaining Open-hearth Temperatures*  
 Made by Dr. Burgess and Messrs. Brown, Bash, Miller, Apr. 17, 1919.

| Test Number | Furnace and Heat Number | Time           | Temp. Furnace (Opt. Pyr. on Slag), Degrees F. | Temp. Stream, Spoon to Drinker Mold, Pyr., Degrees F. | Amount of Metal    |       | Weight of Metal in Drinker Mold |                  | Time of Pouring, Taken from Time Spoon was Lifted from Bath |                              |                               | Thermocouple Reading, Degrees F. |       | Remarks |                           |
|-------------|-------------------------|----------------|---|---|--------------------|-------|---------------------------------|------------------|---|------------------------------|-------------------------------|----------------------------------|-------|---------|---------------------------|
|             |                         |                |   |   | Lb.                | Oz.   | Lb.                             | Oz.              | To Door of Furnace, Seconds                                 | To Start of Pouring, Seconds | To Finish of Pouring, Seconds | To Max. Reading, Seconds         | Start |         | Max.                      |
| 1           | 8/5394                  | A. M.<br>10.25 | .....   | 2442?   | .....              | ..... | .....                           | 2                | 3   | 5                            | ..                            | 19                               | 0     | 1960    |                           |
| 2           | 8/5394                  | .....          | 2985  | 2506  | .....              | ..... | 2                               | 15 $\frac{1}{2}$ | 5   | 5                            | ..                            | 16                               | 200   | 2030    |                           |
| 3           | 8/5394                  | .....          | Flame off 2708                                | 2534  | .....              | ..... | 1                               | 14 $\frac{1}{2}$ | 5   | 5                            | ..                            | 18                               | 0     | 1980    |                           |
| 4           | 8/5394                  | 10.46          | Flame on 2987                                 | 2527  | .....              | ..... | 2                               | 14 $\frac{1}{2}$ | 6   | 6                            | ..                            | 22                               | 140   | 1980    |                           |
| 5           | 8/5394                  | .....          | .....   | 2527  | .....              | ..... | 1                               | 15               | 4   | 4                            | ..                            | 18                               | 150   | 1960    |                           |
| 6           | 8/5394                  | 11.00          | .....   | 2527  | .....              | ..... | 1                               | 15               | 5   | 5                            | ..                            | 21                               | 81    | 100     | 2020                      |
| 7           | 8/5394                  | 11.11          | .....   | 2534  | .....              | ..... | 2                               | 21 $\frac{1}{2}$ | 5   | 13                           | 20                            | 60                               | 160   | 2060    |                           |
| 8           | 10/5113                 | 11.21          | 2873  | 2434  | .....              | ..... | 1                               | 5 $\frac{1}{2}$  | 3   | 15                           | 20                            | 58                               | 120   | 1880    | Metal boiling             |
| 9           | 10/5113                 | 11.25          | .....   | 2426  | Full               | 2     | 15 $\frac{1}{2}$                | 3                | 5   | 18                           | 23                            | 63                               | 120   | 1910    | Metal boiling; heavy slag |
| 10          | 10/5113                 | 11.35          | .....   | 2426  | $\frac{3}{4}$ Full | 3     | 1                               | 7                | 5   | 14                           | 22                            | 55                               | 130   | 1968    | Metal boiling             |
| 11          | 10/5113                 | .....          | 2880  | 2456  | Full               | 3     | 9                               | 1                | 9 $\frac{1}{2}$   | 5                            | 15                            | 58                               | 140   | 1950    | Metal boiling             |
| 12          | 10/5113                 | 11.50          | .....   | 2371?   | $\frac{1}{4}$ Full | 1     | 13                              | 1                | 5   | 22                           | 25                            | 59                               | 140   | 1960    | Metal boiling             |
| 13          | 10/5113                 | 11.55          | .....   | 2428  | $\frac{3}{4}$ Full | 2     | 15                              | 1                | 6   | 5                            | 18                            | 23                               | 65    | 1890    | Metal boiling             |
| 14          | 10/5113                 | P. M.<br>12.01 | .....   | 2456  | .....              | 2     | 10                              | ..               | 15 $\frac{1}{2}$  | 4                            | 17                            | 21                               | 180   | 1990    | Metal boiling             |

NOTE.—Thermocouple was protected by aluminum as shown in Fig. 1.

TABLE 2.—*Tests on Drinker Method of Obtaining Open-hearth Temperatures*  
 Made by Messrs. Brown, Bash, Spring for Mr. Miller, Apr. 24, 1919.

| Test Number | Furnace and Heat Number | Time, A. M. | Temp. Furnace (Opt. Pyr. on Slag), Degrees F. | Temp. Stream, Spoon to Drinker Mold, Opt. Pyr., Degrees F. | Amount of Metal |         | Weight of Metal in Drinker Mold |              | Time of Pouring, Taken from Time Spoon was Lifted from Bath |                           |                            |                             | Thermocouple Reading, Degrees F. |      | Remarks |             |
|-------------|-------------------------|-------------|---|--|-----------------|---------|---------------------------------|--------------|---|---------------------------|----------------------------|-----------------------------|----------------------------------|------|---------|-------------|
|             |                         |             |   |  | Spoon           | Poured  | Weight of Metal                 | Drinker Mold | To Door of Furnace, Seconds                                 | To Start Pouring, Seconds | To Finish Pouring, Seconds | To Maximum Reading, Seconds | Start                            | Max. |         |             |
|             |                         |             |   | Lb. Oz.  |                 | Lb. Oz. |                                 |              |   |                           |                            |                             |                                  |      |         |             |
| 1           | 8/5401                  | 10.25       | .....   | 2513   | Full            | 5       | 1½                              | 1            | 14  | 1¾                        | 7                          | 10                          | 34                               | 0    | 2285    | Metal quiet |
| 2           | 8/5401                  | 10.58       | 3026  | 2500   | Full            | 3       | 6                               | 1            | 10  | 3                         | 7½                         | 10                          | 31                               | 85   | 2340    | Metal quiet |
| 3           | 8/5401                  | 11.02       | .....   | 2513   | Full            | 4       | 12                              | 1            | 12  | ...                       | 8                          | 12                          | 23¾                              | 99   | 2335    | Metal quiet |
| 4           | 8/5401                  | 11.10       | 2967  | 2527   | ¾ Full          | 3       | 9                               | 1            | 13¾   | 3                         | 12                         | 17                          | 25                               | 100  | 2270    | Metal quiet |
| 5           | 8/5401                  | 11.18       | .....   | 2513   | Full            | 4       | 15                              | 1            | 10  | 2                         | 10                         | 17                          | 24                               | 90   | 2300    | Metal quiet |
| 6           | 8/5401                  | 11.24       | 3002  | 2610?  | Full            | 4       | 4½                              | 1            | 6   | 3                         | 9                          | 16                          | 22                               | 90   | 2330    | Metal quiet |
|             |                         |             |   | Slag on Stream   |                 |         |                                 |              |   |                           |                            |                             |                                  |      |         |             |

NOTE.—Thermocouple was bare (without any insulating protection) and was protected from the stream by an iron tip

REPORT OF PYROMETER COMMITTEE

TABLE 3.—*Tests on Drinker Method of Obtaining Open-hearth Temperatures*  
 Made by Mr. Brown and Mr. Spring for Mr. Miller, May 19, 1919.

| Test Number | Furnace and Heat Number | Time          | Amount of Spoon | Total Weight of Metal Poured |     | Weight of Metal in Drinker Mold |     | Time of Pouring Taken from Time Spoon was Lifted from Bath |                           |                            | Thermocouple Reading, Degrees F. |       | Remarks |                         |
|-------------|-------------------------|---------------|-----------------|------------------------------|-----|---------------------------------|-----|--|---------------------------|----------------------------|----------------------------------|-------|---------|-------------------------|
|             |                         |               |                 | Lb.                          | Oz. | Lb.                             | Oz. | To Door of Furnace, Seconds                                | To Start Pouring, Seconds | To Finish Pouring, Seconds | To Maximum Reading, Seconds      | Start |         | Max.                    |
| 1           | 8/5420                  | P. M.<br>2.00 | Full            | 4                            | ½   | 11                              | 15½ | 3  | 17                        | 25                         | 35                               | 75    | 2440    | Cold spoon; small spoon |
| 2           | 8/5420                  | 2.05          | Full            | 4                            | 9½  | 11                              | 14½ | 3  | 17                        | 22                         | 35                               | 90    | 2510    | Cold spoon; small spoon |
| 3           | 8/5420                  | 2.10          | Full            | 4                            | 8½  | 11                              | 6   | 3  | 15                        | 22                         | 33                               | 95    | 2460    | Hot spoon; small spoon  |
| 4           | 8/5420                  | 2.15          | Full            | 4                            | 10½ | 11                              | 7½  | 2  | 15                        | 23                         | 29                               | 95    | *2640   | Cold spoon; small spoon |

\* Molten metal found to have eaten through cold-rolled tip.

† Some liquid metal lost in emptying Drinker mold. NOTE.—Thermocouple was bare (without any insulating protection) and was protected from stream by cold-rolled tip.

EXPERIMENTS WITH REFRACTORY TUBES AND OPTICAL PYROMETER

Dr. Howe, at the first meeting of the Committee, called attention to the fact that in the fireclay insulator, with its graphite tip and reinforcing iron core, of the ladle stopper used for years in steel teeming, we have the possibilities of a protective sheath for a pyrometer in the open hearth. With this idea as a basis, an extended series of experiments has been carried out, mainly by a sub-committee consisting of Messrs. Bash and Miller assisted part of the time by Messrs. Burgess and Forsythe.

The reports of this sub-committee follow, and for convenience in interpreting the results obtained with the optical pyrometer, there is here included the table of corrections for emissivity as given in *Tech. Paper* 91, to which has been added a corresponding table in Fahrenheit degrees. All the optical-pyrometer readings, unless otherwise indicated, have been corrected for emissivity. It will be recalled that for liquid steel  $e = 0.40$  and the value of  $e$  for liquid slag is about 0.65, both for a pyrometer using light or wave length  $\lambda = 0.65\mu$ .

TABLE 4.—Corrections to Add to Temperature Readings for Emissivity  
 Pyrometer using red light, wave-length  $\lambda = 0.65\mu$ , at observed temperatures.

| Emissivity | 900°<br>C. | 1000°<br>C. | 1100°<br>C. | 1200°<br>C. | 1300°<br>C. | 1400°<br>C. | 1500°<br>C. | 1600°<br>C. | 1700°<br>C. | 1800°<br>C. | 2000°<br>C. |
|------------|------------|-------------|-------------|-------------|-------------|-------------|-------------|-------------|-------------|-------------|-------------|
| 0.30       | 80         | 94          | 110         | 127         | 146         | 166         | 188         | 211         | 235         | 262         | 318         |
| 0.40       | 59         | 70          | 82          | 95          | 108         | 123         | 139         | 156         | 174         | 193         | 234         |
| 0.50       | 44         | 53          | 62          | 71          | 81          | 92          | 104         | 116         | 129         | 143         | 173         |
| 0.60       | 32         | 38          | 45          | 51          | 59          | 67          | 75          | 84          | 93          | 103         | 124         |
| 0.65       | 27         | 32          | 37          | 43          | 49          | 56          | 63          | 70          | 78          | 86          | 104         |
| 0.70       | 22         | 26          | 31          | 36          | 41          | 46          | 52          | 58          | 64          | 71          | 86          |
| 0.80       | 14         | 16          | 19          | 22          | 25          | 28          | 32          | 36          | 40          | 44          | 53          |
| 0.90       | 7          | 8           | 9           | 10          | 12          | 14          | 15          | 17          | 19          | 21          | 25          |

| Emissivity | 1600°<br>F. | 1800°<br>F. | 2000°<br>F. | 2200°<br>F. | 2400°<br>F. | 2600°<br>F. | 2800°<br>F. | 3000°<br>F. | 3200°<br>F. | 3400°<br>F. | 3600°<br>F. |
|------------|-------------|-------------|-------------|-------------|-------------|-------------|-------------|-------------|-------------|-------------|-------------|
| 0.30       | 139         | 166         | 196         | 230         | 268         | 310         | 355         | 402         | 452         | 506         | 564         |
| 0.40       | 101         | 122         | 147         | 173         | 200         | 229         | 261         | 297         | 335         | 374         | 414         |
| 0.50       | 76          | 92          | 110         | 130         | 151         | 173         | 195         | 220         | 247         | 276         | 306         |
| 0.60       | 56          | 67          | 79          | 93          | 108         | 124         | 141         | 159         | 178         | 198         | 220         |
| 0.70       | 38          | 47          | 56          | 65          | 75          | 85          | 97          | 110         | 123         | 137         | 153         |
| 0.80       | 24          | 29          | 34          | 40          | 47          | 54          | 61          | 68          | 76          | 85          | 94          |
| 0.90       | 11          | 13          | 16          | 19          | 22          | 25          | 29          | 32          | 36          | 40          | 43          |

FIRST REPORT OF SUB-COMMITTEE ON OPEN-HEARTH PYROMETER

After talking the matter over with steel metallurgists and open-hearth men, it was decided to be impracticable to try to put the pyrometer tube



through the roof of the open-hearth furnace for the reasons that it would tend to weaken the roof, the temperature above the roof would be too high for men to work and observations to be made and the risk of the roof falling in at any time would make the work very dangerous. Also, it would mean some sort of mirror in the pyrometer tube and this could be done away with if the tube were put in from the side.

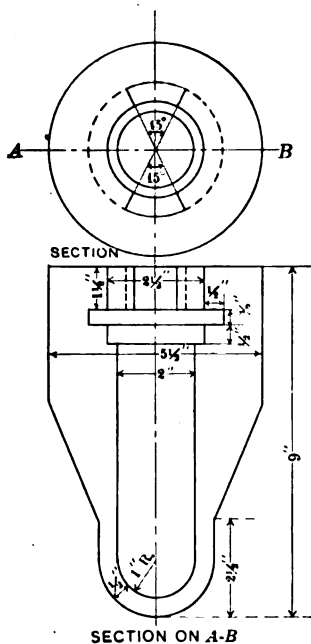

FIG. 2.—REFRACTORY TUBE FOR TAKING STEEL TEMPERATURES.

It was decided not to use wrought-iron pipe, as it could not be obtained in the size wanted and, if it got hot enough through the clay sleeves, the tube would sag whether made of wrought iron or steel. For this reason, drawn-steel pipes  $2\frac{1}{4}$  in. (5.7 cm.) outside diameter were used, each being about 11 ft. (3.4 m.) long. The graphite tip was made as per specifications as shown in Figs. 2 and 3.

While the pyrometer tube and tip were originally designed for  $5\frac{1}{2}$ -in. (14 cm.) clay sleeves, it was decided to try  $4\frac{1}{2}$ -in. (11 cm.) sleeves as well in a preliminary test as they would make a considerably lighter tube, which is very desirable.

For a preliminary test, two pyrometer tubes were made up, one with  $4\frac{1}{2}$ -in. sleeves and one with  $5\frac{1}{2}$ -in. sleeves. To fasten the graphite tip, which had a bayonet joint, to the 11-ft. drawn-steel pipe, an iron sleeve was made which would fit over the pipe and which had two lugs on it to fit the graphite tip. This sleeve was welded to the pipe and the tip fitted in place. The clay sleeves

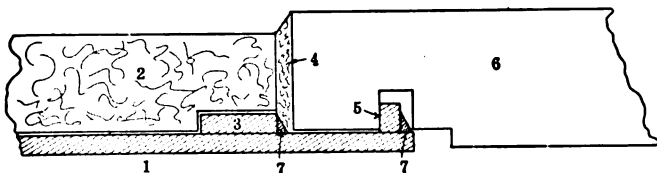

FIG. 3.—ARRANGEMENT OF TUBE FOR TAKING STEEL TEMPERATURES. 1. WROUGHT-IRON TUBE  $2\frac{3}{8}$ - $2\frac{1}{2}$  IN. OUTSIDE DIAMETER; 2. CERAMIC SLEEVE; 3. WROUGHT-IRON RING TO SUPPORT SLEEVE; 4. CLAY OR CEMENT; 5. WROUGHT-IRON LUGS 1 IN. LONG; 6. GRAPHITE TUBE; 7. WELD TO W.I. PIPE.

were then slipped on, the joint between the tip and the bottom sleeve being filled with asbestos rope and clay.

In order to handle the tube at the furnace, an iron sleeve with a ring

attached was slipped over the outside of the tube to a point about 8 ft. from the tip. A crane hook could be attached to this ring and the tube manipulated. For counterbalancing the tube, another ring was attached at the open end of the tube from which heavy chain links could be hung.

After the two tubes were made up, they were thoroughly dried, and, just before using, the tips were heated in a blacksmith's forge fire. It was decided to try the tube with the  $4\frac{1}{2}$ -in. sleeves first, so it was counterbalanced and put directly into a 75-T. acid open-hearth furnace. The tube was put through the door about 7 ft. and the opening covered with corrugated iron to protect the observers. Considerable smoke was forming in the tube, so a  $\frac{3}{4}$ -in. iron pipe connected to an air hose was pushed down the pyrometer tube and the smoke blown out; it reformed quite rapidly, however, so that to make an observation with the optical pyrometer, the air pipe was quickly withdrawn, and a quick reading made. This procedure was repeated a number of times, but the temperature read is questionable.

After the tube had been in the furnace 14 min., it was withdrawn and found to be in good condition and straight. It was laid on the floor and covered with sand to keep it from cooling too rapidly.

The tube with the  $5\frac{1}{2}$ -in. sleeves was not tried, as the end joint was not in good shape and we did not consider it necessary to try it after the result with the smaller sleeves, which are not so bulky and therefore easier to handle and more satisfactory.

After about 2 hr., the tube which had already had one trial, which we will designate as No. 1, was dug out of the sand for another test. This time a  $\frac{1}{4}$ -in. iron pipe was put inside the pyrometer tube and left in to be used in blowing out any smoke that might form. To do this, an air hose was held at intervals to the outside end of the pipe and the smoke cleared from the tube. This time the tube was left in the furnace 15 min. and a reading could be easily made as the smoke was kept clear. The tip appeared to come up to temperature in from 6 to 8 min. Directly after the tube was withdrawn from the furnace, the four or five clay sleeves on the hot end split lengthwise and dropped off, although the pipe remained straight. The reason for the splitting is probably as follows: The clay sleeves fitted very snugly on the steel pipe and when the tube was put in the furnace, the sleeves heated up and expanded but the heat did not penetrate to the steel tube. When the tube was covered with sand and allowed to lie covered for a few hours, the heat was equalized between the clay sleeves and the steel pipe. On putting the tube into the furnace the second time, the steel tube became much hotter than at first and expanded enough to split the sleeves. The remedy would be to have a slightly larger internal diameter for the clay sleeves.

The graphite tip of tube No. 1 was removed and found to be in good condition except for a few small cracks near the top.

It was thought possible that the source of the smoke in the tube was due to the asbestos rope in the joint next to the tip so two more tubes were prepared which we will designate as No. 3 and No. 4. No. 3 tube was made up in the same manner as No. 1 except that the joints were made without any asbestos and sodium silicate mixed with clay was used. No. 4 was the same as No. 3 but had clay only at the joints.

No. 3 and No. 4 tubes were made up and dried in the usual way and then subjected to a temperature of 1000° F. (538° C.) for 1 hr. to drive off any remaining volatile matter. Before being put into the furnace, the tubes were rested on a stand in front of the open-hearth door and the tip pushed against the open peephole. This brought it to a red heat in a few minutes. A  $\frac{1}{8}$ -in. (3.2 mm.) iron pipe was prepared to be used in blowing out smoke from the pyrometer tubes. This, being smaller than the  $\frac{1}{4}$ -in. pipe, did not obstruct the view down the tube so much. No. 3 tube was put into the furnace and left in 19 min., a number of readings being made during that time. The tube sagged slightly and smoke collected as badly as in No. 1 and had to be blown out.

No. 4 tube was put into the furnace right after No. 3 was withdrawn and left in 14 min., without sagging. Smoke also formed in this tube, but by blowing it out at intervals, readings could be made with ease. Slight explosions would occur in the tube when the air was blown in. This seems to point to a partial oxidation of the graphite tip due to the air in the tube. An inert or reducing gas such as nitrogen or hydrogen would probably do away with the smoke. It is probable that the smoke all comes from the graphite tip. After 2 hr., No. 4 tube was put into the furnace again for 12 min., and at the end of this time, the clay sleeves in the furnace started cracking off.

On taking the No. 3 tube out of the sand to put it into the furnace, it was found that a couple of the clay sleeves were cracked so that the tube could not be used. On using a tube for the second time, there is not so much smoke formed, the reason probably being that the graphite on the inside surface of the tip is oxidized at first, leaving a layer of clay which protects the graphite from further oxidation. If this is the case, it might be well to line the tip with clay in the first place or to burn it out by subjecting it to a high temperature.

A tabulation of the observations made in the tubes and in the furnaces and on the taps of different heats is here shown.

TEMPERATURES OF OPEN-HEARTH STEEL WITH PYROMETER TUBE AND  
 L. & N. OPTICAL PYROMETER

Heat No. 12/4104—Midvale Steel Co., 11/21/18.

| TIME                       | TEMP.,<br>DEGREES F. | REMARKS   |
|----------------------------|----------------------|---|
| 10:14                      |                      | No. 1 tube into furnace.  |
|                            | 2740?                | Readings in tube, smoky.  |
|                            | 2843?                | Snap readings taken after smoke<br>blown out.                           |
|                            | 2843?                |   |
|                            | 2842?                |   |
| 10:28                      |                      |   |
| 10:30                      |                      | Finals added.   |
|                            |                      | TAP   |
| 11:11:00                   | 2768?                | Steel stream, smoky.  |
|                            | 2835                 |   |
| 11:12:20                   | 2821                 |   |
|                            | 2805                 |   |
|                            | 2828                 |   |
| 13:45                      | 2821                 |   |
|                            | 2805                 |   |
| 14:15                      | 2805                 |   |
|                            | 2805                 |   |
| 14:50                      | 2813                 | Stream observed by sighting di-<br>rectly on it with optical pyrometer. |
|                            | 2813                 |   |
|                            | 2805                 |   |
| 15:20                      | 2805                 |   |
|                            | 2797                 |   |
| 16:10                      | 2797                 |   |
|                            | 2805                 |   |
| 16:45                      | 2797                 |   |
|                            | 2797                 |   |
| 17:25                      | 2807                 | First slag.   |
|                            | 2858                 | Slag.   |
| 11:17:18                   | 2858                 | Slag finish.  |
| No. 7 Furnace.             |                      |   |
| 12:00                      |                      | Charge melted.  |
| 12:10                      |                      | No. 1 tube in.  |
| 12:20                      | 2658                 | Reading in pyrometer tube.  |
|                            | 2658                 | End of tube approximately 8 in.<br>under slag surface.                  |
|                            | 2658                 |   |
| 12:25                      |                      | Tube out, sleeves cracked.  |
| Heat No. 8/5225, 11/22/18. |                      |   |
| 11:50                      |                      | No. 3 tube in.  |
|                            | 2606                 | Reading in tube.  |
| 11:56                      | 2645                 | Reading in tube.  |
|                            | 2645                 | Reading in tube.  |
| 12:02                      | 2678                 | Reading in tube.  |
| 12:04                      | 2937                 | Slag surface, flame on.   |
| 12:05                      | 2678                 | Tube reading.   |
| 12:08                      | 2678                 | Tube reading.   |
| 12:09                      |                      | Tube out, slightly bent.  |
| 12:15                      | 2917                 | Steel in spoon ( $e = 0.40$ ).  |

REPORT OF PYROMETER COMMITTEE

| TIME    | TEMP.      | REMARKS                         |
|---------|------------|---------------------------------|
|         | DEGREES F. |                                 |
|         | 2924       | Slag surface in furnace.        |
| 12:20   |            | No. 4 tube in.                  |
| 12:27   | 2534       | Reading in tube, smoky.         |
| 12:30   | 2672       | Reading in tube, smoky.         |
| 12:32   | 2672       | Reading in tube, smoky.         |
| 12:33   | 2672       | Tube out.                       |
| 12:34   | 2918       | Slag surface.                   |
| 2:18    | 2902       | Steel in spoon ( $e = 0.40$ ).  |
| 2:19    | 2942       | Slag surface.                   |
|         | 2910       | Steel in spoon ( $e = 0.40$ ).  |
| 2:37    |            | No. 4 tube in.                  |
| 2:42    | 2740       | Tube reading.                   |
| 2:44    | 2740       | Tube reading.                   |
| 2:45    |            | Sleeves cracked off in furnace. |
|         |            | TAP                             |
| 3:28    | 2902       |                                 |
|         | 2858       | Steel stream ( $e = 0.40$ ).    |
| 3:30:15 | 2843       |                                 |
|         | 2872       |                                 |
|         | 2834       |                                 |
| 3:31:30 | 2843       |                                 |
|         | 2851       |                                 |
|         | 2843       |                                 |
|         | 2843       |                                 |
| 3:33:15 | 2833       | Slag stream ( $e = 0.65$ )      |
|         | 2900       | Slag stream finish.             |

To attempt to overcome the smoke difficulties and to ascertain if the inside of the graphite tip actually comes to the temperature of the steel bath, four more tubes were made up as follows:

No. 5.—Tip baked in a crucible furnace until outside surface was glazed. Inside glazed with oxyhydrogen torch.

No. 6.—Tip glazed inside with oxyhydrogen torch.

No. 7.—Tip machined to  $\frac{5}{16}$  in. wall from  $\frac{1}{2}$  in. Burnt in crucible furnace and glazed inside with oxyhydrogen torch.

No. 8.—Tip burnt in crucible furnace. Inside untouched. Nos. 5 and 7 tubes were made up with sodium silicate and clay and 6 and 8 with plain clay.

On Nov. 27, 1918, the tubes were tested with the following results:

Tube No. 5 was prepared and put into an acid open hearth after pre-heating the tip. Fumes appeared and were blown out and one reading was made before the tip came up to temperature. After 10 min. the tip broke and the tube was withdrawn.

Tube No. 7 with the thin tip was then put into the open hearth and a clear reading was made after the tube had been in 4 min. After 5 min. the tip broke and the tube had to be withdrawn.

It was thought possible that the reason for the failure of the first two tips was partly a rapid oxidation of the graphite, due to the stream of

air from the  $\frac{1}{8}$ -in. iron pipe, so a tank of hydrogen was secured and a hose attached.

Tube No. 6 was laid before the open-hearth door with the tip tilted up and the hydrogen run in through the small iron pipe. The open end was then plugged with asbestos wool and a small amount of hydrogen kept flowing into the tube while it was being inserted into the steel bath. Heavy smoke and steam were observed coming out of the tube and no readings could be made. As it was not considered safe to try to blow the fumes and gas out with air, the tube was taken out of the furnace.

Tube No. 8, the tip of which had been baked in a crucible furnace but which had not been glazed inside with the oxyhydrogen torch, was finally warmed up and put into the furnace and a temperature observation on the surface of the slag made directly afterward. When the tube had been in 6 min., a reading was made, after blowing out, with air, the smoke which had formed. This temperature remained constant for a number of readings afterward showing that the tip was up to temperature after 6 min. There was comparatively little smoke in this tip and it was easy to keep the tube clear by blowing air in at intervals.

Readings made by two observers checked to 17° F. (9° C.). After the tube had been in the furnace 15 min., it was withdrawn and found to be in good condition. Directly after the removal of the pyrometer

TEMPERATURE OF OPEN-HEARTH STEEL WITH PYROMETER TUBE  
 AND L. & N. OPTICAL PYROMETER

Heat No. 7/5186, Nov. 27, 1918.

| TIME  | TEMP.,<br>DEGREES F. | REMARKS                                  |
|-------|----------------------|--|
| 12:19 |                      | Tube No. 5 in.                           |
| 12:24 | 2606                 | In tube, air blowing during reading.     |
| 12:25 | 2830                 | Under flames on slag surface.            |
| 12:29 |                      | Tip broke.                               |
| 12:44 |                      | Tube No. 7 in.                           |
| 12:48 | 2747                 | In tube, no smoke.                       |
|       | 2893                 | On slag surface, no flame.               |
| 2:08  |                      | Tube No. 6 in., flowing hydrogen, smoke. |
| 2:18  |                      | Tube out.                                |
| 2:23  |                      | Tube No. 8 in.                           |
|       | 2942                 | On slag surface.                         |
| 2:29  | 2697                 | In tube, smoke blown out.                |
| 2:31  | 2697                 | In tube.                                 |
| 2:32  | 2697                 | In tube.                                 |
| 2:33  | 2697                 | In tube.                                 |
| 2:35  | 2714                 | In tube.                                 |
| 2:37  | 2703                 | In tube.                                 |
| 2:39  | 2948                 | On slag surface.                         |
| 2:40  | 2677                 | Stream from spoon ( $e=0.40$ ).          |

tube, a spoon of steel was taken from the bath for a sample and a reading made on the stream. The temperature read was corrected for emissivity of 0.40 and found to be somewhat lower than that read in the tube, as would be expected. The temperature observations made during this test are shown on page 19.

From the experience with the graphite tips and the trouble with the smoke, the sub-committee decided that it would be desirable to try clay tips on the pyrometer tubes, as the clay appears to stand sudden immersion in the steel and the corrosive effect of the slag. A design was made showing the thin portion of the tip an inch longer and the Joseph Dixon Co. agreed to make up a number of tips for another trial.

*Conclusions*

Open-hearth steel temperatures can be taken with a tube similar to the one used in our experiments, though it is a difficult matter to handle the tube and protect the operators.

With a graphite tip some trouble is experienced with smoke which at times makes the readings questionable. This would possibly be eliminated by a clay tip if that should prove satisfactory in other respects.

SECOND REPORT OF SUB-COMMITTEE ON OPEN-HEARTH PYROMETER

*Temperature Measurements on Open-hearth Steel*

Temperature data were taken of two steel heats of the following composition, Midvale—Feb. 12, 1919:

| Heat No. 8—5317 |               | Heat No. 11—5204 |              |
|-----------------|---------------|------------------|--------------|
| C..... 0.490    | S..... 0.038  | C..... 0.60      | Ni..... 3.50 |
| Mn..... 0.650   | Si..... 0.230 | Mn..... 0.26     | Cr..... 2.25 |
| P..... 0.038    | Ni..... 3.000 | Si..... 0.23     |              |

*Data*

Furnace No. 8, Heat No. 5317.

Three tubes, with clay tips made by Joseph Dixon Co., were put in the furnace; the tips cracked off in each case, the break occurring in two cases at the junction of the thin and thick sections of the tip.

*Temperature Observations*

TEMP.  
 DEGREES F.  
 2931  
 2893

REMARKS

Slag surface 1:35 P. M.  
 Stream from small spoon in furnace. About 3 ft. in from door. Door open about 18 in. Stream appeared much darker than background of flame. No correction for emissivity—2:05 P. M.

| TEMP.,<br>DEGREES F. | REMARKS   |
|----------------------|---|
| 3015.                | Slag surface 2:09 P. M.<br>Door opened at 2:13 to warm up tube.   |
| 2885                 | Slag surface 2:15 P. M.   |
| 2893                 | Stream from small spoon in furnace—Reading made on second dip. No correction.                               |
| 2714                 | Slag surface—about 3:00 P. M.   |
| 2753                 | Stream of slag from large spoon in furnace uncorrected—4th dip.   |
| 2866                 | Above corrected for $e = 0.65$ .  |
| 2830                 | Stream of steel from small spoon in furnace—uncorrected. Good reading.                                      |
| 3092                 | Above corrected for $e = 0.40$ .  |
| 2805                 | Stream from small spoon into mold corrected for $e = 0.40$ —Approximately 12 sec. after spoon left furnace. |

A number of small spoons of metal were taken from the furnace and poured onto the floor at different intervals of time between lifting the spoon clear of the bath and pouring it. A cold spoon was taken in each case. The first set was made about 3:30 P. M. and the second set about 4:00 P. M.

| FIRST SET  |  | SECOND SET |                   |
|------------|--|------------|-------------------|
| DEGREES F. |  | DEGREES F. |                   |
| 1. 2805    | 16 sec. time; $e = 0.40$ .                         | 1.         | 5 sec. to brick.  |
| 2.         | 6 sec. from furnace to brick where it was skimmed. |            | 6½ sec. to read.  |
|            | 10 sec. on brick.                                  | 2790       | 11½ sec. total.   |
|            | 7½ sec. to read.                                   | 2.         | 5 sec. to brick.  |
| 3. 2768    | 23½ sec. total $e = 0.40$ .                        |            | 10 sec. on brick. |
|            | 6 sec. to brick.                                   | 2730       | 21 sec. total.    |
|            | 15 sec. on brick.                                  | 3.         | 5 sec. to brick.  |
|            | 6 sec. to read.                                    |            | 15 sec. on brick. |
| 4. 2713    | 27 sec. total; $e = 0.40$ .                        |            | 5 sec. to read.   |
|            | 5 sec. to brick.                                   | 2705       | 25 sec. total.    |
|            | 7½ sec. to read.                                   | 4.         | 5 sec. to brick.  |
| 2797       | 12¾ sec. total.                                    |            | 5 sec. on brick.  |
|            |  |            | 3 sec. to read.   |
|            |  | 2821       | 13 sec. total.    |

Two tests were made by spooning out a test spoon, clearing it of slag and then making readings at intervals on the surface of the steel until it froze over. Time was counted from lifting the spoon from the bath.

| TEMP.,<br>DEGREES F. | TIME,<br>SECONDS | TEMP.,<br>DEGREES F. | TIME,<br>SECONDS | TEMP.,<br>DEGREES F. | TIME,<br>SECONDS |
|----------------------|------------------|----------------------|------------------|----------------------|------------------|
| 2790                 | 15½              | 2813                 | 13               | 2672                 | 42               |
| 2768                 | 26               | 2768.                | 20½              | 2638                 | 51               |
| 2705                 | 33               | 2737                 | 29½              |                      |                  |
| 2689                 | 44               | 2721                 | 35               |                      |                  |
| 2629                 | 55               |                      |                  |                      |                  |



Immediately after these two tests, a reading on the stream from a small spoon in the furnace and slag readings were made.

| TEMP.,<br>DEGREES F. | REMARKS   |
|----------------------|---|
| 2796                 | Stream from small spoon; no correction.                   |
| 2913                 | Stream from small spoon; slag correction ( $e = 0.65$ ).  |
| 3053                 | Stream from small spoon; steel correction ( $e = 0.40$ ). |
| 2783                 | Stream from small spoon; no correction.                   |
| 2900                 | Stream from small spoon; slag correction ( $e = 0.65$ ).  |
| 3040                 | Stream from small spoon; steel correction ( $e = 0.40$ ). |
| 2772                 | Slag surface; cooled by open door.                        |
| 2818                 | Slag surface; 8 min. after door closed.                   |

Furnace No. 11, Melt No. 5204. Chrome-nickel Steel.

|      |  |
|------|--|
| 2761 | Stream from spoon into mold ( $e = 0.40$ ).  |
| 2937 | Stream from small spoon in furnace, no correction.   |
| 2813 | Slag surface in furnace; cooled.   |
| 2843 | Slag surface 5 min. after previous reading.  |
| 2931 | Stream from small spoon in furnace, no correction.   |
| 2835 | Stream from small spoon into mold ( $e = 0.40$ ).  |
| 2824 | Slag stream from large spoon in furnace; uncorrected.  |
| 2942 | Above corrected for slag ( $e = 0.65$ ). Approximately $1\frac{1}{2}$ hr. later the following readings were taken 5 min. before the tap. |
| 2772 | Stream from small spoon in furnace; uncorrected.   |
| 2887 | Above corrected for $e = 0.65$ .   |
| 3025 | Above corrected for $e = 0.40$ .   |
| 2778 | Stream from small spoon in furnace. Second dip, uncorrected.   |
| 2894 | Above corrected for $e = 0.65$ .   |
| 3033 | Above corrected for $e = 0.40$ .   |
| 2887 | Slag surface, door shut.   |

|                      |                               | TAP                  |                               |
|----------------------|-------------------------------|----------------------|-------------------------------|
| TEMP.,<br>DEGREES F. | TIME FROM BEGINNING<br>OF TAP | TEMP.,<br>DEGREES F. | TIME FROM BEGINNING<br>OF TAP |
| 2805                 | 30 sec.—Steel stream.         | 2775                 | 2 min. 25 sec.                |
| 2782                 | 39 sec.                       | 2782                 | 2 min. 47 sec.                |
| 2768                 | 57 sec.                       | 2768                 | 3 min. 7 sec.                 |
| 2761                 | 1 min. 15 sec.                | 2790                 | 3 min. 27 sec.                |
| 2775                 | 1 min. 30 sec.                | 2742                 | Slag stream.                  |
| 2782                 | 1 min. 54 sec.                | 2638                 | First ingot.                  |
| 2790                 | 2 min. 5 sec.                 |                      |                               |

From the data, it appears that the readings on the stream from a spoon in the furnace should have some emissivity correction, although smaller than for a steel stream in the open. This will have to be checked up by further tests. Until temperature measurements can be made with black-body conditions, nothing definite can be said or proved as to actual temperatures.

The whole matter is up to the ceramic men of the Committee to develop a material suitable for a tip. Clay is satisfactory from a composition standpoint and, if made so that it will stand unequal rapid heat-

ing, could be used for tips that would not smoke and would take the furnace temperature.

### THIRD REPORT OF SUB-COMMITTEE ON OPEN-HEARTH PYROMETER, ELECTRIC-FURNACE AND MISCELLANEOUS TEMPERATURES

In view of the difficulties in making experiments in open-hearth furnaces, the sub-committee decided to make further tests in electric furnaces.

A number of steel tubes  $2\frac{1}{4}$  in. (5.7 cm.) outside diameter and about 5 ft. (1.5 m.) long were prepared with small lugs on the end as shown in Fig. 4. A number of end sleeves with grooves in them to fit the lugs were prepared by Hiram Swank's Sons and tubes for tips were secured, made from different materials.

The first test on an electric furnace was made at the Taylor Wharton Iron & Steel Co. at High Bridge, N. J. Pyrometer tubes having tips of carborundum and clay were prepared and after preheating were each put

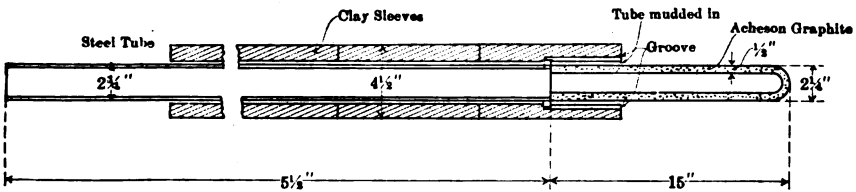

FIG. 4.—ACHESON GRAPHITE MOUNTING.

into the steel in the furnace, which was a 3-ton basic Heroult. Each tube broke before coming to temperature and both were very badly corroded by the slag.

Tapping and teeming temperatures were taken on a number of heats and, just before one tap, four spoons full of steel were dipped out; the spoon in each case was set on the floor and readings made on the steel surface until it crusted over. The values obtained were plotted against time and curves drawn as shown in Fig. 5.

Optical pyrometer readings were also made on the flame from a Bessemer converter and the apparent temperatures obtained are given in the accompanying tabulation of data made at High Bridge.

Fig. 5 shows four cooling curves for four spoons of steel which were dipped out of the electric furnace within a few minutes of each other, just before the tap. Since there were only a few points taken on each spoon through which a number of different shapes of curves might have been drawn, the nature of cooling of a spoonful of steel was considered.

REPORT OF PYROMETER COMMITTEE

TEMPERATURE DATA AT TAYLOR WHARTON IRON & STEEL CO

APR. 22, 1919

Tapping 3-ton Basic Electric Furnace Carbon Steel for Castings

| TIME       | TEMP., DEGREES F.* | REMARKS    |
|------------|--------------------|------------|
| 4:18 P. M. | 2932               | Tap steel. |
|            | 2910               | Tap steel. |
|            | 2895               | Tap steel. |

TEEMING

| TIME   | TEMP., DEGREES F.* | REMARKS          | TIME   | TEMP., DEGREES F.* | REMARKS                |
|--------|--------------------|------------------|--------|--------------------|------------------------|
| 4:23   | 2797               | 1st shank        | 4:31.7 | 2720               | 2d mold.               |
| 4:24   | 2790               | 2d shank         | 4:32   | 2704               | 2d mold.               |
| 4:26   | 2872               | 3d shank         | 4:32.5 | 2688               | 2d mold small stream.  |
| 4:26.5 | 2656               | Pouring 3d shank | 4:33   | 2697               | 3d mold.               |
| 4:27   | 2782               | 4th shank        | 4:33.5 | 2704               | 4th mold.              |
| 4:29   | 2775               | 5th shank        | 4:34   | 2656               | 5th mold small stream. |
| 4:30   | 2761               | 1st mold         | 4:35   | 2713               | Riser of 2d mold.      |
| 4:31   | 2704               | 2d mold          | 4:36   | 2680               | 7th mold, last.]       |
| 4:31.5 | 2730               | 2d mold          |        |                    |                        |

PULLING SLAG

| TIME       | TEMP., DEGREES F. | REMARKS                             |
|------------|-------------------|-------------------------------------|
| 9:58 A. M. | 2638              | Stream from spoon into sample mold. |
| 10:14      | 2712              | On slag ( $e = 0.65$ ).             |
|            | 2902              | On metal (oxidized) ( $e = 0.40$ ). |
|            | 2917              | On metal (oxidized) ( $e = 0.40$ ). |
|            | 2828              | On metal dark streak, some smoke.   |
| 10:16      | 2887              | On metal oxidized.                  |
|            | 2895              | On metal oxidized.                  |

READINGS ON SPOON

| TIME FROM LIFTING FROM SLAG—11:24 A. M. | TEMP., DEGREES F. | REMARKS                 |
|---|-------------------|-------------------------|
| 4 sec.                                  |                   | To floor.               |
| 12 sec.                                 | 2968              | Spoon surface.          |
| 19.5 sec.                               | 2895              | Spoon surface.          |
| 27.5 sec.                               | 2813              | Spoon surface.          |
| 37 sec.                                 | 2790              | Spoon surface.          |
| 46 sec.                                 |                   | Spoon surface oxidized. |

TAPPING CARBON STEEL FOR CASTINGS

Started to tap 11:26 A. M.

| TIME FROM       | TEMP. | REMARKS                         |
|-----------------|-------|---------------------------------|
| 17 sec.         | 2960  |                                 |
| 28 sec.         | 2920  | On slag.                        |
| 46 sec.         | 2982  |                                 |
| 64 sec.         | 2952  |                                 |
| 2 min. 30 sec.  |       | Started to skim.                |
| 3 min. 45 sec.  |       | Finished skimming.              |
| 4 min. 45 sec.  |       | Finished weighing.              |
| 5 min. 22 sec.  | 2887  | 1st shank.                      |
| 7 min. 30 sec.  | 2865  | 2d shank.                       |
| 8 min. 20 sec.  | 2821  | Pouring 2d shank in small mold. |
| 9 min. 13 sec.  | 2835  | 3d shank.                       |
| 9 min. 53 sec.  | 2797  | Pouring 3d shank into mold.     |
| 10 min. 9 sec.  | 2797  | Pouring 3d shank into mold.     |
| 10 min. 46 sec. | 2828  | 4th shank.                      |
| 11 min. 5 sec.  | 2782  | Pouring 4th shank into mold.    |
| 11 min. 43 sec. | 2775  | Pouring 4th shank into mold.    |

\* All readings on steel streams corrected for an emissivity of 0.40 and slag for 0.65.

GEORGE K. BURGESS.

| TIME            | TEMP., DEGREES F. | REMARKS                           |
|-----------------|-------------------|-----------------------------------|
| 12 min. 10 sec. | 2835              | 5th shank.                        |
| 12 min. 35 sec. | 2761              | Pouring 5th shank.                |
| 13 min. 59 sec. | 2775              | Pouring from ladle into 1st mold. |
| 14 min. 41 sec. | 2730              | Pouring from ladle into 2d mold.  |
| 15 min. 15 sec. | 2688              | 3d mold, small stream.            |
| 16 min. 3 sec.  | 2782              | 4th mold, large stream.           |
| 16 min. 21 sec. | 2768              | 4th mold.                         |
| 16 min. 41 sec. | 2761              | 4th mold.                         |
| 16 min. 52 sec. | 2753              | 4th mold.                         |
| 17 min. 12 sec. | 2761              | 4th mold (oxidized stream).       |
| 18 min. 19 sec. | 2753              | 5th mold.                         |
| 20 min. 3 sec.  | 2797              | 6th mold (oxidized stream).       |
| 21 min. 2 sec.  | 2745              | 7th mold.                         |

3-TON ACID BESSEMER FURNACE

2:07 P. M. 2433. Charging on stream

| TIME AFTER START OF BLOW | TEMP., DEGREES F. | REMARKS                                     |
|--------------------------|-------------------|---|
| 2 min. 50 sec.           | 2574              | Flame of Bessemer.                          |
| 3 min. 10 sec.           | 2632              | Flame of Bessemer.                          |
| 3 min. 37 sec.           | 2722              | Flame of Bessemer.                          |
| 4 min. 10 sec.           | 2824              | Flame of Bessemer.                          |
| 5 min. 12 sec.           | 2860              | Flame of Bessemer.                          |
| 6 min. 43 sec.           | 2747              | Flame of Bessemer.                          |
| 7 min. 18 sec.           | 2752              | Flame of Bessemer.                          |
| 8 min. 0 sec.            | 2527              | Started to pour ferromanganese into ladle.  |
| 9 min. 22 sec.           | 3060              | Poured Bessemer charge into ferromanganese. |
| 11 min. 53 sec.          |                   | Finished pouring.                           |

SPOONS FROM ELECTRIC FURNACE (MANGANESE STEEL MELTED SCRAP)

Test started 2:42 P. M.

1ST SPOON

| TIME    | TEMP., DEGREES F. | REMARKS                       |
|---------|-------------------|-------------------------------|
| 0 sec.  |                   | Just lifted spoon from metal. |
| 10 sec. | 2790              | Steel surface.                |
| 18 sec. | 2637              | Steel surface.                |
| 23 sec. | 2603              | Steel surface.                |
| 33 sec. | 2456 no cor.      | Steel surface oxide.          |

2D SPOON

|         |      |                         |
|---------|------|-------------------------|
| 0 sec.  |      | Just in furnace.        |
| 19 sec. |      | Just lifted from metal. |
| 24 sec. |      | On floor.               |
| 34 sec. | 2775 | Steel surface.          |
| 45 sec. | 2745 | Steel surface.          |
| 50 sec. | 2672 | Steel surface.          |
| 52 sec. | 2603 | Steel surface.          |
| 68 sec. | 2471 | Steel surface oxide.    |

REPORT OF PYROMETER COMMITTEE

3D SPOON

| TIME    | TEMP., DEGREES F. | REMARKS               |
|---------|-------------------|-----------------------|
| 0 sec.  |                   | Just dipped in metal. |
| 15 sec. |                   | Just lifted out.      |
| 19 sec. |                   | On floor.             |
| 25 sec. | 2775              | Steel surface.        |
| 31 sec. | 2680              | Steel surface.        |
| 34 sec. | 2629              | Steel surface.        |
| 46 sec. | 2566              | Steel surface dirty.  |

4TH SPOON

|         |      |  |
|---------|------|--|
| 0 sec.  |      | In metal.  |
| 19 sec. |      | Out.   |
| 22 sec. |      | On floor.  |
| 29 sec. | 2821 | Spoon surface.                                     |
| 36 sec. | 2721 | Spoon surface.                                     |
| 45 sec. | 2745 | Spoon surface.                                     |
| 53 sec. | 2556 | Spoon surface.                                     |
|         | 2796 | Flame of 2d Bessemer.                              |
|         | 2843 | Flame of 2d Bessemer.                              |
|         | 2758 | Flame of 2d Bessemer.                              |
|         | 3100 | Pouring into ladle (bright streak). ( $e = 0.40$ ) |
|         | 2895 | On dark streak.                                    |

TAPPING MANGANESE STEEL

| TIME FROM START OF TAP | TEMP., DEGREES F. | REMARKS       |
|------------------------|-------------------|---------------|
| 15 sec.                | 3053              | Steel stream. |
| 34 sec.                | 3025              | Steel stream. |
| 52 sec.                | 3025              | Steel stream. |
| 1 min. 14 sec.         | 3037              | Steel stream. |
| 1 min. 38 sec.         | 3025              | Steel stream. |

There are three factors which enter into the cooling of a hot body—radiation, conduction and convection. Of these the effect of radiation is much greater than conduction or convection at the temperature of molten steel, so that the shape of the cooling curve must be largely influenced by the fourth-power radiation law and approach that of an exponential curve.

In the operation of dipping out a spoonful of steel and bringing it out into the room to cool, there are a number of conditions which may affect the rate of cooling of the steel. The spoon is first dipped into the slag and turned over a number of times to get a good slag coating on it. This operation may take from 10 to 30 sec. depending on conditions and the skill of the operator. The spoon in this operation is heated up considerably and may become so hot that the handle will bend on lifting out the spoonful of metal. When the spoon is sufficiently "slagged," it is dipped into the steel and a spoonful lifted out. The steel in the spoon immediately begins to cool, as there is at least 1000° F. (555° C.) difference between the spoon and steel temperatures, but since the temperatures of the furnace gases are about that of the steel and a third of the total

area bounding the steel in the spoon is exposed to them, the cooling of the molten steel is probably not very rapid while in the furnace. As soon as the spoon passes the furnace door, however, there is an abrupt change of cooling and the rate must be largely exponential in character.

Curves 1 and 3, the cooling curves for two spoons of steel taken out of the furnace under identical conditions, are of the nature of exponential curves. The part of the curves from the point where the spoon passed through the door to the first reading is guessed at, as is the cooling curve in the furnace. The steel temperature is taken as the average of the readings made on the tapping stream.

Curve 4 is clearly defined; curve 2 is rather poor but it was drawn to be as nearly like the others as possible and still conform to the points.

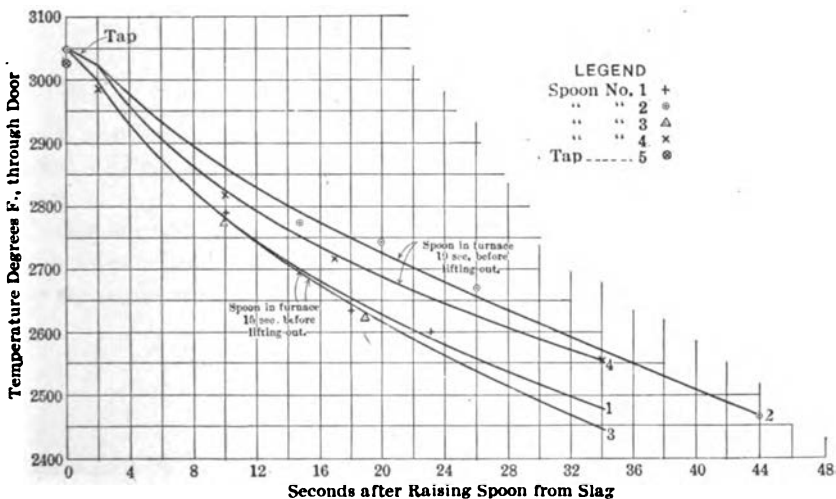

FIG. 5.—TEMPERATURE MEASUREMENTS ON SURFACE OF MANGANESE STEEL SPOONED FROM ELECTRIC FURNACE.

An attempt will be made to get points nearer to zero time in the near future.

After the failure of the clay and carborundum tubes in the basic furnace, a test was planned in the acid furnace at Lebanon, Pa., but since they were not in operation at the time, two tubes were prepared with Acheson graphite tips and a test was made at the Disston Saw Works in Philadelphia, in a 3-ton basic Heroult furnace.

The first tube was put in without preheating, and the end sleeve cracked almost immediately, due to too sudden heating. The other tube was preheated and pushed into the steel. It did not smoke and came to temperature in 70 sec., at which time a very satisfactory reading was obtained. About an hour later the same tube was put into the furnace again and another reading taken. This time, however, part of the end

clay sleeve broke off so that the graphite tube was not held in line but was at an angle to the axis of the steel tube. For this reason the optical reading could not be made on the end. The sight was taken on the side of the tube and a reading was made after it had come up to temperature and remained constant for a minute. This reading was probably very near the true temperature but it is not put on the curve as it is somewhat questionable.

After each time that the tube was put in the furnace, it was withdrawn and readings made on the graphite tip and the time noted. These curves are shown in Fig. 6. It will be noted that a smooth curve can be readily drawn through the points. The furnace was tapped about 15 min. after

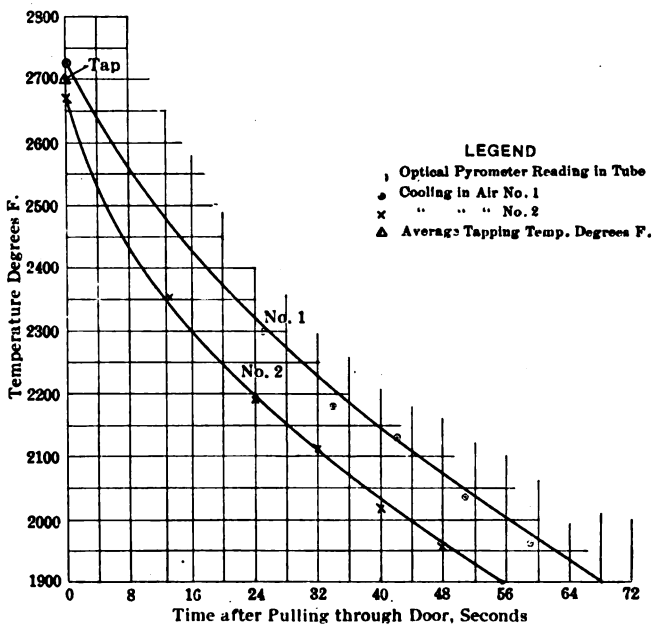

FIG. 6.—COOLING CURVES FOR GRAPHITE TUBES AFTER IMMERSION IN STEEL.

the last tube was put in, and in the intervening time, the steel was heated somewhat. The tapping temperature is 25° F. (13.8° C.) above the extrapolated curve for tube No. 2.

The data taken on this test are as follows:

TEST AT DISSTON SAW WORKS (JUNE 16, 1919)

3-Ton Basic Heroult Furnace

First tube in, the end sleeve broke due to sudden heating. Second tube came to temperature after 70 sec.; reading, 2728° F. (1497° C.). The tube was pulled from the furnace and readings made on its end while it cooled. Time taken from passing through door.

| TIME    | TEMP.,<br>DEGREES F. | REMARKS          | TIME    | TEMP.,<br>DEGREES F. | REMARKS         |
|---------|----------------------|------------------|---------|----------------------|-----------------|
| 0       | ....                 | Out door.        | 42 sec. | 2130                 | On end of tube. |
| 14 sec. | 2380                 | On side of tube. | 51 sec. | 2032                 | On end of tube. |
| 25 sec. | 2298                 | On end of tube.  | 59 sec. | 1964                 | On end of tube. |
| 34 sec. | 2185                 | On end of tube.  |         |                      |                 |

The same tube was put in later. The end sleeve cracked but the tube was held partly under the steel and was at an angle to the sight tube so the readings were made on a point about 9 in. from the end. The temperatures gradually increased to a steady value after 2 min. 30 sec. Reading, 2672° F. (1467° C.)

The graphite tube was pulled out in a shovel and laid on the floor where readings were made on it at different times as follows:

| TIME | TEMP.,<br>DEGREES F. | REMARKS   | TIME | TEMP.,<br>DEGREES F. | REMARKS  |
|------|----------------------|-----------|------|----------------------|----------|
| 0    | ....                 | Out door. | 32   | 2110                 | On tube. |
| 13   | 2355                 | On tube.  | 40   | 2021                 | On tube. |
| 24   | 2193                 | On tube.  | 48   | 1964                 | On tube. |

A number of readings were attempted on the spoon surfaces but the metal chilled over almost immediately after the spoon was set on the floor.

Tap started 16 min. after the tube was put in, the steel being heated up between times for a period of about 7 min. Tapping and teeming temperatures were as follows:

| TAP    |                      |                  |
|--------|----------------------|------------------|
| TIME   | TEMP.,<br>DEGREES F. | REMARKS          |
| 0      | 2688                 | On steel stream. |
|        | 2713                 | On steel stream. |
|        | 2697                 | On steel stream. |
| 1 min. | 2697                 | On steel stream. |

TEEM

| TIME           | TEMP.,<br>DEGREES F. | REMARKS    | TIME            | TEMP.,<br>DEGREES F. | REMARKS          |
|----------------|----------------------|------------|-----------------|----------------------|------------------|
| 2 min. 10 sec. | 2656                 | 1st ingot. | 12 min. 30 sec. | 2576                 | 12th ingot       |
| 3 min. 8 sec.  | 2647                 | 2d ingot.  | 13 min. 30 sec. | 2566                 | 13th ingot.      |
| 3 min. 58 sec. | 2637                 | 3d ingot.  | 17 min. 00 sec. | 2556                 | 16th ingot last. |
| 8 min. 20 sec. | 2595                 | 8th ingot. |                 |                      |                  |

Carbon was about 1.35 per cent. Ingots weighed 470 lb. each.

Two more tubes were prepared with the same graphite tips which had been previously used. One tube was put into the furnace and a very good reading was made. The tube did not smoke in the least and was very satisfactory. After the reading was taken, the end clay sleeve broke off but the graphite tip was pulled out quickly and readings made on it as in the previous test. The points are plotted in Fig. 7.

The second tube had not been thoroughly dried out and had steam in it, so that although a reading was made while the steam was blown out,



REPORT OF PYROMETER COMMITTEE

it is somewhat questionable. A cooling curve was also taken on this graphite tip and is shown as curve No. 2 on Fig. 7. It will be noted how closely the extrapolated curves come to the readings made in the tube. In no case is the difference greater than 20° F. (11° C.). It was not possible to lift the tube above the bath and take a reading on the outside of the graphite tip in the furnace because the smoke was too heavy.

The clay end sleeves that were used in these tests were overheated in making and were not as strong as the regular stopper rod sleeves. For this reason most of them cracked after being in the furnace a short time. The temperature data on this test are given here.

| TIME                  | TEMP.,<br>DEGREES F. | REMARKS  |
|-----------------------|----------------------|--|
| 9:14 A. M.            | 2753                 | Reading in 1st tube.   |
| 0 sec.                |                      | Tube No. 1 through door. Arc off.                            |
| 9.4                   | 2574                 | On graphite tip in air.                                      |
| 18.8                  | 2411                 |  |
| 27.4                  | 2254                 |  |
| 35.0                  | 2157                 |  |
| 45.6                  | 2032                 |  |
| 54.0                  | 1943                 |  |
| 9:28 A. M.            | 2703                 | Reading on slag in furnace. Arc on.                          |
| 9:29 A. M.            |                      | Made new slag, spar and lime.                                |
| 10:10 A. M.           | 2836(?)              | Reading in tube. Air blowing out steam.                      |
| 0 sec.                |                      | Tube No. 2 through door.                                     |
| 8.4                   | 2567                 | Reading on graphite tube in air.                             |
| 16.6                  | 2478                 |  |
| 25.0                  | 2347                 |  |
| 33.0                  | 2203(?)              |  |
| 40.0                  | 2082                 |  |
| 47.0                  | 2053                 |  |
| 54.8                  | 1964                 |  |
| 10:25 A. M.           | 2807                 | Slag in furnace—door open, corrected for $\epsilon = 0.65$ . |
| 10:25:30 A. M.        |                      | Start to tap.  |
| 7 sec.                | 2775                 | Tap.   |
| 22                    | 2768                 |  |
| 31                    | 2768                 |  |
| 44                    | 2775                 |  |
| 60                    | 2768                 |  |
| 72                    | 2768                 |  |
| 83                    | 2768                 |  |
| 108                   | 2761                 |  |
| 10:27:35 A. M.        |                      | Finish tap.  |
| Held 5 min. in ladle. |                      |  |

| TIME FROM<br>START OF<br>TEEM | TEMP.,<br>DEGREES F. | REMARKS    | TIME FROM<br>START OF<br>TEEM | TEMP.,<br>DEGREES F. | REMARKS     |
|-------------------------------|----------------------|------------|-------------------------------|----------------------|-------------|
| 30 sec.                       | 2656                 | 1st ingot. | 8:00                          | 2602                 | 10th ingot. |
| 1:30                          | 2647                 | 2d ingot.  | 10:45                         | 2595                 | 12th ingot. |
| 3:00                          | 2629                 | 4th ingot. | 12:45                         | 2576                 | 14th ingot. |
| 4:40                          | 2620                 | 6th ingot. | 13:05                         | 2566                 | 16th ingot  |
| 6:15                          | 2611                 | 8th ingot. |                               |                      | last.       |

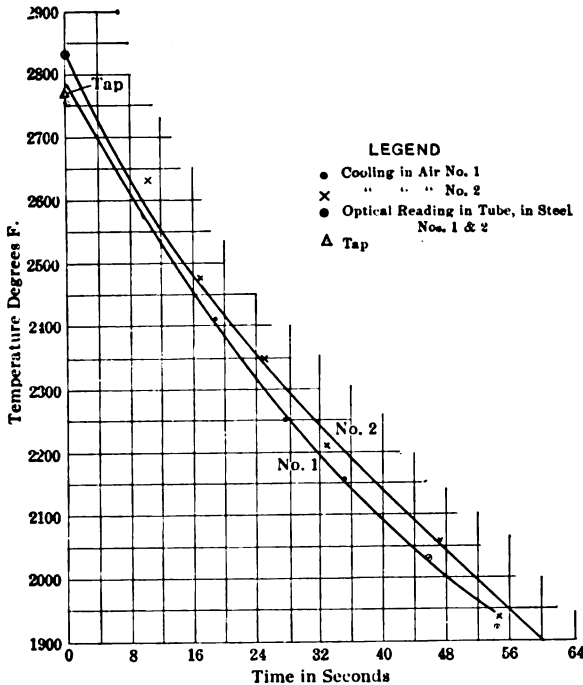

FIG. 7.—COOLING CURVES FOR GRAPHITE TUBES AFTER IMMERSION IN STEEL IN HEROULT FURNACE.

### CONCLUSIONS OF SUB-COMMITTEE

Acheson graphite is a very satisfactory material for a tube to use in steel. It does not smoke, only oxidizes slowly, and has plenty of strength. One tube with  $\frac{1}{2}$ -in. wall which was immersed five times and allowed to cool in air appeared to have lost only a small amount in diameter. Another advantage is that the slag does not stick to it, and optical readings may be made on it as soon as it is lifted from the bath.

Steel temperatures may be taken by allowing a tube of Acheson graphite to come to the temperature of the bath and then either sighting on the tube when it is raised above the bath or pulling it out into the air and taking the cooling curve and extrapolating to zero time. Temperatures may also be taken by sighting down the tube. In an open hearth it would probably be easier to use the graphite as a target.

### PROJECTED EXPERIMENTS AND SUMMARY

The use of Acheson graphite, either in block or tube form, as a target after immersion to the desired depth and location in the metal bath and sighted upon by the optical pyrometer, as shown by the experiments of the sub-committee, gives promise of being a serviceable method of tem-

perature control. This graphite has the advantage of remaining clear of slag and, in addition, the optical pyrometer requires no correction when sighted on graphite whether within the furnace or not. More observations, however, should be taken by this method to more completely determine its limitations.

Another method suggested, which has been used by Dr. Northrup with small laboratory furnaces and which the Committee expects to try out, is to thrust a quartz-glass rod or thick-walled closed-end tube into the bath to the depth at which the temperature is wanted, and sight in the outer end of the rod with an optical pyrometer. The light being totally reflected along the quartz—which may even bend considerably without loss of light—temperatures not requiring any appreciable correction should be given by this method. The quartz will probably not last very long, especially in basic practice, but it will probably be found unnecessary to leave the quartz immersed more than a fraction of a minute in order to take a satisfactory observation. If held too long in the bath, of course the quartz will melt, but on account of its transparency it should be possible to obtain a reliable observation before this happens.

The work of the Committee has shown the very great practical difficulties which obtain with available refractories when attempt is made to sight down a tube thus protected. The best material thus far found for this purpose is an Acheson graphite tube supported and extended by a steel tube which is in turn protected by a fireclay sleeve. All other refractories tried are unsuited for the purpose.

When care is exercised, it has been shown by the Committee that the method of spooning out metal and taking simultaneous observations of time and temperature will give reliable results.

The modifications suggested by Mr. Drinker, in the hands of the Committee, do not give dependable results.

## APPENDIX

### REPORT OF SUB-COMMITTEE

#### *Test on Crucible Steel at Midvale Steel Co., Sept. 17, 1919*

F. E. BASH, Philadelphia, Pa.—In order to make a definite check on the emissivity of crucible steel under works conditions, a test was planned and executed as follows: Five crucibles were put in a crucible furnace with the normal charge and were treated in the same manner as a number of others that were charged at the same time; the only difference was that the five crucibles had lids with 2-in. holes in the center. It was thought that after the crucibles were removed from the furnace a reading could be made through the hole in the lid with the optical pyrometer and that such a reading would give the true temperature of the steel as

black-body conditions should prevail inside the crucible. If after obtaining the true temperature, the crucible lid were removed and the steel poured into the ladle, the apparent temperature could be taken by sighting on the steel stream and the emissivity obtained from the two temperature values.

Such a test was carried out with five crucibles. About a third of the crucibles charged into the furnace with the five experimental ones were first drawn from the furnace and poured into the ladle. The experimental crucibles were then drawn and readings of the true temperature were made through the hole in the lid from a raised stand erected for the purpose; the crucibles were then poured into a small ladle. While pouring them, a reading was made on the stream. It was not an easy matter to get this reading as the crucible was poured in about 8 to 10 sec., and often only a glimpse of the steel stream could be obtained as it was covered with slag during most of the time of pouring. However, by setting the

*Temperature Measurements on Crucible Steel*

| Time from Furnace,<br>Seconds                               | Temperature, Degrees F. |        | Remarks   |
|---|-------------------------|--------|---|
|   | Apparent                | True   |   |
|   |                         | 2886   | Temperature in furnace before drawing crucibles |
| 12  |                         | 2824   | First experimental crucible                     |
| 33  | 2542(?)                 | (2761) | First experimental crucible, steel              |
| 15  |                         | 2783   | Second experimental crucible                    |
| 30  | 2560                    | (2783) | Second experimental crucible, steel             |
| 17  |                         | 2818   | Third experimental crucible                     |
| 30  | 2708                    | (2820) | Third experimental crucible, slag               |
| 30  |                         | 2824   | Fourth experimental crucible                    |
| 45  | 2703                    | (2814) | Fourth experimental crucible, slag              |
| 24  |                         | 2802   | Fifth experimental crucible                     |
| 40  | 2632                    | (2738) | Fifth experimental crucible, fumes              |
| Average<br>time<br>from<br>furnace<br>to<br>pour<br>20 sec. | 2722                    | (2834) | Reading on slag stream from pots                |
|   | 2708                    | (2820) | Reading on slag stream from pots                |
|   | 2581                    | (2805) | Reading on steel stream from pots               |
|   | 2567                    | (2790) | Reading on steel stream from pots               |
|   | 2581                    | (2805) | Reading on steel stream from pots               |
|   | 2581                    | (2805) | Reading on steel stream from pots               |
|   | 2574                    | (2797) |   |
|   | 2588                    | (2813) |   |
|   | 2594                    | (2821) |   |
|   | 2588                    | (2813) |   |
|   | 2581                    | (2805) |   |
|   | 2574                    | (2797) |   |

lamp at a temperature very nearly that of the apparent temperature of the steel stream, some readings were obtained. In the case of three of the crucibles the reading had to be made on the slag stream as the steel was not visible.

As a further check on the apparent temperature of the steel, readings were made on the streams from all the remaining crucibles in that heat; these temperatures are tabulated on page 33. The time recorded in the first column is the time that elapsed when the crucible passed through the door and the reading was made.

TEEMING READINGS CORRECTED FOR AN EMISSIVITY OF 0.40

| TRUE TEMPERATURE, DEGREES F. | TRUE TEMPERATURE, DEGREES F. |
|------------------------------|------------------------------|
| Third ingot..... 2680        | Ninth ingot..... 2647        |
| Fourth ingot..... 2665       | Tenth ingot..... 2647        |
| Fifth ingot..... 2665        | Eleventh ingot..... 2647     |
| Sixth ingot..... 2665        | Twelfth ingot..... 2629      |
| Seventh ingot..... 2656      | Thirteenth ingot.... 2629    |
| Eighth ingot..... 2656       | Fourteenth ingot.... 2629    |

NOTE.—All temperature values enclosed in parenthesis, in the columns for true temperatures, are corrected for an emissivity of 0.40 in the case of steel and 0.65 for slag.

The readings in the table for the five experimental crucibles show that the corrections for emissivity of 0.40 for steel and 0.65 for slag, when applied to the apparent temperatures, give practically the same temperature values as the readings made in the crucible under black-body conditions, the greatest difference being 10° F. The correctness of these emissivity values is further verified by taking the mean of the true temperatures obtained by sighting into the five experimental crucibles and comparing them with the mean of the corrected temperature values obtained by sighting on the steel streams from the crucibles. The values are as follows:

|   | DEGREES F |
|---|-----------|
| Mean of true temperatures for five crucibles..... | 2810      |
| Mean of corrected readings on steel streams.....  | 2805      |
| Difference.....                                   | 5         |

The conclusions drawn from the above data are that under industrial conditions, the values for the emissivity of steel and slag are 0.40 and 0.65, respectively.

DISCUSSION

H. SCOTT, Washington, D. C. (written discussion\*).—It appears to me, from observations taken in a number of plants under Dr. Burgess' direction, that the simple and natural expedient of sighting on the bath will give the steelmaker the desired information. The measurements

\* Received Sept. 24, 1919.

show remarkable consistency among themselves. On the other hand, it may be noted from other work, as Dr. Burgess' "Temperature Measurements in Bessemer and Open-hearth Practice"<sup>4</sup> and the report under discussion, that readings taken by this method (sighting on the bath) are not uniform enough to be used as a direct control of open-hearth heats for the variations in tapping temperatures are less than the observed bath temperatures.

To support this opinion I have prepared the accompanying figure, which shows the temperature rise in open-hearth furnaces after the charge

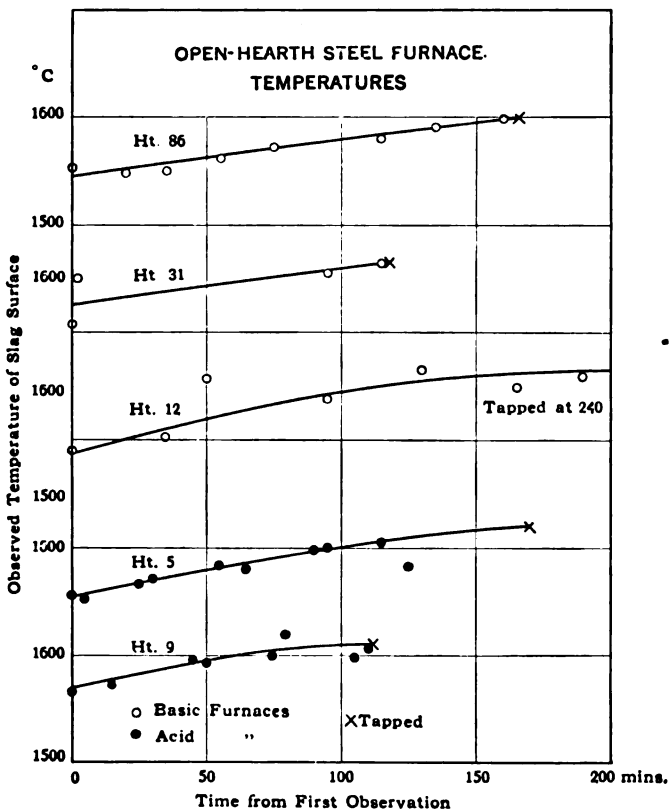

has melted down. Each value represents the average of several uncorrected readings taken through the opening in the furnace door with the pyrometer used by Dr. Burgess. It may be noted that a smooth curve can be drawn representing the temperature rise with time, that only an exceptional value lies more than 15° C. off the curves, and that the extrapolated values for the tapping temperatures all lie between 1600° and 1620° C. (2912° and 2948° F.).

<sup>4</sup> U. S. Bureau of Standards *Tech. Paper* 91; also *Trans.* (1917) 56, 432.

The discrepancies generally observed in readings taken on the bath may be associated with the two disconcerting conditions that always exist in open-hearth furnaces; namely, flames shooting across the line of vision and the boiling of the bath. As both of these features are intermittent, it is possible, with the development of some skill, to obtain rational observations on the background of the slag surface. Thus, for example, by decreasing the brightness of the pyrometer lamp from that of the flames, a point is reached at which the filament no longer flashes bright when the flame momentarily ceases and *vice versa*. These readings represent temperatures just below or above, as the case may be, that of the bath. Care must be taken, however, that the reading is not on the front surface of bubbles as these reflect the dark hole in the door and probably represent non-black-body conditions. I therefore think that the question can be properly brought up as to whether direct observations on the bath in the furnace do or do not give an acceptable criterion of open-hearth furnace temperatures.

A. L. FEILD, Niagara Falls, N. Y.—Have any attempts been made to correlate the temperatures in the steel bath with the reactions that go on in the smelting process? Has the temperature been related to the question of the life of the refractories, especially in the roof? It seems to me that these two points are of practical importance to steel manufacture. A third question is the relation of the temperature of the steel to the properties of the cooled ingot. So far, it seems to me, the Pyrometer Committee has been devising methods and means of measuring temperature, which should be regarded only as preliminary to the really important questions I have mentioned.

G. K. BURGESS.—Mr. Feild is perfectly correct in stating that the object of the Committee's work was the question of determining temperatures. The fundamental idea, of course, is that if you can get a reliable method of temperature observation and control, it is obvious that the thing to do is to tie it up to the factors in steel making that may be of interest and related to temperature, such as the reaction in the furnace, life of the roof, and ingot properties, etc.

## Temperature

BY JOSEPH S. AMES,\* BALTIMORE, MD.

(Chicago Meeting, September, 1919)

THERE are two distinct questions associated with the concept of temperature: one is practical, the other is theoretical. Our fundamental ideas of temperature come from our senses; we know what we mean by the words "hot" and "cold," or by saying one body is "hotter than another." But for scientific purposes words require definition. We are guided in this matter, as in all other scientific questions, by our knowledge of facts of observation.

When two bodies at different temperatures are intimately associated, *e.g.*, a hot stone is dropped into a pail of water, our experience is that ultimately they come to the same temperature as far as our senses can tell; the hot body becomes colder and the cold body hotter. In the case of a block of ice immersed in water, the ice melts, forming cold water, which then mixes with the other water, the final result being water colder than the original water.

From our knowledge of the nature of heat phenomena, we learn that in this process one body loses heat and the other gains heat, the condition of equilibrium being one in which each body gains as much heat as it loses. It is distinctly assumed in this statement that only two bodies are concerned in the transfer of heat, all other bodies being rendered in some way impervious to heat. The body that in the process loses heat is said to have the "higher temperature" while the body that gains the heat is said to have the "lower temperature;" and, when thermal equilibrium is reached, the two bodies are said to have the "same temperature." Consequently, the temperature of a body may be defined, as it was by Maxwell, as "its thermal state considered with reference to its power of communicating heat to other bodies."

Experience also proves that if we have three bodies *A*, *B*, and *C*; if *A* is at the same temperature as *B* and as *C*, then *B* will be at the same temperature as *C*. This fact is the basis of all methods of thermometry. For instance, if *A* and *B* are two bodies in thermal equilibrium, and if *C* is an ordinary mercury thermometer in equilibrium with *A*, then if *C* is placed in *B*, it will indicate the same "reading," showing that *B* is in equilibrium with it. This emphasizes an essential feature of the use of a

---

\* Professor of Physics, Johns Hopkins University.



thermometer: it must be in such a relation with the body whose temperature is desired that these two bodies are in complete thermal equilibrium.

Experiments have shown that we have at our disposal in laboratories many methods by which definite thermal states can be secured. For instance, if a rod of copper is placed in a mixture of ice and water, it always assumes the same length, regardless of when or where the experiment is performed; a piece of platinum wire will, in such a bath, always have the same electrical resistance, etc. We therefore believe that we are dealing with a definite thermal condition. The same is true of the steam rising from boiling water if the pressure of the air on the surface of the water is unchanged, and of countless other so-called "changes of state."

### THERMOMETRY

The practical question of thermometry is to devise a method by which numbers may be given the temperature of any state of thermal equilibrium; and, obviously, the method should be such as to assign always a greater number to the higher temperature. The theoretical question is to learn what physical property of the molecules of a body it is that determines its temperature. Great difficulties arise instantly. Assume that we have adopted a thermometer and a thermometric scale (as will be explained later) and that it is possible to insert the thermometer into a flame in such a manner that it and the flame come to equilibrium; then, if there are two types of flames or even the same type of flame under two conditions, we can obtain numbers by the thermometer "readings." Are they temperatures? Supposing one reading is  $1500^{\circ}$  and the other  $1000^{\circ}$ ; does this mean that, when the two flames are placed in thermal communication, the former will lose heat and the latter gain heat? In such a case as this there are at least two causes of uncertainty: (1) Is the state of a flame such as to justify one in using the word "temperature" in connection with it? (2) Is the condition of the thermometer when it ceases to change such that it is in thermal equilibrium with the flame? This same uncertainty arises when one considers inserting a thermometer in an arc-light, in an electric spark, in a vacuum tube carrying an electric discharge, and in numerous other cases.

Therefore in the preliminary discussion of temperature and thermometry we shall exclude all such cases and shall assume: (1) That the bodies to which temperature numbers are to be assigned are in thermal equilibrium free of all electrical or chemical changes, and (2) that the presence of the thermometer does not give rise to any such changes. Thermal equilibrium between the body and the thermometer is brought about by processes of heat-conduction. The process of radiation is involved in those methods of thermometry in which the thermometer is not inserted in the body. It is convenient, therefore, to divide the sub-

ject of thermometry into two divisions: one involving the insertion of the thermometer in the body and therefore heat-conduction; the other, the use of a thermometer at a distance and therefore radiation.

### CONDUCTION METHODS

In order to assign a number to a thermal state, it is impossible to make use of our temperature-sense, but an obvious method is to make use of some physical property of a definite piece of matter, which property changes in amount as heat leaves this body or is added to it and which can be measured; *e.g.*, the length of a selected copper rod; the volume of a definite quantity of mercury held in some solid; the pressure of a definite volume of a definite mass of nitrogen; the electrical resistance of a definite platinum wire; etc. Such an instrument is called a thermometer. Of course it would cease to be useful if (1) its thermometric property ceased to change as heat was abstracted from it, or (2) it underwent such changes owing to use that, when replaced in the same thermal state after such use, it gave a different reading. (In some cases this second cause of trouble may be obviated).

Having selected a definite physical property of a definite body, for instance, the length of a copper rod, this length may be measured at two definite thermal states to which arbitrary numbers are assigned. Let these numbers be  $t_1$  and  $t_2$ , where  $t_2 > t_1$ , and let the measured quantities be  $a_1$  and  $a_2$ ; the ratio  $\frac{a_2 - a_1}{t_2 - t_1}$  is chosen as the measure of a "degree." Then, for the number to be given the temperature of any thermal state, let  $a$  be the measured quantity in that state,  $t$  the temperature of that state may be defined as

$$t = t_1 + \frac{a - a_1}{\frac{a_2 - a_1}{t_2 - t_1}}$$

It is obvious that this is only one of a number of ways in which a method can be devised for assigning a number to the temperature; but it certainly is the simplest. This definition of  $t$  leads at once to the proportion

$$\frac{t - t_1}{t_2 - t_1} = \frac{a - a_1}{a_2 - a_1},$$

and a reason for adopting it, apart from its simplicity, is that, when various "thermometers" are used, experiments made, taking advantage of a large number of definite thermal states, prove that the values of  $t$  obtained do not differ widely. Of course they differ, but not as much as they would if any less simple definition were adopted.

In this connection another definition is useful; this is the "mean

coefficient of change of  $a$  between  $t_1$  and  $t_2$  with reference to  $t_1$ ." This is obviously  $\frac{a_2 - a_1}{a_1(t_2 - t_1)}$  and may be written  $\alpha$ .

"Absolute zero" on such a scale is, by definition, the value  $t$  assumes when, in the formula,  $a$  is put equal to zero. (This is quite regardless of whether or not it is possible to reduce  $a$  to zero by any physical means.) Calling this calculated value  $t_0$ , we have

$$t_0 = t_1 - \frac{a_1}{\frac{a_2 - a_1}{t_2 - t_1}} = t_1 - \frac{1}{\alpha}$$

The "absolute temperature" on such a scale is defined to be  $t - t_0$ ; and, calling this  $t_a$ , we have

$$t_a = \frac{1}{\alpha} + \frac{a - a_1}{\frac{a_2 - a_1}{t_2 - t_1}}$$

On the centigrade system, which is now universally adopted, the two standard thermal states selected are those of "equilibrium of ice and water" and "equilibrium of water and steam," both under a pressure of 76 cm. of mercury; and to this interval of temperature the number 100 is given. Hence, on this centigrade system,

$$\alpha = \frac{a_2 - a_1}{100 a_1}$$
$$t_a = \frac{1}{\alpha} + 100 \frac{a - a_1}{a_2 - a_1}$$

If the ordinary scale, not the absolute one, is used, it is necessary to assign also a number to either of the standard thermal states; and in all scientific measurements it is customary to give the number zero to the temperature of "melting ice." Thus

$$t = 100 \frac{a - a_0}{a_{100} - a_0}$$
$$t_0 = - \frac{100 a_0}{a_{100} - a_0}$$

Certain obvious facts should be noted:

1. If different properties of different bodies are selected for thermometric purposes, that is, if different thermometers are used, different values of  $t$  will be obtained for the same thermal state.
2. The value of absolute zero will be different for different thermometers.
3. The value of absolute zero does not have any physical importance.
4. To say that a body expands uniformly with change in temperature has no meaning unless the particular thermometer used to give the numerical values of the temperature is specified.

Any one thermometer may be calibrated in terms of another and the demands of scientific statement require that all temperatures quoted in

memoirs and reports should refer to the same instrument. In order to secure this, a definite temperature scale has been adopted known as the "Hydrogen Scale," whose specification is well known.

Certain obvious advantages would follow if a method of thermometry could be devised that would be independent of the nature of the thermometric substance. Lord Kelvin was the first to show that there was an indefinite number of such methods, if one could make use of Carnot's principle. If in a Carnot cycle  $Q_2$  is the heat absorbed by the "working substance" at one temperature and  $Q_1$  that given out at the other, Carnot's principle is that the ratio  $Q_2/Q_1$  is independent of the nature of the working substance, being a function only of the temperatures of the two baths (or reservoirs). There is no practical way by which this simple fact may be used directly for thermometric purposes, owing to the impossibility of securing, in practice, a Carnot cycle; but Kelvin showed how indirect methods could be used. He finally adopted the following definition of a thermometric scale; calling the temperatures of the two baths  $T_2$  and  $T_1$ :

$$\frac{T_2}{T_1} = \frac{Q_2}{Q_1}$$

Either a definite number is assigned one definite thermal state or a definite number is assigned a definite thermal interval, *e.g.*, 100 to the interval between "ice" and "steam."

He then, in collaboration with Joule, devised a method by which his scale could be compared experimentally with that given by any constant-pressure gas thermometer. This method depends on the expansion of the gas through a porous plug, due to a small drop in pressure, and the measurement of the ratio of the drop in temperature to the drop in pressure. Calling this ratio  $\mu$ , the purpose of the experiment was to determine  $\mu$  as a function of temperature and pressure. Kelvin showed from thermodynamic reasoning that, if  $\mu$  is known as a  $f(t,p)$ , it is possible to obtain exact numerical relations between his scale and the gas scale. He also showed, by approximate methods, that, if he adopted the centigrade system,  $T = 273 + t$  approximately over a limited range; so that in the "correction terms" in the formulas  $t$  may be replaced by  $T - 273$ . The best modern experiments on the porous-plug expansion, those of L. G. Hoxton for air as the gas, give the value of  $\mu$  over the range of temperature from melting ice to boiling water. Using this value, and writing

$$I = \int \frac{\mu}{T^2} dT$$

the value of the Kelvin temperature for melting ice becomes

$$T_0 = \frac{1}{\alpha} + \frac{T_0 T_{100} \frac{1}{\rho_0} C_p (I_{100} - I_0)}{100\alpha} = \frac{1}{\alpha} + \eta$$

where  $T_{100} = T_0 + 100$ ,  $\rho_0$  = density of air at melting ice,  $\bar{C}_p$  is the mean value of the specific heat of air at constant pressure, and  $\alpha$  is the mean coefficient of expansion of air at constant pressure.  $\eta$  is a "correction term;" and in it  $T_0$  may be placed equal to 273, and in  $I$ ,  $T$  may be replaced by  $t + 273$ . This gives  $T_0 = 273.36$ . For any temperature, the theory gives

$$T - T_0 = t + \eta at - \frac{TT_0}{\rho_0} \bar{C}_p (I - I_0) = t + \epsilon$$

where  $\epsilon$  is the correction term.

Two facts should be noted:

1. Kelvin's theory proves that there is a definite minimum temperature, which may properly be called "absolute zero;" it is the state for which  $T$  becomes equal to zero.

2. Any temperature, if given in the gas scale, may be expressed on the Kelvin scale provided it is in the range of temperature for which  $\mu$  is known.

#### RADIATION METHODS

The thermometric methods just described are evidently not applicable to extremely hot states, *e.g.*, the carbon poles of an arc light, furnaces, etc. Instead, therefore, of attempting to secure thermal equilibrium between a thermometer and the hot body, application may be made of the facts that all bodies are radiating energy, that the amount radiated varies with the temperature, and that this energy may be measured. It is easily observed that the surfaces of different bodies, when at the same temperature, emit different amounts of radiation. But Kirchhoff proved, from theoretical considerations, that if a hollow is made in a solid body maintained at a constant temperature, the radiation out through a small opening in the wall is independent of the nature of the solid and is a function of its temperature alone. (Of course, "freak" cases are excluded.) Such radiation is called "black-body radiation;" and it is, as Kirchhoff proved, greater than is emitted from the surface of any body at the same temperature, provided this emission is due solely to the thermal state of the body, that is, is not due to what has been called "lumeniscence." If it were possible to obtain a body that would absorb all radiation incident upon it, it would be called a black body and its surface would emit the same radiation as the enclosure just described, at the same temperature.

The radiation from such an enclosure is, then, a measure of its temperature, and it is possible to define, in any way deemed desirable, a new scale of temperature  $t$  in terms of the radiation  $E$  emitted per unit of time through an opening of a definite cross-section, *e.g.*, of unit area. Simple observations prove that  $E$  increases when the temperature is increased; so possible scales would be

$t = AE$ , where  $A$  is an arbitrary constant

$t = AE^2 + BE$ , where both  $A$  and  $B$  are constants, etc.

Naturally one would select such a definition as would make  $t$  on this new scale have, if possible, the same value as  $t$  has on some standard scale, *e.g.*, a gas thermometer using the centigrade system, for those thermal states that are not so hot as to preclude the use of such a conduction instrument. Experiments have shown that if the definition adopted is

$$E = A(t + 273)^4$$

where  $A$  is a definite constant, this condition is satisfied. This new scale may be called "radiation temperature." Obviously, it may be used for temperatures far beyond the range covered by a gas thermometer.

Further, if the radiation from the surface of any body is measured, this same formula in the form  $AS^4 = E$  may be applied; and the numerical value of  $S$  may be deduced. It is called the "black-body temperature" of the body, but this number is obviously less than  $273 +$  its true temperature. This last may be obtained in certain cases, however, by an indirect method. If the body is one whose properties are conditioned by its temperature, we have the law:

Reflection coefficient + transmission coefficient + emissivity = 1

Let us assume that these first two may be measured. The emissivity is, by definition, the ratio of the emission of the body to that of a black body at the same temperature. Hence, calling the reflection coefficient  $R$ , the transmission coefficient  $T$ , the black-body temperature of the body  $S$ ,

$$\frac{S^4}{(t + 273)^4} = 1 - R - T$$

and therefore  $t$  may be deduced.

Other radiation methods have been evolved. If that part of the radiation from a black body that is due to waves having wave-lengths in the range from  $\lambda$  to  $\lambda + \Delta\lambda$  is called  $E_\lambda\Delta\lambda$ , experiments prove that for radiation in the visible spectrum, through a range of temperatures where a gas thermometer may be used.

$$E_\lambda = c_1\lambda^{-5}e^{-\frac{c_2}{\lambda(t + 273)}}$$

where  $t$  is gas-thermometer temperature and  $c_1$  and  $c_2$  are definite constants. Therefore this formula may be used to define a new temperature scale, specially for very hot bodies; and the values of  $t$  obtained agree with both those given by the radiation method previously described.

Both the radiation formulas for black bodies:

Total radiation

$$E = A(t + 273)^4 \quad (\text{Stefan's Law})$$

and partial radiation

$$E_{\lambda} = c_1 \lambda^{-5} e^{-\frac{c_2}{\lambda(t+273)}} \quad (\text{Wien's Law})$$

have a thermodynamic foundation. It may be proved from thermodynamic reasoning, with certain assumptions, that the total and partial radiations from a black body obey the laws

$$E = AT^4 \text{ and } E_{\lambda} = c_1 \lambda^{-5} e^{-\frac{c_2}{\lambda T}}$$

where  $T$  is Kelvin's absolute temperature. Therefore radiation methods will give us a knowledge of Kelvin's temperatures for very hot bodies; for, as stated before, in order to define the Kelvin scale, it is sufficient to assign an arbitrary number to some one thermal state, *e.g.*, 373.36 to that of "boiling water;" then  $E$  may be measured for a black body having that temperature and  $A$  may be deduced; or, using two known values of  $T$  for definite thermal states,  $c_1$  and  $c_2$  may be deduced; consequently the constants being known,  $T$  will be given by measurements of  $E$  or  $E_{\lambda}$ .

The results of experiments on porous-plug expansion are to show that over the range of temperatures between melting ice and boiling water  $T = t + 273$ , approximately, where  $t$  is gas temperature on the centigrade system, and radiation experiments prove that the same is true approximately for higher temperatures, as far as the gas thermometer may be used, that is, the constants in the two radiation formulas are found to be the same when obtained by either process.

#### THEORY OF TEMPERATURE

In the discussion of both conduction and radiation methods, care has been taken to exclude from consideration bodies in which chemical or electrical actions were going on and bodies that were not in what has been called statistical equilibrium. The question now arises as to whether or not it is allowable to speak of the temperature of such bodies. Light is thrown upon this from the dynamical study of the properties of bodies, considering them formed of molecules. It has been proved that for a gas in a state of equilibrium, that is, when it is not flowing or in a turbulent condition, there is an intimate connection between its mean kinetic energy per molecule, and its temperature. If  $m$  is the mass of each of its molecules, and if  $u, v, w$  are the components of the velocity of the center of mass of any one molecule, we may write for the mean kinetic energy of translation of the molecules  $\frac{1}{2}(mu^2 + mv^2 + mw^2)$

It has been proved that  $mu^2 = mv^2 = mw^2 = RT$  where  $R$  is a definite constant and  $T$  is Kelvin's temperature. (If we adopt the centigrade system and use other deductions from the kinetic theory as applied to actual gases, it is found that  $R = 9.3 \times 10^{-17}$  approximately.) Further, if the molecules have kinetic energy of rotation, each of the "degrees of freedom" has an amount of mean kinetic energy equal to  $\frac{1}{2}RT$ . So far as the mean kinetic energy of translation is concerned, this equals,

therefore,  $\frac{3}{2}RT$ ; and the same is true of solids, liquids, and the "free electrons" in solids.

It is clear, then, that for a body not in a state of statistical equilibrium it is not allowable to use the word temperature. This means that the word should not be used with reference to a single molecule or to such phenomena as occur in most flames, or in an electric spark or discharge. It is true that bodies placed in flames, sparks, etc., may assume definite temperatures, but this does not affect the statement just made.

From the standpoint of experiment, the fundamental question is to determine when a body is in a state of statistical equilibrium and, therefore, has its properties conditioned by temperature. Unfortunately this cannot be done with certainty in all cases; general principles are the only guides.

There are, however, certain cases in which the body is not in thermal equilibrium, and where the word "temperature" may be used. Consider a vessel of water placed on a stove, we say that its "temperature rises," thus attaching a meaning to the word at any instant. Again, consider a current of air moving with a uniform velocity, if a thermometer were to move with the gas at the same velocity, it would register the true temperature of the gas; but this temperature is not that which would be indicated by a thermometer at rest in the moving gas, nor is it the temperature of the solid walls of the tube through which the gas is flowing. We may often think of certain limits of temperature between which a certain body must lie when it is not in a condition of equilibrium; thus, one limit would be that which corresponds to its mean molecular kinetic energy of translation. But, in general, it is safest to limit the use of the word temperature to bodies in the state of equilibrium and even then to those bodies for which there is reason for believing that their state is conditioned by their mean molecular kinetic energy.



### Standard Scale of Temperature

BY C. W. WAIDNER, E. F. MUELLER, AND PAUL D. FOOTE, WASHINGTON, D. C.

(Chicago Meeting, September, 1919)

THE standard scale of temperature that it is attempted to realize in practice is the centigrade thermodynamic scale, as defined by Kelvin about the middle of the last century. This scale would be exactly realized with a perfect<sup>1</sup> gas in an ideal gas thermometer, and is closely realized with the more permanent gases. From the departure of certain properties of these gases from those of a perfect gas, it is possible to deduce the amount of the departure of the temperature scales, defined by their use, from the thermodynamic scale.

In nearly all the precise experimental work done during the latter part of the last century, it was necessary for the experimenter to establish his own gas-thermometer scale, and the labor involved in this was often greater than that involved in the prime object of the experimental work undertaken. The experimental difficulties involved in gas thermometry led to the establishment of temperature scales differing from one another by amounts considerably greater than could be accounted for by the differences in the properties of the gases used. Results were, therefore, expressed in terms of somewhat different temperature scales, making correlation of such results difficult and uncertain.

#### INTERNATIONAL HYDROGEN SCALE

The first standard temperature scale to receive fairly general scientific recognition was the so-called international hydrogen scale defined by the following resolution of the International Committee on Weights and Measures, adopted Oct. 15, 1887. "The International Committee on Weights and Measures adopts as the standard thermometric scale for the international service of weights and measures, the centigrade scale of the hydrogen thermometer, having as fixed points the temperature of melting ice (0°) and of the vapor of distilled water boiling (100°) at standard atmospheric pressure, the hydrogen being taken at an initial manometric pressure of 1 meter of mercury, that is to say,  $\frac{1000}{760} = 1.3158$  times the standard atmospheric pressure."

---

<sup>1</sup> Buckingham: U. S. Bureau of Standards *Bull.* 6 (1910) 409. (Bureau of Standards *Sci. Paper* 136.)

In practice, this scale in the interval  $-25^{\circ}$  to  $+100^{\circ}$  has been realized and made available by means of primary standard mercurial thermometers made of French hard glass (verre dur). Eight thermometers, four in the range below  $0^{\circ}$  and four in the range  $0^{\circ}$  to  $100^{\circ}$ , were compared by Chappuis<sup>2</sup> with the hydrogen gas thermometer. In this way Chappuis determined the difference between the mean verre dur scale defined by the eight standard thermometers and the scale defined by the hydrogen thermometer.

The scale is distributed to the scientific world by the International Bureau of Weights and Measures through verre dur thermometers, the several corrections (calibration, internal and external pressure coefficients, and fundamental interval<sup>3</sup>) for which have been determined by that Bureau. The assumption is made that the verre dur scale defined by these standardized thermometers differs from the hydrogen scale by the same amount as does the mean scale of the thermometers originally standardized by Chappuis. The thermometers distributed by the International Bureau are but rarely compared with the primary standards of that Bureau to determine to what extent the scale defined by the newer thermometers differs from that of the original standards. It has been found that the scales defined by two different thermometers of verre dur may differ from each other by over  $0.01^{\circ}$ .

#### PROPOSED INTERNATIONAL SCALE OF TEMPERATURES IN THE INTERVAL $-40^{\circ}$ TO $1100^{\circ}$ C.

When the several national laboratories<sup>4</sup> undertook the standardization of temperature-measuring instruments, it became necessary to extend the limited temperature scale distributed by the International Bureau to higher temperatures on the one hand and to lower temperatures on the other. The method used by all of the laboratories in extending the standard temperature scale consisted in the adoption of certain fixed points defined by the freezing (melting) or boiling points of certain pure substances, these fixed points having been determined on the scale of some gas thermometer by a number of different observers. According to the interpretation of the available data, small differences in the temperature scales adopted by the national laboratories thus resulted. With a view to reaching international uniformity in the temperature scales employed, correspondence was carried on between the several laborato-

<sup>2</sup> *Trav. et Mem.*, Bur. Int. (1888) 6.

<sup>3</sup> For discussion of these corrections see Waidner and Dickinson, U. S. Bureau of Standards *Bull.* 3 (1907) 667 (Bureau of Standards *Sci. Paper* 69) or Bureau of Standards *Circular* 8, 2d Edition, 20.

<sup>4</sup> The Physikalisch-Technische Reichsanstalt at Charlottenburg, Germany; the National Physical Laboratory at Teddington, England, and the National Bureau of Standards at Washington.

ries during the years 1912 to 1914. When these negotiations were interrupted by the war, agreement had been reached on the essential principles to be followed and on most of the necessary details. The plan practically agreed upon, but which failed to reach the stage of ratification, was similar to that followed in defining the electric units. It was agreed to define as the fundamental scale, the centigrade thermodynamic scale and, in addition, to establish a practical or working scale that should realize this fundamental scale as closely as was possible in the existing state of knowledge. The practical, or working, scale that had been outlined in the correspondence has served as the working scale of the several laboratories since 1914, although there are a few minor differences due to the fact that final agreement was not reached. In December, 1915, the Reichsanstalt, through its President, Warburg,<sup>5</sup> announced that after Apr. 1, 1916, it would adopt a new temperature scale. In the interval  $-40^{\circ}$  to  $1100^{\circ}$ , this scale is practically identical with that outlined in the correspondence between the laboratories.

*Temperature Scale in the Interval  $-40^{\circ}$  to  $450^{\circ}$  C.*—In the interval  $-40^{\circ}$  to  $450^{\circ}$  C., the temperature scale now used is that defined by the platinum-resistance thermometer, calibrated at the temperature of melting ice ( $0^{\circ}$ ), the temperature of saturated steam ( $100^{\circ}$ ), and of sulfur vapor ( $444.6^{\circ}$ ) all under standard atmospheric pressure.<sup>6</sup>

The relation between the resistance  $R$ , the platinum temperature and the temperature  $t$  is expressed by the Callendar formulas

$$pt = \frac{R_t - R_0}{R_{100} - R_0} 100$$

$$t - pt = \delta \left( \frac{t}{100} - 1 \right) \frac{t}{100}$$

The purity of the platinum is specified by the mean temperature coefficient of resistance between  $0^{\circ}$  and  $100^{\circ}$ , which coefficient should be not less than 0.00388 and by the constant  $\delta$  in the above formulas, which should be not greater than 1.52.

<sup>5</sup> *Ann. Phys.* (4) (1915) 48,1034.

<sup>6</sup> The standard atmospheric pressure is defined as equivalent to the pressure exerted by a column of mercury 760 mm. in height, the mercury being at  $0^{\circ}$  C. and subject to a gravitational force corresponding to  $g = 980.665$  cm. per sec.

Previous to 1914 the only precise formulas for expressing the variation with pressure of the boiling point of sulfur were these of Holborn and Henning and of Harker and Sexton. These are respectively:

$$t = t_{760} + 0.0910 (p - 760) - 0.000043 (p - 760)^2$$

$$t = t_{760} + 0.0904 (p - 760) - 0.000052 (p - 760)^2$$

In the correspondence between the national laboratories, it had been agreed that the equation  $t = t_{760} + 0.0908 (p - 760) - 0.000047 (p - 760)^2$  best represents the relation. Later experimental work at the Bureau of Standards (published in *Jnl. Am. Chem. Soc.* 41, 759, 1919) led to the equation

$$t = t_{760} + 0.0910 (p - 760) - 0.000049 (p - 760)^2$$

The sulfur boiling point is to be determined in the conventional form of sulfur-boiling apparatus originally used by Callendar and Griffiths. Full details concerning the experimental methods to be used and the precautions to be observed have been published by several investigators, the most recent being Meissner<sup>7</sup> and Mueller and H. A. Burgess.<sup>8</sup> Day and Sosman<sup>9</sup> have summarized the more important determinations of the temperature of the sulfur boiling point. To their table should be added the determination made by Eumorfopoulos<sup>10</sup> in 1914. Their table shows that determinations, previous to 1908, indicate a value of about 444.9° C. on the thermodynamic scale, while the later determinations indicate a value somewhat higher than 444.5°. It appears that if any weight whatever is to be given to any determinations other than those of Holborn and Henning and Day and Sosman, the value 444.6° should be chosen in preference to 444.5°.

However, since final ratification of the agreement on the sulfur boiling point had not been reached, the several laboratories are not using identical values for this constant. The National Physical Laboratory has apparently<sup>11</sup> not changed from the old value of 444.53°, as determined by Callendar and E. H. Griffiths, on the scale of the constant-pressure air thermometer. This temperature is now interpreted by that laboratory as being on the thermodynamic scale. The announcement of the Reichsanstalt, already referred to, shows that that institution is using 444.55° as the temperature of the sulfur boiling point, while the Bureau of Standards, for reasons given above, is using 444.6°. A change of 0.1° in the temperature chosen for the sulfur boiling point corresponds to a change of about 0.4 per cent. in  $\delta$ , which would affect the temperature scale by less than 0.002° at 50° C.

It is worthy of note that the several national laboratories have, in effect, abandoned the international hydrogen scale either as an ultimate standard or as a working standard. It is, therefore, a matter of great interest to determine whether, in actual practice, the scale used by these laboratories differs measurably from the hydrogen scale of the International Bureau. The results of numerous unpublished intercomparisons of the scale defined by platinum resistance thermometers and the hydrogen scale, derived from the mean of a large number of verre dur thermometers,<sup>12</sup> show that the scale defined by the platinum resistance

---

<sup>7</sup> *Ann. Phys.* [4] (1912) **39**, 1230.

<sup>8</sup> *Jnl. Am. Chem. Soc.* (1919) **41**, 745.

<sup>9</sup> *Am. Jnl. Sci.* (1912) **33**, 530; *Ann. Phys.* (1912) **38**, 865.

<sup>10</sup> *Proc. Royal Soc. London* (1914) **A 90**, 189.

<sup>11</sup> See Ezer Griffiths: "Methods of Measuring Temperature," 8. Charles Griffin & Co., 1918.

<sup>12</sup> Waidner and Dickinson: *Op. cit.*

thermometer is in agreement with the hydrogen scale of the International Bureau to well within the limits of accuracy with which the latter scale has been distributed to the scientific world by means of standardized primary standard verre dur thermometers. The advantage of using the platinum resistance thermometer to define the standard scale lies in the fact that platinum of the required purity is readily available, that its purity is easily verified, and that the standard scale in the interval 0° to 100° can be reproduced in any part of the world to an accuracy of 0.002° or 0.003°.

It may be noted that the adoption of the platinum resistance thermometer to define the standard scale of temperature embodies the essential features of the practical thermometric standard proposed by Callendar to the British Association in 1899.<sup>13</sup>

A number of fixed points within the above range, useful for the calibration of temperature measuring instruments other than standard resistance thermometers had been practically agreed upon, as shown in Table 1. The freezing points of cadmium and zinc are convenient lower fixed points for the calibration of high temperature thermocouples.

TABLE 1.—Fixed Points in the Interval — 40° to 450° C.

|                                    | DEGREES                                      |
|------------------------------------|--|
| Freezing point of mercury.....     | - 38.88                                      |
| Freezing point of tin.....         | 231.84 <sup>a</sup>                          |
| Freezing point of cadmium.....     | 320.9  |
| Freezing point of zinc.....        | 419.4 <sup>a</sup>                           |
| Boiling point of naphthalene.....  | 217.96 + 0.058 ( <i>p</i> - 760)             |
| Boiling point of benzophenone..... | 305.9 + 0.063 ( <i>p</i> - 760) <sup>a</sup> |

<sup>a</sup> Recent determinations with the resistance thermometer calibrated at 0°, 100°, and the boiling point of sulfur (444.6°), of the freezing points of very pure specimens of tin and zinc lead to the values 231.88° and 419.44°, respectively. It is apparently difficult to produce benzophenone of sufficient purity to serve for reproducing the standard temperature and so far as known the temperature given is obtained only with Kahlbaum's purest material. See U. S. Bureau of Standards *Bull.* 7 (1910) 5. (Bureau of Standards *Sci. Paper* 143.)

*Temperature Scale in the Interval 450° to 1100° C.*—In the interval 450° to 1100° C., the practical scale is defined by the fixed (freezing) points given in Table 2, which are practically identical with the values of Day and Sosman<sup>14</sup> when reduced to the thermodynamic scale, the resulting values being, in general, rounded off in the direction of higher temperatures in view of the fact that the previously accepted values for these fixed points were higher.

<sup>13</sup> Report British Assn. Dover (1899) 242.

<sup>14</sup> *Am. Jnl. Sci.* (1910) 29, 93; (1912) 33, 517. Also L. H. Adams: *Jnl. Am. Chem. Soc.* (1914) 36, 65.

TABLE 2.—Standard Freezing Points<sup>a</sup>

|                              | DEGREES |
|------------------------------|---------|
| Antimony.....                | 630     |
| Silver.....                  | 960.5   |
| Gold.....                    | 1063    |
| Copper, free from oxide..... | 1083    |

<sup>a</sup> The freezing point given for antimony is apparently attained only with the pure metal supplied by Kahlbaum. See U. S. Bureau of Standards *Bull.* 6 (1910) 164. (Bureau of Standards *Sci. Paper* 124.) Final agreement was not reached as to whether 960.5° or 961° is the better value to be taken as the freezing point of silver. The Reichsanstalt announcement gives 960.5°.

The instrument commonly employed for interpolation between these fixed points is the platinum, 90-per cent. platinum, 10-per cent. rhodium thermocouple calibrated at three temperatures; the relation between temperature  $t$  and electromotive force  $e$  being expressed by the formula  $e = a + bt + ct^2$ . The points usually chosen for the standardization of these couples are the freezing points of zinc (or cadmium), antimony, and copper. Other convenient secondary calibration points in the interval are aluminum (freezing point) 658.7° for a sample 99.66 per cent. pure, and sodium chloride (freezing point) 801° C. The freezing point of the latter substance is less sharply defined and is not quite as satisfactory as a fixed point as are the freezing points of the metals.

It is a rather remarkable fact that the scale defined by the platinum resistance thermometer calibrated in ice, steam, and sulfur vapor (444.6°) is in agreement up to 1100° with the scale defined by the thermocouple calibrated at three points as above described.<sup>15</sup>

*Temperature Scale Above 1100° C.*—In the correspondence between the national laboratories, no attempt had been made to agree on a uniform scale above 1100° C. The only gas-thermometer data that could receive consideration for the purpose of establishing a standard temperature scale above 1100° is that of Day and Sosman. Whatever temperature is considered as the upper limit of precise gas thermometry, it is evident that the scale above this limit must be based on physical laws having sound theoretical or experimental support. The method generally followed was to extend the thermometric scale from the region of known temperatures, as determined by the gas thermometer, by the aid of the radiation laws. The two laws most satisfactory for this purpose are represented by the Planck and the Stefan-Boltzmann equations. Of these two laws the latter has a stronger theoretical basis, but has been less frequently applied on account of the greater difficulties of experimental manipulation involved. The former, for the wave-lengths of the visible spectrum, reduces to the well-known Wien formula from which it follows that

<sup>15</sup> Waidner and Burgess: U. S. Bureau of Standards *Bull.* 6 (1910) 182. (Bureau of Standards *Sci. Paper* 124).

$$\log_{10} \left( J_2 / J_1 \right)_\lambda = \frac{c_2 \log_{10} e \left( \frac{1}{\theta_1} - \frac{1}{\theta_2} \right)}{\lambda}$$

where  $J_1$  and  $J_2$  are the intensities of black-body radiation of wave-length  $\lambda$  at absolute temperatures,  $\theta_1$  and  $\theta_2$ , respectively, and  $c_2$  is the fundamental constant of the Planck equation.

It will be seen from this equation that any high temperature  $\theta_2$  (absolute) may be determined from a measurement of the ratio of the intensity of black-body radiation for a given wave-length  $\lambda$  to the intensity of black-body radiation for the same wave-length at some accurately determined lower temperature  $\theta_1$  (absolute). The temperature scale will depend on the value chosen for  $c_2$ , the constant of the Planck equation. In all of the earlier work, the value taken for this constant was 14,500 or 14,600 micron degrees. In 1906, Holborn and Valentiner<sup>16</sup> published the results of an investigation that led them to assign the value 14,200 to this constant. The large difference between this value and the ones previously accepted led to further extensive researches at the Reichsanstalt and at the Bureau of Standards. A summary of this later work may be found in a paper by Coblenz.<sup>17</sup> As a result of this more recent work, the Bureau has been led to adopt 14,350 for the value of the constant  $c_2$  of the Planck equation. The Reichsanstalt is using the value 14,300 for  $c_2$ .

The most important fixed points in the range above 1100° C. are the melting points of palladium and platinum. Some of the more important experimental work that has been done in the determination of these fixed points is discussed below.

*Melting Point of Palladium.*—Day and Sosman extended their gas-thermometer measurements to the melting point of palladium. Using a crucible method, the e.m.f. of standard rare-metal thermocouples was obtained at the melting point of palladium and the couples were standardized by direct comparison with the gas thermometer. The couples, accordingly, served only as a means of transfer from the crucible of palladium to the furnace containing the thermometer bulb. The result of the single experiment attempted at this extreme temperature for the gas thermometer gave  $1549.2 \pm 2.0^\circ$  C. for the melting point of palladium. To this value may be added a rather uncertain correction of about  $0.8^\circ$  to take account of the deviation of the temperature scale defined by the constant-volume nitrogen gas thermometer, at the pressures employed, from the ideal thermodynamic scale. As a final corrected value we thus obtain  $1550^\circ \pm 2^\circ$  C. A chemical analysis of the palladium showed that it was of extremely high purity. This value of  $1549^\circ$  C. was used quite generally for several years. Since 1916, however, the Reichsanstalt<sup>18</sup>

<sup>16</sup> *Ann. Phys.* [4] (1906) 22, 1.

<sup>17</sup> U. S. Bureau of Standards *Bull.* 13 (1917) 459. (Bureau of Standards *Sci. Paper* 284.)

<sup>18</sup> *Loc. cit.*

has adopted the value 1557° C. for the melting point of palladium, and 1764° C. instead of 1755° C. for the melting point of platinum. More recently the laboratories of the General Electric Co.<sup>19</sup> have agreed to use the value 1555° C. for the melting point of palladium.

The evidence that the determination of Day and Sosman is low is based on the data obtained by extrapolation of the optical temperature scale using Wien's (or Planck's) law. The melting point of gold is generally agreed upon as 1063° C. Hence if we measure for a given wave-length the ratio of the brightness of a black body at the temperature of melting palladium to that of a black body at the temperature of melting gold, knowing  $c_2$ , the melting point of gold, and the value of this ratio  $R$ , the temperature of the melting palladium may be computed by the formula already given:

$$\log R = \log \left( \frac{J_{Pd}}{J_{Au}} \right)_{\lambda} = \frac{c_2}{\lambda} \log e \left( \frac{1}{\theta_{Au}} - \frac{1}{\theta_{Pd}} \right) \quad (1)$$

where

- $\theta_{Au}$  = absolute temperature of melting gold;
- $\theta_{Pd}$  = absolute temperature of melting palladium;
- $J_{Pd}$  = intensity of radiation for wave-length  $\lambda$  from a black body at a temperature  $\theta_{Pd}$ ;
- $J_{Au}$  = intensity of radiation for wave-length  $\lambda$  from a black body at a temperature  $\theta_{Au}$ .

If in this formula we substitute the values  $c_2 = 14,350$  and  $\theta_{Au} = 1336$ , we obtain:

$$\frac{1}{\theta_{Pd}} = 0.0007485 - \frac{\lambda \log R}{6232} \quad (2)$$

Nernst and V. Wartenberg<sup>20</sup> measured the value of the ratio  $R$  for  $\lambda = 0.5896\mu$  by means of a Wanner pyrometer, which is essentially the Konig-Martens spectrophotometer. The gold or palladium in the form of wire was gradually heated in an iridium-tube furnace. The melting point was indicated by the breaking of an electric circuit of which the wire formed a part. The value thus found was  $R = 131$ . Substituting this value in formula 2 we obtain  $\theta_{Pd} \approx 1551^\circ$  C. on the basis of  $\theta_{Au} \approx 1063^\circ$  C. and  $c_2 = 14,350$ .

Holborn and Valentiner<sup>21</sup> using the wire method, an iridium furnace, and a Lummer-Brodhun spectrophotometer obtained the following values of  $R$  from which are recomputed, in column 3, on the basis of  $c_2 = 14,350$ , the corresponding values of the melting point of palladium. The mean 1573° C. is confirmed by their work with the gas thermometer,

<sup>19</sup> Hyde: *Gen. Elec. Rev.* (Oct., 1917).

<sup>20</sup> *Verh. Phys. Ges.* (1906) 8, 48-58.

<sup>21</sup> *Loc. cit.*



which gave a final value of 1575° C. It is impossible to account for these high determinations since the experimental work, at least from the optical side, appears most carefully done.

| $\lambda$  | $R$   | $^{\circ}$ C. |
|------------|-------|---------------|
| 0.656      | 93.1  | 1575          |
|            | 92.6  | 1574          |
|            | 90.3  | 1570          |
| 0.590      | 153.5 | 1574          |
| 0.546      | 229.0 | 1573          |
| Mean ..... |       | 1573          |

Hoffmann and Meissner<sup>22</sup> have performed a series of experiments, only the summary of which, however, has been published. Using a spectrophotometer at various wave-lengths and using black bodies immersed in baths of freezing gold and of palladium as well as employing the usual wire method, the following values of  $R$  reduced to a common wave-length were obtained. In the third column is given the corresponding melting point of palladium computed for  $c_2 = 14,350$ . On the basis of  $R = 81.5$  for  $\lambda = 0.6563\mu$  and  $c_2 = 14,300$ , the above referred to temperature scale of Reichsanstalt was adopted.

| $\lambda$    | $R$  | $^{\circ}$ C. |
|--------------|------|---------------|
| 0.6563 $\mu$ | 80.5 | 1552          |
|              | 81.4 | 1554          |
|              | 81.6 | 1554          |

The work of Hyde, Cady, and Forsythe,<sup>23</sup> which forms the basis for the adoption by the General Electric Co. of the value 1555° C. for palladium, has never been published in detail. They state that for the effective wave-length of a piece of red glass "slightly thicker than the standard sample here investigated," for which this wave-length was determined "as a result of ten determinations extending over a year and a half, the ratio 76.9 was obtained." The wave-length<sup>24</sup> employed was  $\lambda = 0.6661\mu$  (private letter to the authors). Hence on the basis of gold = 1063° C. and  $c_2 = 14,350$ , this ratio gives 1555° C. for the melting point of palladium.

Mendenhall,<sup>25</sup> using the wire method and a spectral pyrometer and assuming the melting points of gold and palladium to be 1063° C. and 1549° C. respectively, obtained  $c_2 = 14,413$  from measurements of the

<sup>22</sup> *Zeit f. Inst.* (1912) **32**, 201; (1913) **33**, 95, 157.

<sup>23</sup> *Astrophys. Jnl.* (1915) **42**, 300.

<sup>24</sup> For methods of computing and for definition of effective wave length see Hyde, Cady and Forsythe, *loc. cit.* and Foote: U. S. Bureau of Standards *Bull.* 12 (1915) 483-501.

<sup>25</sup> *Phys. Rev.* [2] (1917) **10**, 522.

ratio  $R$ . The actual values of  $R$  are not given but the data permit the calculation of  $R$  for any arbitrary wave-length. Thus, for  $\lambda = 0.65\mu$  the foregoing data require that  $R = 83.7$ . Using this value of  $R$  and  $c_2 = 14,350$ , we find from formula 2 that  $\theta_{Pd} = 1825^\circ$  absolute or  $1552^\circ$  C.

In another series of experiments in which the ratio of brightnesses of a black body at a temperature  $\theta_1 = 1604^\circ$  absolute, and a black body at a temperature  $\theta_2 = 2734^\circ$  absolute was measured, the value  $c_2 = 14,394$  was obtained. Since assigning values to  $\theta_{Au}$ ,  $\theta_{Pd} = 1822^\circ$  absolute and  $c_2$  fixes the ratio  $J_{Pd}/J_{Au}$  for any color, this ratio may be computed for  $c_2 = 14,394$ . Using the ratio thus obtained  $\theta_{Pd}$  may be recomputed for  $c_2 = 14,350$ . This gives  $1551^\circ$  C. for the melting point of palladium. The temperature  $\theta_1$  was defined in terms of the Day and Sosman scale based on the melting point of palladium  $1549^\circ$  C., and  $\theta_2$  was measured by an application of the Stefan-Boltzmann law. This method of computation accordingly assumes that an error in the temperature scale at  $1549^\circ$  C. necessitates some error at  $1604^\circ$  absolute, an assumption which is not absolutely justified. Hence the value of  $1551^\circ$  C. is omitted from Table 3.

Many other determinations of the melting point of palladium have been made by various investigators but most of these have taken no account or improper account of the wave-length of the glass employed in the eyepiece of the pyrometer and hence their data, either with a sector disk or absorption glass, are unreliable. We have recomputed the data of Waidner and Burgess,<sup>26</sup> in which a sector disk was used. The proper

TABLE 3.—Melting Point of Palladium.  
 $c_2 = 14,350$ ; Melting Point of Gold =  $1063^\circ$  C.

| Investigator                | Method  | Melting Point, Degrees C. |
|-----------------------------|---|---------------------------|
| Day and Sosman.....         | Gas thermometer corrected to thermodynamic scale. | 1550                      |
| Nernst & Wartenberg.....    | Ratio of brightness Pd/Au, Wanner pyrometer.      | 1551                      |
| Hoffman and Meissner.....   | Ratio of brightness Pd/Au, spectrophotometer.     | 1552<br>1554<br>1554      |
| Hyde, Cady and Forsythe.... | Ratio of brightness Pd/Au, H. & K. pyrometer.     | 1555                      |
| Mendenhall.....             | Ratio of brightness Pd/Au, spectral pyrometer.    | 1552                      |
| Waidner and Burgess.....    | H. & K. pyrometer and sector disk.                | 1549                      |
| Mean.....                   |   | 1552                      |

<sup>26</sup> U. S. Bureau of Standards *Bull.* 3 (1907) 163-208, Table XI.

effective wave-length is  $\lambda = 0.6663\mu$ . Hence on reducing their values to  $c_2 = 14,350$ , the copper melting point of  $1083^\circ \text{C}$ . instead of  $1084^\circ \text{C}$ . we obtain  $1549^\circ \text{C}$ . for the melting point of palladium.

Table 3 summarizes the determinations of the melting point of palladium as discussed, omitting the work of Holborn and Valentiner, which gives a value  $20^\circ$  higher than that of all other observers. Hence the unweighted mean of all the best published values of the melting point of palladium, properly corrected for  $c_2 = 14,350$  and the melting point of gold of  $1063^\circ \text{C}$ ., gives  $1552^\circ \text{C}$ . The value that has been used by the Bureau of Standards for the past 4 years is  $1550^\circ \text{C}$ . The evidence here presented indicates that this temperature is possibly low by an uncertain amount, probably by not more than  $5^\circ \text{C}$ . In view of the uncertainties involved, the Bureau has not deemed it advisable to change the scale in present use.

In only one of the investigations discussed, that of Day and Sosman, was the purity of the palladium determined. Hoffman and Meissner, however, stated that the palladium used by them melted within  $1^\circ \text{C}$ . of that of a sample used by Day and Sosman. The natural tendency in the wire method is toward too high values, although with care Hoffman and Meissner obtained consistent results by both the wire and the crucible methods. In the Lummer-Kurlbaum black body, it is possible to obtain too high values on account of stray reflection from the hotter side walls. For this reason further experimental work with crucible melts of a type described by Hoffman and Meissner are highly desirable. If the measurements are made with a spectrophotometer, attention must be given to the slit width and to the shift of wave-length with temperature of the source when the slit width is large. If the measurements are made with a pyrometer, the effective wave-length of the ocular screen must be carefully considered. That these factors are of importance is evident when one notes that the ratio of brightness Pd/Au increases from about 74 at  $\lambda = 0.67\mu$  to about 600 at  $\lambda = 0.45 \mu$ .

*Melting Point of Platinum.*—Experimental determinations of the melting point of platinum are much less satisfactory than those of palladium. Table 4 summarizes the work of investigators who have made

TABLE 4.—*Melting Point of Platinum*

| Investigator                | Palladium,<br>Degrees C. | Platinum,<br>Degrees C. | Platinum-<br>palladium,<br>Degrees C. |
|-----------------------------|--------------------------|-------------------------|---------------------------------------|
| Nernst and Wartenberg.....  | 1551                     | 1761                    | 210                                   |
| Holborn and Valentiner..... | 1573                     | 1777                    | 204                                   |
| Waidner and Burgess.....    | 1549                     | 1753                    | 204                                   |
| Mean.....                   |                          |                         | 206                                   |

determinations with both metals. The data have been recomputed for gold = 1063° C.,  $c_2 = 14,350$ , and the proper effective wave-lengths have been employed. If the mean difference of 206° C. is added to the mean value of the determination of the melting point of palladium, 1552° C., we obtain 1758° C. for the melting point of platinum. The Bureau has used the value 1755° C. for the past several years, hoping to obtain more satisfactory data before adopting a new value.

*Melting Point of Tungsten.*—Consideration of the pioneer work on tungsten by Waidner and Burgess, V. Wartenberg, and Pirani may be omitted because of the fact that at this early date pure tungsten was not procurable, and because of the empiric methods employed, especially in the determination of emissivity of the metal, and finally because of the unsatisfactory computation of effective wave-lengths and transmission coefficients of the absorbing glasses. Worthing<sup>27</sup> has summarized what are believed to be the most reliable measurements, reduced to  $c_2 = 14,350$ , gold = 1063° C., and  $\lambda = 0.665\mu$  as follows:

| INVESTIGATORS                | APPARENT<br>TEMPERATURE<br>$\lambda = 0.665\mu$<br>DEGREES<br>ABSOLUTE |
|------------------------------|--|
| Mendenhall and Forsythe..... | 3174   |
| Langmuir.....                | 3187   |
| Worthing.....                | 3174   |
| Luckey.....                  | 3169   |
| Mean.....                    | 3176   |

On the basis of Worthing's determination of the emissivity of tungsten at this wave-length, 3176° absolute is equivalent to a true temperature of 3674° absolute or in round numbers 3400° C.

*Reproduction of the High Temperature Scale.*—The standard temperature scale as used and distributed by the Bureau of Standards is fixed in the interval  $-40^\circ$  to  $450^\circ$  C. by means of platinum resistance thermometers calibrated in ice, steam, and sulfur vapor ( $444.6^\circ$  C.) as previously described. The standard temperature scale in the interval  $450^\circ$  to  $1100^\circ$  C. is defined by the fixed points cited in Table 2 and interpolation between these points is based on the temperature scale defined by the rare-metal thermocouple (Pt, Pt 90 - Rh 10) calibrated at two of these fixed temperatures, usually antimony and copper, and at the zinc point, Table 1.

The temperature scale above  $1100^\circ$  C. is based upon the extrapolation of Wien's (or Planck's) law using as the fiducial point the melting point of gold =  $1063^\circ$  C. and  $c_2 = 14,350$ .

<sup>27</sup> Worthing: *Phys. Rev.* [2] (1917) 10, 392.

DISCUSSION

CHARLES E. GUILLAUME,\* Sèvres, France (written discussion†).— Referring to p. 47, experiments made at the end of the year 1884 showed a remarkable agreement between the indications of various verre dur thermometers of which all the corrections had been determined with the greatest possible precision. The maximum deviations not attributable to the comparisons themselves were then about 0.002 to 0.003 degree. Much later, greater differences began to show. They were caused by the fact that the glassmaker had modified the composition by adding to it a small quantity of lead. Efforts are now being made in France to obtain a regular supply of glass made according to the old formula.

The determination of the boiling point of sulfur made by Chappuis,<sup>28</sup> 444.6°, accords very well with the value noted on p. 49.

The International Committee of Weights and Measures and the General Conference have already considered the future abandonment of the hydrogen scale in favor of the thermodynamic scale. The hydrogen scale appears to be, in their estimation, a transitory one, happily so closely approaching the final scale that no correction should be necessary for all measurements of temperature made during the last 30 years.

It must not be forgotten that the decision reached by the International Committee in 1887, and endorsed by the Conference of 1889, applied only to the international service of weights and measures; that is to say, the domain of temperatures where the hydrogen scale or the thermodynamic scale presents divergences which are, up to date, within the limit of measurable quantities. But it is not at all contrary to this decision to adopt other representations in the region outside of the one expressly indicated. At very low temperatures, the best representation that one can at the present time propose is undoubtedly that furnished by the helium thermometer; and at high temperatures, hydrogen has such a tendency to diffuse that it is necessary to replace it by another gas. But then the errors in reference to the thermodynamic scale are considerable enough to necessitate a correction. All our efforts ought to tend now to determining the corrections in such a way as to extend the realization of the thermometric scale far into the region where the nitrogen thermometer, for example, overlaps the radiation pyrometer. As the authors say, the latter is the only thing that one can use for high temperatures, whichever law is applied. It may be noted that, the fundamental points of a nitrogen thermometer under low initial pressure having been chosen, for example, at the boiling point of water and at the boiling point of sulfur, the linear extrapolation toward high temperatures will

\* Bureau International des Poids et Mesures.

† Received Oct. 11, 1919. Translated from the French.

<sup>28</sup> Bureau International, *Travaux et Mémoires*, 16.

give a scale very close to the thermodynamic scale. It would seem possible to make a direct experimental determination of corrections by the comparison of two nitrogen thermometers having very different initial pressures.

On p. 56, the authors mention the old measure of Holborn and Valentiner of the melting temperature of platinum. However, this old value seems to have been abandoned by the Reichsanstalt, see p. 52. On the other hand, Harker indicated a much lower temperature for the melting of platinum; but the process that he employed in his determination leads one to think that he used a metal containing an appreciable amount of carbon in solution, either in the form of carbon or in the form of platinum carbide.

LEASON H. ADAMS,\* Washington, D. C. (written discussion†).—It would be difficult to point to anything more vitally important to the industries and to scientific research than a temperature scale that is trustworthy and reproducible. This paper is a clear and illuminating exposition of the present state of our knowledge of the scale of temperature and it is pleasing to note that, by means of the standard scale which the authors present, temperatures may now be defined with such satisfactory precision. Thus at room temperatures the possible uncertainty in the absolute magnitude of a given temperature need not be greater than a few thousandths of a degree; at 400° C., the maximum error is not more than a few hundredths of a degree; and at 1100°, a few tenths.

Above 1100°, the determination of the temperature scale hinges largely upon the melting point of palladium, which is taken as 1550°, although the average as obtained by several independent investigators is somewhat higher. As pointed out by the authors, in only one of the investigations, that of Day and Sosman, was the purity of the palladium determined. This circumstance brings to mind certain observations I made some time ago on the difference in melting point of three samples of palladium wire, one of which was drawn from a piece of the metal used by Day and Sosman. The melting points were determined with a platinum-platinrhodium thermocouple using the wire method. One sample melted 2° and another 12° higher than the Day and Sosman palladium, which according to the analysis was very pure, and the thermoelectric properties of the three kinds gave a qualitative support to the conclusion that as a rule the purest palladium has the lowest melting point. This being the case, it is not at all improbable that some of the higher values that have been obtained for the melting point of palladium are influenced by lack of purity of the material, and this supposition lends support to the lower value, 1550°, which the Bureau of Standards has very wisely chosen.

\* Physical Chemist, Geophysical Laboratory.

† Received Sept. 25, 1919.

The scale of temperature, as given, terminates at the lower end at  $-40^{\circ}$ . It is to be hoped that the Bureau of Standards will, as soon as feasible, extend the standard scale down to liquid-air temperatures or below.

E. P. HYDE, Nela Park, Cleveland, O.—I want to emphasize the importance of determining the palladium point. I do not know how pure the palladium is for these melting-point determinations. I know it is quite constant and the values obtained from time to time using different samples of this wire are approximately the same. In calibrating optical pyrometers in practical use, the palladium point is the one of greatest value. The General Electric Co. has arrived at the same conclusion. It would be better to establish our scale on the melting point of gold, using for the constant  $c_2$ , the value 14,350 micron degrees. We find it necessary to use palladium in calibrating pyrometers, and I trust that before long the Bureau of Standards will determine whether or not the wire we get has a different melting point from that used by Sosman, and what that value should be.

In addition, I want to question the statement that a change in  $c_2$  from 14,460 to 14,350 micron degrees makes anything like the variation in the effective wave-length given in the paper. If the Crova wave-length, which is the effective wave-length for a clear glass or no glass at all, is calculated for the same range ( $1336^{\circ}$  to  $1828^{\circ}$ K), the change will only be about 4 parts in 5800 for this change in  $c_2$ . For the effective wave-length, this change will be much smaller, *i. e.* less than 1 part in 6000. Furthermore, the change is in the opposite direction from that stated above; that is, a decrease in  $c_2$  causes a decrease in the effective wave-length.

P. D. FORTÉ.—Dr. Hyde is correct in his criticism of our statement in regard to the change in effective wave-length with change in  $c_2$ , but this does not affect the results in the slightest manner. After considering all determinations of the melting point of palladium, the true value appears to be  $1552^{\circ}$  C. The value adopted by the Bureau of Standards 5 years ago is  $1550^{\circ}$  C. and until further work is done we do not feel justified in changing to a new value. We have recently procured a large quantity of palladium and Mr. Fairchild will determine the melting point by a crucible method. As noted in our paper, a knowledge of the exact melting point of palladium, while most desirable, is not absolutely essential, since the high-temperature scale is reproduced by a definition of  $c_2$  and the melting point of gold.

## Metals for Pyrometer Standardization

BY CHARLES W. Waidner\* AND GEORGE K. Burgess,† WASHINGTON, D. C.  
(Chicago Meeting, September, 1919)

IN response to many urgent requests for a concrete realization of a series of standard temperatures that would be available to any one anywhere for the standardization of pyrometers and the reproduction of the standard scale of temperature for use in laboratories and industrial works, the Bureau, in 1916, made arrangements with several manufacturers to prepare a series of pure metals that could best serve this purpose. After the necessary preliminary work of chemical analysis, as a check on the purity, together with exact determinations of melting or freezing points, the Bureau began, in 1917, the issuing of melting-point standards of tin, zinc, aluminum, and copper.

At the outset, it was decided to secure metals of the highest purity and of American manufacture, and this was accomplished in a more satisfactory manner than anticipated. In the preparation of these temperature standards, the Bureau has had the hearty cooperation of several American companies, which have succeeded in producing metals highly satisfactory for the purpose and of as high a state of purity as could have been obtained anywhere. Each company that undertook the responsibility of furnishing a metal for this series of standards exercised most painstaking care to produce the best possible product as to purity and uniformity. A representative of the Bureau witnessed the actual preparation of each metal.

The 300 and 400-lb. (136 and 181-kg.) samples making up the first series were all used up, with the exception of the aluminum, early in 1919. The Bureau has taken steps to replenish its stocks of metals serving as pyrometric standards and to the list has been added lead. The copper and lead are being ordered this time in 1-ton lots and the zinc and tin in 300-lb. (136 kg.) lots as before. The wide dissemination of these samples will be appreciated when it is noted that the metals are distributed by the Bureau in quantities of 50 cu. cm. each, at \$2 a sample and accompanied by a certificate which gives the melting point as determined by samples from the same lot. The manufacture and detailed description of chemical analyses, physical measurements, and precautions in use of these pyrometric standards, are described in detail in the Bureau *Circular* No. 66.

Although an exact chemical determination of the residual impurities remaining in these metals is not absolutely essential for their use as a pyrometric standard, it was thought desirable to make such an analysis from a suitably compiled sample, for the purpose of testing uniformity

\* Physicist, Chief of Heat Division, U. S. Bureau of Standards.

† Physicist, Chief Division of Metallurgy, U. S. Bureau of Standards.



and also to demonstrate what could be done in American plants on the production of metals of highest possible purity. The uniformity of several lots of metal were tested on several samples from each lot by means of the intercomparison of their freezing points, using as temperature-measuring instruments four electrical resistance thermometers of pure platinum calibrated at 0°, 100°, and 444.6° C., the freezing and boiling points of water and the boiling point of sulfur, respectively. The temperature scale given by the resistance of pure platinum within the range covered by this series of metals (0–1100° C.) reproduces the standard scale of temperatures as closely as it can be determined. The actual value to be used for the freezing point of each metal is given by the certificate furnished with each sample.

In the accompanying table are given the values of the freezing points and purity of the first series and of the second series, in so far as they have been determined, of the standard pyrometric metals issued by the Bureau. As may be required, and as opportunity permits, other metals will be added to this series, including palladium, platinum, and gold in the form of wires; and it may be advisable to include pure chemical substances of known boiling points such as naphthalene, benzophenone, and sulfur. Other convenient standardization temperatures for pyrometers are the freezing point of sodium chloride, 801° C.; the *A*<sub>2</sub> transformation of pure iron, 768° C; and the transformation temperature of crystalline quartz, 573.3° C.

These pyrometric standards have been found of great use in testing and research laboratories and for control of pyrometric operations in many kinds of industry. They are particularly convenient in that they permit calibrations to be carried out in place and thus save time, conserve equipment, and prevent breakage of instruments in transit.

TABLE 1.—*Metals for Pyrometer Standardization*

| Source                            | Lot No. | Metal    | Freezing Point, Degrees C. | Purity, Per Cent. | Main Impurities, Per Cent.          |
|-----------------------------------|---------|----------|----------------------------|-------------------|-------------------------------------|
| Aluminum Co. of America.          | 1       | Aluminum | 658.68                     | 99.66             | Fe 0.18, Si 0.15, C 0.01, Cu 0.004. |
| Raritan Copper Co. . . . .        | 1       | Copper   | 1083.0                     | 99.987            | Sb 0.004, As and S 0.0026 each.     |
| Raritan Copper Co. . . . .        | 2       | Copper   | 1083.00                    |                   |                                     |
| National Lead Co. . . . .         | 2       | Lead     |                            |                   |                                     |
| Amer. Smelt. & Refin. Co. . . . . | 1       | Tin      | 231.88                     | 99.988            | Pb 0.007, Cu 0.003, Fe 0.002.       |
| Amer. Smelt. & Refin. Co. . . . . | 2       | Tin      |                            |                   |                                     |
| New Jersey Zinc Co. . . . .       | 1       | Zinc     | 419.44                     | 99.993            | Fe 0.005, Cd 0.0018, Pb 0.0004.     |
| New Jersey Zinc Co. . . . .       | 2       | Zinc     | 419.39                     |                   |                                     |

## Fundamental Laws of Pyrometry

BY C. E. MENDENHALL, \* PH. D., MADISON, WIS.

(Chicago Meeting, September, 1919)

THE word temperature has both a colloquial and a technical use. For everyday purposes of abusing the weather man, no very exact definition is necessary, but for the purpose of giving a simple summary of the physical laws that form the basis of practical pyrometry, something more precise is required. Beginning, therefore, with the common concept of "hotness" and "coldness," we must agree on a method of measuring differences in "hotness," on the unit to be used, and on the point from which measurements are to be taken. We shall then have a definite "scale of temperature," which can be used in all methods of pyrometry. But, as in many similar cases, it is much easier to define or describe something than it is to make practical application and use of the definition; so that much of our attention will be taken up with practical methods of realizing or applying the scale agreed upon.

It was early observed that changes in temperature produced large and easily measurable changes in gases, which may be most simply separated into changes in volume (expansion and contraction) under conditions of constant pressure, and changes in pressure under conditions of constant volume. These changes are much the same in magnitude for the common gases oxygen, nitrogen, and hydrogen and also for the rarer helium and argon. This relative uniformity in behavior led to the suggestion of "the gas thermometer" and "the gas scale" as the basis for all temperature measurements. However, as methods were refined, differences appeared between different gases and different ways of using gases, so that Lord Kelvin introduced his more fundamental notion of the "absolute thermodynamic scale" of temperature, which he defined as follows: Given two bodies, say two tanks of water, at different temperatures, to determine these temperatures on the "absolute thermodynamic," or Kelvin, scale, operate a thermal engine between these two temperatures, letting it take in heat from the hot body and give out heat to the cold, which therefore corresponds to the boiler and the condenser of a steam engine. The engine we may imagine as a cylinder and piston inclosing a gas and operating with the well-known Carnot or isothermal-adiabatic cycle. We must imagine that the mechanical losses of energy due to friction and the thermal losses due to radiation convection and con-

---

\*Chairman of Section on Mathematics and Physics of National Research Council.

duction have been determined and allowed for. We must also take care to run the engine slowly so that only an inappreciable difference or temperature exists between it and the hot and cold bodies when it is absorbing or giving out heat to them. Such an engine with the corrections applied as indicated, is called perfect because it is of maximum efficiency. If it is found that a quantity of heat  $H_1$  is taken in at the high temperature and  $H_2$  is given out at the low temperature we have

$$\frac{T_1}{T_2} = \frac{H_1}{H_2} \quad (1)$$

where  $T_1$  and  $T_2$  are the two temperatures in question on the K. scale. From this,  $\frac{H_1 - H_2}{H_1} = \frac{T_1 - T_2}{T_1}$ ; and from this, the idea of an absolute zero is suggested as that temperature for which  $H_2 = 0$  for then  $T_2 = 0$ . To complete the definition of the K. scale, it is only necessary to agree that the interval between the two most reliable fixed points, namely, the temperatures of melting ice and of boiling water, shall contain a certain number of degrees, 100 if we are working with the centigrade K. scale.

This condition is expressed by  $\frac{H_{100} - H_0}{H_0} = \frac{100}{T_0}$  (2)

and combining this with the general equation 1 we have

$$T_1 = \frac{H_1 100}{H_{100} - H_0} \quad (3)$$

which gives any temperature on the centigrade K. scale in terms of the quantities of heat taken in and rejected. How can this scale be realized and used in practice? Obviously not by means of any ideal engine as outlined above. There are, however, two distinct ways in which it may be done, both depending on theoretical deductions from the second law of thermodynamics, to which the K. scale is very intimately related.

First, by applying the second law expressions may be derived (Callendar-Berthelot-Buckingham) in which the pressure of a gas (volume constant) is given in terms of its temperature on the K. scale and of certain physical characteristics of the gas. By a different treatment of the problem, analogous expressions may be obtained giving the volume of gas (pressure constant) in terms of its K. temperature and physical properties. These expressions, in the form given by Buckingham, are:

A (volume constant =  $v$ )

$$\frac{p}{\theta} - \frac{p_0}{\theta_0} = - \int_{\theta_0}^{\theta} \frac{1}{\theta^2} \left[ \frac{\delta}{\delta v} (pv) + \mu c_p \frac{\delta p}{\delta v} \right]_{\theta} d\theta$$

B (pressure constant =  $p$ )

$$\frac{v}{\theta} - \frac{v_0}{\theta_0} = \int_{\theta_0}^{\theta} \frac{\mu c_p d\theta}{\theta^2}$$

In these expressions

- $\theta$  = temperature on K. scale;
- $\theta_0$  = initial temperature (say ice point) on K. scale;
- $c_p$  = specific heat under constant pressure;
- $\mu \equiv \frac{\Delta t}{\Delta p}$  = under Joule-Kelvin conditions; that is, when expanded adiabatically through a porous plug;
- $p_0$  = pressure at  $\theta_0$  and  $v$ ;
- $v_0$  = volume at  $\theta_0$  and  $p$ .

The physical properties involved, namely, the specific heat at constant pressure, the pressure-volume relations of the gas, the Joule-Kelvin coefficient or rate of change of temperature with pressure when expanded through a porous plug, should be known throughout the temperature interval that is to be determined for the volumes and pressures to be used, in order to evaluate these expressions. The initial volume or pressure, as the case may be, must also be known with especial accuracy. If these quantities are known for a given gas, the observation of the change in volume of this gas at constant pressure ( $v_0$  to  $v$ ) will enable us to compute the K. temperature at which the volume was observed to be  $v$ ; and, similarly, if the pressure change is observed at constant volume, the temperature can be computed from the pressure change  $p - p_0$ . Unfortunately the experimental knowledge of  $c_p$ ,  $\mu$ , and the  $pv$  relation is very incomplete, being limited to a short temperature range, and great ingenuity and care are needed in handling and extrapolating the data to get the most reliable results.

The results of the thermodynamic computations just referred to are usually expressed in a somewhat different way by introducing various "gas scales" of temperature. For example, if we are operating with nitrogen, we may conveniently consider two nitrogen scales, one defined by

$$\left(\frac{T}{T_0}\right)_p = \left(\frac{v}{v_0}\right)_p$$

if the gas is maintained at constant pressure during the measurements, and the other by

$$\left(\frac{T}{T_0}\right)_v = \left(\frac{p}{p_0}\right)_v$$

if the volume is maintained constant. Every other gas would have its own two scales. Hence the previous fundamental equations may be described as giving the differences between any given gas scale and the K. scale, and these differences or corrections may be tabulated and applied to reduce gas-thermometer observations to the K. scale. These corrections have only been computed up to 1200° C. and are, in general, somewhat more than twice as large for the constant-pressure gas thermometer

as for the constant-volume, but there are other compensating advantages in favor of the former.

Confining our attention to nitrogen as the most useful gas for high-temperature measurements, it may be briefly said that the correction to  $T_p$  is about  $1.70^\circ$  at  $1000^\circ$  C. and  $2.15^\circ$  at  $1200^\circ$  C., while it is only  $0.96^\circ$  for  $T_v$  at  $1200^\circ$  C. These errors are of significance when it comes to determining, by gas thermometry, the fundamental fixed points of the high-temperature scale, though too small to be considered in ordinary work. Above  $1200^\circ$  C. they are undoubtedly larger, but unfortunately data are not yet available for their computation.

There is one other fundamental matter that must be considered, and that is the value of the ice point on the Kelvin scale. This may be calculated from the same basic equations already given. The computations of Buckingham and Berthelot agree very well in giving  $\theta_0 = 273.13$ ; that is, for high-temperature work, the ice point may be taken as flat  $273^\circ$  on the Kelvin scale.

The second field in which it has been possible to connect practical methods of pyrometry with the Kelvin scale is the field of radiation. The fundamental facts of radiation are that it is an effect of one body on another that may take place across a vacuous space, and that it is closely related to the "hotness" of bodies and tends to equalize their temperature. Without attempting to distinguish between what we know and what we merely say, radiation may be described in the usual way as an electromagnetic disturbance sent off from bodies, which may be analyzed by spectroscopes of various types, and shown to contain waves of various lengths, of which those having lengths from  $0.0003900$  mm. to  $0.00076$  mm. directly affect the eye and are called "light" waves; waves longer than these are called "infra-red," those shorter "ultra-violet," and those still shorter  $x$ -rays. The entire range of waves is called a complete spectrum, and various radiating bodies emit, according to their nature and condition, various characteristic spectra; that is, different groupings of wave-lengths with different distributions of energy among them. The radiation from solids and liquids increases very rapidly with rising temperature, and their spectra are similar, and, in general, continuous; that is, there are no "gaps" if arranged according to wave-lengths. But the total energy radiated and its distribution among the wave-lengths is very different for different substances at the same temperature. At present, it is not possible, theoretically, to express the radiating power of a substance in terms of its other physical properties and temperature, but there is a special form of radiator which can be successfully dealt with both theoretically and experimentally, namely, the perfect or complete radiator, or black body. The original idea of this was due to Kirchhoff, and the experimental realization to Lummer and Pringsheim and many later workers. Given an inclosure with opaque walls at a uniform and

constant temperature, the fundamental theorem is that the radiation inside the inclosure will be, both as to intensity and energy distribution in the spectrum, entirely independent of the material of the walls and dependent only on its temperature. Since, in general, bodies that are good radiators are poor reflectors and good absorbers, and vice versa, it is quite reasonable to conceive of the radiation, so to speak, accumulating in a closed space until an equilibrium condition is reached dependent only on the temperature. For immediately contiguous to one part of the wall the equilibrium condition might be maintained by strong absorption and correspondingly strong emission, while at another point the same condition might result from strong reflection and weak emission. Nevertheless, of the so-called proofs of this theorem that have been given by Kirchhoff, Pringsheim, and others, none is entirely satisfactory, and the most convincing evidence that it is possible to produce radiation independent of the qualities of special kinds of matter and dependent only on temperature, is furnished by experiment.

The first form of perfect radiator used for experimental purposes consisted of a hollow vessel with walls as uniformly heated as possible and provided with a small aperture through which radiation from the inside passed out to be examined spectroscopically and otherwise. If the area of the aperture is small, compared to the interior radiating walls, the condition of equilibrium, which must exist in order that the interior radiation should be complete, will be very little disturbed and the departure from equilibrium, and hence from completeness, may be made as small as desired by a proper choice of proportions. The experimental proof referred to consists in the fact that whereas radiation observations on free metal or other surfaces are very difficult to repeat, that is to say, the radiation from free surfaces is very much subject to changes in surface conditions, all observations with inclosures are much more uniform, and it is possible to arrange matters so that the emergent radiation is observably independent of interior surface conditions. Once we accept this as possible, eye observations of the interior furnish a most sensitive test as to whether the conditions of perfect radiation really exist in any given case. There are, of course, experimental difficulties in the way of producing sufficiently uniform temperature conditions, but these need not be discussed here.

Granted then that there is such a thing as a perfect radiator, we must consider Boltzmann's ingenious extension of the theory. First, however, it must be recalled that Bartolli had shown that in order to be consistent with the second law of thermodynamics, radiation must exert a pressure on any surface on which it impinges, the pressure being twice as great if the surface is perfectly reflecting as if it is perfectly absorbing—being, in fact, proportional to the amount of radiant energy per unit volume in front of the surface. Maxwell drew the same conclusion from his

electromagnetic theory; and later Lebedew, Nicholls and Hull experimentally verified these theoretical deductions. On this basis, Boltzmann conceived of a "radiation engine," which might be a cylinder with reflecting walls and piston and a radiating base, in which radiation could be "expanded," so to speak, and allowed to do mechanical work through the pressure on the piston. By applying to this engine the second law, Boltzmann showed that the total radiation from a perfect radiator must vary in amount as the fourth power of the temperature of the radiator, measured on the Kelvin scale, that is

$$E = \sigma \theta^4$$

where  $E$  is total radiant energy,  $\sigma$  is a constant, and  $\theta$ , as before, is Kelvin temperature.

This theoretical deduction is quite simple, is no more questionable than the direct thermo-mechanical deductions from the second law, such as are used in the theory of gas thermometry, and constitutes the second experimental hold on the Kelvin scale. It is known as the Stefan-Boltzmann law because Stefan had some years earlier deduced it from a discussion of bad observations on imperfect radiators, for which it does not hold—a case in which two negatives have apparently been equivalent to an affirmative, so to speak.

The next advance in radiation theory was by Wien, the radiation engine still being the basis; but the arguments are not quite so simple and free from objection as in Boltzmann's case. The result is Wien's displacement law, of which the usual statement

$$\theta \lambda_{\max.} = \text{constant}$$

is a special case. Here  $\theta$  is the Kelvin temperature at which a perfect radiator would have the maximum of its spectral energy curve at the wave-length  $\lambda_{\max.}$  Wien proceeded further and, by still less satisfactory methods, deduced the equation of spectral energy distribution known as Wien's law

$$E_{\lambda} = c_1 \lambda^{-5} e^{-\frac{c_2}{\lambda \theta}}$$

wherein

$E_{\lambda}$  = ordinate at wave-length  $\lambda$  of spectral energy distribution curve;

$\theta$  = corresponding Kelvin temperature;

$c_1$  and  $c_2$  = constants.

Further work of Planck led to the well-known expression

$$E_{\lambda} = c_1 \lambda^{-5} \frac{1}{e^{\frac{c_2}{\lambda \theta}} - 1}$$

which for small values of  $\lambda\theta$ , that is, short wave-lengths and not too high temperatures, becomes practically identical with Wien's law. While Planck's, and within the limits just mentioned, Wien's distribution formulas have been experimentally verified with a fair degree of accuracy and for temperatures below about 1500° C., unfortunately their theoretical deduction cannot be regarded as sound. They do not, therefore, furnish another independent connection between the Kelvin scale and observable quantities, but must be regarded as empirical equations whose accuracy has been demonstrated within limits. We must consider these three radiation formulas of Stefan-Boltzmann (total), Wien (displacement), and Planck (distribution) somewhat more in detail in their bearing on pyrometry. The first of these gives us a means, independent of corrected gas thermometry, of completely evaluating the Kelvin scale, beginning merely with the ice and steam points and the assumption of 100° between the two. For this purpose it is theoretically much simpler than gas thermometry, but whether it would work out to be of comparable accuracy, especially at low temperatures, cannot be said as no one has ever attempted to apply it in this comprehensible way. For high temperatures, more particularly for extreme high temperatures, the case is clearer. The limit of successful gas thermometry is at present the palladium point (1549° C.), and above this region experimental difficulties seem to be increasing at an appalling rate. On the other hand, the difficulties in applying the fourth-power law in a sense diminish with increasing temperatures because "stray" radiation in general becomes proportionately less compared to that which is to be measured. While beginnings have been made in the application of the Stefan-Boltzmann law to accurate pyrometry, the possibilities have not been in any sense exhausted. The law should be applied to determine the gold melting point (1062.6° C.) and especially the palladium melting point, as a check upon the determination by gas thermometry, and there is room for more work in determining other standard fixed points in the range beyond 1600° C., in which region the total radiation method seems to be about the only hopeful one. It should perhaps be pointed out that in using this method no absolute measurements of radiant energy are needed—one deals entirely with energy ratios, and enough work has been done to prove that very considerable accuracy is possible.

Wien's displacement law  $\theta = \frac{\text{const.}}{\lambda_{\text{max.}}}$  has also been used in pyrometric work, but the disadvantages are several. In the first place the wave-length corresponding to maximum energy is difficult to determine, and as the inverse wave-length varies only as the first power of the temperature the shift is not sensitive to temperature changes, particularly at high temperatures. We may therefore dismiss this as of little value either for fundamental or practical measurements.



If we confine our attention to a single wave-length, or rather a narrow band of wave-lengths in the spectrum, the laws of Planck and Wien give the rate of variation of the energy in this band as a function of temperature, a very useful indicator of temperature change. Within the range wherein Wien's law is valid, it serves most conveniently to express this variation of partial radiation and may be written in this form

$$\log E_{\lambda} = \log \frac{c_1}{\lambda^5} - \frac{c_2}{\lambda\theta}$$

This equation, which must be looked upon as empirical and which has been verified with a high degree of accuracy for temperatures up to 1600° C., and less accurately from there up to 3000° C., is the basis of all optical pyrometry. As such its importance warrants still more careful comparison between it and the Stefan-Boltzmann law up to the highest possible temperatures. For while the Stefan-Boltzmann equation gives our best, if not our only sound, connection with the Kelvin scale and while it is easy to work very accurately with this equation under laboratory conditions, the equation is subject to certain troublesome errors (notably that due to absorption by vapors or smoke and to windows and reflectors etc. that may intervene between the radiator and indicating instruments) which are difficult to eliminate in practice. Similar errors affect optical pyrometers, but perhaps not quite so seriously, and there is a certain safety as regards the detection of trouble in actually looking through the instrument into the space whose temperature is being determined. However, excellent instruments have been devised according to each principle, and the only object here is to point out that one may be regarded as fundamental in terms of which the other should be calibrated.

In all this discussion of radiation pyrometry it has been presupposed that the object whose temperature was to be measured was a perfect radiator, as the laws that have been used apply only to such a case. For fundamental measurements this is, of course, essential; and for practical measurements it is usually possible and always desirable, for a perfect radiator is the most definite and easily reproducible. A tube thrust into a furnace, a narrow deep hole bored into a large hot mass—a crack in such a mass—can usually be arranged so that they will approximate sufficiently to the "uniformly heated enclosure with small aperture" that is desired, especially if the surface actually observed through the aperture is itself a good radiator and a poor reflector. There are other ways of approximating a perfect radiator by using multiple reflection, but a discussion of these various methods is not germane to the present subject. It should be pointed out, however, that for purposes of practical pyrometry, ordinary non-perfect radiators may, and sometimes have, to be used; and if the radiation laws are applied directly in such cases, true temperatures will not be obtained, but instead lower values which are commonly referred

to as "black body (or perfect radiator) temperatures," meaning thereby the temperatures at which a "perfect radiator" or "black body" would radiate as the real body is observed to do. If the real surface is sufficiently definite and reproducible, known corrections in some cases may be applied to reduce the observations to Kelvin temperatures, or it may be that black-body temperatures will suffice.

There are two methods of temperature measurement still to be touched upon—resistance and thermoelectric pyrometry—but in neither of these is it possible to deduce any theoretical connection between the observed quantities and the Kelvin scale. They are entirely empirical and all the instruments must be calibrated by comparison directly or indirectly with gas or radiation work. There are certain relations, such as Callendar's parabolic formula connecting the resistance of platinum with temperature, and various equations giving thermoelectromotive force as a function of temperature that are extremely useful and hold with great accuracy within certain temperature limits, but which cannot be called fundamental laws. They may, therefore, be left without further discussion, as most valuable methods both in the laboratory and in practice, but not contributing anything to our grasp of the fundamental temperature scale. Even as methods, their range is much more limited than the radiation processes.

This survey of the physical basis of pyrometry is of necessity superficial, and it may seem at first thought that the underlying idea of working to an "absolute scale" is unnecessary, any single arbitrary scale being, for all practical purposes, just as good. This is quite true, provided a single arbitrary scale could be agreed upon and accurately reproduced. But the general experience in such matters has been that the more fundamental and absolute the nature of any scale of measurement, the more accurately it can be maintained and reproduced. In other words, the absolute scale whose development has been described in this paper is of importance in pyrometry, not because of its "absoluteness" but because of its permanence and ease of reproduction.

### Present Status of Radiation Constants

BY W. W. COBLENTZ,\* PH. D., WASHINGTON, D. C.

(Chicago Meeting, September, 1919)

THE constants in question pertain to the total radiation and the spectral radiation of a uniformly heated enclosure, or so-called black body. These constants have been determined for the range within which temperatures can be measured with thermocouples. Conversely, using these constants and suitable instruments, such as an optical pyrometer, for example, it is possible to determine temperatures far above the range attainable with the most refractory thermocouples.

The formula of Stefan Boltzmann for expressing the total radiation of a black body is  $R = kT^4$  in which  $k$  is the coefficient or "constant" under discussion. In view of the fact that total radiation pyrometers are usually calibrated on an arbitrary scale, there is no great demand for an exact value of the coefficient of total radiation in absolute value. However, it is intimately connected with the constant of spectral radiation; hence, an accurate determination of the constant  $k$  gives a check on the constant of spectral radiation.

The distribution of radiation in the spectrum of a black body is represented by Planck's equation,  $E_\lambda = C_1\lambda^{-5} (e^{c/\lambda T} - 1)^{-1}$ . The spectral radiation constant  $c$ , in this formula, is useful in optical pyrometry and in establishing a high temperature scale. The numerical value of the constant  $c$  has been determined in the range of temperatures measurable with thermocouples and, also, by extending the temperature scale to higher temperatures by means of total radiation measurements.

But little work has been done on the radiation constants since the beginning of the war, and especially since 1916. In a summary<sup>1</sup> of the data of various observers, it was shown that, after making corrections for atmospheric absorption, the variously obtained values of the coefficient of total radiation are close to  $k = 5.7 \times 10^{-12}$  watt cm.<sup>-2</sup> deg.<sup>-4</sup>, which is close to this Bureau's value,  $k = 5.72$ . A recalculation<sup>2</sup> of these data gave a value of  $k = 5.72 \times 10^{-12} \pm 0.012$  watt cm.<sup>-2</sup> deg.<sup>-4</sup>. In a recent discussion,<sup>3</sup> it was shown that the determinations by Kahanowicz,<sup>4</sup> when corrected for atmospheric absorption lead to a value of  $k = 5.7$  which is

\* Associate Physicist, U. S. Bureau of Standards.

<sup>1</sup> Coblentz: U. S. Bureau of Standards *Bull.* 12 (1916), 553.

<sup>2</sup> Coblentz: *Proc. Nat. Acad. Sci.* (1917) **3**, 504.

<sup>3</sup> Coblentz: *Jnl. Wash. Acad. Sci.*, **9**, 185.

<sup>4</sup> Kahanowicz: *Nuovo Cimento* (6) (1917) **13**, 142.

in agreement with other data. For some years this Bureau has used the value  $k = 5.7 \times 10^{-12}$  watt cm.<sup>-2</sup> deg.<sup>-4</sup>.

Determinations of the spectral radiation constant  $c$  have been made principally by the Reichsanstalt and by this Bureau; the various data have been summarized in a recent paper.<sup>5</sup> In this paper a recalculation of this Bureau's data, on the basis of a revised calibration curve of the fluorite prism used in obtaining the spectral energy curves, gave a value of  $c = 14,353$  micron deg. A recalculation of Paschen's data have a value of  $c = 14,350$  to  $14,370$ . The summary of the extensive data obtained by the Reichsanstalt indicated values of  $c = 14,250$  to  $14,400$ ; and the adoption<sup>6</sup> of  $c = 14,300$  and the melting point of palladium =  $1557^\circ$  C. For some years this Bureau has been using the value of  $c = 14,350$ ; although there are indications that probably  $c = 14,330$  would be a better value. Using Millikan's value of the unit electric charge,  $e = 4.774 \times 10^{-10}$  e.s.u., and this Bureau's value of  $k = 5.72$ , in the appropriate formula which interrelates  $c$  and  $k$ , it is found that the value of  $c = 14,320$ .

Another check upon these data was obtained by Hyde<sup>7</sup> and his collaborators from measurements of the brightness of a black body at the melting point of gold and of palladium, as determined with an optical pyrometer. Adopting the value  $c = 14,350$ , consistent results could be obtained only on the assumption that the melting point of palladium is  $1555^\circ$  C. instead of  $1550^\circ$  C. as previously used. The latter gives a value of  $c = 14,460$ , which is too high according to the best data available.

A further check on the radiation constants is obtained by considering the interrelation between the spectral radiation constant  $c$  and Planck's natural constant  $h$ . Recent determinations, by various methods (*e.g.*,  $x$ -ray, ionization potential, etc.) indicate a value of this constant of the order  $h = 6.55 \times 10^{-27}$  erg. sec. This, in turn, indicates a value of  $c = 14,320$ .

From the foregoing summary, it appears that the radiation constants are known to 0.3 per cent.; certainly to 0.5 per cent. In view of the difficulties involved it seems remarkable that all these constants, including the constant  $h$ , are so closely determined. This is especially true in view of the fact that a variation (increase) of less than 0.1 per cent. in the value of  $e$  would produce exact agreement in the computed data. In conclusion it may be added that from a consideration of the data available it appears that the value of the constant of spectral radiation is close to  $c = 14,330$  micron degrees and that the coefficient of total radiation is close to  $k = 5.72 \times 10^{-12}$  watt cm.<sup>-2</sup> deg.<sup>-4</sup>.

<sup>5</sup> Coblentz: U. S. Bureau of Standards *Bull.* 13 (1916), 459.

<sup>6</sup> Warburg: *Verh. Phys. Ges.* (1916), 1.

<sup>7</sup> See *Phys. Rev.* (2) (1919) 13, 48.

## Thermoelectric Pyrometry

BY PAUL D. FOOTE,\* PH. D., T. R. HARRISON,\* B. S., AND C. O. FAIRCHILD,\* B. S.,  
WASHINGTON, D. C.

(Chicago Meeting, September, 1919)

SEEBECK discovered, in 1821, that if, in a closed circuit of two metals the two junctions are at different temperatures, an electric current will flow in the circuit. In the case of an iron and a copper wire, for example, current will flow from copper to iron at the hot junction, or from iron to copper at the cold junction. Two factors combine to cause the current. An electromotive force exists between the two metals, the magnitude of which depends upon the temperature and upon the metals; this is called the Peltier e.m.f. If a single wire of homogeneous material is heated at one end, an electromotive force is developed between the ends of the wire, the magnitude of which depends upon the metal and upon the difference in temperature; this is known as the Thomson e.m.f. The total e.m.f. acting in the circuit is the sum of the Peltier e.m.f. at the two junctions and the Thomson e.m.f. in each wire, consideration being given, of course, to the algebraic signs of the four e.m.f.'s. The total electromotive force thus depends upon the difference in temperature of the two junctions. If the temperature of one junction is fixed, the temperature of the other junction can be determined by measuring the electromotive force developed in the circuit; this is the basic principle of thermoelectric pyrometry. The electromotive forces developed by thermocouples are small, usually a few thousandths of a volt; to measure such small e.m.f.'s special types of sensitive voltmeters (millivoltmeters) or indicators are required. For any particular type of couple, these instruments may be graduated to read temperatures directly instead of electromotive force.

A simple thermoelectric pyrometer consists of three parts:

(a) The thermocouple of two different metals or alloys, having a fused junction which is inserted into the furnace, while the cold junctions protrude from the furnace and are maintained at some fixed temperature, such as that of the room or of melting ice.

(b) Two lead wires, usually of copper, running from the cold junctions of the thermocouple to the indicator.

(c) The indicator, which may be a millivoltmeter, a potentiometer, or a special type of instrument embodying both of these principles, and

---

\* U. S. Bureau of Standards,

may be graduated to read either electromotive force, or temperature, or both.

Although any two dissimilar metals might be employed for a thermocouple, certain combinations are unsatisfactory because of the very small e.m.f.'s which can be developed, and because of the fact that with some combinations the electromotive force may first increase, then decrease, become zero, and finally change sign, as the temperature increases. Obviously desirable properties for a thermocouple are:

1. Ability to resist corrosion and oxidation.
2. Development of relatively large electromotive forces.
3. A temperature-e.m.f. relation such that the latter increases continuously with increasing temperature over the range to be employed.

For general work at the higher temperatures, several different types of couples are employed in the United States. Up to  $360^{\circ}$  C. for extreme precision, or to  $500^{\circ}$  C. for a precision of  $5^{\circ}$  or  $10^{\circ}$ , the couple may have one wire of copper and the other of constantan. Iron-constantan or nichrome-constantan couples may be employed for technical processes below  $900^{\circ}$  C. For operation below  $1100^{\circ}$  C. special patented alloys of chromium and nickel and of aluminum and nickel, chromel-alumel or nichrome-alumel are satisfactory, even for continuous service. For the range  $300^{\circ}$  to  $1500^{\circ}$  C. the Le Chatelier couple should be employed, having one wire of platinum and the other of an alloy containing 90 per cent. platinum and 10 per cent. rhodium. Other alloys and metals may be employed for special work, but the above combinations are sufficient for almost all technical processes conducted at less than  $1500^{\circ}$  C. No satisfactory couple has been developed for operation much above  $1500^{\circ}$  C.; there are several metals and numerous alloys which melt only at much higher temperatures, but all, so far known, are subject to serious disadvantages which prevent their practical application. For example, a couple having one wire of iridium and the other of the alloy Ir 90  $\times$  Ru 10, can be used up to  $2000^{\circ}$  C., but it is so costly as to be prohibitive, so fragile and brittle that a slight jar will fracture it, and the iridium rapidly volatilizes even at  $1200^{\circ}$  C. Tungsten-molybdenum could be employed possibly up to  $2400^{\circ}$  C., but both of these metals oxidize so readily that extreme care must be taken, by the use of hydrogen, to prevent oxidation; a satisfactory method for thus protecting such a couple for technical purposes has never been developed. The peculiar fact that nickel is readily oxidized and made brittle by heating in air, but, when alloyed with chromium or aluminum, resists oxidation and does not crystallize so rapidly, suggests the possibility that certain similar alloys of tungsten may be developed which will not suffer the rapid oxidation characteristic of the pure metal. Such alloys might prove of great value in thermoelectric pyrometry.

The principal cause of change in calibration is inhomogeneity, which

may develop through contamination by fumes or metallic vapors from the furnace, through oxidation, or for other reasons. Contamination may usually be prevented by the use of suitable protecting tubes, and the effect of contamination may be minimized by using wire of large cross-section. Different furnace conditions and different types of couples require different methods of protection against contamination; for example, a platinum couple is usually protected by refractory porcelain tubes, but if the atmosphere surrounding the platinum be reducing, the porcelain may do more harm than good, because the reducing atmosphere changes the silica of the porcelain into silicon, which readily attacks the platinum. The electromotive force of some couples gradually diminishes with use. The platinum and Pt 90 + Ir 10 couple has not proved very satisfactory for this reason, although it develops a much larger force than the platinum-rhodium couple; the iridium gradually distills from the alloy wire, especially above 1200° C., requiring frequent recalibration.

When thermocouples are employed in the laboratory for scientific purposes, although desirable, it is not important that the calibration of couples of the same type be exactly similar. In an industrial plant, however, the question of reproducibility is of considerable moment. The indicating instruments are usually graduated in degrees of temperature, and the graduation holds for one definite temperature-e.m.f. relation. If the calibrations of various couples of the same type are not similar, corrections must be applied to the readings of the indicator, and these corrections will be different for every couple. When several couples are operated with one indicator, and when the process is such as to require frequent renewal of couples, the application of these corrections becomes troublesome. For extreme precision it is always necessary to apply such corrections, but for most industrial processes, thermocouples which are sufficiently interchangeable can be secured, so that the corrections may be omitted. Thus the calibration of different homogeneous and uncontaminated chromel-alumel couples should not vary by more than 10° or 15° C., and of platinum-rhodium couples by more than 2° or 3° C. The variations in iron-constantan couples have been considerably greater, but rapid progress is now being made in the production of constantan having reproducible thermoelectric characteristics. No industrial processes conducted at high temperatures require such accurate temperature control that variations in the calibration of new platinum-rhodium thermocouples, of the same type, warrant consideration. Variations in the calibration of different base-metal couples are frequently corrected by the use of series or shunt resistance; but most of the methods yet devised are somewhat unsatisfactory, and some of the compensating devices, after continued use, may develop larger errors than those arising from the variation of the couple, as will be shown later. The above remarks as to reproducibility apply only to new couples; after a couple

has been used for some time, especially a base-metal couple, or has become contaminated in any manner, the calibration may change considerably. All thermocouples should be tested frequently under operating conditions.

The proper mounting and protection of a thermocouple is of great importance; the correct protection depends upon the particular process in which the couple is employed, and will be considered in some detail later. The usual rare-metal couple consists of wires 0.5 mm. or preferably 0.6 mm. in diameter and from 50 to 125 cm. in length. Wires as small as 0.1 mm. and even less are frequently used for special research. One or both of the wires are insulated by threading them through small porcelain or quartz tubes. For measuring temperatures below about 1400° C., two-hole porcelain tubes are useful, but for higher tempera-

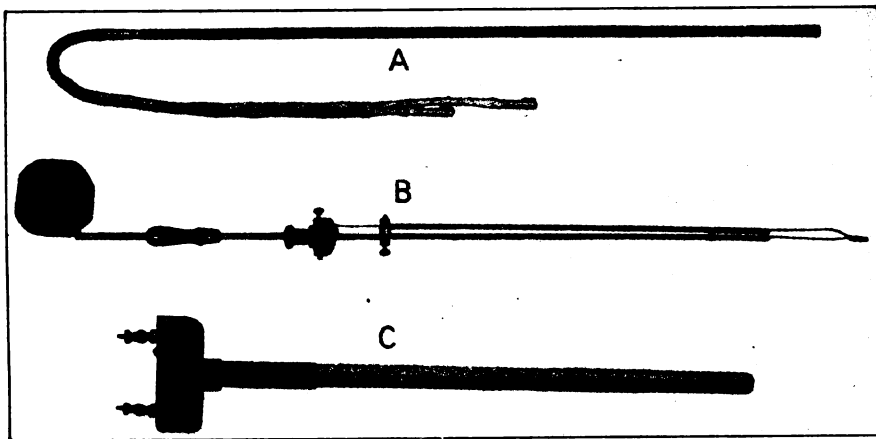

FIG. 1.—COUPLES MADE BY THWING INSTRUMENT CO. A. IRON-CONSTANTAN COUPLE IN IRON PROTECTING TUBE FOR USE BELOW 900° C. B. EXTENSIBLE CHROMEL-ALUMEL COUPLE FOR MOLTEN BRASS; THE EXPOSED JUNCTION, WHICH IS IMMERSSED IN THE MOLTEN BRASS WITHOUT PROTECTION, IS RENEWED FROM THE MAGAZINE OF RESERVE WIRE. C. PORCELAIN OR FUSED SILICA PROTECTING TUBE AND MOUNTING FOR RARE-METAL COUPLES.

tures separate tubes should be used. The hot junction of the couple is made by fusing the two wires in an arc or oxygen-gas flame. The couple and insulating tube are inserted in a small outside protecting tube of porcelain, glazed on the outside only, or of fused silica, hemispherically closed at one end. On the open end of the protecting tube may be mounted the head of the couple, which serves as a handle and as a support for rigidly holding the wires. The couple wires frequently extend beyond the head so that their ends may be maintained at some controlled cold-junction temperature. Usually the wires terminate in binding posts on the couple head, in which case the cold-junction temperature may be controlled by water jackets, or may be allowed to remain that



of the surroundings, or the couple may be fitted with one of the various devices, discussed later, for the elimination of cold-junction errors.

Base-metal couples for laboratory use may be constructed in much the same manner, and may be made of wire as small as No. 20 (0.8 mm.) or of much smaller wire for certain types of research at lower temperatures. Small wires, however, are readily and completely oxidized at high temperatures, so that for continuous operation in industrial installations the couples are made of No. 8 (3.3 mm.) or No. 6 (4 mm.) wire, or of still

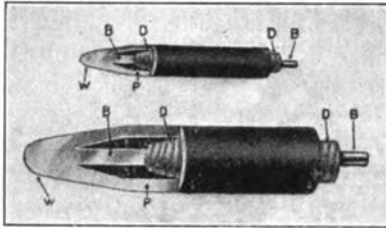

FIG. 2.—END SECTION OF THE WILSON-MAEULEN PYOD. THE OUTER TUBE *P*, WHICH IS ONE ELEMENT, IS WELDED TO THE OTHER ELEMENT *B* AT *W*. THE INNER ROD IS INSULATED FROM THE TUBE BY ASBESTOS CORD.

larger wire when there is danger of contamination. The hot junction is fused, and usually the two wires are twisted for a few turns at the hot junction in order to give greater mechanical strength to the joint. The two wires are insulated by fireclay insulating tubes, or by asbestos sleeving or cord, and are connected to a suitable couple head forming the cold junction. For severe use it is necessary to encase the couple in a protecting tube of steel, chromel, porcelain, fireclay, etc.

A different form of base-metal couple, known under the trade name of "pyod" consists of an outer tube of iron and an inner wire or rod of

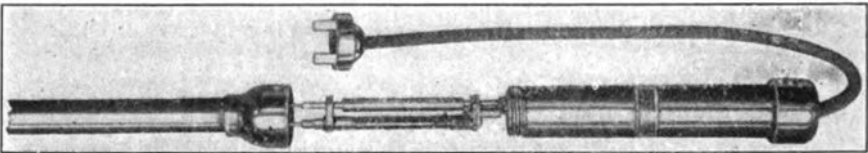

FIG. 3.—INTERIOR OF THERMOCOUPLE HEAD MADE BY BEIGHLEE ELECTRIC Co., SHOWING THE COLD-JUNCTION COMPENSATOR DESCRIBED UNDER FIG. 23.

constantan. The two are fused at one end into a neat joint forming the hot junction, and are insulated from each other up to the couple head, or cold junction. The couple is thus mechanically stronger than one formed of two wires, and when used without an additional protecting tube, is somewhat less liable to contamination than the bare-wire couple. Pyod couples should nevertheless be protected by outer tubes if subjected to severe furnace conditions. Figs. 1 to 3 illustrate several couples and mountings. It is sometimes desirable to bend a couple,

usually a mounted couple will stand bending, but one should first remove porcelain tubes or insulators liable to be broken by the process.

### INDICATING INSTRUMENTS

The indicating instruments connected to the thermocouple are of three general types; those operating upon the galvanometric principle, as an ordinary voltmeter; those operating upon the potentiometric principle; and those operating upon a combination of these two principles. The first two types of instrument have been made automatically recording, as will be discussed elsewhere.

#### *Galvanometer Method*

Galvanometers for measuring the electromotive force developed by a thermocouple usually operate on the d'Arsonval principle, having a moving coil mounted between the poles of a permanent magnet. Different methods for mounting the coil are employed. The coil may be suspended both above and below by phosphor-bronze suspensions, and although many foreign instruments of this type have proved delicate, one of the latest forms of American double-suspension galvanometer may be subjected to severe handling without injury. The combination of an upper suspension and a lower pivot has been used extensively. A unipivot system is employed by one English and one American manufacturer. The pivot is at the center of the coil and the center of gravity of the whole moving system is at the point of the pivot.

The scale of the instrument may be graduated to read e.m.f. or temperature. By adding a series resistance, mounted inside the galvanometer case, and an extra terminal, two scale ranges may be utilized, one for base-metal and the other for rare-metal couples. Indicators may be obtained in either the switchboard or the portable type, the former being desirable for permanent installations. Usually high precision is not required of an instrument of the switchboard type, so that the graduations may be coarse.

*Resistance of Indicating Instrument.*—When operated at the highest safe working temperatures, most base-metal couples develop a maximum e.m.f. of less than 50 to 70 millivolts, and the LeChatelier couple about 16 millivolts; a very sensitive indicator or millivoltmeter is therefore required. On the other hand, the instrument must be able to withstand rough handling, and these opposing conditions are difficult to satisfy. The deflection registered by the millivoltmeter is approximately proportional to the current flowing through the coil; hence, if the resistance of the total thermoelectric circuit is low, relatively large currents are obtained, resulting in a torque high on the movable coil. When the current is large, the construction of the indicator may therefore be robust;

strong springs for balancing the turning moment of the coil may be employed, and less attention need be given to the friction of the pivots in their bearings. The torque may be made high without greatly increasing the resistance of the circuit by using a great number of turns of copper wire in the coil. Copper possesses a large temperature coefficient of resistance, so that ordinarily the calibration of an instrument having its entire electrical circuit of copper would be affected by the temperature. However, by the use of shunt and series resistances of a certain type it is possible to reduce these errors to a negligible amount. Thus it is not difficult to construct a sufficiently sensitive millivoltmeter of low resistance. The objection, from the pyrometric standpoint, to such an instrument used as a simple galvanometer has led to the development of indicators having considerable resistance. These are made by placing a high resistance, of zero temperature coefficient, such as manganin, in series with the coil, and by increasing the number of turns on the moving coil to compensate for the decrease in sensitivity arising from the increased resistance. The so-called swamping resistance, having zero temperature coefficient, may be so proportioned with respect to the copper that, due account being taken of the temperature coefficient of elasticity of the springs, the instrument as a whole possesses a negligible temperature coefficient. The high resistance greatly diminishes the current flowing through the coil and thus reduces the deflection; hence, attention must be given to the elimination of bearing friction, and the instrument is necessarily more delicate than a low-resistance indicator of the same type. The advantage of an instrument having a high resistance is demonstrated by the following discussion.

The current flowing in the circuit is equal to  $e \div R$ ,  $e$  being the electromotive force developed by the couple and  $R$  the total resistance of the circuit. While the temperature of the furnace remains fixed,  $e$  is constant, but the deflection of the instrument will be affected by changes in resistance; hence any variation in  $R$  which produces a change in the reading of the instrument would be interpreted as a change in the temperature of the furnace. The total resistance of the circuit consists of three parts,  $R_o$ , of the millivoltmeter,  $R_L$ , of the line, and  $R_c$ , of the couple. If these elements are properly proportioned, the effect upon the reading of the indicator, due to any changes in the total resistance likely to occur, can be reduced practically to zero. This condition is realized when the resistance of the galvanometer is sufficiently high compared with the resistance of the external circuit. Suppose that the indicator has a scale graduated to read the potential difference at its terminals. The relation between the reading of the instrument  $e_0$  and the true e.m.f.  $e$  of the couple is given by the following equation:

$$e_0 = \frac{R_o}{R_o + R_c + R_L} e$$

Thus, if  $R_g$  is large compared to  $R_c + R_L$ , the ratio  $R_g \div (R_g + R_c + R_L)$  is practically 1, and the reading of the galvanometer gives the true e.m.f. of the couple.

Robust indicators are now obtainable having resistances of 300 to 1200 ohms. Consider, for example, an installation in which the galvanometer resistance is 300 ohms, couple resistance 1 ohm, line resistance 1 ohm.

$$e_0 = \frac{R_g}{R_g + R_c + R_L} e = \frac{300}{300 + 1 + 1} e = 0.993e$$

Thus the reading of the instrument gives the true electromotive force of the couple to within 0.7 per cent. Instruments having a resistance as low as 10 ohms, or less, are in extensive use. Suppose a galvanometer of 10-ohm resistance were used in the circuit described above:

$$e_0 = \frac{R_g}{R_g + R_c + R_L} e = \frac{10}{10 + 1 + 1} e = 0.83e$$

Thus the e.m.f. indicated by the instrument would be 17 per cent. less than the true e.m.f. of the couple. Such large errors are compensated by arbitrarily graduating the scale to read the true e.m.f. of the couple when the external resistance has a certain value. Bad contacts, deterioration of the couple from oxidation, change in depth of insertion, temperature coefficient of the copper lead wires, etc. may at any time alter the resistance of the external circuit. Let us compare the behavior of the 300-ohm instrument and the 10-ohm instrument, assuming both are compensatingly graduated to read correctly for an external resistance of 2 ohms, when for one of the several reasons cited above the external resistance varies slightly. The relation between the potential drop  $e_0$  across the terminals of the galvanometer and the e.m.f.  $e$  of the couple is as follows, where the total line resistance  $R' = R_c + R_L$ .

$$e_0 = \frac{R_g}{R_g + R'} e$$

Hence  $e_0$  is always less than  $e$ . Suppose, however, for a certain line resistance  $R'_0$  the scale of the indicator is arbitrarily graduated so that the reading  $e'$  equals the true  $e$  of the couple. The relation between the scale reading and the potential drop across the terminals of the instrument must be, accordingly

$$e' = \frac{R_g + R'_0}{R_g} e_0 = F e_0$$

where  $F$  is a constant. The graduations on the scale are such that for any deflection of the pointer the scale reading is  $F$  times the potential drop across the galvanometer terminals. On substituting this value of  $e_0$  in the above equation we obtain:

$$e' = F e_0 = \frac{F R_g}{R_g + R'} e$$

The following table shows the percentage error in the indicated  $e'$ , computed from the above equation, when the line resistance  $R'$  has the values 1, 2, 3 and 4 ohms respectively, when  $R_o$ , the resistances of the indicators, are 300 and 10 ohms respectively, and  $R'_o$ , the normal line resistance, is 2 ohms.

TABLE 1.—*Error Due to Change in Line Resistance*

| Line Resistance, Ohms | Per Cent. Error in Indicator Reading |         | Error in Degrees at 1000° C. |         |
|-----------------------|--------------------------------------|---------|------------------------------|---------|
|                       | 300 Ohms                             | 10 Ohms | 300 Ohms                     | 10 Ohms |
| 1                     | +0.33                                | +9.1    | +3.3                         | +91     |
| 2                     | 0                                    | 0       | 0                            | 0       |
| 3                     | -0.33                                | -7.7    | -3.3                         | -77     |
| 4                     | -0.66                                | -14.3   | -6.6                         | -143    |

Thus, when both instruments read correctly for an external resistance of 2 ohms, if the external resistance is increased by 1 ohm, the low-resistance indicator is in error by 7.7 per cent. or about 77° at 1000° C., while the high-resistance instrument still reads practically correct. This emphasizes the importance of using a galvanometer having a resistance of 300 ohms or more. In actual operation the line resistance may change by several ohms on account of bad contacts and deterioration of the thermocouple.

It must not be inferred that all high-resistance indicators are necessarily superior to all indicators of low resistance. Superior workmanship and certain mechanical details may lead to the choice of a particular instrument having a resistance less than 100 ohms, especially in the case of recording millivoltmeters; nevertheless the resistance of the instrument is a matter of extreme importance, and a galvanometric indicator of low resistance is always subject to the errors arising from small changes in the resistance of the circuit. This does not apply to the compensated galvanometer, or to semi-potentiometric instruments described later. Figs. 4 and 5 represent typical American indicating galvanometers.

*Portable Test Set.*—On account of the errors which may be introduced in the reading of a galvanometer by variation in resistance of the line or couple, it is important to have some means for measuring this resistance occasionally. Every plant requiring a large thermocouple installation with simple galvanometric indicators should have a portable Wheatstone bridge or "test set" for this purpose. Fig. 6 illustrates a simple and inexpensive instrument made by Leeds & Northrup Company. Disconnect the pyrometer indicator from the circuit and connect the two line wires to the X terminals of the test set; note the measured resistance. Reverse the + and - lead wires at X and obtain a new reading; the

mean of the two observations is the resistance of the circuit, the two readings being different because of the e.m.f. developed by the couple. If two indicators, or an indicator and a recorder, are operated in parallel

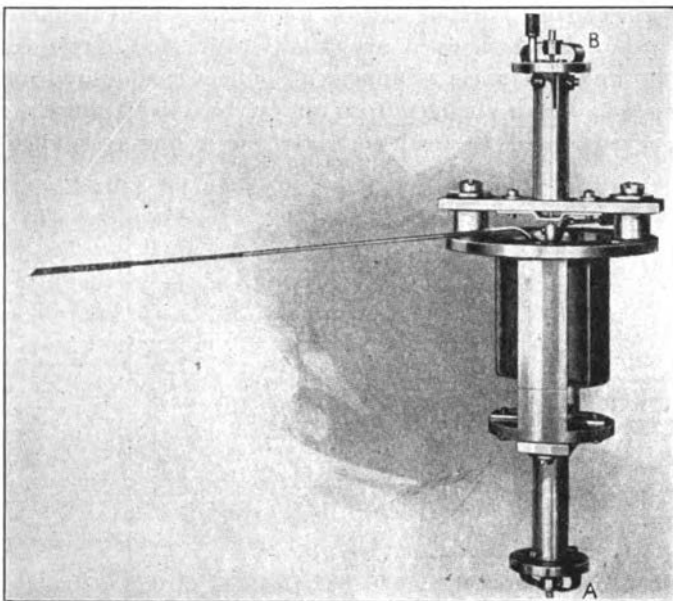

FIG. 4.—MOVING ELEMENT OF THE ENGELHARD INDICATOR. A DOUBLE-SUSPENSION INSTRUMENT IN WHICH THE SUSPENSIONS ARE KEPT UNDER TENSION BY THE SPRINGS *A* AND *B*. THE TENSION IS SUFFICIENT TO MAINTAIN AXIAL ALIGNMENT OF THE COIL WITHOUT PRECISE LEVELING. THE INSTRUMENT IS VERY ROBUST AND HAS A HIGH RESISTANCE, ABOUT 50 OHMS PER MILLIVOLT.

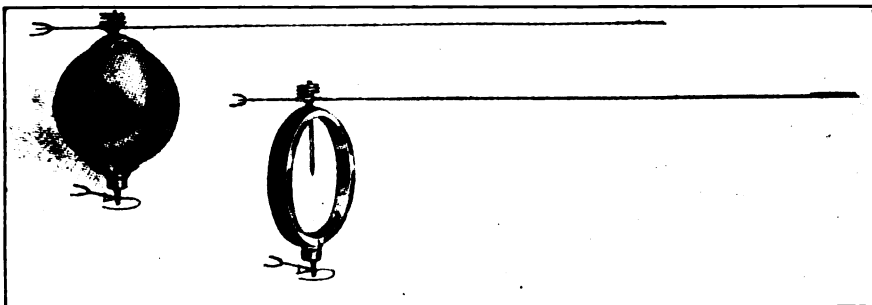

FIG. 5.—SINGLE-PIVOT MOVEMENT USED IN WILSON-MAEULEN INDICATORS THE PIVOT IS AT THE CENTER OF GRAVITY OF THE MOVING SYSTEM.

on the same circuit, care must be taken that both instruments are disconnected from the circuit during the measurement of the resistance. If the resistance of the line and couple is found to be much higher than that for which the indicator was designed, short-circuit the line at the

cold junction and determine whether the fault is in the couple or in the line; if in the former, the couple usually should be replaced. By such occasional observations serious faults may be detected long before they would be suspected from the low values in the indicated temperatures.

*Galvanometer with Variable Series Resistance.*—Galvanometers, especially those of low resistance, are usually calibrated to read correctly for a definite line resistance. Suppose an indicator is desired for a line the resistance of which changes from almost zero to 10 ohms. The instrument is calibrated to read correctly for a line resistance of 10

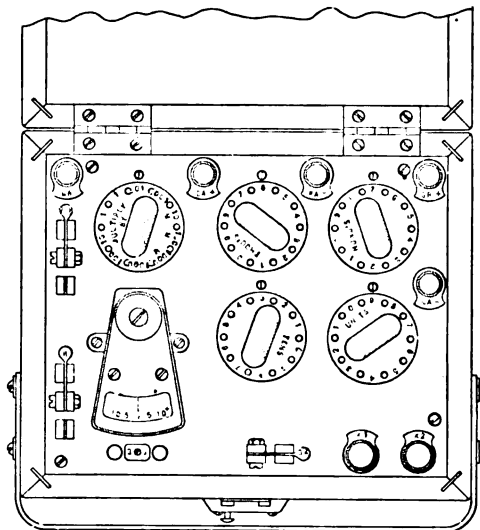

FIG. 6.—“TEST SET” OR WHEATSTONE BRIDGE FOR MEASURING LINE RESISTANCE.  
(Leeds & Northrup.)

ohms, and in the galvanometer case, in series with the line, is a variable resistance which can be adjusted by hand until the sum of the line resistance and the variable resistance equals 10 ohms. The dial of the variable resistance is graduated to read the amount of resistance cut out of the circuit; hence it should be set at the resistance of the line and couple, which value may be determined by a test set. This method is of great value for precision work with a galvanometric indicator. The principal objection to it, which also applies to all galvanometric indicators thus far described when used for accurate measurements, is the necessity for measuring the resistance of the line and couple. This objection is avoided and other desirable features have been added in the instrument next mentioned.

*Harrison-Foote Compensated Indicator.*—This instrument, manufactured by The Brown Instrument Co., is illustrated in a simple form by Fig. 7. The circuit *CDGF* is an ordinary millivoltmeter in which *G* represents

the moving coil, in series with which is an adjustable rheostat  $CB$ . The maximum value  $r_5$  of this resistance is chosen equal to the maximum value of the resistance of the line and couple likely to occur in practice; a convenient value is 15 ohms. With the slide of the rheostat set for the maximum resistance,  $r_1 = r_5$ , the instrument is calibrated in terms of the potential drop across  $AH$ . Hence when the instrument is connected through the line having resistance  $L$  to the couple having resistance  $T$ , the rheostat  $CB$  must be adjusted until  $r_1 + L + T = r_5$ . The scale reading then gives correctly the e.m.f.,  $e$ , of the couple, or the correct temperature if the scale is graduated in degrees. This adjustment is

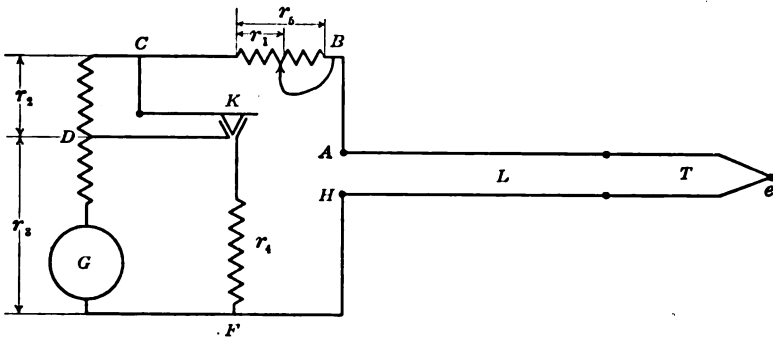

FIG. 7.—HARRISON-FOOTE COMPENSATED INDICATOR (BROWN INSTRUMENT CO. IMPROVED HEATMETER).

made in the following manner. By depressing the key  $K$  a portion of the galvanometer resistance  $r_2$  is short-circuited and the rest of the resistance  $r_2$ , containing the moving coil, is shunted by a resistance  $r_4$ . If  $e'$  represents the potential drop across  $DF$  when the key is open, and  $e''$  represents the drop when the key is closed, we obtain :

$$e' = \frac{er_3}{L + T + r_1 + r_2 + r_3}$$

$$e'' = \frac{er_3r_4}{(L + T + r_1)(r_3 + r_4) + r_2r_4}$$

If  $r_1$  is so adjusted that these two potential drops, and hence the deflections of the indicator, are the same, we have, on equating,

$$L + T + r_1 = \frac{r_2r_4}{r_3} = \text{a constant.}$$

If now, in the construction of the instrument,  $r_2r_4 \div r_3$  is made equal to  $r_5$ , the above setting makes  $L + T + r_1 = r_5$ , the adjustment required in order that the reading of the scale may give the true e.m.f. of the couple.

The ease with which the proper setting can be obtained is greatly improved by making  $r_2 \div r_4$  equal to from 5 to 10. Suppose it be made equal to 9. Then if  $r_1$  is improperly adjusted, and the instrument reads



in error by, say,  $\delta e$  when  $K$  is open, on depressing the key the reading is changed by  $9\delta e$ . If now  $r_1$  is readjusted with the key depressed until the reading takes its initial value, the error with the key open is reduced to  $\delta e \div 10$ . The process for operating the instrument is accordingly as follows:

1. Read the instrument with the key open.
2. Close the key and adjust the rheostat  $r_1$  until the instrument reads approximately the same as in 1.
3. Repeat 1 and 2 if necessary.

When  $r_3 \div r_4 = 9$  it is rarely necessary to make a second adjustment. In position 1 the instrument acts as an ordinary galvanometer. The single setting in position 2 reduces the error in the ordinary galvanometer by the factor  $\frac{1}{10}$ , which is usually sufficient. The adjustment for the proper external resistance, if desired, can be made with 10 times the precision necessary. Variation in line resistance, which might give rise to very serious errors, is thus easily and accurately controlled by a simple mechanical adjustment.

The device is readily applicable to multiple installations of different line resistances. For multiple point recorders and indicators, as many resistances  $BC$  may be employed as there are couples. These may be inexpensive rheostats, having a resistance of approximately 15 ohms each, located in each line between the couple and the selective switch; they may be adjusted in the manner described whenever convenient or necessary. A suitable proportioning of resistances for a 300-ohm indicator would be:  $r_2 = 135$  ohms;  $r_3 = 150$  ohms;  $r_4 = 150 \div 9 = 16\frac{2}{3}$  ohms;  $r_5 = 15$  ohms;  $r_2 + r_3 + r_5 = 300$  ohms.

If the simple indicator has the proper ratio of manganin to copper, its temperature coefficient is practically zero. In that case the shunt  $r_4$  should have the same manganin to copper ratio as the portion of the galvanometer resistance comprised by  $r_3$ , thus giving the instrument as a whole a zero temperature coefficient. If the simple indicator does not have a zero temperature coefficient it is possible, by increasing the proportion of manganin in  $r_4$ , to compensate for the temperature coefficient of the resistance  $r_3$ .

#### *Potentiometer Method*

The potentiometer method is the most accurate for measuring the e.m.f. of a thermocouple. The fundamental principle is illustrated by Fig. 8. A constant current from the battery  $B$  flows through the slide-wire resistance  $abc$ . One wire of the couple  $T$  is connected to the movable contact  $b$  and the other wire, in series with a sensitive galvanometer, is connected to  $a$ . The contact  $b$  is moved until the galvanometer reads zero, showing that no current is flowing through the thermocouple circuit; the true e.m.f. of the couple is then equal to the potential drop across

$ab$ , and this is computed from  $e = ir$ , where  $i$  is the current flowing through the resistance  $r = ab$ . The slide wire may be graduated to read millivolts or temperature directly, if the current is always adjusted to a definite value; various devices are employed for this purpose. An ammeter will answer, but the usual method is to obtain a preliminary setting by replacing the thermocouple by a constant known source of e.m.f., such as a standard cell. The galvanometer  $G$  is always used as a zero instrument in a strictly potentiometric circuit; hence it requires no calibrated scale and no attention need be given to the constancy of its sensitivity, provided it is always sufficiently sensitive to serve its purpose. These

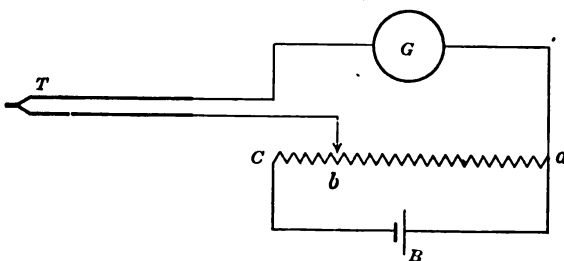

FIG. 8.—SIMPLE WIRING DIAGRAM FOR POTENTIOMETRIC INDICATOR.

requirements are easily met, and the entire potentiometer, including galvanometer, battery, standard cell, slide wires, etc. are mounted in a case not much larger than that of a millivoltmeter. The instrument is as mechanically robust as many indicators operating on the galvanometric principle.

The potentiometer method has several important advantages. The scale is easily made very open, thus permitting accurate readings; the instrument described below has a scale length of 40 cm. The calibration of the scale is in no way dependent upon the constancy of magnets, springs, or jewel bearings, nor upon the level of the instrument. From the pyrometric standpoint, the greatest advantage is the complete elimination of errors due to changes in the resistance of the couple or of the lead wires; no matter what resistance is inserted in the thermocouple circuit, the reading of the potentiometer still gives the true e.m.f. of the couple although, of course, the sensitivity of the instrument is decreased by excessive resistance. The only objections to the potentiometer are its slightly greater initial cost and the fact that usually a manual adjustment must be made to obtain a setting. In the potentiometric recording instrument, however, all the various manipulations may be performed mechanically, even to the balancing against the standard cell.

Fig. 9 illustrates the portable potentiometer manufactured by Leeds & Northrup, and Fig. 10 shows the wiring diagram. The galvanometer should be adjusted to read zero on open circuit. At intervals of a few

hours the setting on the standard cell should be made. This is done by depressing the key *SC* and adjusting the resistance *RR'* by turning the knurled head on the left of the case until the galvanometer reads zero. The thermocouple is connected to the terminals *TC* and the e.m.f. or temperature is observed directly on the dial by depressing the key marked



FIG. 9.—PORTABLE POTENTIOMETER. (*Leeds & Northrup.*)

*TC* and turning the main dial until the galvanometer indicates zero. The key *TC* and the key *SC* should never be depressed at the same time. These instruments can be made in any scale range or with multiple scale ranges adapted to various types of couple.

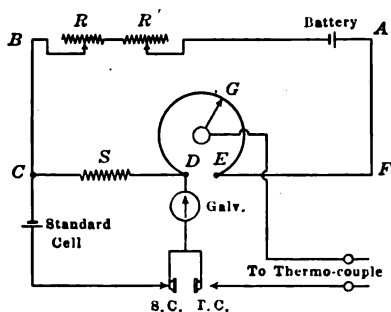

FIG. 10.—WIRING DIAGRAM OF LEEDS & NORTHRUP PORTABLE POTENTIOMETER.

### *Semi-potentiometer Method*

It is possible by means of a single galvanometer or millivoltmeter to measure the e.m.f. of a couple potentiometrically. Thus, in Fig. 8, by using a shunted galvanometer first in the main circuit *abcB*, as an ammeter, the initial setting for a standard current is obtained. Then the instrument, without the shunt, is placed in the position *G* and the con-

tact *b* is moved along the graduated slide wire until a zero setting is obtained. The objection to this method is that if the millivoltmeter is sufficiently sensitive to be used as a zero instrument it is not likely to be reliable as an ammeter, and vice versa. Various modifications of this device, however, have proved valuable in thermoelectric pyrometry.

*Northrup Pyrovoltter.*—Referring to Fig. 11 (*a*), the dry cell *B* contained in the case of the instrument sends a current through the variable resistance *R* and the fixed resistances *C* and *S*. The resistance *C*, of copper, is equal in value to the resistance of the copper coil in the moving

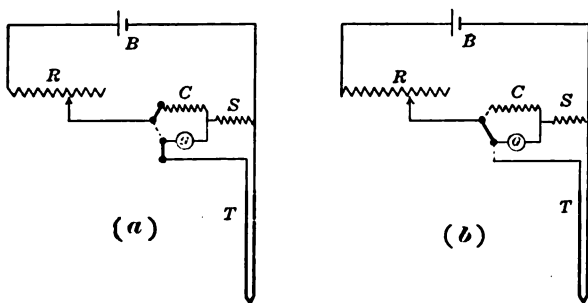

FIG. 11.—WIRING DIAGRAM OF PYROVOLTER.

element of the galvanometer *G*. The couple *T* is connected, in series with the moving coil of the galvanometer, across the resistance *S*. The resistance *R* is adjusted until the galvanometer reads zero, by turning the knurled head in the lower right-hand corner of the instrument. The key in the lower left-hand corner is then depressed, which throws the thermocouple and the resistance *C* out of the circuit, and replaces *C* by the galvanometer *G* having equivalent resistance, Fig. 11 (*b*). The galvanometer is now deflected by an amount proportional to the current flowing through it, which in turn is proportional to the potential drop across *S*. The scale of the instrument is graduated to read the potential drop over *S*, and since this potential difference was made equal to the e.m.f. of the couple by the initial setting for zero deflection, the galvanometer indicates directly the true e.m.f. of the couple. The initial setting is not altered by introducing resistance into the thermocouple circuit, so that the instrument is really a form of potentiometer. The scale may be graduated to indicate temperature for any particular type of couple, and the instrument may be obtained with several different scale ranges.

*Northrup Continuously Deflecting Pyrovoltter.*—This instrument is the ordinary pyrovoltter with the addition of an extra key and an adjustable resistance. After the e.m.f. of the couple has been determined by the pyrovoltter method just described, the galvanometer, in series with this resistance, is connected directly to the thermocouple terminals. The

resistance is then adjusted until the reading of the instrument is the same as that determined by means of the pyrovolter.

*Brown Precision Heatmeter* (old form, prior to May, 1919).—Making use of somewhat differently arranged circuits, this instrument is identical in principle with the Northrup continuously deflecting pyrovolter. The wiring diagram is given in Fig. 12. By means of suitable switches the electrical connections are thrown successively into the three positions illustrated, No. 3 being the final working position in which the couple is connected directly to the millivoltmeter through a definite line resistance. In the first position, the e.m.f. of the couple is balanced against the po-

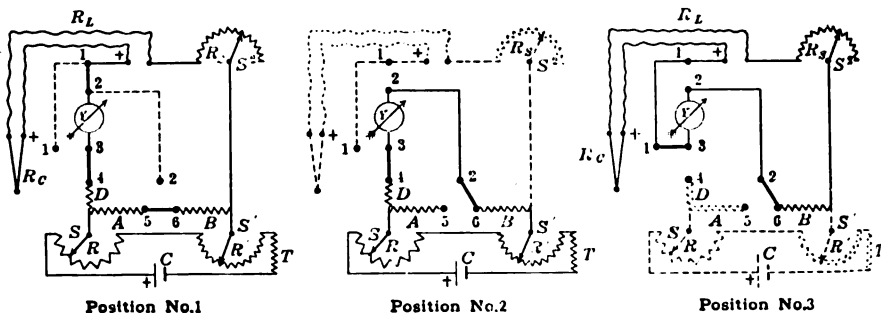

FIG. 12.—WIRING DIAGRAM OF THE HEATMETER. (*Brown Instrument Co.*)

tential drop between *S* and *S'* by varying *R* and *R'* until the galvanometer *Y* indicates zero. In position 2, the thermocouple circuit is cut out and the galvanometer is connected to the points *S* and *S'*; the scale of the galvanometer is so divided as to read the potential differences across *SS'*. This potential difference is not altered by switching from position 1 to 2, since the resistance *D* is so chosen that  $A = Y + D$ . The total resistance of the galvanometer circuit in position 2 is  $D + Y + B$ . In position 3 the resistance *R*<sub>1</sub> is adjusted until the total resistance of the galvanometer circuit is equal to that of position 2, viz.:  $D + Y + B = R_c + R_L + R_1 + B + Y$ . This adjustment is obtained when the reading of the galvanometer is not altered by switching from position 2 to 3. Thus with *R*<sub>1</sub> properly adjusted, the reading of the indicator in position 3 gives directly the true e.m.f. or temperature of the couple so long as the line resistance  $R_L + R_c$  remains unchanged. This instrument is now superseded by the Harrison-Foote compensated indicator, called the Brown Improved Heatmeter.

### *Deflection Potentiometer Method*

A potentiometer is ordinarily used as a null instrument, the e.m.f. of the couple being exactly balanced by the potential drop over a resistance through which a current from a battery is flowing. The objection some-

times raised against the ordinary potentiometer for industrial installations is that it requires a manual adjustment of a dial or slide wire every time an observation is made. This objection is practically eliminated in the deflection potentiometer, which may be so constructed as to embody the accuracy of the ordinary potentiometer and the convenience of the galvanometer indicator.

In the deflection potentiometer, part of the e.m.f. of the couple is balanced against the potential drop over a resistance through which a current is flowing, while the remainder is indicated by the deflection of a galvanometer in series with the couple. For example, the instrument may be constructed with a dial of, say, 16 points, representing potential differences from 0 to 15 millivolts, and a galvanometer which gives full-scale deflection on 1 millivolt. The dial is set to the approximate e.m.f. developed by the couple, and the dial reading, combined with the galvanometer reading, gives the true e.m.f. of the couple. In many industrial processes the temperature of the couple will vary only slightly during several hours, so that a new dial setting is infrequently required. Thus the method for obtaining the e.m.f. of the couple is nearly as simple as when an ordinary galvanometric indicator is used.

The theory of the deflection potentiometer has been developed in detail by Brooks.<sup>1</sup> As applied to e.m.f. measurements, the simple theory may be deduced as follows. It has been shown in the case of an ordinary potentiometer that if an e.m.f.  $e'$  is exactly balanced against the potential drop in a resistance wire of a potentiometer, the value of  $e'$  will be given by the equation

$$e' = \frac{Er_1}{r_1 + r_2} \quad (1)$$

where  $E$  is the e.m.f. of the battery used to furnish the current in the resistance wire,  $r_1$  is the resistance of this wire, and  $r_2$  is all other resistance in the battery circuit. Usually the value of  $e'$  is indicated by figures on the dials or slide wire of the potentiometer. If  $e'$  changes to a new value  $e$  and the potentiometer remains adjusted as before, a current will flow through the galvanometer and thermocouple, causing the galvanometer to deflect. The currents now flowing through  $r_1$  and  $r_2$  are unequal and are different from the original value. The currents flowing in the different branches of the circuit are indicated by Fig. 13, in which  $T$  represents a thermocouple,  $G$  the galvanometer,  $abcB$  the potentiometer,  $R$  the resistance of the galvanometer and thermocouple,  $e$  the e.m.f. of the couple, and  $B$  the battery.  $I$  represents the current flowing from  $a$  to  $b$  through  $r_1$ , and  $i$  the current flowing through the galvanometer. Since

<sup>1</sup> U. S. Bureau of Standards *Sci. Papers* 33, 79, 172, 173.

the sum of the e.m.f.'s and potential drops around any closed circuit must equal zero the following two equations may be written:

$$E = (r_1 + r_2) I + r_2 i \tag{2}$$

$$e = r_1 I - R i \tag{3}$$

Substituting the value of  $I$  from equation (2) in equation (3), and subtracting this value of  $e$  from the value of  $e'$  given by equation (1), we obtain:

$$e' - e = i \left( R + \frac{r_1 r_2}{r_1 + r_2} \right) \text{ or } i = \frac{e' - e}{R + \frac{r_1 r_2}{r_1 + r_2}} \tag{4}$$

Hence, when a potentiometer is not balanced, a current will flow through the galvanometer equal to the difference between the setting of the potentiometer and the e.m.f. of the thermocouple, divided by the total resistance  $R + r_1 r_2 \div (r_1 + r_2)$  in the galvanometer circuit.

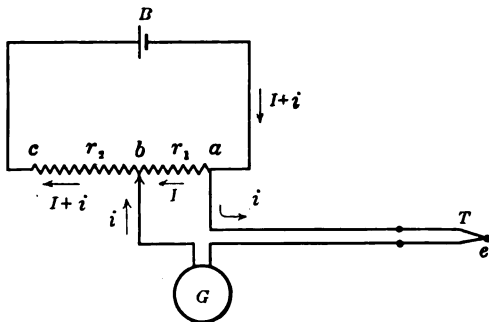

FIG. 13.—UNBALANCED POTENTIOMETER CIRCUIT.

Representing the resistance within the potentiometer,  $r_1 r_2 \div (r_1 + r_2)$ , by  $r_p$ , the resistance of the galvanometer circuit will be  $R + r_p$ . If the galvanometer is to indicate correctly the unbalanced e.m.f.  $e' - e$  at all values of  $e'$ , its sensitivity must remain constant, which requires that  $R + r_p$  remain constant. The value of  $r_p$  will change as point  $b$  is moved nearer to  $a$  or  $c$ , thus altering the values of  $r_1$  and  $r_2$ . Hence it is necessary to put in the galvanometer circuit a variable resistance which compensates for these changes in  $r_p$ .

In instruments of low range, suitable for thermocouples,  $r_1$  is made small compared with  $r_2$ . Since  $r_p = r_1 r_2 \div (r_1 + r_2)$  if  $r_2$  is sufficiently large compared with  $r_1$ , we may neglect the term  $r_1$  in the denominator and the above equation reduces to  $r_p = r_1$ . For such an instrument the compensating resistance in series with the galvanometer is decreased by the value of  $r_1$ , at any dial setting. Instruments of this type have been designed by Brooks and by White. The compensating resistance is mounted as an integral part of the dial, so that turning the dial changes

the e.m.f. setting and at the same time adjusts the compensating resistance in the galvanometer circuit to its proper value.

Fig. 14 illustrates a deflection potentiometer for thermocouples, made by the Taylor Instrument Co., and known as the "range control board." The galvanometer  $G$  is provided with two scales, in the ranges 0 to 500° and 450 to 950° respectively. The galvanometer circuit is connected at fixed points  $a$  and  $b$  within the potentiometer, and when the instrument is to operate in the lower range the battery circuit is opened. Thus the potentiometer setting  $e'$  is made zero without changing the value of  $r_1$ . In this range the instrument operates as an ordinary galvanometric indicator. If the temperature of the thermocouple is above

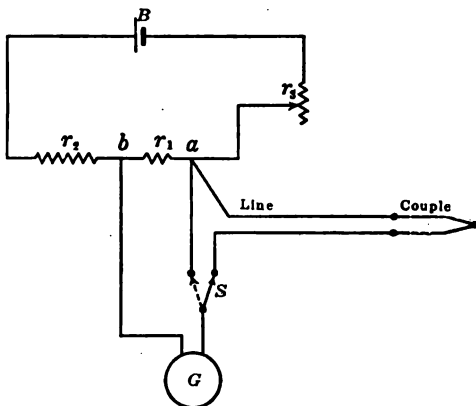

FIG. 14.—RANGE CONTROL BOARD. (Taylor Instrument Co.)

450° or 500° C., a current of such magnitude is made to flow through  $r_1$  that the potential drop  $e'$  across  $r_1$  balances the e.m.f. developed by the couple when at 450° C. The temperature will then be indicated on the high-range scale.

The total resistance of the galvanometer circuit is almost exactly equal when operating in either range, since when operating in the upper range the shunting effect of  $r_2 + r_3$  on  $r_1$  is negligible. Since a separate galvanometer scale is provided for each setting of the potentiometer (0 and  $e'$ ), it is not really necessary that the sensitivity be equal in the two cases.

For the high range, the current from the battery is adjusted by connecting switch  $S$ , as shown by the dotted line, and setting  $r_3$  so that the galvanometer deflects to a marked position. Provision must be made for reversing the direction of the current from the battery through the galvanometer after this adjustment has been made. The figure does not show this, nor the switch for opening the circuit when the instrument is to be used for the low range.

Fig. 15 shows the Leeds & Northrup instrument, which is a modification of a design by W. P. White. When a range suitable for thermo-



couples is used, and the condition of a balanced Wheatstone bridge with arms of equal resistance is never far departed from, the resistance of that part of the galvanometer circuit which is constituted by the potentiometer usually remains constant within a few tenths of 1 per cent. The value of this resistance, for instruments of the same range and using the same battery current, is considerably higher than that of the designs previously discussed. The following table shows suitable values of the

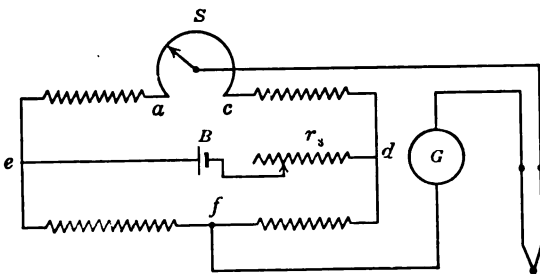

FIG. 15.—THERMOCOUPLE DEFLECTION POTENTIOMETER. (Leeds & Northrup Co.)

different resistances which will give, to a satisfactory degree, conditions of a nearly balanced Wheatstone bridge with equal arms:

|                                       |            |
|---------------------------------------|------------|
| Resistance <i>e</i> to <i>a</i> ..... | 475 ohms   |
| Resistance <i>a</i> to <i>c</i> ..... | 70 ohms    |
| Resistance <i>c</i> to <i>d</i> ..... | 455 ohms   |
| Resistance <i>e</i> to <i>f</i> ..... | 475 ohms   |
| Resistance <i>f</i> to <i>d</i> ..... | 525 ohms   |
| Resistance <i>dBe</i> .....           | Immaterial |

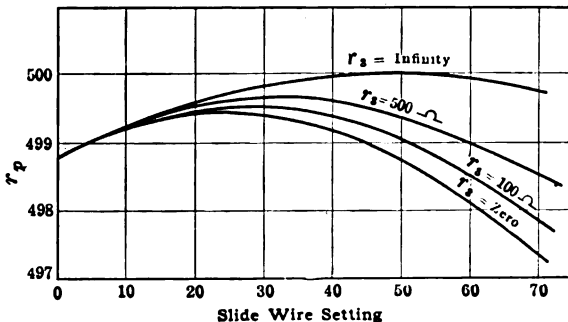

FIG. 16.—CHANGE OF  $r_p$  WITH SLIDE-WIRE SETTING OF THE LEEDS & NORTHROP DEFLECTION POTENTIOMETER.

These values may be divided or multiplied by any number, in order to obtain any desired range of currents and a proper critical damping resistance for the galvanometer; the above design allows a range of 70 millivolts over the slide wire. The curves in Fig. 16 show the manner in

which the resistance  $r_p$  of that part of the galvanometer circuit consisting of the parallel paths within the potentiometer varies with different settings of the slide wire, ranging from 0 to 70 millivolts, and with resistance  $r_s$  in the outside battery circuit  $dBe$ , varying from zero to infinity. Actually  $r_s$  would not be likely to vary beyond the limits 100 and 500 ohms. An average value for  $r_p$  may be obtained by setting the slide wire to read about 7 millivolts, and the variation of  $r_p$  from this value will generally be less than 0.1 per cent., whatever the setting of the slide wire on the battery resistance  $r_s$ . Therefore, if the galvanometer is calibrated when the slide is set to read 7 it will be more nearly accurate with varied settings and adjustments of the instrument. Since  $r_p$  constitutes only part of the galvanometer circuit, the galvanometer sensitivity will remain constant within proportionally less than 0.1 per cent.

This instrument is designed primarily so that the slide wire  $S$  may be set to read the exact temperature required. The galvanometer  $G$  accordingly indicates the departure of the actual temperature from the temperature desired. It thus serves as a very convenient guide to the operator of a furnace, who can see at a glance by how many degrees the temperature at any time differs from the temperature at which the furnace should be operated.

The Beighlee Electric Company makes a deflection potentiometer which is a modification of its Wheatstone bridge, cold-junction compensating instrument. By altering the ratio of the coils (Fig. 23) in suitable steps, the e.m.f. of the couple is opposed by potential drops of different values, the indicator showing the unbalanced portion of the thermocouple e.m.f., as in the other instruments described.

*Graduation for Reading Temperature Directly.*—The preceding discussion has assumed that the scale of the galvanometer may be graduated to read either e.m.f. or temperature. If the thermocouple has a linear relation between e.m.f. and temperature, the theory outlined is just as applicable to a scale and dial graduated in terms of temperature as in terms of e.m.f. If the temperature e.m.f. relation of the couple is not linear, a given temperature change corresponds to different changes in e.m.f., depending upon the temperature of the couple. Hence, in order that the scale of the galvanometer may be graduated in degrees, it is necessary to modify its sensitivity in the various temperature ranges, by means of series resistance. The change in thermoelectric power of a couple through the temperature range represented by the scale of the galvanometer is usually small.

In the "range control board" the above-mentioned difficulty is avoided by the provision of a separate scale for each range, but it would not be practical to apply this method to the ordinary deflection potentiometer, which may have 10 to 20 different scale ranges. In the deflection potentiometer made by Leeds & Northrup (Fig. 15) the ratios of the

resistances may be so modified as to produce very closely the proper compensation in  $r_p$ , for any type of couple used industrially.

TEMPERATURE OF THE COLD JUNCTIONS OF THERMOCOUPLES

The e.m.f. developed by a thermocouple depends upon the temperature of the cold junctions as well as upon that of the hot junction. For certain base-metal couples having a nearly linear relation between temperature and e.m.f., the latter is approximately proportional to the difference in temperatures between hot and cold junctions; with such a couple a change of  $50^\circ$  in the temperature of the cold junctions, unless allowed for, would cause an error of  $50^\circ$  in the observed temperature.

If a couple is calibrated with a cold-junction temperature of  $t_0^\circ$  C., but is used with a cold-junction temperature of  $t'_0^\circ$  C., the true temperature of the hot junction is obtained by adding to the observed temperature the value  $(t'_0 - t_0) K$ , where  $K$  is a factor depending upon the particular couple employed and upon the temperature of the hot junction.  $K$  varies from 1.5 to 0.3, but for rough work may be assumed as 1.0 for base-metal couples, and 0.5 for rare-metal couples. Table 2 gives the cold-junction factors for several different types of couple.

The corrections may be applied directly, without computing, by setting the pointer of the galvanometer to read the cold-junction temperature on open circuit; this is done by turning the zero-adjustment screw of the indicator when the couple is disconnected. This method of

TABLE 2.—Cold-junction Correction Factors

| Engelhard<br>"LeChatelier" |       | Johnson-Matthey<br>"LeChatelier" |       | Copper-constantan    |       | Iron-constantan      |       |
|----------------------------|-------|----------------------------------|-------|----------------------|-------|----------------------|-------|
| Temp.,<br>Degrees C.       | $K^*$ | Temp.,<br>Degrees C.             | $K^*$ | Temp.,<br>Degrees C. | $K^*$ | Temp.,<br>Degrees C. | $K^*$ |
| 265-450                    | 0.65  | 250-400                          | 0.60  | 0-50                 | 1.00  | 0-100                | 1.00  |
| 450-650                    | 0.60  | 400-550                          | 0.55  | 50-80                | 0.95  | 100-600              | 0.95  |
| 650-1000                   | 0.55  | 550-900                          | 0.50  | 80-110               | 0.90  | 600-1000             | 0.85  |
| 1000-1450                  | 0.50  | 900-1450                         | 0.45  | 110-150              | 0.85  | Chromel-alumel       |       |
|                            |       |                                  |       | 150-200              | 0.80  | 0-800                | 1.00  |
|                            |       |                                  |       | 200-270              | 0.75  | 800-1100             | 1.05  |
|                            |       |                                  |       | 270-350              | 0.70  |                      |       |

\* Based on calibration with  $t_0 = 0^\circ$  C.

correcting is accurate, but, of course, requires new settings whenever the temperature of the cold junction is altered. Indicators of the potentiometric type frequently have a movable slide on the temperature scale, or an auxiliary dial (see discussion below), which, when set to the tem-

perature of the cold junction, gives perfect compensation at all temperatures of the hot junction; these two methods also require new settings whenever the temperature of the cold junction is altered. With large and permanent installations the applying of corrections for the temperature of the cold junction by any of the above methods is frequently troublesome, since the temperature may vary considerably within a few hours. There are several methods for obviating this necessity. The head of the couple may be fitted with a water-jacket, maintained at practically constant temperature; copper wires lead from the terminals of the couple, inside the water jacket, to the indicator, the pointer of which, on open circuit, is set to read the mean temperature of the water.

### *Compensating Leads*

The use of compensating lead wires from the couple to the indicator is the most generally satisfactory method for minimizing cold-junction errors in industrial installations. For base-metal couples, these lead

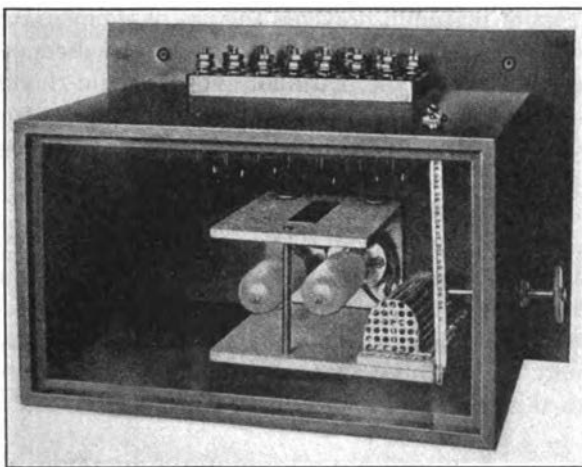

FIG. 17.—THERMOSTATED COLD-JUNCTION BOX.

wires are of nearly the same materials as those employed in the couple, small stranded wires being used for flexibility. Thus the cold junction is transferred from the head of the couple, where the temperature varies, to a point at some distance from the furnace, where the temperature is reasonably constant, and from this point copper wires lead to the indicator. The compensating wires may terminate in a thermostated cold-junction box, as illustrated by Fig. 17, or may be buried underground. At a depth of 10 ft. beneath the floor of a large building, the temperature remains constant to within  $2^{\circ}$  C. throughout the year; usually this mean temperature is about  $12^{\circ}$  C. for temperate climates, but may differ some-

what in the immediate vicinity of a large furnace. To apply this method of control, an iron pipe of the proper length, closed at the bottom, is driven into the ground, and the two cold junctions, well soldered and carefully insulated, are threaded to the bottom of the pipe in such manner as to be conveniently removable when necessary. The top of the pipe may be plugged with asbestos or waste, and covered with pitch to keep water away from the insulation. The scale of the indicator is set to read the mean temperature of the bottom of the tube. It is convenient to have an extra pair of compensating leads, or an extra thermocouple with its junction at the bottom of the pipe, to measure this temperature occasionally. Usually the compensating leads of a base-metal couple are marked, or are equipped with one-way terminals, so that they are easily connected properly to the head of the couple. If reversed at the couple, the leads will cause an error double the amount of the compensation. When compensating leads of a base-metal couple are properly connected to the couple, no deflection of the indicator is registered by heating the head of the couple.

The high cost of platinum prevents the use of compensating leads of that metal, but inexpensive wires of copper and nickel-copper alloy are now available for use with the platinum and platinum-rhodium couple. These lead wires do not compensate individually, but taken together they compensate to within  $5^{\circ}\text{C.}$  for a variation of  $200^{\circ}\text{C.}$  at the junctions of the couple and lead wires. Both terminals on the head of the couple should be kept as nearly as possible at the same temperature. The copper compensating lead is connected to the platinum-rhodium wire of the couple, and the copper-nickel wire is connected to the platinum wire of the couple, *i.e.*, alloy wire to pure metal in each case. The cold junction is then located at the indicator end of the compensating leads, and its temperature may be controlled by one of the methods described; copper wires run from this point to the indicator.

#### *Potentiometric Compensation Methods*

The wiring diagram for the Leeds & Northrup portable potentiometer, equipped with a hand-adjusted cold-junction compensator, is given in Fig. 18. The e.m.f. of the thermocouple  $H$  is balanced against the potential drop across  $DG$ , a condition obtained when the galvanometer reads zero. Dial  $G$  is calibrated to read the temperature of the hot junction of the couple. If this temperature remains constant while the temperature of the cold junction  $T$  increases, the e.m.f. of the couple diminishes and the point  $G$  would have to be moved nearer  $D$  to obtain a balance. If this were done, however, the temperature indicated on the scale would be too low. Hence, instead of moving  $G$  the contact  $D$  is turned nearer  $G$  by an amount depending upon the temperature of the

cold junction. A portion of the slide wire *DGE*, containing the contact *D*, is mounted as a separate dial, empirically graduated for any particular type of couple, to read the temperature of the cold junction. The pointer on this dial is set at the cold-junction temperature, by doing which the contact *D* is moved the proper amount for exact compensation. The balance is then made in the usual manner by adjusting the contact *G*. The temperature now indicated on the main dial is the correct tem-

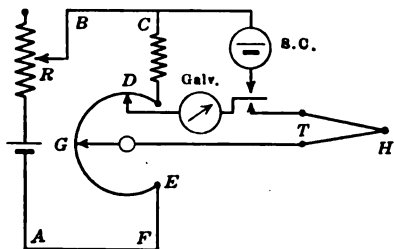

FIG. 18.—HAND-ADJUSTED COLD-JUNCTION COMPENSATOR.

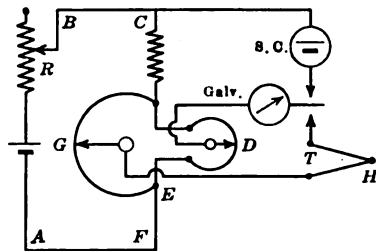

FIG. 19.—HAND-ADJUSTED COLD-JUNCTION COMPENSATOR.

perature of the hot junction of the couple. Fig. 18, while illustrating the principle of this method of compensation does not permit e.m.f. measurements to zero; the temperature scale on the main dial must start at the highest temperature on the cold-junction dial. Fig. 19 illustrates the wiring system more usually employed, the cold-junction dial being in parallel instead of in series with the main dial; this permits settings on the main dial to zero.

The above principle has been applied in an automatic compensator which has been used satisfactorily with the Leeds & Northrup recording

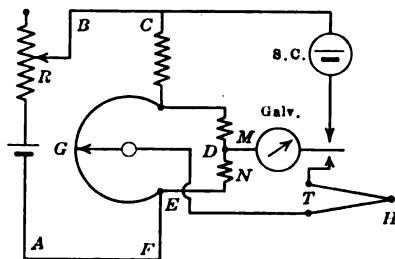

FIG. 20.—AUTOMATIC COLD-JUNCTION COMPENSATOR.

indicators (Fig. 20). The wiring system is similar to the one just described, except that the contact *D* of Fig. 19 is mechanically fixed between the two resistances *M*, having a zero temperature coefficient, and *N*, of nickel, having a high temperature coefficient. The resistance *N* is located near the cold junction of the couple so that its temperature and that of the cold junction are identical. If this temperature increases, the e.m.f. developed by the couple decreases, but the accompanying

increase in the resistance  $N$  automatically produces the same effect as moving the contact  $D$  toward  $G$  in Fig. 18. The circuit is more simply represented by Fig. 21. Let  $e =$  e.m.f. developed by the couple when the hot junction is at a temperature  $t^\circ$  and  $e_0 =$  the e.m.f. developed for a hot-junction temperature  $t_0$ , the cold-junction temperature being  $0^\circ$  in both cases. Then the e.m.f. developed by the couple when its hot junction is  $t^\circ$  and cold junction is  $t_0^\circ$  is  $e - e_0$ . Neglecting the slight effect

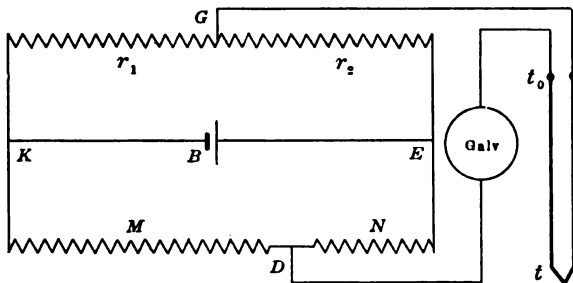

FIG. 21.—AUTOMATIC COLD-JUNCTION COMPENSATOR.

of variation in resistance  $N$  with the temperature, the potential drop from  $K$  to  $E$  due to the battery  $B$  is constant,  $e'$ . Whence, the potential difference between  $G$  and  $D$  when the galvanometer in the thermocouple circuit indicates zero is simply derived as follows, and is equal to the e.m.f. of the couple:

$$e' \left( \frac{r_2}{r_1 + r_2} - \frac{N}{M + N} \right) = e - e_0$$

For exact compensation, the position  $G$  must be independent of the cold junction temperature  $t_0$ ; hence, on differentiating the above expression we obtain the following as a condition which must be satisfied:

$$\frac{de_0}{dt_0} = e' \frac{M}{(M + N)^2} \frac{dN}{dt_0}$$

With proper proportioning of  $M$  and  $N$ , this condition is fairly well satisfied by the nickel coil for either base-metal or rare-metal couples, provided the temperature range for the cold junction is small.

### Compensation by a Shunt

The use of a resistance, having a high temperature coefficient, shunted across the terminals of the couple at the cold junction was suggested by Foote<sup>2</sup> in 1913 as a possible method of partly correcting the cold-junction errors. A modification of this method has since been patented by Mertelmeyer<sup>3</sup> and is used by the Bristol Co. As the temperature of the cold

<sup>2</sup> Foote: U. S. Bureau of Standards *Sci. Paper* 202, 12.

<sup>3</sup> Mertelmeyer, assignor to Bristol Co., U. S. Patent No. 1228803, 1917.

junction increases, the e.m.f. developed by the couple diminishes. If, however, the resistance of the coil shunted across the couple increases with the temperature, the potential drop over the coil tends to increase, and by properly proportioning the constants of the circuit a fair degree of compensation is obtained. Fig. 22 illustrates the method of compensation for potentiometric measurements.

- $r_1$  = resistance of the thermocouple.
- $r_2$  = series resistance having a zero temperature coefficient (manganin).
- $r_3$  = resistance of the shunt at  $0^\circ$ .
- $r'_3$  = resistance of shunt at temperature  $t'_0$ .
- $\alpha$  = temperature coefficient of resistance of the shunt, reckoned from  $0^\circ$ .
- $\beta$  = thermoelectric power of the couple (assumed constant).
- $t$  = any temperature of the hot junction.
- $t_0$  = any temperature of the cold junction, and of  $r'_3$ .
- $t'$  = temperature of hot junction for which perfect compensation is desired.
- $t'_0$  and  $0^\circ$  = temperatures of cold junction for which perfect compensation is desired.
- $e'$  = potential drop across  $r'_3$ , hot junction being at  $t'$ , and cold junction at  $t'_0$ .
- $e - e_0 = \beta (t - t_0) =$  e.m.f. developed by couple.

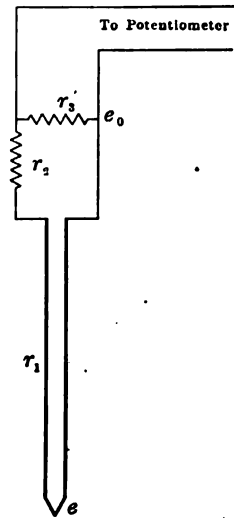

FIG. 22.—COLD-JUNCTION COMPENSATION BY SHUNT AND SERIES RESISTANCE.

In order to reduce to a minimum the effect of variations in the resistance  $r_1$  of the couple, a relatively high resistance  $r_2$  of manganin is mounted in series with the couple. If  $r_2$  is sufficiently high compared with  $r_1$ , we may neglect consideration of the latter in the present discussion. The potential drop  $e'''$  across  $r'_3$  for a cold-junction temperature  $t'_0$  and a hot-junction temperature  $t'$  is as follows:

$$e''' = \frac{\beta(t' - t'_0)(1 + \alpha t'_0)r_3}{r_2 + r_3(1 + \alpha t'_0)} \quad (1)$$

For a cold-junction temperature of  $0^\circ$ , and a hot-junction temperature  $t'$ , the potential drop  $e''$  is:

$$e'' = \frac{\beta t' r_3}{r_2 + r_3} \quad (2)$$

For exact compensation,  $e''$  must equal  $e'''$ ; hence from (1) and (2)

$$\frac{r_3}{r_2} = \frac{\alpha(t' - t'_0) - 1}{1 + \alpha t'_0} \quad (3)$$

For a cold-junction temperature  $t_0$ , and a hot-junction temperature  $t$ , the potential drop across  $r'_3$  is:

$$e' = \frac{\beta(t - t_0)(1 + \alpha t_0)r_3}{r_2 + r_3(1 + \alpha t_0)} \quad (4)$$



For a cold-junction temperature of  $0^\circ$ , and a hot-junction temperature  $t^\circ$ , the potential drop across  $r'_2$  is:

$$e'''' = \frac{\beta t r_3}{r_2 + r_3} \quad (5)$$

The error in the compensation, expressed in degrees, at any hot-junction temperature  $t$  and cold-junction temperature  $t_0$  is:

$$\text{Error, in degrees} = \frac{e'''' - e'}{e''''} t = t - \frac{\left(1 + \frac{r_3}{r_2}\right) (t - t_0)(1 + \alpha t_0)}{1 + \frac{r_3}{r_2} (1 + \alpha t_0)} \quad (6)$$

On substituting the value of  $r_3 \div r_2$  from equation (3), we obtain:

$$\text{Error, in degrees} = t_0 \left( \frac{t' - Kt}{t' - Kt_0} \right) \quad (7)$$

where 
$$K = \frac{1 + \alpha t'_0}{1 + \alpha t_0}$$

Suppose an iron-constantan couple is employed and perfect compensation is desired for a hot-junction temperature of  $800^\circ \text{C}$ . when the cold-junction temperatures are  $0^\circ$  or  $50^\circ \text{C}$ . The potentiometer indicator is graduated to read correctly all temperatures of the hot junction when the temperature of the cold junction is  $0^\circ$ . If the shunt is constructed of nickel wire, we have the following data:  $\alpha = 0.006$ ;  $\beta = 0.05$  millivolts per degree;  $t' = 800^\circ \text{C}$ .;  $t'_0 = 50^\circ \text{C}$ .

On substituting these values in equations (3) and (7) we obtain:

$$r_3 \div r_2 = 2.7$$

$$\text{Error, in degrees} = t_0 \left( \frac{800 + 4.8 t_0 - 1.3 t}{800 + 3.5 t_0} \right)$$

The ratio of the resistance of the nickel shunt to that of the manganin should be 2.7, at  $0^\circ$ . Table 3 shows the magnitude of the errors.

TABLE 3.—*Error in Compensation by Shunt Method*

| Hot Junction, $t$ ,<br>Degrees C. | $700^\circ \text{C}$ . | $800^\circ \text{C}$ . | $900^\circ \text{C}$ . |
|-----------------------------------|------------------------|------------------------|------------------------|
| Cold junction, $t_0$              |                        |                        |                        |
| 0                                 | 0                      | 0                      | 0                      |
| 10                                | -0.7                   | -2.3                   | -3.9                   |
| 20                                | -0.3                   | -3.3                   | -6.3                   |
| 30                                | +1.1                   | -3.2                   | -7.5                   |
| 40                                | +3.5                   | -2.0                   | -7.6                   |
| 50                                | +6.7                   | 0.0                    | -6.7                   |
| 60                                | +9.7                   | +2.6                   | -4.5                   |

Thus, over a range of 200° C. in the temperature of the hot junction and of 60° C. in the temperature of the cold junction, the method compensates to within 10° C.

The above method may be applied even more satisfactorily when a galvanometer is used instead of a potentiometer. By carrying through a series of computations for the more complicated circuit with a galvanometer, having resistance  $R$ , a relation may be obtained between  $R$ ,  $r_2$ ,  $r_3$ ,  $\alpha$  and  $\beta$ . A wiring system according to the data in Table 4 will give slightly better compensation around 800° C. than that of the potentiometer, as in Table 3.

TABLE 4.—*Shunt Compensation with Galvanometric Indicator*

| Galvanometer Resistance,<br>Ohms | Series Resistance<br>(Manganin), Ohms | Shunt Resistance<br>(Nickel), Ohms |
|----------------------------------|---------------------------------------|------------------------------------|
| 100                              | 126                                   | 150                                |
| 100                              | 59                                    | 100                                |
| 100                              | 23                                    | 50                                 |

It is evident that this method of compensation has certain advantages in the control and maintaining of furnace temperature. It should not be employed when the variation in temperature of the furnace is much greater than 100° C. There are few processes in which the use of compensated leads with a cold-junction box or a buried cold junction is not preferable. The shunt method has been described at some length because it has not been discussed elsewhere, and in certain restricted applications the method offers desirable features.

*Wheatstone Bridge Compensation*

This method of compensation for the temperature of the cold junction, as applied by the Beighlee Electric Co., is illustrated in Fig. 23. The switch  $S$  is first thrown to position  $t$ . The fixed resistances  $A$  and  $B$  are equal, so that if  $T$  were equal to  $D$  the galvanometer would show no deflection; the resistance of  $T$  is actually considerably greater than that of  $D$ . By varying the resistance  $VR$ , the pointer of the galvanometer may be adjusted to some definite mark on the scale. This preliminary setting fixes the amount of current flowing in the main circuit due to the battery  $E$ .

For a temperature measurement, the switch  $S$  is thrown to position  $1$ . The couple and the resistances  $X + C$  now constitute an arm of the bridge. The resistance  $C$  has a high temperature coefficient and is located at the cold junction of the couple. Suppose the apparatus is standardized for a cold-junction temperature of 0°; at that temperature  $X + C = D$ , and the galvanometer would show no deflection if the tem-

perature of the hot junction were  $0^\circ$ . As the temperature of the hot junction rises, the bridge is thrown out of balance, causing a deflection of the galvanometer. The scale of the instrument is accordingly empirically graduated to read the temperature of the hot junction when the cold junction is at  $0^\circ$ , and when the proper current is flowing through the main battery circuit as determined by the preliminary adjustment. When the temperature of the cold junction rises, the e.m.f. of the couple diminishes, but the resistance  $C$  increases. An increase in the resistance  $C$  tends to increase the deflection of the galvanometer, while a decrease in

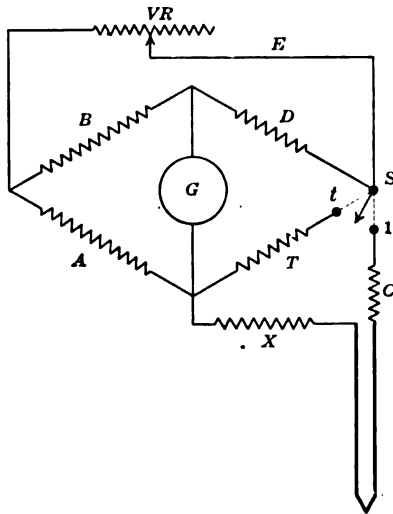

FIG. 23 — COLD-JUNCTION COMPENSATION BY WHEATSTONE BRIDGE METHOD.

the e.m.f. of the couple tends to decrease the deflection. For the reason that the thermoelectric power of a couple and the temperature-resistance coefficient of the coil  $C$  are nearly constant, or vary similarly with temperature, over a small range, by properly proportioning the various resistances of the circuit, the increased deflection due to increased resistance of  $C$  compensates, for all practical purposes, for the diminished deflection due to the reduction in e.m.f. of the couple as the temperature of the cold junction rises.

#### CORRECTION FOR IRREPRODUCIBILITY OF COUPLES

Platinum and platinum-rhodium suitable for thermocouples are refined in this country by Engelhard and in England by Johnson-Matthey. The temperature-e.m.f. relations of the couples obtained from these two sources differ somewhat from each other, but, as stated elsewhere in this paper, the reproducibility of either of these general types of Le Chatelier couple is highly satisfactory. The e.m.f. of base-metal couples of any

given type, under the same temperature conditions, may differ by 5 per cent. or more; expressed in temperature, these differences may amount to 50° at 1000° C. If the manufacturer of the couples exercises special care in the choice of the wire, these differences may be considerably reduced. For example, a certain length of chromel wire and another of alumel wire may be selected as representative of the standard couple for which the scale of the pyrometer indicator is graduated. The various stock coils of alumel are tested thermoelectrically against the standard alumel wire and the stock coils of chromel against the standard chromel wire. If no e.m.f. is developed by heating the junction of the standard wire and the wire under test, this indicates that the two are similar. Suppose, however, that an e.m.f. of 0.5 millivolt is observed, the standard alumel wire being positive. This coil of alumel wire should accordingly be used with a coil of chromel wire to which the standard chromel wire tested 0.5 millivolt positive. By carrying through a series of such tests on many coils of wire, always heating to the same temperature, various pairs of chromel and alumel coils may be selected, of which the temperature-e.m.f. relations are nearly the same as that of the standard couple. When these pairs of coils are made into couples, any differences in calibrations from that of the standard couple will be due mainly to heterogeneity of the wire itself. Usually a coil of wire is drawn from a single ingot, and its variations in thermoelectric properties are likely to be much smaller than the differences between two coils of wire. Any remaining variations are usually of small practical importance, and some manufacturers consider couples made from wire thus selected to be sufficiently reproducible for industrial purposes.

#### *Compensation by Series Resistance*

It is obviously impractical to graduate the scale of the indicator for every individual couple, especially as several couples are frequently connected to the same indicator. If a couple shows a higher e.m.f. than the standard couple for which the indicator is graduated, a sufficient amount of resistance may be placed in series with the galvanometer. Usually, if a base-metal couple shows an e.m.f., say, 2 per cent. high at 1000°, it will be 2 per cent. high at all other temperatures, so that this method of correction is satisfactory for all temperature ranges. The series resistance must be located at the couple and not inside the galvanometer. If a couple shows an e.m.f. 2 per cent. high, for example, the extra series resistance must be 2 per cent. of the total resistance of the circuit; thus, with a 300-ohm galvanometer and negligible line resistance, 6 ohms of manganin is placed in series and is mounted on a spool inside the terminal head of the couple. If the e.m.f. of a couple is low, resistance must be taken out of the circuit. The scale of the instrument is accord-

ingly designed for the normal couple plus a certain normal series resistance, the latter being sufficient to permit adjustment for couples showing low e.m.f.

This method of compensation is open to objection, especially from the standpoint of the pyrometer manufacturer, in that the resistance of the series coil required for exact compensation depends upon the resistance of the indicator. Table 5 shows the values of the series resistances required for indicators of various resistances, in order to provide for a maximum variation of  $\pm 2$  per cent. in the e.m.f. of different couples. The resistance of the line proper (*i.e.*, lead wires and couple without series coil) is assumed negligible.

TABLE 5.—Series Resistance Required for Compensation

| E.m.f. of Couple        | Resistance of Indicator |          |          |         |         |         |
|-------------------------|-------------------------|----------|----------|---------|---------|---------|
|                         | 500 Ohms                | 250 Ohms | 125 Ohms | 50 Ohms | 25 Ohms | 10 Ohms |
| 2 per cent. low.....    | 0                       | 0        | 0        | 0       | 0       | 0       |
| 1 per cent. low.....    | 5.0                     | 2.4      | 1.2      | 0.50    | 0.24    | 0.10    |
| 0.5 per cent. low.....  | 7.5                     | 3.7      | 1.9      | 0.75    | 0.37    | 0.15    |
| Normal.....             | 10.1                    | 5.0      | 2.5      | 1.01    | 0.50    | 0.20    |
| 0.5 per cent. high..... | 12.7                    | 6.3      | 3.1      | 1.27    | 0.63    | 0.25    |
| 1 per cent. high.....   | 15.2                    | 7.6      | 3.8      | 1.52    | 0.76    | 0.30    |
| 2 per cent. high.....   | 20.3                    | 10.1     | 5.0      | 2.03    | 1.01    | 0.40    |

The development in pyrometry during the past five years has tended toward the making of indicators having higher resistance, with the object of minimizing the errors arising from variations in line resistance. As a result, instruments having resistances ranging from 5 to 600 or even 1200 ohms are on the market. Hence, when ordering couples for replacement, the customer must state the resistance of the indicator, and the manufacturer must carry in stock an almost endless assortment of couples compensated and calibrated to fit all the instruments he has manufactured possibly in the past ten years. A large plant which has purchased instruments for five years may have an assortment of perhaps 100 indicators having resistances from 50 to 600 ohms, all calibrated to read correctly for the normal couple. Since the compensated renewing couples are no longer interchangeable, this plant would be required to carry a stock of couples for every indicator. The chances for confusion of records and the mixing of couples, and the extra cost of such a complete stock, are serious items.

The possible error when a compensated couple is used with the wrong indicating instrument is illustrated by the following example. Suppose the couple originally read 2 per cent. high and that it is compensated to read correctly with a 500-ohm indicator. The couple, by mistake,

is connected to a 50-ohm instrument. The series resistance for the 500-ohm instrument is 20.3 ohms (see Table 5) while that for the 50-ohm indicator is only 2.03 ohms. The introduction of 20.3 ohms in series with a 50-ohm galvanometer, when only 2.03 ohms should be used, makes the instrument read 26 per cent. low. Hence if the temperature of the furnace were 1000° C., the error would be 260°. If no compensation whatever had been employed, and if the instruments were graduated for the normal couple with no resistance in series, each instrument, when connected to the couple showing e.m.f. 2 per cent. high, would be in error by only 20° at 1000° C.

One way to prevent such mistakes is to use instruments all having the same resistance. Indicators having a practically fixed preassigned resistance are made by certain manufacturers; all parts of the galvanometers are constructed according to rigid specifications. The swamping resistance is finally adjusted until the total resistance of the instrument has the preassigned value found by experiment to be satisfactory. Slight differences may still exist in the calibration of different instruments; these can be corrected by several methods, such as:

(a) Calibrate the instrument by direct experiment and make a hand-drawn scale. Different instruments will have slightly different temperature ranges.

(b) Use printed scales and adjust the sensitivity of the galvanometer by means of a magnetic shunt.

(c) Use printed scales in several different temperature ranges and select the one which best fits the instrument.

(d) Shunt the moving coil to give a specified deflection on a specified current; then adjust the external resistance until the total resistance has the proper value. Use printed scales.

The adoption of a standard instrument is likely to discourage development on the part of the manufacturers. Furthermore, instruments having all resistances and scale ranges are in daily use in the industries, and they are giving satisfactory service; it is impossible to consider discarding all except those having a certain definite resistance in order that a convenient method of compensation by series resistance may be adopted. The objection to compensation by series resistance is further emphasized when indicators, or an indicator and a recorder, are operated in parallel on the same couple. Suppose a couple reading normally 2 per cent. high is installed with a 500-ohm indicator; the series resistance in the head of the couple (Table 5) is 20.3 ohms. It is desired to operate another similar indicator in parallel. The resistance of two 500-ohm indicators in parallel is 250 ohms; the two indicators accordingly act as a single indicator having a resistance of 250 ohms. Hence the series resistance must be 10.1 instead of 20.3 ohms. If the couple is to be used with both indicators it can never be used with the indicators separately.

If a 500-ohm indicator and a 125-ohm recorder are operated in parallel, the two instruments act as a single indicator, having a resistance of 100 ohms. For a couple reading 2 per cent. high, the series resistance must be 20.3 ohms when the 500-ohm indicator is used, 5.0 ohms when the 125-ohm recorder is used, and about 4 ohms when both are employed in parallel. When instruments of low and different resistances are operated in parallel, the problem of choosing the proper compensation for the couple becomes very complicated. In fact, it is frequently necessary to use cut-out switches to throw the recorder out of the circuit when the indicator is read, and vice versa. A final objection to the method of compensation by series resistance is that it has no effect when a potentiometric or semi-potentiometric indicator or recorder is employed. A couple showing e.m.f. 2 per cent. high, and compensated to read correctly on a 500-ohm indicator, will still read 2 per cent. high when the measurements are made with a potentiometer. Since the use of potentiometric instruments is becoming more extensive every year, especially for laboratory and checking work and for recorders, this last objection to compensation by series resistance deserves consideration.

#### *Compensation by Shunt Resistance*

In this method the thermocouple is shunted usually by a small resistance. If the couple normally reads high the resistance of the shunt is decreased: if low, the resistance is increased. An ordinary base-metal couple, for industrial purposes, has a resistance of 0.1 to 0.3 ohm at room temperature. It has been the practice to shunt this couple with a resistance of about the same magnitude; the shunted couple may accordingly be used with a potentiometer or with a galvanometer having almost any resistance from, say, 10 ohms up.

Various couples are thus perfectly interchangeable and may be used with instruments in parallel, when desired; hence none of the objections to series resistance apply to the shunted couple. A serious objection, however, may be raised against the shunted resistance in that the resistance of the shunt, for proper compensation, depends upon the resistance of the couple. The latter is subject to change with temperature and depth of immersion, depending upon the temperature-resistance coefficient of the two alloys, and is altered by deterioration of the couple. The following example illustrates the error which may be expected from a slight change in resistance of the couple when the resistance of the shunt is low.

Suppose the couple having a resistance, at room temperature, of 0.2 ohm is shunted by 0.2 ohm of manganin. If  $e$  is the e.m.f. developed by the couple, the potential drop over the shunt is  $\frac{1}{2}e$ . The scale of the galvanometer is arbitrarily graduated to take account of this reduc-

tion of e.m.f. Suppose the resistance of the couple changes from 0.2 to 0.25 ohm. The potential drop across the 0.2-ohm shunt on a couple of 0.25 ohm is  $0.44e$  instead of  $0.5e$  for which the galvanometer was graduated. The galvanometer accordingly reads 12 per cent. low, or in error by about  $120^\circ$  at  $1000^\circ$  C., which is many times greater than any error which would be introduced on account of irreproducibility of the couples if no compensating device were employed. The use of a low-resistance shunt should be discontinued; the method is satisfactory, however, when the shunt has a resistance many times that of the couple. As the resistance of the shunt is increased, the range for adjustment of different couples is diminished; however, it is not difficult to secure matched wire which is thermoelectrically reproducible to  $\pm 2$  per cent., and this variation can be compensated by shunts of fairly high resistance. For generality, the method is discussed under the following heading.

*Compensation by Shunt and Series Resistance<sup>4</sup>*

Let  $r_1$  = resistance of the couple plus a small resistance (if necessary) in series with it;  $r_2$  = resistance of the shunt;  $R$  = resistance of the galvanometer. The potential drop  $E'$  across the shunt is given by the following equation, where  $e$  is the e.m.f. developed by the couple at a given temperature.

$$E' = \frac{r_2 e}{r_1 + r_2 + r_1 r_2 / R} \tag{1}$$

In case the potential drop is measured by a potentiometer:

$$E = \frac{r_2 e}{r_1 + r_2} \tag{2}$$

The shunt resistance  $r_2$  is adjusted to compensate for the variation in e.m.f. of the different couples. On account of the term  $r_1 r_2 / R$  in equation (1), galvanometers having different resistances will be differently affected by variations in  $r_2$  from couple to couple. If, however, the term  $r_1 r_2 / R$  is small enough compared with  $(r_1 + r_2)$  this effect is negligible and the potential drop across  $r_2$  will be practically the same for all values of  $R$  and, with a potentiometer, for different couples regardless of the values of  $r_2$ . Let us impose the condition that the values of  $r_1$ ,  $r_2$ , and  $R$  must be such that the reading with a potentiometer shall never differ from that with a galvanometer by more than 0.5 per cent., (i.e.,  $5^\circ$  at  $1000^\circ$  C.). This condition is expressed by:

$$\frac{r_1 r_2}{R} \leq 0.005(r_1 + r_2) \tag{3}$$

We desire to compensate for couples showing e.m.f.'s differing from the normal couple by less than 2 per cent. For convenience in making the

<sup>4</sup> Zimmerschied: U. S. Letters Patent No. 776252, 1915.



adjustments on the shunt it is better to allow a little more variation for couples showing low e.m.f.; we will make the computations so that a couple reading 3 per cent. low could be compensated by using a shunt of infinite resistance—that is, with no shunt at all. If  $e$  is the e.m.f. of any couple, at some fixed temperature, and  $e'$  is the e.m.f. of a couple 3 per cent. below normal, we have from equation (2) for compensation:

$$\frac{r_2 e}{r_1 + r_2} = \frac{r_2' e'}{r_1 + r_2'} = e', \text{ since } r_2' = \infty \quad (4)$$

Hence substituting in (3) the value of  $r_2$  found from (4):

$$r_1 = \frac{R e}{200 e'} = \frac{R}{200} \frac{\text{e.m.f. of any couple}}{\text{e.m.f. of couple 3\% low}} \quad (5)$$

It is of advantage to make  $r_1$  as large as possible; this can be done by making  $R$  large, but the value of  $R$  must be small enough to provide for all galvanometers likely to be employed. If we denote by  $R_0$  the lowest galvanometer resistance for which compensation is required, the maximum desirable resistance of the couple is:

$$r_1 = \frac{R_0 e}{200 e'} = \text{total resistance of couple.} \quad (6)$$

Substituting this value of  $r_1$  in (4) we obtain:

$$r_2 = \frac{r_1}{\left(\frac{e}{e'} - 1\right)} = \frac{R_0}{200 \left(1 - \frac{e'}{e}\right)} = \text{shunt resistance} \quad (7)$$

Table 6 shows the values of the shunt resistances and couple resistances for the minimum galvanometer resistances 100, 80, 60, and 40 ohms. The compensation is better the more the resistance of the galvanometer exceeds these minimum values, and in no case does the error in compensation amount to more than 0.5 per cent. (*i.e.*, 3° at 600° or 5° at 1000° C.).

TABLE 6.—*Compensation by Shunt and Series Resistance*

| Series Resistance, Couple                        | $r_1 = 0.5$ Ohm,<br>Shunt<br>ohms | $r_1 = 0.4$ Ohm,<br>Shunt<br>ohms | $r_1 = 0.3$ Ohm,<br>Shunt<br>ohms | $r_1 = 0.2$ Ohm,<br>Shunt<br>ohms |
|--|-----------------------------------|-----------------------------------|-----------------------------------|-----------------------------------|
| 3 per cent. low .....                            | $\infty$                          | $\infty$                          | $\infty$                          | $\infty$                          |
| 2 per cent. low .....                            | 48.50                             | 38.80                             | 29.10                             | 19.40                             |
| 1 per cent. low .....                            | 24.25                             | 19.40                             | 14.55                             | 9.70                              |
| Normal .....                                     | 16.17                             | 12.94                             | 9.70                              | 6.47                              |
| 1 per cent. high .....                           | 12.12                             | 9.70                              | 7.27                              | 4.85                              |
| 2 per cent. high .....                           | 9.70                              | 7.76                              | 5.82                              | 3.88                              |
| Minimum galvanometer resist-<br>ance, ohms ..... | 100                               | 80                                | 60                                | 40                                |

In applying this method of compensation the standard galvanometer scale is graduated in the usual manner for the couple which reads 3 per

cent. low. Thus if we have a table of e.m.f.-temperature for the normal couple, we decrease all the e.m.f. values in the table by 3 per cent.

It was noted in the case of shunting a 0.2-ohm couple by 0.2 ohm that if the resistance of the couple increased from 0.20 to 0.25 ohm, the galvanometer would be in error by  $120^\circ$  at  $1000^\circ$  C. On referring to Table 6, the greatest error which a change in the couple resistance from 0.20 to 0.25 ohm can produce, when properly shunted, occurs with the couple reading normally 2 per cent. high, in which case the shunt has a resistance of 3.88 ohms; the error due to this change amounts to 1.2 per cent. or about  $12^\circ$  at  $1000^\circ$  C. instead of  $120^\circ$ . For the normal couple the error is only  $7^\circ$ , and for the couple reading 2 per cent. low, only  $3^\circ$ . The error thus diminishes as the resistance of the shunt increases, showing that it is preferable to use a couple having a resistance of 0.5 ohm; if the resistance of the couple alone is only 0.2 ohm, 0.3 ohm of manganin may be placed in series, and the shunt connected over the total of 0.5 ohm. If the resistance of the couple is now altered from 0.50 to 0.55 ohm, the couples reading 2 per cent. high, normal, and 2 per cent. low will be in error by only  $5^\circ$ ,  $3^\circ$ , and  $1^\circ$  respectively at  $1000^\circ$  C. It is evident that this method of compensation is far superior to the use of a shunt of low resistance.

#### *Summary on Reproducibility of Couples*

The object of this section has been primarily to call attention to the difficulties encountered by the pyrometer manufacturer when he attempts to correct for small variations in the calibration of different couples. The U. S. Bureau of Standards has calibrated chromel-alumel couples submitted for test, which deviated from the normal couple by  $20^\circ$  at  $1000^\circ$  C. On the other hand, it has purchased chromel-alumel wire at different times for which the maximum deviation from the specified temperature-e.m.f. relation was only  $4^\circ$  C. The variations with iron-constantan are usually greater but still are not serious. It is certainly possible, if necessary, to hold the manufacturer to within  $\pm 10^\circ$  C. of the specifications for an uncompensated couple. There are few industrial processes, however, using base-metal couples which require an accuracy of even  $20^\circ$  at  $1000^\circ$  C., and there are still fewer processes in which temperatures are measured or would probably be measured to this accuracy even if a perfectly compensated couple were secured. The users of pyrometers have forced these compensation methods upon the manufacturer, by insisting upon greater precision than is really necessary. In so doing the user obtains a couple which, when installed in a certain precise manner and frequently checked, may give satisfactory results, but usually the compensation device is a source of more serious error than would be occasioned by the slight irreproducibility of the uncompensated couples.

A solution of the problem, from the manufacturing point of view, is

to secure as well matched wire as possible, do away with compensation devices, and sell, at different prices, two grades of couples, one guaranteed to  $\pm 10^\circ$  and the other to  $\pm 20^\circ$  C. Possibly later, closer specifications could be adopted. If any industrial process requires greater precision than this, the couples should be individually calibrated and correction curves prepared similar to those furnished with high-grade voltmeters and other electrical instruments. If exact reproducibility and higher accuracy are both required, the rare-metal couples should be employed. In objecting to compensating methods, we refer only to those devices which are supposed to correct for variations in the thermoelectric characteristics of the couple wire; compensation methods for eliminating cold-junction errors, ordinary "compensating lead wires," etc. are of course necessary and must not be confused with the methods discussed in this section, which serve an entirely different purpose.

#### THERMOCOUPLE INSTALLATIONS

The installation of a large thermocouple equipment requires the services of competent electricians. As much attention, if not more, should be given to the wiring, switches, switchboards, etc., as in the case of ordinary power installations. Proper fixtures should be used to mount the couple in the furnace. Lead wires should have a weather-proof covering and should be run in a metal conduit, except for a short length of flexible cable at the ends of the conduit; the conduit should be grounded to prevent leakage from power installations or lighting circuits. All joints in the lead wires should be soldered and taped; when indicators or recorders of low resistance are employed it is of the greatest importance to have a well constructed electrical installation to insure a constant line resistance. Since instruments of low resistance are usually calibrated for a low line resistance of definite value, the size of copper wire required for a long line may be as large as No. 12 or 10 (2 mm. or 2.6 mm.). Special attention must be given to contact resistances at switches. Frequently switches rated at 100 amperes are required although the actual thermoelectric current is only a few milliamperes. If the indicator is of high resistance, or operates upon the potentiometric or semi-potentiometric principle, the necessity for low line resistance is not so pressing, but the wiring should be well installed, for the psychological effect at least. Stationary indicating and recording instruments usually should be mounted upon switchboards, with suitable selective or commutating switches when several couples are used with one indicator. When the head of the couple is exposed to severe conditions, a weather-proof terminal head should be provided, consisting of an outside casing which fits over both binding posts. Lead wires should be carried from the couple to the indicator through as cool rooms as conveniently possible; copper has a high temperature-resistance coefficient and the frequent

practice of running wires over the top of a long row of furnaces may cause large variations in line resistance.

The indicator or recorder should be conveniently located and should be mounted where vibration or excessive dirt and dust will not injure the mechanism; in almost all industrial installations, protecting cases are required. Special devices are employed to dampen vibration when this is serious, as in the neighborhood of a trip hammer or rolling mill. Frequently the instruments are suspended by spiral springs. One convenient method suitable for heavy instruments, such as a recorder, is to mount the instrument on a board which is supported on a pier by four tennis balls, one at each corner.

When fixing the couples in the furnace, the primary consideration is to locate the hot junction at the exact point the temperature of which is desired; at the same time, the lead wires should be conveniently situated. The space between the protecting tube of the couple and the furnace wall should be tightly plugged with refractory cement so that cold air cannot be drawn in, thus cooling the hot junction. The cold-junction box should be so located as to reduce the necessary amount of compensating lead wire to a minimum, since this wire is somewhat costly and should not be employed extravagantly; great lengths of compensating wire also increase the line resistance, since its conductivity is much lower than that of copper.

In case the cold junction is buried underground, it must not be located too near a large furnace; either the distance from the furnace, or the depth at which the junction is buried, must be increased. A depth of 10 ft. and at least 10 ft. from a large furnace is usually satisfactory.

#### *Common Return*

The use of a common return wire for a multiple installation is generally unsatisfactory, because short circuits are so likely to occur. At the same time, leakage from a power installation affects the reading of every couple connected to the return, and as a leakage through a high resistance may alter the readings of every couple by the same amount, the presence of such leaks is not always readily detected. It is also possible, by leakage from different couples to the ground, to obtain very erratic and erroneous readings when the common return is employed. Base-metal couples are frequently constructed with the hot junction welded to the end of the iron protecting tube in order to reduce thermal lag. Even when this welded junction is not made, the hot junction usually touches the protecting tube, and is in good electrical contact with it, especially at high temperatures, when insulation resistance becomes very low. Suppose that the iron tubes of two chromel-alumel couples are grounded to the iron casing of a furnace, the two hot junc-

tions thus being connected by a circuit of iron (Fig. 24). The actual result is a chromel-alumel couple one leg of which is shunted by an alumel-iron-alumel differential couple. So long as the temperatures of the hot junctions of both couples are the same, this differential couple produces no effect, but it will alter the reading of the indicator whenever the temperatures differ; both of the chromel-alumel couples will accordingly give erroneous results. With individual returns, the iron circuit produces no effect. When grounds occur further back from the hot junction, for example between the common return and the other lead wire of a single couple, every couple on the common return has, in addition to its own e.m.f., an impressed potential drop due to the current flowing in the shunted couple, which may cause a large error in every reading. The common return is extensively utilized in the industries, but it is a dangerous practice and should be avoided as far as possible.

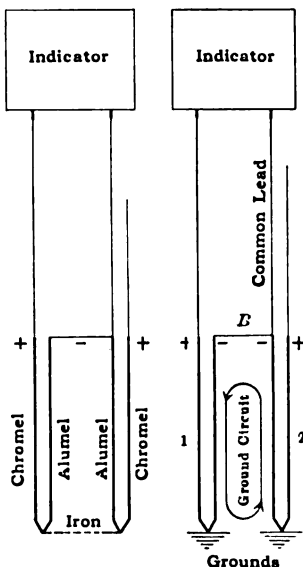

FIG. 24.—ILLUSTRATING THE OBJECTION TO COMMON RETURN.

*Wiring Diagrams of Thermocouple Installations*

Fig. 25 illustrates a simple thermoelectric installation for a rare-metal couple, the couple being properly protected by a porcelain or quartz tube and, if necessary, by an outer tube of iron, chromel, fireclay, etc. From the head of the couple, compensating lead wires are carried to the bottom of a pipe driven 10 ft. underground, with copper wires leading to the indicator.

Fig. 26 illustrates a multiple installation for five thermocouples; in this case a common return is employed, whereby four lengths of copper wire have been saved, and the commutating switch made simpler. The indicator for the operator of the furnaces and the recorder for the superintendent's office are mounted in parallel. The indicator or recorder may be connected to any desired couple by setting the commutating switch. Such an installation can be utilized only when the instruments have a high resistance. The recorder and the indicator, when connected to the same couple at the same time, act as shunts on each other, which tends to make both instruments read low; whereas if the two instruments are calibrated to read correctly in parallel, they will both read high when connected to different couples. An example illustrates this point. Suppose the line and couple resistance for each circuit is 3 ohms, and the resistance of the recorder and indicator 500 ohms each. Assume that

both instruments are calibrated to read correctly when connected separately to any couple. The potential drop  $E$  across the terminals of either instrument bears the following relation to  $e$ , the e.m.f. of the couple:

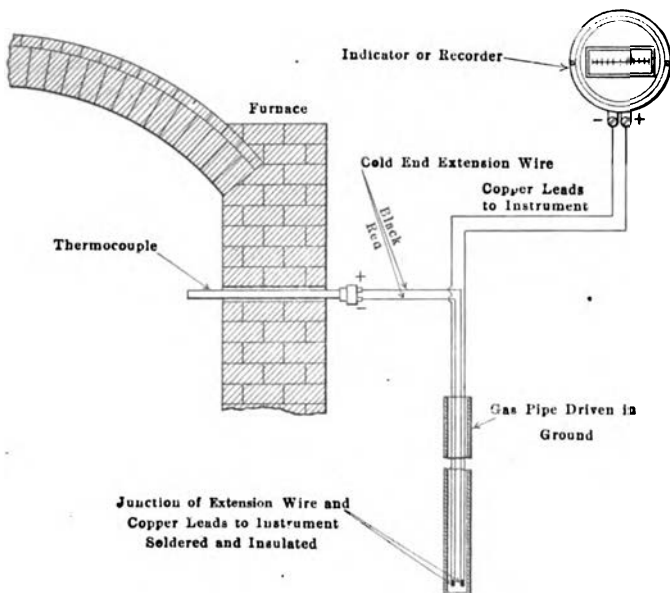

FIG. 25.—SIMPLE THERMOCOUPLE INSTALLATION.

$E = (500 \div 503) e$ . The scale of the instrument is graduated to take account of this reduction in e.m.f. When the two instruments are in

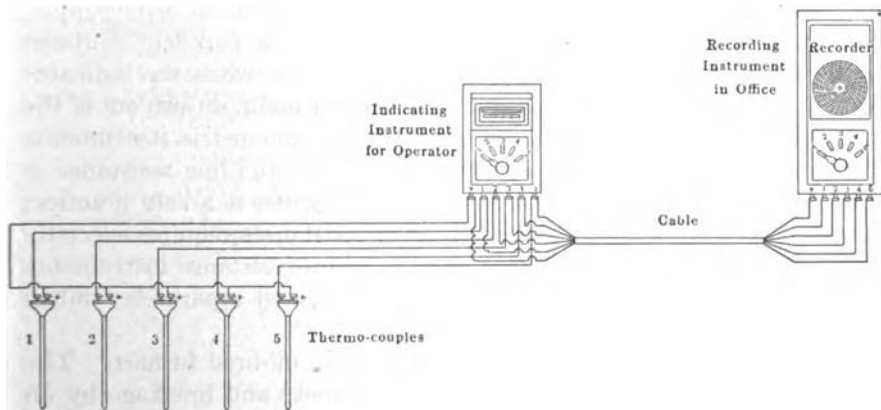

FIG. 26.—SIMPLE 5-COUPLE INSTALLATION.

parallel, the potential drop across the indicator and recorder is given by the following equation, where  $R$  = resistance of indicator or recorder, and  $r$  = line resistance:

$$E' = \frac{Re}{R + 2r} = \frac{500}{506} e$$

Accordingly the e.m.f. is reduced by the factor  $500 \div 506$ . As each instrument is calibrated for a reduction of  $500 \div 503$ , the error resulting from the parallel connection is thus 0.6 per cent., or about  $6^\circ$  at  $1000^\circ$  C. Hence if the operator of the furnace switches a couple onto the indicator when the same couple is also connected to the recorder, both instruments will read low; but this error is usually insignificant.

A similar example will be considered for an indicator and a recorder of low resistance. Let the line resistance  $r$  be 3 ohms, as before, and the resistances  $R$  of the indicator and the recorder be 10 ohms each. The potential drop  $E'$  across the terminals of either instrument bears the following relation to  $e$ , the e.m.f. of the couple:

$$E = \frac{Re}{R + r} = \frac{10}{13} e$$

When the two instruments are in parallel, the potential drop across the indicator and recorder is:

$$E' = \frac{R}{R + 2r} e = \frac{10}{16} e$$

The instruments are calibrated to read correctly when used separately, that is for a reduction in e.m.f. by the factor  $10 \div 13$ ; when in parallel the reduction factor is  $10 \div 16$ , the resulting error thus being 19 per cent., or about  $190^\circ$  at  $1000^\circ$  C. For this reason, low-resistance instruments can not be alternately operated separately and in parallel on the same couple; they must always be used either separately or in parallel. Cut-out switches are frequently employed, so designed that when the indicator is connected with a couple, this couple is automatically thrown out of the recorder circuit. The paralleling of simple galvanometric instruments having a resistance of 300 ohms and more when the line resistance is less than 3 ohms, or of potentiometric instruments, is a safe practice; the paralleling of instruments having lower resistances requires specially graduated scales or special wiring circuits. Low-resistance instruments designed for parallel operation should not be used separately, unless protected by cut-out switches.

Fig. 27 illustrates a simple installation in an oil-fired furnace. The thermocouple is protected from mechanical shocks and breakage by an additional metal sheath. Compensating lead wire is carried to the indicator, the cold junction being located at the indicator and not thermostatically controlled. The indicator is set to read the room or cold-junction temperature on open circuit; otherwise correction for "cold-junction error" must be applied.

Fig. 28 shows a thermocouple imbedded in the floor of an oil-fired furnace, thus occupying no space in the heating chamber. The cold

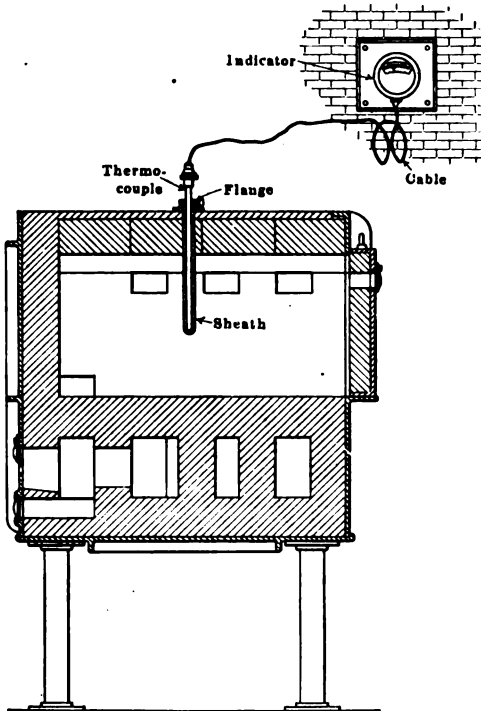

FIG. 27.

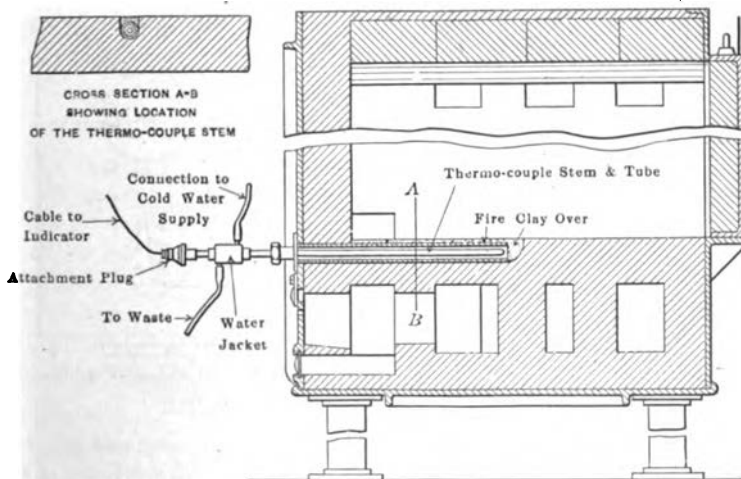

FIG. 28.—THERMOCOUPLE IN OIL-FIRED FURNACE.

junction is water-jacketed. Fig. 29 shows a method of installing a couple in the wall of a large furnace.



Fig. 30 shows a method of installing a couple in a galvanizing tank or in a pot of stereotype metal, babbitt, or tin.

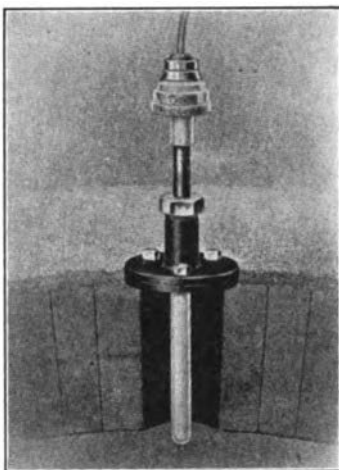

FIG. 29.—METHOD OF MOUNTING COUPLE IN FURNACE.

Fig. 31 illustrates a multiple thermocouple installation connected to a single indicator. Compensating lead wires are carried from the couples to a conveniently located cold-junction box, the temperature of which is

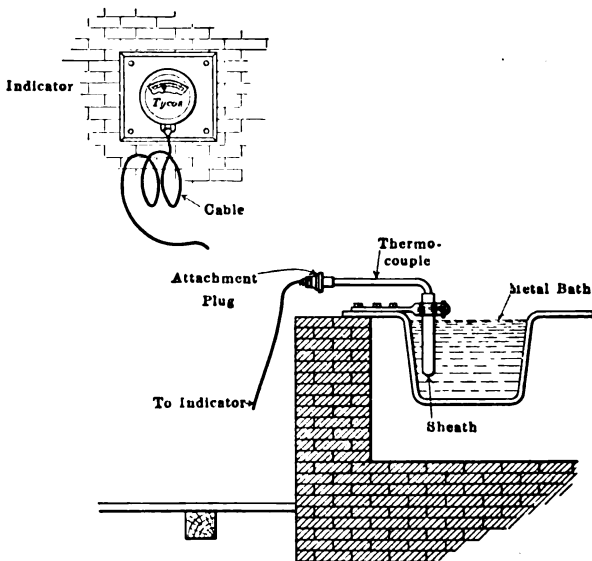

FIG. 30.—THERMOCOUPLE IN LEAD BATH.

thermostatically controlled. From the cold-junction box copper wires run to the terminal block and selective switch. A common return has been employed between the cold-junction box and the switchboard.

The switchboard is designed for six couples; by pressing one of the buttons any desired couple is connected directly to the indicator.

### *Commutating Switches*

In one type of multiple rotary switch, by turning the dial to the proper position any one of twelve couples may be connected to the indicator. The commutating brushes are laminated phosphor-bronze, diagonal wiping, and have a long spring action to follow up all possible wear. In a switch of different design, but similar in principle, double points of contact are required when individual return wires are employed. The positive wires of each couple are connected to the outer ring of contacts and the negative wires to the inner ring. The galvanometer is connected across the two solid rings. Commutating switches are designed so that variable contact resistance is reduced to a minimum.

For large installations several hundred couples may be connected to a switchboard, which is frequently designed somewhat similar to an ordinary telephone switchboard. Often in these large installations communication between the operator of the switchboard and the operator of the furnace is maintained by a system of colored electric lamps.

### *Junction Box and Zone Box*

Fig. 32 is a wiring diagram for a multiple-couple installation which has the advantage of saving compensating lead wire, and thus reducing

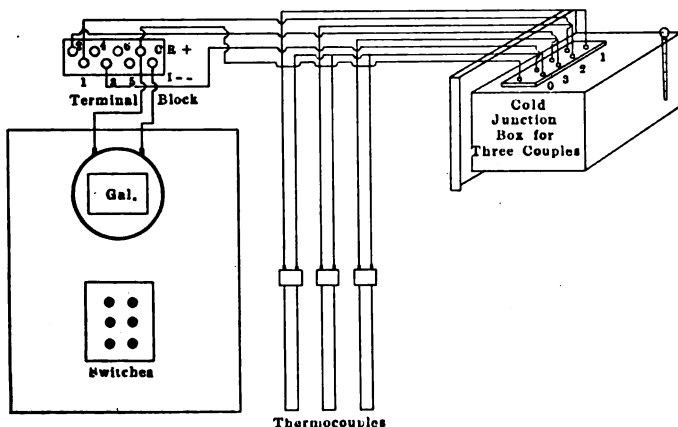

FIG. 31.—MULTIPLE-COUPLE INSTALLATION WITH THERMOSTATED COLD-JUNCTION BOX AND COMPENSATING LEADS.

the cost and the resistance of the line. The junction box is a cast-iron box such as is used for underground telephone wiring; it is not thermostated, since a constant and measured temperature is not required. The e.m.f. developed at the junctions of compensating leads and copper leads is corrected by a common junction, in the opposite direction, inserted

between the selective switch and the indicator or recorder. A common cold junction is also placed here; in Fig. 32 this is shown located in a pipe buried 10 ft. underground. The selective switch and recorder or indicator are usually mounted in a single case. The common cold junction and the junction-box compensating couple are connected at the recorder between the switch and the binding post terminals of the instrument, as illustrated. The cold junction is placed near the junction box and the recorder or indicator (with switch if desired) may be any distance away since only copper leads are used from this point to the junction box.

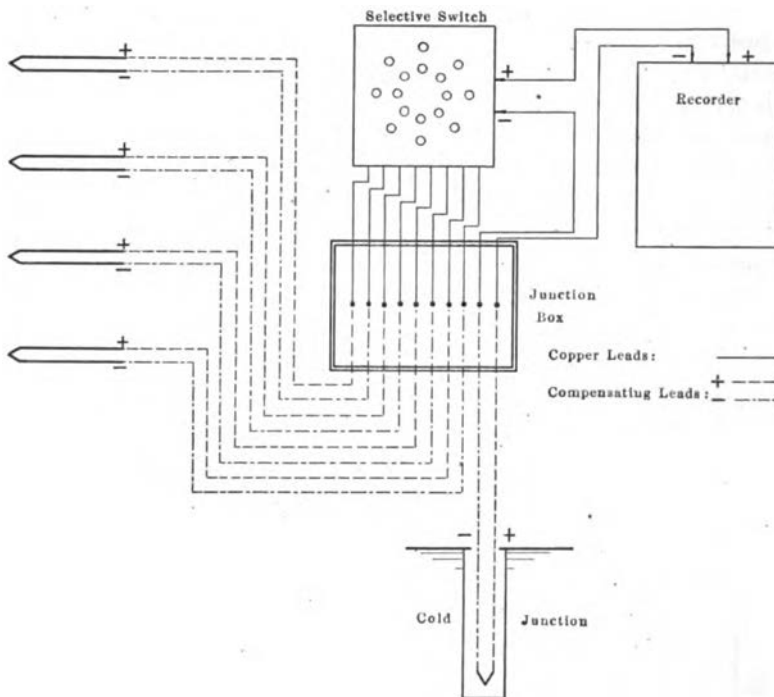

FIG. 32.—ILLUSTRATING USE OF JUNCTION BOX WITH CONTROLLED COLD-JUNCTION TEMPERATURE.

This method is especially useful where separate cold junctions would require too long compensating leads. Suppose the temperature of a coke oven, 20 by 40 by 150 ft., is measured by nine couples inserted in the top. The indicator is at the ground level, 40 ft. away, and the buried cold junctions are 20 ft. in front of the oven. When the junction box is not employed, the amount of compensated lead wire required to reach the buried cold junctions is as follows:

- Three couples at rear of furnace,  $3 \times (150 + 20 + 20 + 10)$  ft.
- Three couples at center of furnace,  $3 \times (75 + 20 + 20 + 10)$  ft.
- Three couples at front of furnace,  $3 \times (20 + 20 + 10)$  ft.
- Total compensating cable..... 1125 ft.

When a junction box is located on top of the furnace, at the center

- Three couples at rear of furnace,  $3 \times 75$  ft.
- Three couples at center of furnace,  $2 \times 10$  ft.
- Three couples at front of furnace,  $3 \times 75$  ft.
- From box to cold junction.....  $(75 + 20 + 20 + 10)$  ft.
- Total compensating cable..... 595 ft.

By means of the junction box we effect a saving of some 500 ft. of compensating cable, and need to bury only one pair of junctions, the installation being just as satisfactory. When installing a large multiple-couple equipment with a junction box, it is important to insure that the common cold-junction couple is connected with the correct polarity, as illustrated. Although a common cold junction has been used for all couples, the objectional common return has not been employed.

In case the recorder is placed where the temperature is fairly uniform from day to day, the use of a buried cold junction or thermostated cold-junction box is not absolutely essential. The e.m.f. generated at the

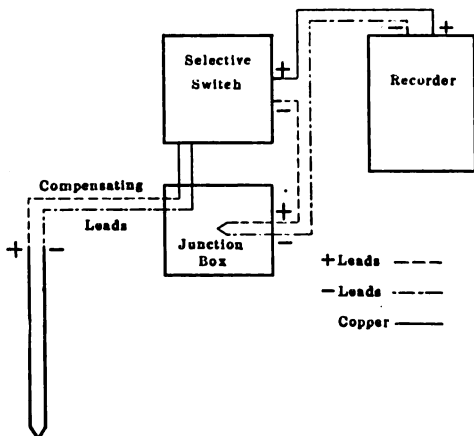

FIG. 33.—ILLUSTRATING USE OF JUNCTION BOX WITHOUT COLD-JUNCTION CONTROL.

junction box in Fig. 32 is then compensated by running one pair of compensating leads from the recorder to the junction box, taking care to connect the negative lead to the negative terminal of the recorder and the positive lead to the selective switch. A simple installation of this kind is illustrated by Fig. 33; here only one couple is shown, but as many as desired may be connected to the multiple-pole selective switch. The compensating lead wires are soldered together inside the junction box and the auxiliary couple formed by the compensating leads is in series with the couple connected in by the selective switch. The cold junction is accordingly actually at the recorder, where the temperature is fairly constant; changes in temperature of the distributing or junction box thus will not affect the reading of any couple.

Fig. 34 illustrates the Wilson-Maeulen zone box, to which the couple  $yz$  is connected directly. Two pairs of wires lead from the zone box, one pair, of copper, being connected to the main line and indicator; the other pair  $YZ$  goes to the cold-junction box or is buried underground. For base-metal couples  $Z$  and  $y$  are of the same material, and also  $Z$  and  $z$ . For rare-metal couples,  $Z$  and  $Y$  are respectively copper and a copper-nickel alloy. The zone box thus saves running an extra pair of copper lead wires to the bottom of the cold-junction well. If this principle is adopted for a multiple installation, so as to save compensating leads, a selective switch may be mounted between the zone box and the different couples; however,

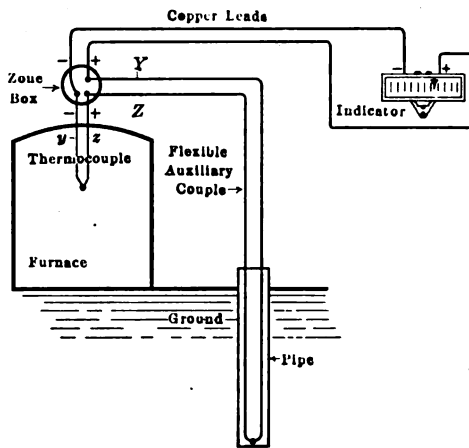

FIG. 34.—WILSON-MAEULEN ZONE BOX.

this requires that the selective switch be mounted near the furnace, unless a complicated interlacing electrical circuit is employed, whereas it is always desirable to have the switch at the indicator. It appears, therefore, that for large installations the junction box previously described is preferable so far as economy in compensating lead wire is concerned. In case of a single couple, or where separate cold-junction wells are installed for different couples in multiple installations, the zone box accomplishes practically the same results as the junction box, affording a small saving in copper and frequently a more desirable wiring system. The main advantage of the junction box is the saving of compensating lead wire in a multiple-couple installation; the main advantage of the zone box is the simplicity with which the cold junction is extended to some point at which the temperature is constant or can be controlled.

#### *Determination of Temperature of Buried Cold Junction*

The simplest method is to use a thermocouple consisting of the compensating leads. Insert this in the well, connect it to a portable indicator, and measure the secondary cold-junction temperature at the indicator

with a thermometer. With a well 10 ft. deep or more and properly located, it is necessary to measure the temperature only once a month. Another method is to lower a thermometer into the well, wrapped with a few layers of cloth but leaving the stem exposed near the expected reading; it should be left in the well for 30 min. All buried leads to the cold junction should be water-proof insulated, and the junction well should be water tight. The compensating leads, particularly those for base-metal couples, will generate a large voltaic e.m.f. if they become wet.

### *Depth of Immersion of Couples*

Thermocouples immersed in furnaces of the various industrial types must be carefully protected. Heavy iron tubes and frequently larger auxiliary protecting tubes of various materials are employed. There is no certainty that the temperature indicated by the thermocouple is actually that of the furnace, because of conduction along the protecting tubes. Conduction losses may be reduced and even eliminated by allowing a sufficient depth of insertion, but it is not always possible to do this and it is difficult to determine when the depth is sufficient. The general practice is to make the depth as great as convenient and trust that this is sufficient. Two methods may be suggested for investigating this question, but neither is very conclusive. First: Remove the couple alone from the fixed installation, leaving all protecting tubes in place. If it is impossible to remove the iron tube from the couple use a similar tube in the fixed installation without the couple. Explore the temperature inside the protecting tube with an unprotected couple. If the temperature for several centimeters along the inner end is practically uniform, the depth is sufficient; if the temperature falls rapidly in that region, the depth is not enough. Second: The couple, previously standardized, is mounted complete in the fixed installation and compared with a checking couple mounted at its side. The checking couple must have a small cross-section, and must be either unprotected or protected by an extremely thin protection tube, in order to minimize the loss of heat by conduction. The hot junction of this couple and that of the couple under test are brought closely together, but not in contact. The checking couple should indicate the furnace temperature more closely than the fixed couple; if the difference is large a greater depth should be adopted. These methods are complicated by local variations in the temperature of the furnace, but checks of this nature, although somewhat unsatisfactory, are better than none.

It is frequently desirable to purposely immerse the couple to an insufficient depth. In many processes the furnace is operated at such a high temperature that a thermocouple or protecting tube cannot with-

stand the severe conditions to which it may be subjected. In this case the couple may be immersed only part way through the furnace wall, or to a distance flush with the inner wall of the furnace. The temperatures indicated by couples installed in this manner are always lower than those of the furnace interior, but they bear a fairly definite relation to the temperature of the furnace, and hence the method is satisfactory for temperature control and reproduction of furnace conditions from day to day.

#### PROTECTION TUBES FOR THERMOCOUPLES

The choice of a proper protection tube for a thermocouple is nearly as important as the selection of the material for the couple. Among others, the following properties of a protection tube should be considered:

(a) Slight porosity to gases; many tubes become very porous at high temperatures and furnace gases usually attack the couple.

(b) Low volatility; certain metal tubes are undesirable at high temperatures because the metal distills upon the couple and alters its calibration.

(c) Ability to withstand high temperatures.

(d) Ability to withstand sudden changes in temperature.

(e) Ability to withstand mechanical shocks and strains.

(f) High rigidity or viscosity; protecting tubes frequently deform and exhibit the phenomenon of plastic flow at high temperatures.

(g) Thermal conductivity; high thermal conductivity is frequently desirable when rapidly changing temperatures are measured; usually, however, low conductivity is desired so that the flow of heat along the tube shall be small.

(h) Ability to resist corrosion from molten metals or furnace gases.

Excellent protecting tubes are obtainable for many different industrial processes, but for certain others, satisfactory tubes have not yet been developed; this applies particularly to industries dealing with molten metals, especially iron and brass.

*Fused Quartz.*—Fused quartz affords good protection up to 1050° C. in an oxidizing atmosphere free from alkalis. The material is somewhat pervious to hydrogen and probably to other reducing gases, but at this temperature is not pervious to oxygen or carbon dioxide. Any reducing gas within the protecting tube of a rare-metal couple is disastrous, particularly when the tube contains silica; the silica is reduced to silicon, which is readily absorbed by platinum. Above 1050° C., and even at lower temperatures after prolonged heating, quartz devitrifies and crumbles. Quartz tubes withstand sudden changes of temperature without breaking. Heavy sintered quartz tubes, with walls 1 or 2 cm.

thick, are sometimes used for extra protection, for example, against acid fumes.

*Porcelain.*—Porcelain is used primarily for protection of rare-metal couples. Previous to 1914 a highly refractory porcelain, known as Marquardt, was imported from Germany. A better grade of this material was developed through the research work of the U. S. Bureau of Standards, and is now manufactured by Stupakoff under the name "Usalite," and by Engelhard under the name "Impervite." These two porcelains have a melting point above that of platinum. However, only when

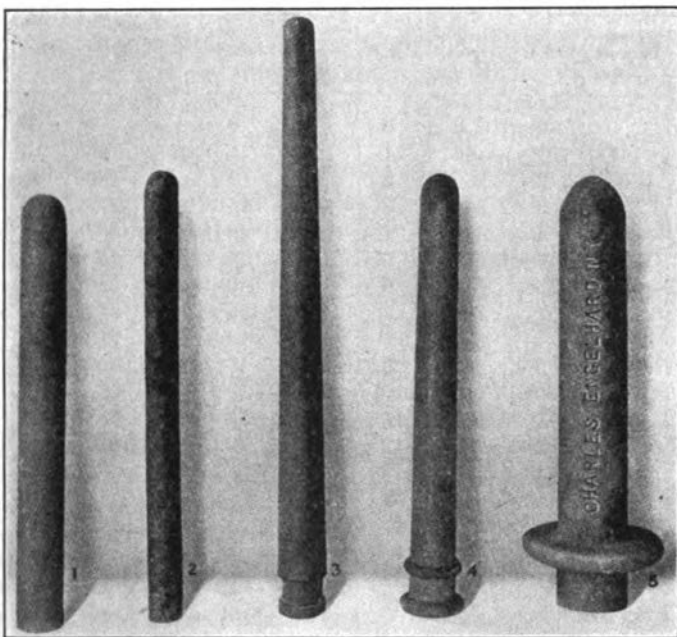

FIG. 35.—PROTECTING TUBES FOR COUPLES.

glazed are they impervious to gases. The softening point of the American glaze is about  $1300^{\circ}\text{C}$ .; that on the German tubes softens at  $1200^{\circ}\text{C}$ . If the tubes are glazed only on the outside they are serviceable as pyrometer protection tubes up to  $1500^{\circ}\text{C}$ .; the insulating tubes are not glazed. An unprotected porcelain tube, suddenly thrust into a furnace at  $1000^{\circ}\text{C}$ ., will usually break, but not if it is inserted very slowly.

In permanent installations, quartz and porcelain tubes, and also the iron or chromel tubes of base-metal couples, are frequently further protected by heavy outer tubes of fireclay, carborundum, graphite, etc. The outer tube is usually cemented in place in the furnace wall, forming a well into which the couple is inserted. In case the outer tube introduces too large a temperature lag, or if the temperature of the hot junct-



tion of the couple is likely to be diminished by conduction of heat through the heavy tube, the latter is made open at both ends; the couple and its smaller protecting tube are then so mounted that the hot junction projects a few centimeters beyond the end of the outer protecting tube.

TABLE 7.—*Calibration Data of Representative Couples*  
 Cold-junction Temperature, 0° C. E.m.f. in millivolts

| Engelhard<br>"Le Chatelier" |                         | Johnson-Matthey<br>"Le Chatelier" |                         | Copper-<br>constantan |                         | Iron-constantan |                      | Chromel-<br>alumel |        |                         |
|-----------------------------|-------------------------|-----------------------------------|-------------------------|-----------------------|-------------------------|-----------------|----------------------|--------------------|--------|-------------------------|
| E.m.f.                      | Temp.,<br>Degrees<br>C. | E.m.f.                            | Temp.,<br>Degrees<br>C. | E.m.f.                | Temp.,<br>Degrees<br>C. | E.m.f.          | Temp.,<br>Degrees C. |                    | E.m.f. | Temp.,<br>Degrees<br>C. |
|                             |                         |                                   |                         |                       |                         |                 | B                    | L                  |        |                         |
| 0                           | 0                       | 0                                 | 0                       | 0                     | 0                       | 0               | 0                    | 0                  | 0      | 0                       |
| 1                           | 147                     | 1                                 | 146                     | 1                     | 25                      | 5               | 105                  | 95                 | 5      | 122                     |
| 2                           | 265                     | 2                                 | 260                     | 2                     | 49                      | 10              | 204                  | 186                | 10     | 243                     |
| 3                           | 374                     | 3                                 | 364                     | 3                     | 72                      | 15              | 299                  | 277                | 15     | 363                     |
| 4                           | 478                     | 4                                 | 461                     | 4                     | 94                      | 20              | 392                  | 367                | 20     | 482                     |
| 5                           | 578                     | 5                                 | 553                     | 5                     | 115                     | 25              | 483                  | 457                | 25     | 601                     |
| 6                           | 675                     | 5                                 | 641                     | 6                     | 136                     | 30              | 574                  | 546                | 30     | 721                     |
| 7                           | 770                     | 7                                 | 725                     | 7                     | 156                     | 35              | 662                  | 632                | 35     | 844                     |
| 8                           | 861                     | 8                                 | 806                     | 8                     | 175                     | 40              | 749                  | 713                | 40     | 970                     |
| 9                           | 950                     | 9                                 | 884                     | 9                     | 194                     | 45              | 836                  | 792                | 45     | 1100                    |
| 10                          | 1037                    | 10                                | 959                     | 10                    | 213                     | 50              | 924                  | 871                |        |                         |
| 11                          | 1122                    | 11                                | 1032                    | 11                    | 232                     | 55              | 1011                 | 950                |        |                         |
| 12                          | 1206                    | 12                                | 1103                    | 12                    | 250                     | 60              | ...                  | 1030               |        |                         |
| 13                          | 1290                    | 13                                | 1173                    | 13                    | 268                     |                 |                      |                    |        |                         |
| 14                          | 1373                    | 14                                | 1242                    | 14                    | 285                     |                 |                      |                    |        |                         |
| 15                          | 1455                    | 15                                | 1311                    | 15                    | 302                     |                 |                      |                    |        |                         |
|                             |                         | 16                                | 1379                    | 16                    | 319                     |                 |                      |                    |        |                         |
|                             |                         | 17                                | 1447                    | 17                    | 336                     |                 |                      |                    |        |                         |
|                             |                         |                                   |                         | 18                    | 353                     |                 |                      |                    |        |                         |

*B* represents mean calibration by U. S. Bureau of Standards of iron-constantan couples from all sources. *L* represents mean calibration of Leeds & Northrup's iron-constantan couple.

**Carborundum.**—Carborundum is used for outer protecting tubes (Fig. 35, No. 1). It has a high thermal conductivity, about twice that of silica, a low coefficient of expansion, about one-half that of fused alumina, and great mechanical strength. When heated in an oxidizing atmosphere, oxidation begins at about 1200° C. At 1500° C. the silica formed on the surface of the tube fuses and protects the tube from further oxidation. Gases, except chlorine, do not act on carborundum, but basic slags attack it readily. Carborundum reacts at high temperatures with practically all metals, wherefore platinum must be thoroughly protected from the carborundum by a gas-tight inner tube. Silfrax, which is pure finely crystalline carborundum, is highly satisfactory for ordinary furnace work; it is sometimes used in molten glass and open-hearth slag.

**Nichrome or Chromel.**—Cast nichrome or chromel tubes are extensively used for protection of both base-metal and rare-metal couples (Fig. 35, No. 2). These tubes resist oxidation remarkably well and, although much more costly than iron tubes, their longer life warrants and requires their use in many processes. Chromel "A" may be used continuously to 1200° C. It has not yet been found possible to draw these alloys into tubes. The material can be machined with difficulty but threads may be cut for pipe fittings. In order to economize in these materials, iron tubes may have short sections of nichrome or chromel welded to them, at the place where exposed to the furnace. In processes carried out at low temperatures, where either iron, chromel, or nichrome may be utilized, experiments should be made to determine the relative life of these tubes in hours per dollar of cost; practically no data are available on this subject. In heat-treating and carburizing furnaces, chromel "A" is often used; chromel "C" and nichrome last many months in lead baths. Chromel and nichrome do not volatilize so readily as iron; base-metal couples are thus better protected by these tubes than by iron or steel. Chromel "A" contains practically no iron, while chromel "C" and nichrome contain considerable.

**Graphite.**—Graphite affords an excellent protection to quartz or porcelain tubes on rare-metal couples, and is frequently used with base-metal couples for molten metals (Fig. 35, No. 3). Porcelain encased in a sheath of graphite can be used in molten aluminum. Platinum couples must be thoroughly protected against the vapors distilled from graphite or carbon, and from the reducing atmosphere present near heated graphite.

**Fireclay.**—Outer tubes of fireclay are used for protection in kilns, glass and steel furnaces, annealing ovens, etc. (Fig. 35, No. 4). Usually they are mounted vertically in the top of the furnace and may be cemented in place. Small fireclay insulating tubes are used on base-metal couples.

**Corundite.**—Corundite consists of emery with a plastic clay binder (Fig. 35, No. 5). It is used in ceramic and glass industries for outer protection tubes.

**Alundum.**—Natural corundum usually contains a large amount of iron. The artificial product, fused  $Al_2O_3$ , or alundum, is practically free from iron, and is very desirable for protecting rare-metal couples and also as outer protecting tubes. The tubes are made from pulverized alumina mixed with a clay binder. The inner protecting tubes are glazed, in order to reduce porosity, and the glaze is coated with an outer layer of alundum; this method permits the tubes to be used at temperatures above the softening point of the glaze, being serviceable up to 1400° C. Outer protecting tubes, without glazing, withstand temperatures up

to 1550° C., and even higher. Alundum is mechanically strong and resists temperature changes much better than porcelain.

*Nickel.*—Pure nickel is frequently used in cyanide baths. In an oxidizing atmosphere a thick, tough coating of oxide forms and affords protection against further corrosion.

*Steel and Iron.*—Seamless steel and wrought-iron tubes are usually furnished with base-metal couples. They are satisfactory for many processes up to 800° or 900° C, for example., in a muffle furnace.

*Calorized Iron.*—Calorizing is a process by which the surface of a wrought-iron tube is impregnated with metallic aluminum. Calorized tubes resist oxidation better than the pure iron or steel.

*Duriron.*—Duriron, a high-silicon iron alloy, is sometimes used, at lower temperatures, as a protection against acid fumes. When subjected to sudden temperature changes the material may fracture.

## DISCUSSION

C. B. THWING, Philadelphia, Pa.—It has become so customary to refer to the potentiometer method as the ideal method which fits everywhere that the impression is general that this method has no limitation. The faults of the galvanometer method are so well known that a word should occasionally be said on the other side. There has been a marked improvement in the construction of the galvanometers and little in the construction of the potentiometers.

At the time we began to build recording instruments, millivoltmeters, we called our 75-ohm instrument a high-resistance instrument; and it was high in comparison with the 5-ohm instruments then in use. At the present time we build a galvanometer with 800 to 1000 ohms resistance that has just as good control. Mr. Foote mentioned 300 ohms as the desirable resistance for a good, rugged millivoltmeter. If he had been writing 5 years ago, he would have said 30 ohms. It is just as easy now to make them 800, or 1000 ohms, that is, on the 50-millivolt basis.

A. O. ASHMAN, Palmerton, Pa.—Unquestionably the instruments most used in pyrometric work are of the galvanometer type. We are so accustomed to thinking in terms of high-resistance instruments that, I believe, today we have gone to the extreme. We are all well acquainted with the evils of the low-resistance instrument and think the cure is to make an extremely high-resistance instrument. There are, from a practical point of view, several objections to this. One is the large zero shift in these high-resistance instruments or the highly sensitive instruments. This zero shift, on a 200 division scale, in my experience, has amounted to 5 and 6 and sometimes 10 divisions. It is very hard to compensate for this in practice, although it can be done.

Another thing, the tendency toward greater delicacy makes these instruments less robust. We have found that the higher the resistance, the more often are the instruments in error, due to dropping and accidents, and usually these errors are greater than the accuracy gained by using the high-resistance instrument.

C. H. WILSON,\* New York, N. Y. (written discussion†).—On page 122, the authors say, that if the zone-box principle of connections be-

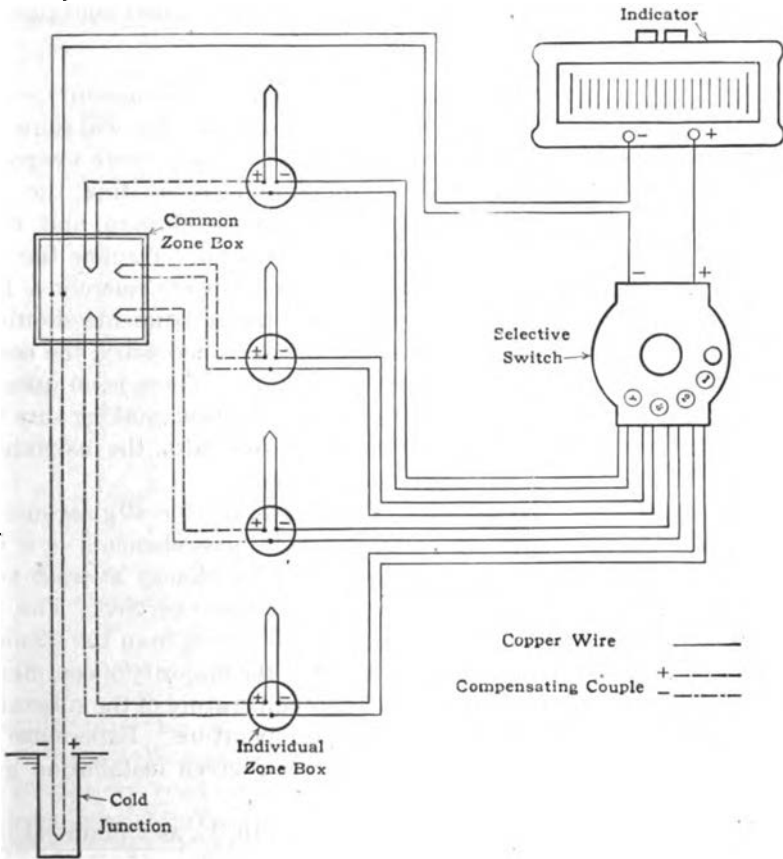

FIG. 36.

tween primary couple, compensator couple, and copper leads, which method in its application to a single couple is shown in Fig. 34, is adopted for a multiple installation, so as to save compensating leads, a selective switch may be (and the inference is that it must be) inserted between the zone box and the different couples, putting the switch at an

\* Wilson-Maeulen Co.

† Received Sept. 20, 1919.

inconvenient point, or putting up with some complicated interlacing of connections. Wilson-Maeulen Co. has employed the zone-box method extensively for several years and in none of the many multiple installations has either of those alternatives been resorted to. Instead there has been used a method of wiring with the switch at the indicator and involving no more complications than the junction-box method shown in Fig. 32. A diagram of this method is given in Fig. 36. The preference between the zone box and the junction box is not of principle but is dependent on relative location of furnaces, indicator, and cold-junction point.

J. T. LITTLETON, JR.,\* Corning, N. Y. (written discussion†).—This discussion will add little that has not been brought out but will show how the problems encountered in the Corning Glass Works were overcome. The chief points of consideration in any equipment are, first, the work the equipment is called upon to do; second, the installation; and, third, the man who will use it. These three points should determine the type of apparatus adopted. If only rough measurements, merely a little better than the eye, are desired, the cost of the instruments should be considered; but if accurate temperature control is necessary, the cost of the equipment deserves only small consideration. There is no question that the real problem for any factory is the installation, making sure that the elements really give the temperatures desired; also, the instruments must be so designed that any man can use them.

Platinum-rhodium thermocouples are necessary for all glass-melting operations. As the change in calibration of these elements is a very serious factor, each element should be tested for change at least twice a week when used for continuous high-temperature service. The new couples should also be calibrated, as couples differing from the standard by  $10^{\circ}$  C. at  $1200^{\circ}$  C. are often met with. For the majority of commercial work it is not necessary to know the actual temperature of the substances treated but it is necessary to control this temperature. Experience will show that a certain temperature reading on a given installation gives the desired results.

The authors of the paper set plus or minus  $10^{\circ}$  C. as a practical limit of accuracy; this variation is too great. Glasses at the standard melting temperature vary in viscosity about 20 per cent. for such a temperature change. The relaxation time in annealing will vary by a factor of 4 for such a range. Besides, greater accuracy of control can be obtained. The curves shown prove this point. They are from a regular factory chart for a 24-hr. run on a large glass pot furnace and record that a plus or minus  $5^{\circ}$  variation is not too much to demand or set as a standard. Accordingly if an instrument or couple should fail, previous conditions

\* Physical Laboratory, Corning Glass Works.

† Received Oct. 8, 1919.

should be reproducible to within that degree of accuracy at least. That demands a standard testing equipment.

Test standardizing equipment at the Corning Glass Works consists of a primary, a secondary, and a factory standard thermocouple. The primary standard is a Bureau of Standards couple that is checked against the secondary standard about twice a year and against the melting point of standard metals furnished by the Bureau of Standards. The secondary standard is checked at the gold point whenever thought desirable. The factory standard element is checked against the secondary standard

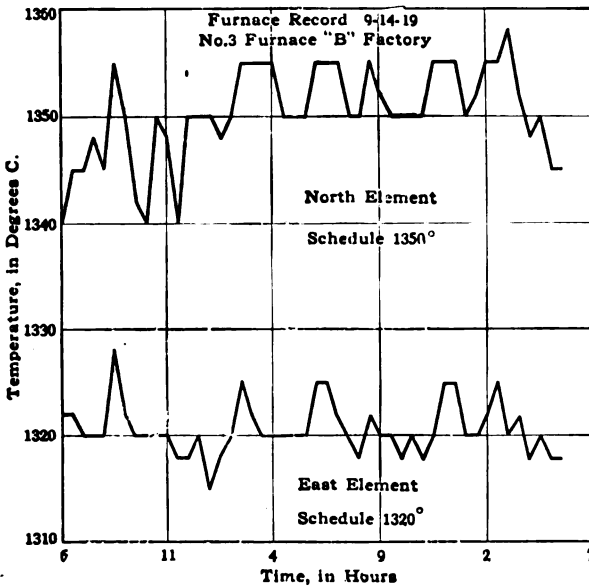

FIG. 37.

at regular intervals by means of a Leeds & Northrup precision potentiometer with a Bureau certified standard cell. The difference between the couples is read directly by connecting them in opposition. A nichrome-wound furnace is used as a standardizing furnace and corrections above the limit of this furnace are obtained by extrapolation. Each factory couple is mounted in a double-bore hard-clay tube and twice a week the factory standard is placed in the hole beside the couple under test and the correction obtained. Records are kept of these corrections and the actual temperature of the element tube may be known at any time to within about 3° C. The schedule is modified to meet all calibration changes. This merely amounts to using a slightly different temperature unit. It would be unfair to many manufacturers to give the results obtained with particular instruments, as what will best suit one set of conditions will not suit another.

An instrument that requires two settings before taking a temperature reading is not suitable for some operations. If the temperature is changing rapidly the instrument lag may be sufficient to cause trouble. Also, when the instrument is in the hands of an unskilled operator, as is nearly always the case, the chances of error are increased. If many temperatures are taken, the time involved may be a factor. Line-resistance and cold-junction changes should be given all the consideration possible. Water-cooled cold junctions are used on all platinum-rhodium elements. About 170,000 gal. of water a year are used on each couple. This costs about \$6 a year, including overhead and installation depreciation; the installation cost is about \$25 per couple.

Line resistance, due to faulty connections and deteriorated base-metal couples, has at times caused a difference as great as 200° C. By using a 500-ohm resistance deflection-type suspension millivoltmeter, together with a potentiometer recorder, all such changes are instantly picked up due to failure of the two instruments to check. Serious damage might have been incurred had the furnace had to wait until the line resistance could be checked before the change was discovered.

On base-metal couples, a partial-deflection potentiometer is used; this will indicate a high resistance when the partial-deflection readings do not check the balanced settings. The ordinary operator will not notice a change in sensitivity of the potentiometer.

The chief point of advantage of the dual system is that it gives the desirable features of both types of instruments without the disadvantage of a second setting common to the types which combine the two in one instrument. It may be said that trouble has been experienced in getting operators to control by a recorder.

The general installation is the real factory problem. With the proper installation most of the high-grade instruments will give good service. The location of the couple, so that it gives a control temperature similar to the substance treated, is extremely important. With the proper central-station control, it is easily possible to overemphasize the robustness of the instrument. One advantage of the deflection type is that it may be mounted in a dust-proof box and need never be touched. The average operator will not write on his record false readings but if he can, so to speak, fool the instrument by throwing two couples in parallel or by any other means smooth out his record, he might do so. Any opportunity for him to get at the wiring should be avoided.

Switches are sources of continuous annoyance. The protection tubes used are all manufactured in the ceramic laboratory of the Corning Glass Works and are satisfactory, though improvements are always desirable. The Corning Glass Works has had thermoelectric equipment for about 15 years and the present system is the result of much experimentation and work. Satisfactory results are obtained but there are problems still ahead.

EWART S. TAYLORSON,\* Pittsburgh, Pa. (written discussion)†.—  
The writers of this paper are to be congratulated on being the first to publish a comprehensive collection of thermocouple wiring diagrams; but it is well to point out the difference between the zone-box and cold-junction-box systems. A zone box, as its name implies, is a zone of uniform temperature which, however, need not remain constant. In the cold-junction box the temperature must either remain constant or allowance must be made for its variations. In thermoelectric work, the zone box is used to eliminate the thermoelectric effect of similar junctions connected in opposition in the same circuit by keeping them at the same temperature; their resultant voltage is thus negligible. This principle has been successfully applied for many years in the design of electrical resistances, especially those of low values constructed of constantan.

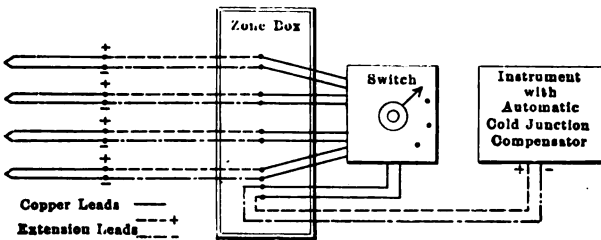

FIG. 38.

The junctions with the copper circuit are brought into close proximity to secure uniformity of temperature and avoid thermoelectric errors. It should be definitely understood, however, that this zone-box principle is not limited to only two opposed junctions; it can be applied to any number of opposed junctions, as shown in Figs. 32, 33 and 34, in which all the junction boxes are in principle zone boxes. Whether these opposed junctions are brought into the zone box as extension leads, as in Fig. 32, or as auxiliary couples, as shown partly in Fig. 33, depends entirely on such factors as economy of material and convenience in wiring. If these points are kept in mind, the criticism of the zone-box system on p. 122 is certainly not justified, as no complicated interlacing circuit is ever necessary and the switch can be placed at any desired position by the use of ordinary copper wire. The copper circuit to the switch and instrument can be of any suitable design as long as it is homogeneous and finally reenters the zone box.

The auxiliary couple shown in Fig. 33 is said to bring the cold junction to the recorder, whereas the diagram shows two junctions, one at the switch and one at the recorder. This, however, can be easily corrected by extending both wires of this couple to the recorder and connecting the free wire to the switch by a copper lead.

\* Research Laboratory, American Sheet & Tin Plate Co. † Received Oct. 17, 1919.



For the sake of completeness, other useful applications of this principle are shown in the diagrams here shown. The first system, Fig. 38, is used with an instrument having an automatic cold-junction compensator, such as some of the Leeds & Northrup potentiometers or the instrument with bimetallic zero control developed by C. R. Darling and recently revived by Bristol. This method is sometimes more convenient than that shown in Fig. 33, though theoretically they fulfill the same purpose.

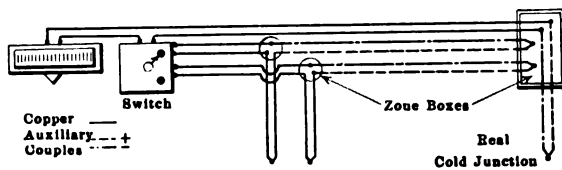

FIG. 39.

Fig. 39 shows a zone-box system that uses only auxiliary couples, thus avoiding the controversy over patents that was in progress at the time this method was developed.

PAUL D. FOOTE, T. R. HARRISON, AND C. O. FAIRCHILD.—Mr. Taylerson arbitrarily defines the “zone box” as equivalent to the junction box already described by us whereas actually the “zone box” is designed for use with a single couple. This is illustrated by Fig. 34 taken from the Wilson-Mæulen catalog. Accordingly his Fig. 38 is the same as our Fig. 33, describing the use of a junction box, except that he employs an additional and unnecessary pair of copper leads between the junction box and the switch and recorder, which are usually located close together and hence are at the same temperature. If for any reason the switch and recorder are at different temperatures, Mr. Taylerson’s method of using the junction box will correct for such a difference, but a simpler method is to use the wiring diagram of Fig. 33, except that a positive compensating lead is substituted for the copper lead from the switch to recorder.

In his Fig. 39, a combination of the zone box and junction box is employed. In general the use of the zone box in such an installation complicates matters and requires additional wiring. However, it may be of advantage under the following condition. If some of the couples in Fig. 33 or 34 are so situated, geometrically, that they lie between the junction box and switch, a zone box may be used at each of these couples, copper leads from the switch to the zone boxes, and compensating leads or auxiliary couple from the zone boxes to the junction box, the method of connection through the zone box being that illustrated by Fig. 34 except that the auxiliary couple terminates in the junction box instead of the

ground. This system saves lengths of copper leads from these couples to the junction box. This paragraph applies also to the discussion by Mr. Wilson on page 129.

W. P. WHITE,\* Washington, D. C. (written discussion †).—From the description, convenient working of the Harrison-Foote compensated indicator involves increasing the circuit resistance to ten or more times that of the thermocouple. This is no disadvantage if a relatively high resistance galvanometer has already been decided upon. The instruments depending on the potentiometer principle do not suffer to the same extent, as Williamson and Roberts have pointed out in their paper on thermocouple installation in annealing kilns. I have found that, in some cases, where one type of reading instrument was said to be superior to another, the real difference lay in the quality of the instrument and not in the principle at all. I must disclaim all credit for the deflection potentiometer shown on p. 94. The split circuit here is employed in a different way from that which I had proposed, and with a different purpose.

It seems possible that the 2° variation of temperature of a point 10 ft. underground, determined in England, may be less than it would usually be in the more variable climate in most parts of this country. This statement is merely to correct a possible misapprehension. If readings of the temperature are taken from month to month, the constancy seems likely to exceed all ordinary requirements.

Nichrome wires and other alloys containing nickel can frequently be wound in fairly close coils without any other insulation than the layer of tarnish which they ordinarily possess. It seems that this fact might sometimes be useful in thermocouple construction, although the trouble and expense of porcelain insulation would usually be preferable to taking any chances. I have found that a furnace wound with No. 32 nichrome wire worked well without any special insulation, and the efficiency of the oxide layer would be enormously greater with the very large wires used for commercial base-metal couples. Apparently it would not do to trust the oxide layer in a reducing atmosphere.

The methods and apparatus here described, although intended for pyrometry, are likely to be applied to work of higher precision. It therefore seems in order to call attention to an error which may come in such work regarding the cold junction where this is different from the room temperature, as it may often be, especially where ice is used. Since copper is a very much better conductor of heat than most of the metals used for thermocouples, its conductivity may, if precautions are not taken, falsify the cold-junction temperature. Even wire as small as No. 18 has been known to do this to a marked degree.

---

\* Physicist, Geophysical Laboratory.

† Received Sept. 25, 1919.

T. R. HARRISON (written discussion\*).—Regarding the objection that the Harrison-Foote instrument requires the use of high resistance in series with the galvanometer, thus reducing the sensitivity of a given instrument, as actually manufactured, this instrument makes use of resistances (sometimes called swamping resistances) placed in series with the moving element for the accomplishment of desirable purposes, other than that referred to (such as reducing temperature coefficient and eliminating the necessity of making too frequent readjustment of the rheostat to compensate for minor changes of resistance). This relatively high resistance has been made possible for thermocouple work through the development of galvanometers of relatively high sensitivity. Through this feature, a construction of the compensating instrument is possible whereby accurate adjustment may be obtained with little care. The principle may be applied, however, by using a much lower swamping resistance than is usually employed; this involves a more careful adjustment of the rheostat in order to realize e.m.f. readings of a given accuracy.

If a swamping resistance value equal to the maximum resistance of couples to be used with the instrument is adopted, adjustment must be made with a precision equal to that required in the final e.m.f. reading. Further reduction of the swamping resistance nets no gain in precision of e.m.f. observations, as the increased sensitivity is offset by the necessity of proportionately increased accuracy of adjustment. Thus, any galvanometer provided with swamping resistance as great as the maximum allowable resistance of the couple can be converted into a Harrison-Foote compensated instrument without the addition of any resistance whatever to the circuit. Evidently the possible sensitivity increases as the maximum allowable couple resistance is reduced.

---

\* Received Oct. 27, 1919.

## Potentiometers for Thermoelement Work

BY WALTER P. WHITE,\* WASHINGTON, D. C.

(Chicago Meeting, September, 1919)

THE measurement of the reading of a thermoelement is the measurement of an electromotive force extraordinarily small compared to those generally used in commercial work. Of the various possible methods of measuring such a quantity, the most advantageous is always a delicate galvanometer. Since a galvanometer measures current, it is necessary to adopt some scheme by which its current reading shall indicate electromotive force.

There are two general methods of doing this. One is to use the delicate galvanometer as a "direct reader," that is, to let the electromotive force of the thermoelement furnish the power and produce the current measured. If the resistance is constant the reading will, after a suitable calibration, give the electromotive force of the thermoelement which, by means of a table or of a suitable scale in the galvanometer itself, will

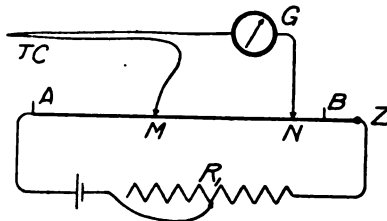

FIG. 1.—SIMPLIFIED POTENTIOMETER. POTENTIAL DROP ACROSS THE PART *MN* OF CIRCUIT OF BULL CELL BALANCES THAT OF THERMOELEMENT *TC* WHEN GALVANOMETER *G* READS ZERO.

give the temperature. The other method, that of the potentiometer, is to balance the electromotive force of the thermoelement by means of another electromotive force, using the galvanometer to tell when the balance is made. The usual way of getting this other electromotive force is to have a battery, the "bull" cell, send a current through a series of resistances, which may in a special case be the resistance of a single wire. The fall of potential along this circuit will then, by Ohm's Law, be proportional to the resistance; the potential difference between any two points, proportional to the resistance between the two points. This is represented in Fig. 1, where *M* and *N* are the two points in the circuit *AZ* of the battery. If *M* or *N*, or both, is movable so that the resistance

\* Physicist, Geophysical Laboratory, Carnegie Institution of Washington.

$MN$  can be varied, the electromotive force between  $M$  and  $N$  may be made equal to that of the thermocouple  $TC$ . When this has been done, there will be no deflection of the galvanometer in the subordinate circuit  $MNGTC$ . The reading  $MN$  then gives the reading of the thermoelement. Since there is no current flowing in the subordinate circuit, the resistance of the thermoelement is of no importance, but the current from the bull cell as well as the resistance  $MN$  must be known. The usual way of determining this current is to adjust it until the potential drop along another part of the resistance, say,  $AB$ , just balances the electromotive force of a standard cell. The potentiometer thus compares thermocouple electromotive force with that of the standard cell by means of the ratio of two resistances, here  $AB$  and  $MN$ , using an adjustable and reasonably constant current as an essential agent in the comparison.

*Direct-reading Galvanometer.*—In comparing these two methods, the direct reader and the potentiometer, it is evident that the direct reader excels in simplicity of apparatus and also in quickness, since no adjustments are necessary. This latter advantage is not important in simple readings, but in making a recording instrument the greater simplicity of the direct reader is especially evident, since otherwise the recorder must not only record but actually adjust the position of a contact corresponding to  $M$  or  $N$ . The disadvantages of the direct reader, however, are serious. Chief among these is the requirement of constant resistance, while contacts, unless great care is used, are apt to introduce uncertain and treacherous resistances. Nickel-plated contacts are particularly bad in this respect; less oxidizable than brass, they are more apt to be neglected, and frequently look in excellent condition when their conducting power has been almost destroyed by tarnish.

*Delicacy of Galvanometer.*—This resistance difficulty is complicated by one of the restrictions of the galvanometer. The electromotive force corresponding to  $1^\circ$ , with the most sensitive thermocouples, is seldom much more than 50 microvolts, or  $\frac{1}{2,000,000}$  of the smallest commercial voltage ordinarily used, hence extreme delicacy is required in the galvanometer. Now, the lower the resistance of the circuit the larger is the current for a given voltage, hence the less delicate does the galvanometer need to be. It is, therefore, unfortunate that diminishing the circuit resistance increases the proportionate effect of the troublesome accidental changes of resistance. Whether, in view of this detrimental effect of low-circuit resistance, it is well to make the galvanometer "robust" by diminishing resistance, is a question that has been much discussed. In general, the requirement of extreme delicacy in the galvanometer has acted as an obstacle to the use of electrical methods. Hence its discussion here seems in order.

There are three ways of overcoming the difficulty that arises from the

delicacy of a galvanometer. The first is by improving the robustness of delicate-reading instruments, and the manufacturers have done much in this direction. Portable galvanometers capable of being read (by estimation of tenths) to 1 microvolt can now be had, and greater robustness can be given to the more sensitive reflecting instruments as soon as demand becomes more effective. In particular, an enormous improvement could very easily be made by replacing the often worse than useless levels now furnished.

A second way is for the users to overcome their extreme objections to the sensitive galvanometer. Those who have worked with these instruments know that the objections are largely psychological. A few years ago, it was given as a reason against using electrical instruments that they must ultimately be put in the hands of the dollar-a-day man, who could not be expected to handle them. Evidence is continually accumulating that if the 20-dollar-a-day man knows as much about the installation as he ought to, there is very little difficulty in getting the lower paid employee to use them as well as he needs to. The amount of care and skill required to use a delicate galvanometer does not compare with that put forth by a good machinist in half the things he does. Yet even the machinist is often offended by the galvanometer. He is used to taking pains in certain directions and the different precautions needed by the galvanometer may appear unreasonable. With better understanding and familiarity, this subjective difficulty may be expected gradually to disappear and we may have a number of important measurements made electrically that at present are scarcely known outside of a few laboratories. Of course these will seldom be with pyrometers, on which such delicate measurements would usually be wasted, and they would not necessarily be in the unfavorable situations where many pyrometers must now be used. In particular, a very unsteady support has for delicate galvanometers a detrimental effect the overcoming of which may be so expensive as to prohibit the use of the sensitive reflecting galvanometer in such locations.

A third way of overcoming the difficulties arising from the delicacy of a galvanometer is to increase the current by decreasing the resistance, a method whose limitations have already been discussed.

*Lack of Relative Precision in Direct-reading Galvanometer.*—A second objection to the direct reader is its lack of relative precision. Opinions may differ as to whether such instruments can generally be relied upon to 1 part in 500 of their deflection, or to 1 part in 2000, but the limit is certainly reached at a point far short of that for even a simple potentiometer. Of course, for reading temperatures below 1000°, in cases where a precision of 10° is sufficient, anything reading to 1 per cent. is adequate, but it is the cases of greater precision that most need discussion so far as auxiliary apparatus is concerned.

*Simple Potentiometer.*—The difficulties of the direct reader, except those due to delicacy of the galvanometer, are entirely absent in the potentiometer. The objections to the potentiometer are its greater cost and complexity, the protection needed by the standard cell, and the attention that must be given to the constant cell. The greater time required to make a setting is ordinarily almost inappreciable, because once the setting is made small divergences from it can be read directly on the galvanometer. Thus the quickness of the direct reader and the precision of the potentiometer are combined. To thus use the potentiometer as a “deflection potentiometer,” of course, demands that the galvanometer sensitiveness shall have an exact value, though this requirement is much less severe than where the galvanometer handles the whole quantity to be measured. Those who do not care to keep their galvanometer in this condition may have the advantage of being entirely independent of its calibration at the cost of a little more time in making the settings.

*Devices to Avoid Use of Standard Cell.*—Considerable effort has been expended to avoid the use of the standard cell. Some time ago a poten-

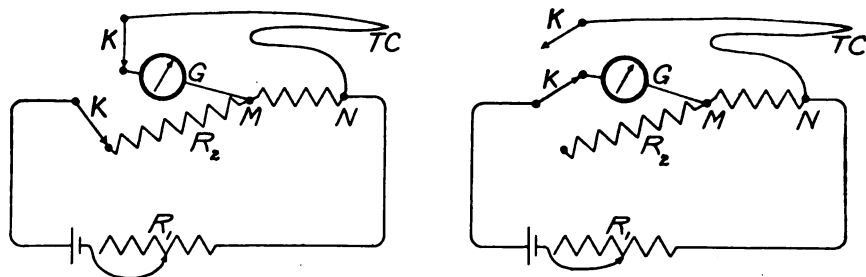

FIG. 2.—PYROVOLTER. FIRST POSITION, POTENTIAL DROP  $MN$  IS MADE EQUAL TO ELECTROMOTIVE FORCE OF THERMOELEMENT; SECOND POSITION, CURRENT IS MEASURED BY SAME GALVANOMETER.

tiometer was designed at the Reichsanstalt in which the current was kept constant by the reading of an ammeter. This instrument had two galvanometers, namely, the ammeter and the more delicate balance-galvanometer, and yet the final precision was no greater than that of the direct-reading ammeter. A simpler arrangement for the same general purpose is illustrated in Fig. 1 of a paper by E. D. Williamson and H. S. Roberts.<sup>1</sup> Here the current is variable and the resistance corresponding to  $MM$  of the present paper (see Fig. 1) is constant, so that the reading is made on the ammeter scale instead of on a number of resistance dials.

*The Pyrovolter.*—A further improvement is made possible by the principle of the pyrovolter,<sup>2</sup> Fig. 2, in which the same galvanometer is

<sup>1</sup> This volume, p. 468.

<sup>2</sup> Manufactured by the Pyroelectric Instrument Co., of Trenton, N. J.

ingeniously employed to fulfil both functions; first, to establish a balance, and second, to measure the current. A resistance  $R_2$  replaces the galvanometer when that is not in the main circuit, so that the transfer of the galvanometer does not alter the current. In this case, as in Williamson and Roberts' Fig. 1, the current is not kept constant as in the orthodox potentiometer, but is adjusted to give a suitable drop over a constant resistance  $MN$ . There are thus no resistances to be measured. A variable rheostat  $R_1$ , which is not read, adjusts the current and the second, or final, reading depends, as in the direct reader, on the calibration of the galvanometer. The advantage is in eliminating resistance difficulties in the thermoelement. The operation of the instrument involves, first, an adjustment to a zero reading of the galvanometer, as with a regular

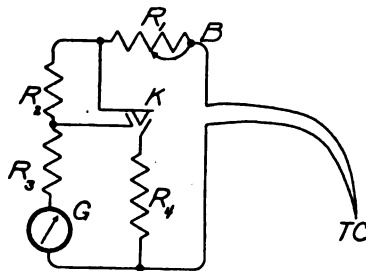

FIG. 3.—BROWN IMPROVED HEATMETER. DEPRESSION OF KEY DOES NOT CHANGE DEFLECTION WHEN CIRCUIT RESISTANCE IS ADJUSTED TO PROPER VALUE.

potentiometer, but following that, instead of reading the resistance setting the ammeter deflection is produced and that is read just as with a direct reader.

It is easy to show that with this instrument, and any given galvanometer sensitiveness, the zero setting is less sensitive than the final reading, and this difference becomes very large if the galvanometer resistance or the thermocouple resistance is, accidentally or otherwise, much higher than the resistance of the fixed coil. In some instruments this difficulty is overcome by varying the current sensitiveness of the galvanometer. The difficulty should also be small if the thermocouple resistance is not greater than that for which the instrument was designed.

*Harrison and Foote Instrument.*—The same advantage, namely, avoidance of error from uncertain thermocouple resistance, is obtained in a new instrument designed by Harrison and Foote (the Brown Improved Heatmeter, Fig. 3) in which the potentiometer principle is not used at all. The circuit resistance is adjusted to compensate for any changes or differences in the thermoelement, and in this the thermocouple itself is used as a source of temporarily constant current. The instrument thus avoids one of the disadvantages of the potentiometer, namely, the battery,



and therein lies perhaps its main advantage. The operation is shown in Fig. 3. By pressing the key  $K$  the circuit is shortened by cutting out the resistance  $R_2$ , which tends to increase the galvanometer deflection. At the same time the galvanometer is shunted by the resistance  $R_4$ , which tends to decrease the deflection. These two effects will offset each other, and there will be no change, when the resistance of the rest of the circuit has a particular value. Hence by adjusting the resistance  $R_1$  until the depression of the key  $K$  makes no change in the deflection, the instrument becomes a perfect direct reader, since its circuit resistance is correct. The adjustment is not nearly as difficult as it might at first sound, for the galvanometer when the key is down is much more sensitive to resistance changes. Hence one or at most two trials are nearly always sufficient to get the adjustment. On account of the greater sensitiveness shown by the galvanometer when the key is down, the error of reading at that time produces a negligible effect. Hence the accidental error of only one reading comes in. Once set, the instrument can be used as a direct reader for some time. The pyrovolter can also be used to give this advantage by means of a special addition. The instrument is to be more fully described.

All these instruments (Reichsanstalt instrument, pyrovolter, Harrison and Foote instrument) avoid merely the trouble from uncertain resistance. They are dependent on the calibration of an ammeter. For higher precision than that will give there has been with the thermolement as yet no auxiliary which did not involve the use of the standard cell. The attempts to avoid its use are to be laid mainly to the feeling that it is an unnecessary complication. But although an additional complication, it is not one to be seriously shunned if precision is desired.

*Portable Potentiometer.*—For the next grade of precision after the ammeter readers, a simple and portable potentiometer is made by the Leeds & Northrup Co. Here a coiled slide wire furnishes the  $MN$  of Fig. 1. Settings upon this can be made to 100 microvolts and read to about 10 microvolts, or less than a quarter of a degree with ordinary base-metal thermocouples. A robust, portable galvanometer forms part of the instrument and gives about the same precision as the slide wire.

*Precision Potentiometer.*—The next step in precision is far more conveniently secured by abandoning the slide wire, since the contact on this wire is a source of "parasitic" electromotive forces that are annoying even when they do not seriously impair the precision of the observations. It is true that slide-wire potentiometers reading to 1 microvolt have been used, and the question as to just what precision can be advantageously obtained with them is evidently to some extent a matter of opinion. But they certainly cannot go much farther than the simple potentiometer just described, while by passing over to another type of potentiometer we not only get microvolt precision with the greatest ease

and certainty, but can with almost as great ease, though at the cost of certain imperative experimental features, read to 0.1 microvolt with only a little more care and precaution than is needed for far less precision with any of the other instruments just described. Reading to 0.1 microvolt means that two thermocouples in series will give the sensitiveness and more than the precision of a Beckmann thermometer, while a multiple thermoelement only 3 mm. in diameter will reach a precision of ten times that, and equal to that of a standard calorimetric platinum resistance thermometer. This precision of 0.1 microvolt demands the use of copper switches at certain points in the circuit and also requires a galvanometer of considerably higher sensitiveness than those known as portable.

A complete description of such apparatus does not seem necessary in a discussion more especially devoted to pyrometry. Such instruments, however, are used for the calibration and comparison of standards, and open up a field for the thermoelement more extensive and varied and not unlikely to become more widely cultivated than the whole subject of thermoelectric pyrometry. It seems worth while, therefore, to state the principle of the modern thermoelectric potentiometer and to explain what are its essential requirements. In general, the advantage of resistance electric methods, such as that of the Wheatstone bridge, consists in the fact that variation in the battery or other source of electromotive force is largely compensated. The advantage of potential methods, on the other hand, lies in their independence of contact resistances.

In the high-precision potentiometer, it is necessary to minimize difficulties coming from the variation in the cell current, while at the same time preserving the advantage of negligible contact resistance. The first has been satisfactorily accomplished by the use of lead and nickel storage cells (the latter are nearly if not quite as satisfactory as the lead cell and are much less likely to deteriorate); but the contact resistance introduces a difficulty. In Fig. 1 there are two movable contacts  $M$  and  $N$ , which come into the galvanometer circuit where no appreciable current flows and where therefore resistance is not important. If  $M$  and  $N$  are each nine-step or ten-step dials, there is a variation from 1 to 100 in the electromotive force which can be read by the dials—but that is the maximum variation that can be obtained in this simple way. If the resistance  $MN$  is varied by putting a variable resistance in the battery circuit between  $M$  and  $N$ , the resistance of the necessary contacts now affects the electromotive force in that part of the circuit. If  $MN$  is small, as it is in reading the thermoelement, it is practically impossible to get a satisfactory potentiometer in this way. It is to avoid this difficulty and get a large range of variation with only two contacts that the slide wire has been used.

Where the slide wire has been considered inadmissible, a number of different schemes have been used to get more than two dials without

contact-resistance error. The older Wolff potentiometer simply increased the resistance of the whole instrument to a very high value; this interfered with the sensitiveness of the galvanometer and even then did not give sufficient precision for the best thermoelectric work. Two schemes, however, have been successful. One, that of the Diesselhorst-Wolff potentiometer, a combination of devices suggested by several writers, in which  $M$  and  $N$  are on two sides of a divided circuit, so that even when they are at the same potential considerable resistance lies in the path from one to the other. Shunts applied to this resistance can change the difference of potential between  $M$  and  $N$  without introducing contact-resistance error into the main line. It is still necessary, however, that the contact resistance be kept small; hence the instrument, although admirably successful, demands almost daily attention for its contacts.

This difficulty is avoided in the White potentiometer, where two simple potentiometers, like Fig. 1, are in series in the same galvanometer circuit. This has two separate bull cells, but one of these requires very infrequent adjustment, while the contact requirements are such that the contacts have, under good conditions, literally been left without attention for more than a year without any detriment. Where corrosive gases are present this treatment might not be possible, but this type of potentiometer evidently has a very great special advantage under such conditions. The principle of the instrument is evidently simple and needs no further explanation. But two features of some importance seem to deserve a more detailed description.

*Partial-deflection Method of Reading.*—The development of the thermoelement potentiometer has been somewhat modified by a more or less accidental circumstance arising out of the fact that the Geophysical Laboratory has taken a part in that development. When that laboratory was first organized, the Director, Dr. A. L. Day, in reading varying temperatures for "melting-point curves" and the like, did not follow the plan, frequently and perhaps generally used, of using the galvanometer as a null instrument and observing the irregularly varying times at which its deflection passed through zero as integral changes were made in the resistance setting. Instead, the readings were made at even minutes, which necessitated taking the last figures of the result from the galvanometer deflection. This practise soon led to an attempt to keep the galvanometer sensitiveness constant and hence to the development of the "partial deflection" methods, that is, partial direct-reading methods, where the potentiometer matches most of the unknown electromotive force, but a small residual effect is directly read. When special thermoelement potentiometer designs began to be made, this feature of constant galvanometer sensitiveness, that is, constant galvanometer-circuit resistance, was incorporated in them. The scheme was accepted by Diesselhorst and embodied in the Diesselhorst-Wolff potentiometer and

is a feature of the White potentiometer, where it is secured by the simple device of putting supplementary coils of low precision in series with the contact points of some of the switch dials, so that as the resistance directly between  $M$  and  $N$  is altered, the resistance in the galvanometer circuit nevertheless remains unchanged. This constancy of resistance is merely a convenience for rapid reading. It does not need to be as accurate as it would be if the galvanometer were reading the whole quantity, and practically no possibility of error is ever connected with it. This feature, although it characterizes the thermoelement potentiometer, could also be applied to the Wheatstone bridge, but has not been, at least not generally. The result is that frequently resistance thermometer measurements have been regularly made by two observers and with uneven time intervals, while observations of equal precision could be made with as great ease, at any desired times, by a single observer with a thermoelement and a suitable potentiometer.

*Double Potentiometer.*—Another feature of this potentiometer enables the single observer to read several temperatures in very rapid succession. This is done by having the dials in duplicate but attached to the same coils, and with an arrangement for throwing one or the other set of dials into operation at will along with a different thermoelement. Hence where the temperatures, for instance, of two different bodies are being followed, the observer can go back and forth from one to the other without having to reset all his switches each time. The gain is merely one in time, but that is very often important. Such an arrangement could be applied to the resistance thermometer or to other apparatus, but is especially advantageous in the potentiometer for several reasons. (1) The independence of contact resistance, shown by this potentiometer system generally, renders exchanges of instrument easy to make with rapidity and without error. (2) Single thermocouples can be very easily constructed in practically exact duplicates of each other, so that in any case where numerous temperatures are to be read the thermoelement has a decided advantage quite aside from its sensitiveness and small dimensions. (3) The thermoelement furnishes its own power and can be read directly by the galvanometer. In almost every system involving a number of thermoelements it is easy to arrange a number of them in such a way that the reading of each shall be a small quantity. Hence they can be read directly from the galvanometer while others in the same set-up are combined with the potentiometer. The exchanging arrangement in the White potentiometer makes provision for this combination so that three different thermoelements, at least, and usually a much larger number, can be used without changing switches.

The instrumental arrangements necessary as safeguards with the potentiometer have been fully described. The present paper is not a description of potentiometer manipulation, but merely a discussion of the

advantages of different systems; hence it will be sufficient to state what these safeguards are. One is the equipotential shield, which guards the system against leakage from the relatively high voltage of commercial circuits. The second is a switch constructed of copper so as to be itself free from thermoelectric forces (an ordinary knife switch will usually answer perfectly), used to eliminate parasitic thermoelectromotive forces within the galvanometer and other parts of the potentiometer system. These two safeguards<sup>3</sup> are the same in principle as those necessary with other systems of equal sensitiveness.

#### SUMMARY

Thermocouple pyrometers are read in three ways. (1) By direct readers where the current, and therefore the deflection, is proportional to the electromotive force of the couple. (2) By potentiometers, where the galvanometer merely helps to balance the electromotive force of the couple against that of a standard cell by means of known resistances and a constant battery current. (3) By intermediate instruments, such as the pyrovoltmeter, employing the potentiometer principle with a constant battery, but avoiding the standard cell, and measuring current with a calibrated galvanometer. Similar in result, but different in principle, is the new Harrison-Foote instrument, where the circuit resistance can be very quickly adjusted to the correct value. All these special instruments avoid the main difficulty of a direct reader, namely, the error from uncertain or variable resistance. It is necessary to use the regular potentiometer in order to avoid also the uncertainty (perhaps 1 per mille) of the calibration of the direct reader. With a slide wire, a simple and portable potentiometer is made good to about 10 microvolts, or  $\frac{1}{4}^{\circ}$  with most thermocouples. The slide wire also permits readings to 1 microvolt, though not altogether satisfactorily. Two special designs of potentiometer, the Diesselhorst-Wolff and the White, enable readings to be made to 0.1 microvolt or better, and the White potentiometer is very little affected by corrosive gases. Both of these are deflection potentiometers, enabling part of the readings to be taken direct from the galvanometer with a gain in speed and without sensible error. If the potentiometer is arranged as a double potentiometer, speed can be gained in reading different instruments simultaneously. The precision of these potentiometers exceeds that needed in ordinary pyrometry, but is useful in fundamental standardization work, in calorimetry, and in numerous other applications of the thermoelement.

---

<sup>3</sup> Walter P. White: Thermoelement Installation, especially for Calorimetry. Leakage Prevention by Shielding, especially in Potentiometer Systems. *Jnl. Am. Chem. Soc.* (1914) **36**, 1859, 2011.

DISCUSSION

T. R. HARRISON, Washington, D. C. (written discussion\*).—Advantage will be taken of this occasion to mention briefly a form of double potentiometer which has been used at the Bureau of Standards for about 2½ yr. in calibrating thermocouples. The calibrations referred to are those made by comparison to standard couples.

In order to insure equality of temperature between the couples, the junctions are fused together; consideration of fundamental principles will show that this introduces no error. Two separate potentiometers are used, one connected to each thermocouple, and each potentiometer is provided with a reflecting galvanometer. The two spots of light are reflected onto a single scale, the galvanometers being set in such a position that the spots coincide on the scale at a point marked zero when the circuits are open or when the potentiometers are balanced. By setting one potentiometer to a desired value and adjusting the other so that both spots pass across the scale together as the temperature rises or falls, simultaneous readings are obtained.

By making observations first with a rising temperature and then with a falling temperature, the rates of rise and fall being approximately equal, and taking the means of the results found, several minor errors such as those due to differences in the time lags of the two systems, etc., are eliminated or greatly reduced. The differences between the values observed with rising and falling temperatures are usually less than 1° with rare-metal couples. By this method a calibration may be made rapidly and with accuracy, since the junctions are fused together and means are provided for taking simultaneous readings on the couples while the temperature is changing.

On account of the fact that the junctions of the couples are in electrical contact and the readings must be made simultaneously, it is necessary to use potentiometers having entirely independent circuits.

LEASON H. ADAMS,† Washington, D. C. (written discussion‡).—For precision work with thermocouples in the laboratory, all are agreed on the necessity of using a potentiometer in connection with a reflecting galvanometer; but in the choice of an instrument for the factory, opinions seem to differ. Doctor White has discussed the advantages and disadvantages of three classes of portable instruments: the direct-reading millivoltmeter, the portable potentiometer, and the class to which belong the pyrovoltmeter and the heat-meter. My experience with pyrometer installations in the factory has led me to prefer the portable

\*Received Sept. 25, 1919.

† Physical Chemist, Geophysical Laboratory.

‡ Received Sept. 25, 1919.

potentiometer and to consider that in accuracy, convenience, and reliability it is far superior to the other instruments. The fact that this potentiometer requires a battery and a standard cell has not proved to be a drawback, since they are built into the case of the instrument and require very little attention. Moreover, no difficulty has been experienced in teaching unskilled laborers to make accurate readings with the the portable potentiometer, a few minutes' instruction being sufficient in all cases. The portable potentiometer has also proved to be very convenient for use in the laboratory when the extreme accuracy of the precision potentiometer is not required.

W. E. FORSYTHE, Nela Park, Cleveland, O.—In measuring the temperature of a lamp, we control the current with the potentiometer; we want to measure that as accurately as possible and still have some speed. We have adopted the principle of the deflection potentiometer. We connected a millivoltmeter between the binding post of a regular Leeds & Northrup potentiometer, which is there to test out the slide wire, and a movable plug in the *Br* dial of the potentiometer. As this deflection instrument is connected, only a very small part of the current is measured by it. Thus, by using the ordinary deflection millivoltmeter, we arranged the connections so that currents can be read to better than 1 part in 4000 by simply reading a deflecting instrument. We have never attempted to make this deflecting instrument direct reading, but have always had the readings recorded as they were made. At the end of the series, the deflections were averaged and the corresponding current determined by the potentiometer.

## Self-checking Galvanometer Pyrometer

BY H. F. PORTER,\* E. E., TRENTON, N. J.

(Chicago Meeting, September, 1919)

MUCH has been written relative to the errors involved in the use of a galvanometer for measuring thermocouple electromotive forces. In general, it may be said that accuracy with a galvanometer is secured only at the sacrifice of durability, unless manual adjustment is made in the operation of the instrument to overcome the errors of resistance and resistance changes. The pyrovoltmeter and the potentiometer both require manual adjustment for every reading, readings being taken on a "null" method.

To the end that some of these balances may be eliminated and only an occasional balance be made as a check reading, the "continuously deflecting pyrovoltmeter" was developed. Essentially, the operation of the continuously deflecting pyrovoltmeter is to determine the resistance of the thermocouple circuit, though its value is not noted or indicated, then throwing in series with the thermocouple sufficient resistance to bring the sum up to some standard value for which the indications of the galvanometer will be correct. This result may, however, be accomplished in a somewhat simpler manner, for which general method patents are now in the course of application.

If we devise a galvanometer circuit so that by means of a simple adjustment the resistance of the entire circuit will be rendered equal to some constant predetermined value, we may rely on the galvanometer to give correct e.m.f. indications (assuming that the errors of temperature resistance coefficient and cold junction have been properly allowed for), and will indicate temperature continuously where the e.m.f. measured is developed by a thermocouple.

In Figs. 1 and 2, there is in series with the galvanometer of resistance  $g$  the thermocouple of resistance  $X$  and the rheostat of total resistance  $S$ . To operate the instrument, that is, to make a check to compensate for couple resistance, a button is depressed which connects points  $M$  and  $N$ , as shown in Fig. 1, normally separated, and disconnects points  $P$  and  $Q$ , normally engaged in contact. The slider on the rheostat is adjusted until the resistance  $a$  is zero and the deflection  $D$  of the meter is at its maximum. This deflection is noted, and, still depressing the button, the slider is adjusted until a deflection equal to  $D/2$  is obtained. The button is now released, closing the connection between points  $P$  and  $Q$

\* Secretary, Pyroelectric Instrument Co.



and breaking the contact of  $M$  and  $N$ , as shown in Fig. 2. The resistance  $R_2$  of the entire circuit after this adjustment is complete equals  $S$ , a constant value equal to the total resistance of the rheostat shown. This is easily proved as follows:

Call the resistance of the entire circuit in Fig. 1,  $R_1$ , that is, when  $a$  is zero

$$R_1 = g + X \tag{1}$$

For deflection  $D/2$ , the circuit resistance is  $R_2$

$$R_2 = g + X + a \tag{2}$$

Since adding resistance  $a$  to the circuit halved the current flowing, and hence the deflection, the circuit resistance must have been doubled when the adjustment was complete or  $2R_1 = R_2$ . By substitution from

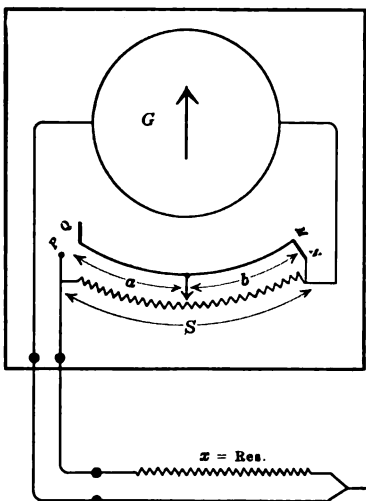

FIG. 1.

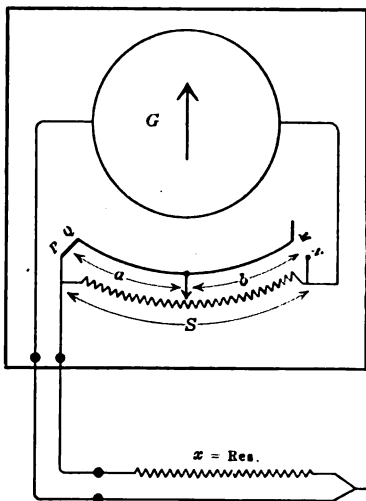

FIG. 2.

formulas (1) and (2),  $2(g + X) = g + X + a$ ; whence  $g + X = a$ . When the button is released and connections are made between  $P$  and  $Q$ , simultaneously breaking the junction between points  $M$  and  $N$ , the circuit resistance  $R_2$  becomes  $R_2 = b + g + X$ ; and since  $g + X = a$ ,  $R_2 = b + a$ .

By definition of  $a$  and  $b$ , they are the component parts of the rheostat and  $a + b = S$ ; so that  $R_2 = a + b = S$  which is the result it was desired to prove.

The following characteristics of this circuit may be of interest. Maximum allowable resistance in thermocouple circuit external to instrument is  $M = (s - g)$ . The e.m.f. range of the instrument is given by  $E = SI$ , where  $I$  is the current required to deflect the galvanometer to full scale.

The relative error of setting is small in direct proportion as  $(b + X)$  is

small in comparison with  $g$ . Also the error of setting for  $D/2$  is inversely increased with reduction in the value of  $D$ .

Many variations of this type of circuit are possible, though their method is essentially the same as that outlined. It must be remembered that check readings can only be taken when the conditions are such that the e.m.f. of the couple is practically constant, but there is no need for such checks except when it is supposed that the circuit resistance may have changed, changes being due to temperature resistance coefficient of leads, couple, of galvanometer coil, depth of immersion of couple, corrosion of some part of the circuit reducing its cross-sectional area of conductor or adding contact resistance, or the shortening of the couple or couple leads. If the rheostat  $S$  is made of manganin or some alloy of practically negligible temperature resistance coefficient, the instrument is free from errors due to change in the resistance of the galvanometer coil, and hence the instrument is free from errors of indication due to temperature changes of the instrument coil.

The main objection to an instrument of this type is that it can only be used conveniently with one couple at a fairly constant depth of immersion and temperature. It is impractical to employ it with several couples and a selective switch or other similar device, unless all the couple circuits are of strictly the same resistance—a circumstance that is difficult to secure and almost impossible to maintain. The chief advantages are the elimination of any form of cell, dry or standard, from the instrument circuit and continuous deflection, with only occasional manual adjustment.

The circuits offer unusual possibilities for the instruction of students in electrical measurements. Knowing the current sensitivity of the galvanometer at full scale and the value of the rheostat, it is possible to determine the galvanometer resistance, battery resistance, and voltage, and to correct a millivoltmeter from all errors due to line drop or extraction of current from a high resistance shunt.

## DISCUSSION

PAUL D. FOOTE AND T. R. HARRISON, Washington, D. C. (written discussion\*).—There are several methods for measuring the internal resistance of a battery, the line resistance in a circuit containing an e.m.f., or the true value of this e.m.f. The writers, however, were the first to employ a simple principle whereby the total resistance of the circuit is adjusted to a preassigned value for which the scale of the millivoltmeter is graduated, the only e.m.f. employed being that of the source measured. One of the simplest forms of these instruments is described on pages 84–85. In papers now in press we have described some twenty modifications of this simple design, all operating upon the same fundamentally new principle. The instrument devised by Mr. Porter is of this general

\* Received Sept. 25, 1919.

type but, unlike the designs we have recommended, is open to serious objections.

If the e.m.f. of the source being measured is equivalent to the full-scale range of Mr. Porter's instrument, the adjustments can be made only if by chance the external resistance  $x$  equals  $s - g$ . Suppose that the full-scale deflection corresponds to  $e$  millivolts; the current required to produce this deflection is  $i = e/s$ . In the first adjustment, however, the current  $i' = e/(x + g)$ . Since  $x + g = a$  by the second adjustment, and since in general  $a < s = a + b$ , the current  $i'$  is larger than  $i$  in the ratio  $s/(x + g)$ . To keep the pointer on the scale throughout adjustment, therefore, the e.m.f. to be measured must not exceed the fraction  $(x + g)/s$  of the full-scale deflection. When  $x$  is reduced until it equals  $\frac{1}{2}s - g$  (i.e., when  $a = \frac{1}{2}s$ ) we have  $x + g = \frac{1}{2}s$  so that  $(x + g)/s$  equals  $\frac{1}{2}$ , hence only one-half of the scale e.m.f. can be used for adjusting the resistances. With couple and leads of zero resistance, the maximum e.m.f. for which adjustment can be made is  $g/s$  times the full scale e.m.f. which may or may not be less than one-half of the scale range of the instrument, depending on the characteristics of the individual instrument.

Since the ratio of maximum deflection to actual e.m.f. is  $(x + g)/s$ , the ratio of the half deflection to actual e.m.f. is  $2(x + g)/s$ , and an error in adjustment to the half deflection will appear in the final reading multiplied by this factor, which ranges from 2, where  $x = s - g$ , to  $2g/s$  as a minimum.

A more satisfactory arrangement, which utilizes the full scale, is illustrated by the accompanying illustration. The normal operating

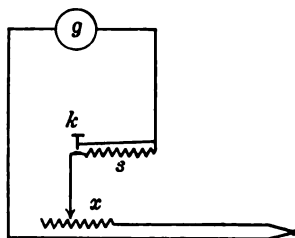

position is with the key  $k$  closed. The current flowing in this case is  $i = e/(x + g)$ . With the key open the resistance  $x$  is adjusted until the deflection is halved; viz.,  $i/2 = e/(x + g + s)$ . Hence  $x + g = s$ , for which resistance the scale of the instrument is graduated. With this arrangement, adjustment can always be made with full-scale e.m.f. Obviously the ratio of deflections may be other than  $\frac{1}{2}$ . In some instances it may be of advantage to use a ratio 0.9, in which case a double scale could be employed, one scale graduated in intervals 0.9 as great as the other scale. Another disadvantage of Mr. Porter's instrument, as described, is that an e.m.f. or linear scale must be employed,

since proper adjustment could not be obtained by halving the deflection on a temperature scale. Furthermore, the instrument must be set to read zero on open circuit, which prohibits the usual cold-junction adjustment. These, and other, objections are successfully met in the instruments described by us in the paper just referred to, and furthermore, high sensitivity in adjustment is assured.

H. F. PORTER (author's reply to discussion\*).—The discussion by Messrs. Foote and Harrison opens with a direct attack on the ethics followed by the writer in describing what they claim is a modification of their own device. Freely admitting that the basic principles of their invention were taken from Dr. Northrup's book and similar standard works of reference, they openly challenge, at the time of their first public announcement of their work, the right of another to describe a device similar in its results to their own. The writer's invention, though possibly it may not have antedated that of Foote and Harrison in its first conception, is in no sense whatsoever an imitation of their device. It was independently conceived and worked out long before the writer had any knowledge of their circuits. Further, it may be remarked that the purpose of this article was not to show in how many ways the "Heatmeter" circuits might be imitated. Such efforts as those put forth in the technical press of a year or so ago, when attempts were made to adequately imitate the Pyrovolter, may well be left to others.

As to the mathematical remarks: A meter is designed to allow for certain definite maximum variation in thermocouple resistance. It is not a matter of the resistance  $X$  by chance being equal to or less than any particular value. It requires but a very superficial examination to disclose the fact that the Heatmeter is capable of operation only in case by chance the resistance of the thermocouple circuit is not over 20 ohms, unless an extremely fragile type of meter is employed. Messrs. Foote and Harrison claim extreme accuracy of setting and adjustment for their meter. It is true they have it, but at the expense of durability. By their own admission, nine-tenths of the current is shunted from the meter (and shunting a meter with so comparatively low a resistance shunt which has a very appreciable contact resistance in the shunting circuit is a rather dangerous procedure from the viewpoint of accuracy), thus requiring, for even base-metal ranges, a fragile and moderately high-resistance type of movement. The whole advantage of the writer's scheme lies in its practical applicability to rugged, durable, practical, reliable, low-resistance, double-pivot type instruments, such as have been very successfully employed in the Pyrovolter. They criticize the difficulties encountered in halving the deflection, which, as the writer explained at the meeting, have been very simply overcome. The circuits were described in their present form for the sake of simplicity in showing the principle.

---

\* Received Dec. 6, 1919.

## Some Factors Affecting the Usefulness of Base-metal Thermocouples

BY O. L. KOWALKE,\* MADISON, WIS.

(Chicago Meeting, September, 1919)

DURING the last few years the use of base-metal thermocouples has increased very considerably in various industries, due to the necessity for more precise control of temperatures. The base-metal couple has the advantages of being robust to a surprising degree, cheap as compared with platinum couples, sufficiently accurate for most operations, rapid in indicating changes in temperature, easily renewed or repaired, and of generating a much higher electromotive force than the noble-metal couples. There are, however, some factors, such as indicating and recording instruments, the insulation on the elements, the constancy and homogeneity of the wires, and the resistance to oxidation in the furnace, that limit the usefulness of the temperature-measuring device. It is the purpose of this paper to discuss in what manner these factors affect the usefulness of the couples.

### MEASURING INSTRUMENTS

There are at present two sorts of measuring instruments in general use, millivoltmeters and potentiometers. The deflection of the millivoltmeter is proportional to the amount of current flowing through the movable coil, and the amount of current flowing in the entire circuit is dependent on the electromotive force generated and the total resistance of the circuit. It is obvious that the resistance of the couple will increase when heated and, for a given temperature, the increase is roughly proportional to the length of couple heated. In view of these changes in resistance, would a low- or high-resistance millivoltmeter give the more accurate readings?

Let  $E$  = electromotive generated by the couple,  $IR$  = volts drop through the millivoltmeter,  $Ir$  = volts drop through couple and the leads to the millivoltmeter; then

$$E = IR + Ir.$$

Assume that the resistance of the millivoltmeter  $R$  is 2 ohms, and that the resistance of the couple and leads  $r$  is 0.01 ohm when 2 in. of the couple is heated to 1000° C., and further that when all of the effective length of the couple is heated to 1000° C. the resistance of couple and leads  $r$  is 0.10 ohm. The total resistance of the circuit may thus increase from 2.01 ohms to 2.10 ohms or 4.4 per cent.; therefore the current flowing is decreased pro-

---

\* Professor of Chemical Engineering, University of Wisconsin.

portionately and consequently the deflection of the millivoltmeter is also decreased. Now assume that the resistance of the millivoltmeter  $R$  is 30 ohms and that the same changes in resistance in the couple and leads  $r$  take place as above. Thus the increase in total resistance of the circuit is from 30.01 ohms to 30.10 ohms or 0.3 per cent.; the current decrease and deflection of the millivoltmeter will be a like amount. Thus, it is clear that a high-resistance millivoltmeter will give readings that are less affected by changes of resistance due to depth of immersion than a low-resistance instrument.

In the potentiometer system, the electromotive force from a standard cell is made to oppose the electromotive force generated by the couple. A galvanometer is placed in the circuit of the thermocouple in such a manner that no deflection is obtained when the electromotive force from the standard cell or its auxiliary just balances that from the thermocouple. Thus, no current flows in the thermocouple circuit when the measurement is made, hence the length of the couple and its resistance due to depth of immersion are immaterial with the potentiometer.

The reliability of the millivoltmeter depends on the permanence of the magnet, the correct adjustment for freedom of movement of the coil carrying the needle, and good electrical contacts in all the wires of the circuit. Unless a calibration is made, there is no way of knowing how much in error a given deflection may be. The reliability of the potentiometer depends on the permanence of the standard cell. When the potentiometer works, it is usually right; when it is not right, it won't work. The millivoltmeter is cheaper than the potentiometer; both are about equally robust. The indicating millivoltmeter can be read without manipulation; the indicating potentiometer must be manipulated for balance. Both types are made recording, but the potentiometer can be attached to more couples than the millivoltmeter.

#### INSULATION OF THE WIRES

Materials such as asbestos twine covered with water glass and also with water glass mixed with fine carborundum, woven-asbestos tubing, porcelain tubing, and fireclay bushings have been used for the electrical insulations of the wires of thermocouples. Obviously, a material used for this purpose should be capable of enduring high temperatures without breaking down, withstand a certain amount of rough handling, and not combine with the thermocouple when hot.

Asbestos twine when wound closely on the wires of the couple and covered with a paint containing sodium silicate makes a fair insulator. The asbestos breaks down, however, when heated to 1000° C. or more for extended periods of time and thus the wires are left bare, and liable to short circuit. In Fig. 1 are shown some pictures of couples wound with asbestos twine and painted with fine carborundum. After using these couples near 1000° C. for some time, it was noticed that the iron wire  $B$

had grown to nearly twice its original diameter and could be broken easily in one's fingers. The iron, asbestos, and carborundum had combined into a friable mass; there was no free iron left. The fracture has a greenish purple color. Iron at high temperatures combines readily with carborundum and thus the couple is destroyed. The woven-asbestos tubing breaks down readily and is not so permanent as the twine wrapped on the wire and painted with sodium silicate.

In Fig. 2 is shown a couple with wires insulated from one another by fireclay bushings 1 in. (25 mm.) long, about  $\frac{3}{8}$  in. (9.5 mm.) outside

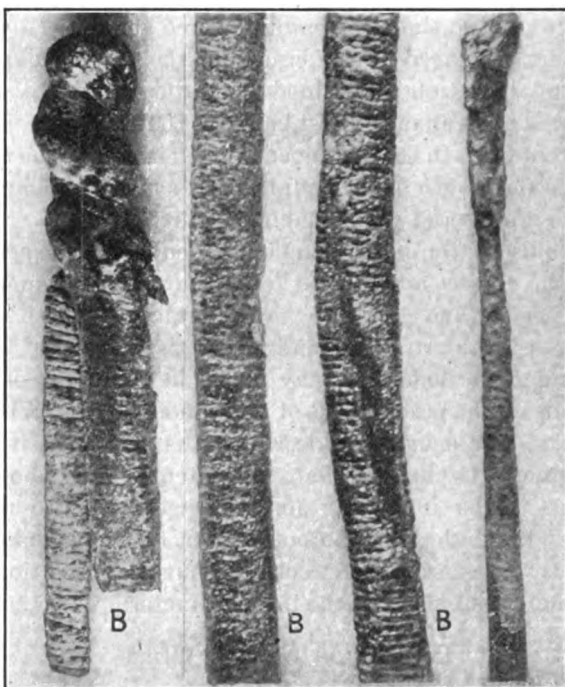

FIG. 1.—COUPLES WOUND WITH ASBESTOS TWINE AND PAINTED WITH FINE CARBORUNDUM.

diameter and  $\frac{3}{16}$  in. (4.7 mm.) bore. These bushings are used by several manufacturers of thermocouples and have been found very satisfactory in this laboratory. In the illustration, a slight fluxing of the oxides on the wire with the bushing is noticeable on the constantan wire which had been raised to 1100° C. On nickel-chromium wires, such fluxing action has not been observed. These bushings have shown good strength under hard use; they are easily replaced when broken and they are cheap.

#### CONSTANCY AND HOMOGENEITY OF COUPLES

Since the voltage generated by a couple for a given temperature is the summation of all the electromotive forces due to the contact of two dis-

similar metal parts, the wires of the couple should be as homogeneous as possible if the electromotive force indicated is that generated at the hot

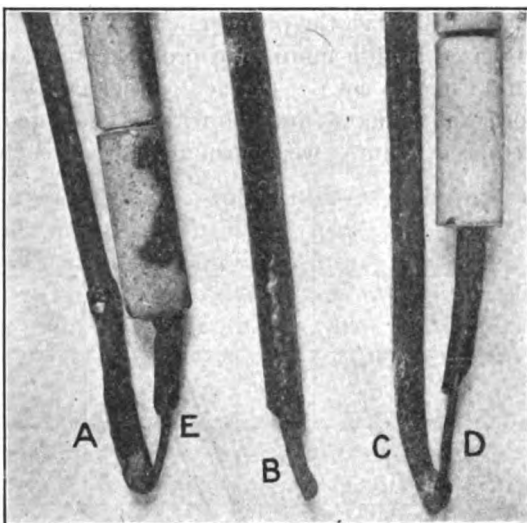

FIG. 2.—COUPLES IN WHICH WIRES ARE INSULATED FROM ONE ANOTHER BY FIRECLAY BUSHINGS.

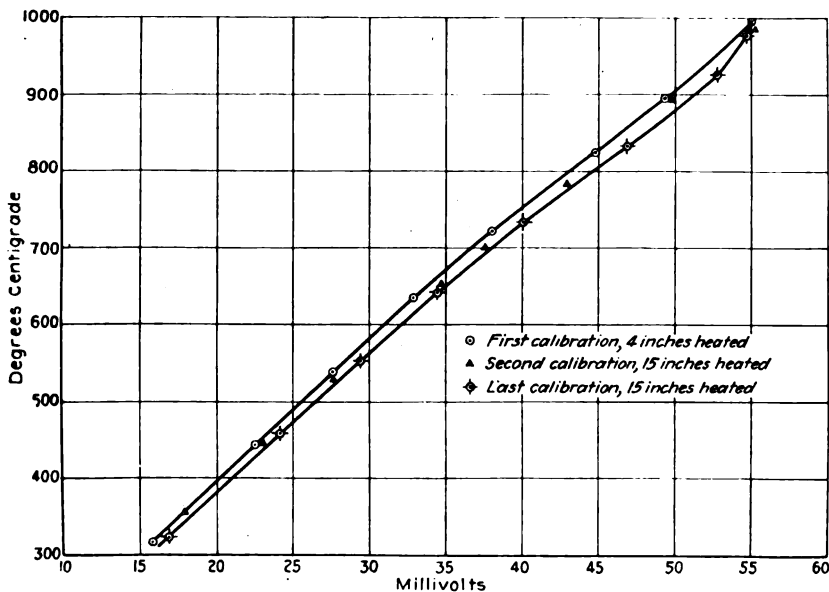

FIG. 3.—CALIBRATION OF COUPLE 20.

junction of the two wires. If the wires are not homogeneous, there will be set up at each junction of dissimilar metals, a voltage that is a function of the temperature at that point. Should the depth of immersion of such a couple be varied, the resultant voltage will change, even though the



temperature remains constant. It was found, after a series of tests<sup>1</sup> made in this laboratory, that there are several couples obtainable that are sufficiently homogeneous for those installations where an accuracy of about 25° to 50° C. will serve the purpose.

Couples purchased from a number of prominent makers were cut to lengths of about 18 in. (45 cm.). To each couple about 3 ft. (0.9 m.) of flexible lamp cord was soldered, and the wires, at soldered joints as well as all other required points, were insulated from each other. The

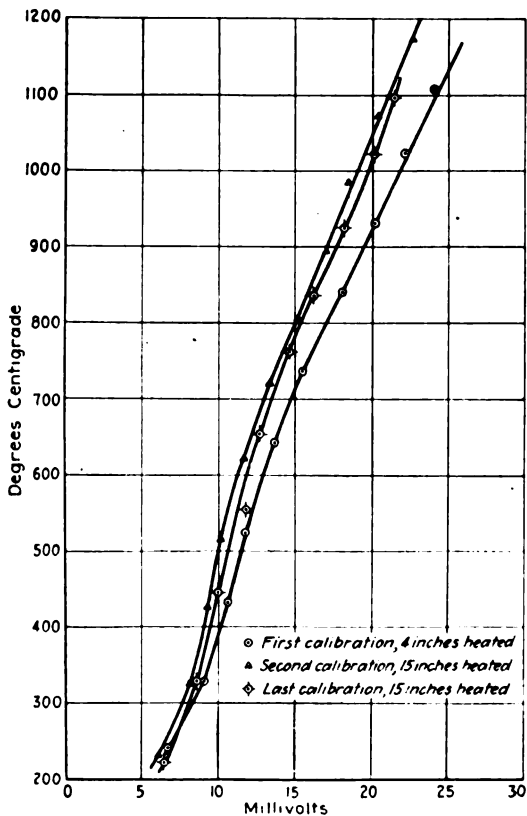

FIG. 4.—CALIBRATION OF COUPLE 18.

couples were then calibrated, one at a time, over the range given by the manufacturer against a standardized platinum couple. First, all couples were calibrated with a length of 4 in. (10 cm.) heated. Second, all couples were calibrated with a length of 15 in. (38 cm.) heated to determine the effect and presence of heterogeneity in the wires. Third, all couples were subjected to a heat treatment for periods of 20 to 24 hr. each at temperatures of 400°, 600°, and 800° C. After the treatment at each of these temperatures each couple was calibrated singly.

<sup>1</sup> Kowalke: *Trans. Am. Electrochem. Soc.* (1913) 24, 377.

Electrically heated tube furnaces were used for all the tests. One furnace was 10 in. (25 cm.) long and the other was 20 in. long, each having a tube about 1 in. bore. These were used for the calibrations at 4 in. and 15 in. depth of immersion, respectively. So that all the couples could be heated together for the treatments at 400°, 600°, and 800° C., a furnace 24 in. long and having a tube 2½ in. bore was used.

Asbestos disks were placed on the base-metal and the standard couples to keep them centered in the furnace. The hot junctions of the two couples were in contact. The temperature was raised to about 300° C. before readings were taken and then the temperature was increased by intervals of 100° C. At each point the temperature was maintained stationary for a period of 2 min. to insure equilibrium. The cold junctions of both couples during calibration were kept at 0° C. by means of an ice bath. All measurements were made on Leeds & Northrup Type K potentiometers, a separate potentiometer being used for each couple.

The data on two of the couples only is presented here to illustrate how near to and how far from being homogeneous and constant the couples were found to be. The composition of the wires of the most satisfactory couple, Couple No. 20, is as follows: *Positive terminal*, Fe, 99.8 per cent.; *Negative terminal*, Cu, 52.3 per cent., Ni, 48.0 per cent.

TABLE 1.—Data on Couples

|                | First Calibration,<br>4 In. Heated |            | Second Calibration,<br>15 In. Heated |            | Last Calibration after Third<br>Heat Treatment at 800° C. |            |
|----------------|------------------------------------|------------|--------------------------------------|------------|---|------------|
|                | Degrees C.                         | Millivolts | Degrees C.                           | Millivolts | Degrees C.  | Millivolts |
| Couple No. 20. | 318                                | 15.70      | 245                                  | 11.99      | 324   | 16.88      |
|                | 445                                | 22.51      | 352                                  | 17.97      | 459   | 24.12      |
|                | 540                                | 27.66      | 441                                  | 22.75      | 553   | 29.40      |
|                | 634                                | 32.99      | 530                                  | 27.62      | 645   | 34.59      |
|                | 721                                | 38.11      | 653                                  | 34.67      | 735   | 40.09      |
|                | 825                                | 44.85      | 700                                  | 37.66      | 835   | 46.93      |
|                | 896                                | 49.41      | 783                                  | 42.85      | 928   | 52.70      |
|                | 997                                | 55.02      | 893                                  | 49.84      | 980   | 54.77      |
|                |                                    | 984        | 55.17                                |            |   |            |
| Couple No. 18. | 240                                | 6.75       | 230                                  | 6.32       | 222   | 6.42       |
|                | 330                                | 9.09       | 325                                  | 8.34       | 330   | 8.61       |
|                | 435                                | 10.66      | 428                                  | 9.49       | 446   | 9.96       |
|                | 525                                | 11.75      | 516                                  | 10.38      | 554   | 11.18      |
|                | 645                                | 13.64      | 621                                  | 11.76      | 655   | 12.61      |
|                | 738                                | 15.49      | 723                                  | 13.43      | 763   | 14.65      |
|                | 843                                | 18.20      | 805                                  | 15.23      | 838   | 16.34      |
|                | 933                                | 20.28      | 895                                  | 17.05      | 927   | 18.25      |
|                | 1026                               | 22.19      | 981                                  | 18.51      | 1025  | 20.08      |
|                | 1109                               | 24.16      | 1072                                 | 20.46      | 1099  | 21.58      |
|                |                                    | 1174       | 22.77                                |            |   |            |

The composition of the wires of the couple found most unsatisfactory, Couple No. 18, is: *Positive terminal*, Fe, 99.9 per cent.; *Negative terminal*, Al, 1.14 per cent., Ni, 98.3 per cent. These data are further shown graphically in Figs. 3 and 4, and Table 1.

It is apparent from the graphs that couple No. 18 shows a difference of 120° C. at 1000° C. between the immersions to 4 in. and 15 in., respectively, and that the variation of electromotive force with temperature is not uniform throughout the range. The lack of agreement of the calibrations with 4 in. and with 15 in. of the couple immersed is apparently due to a lack of proper annealing of the wires for the agreement of the second and the last calibrations is as good as that found on several other couples. It is further apparent from the graphs for couple No. 20 that the variation of electromotive force with temperature is regular throughout the range and that the constancy of the couple is satisfactory. There is a change of only 25° C. in the indications from first to last calibration.

#### RESISTANCE TO OXIDATION

The combination of iron with constantan for couples is one that gives practically a "straight line" for the relation of electromotive force to temperature; it also gives a higher electromotive force at a given temperature than most other combinations of wires; and it is further possible to get these two wires remarkably homogeneous. The great disadvantage of iron is its property of oxidizing rapidly at temperatures above 700° C. If iron were protected against oxidation by some means that would not affect the electromotive force the usefulness of the iron-constantan combination would be greatly extended. It has been shown by W. E. Ruder<sup>2</sup> that "calorizing" iron, "which consists in producing a rich aluminum alloy upon the surface of the metal" practically prevents oxidation below 1000° C.

One of the calorized wires used in these tests was donated by the Research Laboratory of the General Electric Co., the other calorized wire was purchased from the Brown Instrument Co. The uncalorized iron and the constantan wires were purchased from the Leeds & Northrup Co. The iron wires, both calorized and uncalorized, were approximately 0.14 in. (3.5 mm.) diameter. The wire from the General Electric Co. was straight and had a rather thin coating of calorizing; the wire from the Brown Instrument Co. came bent double on itself and the calorized coat was so heavy that some of the alloy chipped off when the wire was straightened.

Three sets of couples were made: Couple No. 10*B*, constantan vs. calorized iron (General Electric Co.), Couple No. 32*B*, constantan vs. calorized iron (Brown Instrument Co.), Couple No. 81*B*, constantan vs. uncalorized iron (Leeds & Northrup Co.). Before making the couples the wires were heated with the electric current to a bright red heat for

<sup>2</sup> *Trans. Am. Electrochem. Soc.* (1915) **27**, 253.

several minutes to remove any strains. The couples made were each 12 in. long. For the hot junction, the wires were fused in the electric arc, then fireclay bushings were strung on the constantan wires, and finally flexible copper lamp cord was soldered to each element.

For calibrating and for heat treatments the same types of furnaces and methods were used as have been previously described. The electromotive force measurements were made on Leeds & Northrup portable potentiometers. The couples were calibrated as annealed, then they were heated for 24 hr. at 200° C. and given a second calibration, then heated again for 24 hr. at 900° C. and calibrated a third time. After

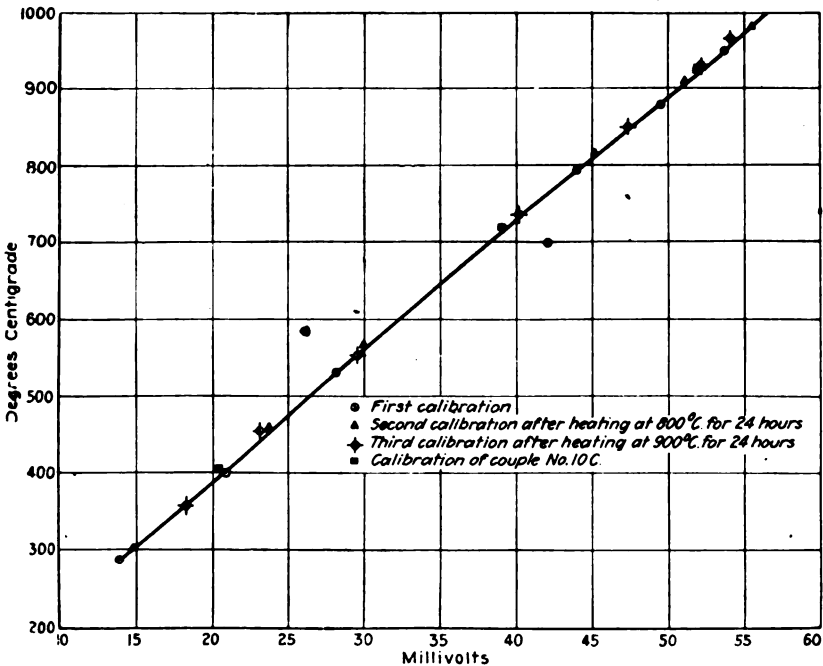

FIG. 5.—CALIBRATION OF COUPLE 10B.

the third calibration, about 1½ in. (3.8 cm.) was cut from the hot junction end of each couple and the remainder fused together again. Thus: Couple 10C was made from Couple 10B, Couple 32C was made from Couple 32B, Couple 81C was made from Couple 81B. The remaining couples were calibrated at only three points to see whether any changes in calibration had taken place due to changes in the wire or method of fusion. The results are shown in Table 2 and Figs. 5, 6, and 7.

As shown in Fig. 2, the constantan wires *E* and *D* and the uncalorized wire *B* have oxidized badly. The calorized wires *A* from the Brown Instrument Co. (couple 32B) and *C* from the General Electric Co. (couple 10B) have not oxidized to any extent upon being given three calibrations and two heat treatments. The wire *C* with the thin coating

USEFULNESS OF BASE-METAL THERMOCOUPLES

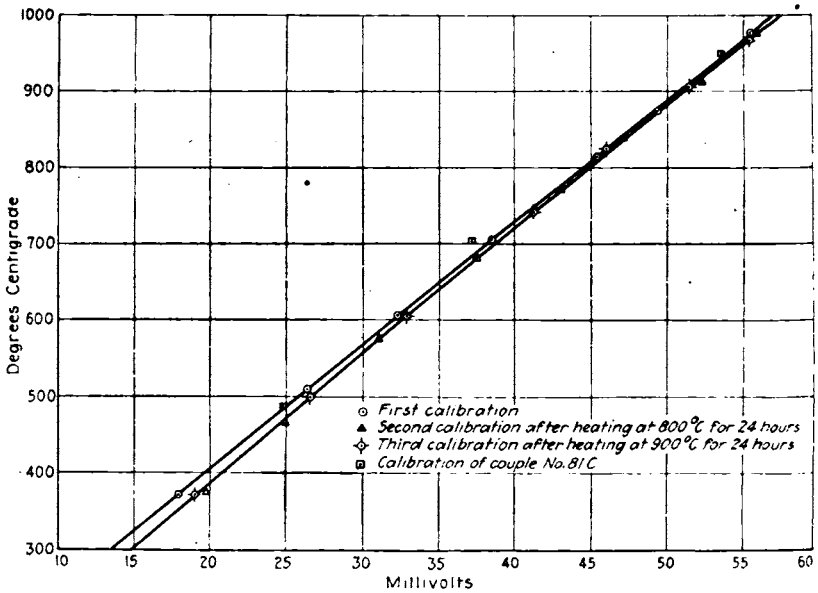

FIG. 6.—CALIBRATION OF COUPLE 81B.

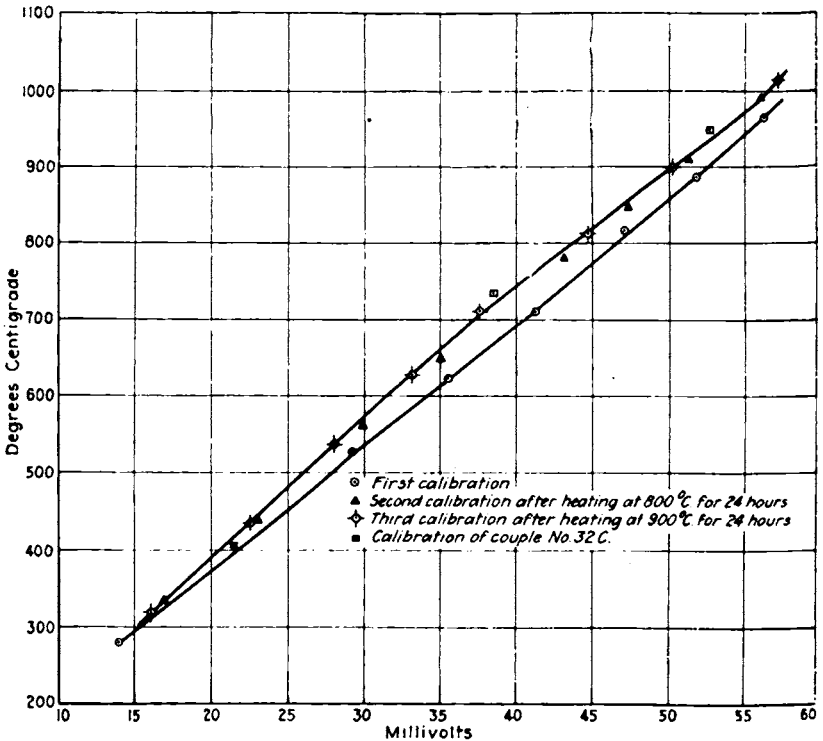

FIG. 7.—CALIBRATION OF COUPLE 32B.

TABLE 2.—Comparisons of Calibrations of Calorized and Uncalorized Iron-Constantan Couples

|                | First Calibration |            | Second Calibration after Heating at 800° C. for 24 Hr. |            | Third Calibration after Heating at 900° C. for 2 Hr. |            |
|----------------|-------------------|------------|--|------------|--|------------|
|                | Degrees C.        | Millivolts | Degrees C.   | Millivolts | Degrees C.   | Millivolts |
| Couple No. 10B | 288               | 14.2       | 301  | 14.8       | 358  | 17.4       |
|                | 400               | 20.9       | 458  | 23.7       | 453  | 23.2       |
|                | 530               | 28.1       | 568  | 30.0       | 553  | 29.1       |
|                | 700               | 42.1       | 815  | 45.2       | 738  | 40.3       |
|                | 795               | 44.0       | 910  | 51.1       | 850  | 47.5       |
|                | 880               | 49.5       | 980  | 55.5       | 929  | 52.4       |
|                | 950               | 53.8       |  |            | 965  | 54.6       |
| Couple No. 81B | 375               | 17.9       | 374  | 19.8       | 371  | 19.0       |
|                | 508               | 26.3       | 466  | 25.0       | 500  | 26.6       |
|                | 605               | 32.3       | 572  | 31.1       | 609  | 32.8       |
|                | 705               | 38.6       | 680  | 37.5       | 742  | 41.3       |
|                | 811               | 45.5       | 769  | 43.0       | 823  | 46.0       |
|                | 874               | 49.3       | 834  | 47.4       | 905  | 51.5       |
|                | 973               | 55.5       | 912  | 52.4       | 977  | 55.5       |
|                |                   | 973        | 55.9   |            |  |            |
| Couple No. 32B | 279               | 13.9       | 333  | 16.8       | 320  | 16.0       |
|                | 529               | 29.3       | 439  | 22.8       | 435  | 22.5       |
|                | 625               | 35.5       | 561  | 29.9       | 537  | 28.0       |
|                | 711               | 41.2       | 650  | 35.0       | 627  | 33.2       |
|                | 818               | 47.2       | 780  | 43.3       | 711  | 37.6       |
|                | 887               | 51.7       | 847  | 47.4       | 812  | 44.9       |
|                | 965               | 56.2       | 910  | 51.4       | 900  | 50.4       |
|                |                   | 990        | 56.2   | 1015       | 57.3   |            |

TABLE 3.—Calibrations of Couples 10C, 32C, 81C.

| No. 10C    |            | No. 32C    |            | No. 81C    |            |
|------------|------------|------------|------------|------------|------------|
| Degrees C. | Millivolts | Degrees C. | Millivolts | Degrees C. | Millivolts |
| 406        | 20.4       | 408        | 21.8       | 485        | 24.9       |
| 720        | 39.1       | 735        | 38.5       | 702        | 37.2       |
| 927        | 52.0       | 949        | 52.9       | 948        | 53.6       |

was in better shape than the wire A with the thick coating, which flaked off and developed oxidized spots. Comparison of Figs. 5 and 6 shows that calorized iron gives the same electromotive force against constantan as the uncalorized iron and that both couples are about equally constant.

Couple No. 32B did not give such good results as Nos. 10B and 81B. The first calibration of No. 32B shows a higher electromotive force for a given temperature than the other couples, but after the heat treatment

at 800° C., couple No. 32B gave a calibration that checked very well with them. This discrepancy is probably due to insufficient annealing at the beginning.

### DISCUSSION

T. R. HARRISON, Washington, D. C. (written discussion\*).—Mr. Kowalke shows that a high-resistance millivoltmeter is subject to smaller errors, due to change in resistance of the thermocouple to which it is attached, than is a low-resistance instrument. He uses as examples instruments having resistances of 30 and 2 ohms, respectively. At the Bureau of Standards, resistances above 300 ohms would be considered high and 30 ohms rather low.

In the tests on calorized-iron thermocouples, a difference between the first and third calibrations of the couples serves to show changes due to the intermediate heat treatment and only under certain conditions would changes in calibrations due to changes in the wire be detected by a recalibration after 1½ in. had been cut from the hot-junction end of the couple and the ends rewelded.

The calibration of a couple depends only on the thermoelectric properties of that part of the couple which lies within the region of non-uniform temperature, *i.e.*, the temperature gradient; hence, so long as the temperature gradient falls along wires of similar thermoelectric properties no change in the electromotive force is produced by altering the metals of those parts of the circuit that are at uniform temperature. Usually at the cold-junction end of the circuit, copper leads, brass binding posts, manganin resistance coils, and various other materials form part of the circuit, but so long as all are at a uniform temperature (or if for each junction between unlike metals there is a similar opposing junction at the same temperature) no resultant thermoelectromotive force will be produced thereby. Likewise, if a length of several inches at the hot-junction end of the couple is at uniform temperature, it matters not if this section is unlike other parts of the couple, so long as there is good metallic connection and no source of e.m.f. other than thermoelectric is present. Cutting off part of the hot end of the couple within such a region of uniform temperature would not alter the e.m.f. of the couple.

Changes in a couple originally homogeneous may be detected by making one calibration with the temperature gradient along a section of the couple that has been subjected to furnace conditions and another with the gradient along a section that has not been exposed to deteriorating conditions. The latter should be the same as the original calibration. If the alteration had taken place while the couple was in use at a given depth of immersion, a calibration in this position would be intermediate between calibrations made as above, since only part of the wires within the temperature gradient would have undergone the maximum change.

\* Received Sept. 25, 1919.

## Tables and Curves for Use in Measuring Temperatures with Thermocouples

BY LEASON H. ADAMS,\* B. S., WASHINGTON, D. C.

(Chicago Meeting, September, 1919)

THE thermocouple as a device for the measurement of temperature is rivaled only by the platinum-resistance thermometer. Both instruments are capable of the highest precision, but the thermocouple, on account of its cheapness, ease of construction, and small cross-section, is finding a continually widening field of usefulness for industrial control as well as for laboratory measurements. Formerly, the thermocouple was subject to two disadvantages: errors due to lack of homogeneity of the metal and the labor involved in the interpolation between fixed points on the temperature scale. Former publications from the Geophysical Laboratory have described the methods<sup>1</sup> for the selection and testing of thermocouple wire and have presented standard calibration curves<sup>2</sup> for platinum-platinrhodium and copper-constantan couples, so that the most important objections to the thermocouple as a precision thermometer have been removed.

The calibration tables published in 1914 covered the range 0–1755° for the platinum-platinrhodium couple and 0–350° for copper-constantan. It has seemed desirable to extend the table for copper-constantan to –200°, and also to include a table for the Hoskins thermocouple. Accordingly, in this paper, the new tables are presented, together with a brief explanation of their use; and, finally, certain diagrams and a paragraph on “cold-junction corrections” are given.

*Standard Calibration Tables.*—In Fig. 1, which illustrates how the electromotive force (e.m.f.) of each of the three couples varies with the temperature, the temperatures of one junction are plotted as abscissas and the corresponding thermo-e.m.f.’s as ordinates. The second junction of the couple is supposed to be at 0°; the curves, therefore, pass through the origin, and the e.m.f. changes sign at this point. The extent of the solid part of each line indicates the useful range (so far as known) of the

\* Physical Chemist, Geophysical Laboratory, Carnegie Institution of Washington.

<sup>1</sup> W. P. White: *Phys. Rev.* (1906) **23**, 449; *Amer. Jnl. Sci.* [4] (1909) **28**, 474; *Jnl. Am. Chem. Soc.* (1914) **36**, 2292; P. D. Foote, T. R. Harrison and C. O. Fairchild: *Met. & Chem. Engng.* (1918) **18**, 343, 403.

<sup>2</sup> R. B. Sosman: *Amer. Jnl. Sci.* [4] (1910) **30**, 7; L. H. Adams and J. Johnston: *Ibid.* [4] (1912) **32**, 534; L. H. Adams: *Jnl. Wash. Acad.* (1913) **3**, 469; *Jnl. Am. Chem. Soc.* (1914) **36**, 65.



MEASURING TEMPERATURES WITH THERMOCOUPLES

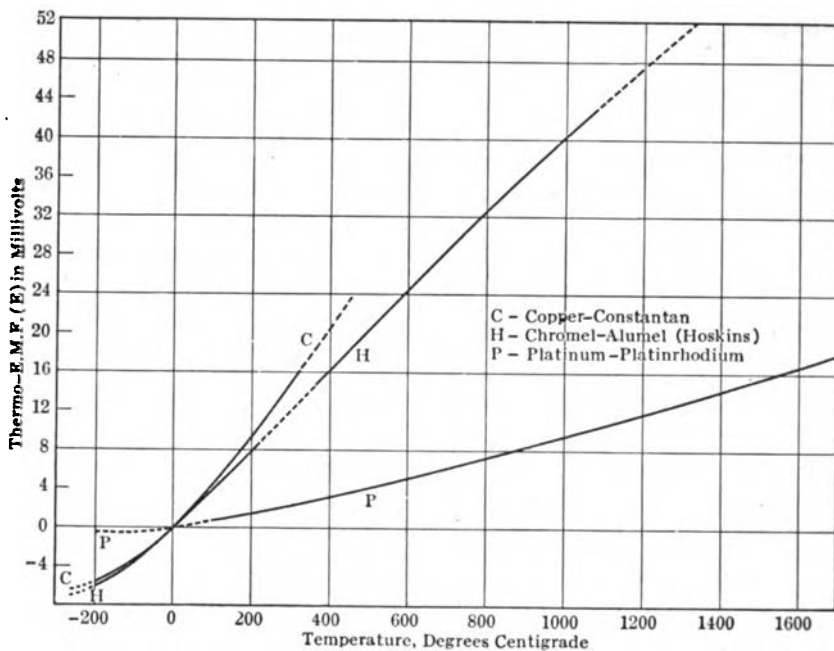

FIG. 1.—VARIATION OF THERMOELECTROMOTIVE FORCE WITH TEMPERATURE. LINES ARE BROKEN IN REGIONS OF TEMPERATURES IN WHICH E.M.F. IS NOT ACCURATELY KNOWN OR IN WHICH THE COUPLES ARE NOT PARTICULARLY SUITABLE FOR TEMPERATURE MEASUREMENT.

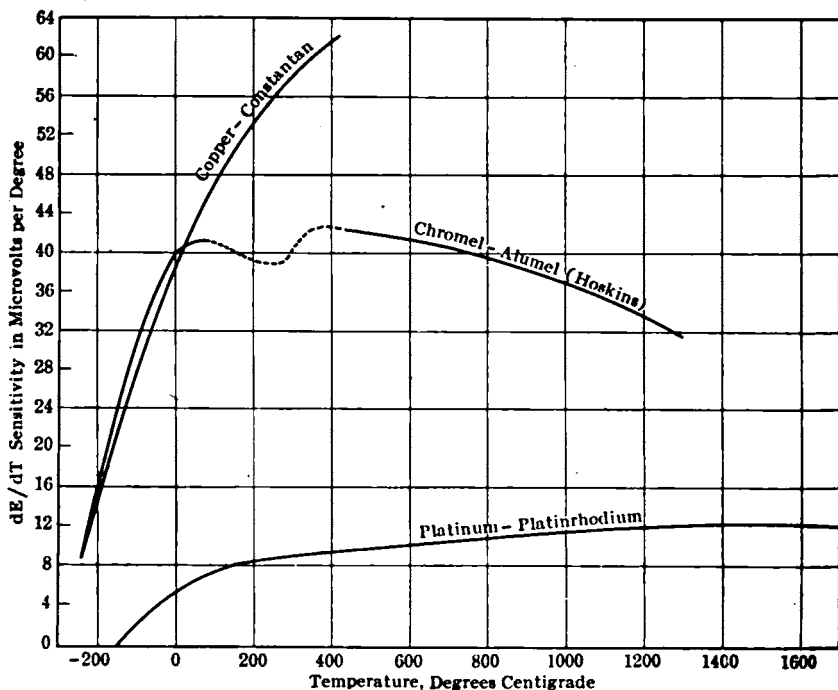

FIG. 2.—SENSITIVITY OF THREE KINDS OF COUPLES AT VARIOUS TEMPERATURES;  $dE/dT$  IN MICROVOLTS PER DEGREE, IS PLOTTED AS A FUNCTION OF TEMPERATURE.

particular couple, while the dotted parts of the lines represent the e.m.f.'s in the region of temperature where the couples deteriorate rapidly or where the temperature-e.m.f. relation is imperfectly known. The sensitivity of the couples at various temperatures is exhibited by the curves in Fig. 2. Here, again, temperature is plotted as abscissas, while the ordinates represent the sensitivity of the respective couples  $dE/dT$ ; or, what is practically the same thing, the number of microvolts for 1° change in temperature.<sup>3</sup>

TABLE 1.—Fixed Points for Use in Thermometry

| Substance             | Transformation | Temperature, Degrees C. | Substance            | Transformation | Temperature, Degrees C. |
|-----------------------|----------------|-------------------------|----------------------|----------------|-------------------------|
| Oxygen.....           | boiling point  | -182.98                 | Sulfur.....          | boiling point  | 444.55                  |
| Carbon bisulfide..... | melting point  | -112.0                  | Antimony.....        | melting point  | 630.0                   |
| Carbon dioxide.....   | boiling point  | -78.5                   | Aluminum.....        | melting point  | 658.7                   |
| Mercury.....          | melting point  | -38.88                  | Silver.....          | melting point  | 960.2                   |
| Water.....            | melting point  | 0.00                    | Gold.....            | melting point  | 1062.6                  |
| Water.....            | boiling point  | 100.00                  | Copper.....          | melting point  | 1082.8                  |
| Naphthalene.....      | boiling point  | 217.95                  | Lithium metasilicate | melting point  | 1201.                   |
| Tin.....              | melting point  | 231.9                   | Diopside.....        | melting point  | 1391.5                  |
| Benzophenone.....     | boiling point  | 305.9                   | Nickel.....          | melting point  | 1452.6                  |
| Cadmium.....          | melting point  | 320.9                   | Palladium.....       | melting point  | 1549.5                  |
| Zinc.....             | melting point  | 419.4                   | Platinum.....        | melting point  | 1755.                   |

The most important fixed points<sup>4</sup> for use in thermometry are given in Table 1. The temperatures given are in degrees centigrade on the thermodynamic scale. The boiling points are for 760 mm. pressure; for other pressures  $p$ , the corresponding temperatures  $T$  may be obtained with sufficient accuracy for small differences of pressure, by use of the correction factor  $A$  in the formula  $T = T_0 + A(p-760)$ . The values of  $A$  are as follows:

| SUBSTANCE           | CORRECTION FACTOR, A | SUBSTANCE         | CORRECTION FACTOR, A |
|---------------------|----------------------|-------------------|----------------------|
| Oxygen.....         | 0.013                | Naphthalene.....  | 0.057                |
| Carbon dioxide..... | 0.016                | Benzophenone..... | 0.063                |
| Water.....          | 0.037                | Sulfur.....       | 0.092                |

*Platinum-platinrhodium Couple.*<sup>5</sup>—Table 2 is the same as the one published previously,<sup>6</sup> and is reproduced here without change.

<sup>3</sup>  $dE/dT$  is sometimes called the thermoelectric power.

<sup>4</sup> In this connection see A. L. Day and R. B. Sosman: *Amer. Jnl. Sci.* [4] (1910) 29, 93; (1912) 33, 517; F. Henning: *Ann. Phys.* (1913) 43, 294; Wilhelm: U. S. Bureau of Standards *Sci. Paper* No. 294.

<sup>5</sup> One wire is of pure platinum, the other is 90 per cent. platinum, 10 per cent. rhodium.

<sup>6</sup> L. H. Adams: *Jnl. Am Chem. Soc.* (1914) 36, 65.

TABLE 2.—Values for Plati

| $E$<br>$\mu v$ | 0                      | 1000                   | 2000                   | 3000                   | 4000                   | 5000                  |
|----------------|------------------------|------------------------|------------------------|------------------------|------------------------|-----------------------|
| 0              | 0                      | 147.1                  | 265.4                  | 374.3                  | 478.1                  | 578.3                 |
| 100            | 17.8<br>17.8<br>16.7   | 159.7<br>159.7<br>12.6 | 276.6<br>276.6<br>11.2 | 384.9<br>384.9<br>10.6 | 488.3<br>488.3<br>10.2 | 588.1<br>588.1<br>9.8 |
| 200            | 34.5<br>34.5<br>16.8   | 172.1<br>172.1<br>12.4 | 287.7<br>287.7<br>11.1 | 395.4<br>395.4<br>10.6 | 498.4<br>498.4<br>10.1 | 597.9<br>597.9<br>9.8 |
| 300            | 50.3<br>50.3<br>16.8   | 184.3<br>184.3<br>12.2 | 298.7<br>298.7<br>11.0 | 405.9<br>405.9<br>10.6 | 508.5<br>508.5<br>10.1 | 607.7<br>607.7<br>9.8 |
| 400            | 65.4<br>65.4<br>16.1   | 196.3<br>196.3<br>12.0 | 309.7<br>309.7<br>11.0 | 416.3<br>416.3<br>10.4 | 518.6<br>518.6<br>10.1 | 617.4<br>617.4<br>9.7 |
| 500            | 80.0<br>80.0<br>14.6   | 208.1<br>208.1<br>11.8 | 320.6<br>320.6<br>10.9 | 426.7<br>426.7<br>10.4 | 528.6<br>528.6<br>10.0 | 627.1<br>627.1<br>9.7 |
| 600            | 94.1<br>94.1<br>14.1   | 219.7<br>219.7<br>11.6 | 331.5<br>331.5<br>10.9 | 437.1<br>437.1<br>10.4 | 538.6<br>538.6<br>10.0 | 636.8<br>636.8<br>9.7 |
| 700            | 107.8<br>107.8<br>13.7 | 231.2<br>231.2<br>11.5 | 342.3<br>342.3<br>10.8 | 447.4<br>447.4<br>10.3 | 548.6<br>548.6<br>9.9  | 646.5<br>646.5<br>9.7 |
| 800            | 121.2<br>121.2<br>13.4 | 242.7<br>242.7<br>11.5 | 353.0<br>353.0<br>10.7 | 457.7<br>457.7<br>10.3 | 558.5<br>558.5<br>9.9  | 656.1<br>656.1<br>9.6 |
| 900            | 134.3<br>134.3<br>13.1 | 254.1<br>254.1<br>11.4 | 363.7<br>363.7<br>10.7 | 467.9<br>467.9<br>10.2 | 568.4<br>568.4<br>9.9  | 665.7<br>665.7<br>9.6 |
| 1000           | 147.1                  | 265.4                  | 374.3                  | 478.1                  | 578.3                  | 675.3                 |

| $E$<br>$\mu v$ | 13,000        | 14,000        | 15,000        | 16,000        | 17,000        | 18,000        |
|----------------|---------------|---------------|---------------|---------------|---------------|---------------|
| 0              | 1289.3        | 1372.4        | 1454.8        | 1537.5        | 1620.         | 1704.3        |
| 100            | 1297.7<br>8.4 | 1380.7<br>8.3 | 1463.0<br>8.2 | 1545.8<br>8.3 | 1629.2<br>8.3 | 1712.6<br>8.3 |
| 200            | 1306.0<br>8.3 | 1389.0<br>8.3 | 1471.2<br>8.2 | 1554.1<br>8.3 | 1637.6<br>8.3 | 1721.0<br>8.4 |
| 300            | 1314.3<br>8.3 | 1397.3<br>8.3 | 1479.4<br>8.2 | 1562.4<br>8.3 | 1645.9<br>8.3 | 1729.3<br>8.3 |
| 400            | 1322.6<br>8.  | 1405.6<br>8.3 | 1487.7<br>8.3 | 1570.8<br>8.4 | 1654.3<br>8.4 | 1737.7<br>8.4 |
| 500            | 1330.9<br>8.3 | 1413.8<br>8.2 | 1496.0<br>8.3 | 1579.1<br>8.3 | 1662.6<br>8.3 | 1746.0<br>8.3 |
| 600            | 1339.2<br>8.3 | 1422.0<br>8.2 | 1504.3<br>8.3 | 1587.5<br>8.4 | 1670.9<br>8.3 | 1754.3<br>8.3 |
| 700            | 1347.5<br>8.3 | 1430.2<br>8.2 | 1512.6<br>8.3 | 1595.8<br>8.3 | 1679.3<br>8.4 |               |
| 800            | 1355.8<br>8.3 | 1438.4<br>8.2 | 1520.9<br>8.3 | 1604.2<br>8.4 | 1687.<br>8.3  |               |
| 900            | 1364.1<br>8.3 | 1446.6<br>8.2 | 1529.2<br>8.3 | 1612.5<br>8.3 | 1696.0<br>8.4 |               |
| 1000           | 1372.4<br>8.3 | 1454.8<br>8.2 | 1537.5<br>8.3 | 1620.9<br>8.4 | 1704.3<br>8.3 |               |

The values of e.m.f. as given lie very close to the mean of the three couples *E*, *F*, and *G* used as standards by Day and Sosman in fixing the high-temperature scale. In this, as in the two succeeding tables, temperatures (on the thermodynamic scale) and temperature differences are given for each 100 microvolts. The last digit in the temperature values in each table is given for purposes of interpolation and for estimating small temperature differences.

*Copper-constantan Couple.*—Table 3 gives the temperature and temperature difference for the copper-constantan thermocouple.

The curve as given represents about the mean e.m.f.'s of constantan<sup>7</sup> wire from various makers. The part of the table lying between 0 and 350° is the same as that previously published,<sup>8</sup> and

<sup>7</sup> Constantan (known also by various trade names such as "Advance," "Ideal," "IAIA," and so forth) contains about 60 per cent. copper and 40 per cent. nickel.

<sup>8</sup> L. H. Adams: *loc. cit.*

*num-Platinrhodium Couple\**

| 6000  | 7000  | 8000  | 9000   | 10,000 | 11,000 | 12,000 |
|-------|-------|-------|--------|--------|--------|--------|
| 675.3 | 769.5 | 861.1 | 950.4  | 1037.3 | 1122.2 | 1205.9 |
| 9.6   | 9.3   | 9.0   | 8.8    | 8.6    | 8.4    | 8.3    |
| 684.8 | 778.8 | 870.1 | 959.2  | 1045.9 | 1130.6 | 1214.2 |
| 9.6   | 9.2   | 9.0   | 8.8    | 8.6    | 8.4    | 8.4    |
| 694.3 | 788.0 | 879.1 | 968.0  | 1054.4 | 1139.0 | 1222.6 |
| 9.6   | 9.2   | 9.0   | 8.7    | 8.5    | 8.4    | 8.3    |
| 703.8 | 797.2 | 888.1 | 976.7  | 1062.9 | 1147.4 | 1230.9 |
| 9.6   | 9.2   | 9.0   | 8.7    | 8.5    | 8.4    | 8.4    |
| 713.3 | 806.4 | 897.1 | 985.4  | 1071.4 | 1155.8 | 1239.3 |
| 9.4   | 9.2   | 9.0   | 8.7    | 8.5    | 8.4    | 8.3    |
| 722.7 | 815.6 | 906.1 | 994.1  | 1079.9 | 1164.2 | 1247.6 |
| 9.4   | 9.1   | 8.9   | 8.7    | 8.5    | 8.3    | 8.3    |
| 732.1 | 824.7 | 915.0 | 1002.8 | 1088.4 | 1172.5 | 1255.9 |
| 9.4   | 9.1   | 8.9   | 8.7    | 8.5    | 8.4    | 8.     |
| 741.5 | 833.8 | 923.9 | 1011.5 | 1096.9 | 1180.9 | 1264.3 |
| 9.4   | 9.1   | 8.9   | 8.6    | 8.5    | 8.3    | 8.3    |
| 750.9 | 842.9 | 932.8 | 1020.1 | 1105.4 | 1189.2 | 1272.6 |
| 9.3   | 9.1   | 8.8   | 8.6    | 8.4    | 8.4    | 8.4    |
| 760.2 | 852.0 | 941.6 | 1028.7 | 1113.8 | 1197.6 | 1281.0 |
| 9.3   | 9.1   | 8.8   | 8.6    | 8.4    | 8.3    | 8.3    |
| 769.5 | 861.1 | 950.4 | 1037.3 | 1122.2 | 1205.9 | 1289.3 |

\*Standard calibration curve for Pt-Pt-Rh (10 per cent. Rh) thermocouple, giving the temperature and temperature differences for every 100 microvolts. Fixed junction is at 0°. For use in conjunction with a deviation curve determined by calibration of the particular couple at some of the following fixed points:

|                                  | Degrees C. | Microvolts $\mu V$ |   | Degrees C. | Microvolts $\mu V$ |
|----------------------------------|------------|--------------------|---|------------|--------------------|
| Water, boiling point.....        | 100.00     | 643                | Silver, melting point.....                            | 960.2      | 9,111              |
| Naphthalene, boiling point.....  | 217.95     | 1,585              | Gold, melting point.....                              | 1,062.6    | 10,296             |
| Tin, melting point.....          | 231.9      | 1,706              | Copper, melting point.....                            | 1,082.8    | 10,534             |
| Benzophenone, boiling point..... | 305.9      | 2,365              | Li <sub>2</sub> SiO <sub>3</sub> , melting point..... | 1,201.     | 11,941             |
| Cadmium, melting point.....      | 320.9      | 2,503              | Diopside, melting point.....                          | 1,391.5    | 14,230             |
| Zinc, melting point.....         | 419.4      | 3,430              | Nickel, melting point.....                            | 1,452.6    | 14,973             |
| Sulfur, boiling point.....       | 444.55     | 3,672              | Palladium, melting point.....                         | 1,549.5    | 16,144             |
| Antimony, melting point.....     | 630.0      | 5,530              | Platinum, melting point.....                          | 1,755.     | 18,608             |
| Aluminum, melting point.....     | 658.7      | 5,827              |   |            |                    |

was calculated from the equation:  $E = 74.672T - 13892 (1 - e^{-0.00261T})$ . The values above 350° were calculated from the same formula and are now added to the table, for the convenience of those who wish to use the copper-constantan couple for rough measurements at the higher temperatures. It should be remembered, however, that this couple, unless made of heavy wire, deteriorates rapidly at temperatures above 300°. The remainder of the table<sup>9</sup> was calculated from the equation:  $E = 92.20T - 29770 (1 - e^{-0.00187T})$ .

The fixed points used were the boiling points of oxygen and carbon dioxide, and the mercury melting point. Between -183° and -220°, the figures in the table were obtained by extrapolation, but since there is no reason for suspecting a sudden change in the slope of the curve in this region, the extrapolation is not violent. The copper-constantan

<sup>9</sup> For temperatures below 0°, interpolations between widely separated fixed points cannot be carried out with the same confidence as for higher temperatures.

TABLE 3.—*Temperatures and Temperature*

| $E$<br>$\mu v$ | -5000                  | -4000                  | -3000                  | -2000                 | -1000                 | -0                    |
|----------------|------------------------|------------------------|------------------------|-----------------------|-----------------------|-----------------------|
| 0              | -189.14<br><i>5.20</i> | -124.46<br><i>4.01</i> | -87.86<br><i>3.42</i>  | -55.81<br><i>3.06</i> | -26.82<br><i>2.79</i> | 0<br><i>2.60</i>      |
| 100            | -174.34<br><i>5.40</i> | -128.47<br><i>4.09</i> | -91.28<br><i>3.46</i>  | -58.86<br><i>3.08</i> | -29.61<br><i>2.81</i> | -2.60<br><i>2.62</i>  |
| 200            | -179.74<br><i>5.64</i> | -132.56<br><i>4.18</i> | -94.74<br><i>3.51</i>  | -61.94<br><i>3.11</i> | -32.42<br><i>2.84</i> | -5.22<br><i>2.63</i>  |
| 300            | -185.38<br><i>5.89</i> | -136.74<br><i>4.28</i> | -98.25<br><i>3.57</i>  | -65.05<br><i>3.15</i> | -35.26<br><i>2.86</i> | -7.85<br><i>2.65</i>  |
| 400            | -191.27<br><i>6.17</i> | -141.02<br><i>4.39</i> | -101.82<br><i>3.63</i> | -68.20<br><i>3.19</i> | -38.12<br><i>2.89</i> | -10.50<br><i>2.67</i> |
| 500            | -197.44<br><i>6.51</i> | -145.41<br><i>4.50</i> | -105.45<br><i>3.68</i> | -71.39<br><i>3.22</i> | -41.01<br><i>2.90</i> | -13.17<br><i>2.69</i> |
| 600            | -203.95<br><i>6.97</i> | -149.91<br><i>4.61</i> | -109.13<br><i>3.74</i> | -74.61<br><i>3.26</i> | -43.91<br><i>2.93</i> | -15.86<br><i>2.71</i> |
| 700            | -210.92<br><i>7.55</i> | -154.52<br><i>4.73</i> | -112.87<br><i>3.80</i> | -77.87<br><i>3.29</i> | -46.84<br><i>2.96</i> | -18.57<br><i>2.73</i> |
| 800            | -218.47                | -159.25<br><i>4.87</i> | -116.67<br><i>3.86</i> | -81.16<br><i>3.33</i> | -49.80<br><i>2.99</i> | -21.30<br><i>2.75</i> |
| 900            |                        | -164.12<br><i>5.02</i> | -120.53<br><i>3.93</i> | -84.49<br><i>3.37</i> | -52.79<br><i>3.02</i> | -24.05<br><i>2.77</i> |
| 1000           |                        | -169.14                | -124.46                | -87.86                | -55.81                | -26.82                |

| $E$<br>$\mu v$ | 7000                  | 8000                  | 9000                  | 10,000                | 11,000                | 12,000                |
|----------------|-----------------------|-----------------------|-----------------------|-----------------------|-----------------------|-----------------------|
| 0              | 155.95<br><i>1.97</i> | 175.50<br><i>1.93</i> | 194.62<br><i>1.89</i> | 213.36<br><i>1.85</i> | 231.74<br><i>1.82</i> | 249.82<br><i>1.79</i> |
| 100            | 157.92<br><i>1.97</i> | 177.43<br><i>1.93</i> | 196.51<br><i>1.89</i> | 215.21<br><i>1.85</i> | 233.56<br><i>1.82</i> | 251.61<br><i>1.79</i> |
| 200            | 159.89<br><i>1.97</i> | 179.36<br><i>1.92</i> | 198.40<br><i>1.88</i> | 217.06<br><i>1.85</i> | 235.38<br><i>1.82</i> | 253.40<br><i>1.78</i> |
| 300            | 161.86<br><i>1.96</i> | 181.28<br><i>1.92</i> | 200.28<br><i>1.88</i> | 218.91<br><i>1.84</i> | 237.20<br><i>1.81</i> | 255.18<br><i>1.78</i> |
| 400            | 163.82<br><i>1.96</i> | 183.20<br><i>1.91</i> | 202.16<br><i>1.88</i> | 220.75<br><i>1.84</i> | 239.01<br><i>1.81</i> | 256.96<br><i>1.78</i> |
| 500            | 165.78<br><i>1.95</i> | 185.11<br><i>1.91</i> | 204.04<br><i>1.87</i> | 222.59<br><i>1.84</i> | 240.82<br><i>1.81</i> | 258.74<br><i>1.78</i> |
| 600            | 167.73<br><i>1.95</i> | 187.02<br><i>1.91</i> | 205.91<br><i>1.87</i> | 224.43<br><i>1.83</i> | 242.63<br><i>1.80</i> | 260.52<br><i>1.77</i> |
| 700            | 169.68<br><i>1.94</i> | 188.93<br><i>1.90</i> | 207.78<br><i>1.86</i> | 226.26<br><i>1.83</i> | 244.43<br><i>1.80</i> | 262.29<br><i>1.77</i> |
| 800            | 171.62<br><i>1.94</i> | 190.83<br><i>1.90</i> | 209.64<br><i>1.86</i> | 228.09<br><i>1.83</i> | 246.23<br><i>1.80</i> | 264.06<br><i>1.77</i> |
| 900            | 173.56<br><i>1.94</i> | 192.73<br><i>1.89</i> | 211.50<br><i>1.86</i> | 229.92<br><i>1.82</i> | 248.03<br><i>1.79</i> | 265.83<br><i>1.77</i> |
| 1000           | 175.50                | 194.62                | 213.36                | 231.74                | 249.82                | 267.60                |

\*Standard calibration curve for copper-constantan thermocouple giving the temperature and temperature differences for every 100 microvolts. Fixed junction is at 0°. For use in conjunction with a deviation curve determined by calibration of the particular couple at some of the following fixed points:

|                                    | Degrees<br>C. | Micro-<br>volts<br>$\mu v$ |                                  | Degrees<br>C. | Micro-<br>volts<br>$\mu v$ |
|------------------------------------|---------------|----------------------------|----------------------------------|---------------|----------------------------|
| Oxygen, boiling point.....         | -182.98       | 5,258                      | Naphthalene, boiling point...    | 217.95        | 10,248                     |
| Carbon dioxide, boiling point..... | - 78.5        | 2,719                      | Tin, melting point.....          | 231.9         | 11,009                     |
| Mercury, melting point.....        | - 38.88       | 1,426                      | Benzophenone, boiling point..... | 305.9         | 15,203                     |
| Water, boiling point.....          | 100.00        | 4,276                      | Cadmium, melting point.....      | 320.9         | 16,083                     |

*Differences for Copper-constantan Thermocouple\**

| 0     | 1000  | 2000  | 3000  | 4000   | 5000   | 6000   |
|-------|-------|-------|-------|--------|--------|--------|
| 0     | 25.27 | 49.20 | 72.08 | 94.07  | 115.31 | 135.91 |
| 2.59  | 27.72 | 51.53 | 74.31 | 96.23  | 117.40 | 137.94 |
| 5.16  | 30.15 | 53.85 | 76.54 | 98.38  | 119.48 | 139.96 |
| 7.72  | 32.57 | 56.16 | 78.76 | 100.52 | 121.56 | 141.98 |
| 10.27 | 34.98 | 58.46 | 80.97 | 102.66 | 123.63 | 143.99 |
| 12.80 | 37.38 | 60.76 | 83.17 | 104.79 | 125.69 | 146.00 |
| 15.32 | 39.77 | 63.04 | 85.37 | 106.91 | 127.75 | 148.00 |
| 17.83 | 42.15 | 65.31 | 87.56 | 109.02 | 129.80 | 150.00 |
| 20.32 | 44.51 | 67.58 | 89.74 | 111.12 | 131.84 | 151.99 |
| 22.80 | 46.86 | 69.83 | 91.91 | 113.22 | 133.88 | 153.97 |
| 25.27 | 49.20 | 72.08 | 94.07 | 115.31 | 135.91 | 155.95 |

| 13,000 | 14,000 | 15,000 | 16,000 | 17,000 | 18,000 | 19,000 |
|--------|--------|--------|--------|--------|--------|--------|
| 267.60 | 285.13 | 302.42 | 319.49 | 336.36 | 353.08 | 369.61 |
| 269.36 | 286.87 | 304.14 | 321.19 | 338.04 | 354.74 | 371.25 |
| 271.12 | 288.61 | 305.85 | 322.88 | 339.72 | 356.40 | 372.89 |
| 272.88 | 290.35 | 307.56 | 324.57 | 341.40 | 358.06 | 374.53 |
| 274.64 | 292.08 | 309.27 | 326.26 | 343.07 | 359.72 | 376.17 |
| 276.40 | 293.81 | 310.98 | 327.95 | 344.74 | 361.37 | 377.80 |
| 278.15 | 295.54 | 312.69 | 329.64 | 346.41 | 363.02 | 379.43 |
| 279.90 | 297.26 | 314.39 | 331.32 | 348.08 | 364.67 | 381.06 |
| 281.65 | 298.98 | 316.09 | 333.00 | 349.75 | 366.32 | 382.69 |
| 283.39 | 300.70 | 317.79 | 334.68 | 351.42 | 367.97 | 384.32 |
| 285.13 | 302.42 | 319.49 | 336.36 | 353.08 | 369.61 | 385.95 |

thermocouple is probably suitable for measuring temperatures as low as 20° absolute (− 253° C.), provided, of course, that an adequate calibration can be obtained.<sup>10</sup>

*Hoskins Couple.*<sup>11</sup>—Table 4 as given represents very closely the observations for a sample of wire drawn down to No. 20 B. & S. (0.032 in. or 0.81 mm.) and then annealed by heating electrically to 600° for a few seconds.

<sup>10</sup> See K. Onnes: *Verslag. Akad. Wetenschappen* (1914) 23, 703.

<sup>11</sup> Of the two wires of this couple, one called "chromel" contains 10 per cent chromium and 90 per cent. nickel, while "alumel," the other wire, contains 2 per cent. aluminum and 98 per cent. nickel.

TABLE 4.—*Temperatures and Temperature Differences for Chromel-alumel Thermocouple\**

| <i>E</i><br><i>mV</i> | - 0     | 0     | 10    | 20    | 30    | 40       |
|-----------------------|---------|-------|-------|-------|-------|----------|
| 0                     | 0.0     | 0.0   | 250.1 | 490.5 | 733.8 | 991.3    |
|                       | 18.7    | 12.6  | 13.0  | 11.9  | 12.5  | 13.5     |
| 0.5                   | - 12.7  | 12.6  | 263.1 | 502.4 | 746.3 | 1004.8   |
|                       | 13.1    | 12.4  | 12.9  | 12.0  | 12.5  | 13.6     |
| 1.0                   | - 25.8  | 25.0  | 276.0 | 514.4 | 758.8 | 1018.4   |
|                       | 13.4    | 12.3  | 12.7  | 12.0  | 12.5  | 13.8     |
| 1.5                   | - 39.2  | 37.3  | 288.7 | 526.4 | 771.3 | 1032.2   |
|                       | 13.8    | 12.2  | 12.6  | 12.0  | 12.6  | 13.8     |
| 2.0                   | - 53.0  | 49.5  | 301.2 | 538.4 | 783.9 | 1046.0   |
|                       | 14.4    | 12.2  | 12.3  | 12.0  | 12.6  | 13.9     |
| 2.5                   | - 67.4  | 61.7  | 313.5 | 550.4 | 796.5 | 1059.9   |
|                       | 15.0    | 12.1  | 12.1  | 12.0  | 12.7  | 14.1     |
| 3.0                   | - 82.4  | 73.8  | 325.6 | 562.4 | 809.2 | 1074.0   |
|                       | 15.8    | 12.1  | 11.9  | 12.1  | 12.7  | 14.1     |
| 3.5                   | - 98.2  | 85.9  | 337.5 | 574.5 | 821.9 | 1088.1   |
|                       | 16.8    | 12.2  | 11.6  | 12.1  | 12.7  | 14.2     |
| 4.0                   | - 115.0 | 98.1  | 349.1 | 586.6 | 834.6 | 1102.3   |
|                       | 18.1    | 12.2  | 11.5  | 12.1  | 12.8  | 14.4     |
| 4.5                   | - 133.1 | 110.3 | 360.6 | 598.7 | 847.4 | 1116.7   |
|                       | 20.1    | 12.4  | 11.5  | 12.1  | 12.8  | 14.5     |
| 5.0                   | - 153.2 | 122.7 | 372.1 | 610.8 | 860.2 | 1131.2   |
|                       | 22.8    | 12.5  | 11.7  | 12.2  | 12.9  | 14.5     |
| 5.5                   | - 176.0 | 135.2 | 383.8 | 623.0 | 873.1 | 1145.7   |
|                       | 28.5    | 12.6  | 11.8  | 12.2  | 12.9  | 14.6     |
| 6.0                   | - 204.5 | 147.8 | 395.6 | 635.2 | 886.0 | 1160.3   |
|                       |         | 12.6  | 11.8  | 12.2  | 13.0  | 14.7     |
| 6.5                   |         | 160.4 | 407.4 | 647.4 | 899.0 | 1175.0   |
|                       |         | 12.7  | 11.8  | 12.3  | 13.0  | 14.8     |
| 7.0                   |         | 173.1 | 419.2 | 659.7 | 912.0 | 1189.8   |
|                       |         | 12.7  | 11.8  | 12.3  | 13.1  | 14.8     |
| 7.5                   |         | 185.8 | 431.0 | 672.0 | 925.1 | 1204.6   |
|                       |         | 12.8  | 11.9  | 12.3  | 13.1  | 15.0     |
| 8.0                   |         | 198.6 | 442.9 | 684.3 | 938.2 | (1220.0) |
|                       |         | 12.8  | 11.9  | 12.3  | 13.2  | 15.0     |
| 8.5                   |         | 211.4 | 454.8 | 696.6 | 951.4 | (1235.0) |
|                       |         | 12.9  | 11.9  | 12.4  | 13.2  | 15.0     |
| 9.0                   |         | 224.3 | 466.7 | 709.0 | 964.6 | (1251.0) |
|                       |         | 12.9  | 11.9  | 12.4  | 13.3  | 15.0     |
| 9.5                   |         | 237.2 | 478.6 | 721.4 | 977.9 | (1267.0) |
|                       |         | 12.9  | 11.9  | 12.4  | 13.4  | 15.0     |
| 10.0                  |         | 250.1 | 490.5 | 733.8 | 991.3 | (1283.0) |

\*Standard calibration curve for chromel-alumel (Hoskins) thermocouple giving the temperature and temperature differences for every 0.5 millivolt. Fixed junction is at 0°. For use in conjunction with a deviation curve determined by calibration of the particular couple at some of the following fixed points:

|                                   | Degrees<br>C. | Milli-<br>volts<br><i>mV</i> |  | Degrees<br>C. | Milli-<br>volts<br><i>mV</i> |
|-----------------------------------|---------------|------------------------------|--|---------------|------------------------------|
| Sulfur, boiling point . . . . .   | 444.5         | 18.07                        | Gold, melting point . . . . .            | 1062.6        | 42.60                        |
| Antimony, melting point . . . . . | 630.0         | 25.79                        | Copper (in air), melting point . . . . . | 1065.0        | 42.68                        |
| Aluminum, melting point . . . . . | 658.7         | 26.96                        | Copper (pure), melting point . . . . .   | 1082.8        | 43.31                        |
| Silver, melting point . . . . .   | 960.2         | 38.83                        |  |               |                              |

The curve of e.m.f. at temperatures above 100° C. is so nearly a straight line that a table representing the calibration data was readily constructed by an adjustment of differences. The remainder of the table was calculated from the equation:  $E = 55.80T - 3465(1 - e^{-0.00467T})$ . Although the values extend beyond 1200°, only couples with wires several millimeters in diameter will last very long at temperatures above 1000°; and even at somewhat lower temperatures the e.m.f. of the couples decreases markedly with use. The only remedy is frequent recalibration. It is evident from the table (and also by inspection of Fig. 2), that at low temperatures the Hoskins couple is slightly more sensitive than the copper-constantan, while at ordinary temperatures  $dE/dT$  is almost exactly the same for the two couples.

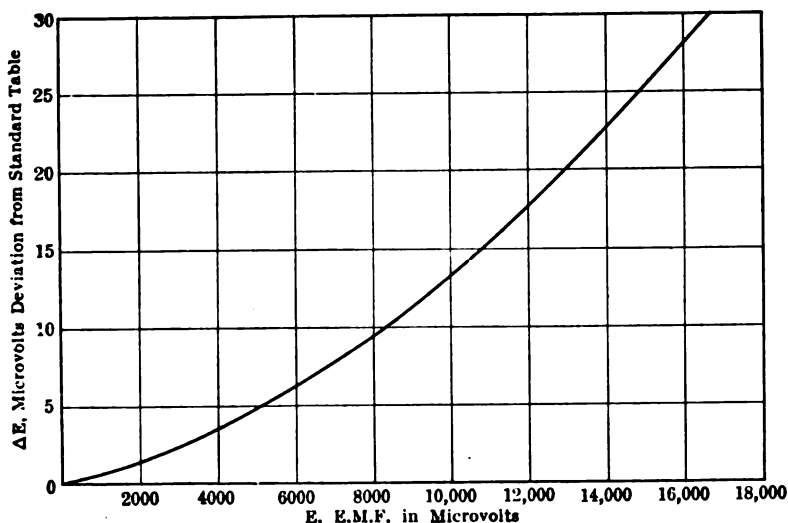

FIG. 3.—TYPICAL DEVIATION CURVE FOR COPPER-CONSTANTAN THERMOCOUPLE, AS DETERMINED BY CALIBRATION OF THE PARTICULAR ELEMENT AT THREE POINTS. THE OBSERVED E.M.F. MINUS THE E.M.F. ACCORDING TO THE STANDARD TABLE IS PLOTTED AGAINST THE OBSERVED E.M.F.

*Deviation Curves.*—Standard tables such as these have no absolute significance; they are merely arbitrary reference curves that, although representing fairly well the temperature e.m.f. functions for certain couples, are intended for use with an appropriate deviation curve. An explanation of this method of procedure has already been given by Sosman<sup>12</sup> and by Adams.<sup>13</sup> The correction curve is determined for each element by calibration at several of the fixed points—preferably three or more—given in Table 1; whence it is simply constructed by plotting

<sup>12</sup> R. B. Sosman: *Amer. Jnl. Sci.*, *loc. cit.*

<sup>13</sup> L. H. Adams: *Jnl. Amer. Chem. Soc.*, *loc. cit.*



$\Delta E$  as ordinate ( $\Delta E = E$  observed minus  $E$  standard) against  $E_{obs.}$  as abscissa, and joining up the various points. Then in order to obtain the temperatures corresponding to the electromotive force indicated by the element, the appropriate value of  $\Delta E$  (as obtained from its deviation curve by inspection) is subtracted algebraically from the observed value of  $E$  before the latter is converted into degrees by means of the table. It is obvious that the required accuracy is secured by plotting the deviation curve on a small scale; a sheet of coordinate paper 20 by 20 cm. is ample. There need be no apprehension of error in the use of this method even with deviations of as much as several hundred microvolts; especially if sufficient calibration points are taken within the specific temperature range, and if the deviation curve so obtained does not depart too far from a straight line.

To illustrate by an actual case: a copper-constantan couple gave at 100°, 217.95°, and 305.9° e.m.f. readings of 4280, 10,262, and 10,529 microvolts respectively. The values of  $\Delta E$  are therefore 4, 14, and 26 microvolts; and when plotted against the corresponding values of  $E_{obs.}$ , yield the deviation curve shown in Fig. 3. Now, suppose that at a certain temperature the couple reads 9112 microvolts. The problem is to find the temperature corresponding to this e.m.f. Referring to the figure, we find that the deviation at 9112 microvolts is 12. Subtracting 12 from 9112 gives 9100 microvolts as the "standard" e.m.f., and from Table 3 it is seen at once that the standard e.m.f. of 9100 corresponds to 196.51°, which is the required temperature. Thermocouples are often connected to instruments provided with scales graduated in degrees. For such cases, these standard tables are of little use except in so far as they may prove useful in the construction of the scales.

*Fixed-junction Correction.*—Thermocouples have (effectively) two junctions. The "business end" of the couple is usually called the hot junction, and the other end the cold junction. This terminology becomes confusing when a couple is used for the measurement of low temperatures, for then the cold junction, although still in an ice bath, for example, is relatively warm compared with the hot junction, which may be immersed in liquid air. It would seem more reasonable to call the two ends of the thermocouple the fixed junction and the variable junction. It may be claimed that the fixed junction may vary and that the variable junction may be temporarily fixed, but it would seem that after all it is an important privilege of the variable junction to vary, and it is the duty of the fixed junction to stay more or less fixed, and that there is no serious danger of confusing the two ends of a couple if they are so named.

The calibration tables are made up on the assumption that the fixed junction is maintained at 0° C., which in the long run is the most convenient and satisfactory procedure. The standard method now is to use a vacuum-jacketed flask filled with ice into which is inserted the

thermocouple junction protected by a glass tube closed at one end and partly filled with kerosene. If it is not feasible to have the fixed junction at  $0^\circ$ , a fixed-junction correction must be applied. This correction, in general, is not equal to the temperature of the fixed junction and depends on both the temperature  $T_0$  of the fixed junction and the temperature  $T$

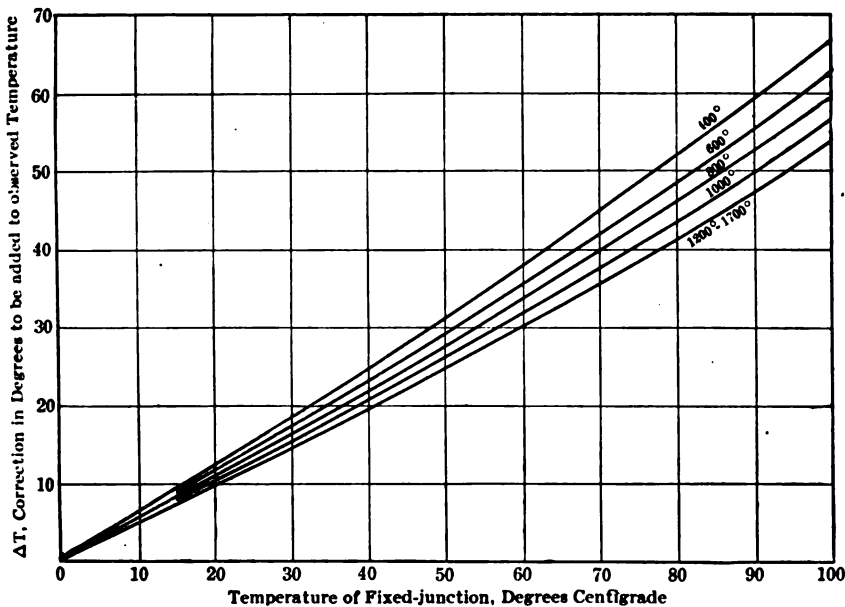

FIG. 4.—CURVES FOR OBTAINING THE FIXED-JUNCTION CORRECTION OF PLATINUM-PLATINRHODIUM THERMOCOUPLES. FOR A GIVEN OBSERVED TEMPERATURE (e.g.,  $400^\circ$ ) CORRECTION TO BE ADDED TO OBSERVED TEMPERATURE IS GIVEN AS FUNCTION OF TEMPERATURE OF FIXED JUNCTION.

of the variable junction. It may be applied by any one of the following three methods.<sup>14</sup>

The e.m.f.<sup>15</sup> corresponding to  $T_0$  may be added<sup>16</sup> directly to the e.m.f.  $E_{T-T_0}$  and the resultant e.m.f.  $E_T$ , converted into degrees by means of the proper table (Tables 2, 3, or 4). Thus if a platinum-platinrhodium couple gives a reading of  $6000\mu v$  (microvolts),  $T_0$  being  $50^\circ$ , the value of  $E_{T_0}$ , according to Table 2, is  $298\mu v$ , which added to 6000 gives 6298 as

<sup>14</sup> C. Offerhaus and E. H. Fischer: *Electrochem. & Met. Ind.* (1908) 6, 362; P. D. Foote: U. S. Bureau of Standards *Bull.* 9 (1913) 553.

<sup>15</sup> Which may be determined from Table 2, 3, or 4, in conjunction, when necessary, with the proper deviation curve, which for the sake of simplicity, we may assume does not deviate from the standard curve.

<sup>16</sup> With a direct-reading instrument this may be accomplished mechanically by changing the zero of the instrument so that when short-circuited it indicates the fixed-junction temperature.

the value of  $E_T$ , which by referring to the table corresponds to  $T = 703.6^\circ$ . This method of correction is mathematically exact.

By another method, which may be more convenient for direct-reading

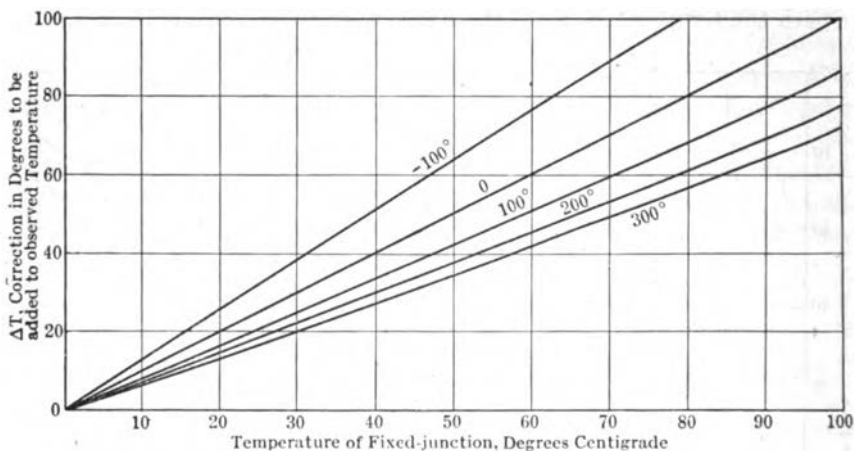

FIG. 5.—SIMILAR TO FIG. 4, BUT FOR A COPPER-CONSTANTAN THERMOCOUPLE.

instruments, the correction is obtained by multiplying the fixed-junction temperature by the factor  $f = (dE/dT)_o / (dE/dT)$ ; *i.e.*, the ratio of the slope of the  $ET$  curve at  $T$  to the mean slope from 0 to  $T_o$ . In other

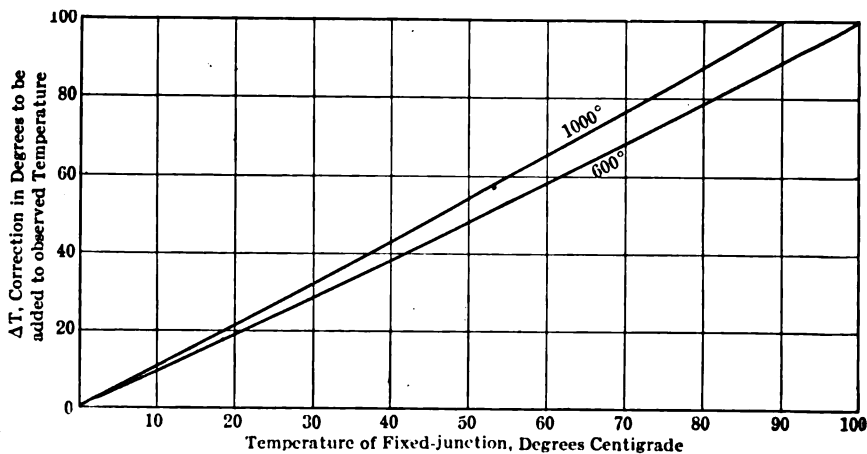

FIG. 6.—SIMILAR TO FIG. 4, BUT FOR A CHROMEL-ALUMEL (HOSKINS) COUPLE.

words, the true temperature  $T$  may be obtained from the expression:  $T = T' + fT_o$ ,  $T'$  being the uncorrected temperature. The slopes of the  $ET$  curves may be obtained by taking the reciprocals of the numbers appearing in the difference columns of Tables 2, 3, and 4. Taking the same

example as given above under (1), the apparent temperature  $T'$  is  $675.3^\circ$  (Table 2). Assuming that  $T$  will be about  $700^\circ$ ,  $(dE/dT) = \frac{1}{0.095} = 10.53\mu\text{v}$  per degree and  $(dE/dT)_0 = \frac{1}{0.1677} = 5.96$ ;  $f$  is, therefore,  $5.96/10.53 = 0.566$ . Then the correction is  $0.566 \times 50 = 28.3^\circ$ , which added to  $675.3^\circ$  gives  $703.6^\circ$  as the true temperature. This method yields results that ordinarily are correct to within a few tenths of a degree.

The third method for fixed-junction correction is a graphical one. By means of the curves shown in Figs. 4, 5, and 6, the correction may be determined by inspection. In these diagrams the corrections to be added to the uncorrected temperatures are plotted as ordinates and the fixed-junction temperatures as abscissas. In each of the three figures, curves are drawn for several temperatures (uncorrected) of the variable junction. As an example of the use of these curves, suppose that the apparent reading of a copper-constantan couple is  $250^\circ$  and that the fixed-junction temperature is  $30^\circ$ . Interpolating between the curves for  $200^\circ$  and  $300^\circ$  in Fig. 5 shows that the correction is  $21^\circ$ . The true temperature is therefore  $250 + 21 = 271^\circ$ .

*Summary and Concluding Remarks.*—Three kinds of thermocouples are extensively used for measuring temperatures.

1. The platinum-platinrhodium couple is the standard for laboratory measurements between  $300^\circ$  and  $1700^\circ$ , and when properly protected it has been successfully employed for commercial work. It is usually free from noticeable inhomogeneities and withstands long exposure to high temperatures without serious deterioration; but it is subject to the disadvantages of relatively low sensitivity and of high initial cost.

2. Copper-constantan forms the most satisfactory combination for use over the range from  $300^\circ$  to minus  $200^\circ$  and below. It is inexpensive, several times more sensitive than platinum-platinrhodium, and both metals are readily obtainable in a fairly homogeneous state and in the form of wires of convenient sizes. Upon exposure in air to temperatures above  $300^\circ$ , both the copper and the constantan gradually oxidize and the e.m.f. of the couple falls off; finally, the wires become brittle and fall to pieces.

3. The Hoskins couple (chromel-alumel) is an important one for industrial installations. Of all the base-metal couples it is the most resistant to oxidation, but at temperatures above a red heat it deteriorates more and more rapidly as the temperature is increased, so that its limit of usefulness does not extend beyond  $1000^\circ$ , except for very heavy wires which may last a short time at temperatures as high as  $1200^\circ$  or  $1300^\circ$ .

The only reliable method for interpreting the e.m.f. of a thermocouple

in terms of temperature requires a calibration at certain fixed points on the temperature scale. For interpolation between these fixed points, much time and labor can be saved by the use of a standard table in conjunction with a deviation curve determined for the particular couple by calibration at several (preferably three or more) temperatures. In this paper such tables are presented for platinum-platinrhodium from  $0^{\circ}$  to  $1750^{\circ}$ , for copper-constantan between minus  $200^{\circ}$  and plus  $400^{\circ}$ , and chromel-alumel (Hoskins) from minus  $200^{\circ}$  to plus  $1200^{\circ}$ . These tables are merely arbitrary reference curves that give temperatures corresponding to a series of true e.m.f.'s, *i.e.*, e.m.f.'s as read by a potentiometer or other compensating device using a galvanometer as a null-instrument,<sup>17</sup> and are to be used only in conjunction with an appropriate deviation curve.

---

<sup>17</sup> Such instruments are much more reliable than the ordinary millivoltmeter with either a temperature or millivolt scale.

## A Reference Standard for Base-metal Thermocouples

BY N. E. BONN,\* B. SC. IN E. E., PHILADELPHIA, PA.

(Chicago Meeting, September, 1919)

It is well known that most of the materials entering into the manufacture of thermocouples are subject to variations in their thermoelectric characteristics, the chief causes of which are: differences in chemical composition; the previous history, which includes mechanical working, aging, oxidation, and contamination; and mode of use, such as depth of immersion, etc.

In the case of a very extensively used thermoelement, the iron-constantan couple, neither iron nor constantan is absolutely uniform, and a number of checks are made during the process of manufacture. As both are subject to diversion from a standard value, neither can be used for checking the other. It is, therefore, necessary to find a third metal against which iron and constantan may be checked. It was to find such a metal, that the present investigation was undertaken.

To be a reliable checking standard, the metal must possess a fairly high melting point, it must be obtainable in sufficient purity, and it must be uniform and constant with respect to its thermoelectric qualities. The choice is, as a result, limited to a few metals, such as copper, gold, and silver.

Copper has the advantage of low cost, which makes it possible to use each wire only once and thus avoid any variations due to continued use, although previous investigators have found<sup>1</sup> that continued use does not affect the calibration of a copper-constantan thermocouple. Copper also has the advantage of a large thermal electromotive force against constantan and would be desirable as a checking standard if it could be shown that it possessed the proper thermoelectric characteristics. The investigation, accordingly, resolved itself into three phases: the uniformity of commercial electrolytic copper, the effect of aging and method of annealing, and the calibration of the copper-constantan thermocouple.

Before describing the experiment, it may be well to mention that all possible precautions were taken to reduce the errors of observation to a minimum. The apparatus used consisted of a hand-regulated vertical electric furnace, a Leeds & Northrup Type K potentiometer, a moving-coil galvanometer of high microvolt sensitivity, and a multiple switch, which made it possible to check simultaneously several pieces of copper against one piece of constantan. Readings were taken only after the furnace was steady for at least 10 min. and only those readings recorded that did not change after three consecutive trials. The cold junction

\* Research Engineer, Leeds & Northrup Co.

<sup>1</sup> U. S. Bureau of Mines *Bull.* 145 (1918).

## 180 A REFERENCE STANDARD FOR BASE-METAL THERMOCOUPLES

was maintained at 0° C. by means of a bath especially constructed for the purpose.

In order to avoid using the same constantan wire all the time, several wires were cut from the same coil and checked against the same piece of copper wire at a temperature of about 1400° F. (760° C.). As no appreciable difference in the resulting electromotive force could be found, these wires were arbitrarily chosen as "standard constantan" and later used in the course of the investigation as such.

The question of uniformity of commercial copper wire involved the testing of many samples coming from widely different sources. Some were obtained from the storerooms of the Leeds & Northrup Co., others came from various makers of copper wire, still others were drawn into wire from different pieces of copper scrap. Wires from fifteen sources, all previously annealed, were tested under exactly the same conditions at 1300° F. (704° C.) against the "standard constantan" mentioned. No differences in the electromotive forces greater than that equivalent to 0.5° F. (0.28° C.) were observed.

The study of the effect of aging presented some difficulty, as wire known to be very old could not be obtained. Artificial aging at higher than room temperatures caused no changes, and it seems to be safe to conclude that the same is true for gradual aging at room temperatures. In any event, wire that was known to have been received from the maker over a year before testing gave the same e.m.f. as new wire. The question, however, is being left open and the affect of aging will be studied at greater length when wire that has been put away for the purpose is tested some time in the future.

In order to determine whether the method of cooling after annealing had any effect on the thermal e.m.f. of copper, three samples were heated to 1500° F. (816° C.) and allowed to cool in various ways. One was plunged directly into cold water, another was permitted to cool in air at room temperature, and the third was cooled over night in the electric furnace. There resulted no appreciable variation in the thermal e.m.f. of the three wires.

The foregoing investigation seems to fully warrant the conclusion that copper is an ideal standard for checking constantan and other base-metal thermoelements, as it can be easily obtained in the electrolytic form, which appears to have the same thermoelectric properties regardless of its origin.

It is stated by a number of authorities that copper is not suitable for pyrometric purposes at even moderately high temperatures. Dr. Burgess would limit its use to 600° C., while Dr. Griffith maintains that 300° C. is the limit for copper. This in no way contradicts our conclusions, since the limits suggested refer only to continuous use, due to oxidation and short life, but for checking purposes, where a wire may be used only once or a very few times, there is no apparent reason why copper could not be used up to 900° Centigrade.

## Alloys Suitable for Thermocouples and Base-metal Thermoelectric Practice

BY J. M. LOHR,\* PH. D., DETROIT, MICH.

(Chicago Meeting, September, 1919)

THE characteristics and uses of thermocouples of platinum and the platinum alloys being so well known, this paper will be confined to base-metal couples. During the past decade, there has developed a strong demand for thermocouples made of metals cheaper than the platinum alloys, and suitable for industrial heat measurements. Much research has been done but only a very limited number of alloys have been found to possess the necessary characteristics for general technical use.

In the development of thermocouple alloys it is necessary to consider the following points: The electromotive force and temperature relations; permanency or constancy; reproducibility; manufacturing difficulties; durability; and accuracy in use.

The electromotive force developed by the thermocouple should increase with the rise of temperature according to some definite law. It is desirable that the electromotive force should vary directly with the temperature difference of its junctions, in other words, giving a curve linear or nearly so. It is also desirable that the resulting electromotive force be as large as possible for any given range of temperature, thereby insuring greater accuracy of readings.

The materials composing the thermocouple must be perfectly homogeneous and must remain so under continued use. When parasitic currents develop in a couple or a couple deteriorates, its usefulness is at once seriously impaired. Everyone who has had any experience in the use of thermocouples knows the extreme vigilance and continual checking and rechecking required to guard against deterioration and parasitic currents. Parasitic currents are probably the most troublesome phase of thermocouple work to deal with. Their real cause is not clear. They seem to be due to several causes, resulting both from the manufacture of the wire and the uses of the couple under different conditions. It is believed that possible segregation and cavities of occluded gas in the casting, as well as the crystal structure due to improper annealing, on the one hand, and the effect of gases and contaminating materials on the outside surface of the couple when in use may be contributing causes.

---

\* Superintendent of Foundry, Hoskins Manufacturing Co.



When the couples of an installation burn out, it is necessary that new elements or couples of the same quality, characteristics, and millivoltage range be available for replacement. This necessitates, on the part of the manufacturer, the ability to reproduce the alloys in quantity at will.

Investigations may develop alloys with all the necessary qualities and characteristics for a satisfactory thermocouple, yet the difficulties of manufacturing them on a production basis may present almost insurmountable difficulties. Doubtless, few users of thermocouples realize fully the infinite pains and care necessary in the production of highly accurate thermocouple wire. Of all the classes and types of alloy work, this probably meets with the widest range of difficulties. The selection of the grades of raw materials going into the alloys, the accuracy of the composition, the methods of melting, deoxidizing, casting, rolling, annealing, and final calibration must be studied and followed to the minutest detail, and any slight variation in any of these steps will very likely cause serious trouble.

The user is interested primarily in the life of the couple he has installed and its continued accuracy during this life. In technical operations, it is highly important that a couple should have a reasonably long life, thereby obviating the necessity and expense of replacements. To be dependable, the results must be absolutely accurate and reliable.

Originally, out of the great number of alloys upon which experiments were made for base-metal couples, one composed of commercial nickel and commercial iron seemed to offer the best possibilities, but certain characteristics of each metal prevented these alloys from giving the accuracy necessary. For instance, as is well known, nickel undergoes a molecular transformation between 446° F. (230° C.) and 734° F. (390° C.) which makes it unsuited for thermoelectric work over this range. However, it may be used from 752° F. (400° C.) to 1652° F. (900° C.). Iron is subject to the development of heavy parasitic currents. To replace the iron element, nickel-chromium, known commercially under the trade name "chromel," was developed. This alloy (10 per cent. Cr) generates the highest negative electromotive force of any alloy suitable for a thermocouple. It proved to be so much superior to iron that a corresponding element to replace nickel had to be developed. A nickel-silicon alloy was tried but later discarded on account of its becoming brittle with use. Pure nickel-aluminum stood up well at high temperatures, but it too had to be discarded on account of its becoming brittle with use at low temperatures; however, nickel-aluminum with some modifications was found to give a perfectly satisfactory element. This alloy is known commercially as "alumel." For lower ranges of temperature, nickel-copper was developed, to be used with nickel-chromium, but in the development of this alloy it was found that increasing the percentage of copper decreased the life of the alloy.

### BASE-METAL COUPLES IN GENERAL USE

At the present time, there are in general use the following base-metal couples: (1) Nickel-chromium (chromel)—nickel-aluminum (alumel) for temperatures up to 2500° F. (1370° C.). (2) Iron—constantan for temperatures up to possibly 1800° F. (982° C.). (3) Nickel—nickel-iron-chromium, for temperatures up to probably 1500° F. (815° C.), but which cannot be produced with sufficient accuracy to warrant extensive use. (4) Nickel-iron-chromium (chromel X)—nickel-copper (copel) for temperatures up to 1000° F. (537° C.).

The possibility of duplicating the exact millivoltage values in the manufacture of chromel, alumel, and copel as well as iron and constantan, has led to a departure from the original methods of manufacturing thermocouples. Coils of the proper class of wire, having a definite standard millivoltage, are now supplied, and couples can be made as needed, without further calibration. This method of supplying thermocouples has found a ready acceptance with the users of such apparatus.

Of the various base-metal thermocouples, the chromel-alumel couples have undoubtedly received the widest use and are generally considered the most accurate and durable. A large motor corporation that has installed these alloys in all of its plants states that it has obtained exceptional results both in accuracy and durability and finds no difficulty in maintaining a system accuracy of better than 15° F. (8° C.), with 95 per cent. of their couples well within 10° F. (5° C.). This is undoubtedly a high degree of accuracy and probably as high as it is possible to obtain commercially with any material. A large plate-glass manufacturer states that in annealing glass at about 2000° F. (1093° C.) chromel-alumel couples give more accurate results than the platinum-platinum-rhodium couple. As to the value of chromel-alumel thermocouples for laboratory work, it might be of interest to mention that a prominent educational institution states that these couples, used unprotected, as is often necessary in research work, are less liable to alteration than the best platinum, over the same range, up to 1472° F. (800° C.).

### THREE MAIN FACTORS IN THERMOELECTRIC PRACTICE

General thermoelectric practice involves mainly three things: Proper protection of the hot end of the couple; proper protection of the cold end of the couple; and proper care of the thermocouple itself.

Owing to the great susceptibility to, and danger of contamination from oxidizing and reducing gases, particularly at high temperatures, all thermocouples should be protected in some manner. The writer will not go into this phase of the subject, as this is to be discussed in another paper in this symposium.

*Methods of Controlling Temperature at Cold End.*—Inasmuch as the pyrometer indicates not the actual temperature of the hot end of the couple but rather the difference in temperature between the cold and hot ends, it is very evident that the temperature at the cold end should be known and kept as constant as possible. Various methods are employed for this purpose. The method chosen depends, of course, on the kind of installation and local conditions, but the main object is to locate the cold end at such a point that it is free from any disturbing source of heat.

The methods used in commercial installations for controlling the temperature at the cold end include:

1. Wells, in which the cold end is located 8 ft. (2.4 m.) or more underground and any distance from the couple.
2. A Thermos bottle placed at some convenient location in the plant and used with the same system of connections as the well.
3. Water and steam jackets in which running water or steam passes around the cold end maintaining a constant temperature.
4. The thermostat cold-end box, which depends on the expansion of a metal strip making an electrical contact, thereby lighting an electric bulb which, in turn, maintains the proper temperature in the box.
5. A device consisting of four resistances connected after the manner of the Wheatstone bridge, with the thermocouple connected in series in one of the four resistances. A copper resistance coil is also connected at the cold end in series with the couple and in the same arm of the bridge as the couple. The resistance is adjusted so that when the cold end is at the temperature for which the meter is set, no current from the battery flows through the meter. When the cold end is heated, the bridge is thrown out of balance enough to compensate for the cold-end error. This involves adjusting a resistance in series with the battery to make the compensation correct. Such adjustment must be done very frequently and is a disadvantage to this method. The adjustment is accomplished by substituting a coil of low-temperature coefficient wire for the couple and compensating coil. Then the resistance in series with the battery is adjusted to make the meter read to a definite mark.
6. An automatic mercury-bulb compensator, consisting of a small glass bulb and capillary tube containing mercury, into which a loop of fine platinum wire dips. This is inserted in the thermoelectric circuit near the cold junction. The mercury expands or contracts under temperature changes, cutting in or out resistance in the circuit. This acts in opposition to the change in electromotive force with temperature at the cold end, so that a balance may be established. But this gives a percentage compensation for an addition error, or in other words, compensates properly at one point, giving too low a compensation at low temperature and over compensates at high temperatures.

7. A method in use where the cold ends can be brought close to the meter, consists of a device composed of a compound strip of two metals having unequal coefficients of expansion, attached to the spring controlling the pointer, so that the reading of the meter is the temperature of the surroundings when no current is flowing.

For portable work, the cold end is, of course, at the meter, in which case a thermometer on the meter is necessary, so that the zero setting may be accurately made.

Of all the systems in use for controlling the temperature of the cold end, the well system probably finds the greatest general use and is considered by many the most satisfactory, although there may be special cases where some one of the other methods could be used with good results. The chief disadvantage of this system is the cost of "lead wires," particularly in a large building where the meter must be placed a long distance from the thermocouple. In such cases, it is undoubtedly much cheaper to use the Thermos bottle, which, all things considered, is probably most satisfactory, next to the well system. In the use of the thermostat cold-end box, the electrical connections may become broken; and with the use of the water and steam jacket, a leak may cause the flow of water or steam to discontinue, in either case affecting the temperature of the cold end to such an extent, possibly, that the product of a large bank of furnaces may be damaged before the operator has had time to notice it. In general, the well system is more applicable to high-resistance equipment, whereas for the low-resistance, providing several couples are to be used with one meter, the cold ends are probably best taken care of by using a water jacket in connection with each one.

#### THERMOCOUPLE EXTENSIONS

This brings up the subject of thermocouple extensions, or "leads" as they are commonly called. Such extensions are principally used with high-resistance installations. They cannot be used for cold-end regulation with low-resistance couples, because the amount of wire required would offer too high resistance. As is well known, the extension wires merely serve the purpose of lengthening out the couple, and may be made of a different alloy from that of the couple, as copper nickel, properly calibrated, or they may consist of the same alloy as that of the couple, but in either case of a much smaller diameter to avoid excessive cost.

Various methods of connecting a series of thermocouples, by means of extension leads through the cold-end well or Thermos bottle to the meter, are in use. The manufacturers of chromel-alumel thermocouples are using four methods with very satisfactory results.

One well or Thermos bottle may be provided for each couple. This method is of advantage where the furnaces are situated over a large

area, because it reduces the amount of extension leads to a minimum, but there is the cost of providing a number of wells or Thermos bottles. With this method, the couple may be of the usual length, with a flexible extension of the same alloy through the well or bottle, and then continued with copper through the switch to the meter.

A second method is to take care of all the thermocouples with one well or Thermos bottle. This method should be used when the furnaces are close together and the meter is located a great distance from them and

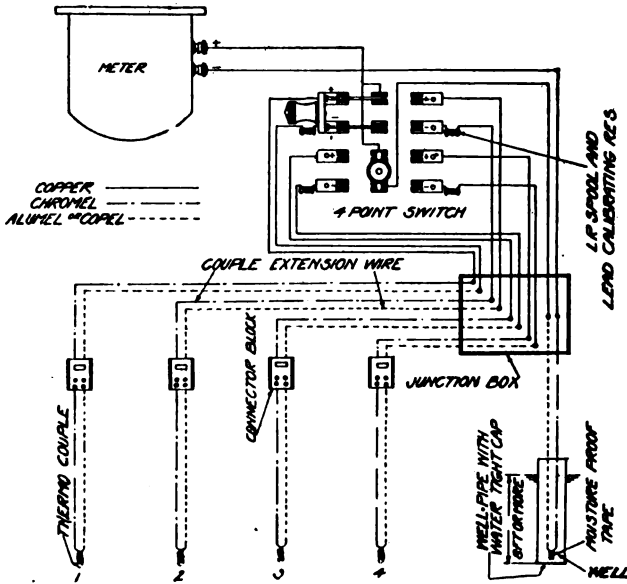

FIG. 1.—WIRING DIAGRAM FOR ONE COUPLE EXTENSION CIRCUIT.

also where it would be impossible to drill individual wells to have the same temperature. In other respects this is identical with the first method.

A third method employs a "common" cold end. Only one couple extension circuit is run into the well to take care of the cold end of all the couples, Fig. 1. All the thermocouple extensions terminate at one point, called a "junction box," insuring the same temperature to all connections within. It will be noted on the diagram that the couples are connected by extension leads to the junction box. Extension leads of the same alloy also connect the junction box to the well, and connections from the junction box through the multipoint switch to the meter are made with copper.

A fourth method, which is very similar to the one just described, is to run the couple extensions to a switch, which takes the place of the junction box, Fig. 2. Only one well is required; this holds the common cold-

end extension. This combination may be used when the meter and switch are located close to the couples and where the furnaces are compactly placed.

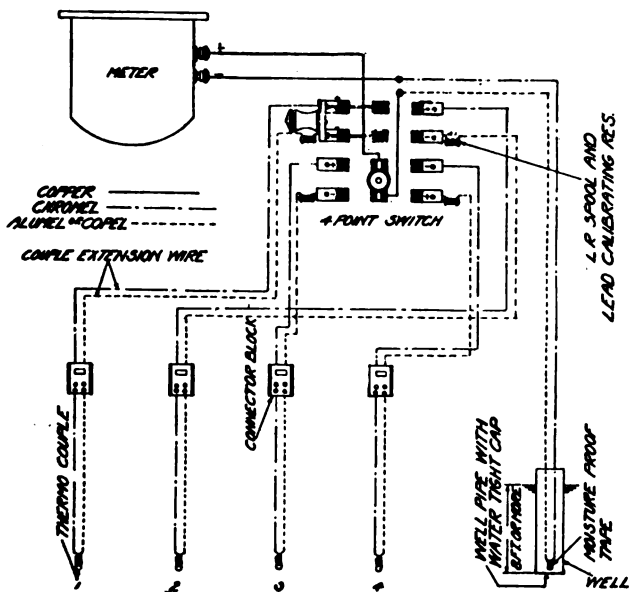

FIG. 2.—INSTALLATION OF ONE WELL; COUPLE EXTENSION WIRES RUN TO SWITCH.

### CARE OF THERMOCOUPLES

The results from base-metal couples, considering the great number in use, have been highly satisfactory; and given equal care with that of the platinum couple, will probably afford the user equal satisfaction on the basis of cost. But in many cases more care should be exercised in the general handling and use of base-metal couples, if one may judge from the appearance of many of those that are returned to the factory for repairs. Covered with dirt and furnace material, they are frequently almost unrecognizable. To obtain the best results, every pyrometer installation should be checked periodically, preferably once a month, and a systematic record should be preserved. The methods to be used, whether by means of a check couple or by the melting points of pure metals, are too well known to need mention here.

## Recent Improvements in Pyrometry

BY R. P. BROWN,\* PHILADELPHIA, PA.

(Chicago Meeting, September, 1919)

To gain some idea of the progress recently made in the measurement of high temperatures, we must review the temperature-measuring devices of the past. As far back as 1782, Wedgewood, a famous potter in England, attempted to measure his kiln temperatures by means of clay trials, or test pieces, that indicated the expansion or contraction that occurred with certain changes in temperature. He also produced cones of clay, formed of various mixes, to form a whole series for the range of temperature met with in firing clay products. These cones are still extensively used to measure kiln temperatures in the pottery industry. Cones are affected not only by time but by temperature and the rate of firing; consequently, they are not an accurate measure of temperature. In addition, it has been common practice for years to attempt to measure temperatures with fusible salts. Capsules of these are inserted in the furnace and indicate, by melting, when a certain temperature has been attained. While such salts cannot be considered a precision form of temperature-measuring device, they have proved reasonably accurate in checking temperature.

### MERCURIAL THERMOMETERS

Mercurial thermometers have been known for years as a standard device for measuring moderate temperatures. The mercurial thermometer for temperatures up to 600° F. (316° C.) was furnished with a vacuum above the mercury column. For temperatures above the boiling points of mercury, 674° F. (356° C.), it is supplied with the mercury column under pressure. If a mercurial thermometer is graduated to 1000° F. (538° C.), there is some 200 lb. gas pressure applied above the mercury column to prevent the mercury boiling. The thermometer manufacturers have shown very little progress, of late, in producing a high-temperature mercurial thermometer. This is apparently due to the fact that glass tubing will soften at temperatures much above 1000° F.; also the pressure necessary to prevent boiling becomes excessive. But it would seem that with the progress being made, these maximum temperatures for a mercury thermometer can be increased by the develop-

---

\* President, The Brown Instrument Co.

ment of glass with a considerably higher softening point and of sufficient strength to apply all the required pressure to prevent boiling of the mercury at a considerably higher temperature than 1000° F. (538° C.).

### EXPANSION PYROMETERS

Mechanical pyrometers operating through the difference in expansion of iron and brass, or iron and graphite, have been manufactured for 75 years. A steel tube containing a rod of graphite extends into the furnace and by multiplying the difference in expansion that takes place and the movement of a pointer across the dial of the instrument, an indication of temperature is secured. Approximately 0.009 in. (0.228 mm.) difference in expansion occurs for every 100° F. (56° C.) rise in temperature to 800° F. (427° C.). This type of pyrometer has always had a tendency to change in its readings with time, particularly if used for temperatures above 800° F., due to constant heating and cooling of the metal tube. This occasions readjustments of the pointer to compensate for this error.

Mechanical pyrometers are today still extensively used for measuring the temperature in bread-baking and core-drying ovens, where accurate temperature measurements are not required, and where a temperature indication within 25° F. plus or minus is satisfactory. By annealing the steel tubes at a considerably higher temperature than they will be subjected to, and for quite a length of time, it has been found possible to partly eliminate the error that would otherwise result, due to constant heating and cooling of the expansion pyrometer. Furthermore, annealing the graphite rods has had a beneficial result. This type of pyrometer cannot be recommended where accurate temperature measurements are required and for use at temperatures above 1200° F. (648° C.).

### GAS THERMOMETERS

The gas or air thermometer, another form of expansive instrument, was a device originally used to determine the true temperature scale; it is only comparatively recently that this type of instrument has been used to any extent to measure temperatures commercially. A good form for industrial use consists of a copper bulb containing nitrogen gas connected to the recording gage by a small-bore capillary tube which is protected by a heavy flexible armored tube. The recording gage contains the usual form of Bourdon spring used in steam gages. When the bulb is heated, the gas expands and the pressure applied along the capillary tube expands the spring in the instrument and causes the pointer to move across the scale or chart. For temperatures of 800° F. (426° C.), approximately 150 lb. (68 kg.) pressure is exerted on the spring for the full scale reading. In consequence, a heavy spring can be used and the instrument is exceedingly robust in construction.



By substituting a bulb of pure nickel for the copper bulb or by applying a heavy deposit of nickel on the outside of the copper bulb, oxidizing may be prevented. By using brazing solders with a melting point of 1600° F. or above, these instruments may be used at temperatures as high as 1500° F. It would seem that considerable progress can be shown in adapting the gas pyrometer for measuring higher temperatures than it has been used for in the past. Heretofore, 1000° F. (538° C.) has been considered the limit of temperature for this type of instrument.

#### RESISTANCE THERMOMETERS

The resistance thermometer is not a new form of temperature-measuring instrument, having been used for some 30 years. Marked progress has been shown during the past few years in adapting this instrument to more satisfactorily meet industrial conditions. The principle on which the resistance thermometer operates is the change in the resistance of a metal due to change in temperature. A platinum or nickel coil, protected by a suitable tube, is inserted at a point where the temperature is to be measured and, with a constant current passing through the coil of wire, the resistance decreases or increases with changes in temperature. This change in resistance can be easily measured, as an adjustable resistance is used to balance the resistance of the bulb and a galvanometer shows when the balance is reached. An adjustable resistance is furnished with a sliding contact arm and temperature scale.

The combining of the instrument in a simple and robust form for installation in a power plant or chemical works naturally adapts this instrument better to meet industrial conditions than the laboratory type of instrument formerly used. Furthermore, by using the instrument with suitable resistance, a resistance thermometer is now supplied for use on 110- or 220-volt direct-current lighting circuits where storage batteries or dry cells are not desirable. Through experimenting with nickel alloys, it has been possible to utilize a nickel-alloy bulb for temperatures as high as 800° F. (422° C.) with very satisfactory results. For temperatures above 300° F. (148° C.) it was formerly considered necessary to use a platinum bulb.

It is not generally recognized that a resistance thermometer is an exceptionally desirable instrument for measuring low temperatures, and there are numerous application for sthis instrument in many industries. Twenty-five or more drying rooms, cold-storage rooms, etc., can be easily connected up to one central resistance thermometer.

#### THERMOELECTRIC PYROMETERS

It is safe to say that by far the majority of all the pyrometers in use today for measuring temperatures above 1000° F. operate on the thermoelectric principle. A thermoelectric pyrometer consists of a thermo-

couple and a measuring device and wires joining the thermocouple and the measuring device. Any two pieces of wire of dissimilar materials, for instance one wire of copper and one of iron with one end twisted or welded together, will generate a small current of electricity if the junction is heated. The current produced is very small. Wires of precious metals, used for high-temperature measurements, for example one wire of pure platinum and one of 90 per cent. platinum and 10 per cent. rhodium, generate only 0.01 volt or 10 millivolts, at a temperature of 2000° F. Wires of base metals, for instance one wire of pure iron and one of a copper-nickel alloy known as constantan, produce five times the millivoltage of the platinum thermocouple. Notable progress has been made in the development of base-metal thermocouples for use up to 2000° F. (1093° C.). For higher temperatures platinum-rhodium thermocouples, as used for some 20 or 30 years, are still used.

*Platinum-rhodium Thermocouples.*—Platinum-rhodium thermocouples are usually furnished with a wire 0.02 in. (0.5 mm.) in diameter, but this diameter is increased or decreased to suit the requirements. The platinum thermocouples are ordinarily protected with a tube of either porcelain or silica, depending on the conditions. A silica or quartz tube is preferable where the instrument must be portable and subjected to rapid changes in temperature. Where installed permanently, the platinum-rhodium thermocouple should be protected by a glazed porcelain tube, suitable to withstand high temperatures without softening. It is advantageous to protect the porcelain tube with an extra tube of a refractory material called Durax, with tubes of firebrick, graphite, or some other suitable material. These extra tubes protect the porcelain tubes from sudden changes in temperature or from mechanical injury or breakage. The platinum-rhodium thermocouples are absolutely reproducible, that is platinum-rhodium thermocouples can be bought with a pyrometer equipment today and 5 years hence additional thermocouples can be ordered that will accurately reproduce the values of the present thermocouples.

*Base-metal Thermocouples.*—For temperatures up to 1200° F., a very satisfactory thermocouple consists of one wire of iron and one of constantan. For temperatures above this and as high as 2000° F. (1093° C.) a nickel-chromium thermocouple has proved most satisfactory—one wire consisting of 90 per cent. nickel and 10 per cent. chromium, and the other wire of 98 per cent. nickel and the balance aluminum, silicon, and manganese. Experiments in calorizing base-metal thermocouple wire to increase its life at high temperatures have not been productive of very satisfactory results and experiments do not indicate that calorizing is desirable but it is possible to increase the life of the base-metal thermocouples materially by suitable protecting tubes.

Base-metal thermocouple wires can be secured in all diameters running from 0.01 in. (0.25 mm.) up to 0.25 in. (6.3 mm.). Certain tests require thermocouple wires of exceedingly small diameter to secure sensitiveness and quick reading. For permanent service the heavier wires will increase the life, particularly where the thermocouple is subjected to constant service at temperatures as high as 1600° or 1800° F. (870° or 982° C.). Without doubt a heavy wire thermocouple increases the lag in the reading, but this is not noticeable in large heat-treating furnaces.

If several base-metal thermocouples, for example, one wire of iron and one of constantan, are made up and later additional coils of the same wire are procured to reproduce these thermocouples, the various thermocouples may vary as much as 50° F. (28° C.) at a temperature of 1400° F. (760° C.). In the case of thermocouples of nickel-chromium wire the variation may be as much as 30° F. (16° C.) plus or minus, depending on the particular coils from which the wire was cut. In order to overcome this variation, all the available wire should be taken and a certain part that will reproduce the standard values within 5° F. plus or minus secured. The balance of the wire can be used as shunted thermocouples.

The shunted thermocouple is the most satisfactory where a customer is using thermocouples of the same length and where the insertion inside the furnace is between 2 and 12 in. (5 and 30 cm.) in each instance. In shunting the thermocouples, the millivoltage is reduced approximately 2 millivolts; if the millivoltage falls, this thermocouple can be restandardized at any time by readjusting the shunt. With the unshunted thermocouple, it is necessary to cut down the length of the thermocouple, or it must be junked. Individual conditions determine which type of thermocouple should be used; without doubt there are places where the shunted couple is preferable. The unshunted thermocouple should be used where various lengths of thermocouples are required and where thermocouples will in certain instances be inserted over 12 in. inside the furnace.

The progress shown recently in the manufacture of base-metal thermocouples has been largely in the ability to standardize thermocouples by a shunt for certain requirements or to furnish wire of unusual accuracy for unshunted thermocouples.

*Protecting Tubes for Base-metal Thermocouples.*—Marked progress has been made in the past few years in the development of suitable protecting tubes for increasing the life of a base-metal thermocouple. It is true that a base-metal thermocouple of nickel-chromium wire can be used in an electric furnace at temperatures of 1400° to 1600° F. satisfactorily for long periods of time without deterioration; but where it is necessary to install the thermocouple in a furnace where gases are prevalent or where chemicals or acids exist, a suitable protecting tube must be used.

Where the base-metal thermocouple will not be subjected to temperatures above 1200° F. (648° C.), an ordinary wrought-iron protecting tube gives very satisfactory results. If the temperatures will run as high as 1500° F. (816° C.), the life of a wrought-iron protecting tube can be materially increased by calorizing the pipe. This is a process, developed by the General Electric Co., which impregnates the pipe with an aluminum oxide. Our experiments show that calorizing wrought-iron pipe will increase the life two or three times at temperatures up to 1500° F. (816° C.).

Tubes of nickel-chromium alloy, either 80 per cent. nickel or 20 per cent. chromium, or a nickel-chromium-iron alloy with approximately 25 per cent. iron added will give most satisfactory service in heat-treating furnaces at temperatures up to 1700° F. (927° C.). In the manufacture of nickel-chromium tubes, it has been difficult to prevent sand holes or leaky tubes and every tube should be carefully tested under pressure against leaks to insure a tight tube. If a nichrome tube leaks, it would be far better to use an ordinary wrought-iron tube.

One of the most difficult problems was to secure a satisfactory tube for use in galvanizing baths—molten zinc, lead, and aluminum—and it has only been within the last few months that a satisfactory tube for this service has been developed. This tube is known as "resisteat." At a certain plant in Philadelphia, it seemed impossible to make a tube last over about 2 weeks, but a resisteat tube was in use for 3 months; then the thermocouple had to be removed for repairs, not because the resisteat tube was destroyed, but because the wrought-iron pipe above the resisteat tube had been broken off. This resisteat tube originally had a wall thickness of  $\frac{5}{16}$  in. (7.9 mm.), and when cut apart after use for 3 months had a wall thickness of full  $\frac{3}{16}$  in. (4.7 mm.) and was perfectly tight.

Base-metal thermocouples can be used in ceramic kilns and in severe conditions where temperatures will occasionally attain 2200° F. (1204° C.) by protecting a nickel-chromium thermocouple with a gas-tight porcelain tube and, in turn, protecting this with an extra refractory tube. It is true that if the thermocouple was subjected to such severe temperatures constantly, satisfactory life would not be secured, but in the ceramic kiln the maximum temperature is attained for not more than 24 hr. in probably every 2 weeks, and for this service the thermocouple described gives very satisfactory results.

Thermocouples of iron and constantan wire, which are very successfully used for moderate temperatures, are frequently supplied in a protecting tube packed with carbon or other powdered substances, which will exclude gases. This increases the life of an iron-constantan thermocouple but this construction is very undesirable for a nickel-chromium thermocouple, as greater life for the latter is secured by circulation of air

than by excluding air entirely. In other words, an iron-constantan thermocouple is most satisfactory when used in a reducing atmosphere, whereas a nickel-chromium thermocouple is best under oxidizing conditions. The subject of protecting tubes for base-metal thermocouples has been considered at considerable length, because the user of a pyrometer generally finds that the only real difficulty is to maintain the thermocouple in good condition.

*Insulation of Wires of Base-metal Thermocouples.*—The original insulation used on a base-metal thermocouple was asbestos string or tubing painted with a solution of carborundum, fire sand, and sodium silicate (water glass), mixed to a paste. This insulation rapidly disintegrates and should not be used for temperatures above 1000° F. (540° C.). The most suitable form of insulator is a porcelain bead or tube, which is not affected by temperatures up to the limit of a base-metal thermocouple; this is the form that has been generally adopted.

*Cold-junction Compensation.*—It is one of the properties of a thermocouple that the voltage it generates is dependent on the temperature of the hot junction, which is placed in the furnace, and the cold junction, which is the point at which the alloy wires of the thermocouple join the copper leads to the instrument. It is, therefore, particularly important that the cold junction of the thermocouple be maintained at a uniform temperature, for if a base-metal thermocouple is in use and its cold junction is heated 10°, the decreased voltage generated by the thermocouple will cause the instrument to read approximately 10° low. If the cold-junction temperature decreases, the pyrometer will read high to approximately the same extent.

Until recently, no methods were adopted to take care of this source of error at the cold junction of the thermocouple. In recent years, however, it has been customary to run compensating leads of the same material as the thermocouple to a distant point where the temperature is uniform, instead of having the cold junction just beside the furnace wall, where it might vary several hundred degrees. These compensating leads, in duplex form, can be run into a pipe driven in the ground 10 or 15 ft. (3 or 4.5 m.) where the temperature will remain constant within 5° winter or summer, see Fig. 1. From my experience, I consider this is the best method to secure a constant cold-junction temperature, as it only takes a few hours to drive into the ground a piece of pipe pointed at the lower end and when once installed the cold-junction question is settled. It has been common practice, in past years, to maintain the cold junction at as nearly a constant temperature as possible by running water around the cold junction; this maintains the temperature at that of running water, but unfortunately this may vary at least 20 or 30° from winter to summer. This method has been very largely abandoned of late.

Where it is impossible to place the cold junction in the ground on account of the furnaces being on an upper floor of the building, or for other reasons, a compensating box can be used in the form of a calo-

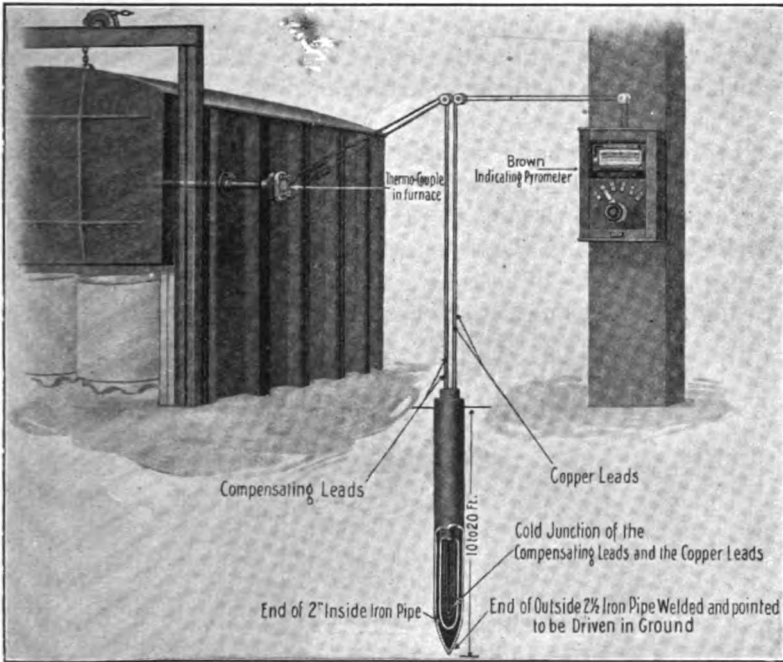

FIG. 1.—COLD JUNCTION INSTALLED IN GROUND.

rimeter, which will maintain the temperature constant within 2° at all times. The common form of compensating box shown in Fig. 2 consists



FIG. 2.—COLD-JUNCTION COMPENSATING BOX.

of a lamp and thermostat which opens and closes a circuit to the lamp as the thermostatic metal expands and contracts, and control within 2° F. is quite possible.

Millivoltmeter and potentiometer pyrometers can be also supplied with automatic means in the meter to compensate for changes in temperature of the cold junction, provided the compensating leads are brought to the instrument. With this type of meter, either hand adjustment can be made at the meter for the temperature surrounding the meter and cold junction, or the instrument can be designed to compensate automatically. No matter what the type of pyrometer, the instrument should be adjusted properly for the actual temperature of the cold junction of the thermocouple. Improved instruments are equipped with a zero adjuster to permit of adjusting the pointer for the actual cold junction temperature.

*Millivoltmeter Method of Measuring Thermocouple Voltage.*—There are two distinct methods of measuring the voltage produced by a thermocouple, that is, the millivoltmeter and the potentiometer methods.

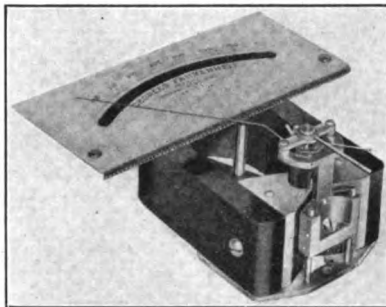

FIG. 3.—MILLIVOLTMETER FOR MEASURING THERMOELECTRIC VOLTAGE.

The millivoltmeter, shown in Fig. 3, consists of a permanent horseshoe magnet with its pole pieces, in the field of which a copper wound coil swings in jeweled bearings. Millivoltmeters have been in extensive commercial use abroad, and to some extent in this country for 20 or 30 years, but the instruments were of such delicate construction as to be really unsuitable for general commercial use. The instruments were supplied with a moving coil hung between fine-wire suspensions, which are easily broken through jars or handling in transit. On account of this delicate construction, some 10 years ago, a standard form of switch-board millivoltmeter was adopted extensively in this country. This is the same instrument commonly used with a shunt, as an ammeter. The instrument had a resistance from 2 to 5 ohms and each individual instrument had to be calibrated for a thermocouple of a certain length for use with leads or wiring of a definite length. Slight changes in resistance due to changes in the length of the thermocouple or the length of the wiring materially affected the indications of the instruments as the internal resistance of the millivoltmeter was so low. Serious errors

occurred also, due to atmospheric changes in temperature along the wiring, which naturally affected the resistance of the circuit. Actual tests show that with a low-resistance millivoltmeter of 5 ohms resistance, an atmospheric change in temperature from 50 to 100° F. along 50 ft. of wiring from the thermocouple to the instrument will make the millivoltmeter read 18° low at 1200° F. It was naturally impossible to procure great accuracy with such an instrument.

In the last 5 or 6 years, great progress has been made in the development of a high-resistance millivoltmeter that for all practical purposes overcomes this trouble entirely. The moving element is shown in Fig. 4. High-resistance pyrometers are produced today with a copper-wound moving element having a resistance of 15 ohms per millivolt. A

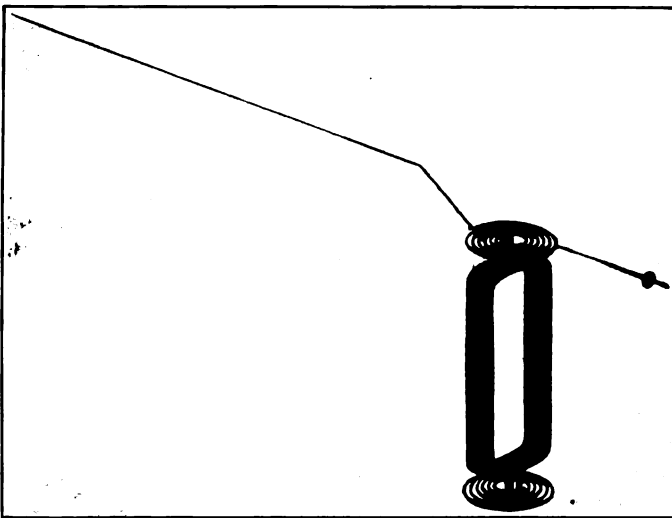

FIG. 4.—MOVING ELEMENT OF BROWN HIGH-RESISTANCE MILLIVOLTMETER.

platinum thermocouple produces approximately 20 millivolts at a temperature of 3000° F., the usual maximum of the scale, and such an instrument in consequence has an internal resistance of 300 ohms. This same type of high-resistance millivoltmeter used with a nickel-chromium base-metal thermocouple producing approximately 40 millivolts at 2000° F. will have an internal resistance of 600 ohms.

By the use of a special form of aluminum-alloy-wound movable element, wound with wire 0.003 in. in diameter the number of ampere-turns can be increased 25 per cent. or more, and the weight of the coil reduced. Consequently, using the same springs, magnets, etc., we obtain a considerable increase in sensitivity over the copper-wound movable element. But, reducing the weight permits the use of lighter springs. Therefore the internal resistance can be still further increased



so that it is possible to increase the instrument resistance to 30 ohms per millivolt. A millivoltmeter graduated to  $3000^{\circ}$  for a platinum thermocouple will have 600 ohms internal resistance, or for a nickel-chromium base-metal thermocouple graduated to  $2000^{\circ}$  will have 1200 ohms resistance. Such an internal resistance eliminates entirely all errors due to line resistance, length of thermocouple, or atmospheric changes in temperature along the leads.

It has been stated that an atmospheric change in temperature of  $50^{\circ}$  F. along 50 ft. of wiring would make a low-resistance pyrometer read  $18^{\circ}$  low at  $1200^{\circ}$  F. This low-resistance pyrometer had a resistance of 5 ohms. Comparing this resistance with 600 ohms, for the average high-resistance instrument, gives a ratio of 1 to 120. If the previous error was  $18^{\circ}$  F., it would be reduced to  $0.1^{\circ}$ .

The standard type of millivoltmeter measures temperatures directly without any hand manipulation whatsoever. The scale is graduated directly in temperature degrees and the operator can read the temperature at any time on the scale. Without doubt, the millivoltmeter is particularly advantageous on account of its simplicity.

An improved form of millivoltmeter pyrometer has been recently developed by Messrs. Paul D. Foote and Thomas R. Harrison, of Washington, D. C. This instrument affords a ready means of adjusting a millivoltmeter for any change in resistance up to 15 ohms of the circuit of thermocouple, leads, and instrument. Heretofore, instruments of this kind, which have been developed in the last few years, have required a dry cell to balance the voltage of the thermocouple but with the new instrument designed by Messrs. Harrison and Foote no dry cell or other source of current than the thermocouple is required. By simply pressing a button and turning a knob, the instrument can be instantly adjusted for any resistance of the circuit up to 15 ohms. This is an unusually desirable instrument where material variations in the length of leads will occur or where there are a number of thermocouples connected up to one central instrument with leads of unusual length. This instrument of Messrs. Harrison and Foote is a marked improvement over the Brown Heatmeter developed and patented by the writer some 2 years ago, and will be known as the Brown Improved Heatmeter.

*Potentiometer Method of Measuring Thermocouple Voltages.*—In this method of temperature measurement the electromotive force produced by a thermocouple is measured by opposing to it a known variable electromotive force, usually a dry cell contained in the instrument, so that when a balance is reached, no current flows. A galvanometer is used to indicate the point when a balance is reached and the galvanometer then indicates zero, the voltage of the thermocouple being equal to the impressed dry-cell voltage. After the thermocouple voltage has been balanced against the voltage of the dry cell, the actual measurement is that of the

dry-cell circuit, hence this measurement is entirely independent of the resistance of the circuit, including the thermocouple, lead wires, and galvanometer. As a consequence, the instrument is independent of the resistance of the circuit of the thermocouple and leads, and compensating leads can be run to the instrument 500 ft. (152 m.) distant, if desired. Changes in resistance of the various parts of the circuit due to changes in length or atmospheric changes will have no effect on the indication.

The advantage of the potentiometer method of measuring temperature is its extreme precision and its independence of resistance changes throughout the thermocouple circuit. It has the disadvantage, as compared with the millivoltmeter method, that it is not direct reading and that some outside source of current, a dry cell or storage battery for example, is necessary as a source of current to oppose the thermocouple, and this cell must be replaced or recharged from time to time.

There are portable potentiometers on the market that automatically compensate for the changes in temperature of the cold junction of the thermocouple, provided the compensating leads are brought to the instrument and they measure the millivoltage of the thermocouple with extreme precision. The writer has been recently granted a patent on a portable potentiometer in which a resistance is wound spirally on an insulated drum or cylinder. The scale is drawn in a spiral with the index traveling across the scale concentric with its travel along the spiral resistance. This type of portable potentiometer has a scale 8 ft. long. The standard scale is graduated up to 50 millivolts in 0.02 millivolt, or 50 graduations to a millivolt. Where used to measure temperature of a nickel-chromium thermocouple range of 2000° F., each graduation is equal to 2° F. (1.1+° C.) and a reading can easily be secured to one-fifth of this. There is no question but that with such an instrument extreme precision is attainable in measuring temperatures with a thermocouple.

*Recording Thermoelectric Pyrometers.*—There are procurable today pyrometers that accurately plot a record of the temperature as indicated by a thermocouple. These instruments are supplied with either circular charts for recording over a period of 24 hr. or with strip charts, lasting as long as 2 months without replacement. Recording pyrometers are supplied that make one record; or by locating two galvanometers side by side, the one recording instrument can make two independent records on one chart. By the introduction of suitable switching mechanism, a record of from three to as many as sixteen thermocouples can be produced on one recording sheet. Multiple recording pyrometers developed within the past 5 or 6 years use two methods of producing distinguishable records, either the records are produced in different colors, or each record line may be identified by a number printed simultaneously with the operation of the recorder. Great progress has been made in the development of accurate recording pyrometers in the last few years.

*Recording Pyrometers for Transformation Points.*—A special design of recording thermoelectric pyrometer is required for determining accurately the transformation points that metals undergo through heating or cooling, see Fig. 5. In addition to the test piece of steel, the transformation point of which is to be determined, a neutral body of a nickel alloy is inserted in the electric furnace with the test piece. One thermocouple is installed in the neutral body and another in the test piece and as the test piece goes through its transformation point a differential is set up, due to the continued heating of the neutral body, whereas the test piece ceases to rise in temperature at these transformation points although the furnace continues to heat up.

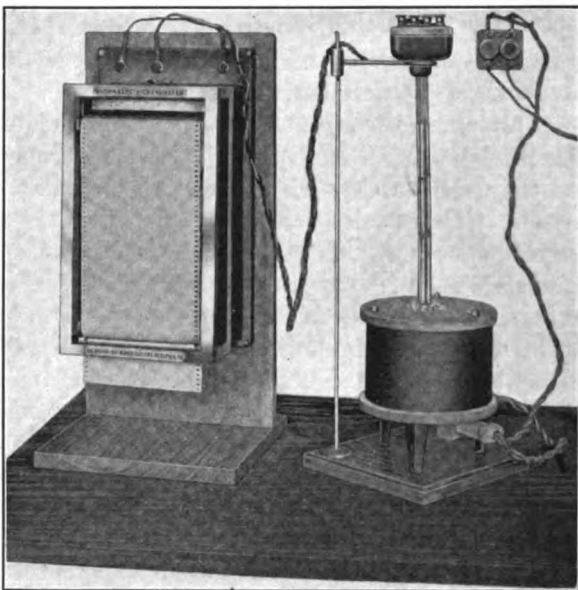

FIG. 5.—RECORDING PYROMETERS FOR TRANSFORMATION POINTS.

Within the past year, the writer has been granted two patents on an improved form of differential transformation-point recorder, which automatically plots the true temperature of the test piece and the record of the differential, which greatly magnifies the jog occurring on the chart at the transformation points.

*Automatic Signaling Pyrometers.*—Instruments to automatically ring a bell have been supplied for many years, operated by the older types of expansion pyrometers or mercurial thermometers. A platinum contact is installed in the mercurial thermometer tube and when the mercury rises to the platinum contact the bell rings. There is a demand for thermoelectric pyrometers for measuring higher temperatures that will give a positive and reliable alarm under certain changes in temperature

or will visually indicate changes in temperature by the means of signal lights. In the last 2 years there have been numerous installations of thermoelectric signaling pyrometers operated by either the millivoltmeter method or the potentiometer system.

In this type of instrument it is essential that positive contacts should be made and no current should pass through the indicating pointer normally used to indicate or record the temperature. In the standard form of signaling pyrometer we construct, the pointer is periodically depressed on to contacts at intervals of every 30 sec. In the case of the pyrometer operating signaling lights, three contacts are used representing high, correct, and low temperatures, corresponding to red, white, and green lights.

Many of the men employed around heat-treating furnaces are unable to read or write and a temperature scale is meaningless to them. It is a comparatively easy matter to instruct these men to keep the white light burning all the time, and if the red or green light should burn to regulate the valve accordingly. This is a much easier proposition than to tell the men to maintain the temperature at 1450° F. (788° C.) and if the temperature rises to 1470° (798° C.) he should partly shut the valves or if it falls to 1430° (777° C.) he should open the valve. Besides the advantage to the workmen of being able to instantly observe the temperature of the signal lights, the foreman in charge of the department can look along a row of furnaces from one end of the room and instantly note whether the white light is burning on all furnaces. If a certain furnace has the red or green light burning too often, an investigation can be made as to the difficulty and the trouble promptly corrected.

*Automatic Temperature-control Pyrometers.*—From the automatic signaling of the temperature by lights, it is a very short step to the automatic control of temperature. The problem of controlling electric-furnace temperatures is a very easy one as a switch operated by solenoids or electric magnets can be controlled by the pyrometer. Where used to operate a valve to control furnaces or ovens heated by steam, gas, or oil, a solenoid or magnet must be applied to operate the valve instead of the switching mechanism. Switches for electric-furnace control can be installed directly in the main circuit, but preferably should cut in or out one of the sections or heating elements of the furnace or a certain part of the resistance in series with the furnace.

Opening and closing of the main circuit will naturally produce constant rising and falling of the temperature, whereas the fluctuation occurring in the voltage or temperature conditions in the furnace can be more accurately controlled by the pyrometer if only approximately 25 or 50 per cent. of the current is controlled. Likewise, in the control of oil or gas furnaces, if the valve is installed in the main line the supply is either all on or cut off entirely, and this must naturally produce constant

fluctuation in temperature. If the valves are installed in a by-pass and a proportion of gas passing through the by-pass is adjusted so as to have approximately only 25 per cent. control, these constant fluctuations are eliminated and a very satisfactory control can be maintained.

*Radiation Pyrometers.*—A radiation pyrometer measures temperatures by the heating of a thermocouple subject only to radiated heat instead of to the direct temperature. Instead of placing the thermocouple directly inside the furnace where the temperature would be so high as to destroy it, it is placed in the back of a tube in the focus of a mirror. The rays of heat from the furnace enter the tube and strike the mirror and are focused on the hot junction of the thermocouple. This attains a heat of only 200° or 300° F. (93° or 148° C.).

This instrument has a particular field where temperature must be measured from 2800° F. (1538° C.) up to 3600° F. (1982° C.) or more, and it is possible to secure an accuracy of 1 to 2 per cent. with this type of pyrometer, if the instructions as to its use are properly carried out. A radiation pyrometer should not be used where a thermoelectric pyrometer can be applied to advantage.

*Optical Pyrometers.*—There has been notable improvement in the adaptation in the past few years of optical pyrometers to general industrial service. Optical pyrometers are not a recent development, like practically every other type of pyrometer in use today, but it has only been within the past few years that optical pyrometers have been brought to the point where they can be satisfactorily used in the industries. The development has been largely along the lines of simplifying the design so that satisfactory results can be secured by almost any user. The trouble with optical pyrometers in the past has been that no two operators could secure the same reading. There are some types of optical pyrometers used to a considerable extent which were supposed to help the eye in determining the temperature, but these have done more harm than good.

#### RÉSUMÉ

I have attempted to cover the subject of recent improvements in pyrometry from the standpoint of the application of pyrometers to the industries. Many special types of pyrometers have been built for laboratory and experimental use, that it would be impossible to refer to in a paper of this character; but though pyrometry has made marked progress in the last few years, I have not the slightest doubt that much greater progress will be made in the next few years. Most industrial plants have coöperated to the utmost with the pyrometer manufacturer in an effort to perfect temperature-measuring apparatus to meet the requirements of general industrial service. Certain foreign countries were formerly recognized as the leaders in the manufacture of

scientific instruments, and particularly pyrometers. This lead has now been taken by our country, and with the rapid perfection of our pyrometers and the great amount of research work constantly being performed, we shall never lose the lead.

### DISCUSSION

E. D. TILLYER,\* Southbridge, Mass. (written discussion†).—It is quite generally known that there is very little that is standard about a mercurial thermometer at temperatures above 212° F. (100° C.) because so many precautions must be taken—precautions that are rarely realized in practice—such as depth of immersion, aging, elastic fatigue, separation of mercury column, and accidental deformation from very slight excess temperature.

One cannot help wishing that Mr. Brown would dwell at greater length on the practical side of both radiation and optical pyrometers, both of which have great possibilities as commercial instruments. In the radiation pyrometer we have ideal conditions for a permanent instrument, no materials being exposed to excessive temperatures or subjected to contamination from the furnace fumes which may raise such havoc with an ordinary pyrometer. The development of a radiation pyrometer requires a thermocouple having a relatively high electromotive force but which need stand temperatures of only 200° F. or 300° F. instead of 1500 to 2000° F., which is required of even a base-metal couple. The galvanometer, if located near the thermocouple, does not need to have a high resistance, as at such low temperatures no changes can occur in the thermocouple that will affect its resistance and, consequently, the indicated temperature.

The serious source of error is the lens or mirror, which images the furnace interior on the hot junction of the thermocouple; this must always have the same transmission, or reflection, and dirt and tarnish must be avoided. Another source of error in many instruments is the temperature of the cold junction, which heats up from radiation. However, there is no fundamental reason why the cold junction cannot be carried to a position of constant temperature, as is done with the regular thermocouple pyrometers.

One physical defect of a radiation pyrometer is the absorption of the longer heat rays by varying amounts of water vapor in the atmosphere. Perhaps this could be overcome by using selective absorption screens cutting out the rays absorbed by water vapor. Another physical defect of a radiation pyrometer, and also of the optical pyrometer, is that it indicates the radiation temperature of the object on which it is focused.

\* American Optical Co.

† Received Sept. 25, 1919.

This would seldom be an objection, however, as the most that is desired is to reproduce temperatures; if it were desired to obtain true temperatures, the black-body condition could be obtained for a small part of the furnace by simply inserting a heat-resisting tube for a considerable distance and focusing the pyrometer on the inside end.

The optical pyrometer requires, in all present forms, that the observer look through it and not at it. Until someone overcomes this practical defect, one of the best forms of instruments for higher temperature pyrometry is probably barred out.

A. O. ASHMAN, Palmerton, Pa. (written discussion\*).—From a theoretical point of view the best method to maintain the cold junction at a constant temperature is by means of a pipe driven in the ground, to which the so-called cold-junction compensating leads are run, and of course there are many times and places where it can be successfully used. There are, however, several objections to this method. In the vicinity of any furnace there are apt to be underground flues for preheated air or gases, recuperators, water mains, etc., which will eliminate the probability of a constant temperature. These, of course, can be avoided by carrying the leads to distant locations known to be free, but this is not good practice because the so-called compensating leads have a rather high resistance, which materially affects the accuracy of even the high-resistance instruments, unless they are specially calibrated for it. Moreover, the cost of these long leads is almost prohibitive. A better way is to run short lengths of compensating leads to electrically heated constant-temperature boxes conveniently located near the furnace in a place that is of fairly uniform temperature. These boxes are on the market and can be procured at a cost that is approximately equal to the cost of 100 ft. of compensating leads. They can be connected to any power or lighting circuit and once set require very little care. One box will accommodate a number of couples.

An additional disadvantage of the buried pipe is that moisture or water may accumulate in it. This is hard to detect and almost impossible to remove. It generally gives rise to galvanic effects which result in errors that are greater than those due to an uncorrected cold junction.

While the term "compensating leads" is in general use, it is not justifiable, as there is no compensation in the true sense of the word. For example, suppose the cold junction of a couple was exposed to a temperature of 100° higher than the couple was calibrated for. If the ends of the leads connected to this couple were in the same region there would, of course, be no compensation as when a true compensator was used. A better term, I think, would be cold-junction extension leads. Many

---

\* Received Sept. 25, 1919.

terms in pyrometry are more or less loosely used, which could be standardized by suitable action on the part of some interested society.

**W. H. BRISTOL**, Waterbury, Conn.—There should be some standard way of speaking of what are sometimes called compensating leads, which, it seems to me, is a misnomer. As I understand it, so-called compensating leads are an extension of the couple itself, a continuation of the same materials of which the couple is made, so as to carry the cold end to a desired point where the temperature is more uniform, or to some correcting device where it can be held at constant temperature to provide for atmospheric changes. "Extension" of the couple would be a very good name.

**E. F. NORTHRUP**, Trenton, N. J.—We have found it is possible to do away with all of these cold-junction corrections by using the all-steel thermos bottles. We use a platinum-rhodium couple having leads just long enough to reach from the couple down into the steel thermos bottle; the rest of the way copper is used. These bottles can be set within 4 or 5 ft. of a large steel bottle filled with molten steel or iron without injury to the bottle and where it will hold cracked ice for 24 hr. We have been able to use hundreds of couples that way and think it a convenient and practical method. When the cold junction goes into the thermos bottle, it must not pass through a metal tube, for that will conduct the heat into the bottle and melt the ice. The junction should pass either through a non-heat-conducting tube or it must be separated from the neck of the bottle by suitable heat-insulating material.

**ANTHONY ZELENY**,\* Minneapolis, Minn.—In 1903, I experimented with a thermoelectric installation consisting of about 200 junctions connected to one common return wire about 400 ft. in length. The common cold-junction was placed in a tube buried in the earth. This was in a steel-tank grain elevator; all insulators were necessarily attached to iron beams and were soon covered with grain dust. The belt conveyors were operated by direct-current motors. This thermoelectric installation operated perfectly except when the motors were in action. Sufficient leakage current passed through the system and the galvanometer to destroy the readings. The removal of the cold junction from the earth remedied the trouble. No attempt was made to improve the insulation. It appears that in such extraordinary installations special care must be taken to prevent leakage when the cold junction is buried in the earth.

---

\* Professor of Physics, University of Minnesota.



### Automatic Compensation for Cold-junction Temperatures of Thermocouple Pyrometers

BY FELIX WUNSCH,\* PHILADELPHIA, PA.

(Chicago Meeting, September, 1919)

WHILE the effect of the cold-junction temperature has been known by many, its consideration has been ignored in a number of installations, resulting at times in a very considerable error. In fact, the magnitude of this error may amount to over 100° in some cases. While hand-operated correcting devices for portable checking pyrometers may be entirely satisfactory, it is, of course, desirable to have such apparatus en-

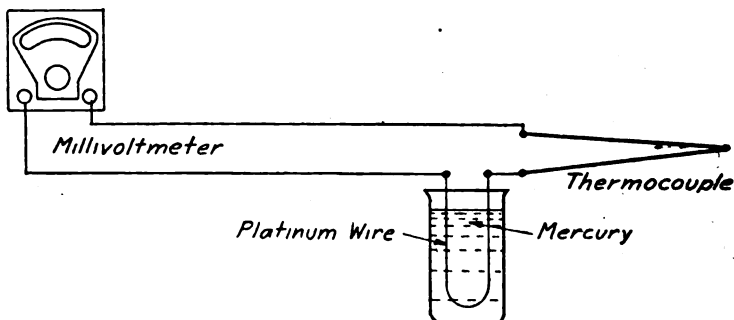

FIG. 1.—EARLY METHOD OF AUTOMATICALLY COMPENSATING FOR COLD-JUNCTION TEMPERATURE CHANGES.

tirely automatic when applied to curve-drawing or printing pyrometers, otherwise there is no assurance that the record is correct.

Numerous methods for automatically compensating for cold-junction temperature changes of thermocouples have been proposed and used in connection with millivoltmeters. One of the earliest proposed was that shown in Fig. 1. A bare resistance wire was immersed in a column of mercury located near the cold junction of the thermocouple. An increase in temperature near the cold junction resulted in a rise of the mercury column, which short-circuited more of the resistance wire, causing an increase in the potential difference across the millivoltmeter, which compensated for the decreased electromotive force of the thermocouple.

The method is open to the objection that the compensation is accurate at only one temperature of the hot junction, for the voltage change across the compensating resistance is a function not only of the compensating resistance but also of the current passing through it. As the

\* Electrical Engineer, Engineering Department, Leeds & Northrup Co.

current changes with the hot-junction temperature, it is obvious that accurate compensation for cold-junction temperature can be obtained for only one temperature of the hot junction. As an example, suppose that the cold-junction temperature is  $0^{\circ}\text{C}$ . and the hot-junction temperature  $1000^{\circ}\text{C}$ . and that the e.m.f. generated is 60 millivolts. Assume the resistance in the millivoltmeter circuit including the compensating resistance at  $0^{\circ}\text{C}$ . to be 600 ohms. Then the current in the millivoltmeter is  $\frac{60}{600} = 0.1$  milliampere. If the cold-junction temperature increases to  $50^{\circ}\text{C}$ ., reducing the e.m.f. by 3 millivolts and reducing the resistance in the compensating resistor by 30 ohms, the current is  $\frac{60 - 3}{600 - 30} = \frac{57}{570} = 0.1$  milliampere, the same as before, and perfect compensation has been obtained for a hot-junction temperature of  $1000^{\circ}\text{C}$ . But if the hot-junction temperature falls to  $500^{\circ}\text{C}$ . and the cold-junction is at  $0^{\circ}\text{C}$ ., as in the first case, and the e.m.f. generated is 30 millivolts, the current is  $\frac{30}{600} = 0.05$  milliampere. On the other hand, should the cold junction rise to  $50^{\circ}\text{C}$ . while the hot junction remains at  $500^{\circ}\text{C}$ ., the resistance in the circuit is reduced to 570 ohms as before and the voltage is reduced by 3 millivolts as before, because the e.m.f. generated at the cold junction is independent of the temperature of the hot junction. The current will now be  $\frac{30 - 3}{600 - 30} = \frac{27}{570} = 0.0474$  milliamps. This current is 5.2 per cent. lower than that obtained with the cold junction at  $0^{\circ}\text{C}$ . Consequently the reading on the millivoltmeter will be 5.2 per cent. low at  $500^{\circ}\text{C}$ . when the cold-junction temperature rises from 0 to  $50^{\circ}\text{C}$ ., an error of  $26^{\circ}\text{C}$ . In practice, the error may be considerably greater than  $26^{\circ}\text{C}$ ., since the location of the cold junctions in the head of the thermocouple protecting tube often results in a much greater rise of temperature than  $50^{\circ}\text{C}$ . at the cold junctions.

Fig. 2 shows a device operating on the same principle as that just described but employing a different construction. A number of thin carbon disks are tightly packed in a porcelain cylinder, which has a small coefficient of expansion. The rod is made of a metal having a large coefficient of expansion, such as zinc. As the temperature increases the rod expands and increases the pressure between the carbon disks, thus decreasing the resistance. The device is connected in series with the thermocouple and millivoltmeter. This device has the same defect as that shown in Fig. 1, namely, it compensates accurately for variations in cold-junction temperature at only one temperature of the hot junction. Fig. 3 shows another method of automatically compensating for cold-junction temperature. *A* is a resistor which increases its resistance as the temperature rises. *B* is a resistor whose resistance remains constant when the temperature changes. The operation is as

## 208    AUTOMATIC COMPENSATION FOR COLD-JUNCTION TEMPERATURES

follows: Assuming a constant temperature at the hot junction, the currents through *A* and *B* decrease as the temperature of the cold junction increases. This would tend to decrease the potential across *A* but, by proper adjustment of *A* and *B*, this decrease can be neutralized by the increase in resistance of the coil *A*, the net result being that the potential difference across *A* for a constant temperature at the hot junction re-

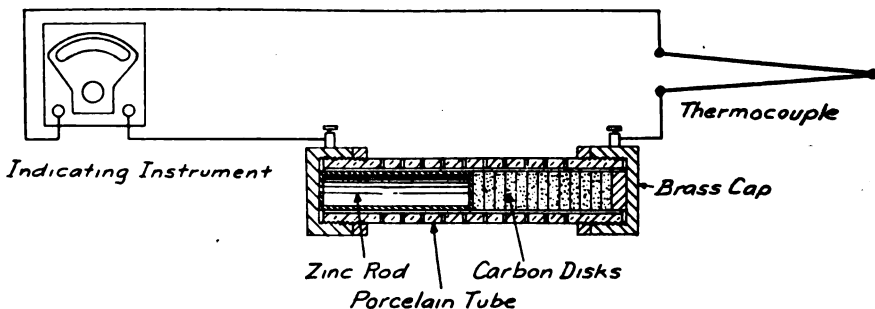

FIG. 2.—USE OF CARBON DISKS FOR COMPENSATING FOR COLD-JUNCTION TEMPERATURES

mains constant, although the temperature of the cold junction changes. The compensation can be made correct for one temperature of the hot junction only and consequently is not better than the devices shown in Figs. 1 and 2.

All devices of this nature, where an actual current is drawn from the thermocouple, are defective in that they depend for accuracy on the

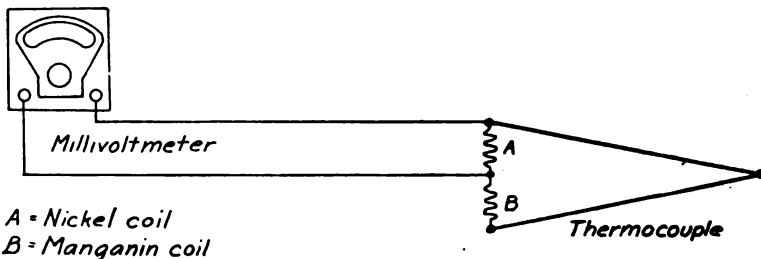

FIG. 3.—USE OF NICKEL AND MANGANIN COILS FOR COMPENSATING FOR COLD-JUNCTION TEMPERATURE CHANGES.

constancy of resistance of the thermocouple. The thermocouple, however, gradually changes resistance with use and gives no external evidence of such change until the circuit is actually broken.

Fig. 4 shows another scheme very similar to that just described which has the same defect, namely, it compensates accurately for variations of cold junction only when the hot-junction temperature remains constant. It is not as good as the scheme shown in Fig. 2 because it is as inaccurate and, in addition, introduces additional resistance in the millivoltmeter

circuit, which is objectionable because a more sensitive millivoltmeter must be used.

Fig. 5 shows another scheme of automatic cold-junction compensation. The resistors *a*, *b*, *c*, and *d* are connected in the form of a Wheatstone bridge, as shown, and placed near the cold junction of the thermocouple. Three arms of this bridge are made of resistances having a zero temperature coefficient, such as manganin. The fourth arm is made of a metal having a high temperature coefficient, such as nickel. These

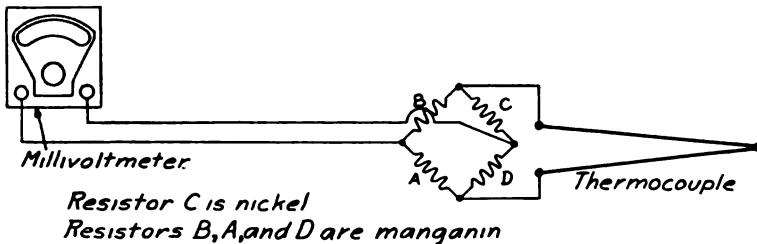

FIG. 4.—SECOND METHOD USING NICKEL AND MANGANIN COILS.

resistances are adjusted so that they have equal resistances at some reference temperature, such as  $0^{\circ}\text{C}$ . The bridge consequently is balanced at this temperature and no difference of potential due to the battery *Ba* appears at the terminals *e* and *f*. If the temperature of the cold junction changes, the resistance of the nickel coil changes and throws the bridge out of balance. This changes the e.m.f. across the terminals *e* and *f* and if the coils are properly adjusted will exactly neutralize the

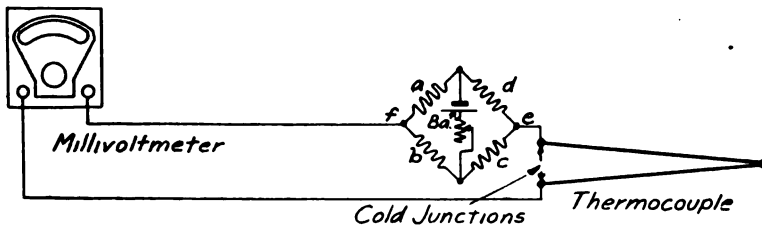

FIG. 5.—METHOD IN WHICH RESISTORS ARE CONNECTED IN FORM OF WHEATSTONE BRIDGE.

change in e.m.f. at the cold junction of the thermocouple. The nickel resistance *c* is made low in comparison to the total resistance in the millivoltmeter circuit, so that resistance changes of the nickel coil do not materially change the total resistance in the millivoltmeter circuit. Consequently the compensation is practically correct for all temperatures of the hot junction provided the voltage at the terminals of the bridge is kept constant. Changes in the voltage of the battery can be corrected for by means of a rheostat in the battery circuit.

## 210 AUTOMATIC COMPENSATION FOR COLD-JUNCTION TEMPERATURES

Other methods of automatically compensating for cold-junction temperature changes by means of magnetic shunts and other devices mounted on the millivoltmeter to shift the position of the pointer have been used more or less successfully. The cold junctions are brought to the millivoltmeter by the use of the proper lead wire. Fig. 6 shows a simplified diagram of connections of the Leeds & Northrup split-circuit potentiometer system with automatic cold-junction compensator. The current from the battery *Ba* divides at *a* and *b*, one-half passing through the upper branch which includes the slide wire *S* and resistances *G* and *B*. The lower branch includes the nickel coil *D* and the resistance *C*. All the resistances, except the nickel coil *D*, are made of manganin wire having a zero temperature coefficient. The current in the two branches is kept constant by adjusting the rheostat *R* until the drop of potential across

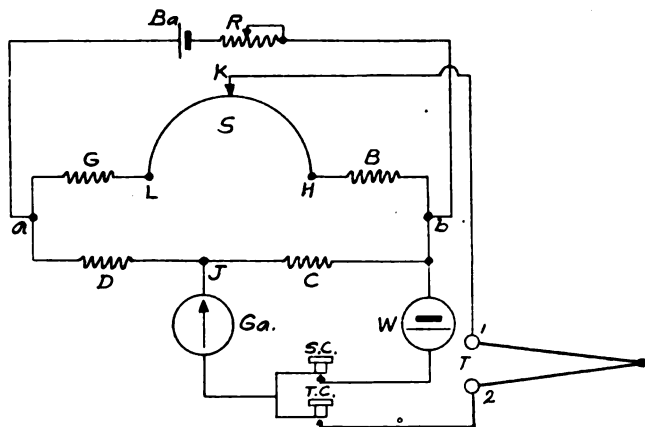

FIG. 6.—SIMPLIFIED DIAGRAM OF CONNECTIONS OF LEEDS & NORTHRUP SPLIT-CIRCUIT POTENTIOMETER SYSTEM.

the coil *C* is equal to the e.m.f. of the standard cell *W*. The galvanometer *Ga* shows when a balance has been obtained. In the recording instrument, this adjustment is made automatically. The resistances *B* and *C* are high and are so chosen that the resistances in the two branches are equal. The nickel coil is located near the cold junction of the thermocouple and has such a value that changes in cold-junction temperature are compensated for by changes in the drop of potential across this coil caused by changes in its resistance with temperature.

The value of the compensating coil is calculated as follows: let  $R$  = resistance of compensating coil *D* at reference temperature;  $c$  = change in e.m.f. of thermocouple per degree change in temperature of cold junction;  $K$  = temperature coefficient of nickel composing compensating coil per ohm per degree;  $t$  = temperature change of cold junction;  $i$  = current in branch including nickel coil;  $e$  = change in e.m.f. of

thermocouple due to temperature change  $t$  of cold junction;  $e_1$  = change in fall of potential across nickel coil due to temperature change  $t$  of cold junction.

In order to have compensation  $e$  must equal  $e_1$ .

$$e = e_1 \quad e = et \quad e_1 = RKti$$

$$ct = RKti \quad R = \frac{c}{Ki}$$

Therefore the resistance  $D$  is made equal to the constant quantity  $\frac{c}{Ki}$  and  $e$  equals  $e_1$  regardless of changes in temperature of the cold junction.

The value of the resistance  $G$  is so chosen that the scale starts at  $0^\circ$  or at any other desired temperature. For example, suppose the temperature range is from  $0$  to  $1000^\circ$  C. The coil  $G$  will be equal to the nickel coil  $D$  at  $0^\circ$  C. Suppose both the hot junction and the cold junction are at  $0^\circ$  C. The e.m.f. of the thermocouple will be zero and the difference of potential between  $K$  and  $J$  will also be zero because the resistance of  $D$  equals that of  $G$ . If the temperature of the hot junction increases to  $1000^\circ$  C. and the cold junction stays at  $0^\circ$  C. the galvanometer will show a balance when the contact  $K$  is at the extreme right side of the scale (side marked  $H$ ). Now suppose the temperature of the cold junction increases. The e.m.f. of the couple will decrease but the resistance of the nickel coil increases and causes a decrease in the e.m.f. across the points  $J$  and  $K$  that exactly compensates for the decrease in the e.m.f. of the thermocouple. The result is that the contact  $K$  remains at  $1000^\circ$  on the scale, which is the temperature at the hot junction.

If base-metal thermocouples are used, the leads connecting the thermocouple with the measuring instrument are usually of the same material as the thermocouples, consequently the cold junction is located at the measuring instrument. In this case the cold-junction coil is mounted in the measuring instrument. If noble-metal couples are used, it is customary to use copper leads to the thermocouple. In this case the cold-junction coil is mounted in the head of the thermocouple and connected to the measuring instrument by means of three copper wires. The connections are as shown in Fig. 7. It will be noted that the  $b$  and  $c$  leads are in opposite branches of the potentiometer circuit and being of equal length the resistance causes no error, because the drop in potential in one lead is compensated for by the drop in the other lead.

If the metals of the leads connecting the thermocouple have the same characteristics as the metals of the thermocouple, the cold junction will be located at the measuring instrument and the compensating coil can also be located in the measuring instrument, thus avoiding the use of the three copper leads that must be run to the cold-junction coil when it is

## 212 AUTOMATIC COMPENSATION FOR COLD-JUNCTION TEMPERATURES

mounted in the head of the thermocouple. Patent leads composed of base-metal alloys that give the same e.m.f. as platinum platinum + 10 per cent. rhodium wires can be obtained. These leads can be used to connect the platinum platinum-rhodium couples to the measuring instrument. The use of these leads is increasing rapidly and where used they have given satisfaction.

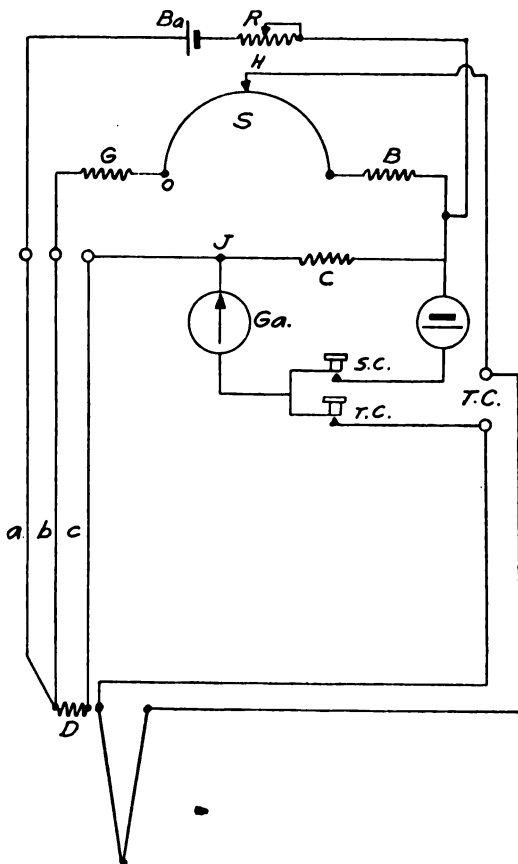

FIG. 7.—CONNECTION OF COLD-JUNCTION COIL WITH NOBLE-METAL COUPLE.

### DISCUSSION

W. H. BRISTOL, Waterbury, Conn.—Five schemes for automatically taking care of the cold end of the thermocouple are shown and attention is called to the different, you might say, limitations of these schemes. They give perfect automatic connections with a cold end for a certain predetermined point on the scale, and either above or below such points there would be over-compensation or under-compensation, as the case

may be, which could be calculated very readily. In some papers presented it has been shown what the limitations are. I would like to mention that each of the first four schemes shown was developed by myself or the company I represent, and we have patented the basic principles of them all. Our latest development is a thermoelectric pyrometer in which the cold end of the thermocouple is automatically compensated for the entire range, which can be anything from  $-0$  through the working range of a thermoelectric couple. The method of obtaining this result is to secure to the controlling spring inside of the instrument a length of bimetallic differential thermostatic metal so that it unwinds or winds the control spring to suit the changes that occur in the instrument itself. The thermocouple is extended entirely from the hot end to the inside of the instrument.



### Use of Modified Rosenhain Furnace for Thermal Analysis

BY H. SCOTT,\* A. B., AND J. R. FREEMAN, JR.,\* B. S., WASHINGTON, D. C.

(Chicago Meeting, September, 1919)

In a paper read before the Institute of Metals, Rosenhain<sup>1</sup> described a new type of furnace designed primarily for the thermal analysis of metals by the inverse-rate method and used by him in the metallurgical department of the National Physical Laboratory with considerable success. In his discussion of this furnace, Rosenhain pointed out some difficulties met with in its operation, such as uniformity of rate of heating or cooling being inadequate for the degree of accuracy aimed at. To overcome this difficulty, he suggested, in place of motor propulsion, a gravity drive controlled by a "hydraulic cylinder with a relief valve whose width of opening can be regulated to allow of any desired rate of motion." The authors, in constructing a thermal-analysis furnace of Rosenhain's type, have therefore followed this suggestion and also added certain features that increase somewhat the convenience and simplicity of its operation. Requests for information regarding this furnace and the highly satisfactory results obtained from its use, it is believed, justify describing its construction and operation in sufficient detail to make possible its duplication or improvement.

*Description of Furnace.*—The details of the furnace construction are shown in Fig. 1, which is drawn to scale. The heating tube is of  $\frac{1}{4}$  in. (6.35 mm.) wall "alundum" heated at the upper end by seventeen turns of 0.52 mm. platinum wire, which is coated with "alundum" cement supplied for this purpose. The cement coating is essential when a high temperature (over 1000° C.) is required, as it prevents hot spots with the resulting burning out of the heater. This platinum-wire winding, unlike "nichrome," is entirely satisfactory for temperatures of at least 1000° C. It has been maintained at that temperature continuously for 2 months and shows no signs of deterioration. This temperature is maintained by a current of 5 amp. drawn from 30 volts potential, so its necessarily continuous operation is quite economical.

The furnace is heated at the top, as is Rosenhain's, to avoid convection currents, but the sample in its containing tube is introduced from the bottom, or cold end. This removes the disadvantages of his method, which consist of inconvenience in position of the sample and control apparatus

\* Assistant Physicist, U. S. Bureau of Standards.

<sup>1</sup> Some Appliances for Metallographic Research. *Jnl. Inst. Metals* (1915) **13**, 160.

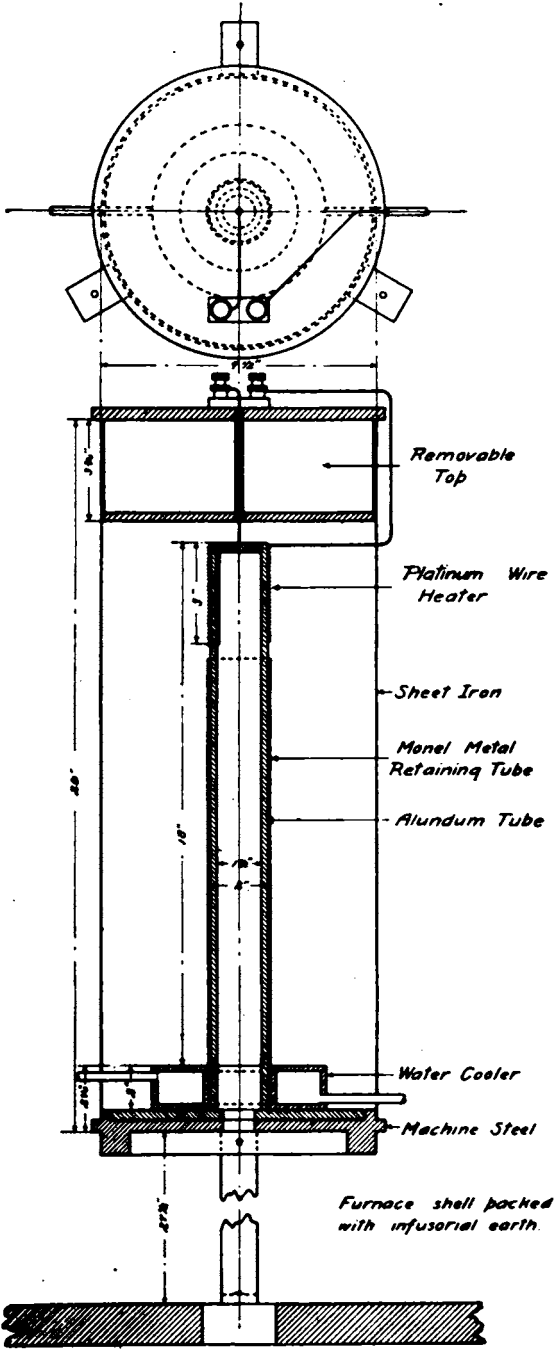

FIG. 1.—DIAGRAM OF FURNACE.

216 USE OF MODIFIED ROSENHAIN FURNACE FOR THERMAL ANALYSIS

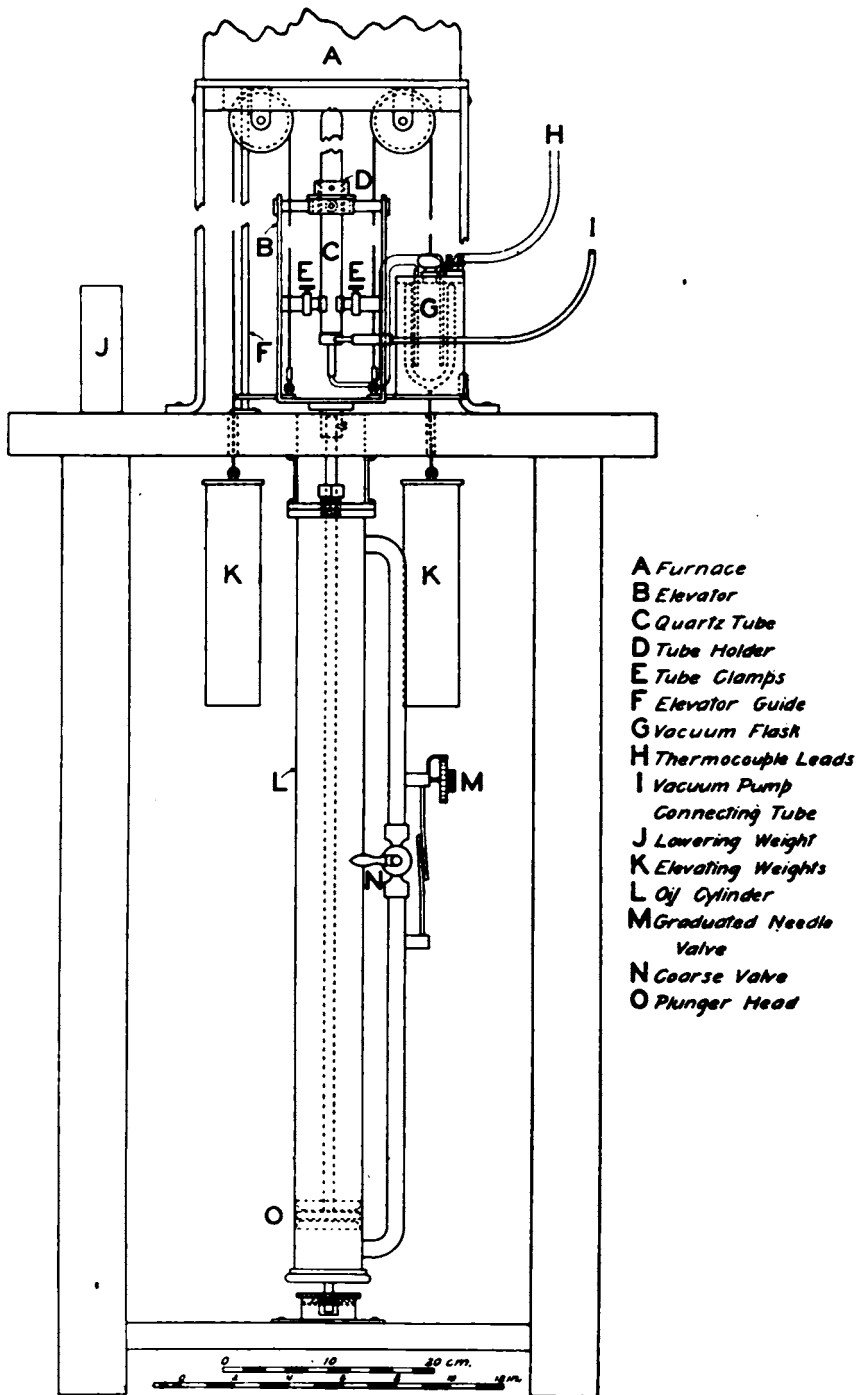

FIG 2—DIAGRAM OF ELEVATING MECHANISM.

and the heating of some part of the sample tube at all times to the maximum temperature of the furnace. The latter disadvantage may prove serious in the event of slight inhomogeneities in the thermocouple wire.

*Description of Elevating Mechanism.*—The details of the rate-control mechanism are shown in Fig. 2. The weights *K* (total weight 15 lb.—6.8 kg.) operating over pulleys supply the force to lift the elevator *B* and the weight *J* (2 lb.) to lower it. The rate of motion of the tube *C* clamped on the elevator is controlled by the flow of oil from one end of the cylinder *L* to the other through the needle valve *M*. The oil cylinder is kept open to the air and filled with a good grade of engine oil, care being taken that the oil is free from dirt and air bubbles, which might easily cause vari-

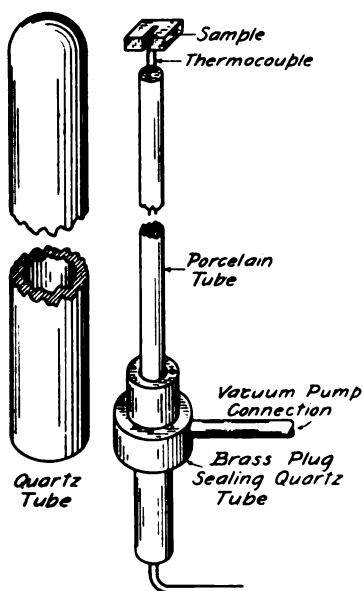

FIG. 3.—SAMPLE MOUNTING.

ations in the rate of motion of the plunger. The sample tube *C* is held and centered with three setscrews in a sleeve *D*, which fits into a receptacle on the elevator facilitating rapid changing of the sample. A guide rod *F* prevents rotation of the elevator and steadies its motion.

*Details of Operation.*—The differential method of obtaining curves may be used with this furnace, but the experience of the authors has been that more valuable and satisfactory results are obtained by use of the inverse-rate method, which accordingly has been used almost exclusively. The adoption of the inverse-rate method limits the pyrometric requirements to a single thermocouple and potentiometer. This permits of the use of a somewhat novel method of mounting samples, first used by Bur-

## 218 USE OF MODIFIED ROSENHAIN FURNACE FOR THERMAL ANALYSIS

gess and Crowe<sup>2</sup> in their researches on pure iron. This method is illustrated in Fig. 3. The operations involved consist simply of cutting a 0.5 mm. slot in the sample with a small hack saw and riveting in this slot the flattened head at the hot junction of a platinum-90 platinum-10 rhodium thermocouple in the form of 0.5-mm. diameter wire. The mounted sample is sealed in the quartz tube and a vacuum maintained through the brass-plug connection.

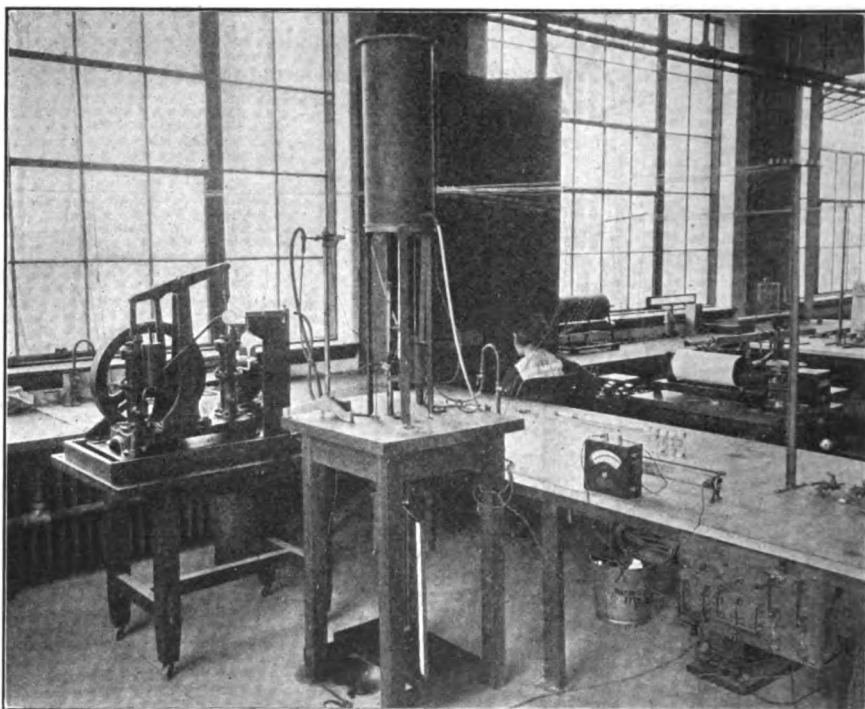

FIG. 4.—ASSEMBLED FURNACE AND AUXILIARY APPARATUS.

This method of mounting has the advantages of good thermal contact between sample and thermocouple, use of small samples—usually  $\frac{1}{8}$  by  $\frac{9}{32}$  by  $\frac{3}{8}$  in. (3.2 by 7.15 by 9.5 mm.) weighing about 1.7 gm.—with the consequent elimination of detectable thermal gradients and ease of preparation of samples. Its chief disadvantage is the slight contamination of the thermocouple resulting from close contact with the sample at high temperatures. This source of error is easily avoided by using a homogeneous thermocouple and frequently removing the short length subject to contamination. A check can be had on the accuracy and

<sup>2</sup> The Critical Ranges  $A_1$  and  $A_2$  of Pure Iron. U. S. Bureau of Standards *Sci. Paper* 213.

sensitivity of the apparatus under actual operating conditions by taking curves on pure iron, the transformation  $A_2$ , of which has a maximum heat effect very constant at  $768^\circ\text{C}$ .<sup>3</sup> independent of rate of temperature change.

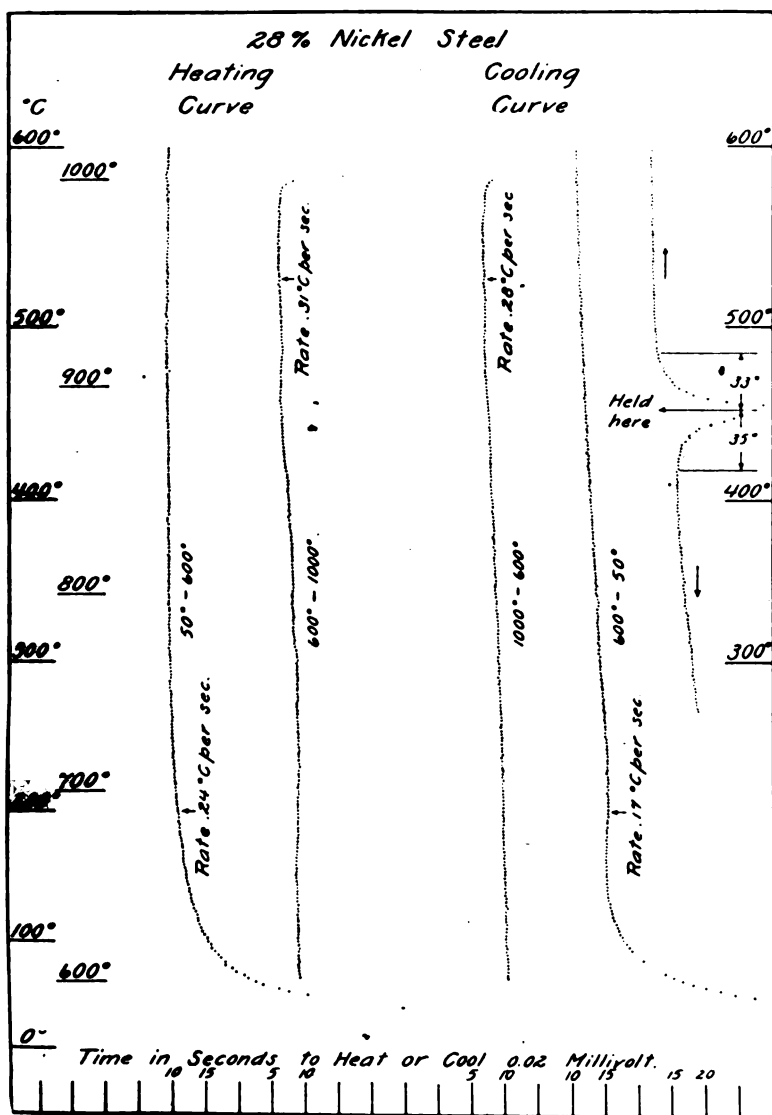

FIG. 5.—THERMAL CURVES OF 28-PER CENT. NICKEL STEEL.

The temperature measurements are made with a dial potentiometer and the time intervals are recorded on a drum type chronograph, which

<sup>3</sup> Burgess and Crowe: *loc. cit.*

## 220 USE OF MODIFIED ROSENHAIN FURNACE FOR THERMAL ANALYSIS

instruments have already been described.<sup>4</sup> The assembled apparatus is shown in Fig. 4.

A heating and cooling curve, characteristic of the furnace, taken on a transformationless (28 per cent. nickel) steel over the temperature range 50° to 1000° C., is shown in Fig. 5, each curve being divided into two sections for convenience in reproduction. Curves of a steel showing several critical points of small intensity and taken with this apparatus are available in the work of one of the present authors.<sup>5</sup> It may be noted that the rate of temperature change is somewhat slower at the lower temperatures than at the higher, as would be expected, but that the change is not sufficient to obscure a transformation occurring anywhere between 100° and 1000° C. This change in rate is emphasized at the lower temperatures by the parabolic form of the relation between the temperature and the electromotive force of the platinum couple, for the curves are plotted with time of unit electromotive force change as abscissas as a matter of convenience. The actual rate change can be reduced, and probably eliminated for a given rate, by using a metal cylinder or "alundum" tube tapered to increase the heat conduction at the lower temperatures.

It might be apprehended that the gravity drive would impart an extended acceleration to the elevator instead of a uniform velocity, but that the time required for the rate to become uniform is slight is shown by the short curves, on the right-hand side, obtained by bringing the sample to the constant temperature designated and then taking readings from the time of opening the valve. The time required for the rate to become normal for that valve setting is only 6½ min. on heating and 4½ min. on cooling, while the corresponding temperature interval is only 33° and 35° C. This is an extremely useful characteristic of the furnace, as it enables the separation of one transformation superimposed on the end of another by holding the sample at a temperature at which the first transformation will complete itself and then starting. It also facilitates the study of the effect of time of holding in the proximity of the transformation temperature on its position; that is, determining the limits of the transformation temperature at what amounts to zero rate of temperature change.

The authors wish to acknowledge the skill contributed by Mr. F. E. Mann in the construction of this furnace and the assistance of Miss H. G. Movius and Mr. H. A. Wadsworth in its successful development.

---

<sup>4</sup> Burgess and Crowe: *loc. cit.* Dr. P. D. Merica has substituted a pair of stop watches for the costly chronograph with good results providing the time interval is greater than 15 sec.

<sup>5</sup> Scott: *Trans.* (1920) 62. Also U. S. Bureau of Standards *Sci. Paper* 335.

## A Hot-wire Anemometer with Thermocouple

BY T. S. TAYLOR,\* PH. D., EAST PITTSBURGH, PA.

(Chicago Meeting, September, 1919)

THE development of the linear hot-wire anemometer has been chiefly due to the efforts of L. V. King<sup>1</sup> and A. E. Kennelly and H. S. Sanborn.<sup>2</sup> The anemometers used by these investigators consisted essentially of a fine heating wire having attached leads for resistance measurements at distances of 10 or more centimeters from each other. In using such an anemometer, the current is measured that is necessary to maintain the resistance of the wire, between the two leads, constant for different air velocities. This resistance is always so chosen that the temperature of the heating wire will be sufficiently high to make the observations practically independent of small variations in the temperature of the gas in which the anemometer is placed. The measurement of the resistance of the anemometer wire requires a Kelvin bridge set up, which for commercial work is not altogether desirable. The cooling effect due to different air velocities depends on the temperature difference between the wire and the gas and the total quantity or mass of gas passing the wire per unit time. Since the temperature of the wire is maintained constant, the effect observed in the change in the heating current for a given change in air velocity is a measure of the difference between the gas flow in the two cases. Such an anemometer, therefore, measures the average gas flow for a length depending on the distance between the two resistance leads. Therefore the instrument in the form used thus far is not very satisfactory for measuring gas velocities in small tubes or in places where the velocity varies rapidly across the line of flow.

For the purpose of measuring gas flow through relatively small tubes, where the velocity changes rather rapidly across the tube, the hot-wire anemometer has been modified in the manner shown diagrammatically in Fig. 1. It consists essentially of a platinum heating wire *H* about 0.007 in. (0.178 mm.) in diameter and  $\frac{1}{2}$  to 1 in. (12.7 to 25.4 mm.) long stretched across a suitable framework, say of glass. This wire has attached at its mid-point a copper-constantan thermocouple made of 0.002-in. (0.05 mm.) wire, *C*, *A*.

\* Research Physicist, Westinghouse Research Laboratory.

<sup>1</sup> L. V. King: *Phil. Trans. Roy. Soc. London* (1914) A 214, 373-432. *Proc. Roy. Soc., London* (1914) A 90, 563-570.

<sup>2</sup> A. E. Kennelly and H. S. Sanborn: *Proc. Amer. Phil. Soc.* (1914-15) 53, 55-77.



In using the instrument, it has been found quite satisfactory to measure the current necessary to maintain the temperature of the wire as determined by the thermocouple, say  $200^{\circ}\text{C}$ . above the temperature of gas in which it is placed. The temperature can be measured by means of a thermocouple potentiometer indicator, such as is sold by Leeds & Northrup. The current can be measured either by means of a first-class ammeter or by means of a standard resistance and potentiometer system.

This anemometer can be so arranged as to be placed in various positions in a tube of any size and still not interfere seriously with the air velocity. The heating wire can be coiled and occupy a relatively small area

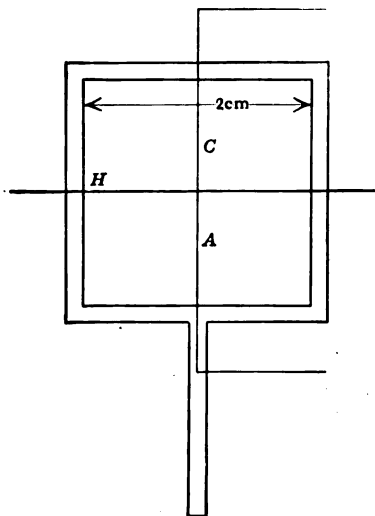

FIG. 1.—MODIFIED ARRANGEMENT OF HOT-WIRE ANEMOMETER.

or can be stretched straight, as indicated in the figure. By use of the thermocouple, the temperature of the gas at the point where the velocity is desired can be readily obtained when there is no current flowing through the wire. If direct current is used, the mean value of the readings obtained for current flowing in each direction should be used; this will avoid the possibility of any error arising due to the thermocouple wires not being at exactly the same point on the wire. By using alternating current for heating the wire, this error is also avoided.

The anemometer is calibrated in the way described by King<sup>3</sup> and Kennelly.<sup>4</sup> This can be done by having it on an arm that can be revolved at various speeds. A curve showing the relation between the speed of the wire through air at room temperature, about  $21^{\circ}\text{C}$ ., and the current necessary to maintain the thermocouple junction at a temperature of  $200^{\circ}\text{C}$ . is shown in Fig. 2.

<sup>3</sup> *Loc. cit.*

<sup>4</sup> *Loc. cit.*

The abscissas represent the velocity, in feet per minute, and the ordinates the corresponding currents, in amperes, necessary to maintain the temperature of the wire at 200° C. This curve was obtained by revolving the anemometer on an arm 4½ ft. (1.37 m.) long in a horizontal plane. Such a device does not give a very uniform swirl to the air. More recent work has been done by having the anemometer calibrated when it is on a revolving disk 2½ ft. (0.762 m.) in diameter. This gives a very uniform swirl to the air and hence it can be accurately corrected by revolving the disk when the anemometer is in a stationary position. The revolving disk can also be placed in an oven so that the anemometer can be calibrated in the air at various temperatures up to 100° C., at least, and possibly

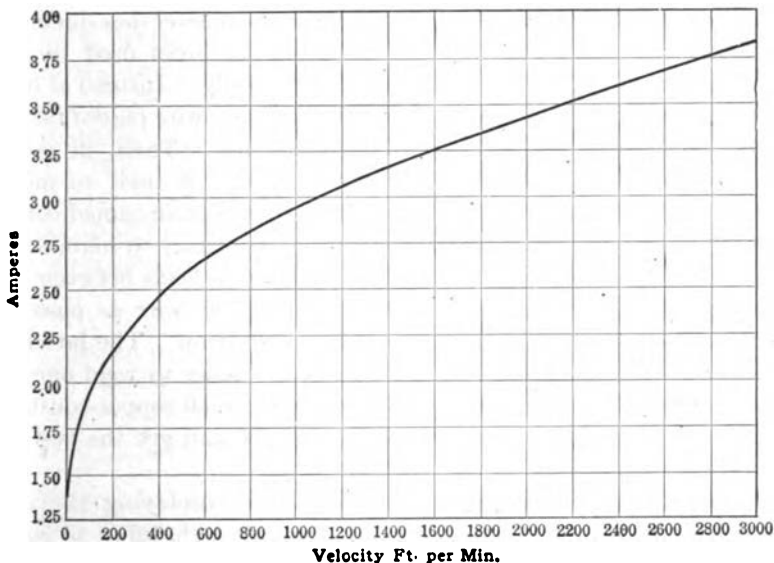

Fig. 2.—RELATION BETWEEN SPEED OF WIRE THROUGH AIR AT ROOM TEMPERATURE AND CURRENT NECESSARY TO MAINTAIN THERMOCOUPLE FUNCTION AT 200° C.

200° C. Such an anemometer has the advantage of really measuring the total gas flow at a point and at the same time is useful in measuring the gas flow in places where the temperature as well as the velocity of the gas is changing from point to point. Such cases would exist, for example, in a tube having a heater wound around it.

In the calibration of the anemometer, the current and thermocouple connections are made to the anemometer by means of slip rings and contact brushes on the revolving shaft. It was not found necessary to use low-resistance mercury contacts, as is the case when the resistance measurements are made by means of a Kelvin bridge, as was done by King and others. Occasional parasitic currents, due to imperfect brush contact and temperature changes, arose while calibrating, but they are

readily detected and eliminated by the method of reversals of current and by noting the thermocouple readings where the anemometer heating wire has no current through it. By the use of an accurate thermocouple potentiometer, for measuring the temperature of the wire and a potentiometer for measuring the heating current, very accurate velocity measurements can be obtained. In using this instrument, it is only necessary first of all to measure the temperature of the air by means of an attached thermocouple at the point in question before putting any heating current through the platinum wire, and then to measure accurately the current necessary to maintain the heating wire, say  $200^{\circ}\text{C}$ ., above that of the air in which it is placed. Then, by referring to the corresponding calibration curve, similar to the one shown in Fig. 2, the velocity is readily obtained.

In addition to the thermocouple-type of anemometer described, it has been found that a resistance type similar to the ones used by King, Kennelly, and others, can be used quite satisfactorily. Instead of having the leads for resistance measurements to the heating wire placed far apart (10 cm. or more) they are placed close together. Then, in calibrating and using the anemometer the potentiometer is used to measure the drop between the potential leads. This drop is maintained constant for all velocities and the values of the current necessary to maintain this potential-drop constant is observed. The potential leads between which the potential drop is measured should be of as fine wire as possible in order to avoid unnecessary loss of heat by conduction. The latter type is a little easier to construct, as it is somewhat easier to weld one small platinum wire to a larger one than it is to weld a small copper-constantan thermocouple junction to a larger platinum wire and get the two wires at exactly the same point on the platinum wire.

Complete details of the experimental results employing the use of these instruments in measuring the gas flow through tubes of various sizes and shapes will be given in a later paper.

#### SUMMARY

1. A hot-wire anemometer consisting of a small platinum heating wire and having a copper-constantan thermocouple attached at its mid-point has been developed and found to be useful in measuring the distribution of gas flow across small channels.

2. The same instrument can be used even though the temperature may vary from point to point across the channel.

3. A hot-wire anemometer of the usual type but which has the leads generally used for the resistance measurements placed quite close together has been found very satisfactory when it is used so that observations are made of the current necessary to maintain a definite drop between the potential leads for various velocities.

## High-temperature Thermometers

BY R. M. WILHELM,\* WASHINGTON, D. C.

(Chicago Meeting, September, 1919)

HIGH-TEMPERATURE thermometry, as treated in this paper, deals with the measurement of temperature in the range 100° to 550° C. The lower limit corresponds to the temperature of boiling water at normal atmospheric pressure, the upper limit is approximately the highest temperature to which a mercury-in-glass thermometer may be safely subjected.<sup>1</sup> In this range the domains of pyrometry and thermometry overlap somewhat, for high-temperature resistance thermometers and thermocouples generally classed as pyrometers are often used below 550° C. This paper will be confined to high-temperature mercurial thermometers, and indicating and recording thermometers of the vapor pressure, liquid or gas filled, and bimetallic or graphite-metal expansion types, a classification of which is as follows:

| CLASSIFICATION OF THERMOMETERS  |  |
|---------------------------------|--|
| GENERAL CLASSIFICATION          | SUBDIVISIONS   |
| Mercury-in-glass<br>(mercurial) | Laboratory — { Etched or engraved stems<br>Enclosed scale (Einschluss) |
|                                 | Industrial   |
| Indicating and<br>recording     | Pressure { Vapor pressure<br>Liquid filled<br>Gas filled               |
|                                 | Bimetallic   |
|                                 | Graphite-metal expansion   |
|                                 |  |

### HIGH-TEMPERATURE MERCURIAL THERMOMETERS

In the laboratory the so-called engraved or etched-stem thermometer is more generally used than the enclosed scale or "einschluss" type. For some classes of work, and especially under high-temperature conditions, the enclosed-scale thermometer has some advantages over the etched-scale type, in that the coloring matter in the graduation lines cannot be removed by solvents, the thermometer can be repaired if only

\* Associate Physicist, U. S. Bureau of Standards.

<sup>1</sup> Quartz glass thermometers filled with mercury under pressure have been constructed to measure temperatures up to 750° C.; they are not used in this country, however, except to a negligible extent. Reports as to their behavior have not been promising.

the outer tubing is broken, and parallax may be avoided by a simple procedure. The disadvantages, however, may offset the good features. The scale is liable to become loose, and this, as well as the failure of the scale and capillary tubing to be in close contact with each other, may introduce uncertain errors. The computation of the correction for emergent stem is also more unreliable by reason of the uncertainty as to the actual temperature inside the glass tubing of an enclosed-scale thermometer.

Fig. 1 shows characteristic types of etched-stem high-temperature laboratory thermometers. The first instrument *a* is the type used as a

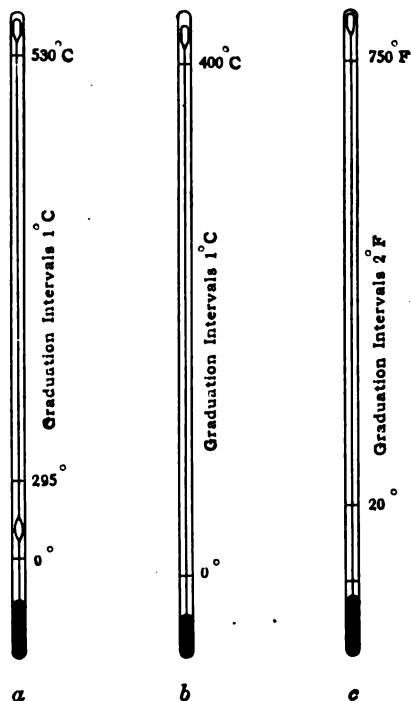

FIG. 1.—TYPES OF HIGH-TEMPERATURE MERCURY-IN-GLASS THERMOMETERS.

standard at the Bureau of Standards in the range 300° to 530° C. The second *b* is a continuous-scale instrument used for making distillation tests and graduated 0° to 400° C. in 1° for total immersion. The third *c* is a 20° to 750° F. thermometer divided into 2° intervals for partial immersion and is used in oil testing or other industrial work.

In the use of high-temperature thermometers, the ice-point graduation (0° C., 32° F.) is very desirable for checking purposes. If it is necessary to use a thermometer for partial immersion, that is with the bulb and only a part of the stem heated, it is advisable to use the continuous-

scale type *b* or *c* rather than the standard type *a*, especially if the enlargement in the capillary shown between the 0° and 295° marks projects into the air, which is much cooler than the bulb. Large and uncertain errors may be introduced by using a thermometer under these conditions.

It is not necessary or advisable to graduate thermometers to be used in the range 200° to 550° C. into intervals smaller than 1° or 2° C. The undesirability, except under unusual conditions, of specifying, for example, six thermometers graduated in 0.1° intervals with a scale range of 25° each to cover the range 200° to 350° C. instead of one instrument graduated into 1° or 0.5°, cannot be too strongly emphasized. These short-range thermometers are seldom provided with ice-point graduations for checking, and for this reason cannot be standardized to even as high a degree of accuracy as thermometers divided into 1° or 0.5° intervals. Very little is to be gained therefore by attempting to read these short-

TABLE 1.—Accuracy Data of Laboratory Thermometers

| Approximate Scale Range, Degrees | Subdivision, Degrees | Probable Accuracy of Unstandardized Thermometers, Degrees | Accuracy that May be Obtained if Thermometer is Standardized, Degrees |
|----------------------------------|----------------------|---|---|
| Centigrade Scale                 |                      |   |   |
| 100 to 200                       | 5                    | 2   | 1   |
| 100 to 200                       | 2                    | 1   | 0.5   |
| 100 to 200                       | 1                    | 1   | 0.2   |
| 100 to 200                       | 0.2 or 0.5           | 0.5   | 0.1   |
| 200 to 300                       | 5                    | 2   | 1   |
| 200 to 300                       | 2                    | 2   | 0.5   |
| 200 to 300                       | 0.5 or 1             | 1   | 0.2   |
| 300 to 400                       | 5                    | 3   | 2   |
| 300 to 400                       | 2                    | 3   | 1   |
| 300 to 400                       | 1                    | 2   | 0.5   |
| 400 to 500                       | 5                    | 5   | 2   |
| 400 to 500                       | 1 or 2               | 2   | 1   |
| Fahrenheit Scale                 |                      |   |   |
| 212 to 400                       | 5                    | 2   | 1   |
| 212 to 400                       | 2                    | 1   | 0.5   |
| 212 to 400                       | 0.5 or 1             | 1   | 0.2   |
| 400 to 600                       | 5                    | 2   | 1   |
| 400 to 600                       | 2                    | 2   | 0.5   |
| 400 to 600                       | 1                    | 1   | 0.2   |
| 600 to 800                       | 5                    | 3   | 2   |
| 600 to 800                       | 2                    | 2   | 1   |
| 800 to 1000                      | 5                    | 5   | 2   |
| 800 to 1000                      | 2                    | 4   | 2   |

scale instruments to 0.05 ° C. or 0.01° C. when the maximum obtainable accuracy is from 0.1° to 0.5° C.

Table 1 gives accuracy data for laboratory thermometers in the range 100° C. to 500° C., and 212° F. to 1000° F. This table was compiled for use at the Bureau of Standards, and is applicable only to thermometers of the laboratory type used under total-immersion conditions; *i.e.*, with bulb and stem containing the mercury column at the same temperature. The maximum errors allowed in the table represent the probable magnitude of the error that may be expected of the best grades of thermometers. This degree of accuracy cannot always be expected of cheaper grades of

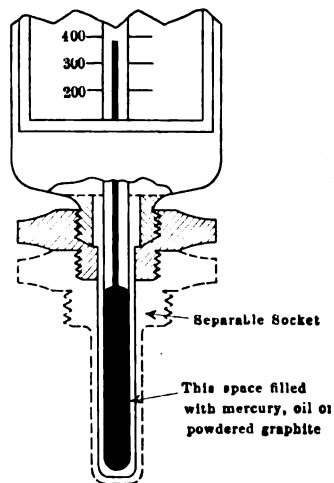

FIG. 2.—INDUSTRIAL TYPE OF MERCURY-IN-GLASS THERMOMETER.

thermometers, or of partial-immersion thermometers. The table emphasizes the necessity for obtaining and applying corrections to the readings of thermometers, especially if high accuracy is desired.

*Industrial Thermometers.*—The use of the chemical or laboratory type of mercurial thermometer is restricted, as the name implies, to the laboratory since unprotected glass thermometers are much too frail to withstand the rough usage of the plant and shop, and are comparatively difficult to read as well.

There has, therefore, been developed what is generally known as the industrial type of mercurial thermometer. As shown in Fig. 2, it is characterized by a heavy metal back and protecting tube for the bulb, large and distinct figures and graduation marks, and threaded connections for attaching the instrument firmly and quickly to some part of the apparatus. This general design is used for instruments for many different operations,

covering ranges of temperature from  $-40^{\circ}$  to  $1000^{\circ}$  F. The instruments necessarily must be graduated and standardized for the condition of use, that is for partial immersion of the mercury column.

It will be noted, from the cross-section view of the bulb and protecting case of the industrial thermometer, that the bulb does not come into direct contact with the substance the temperature of which is to be measured and that the bulb is surrounded by large metal parts which extend into a region that has a temperature different from that of the bulb. These two peculiarities must be taken into consideration in the use of these thermometers. Since the bulb is not in direct contact with the heated substance, the time that it requires to take up changes in temperatures is greater than that necessary for a bare bulb. This "lag," as it is called, can be reduced by filling the space between the bulb and the outer wall of the casing with a good conducting medium. The most satisfactory substance to use for temperatures below  $200^{\circ}$  C. is mercury. Experiments made at the Bureau have demonstrated that the lag of an instrument read in steam at  $100^{\circ}$  C. with mercury surrounding the bulb was one-half to one-third as great as when powdered graphite, oil, or air was used. Obviously mercury cannot be used at the higher temperatures, and heavy oils are usually substituted.

This lag, however, may not be as great a source of error as the actual variance that may be noted in the readings of these thermometers when used to measure the same temperature, but under varying conditions, as regards construction of the protecting case surrounding the bulb, the material into which the bulb is immersed, *i.e.*, whether liquid, vapor, or gas, the rate of flow of the material past the bulb, and the exterior conditions surrounding the protecting stem. These variations can be understood by an examination of the construction of the thermometer and an analysis of the means whereby the heat is either conducted to the bulb of the instrument or is lost by conduction to the air by way of the heavy metal parts. There are no published results of reliable investigations regarding the magnitude of the influence of all of these factors.

If industrial thermometers are used to indicate only changes in the temperature of a process and not to give actual temperatures, it may not be necessary to consider the various sources of error enumerated. But these instruments cannot be depended on to give reliable indications of true temperatures unless they are calibrated or standardized under the same condition as that of use, and after being put in use these conditions must not be changed.

*Emergent-stem Error of Mercury-in-Glass Thermometers.*—In discussing the sources of error and precautions to be observed in the use of high-temperature mercurial thermometers, especially of the laboratory type, the question of emergent-stem error is perhaps of first importance. It is common practice to graduate and standardize thermometers for the



condition that the bulb and the part of the stem containing the mercury are at the same temperature. This process is called graduation and standardization for total immersion. It is necessary to adopt such a practice, for the exact conditions of immersion to which a thermometer will be subjected are not generally known. Some manufacturers point part of their stock thermometers for other conditions of immersion, such as 3 in., claiming that this condition has a wider application than that of total immersion. For lower ranges in temperature (below 100° C.) this method of pointing may have some advantages, and can introduce but a small error. For higher temperatures, it would seem undesirable to adopt a 3-in. immersion for a standard condition.

In the actual use of a thermometer, it is quite often impossible to observe the conditions of total immersion of the mercury column, and many instruments must be used with the bulb only, or the bulb and a very small part of the stem heated. The remainder of the stem, containing the mercury column, is usually at a temperature considerably lower than the bulb, and the original calibration of the instrument, if for total immersion, will not hold. The thermometer reads too low under these conditions. It is always possible to compute the approximate correction to apply to the reading to reduce it to standard conditions by means of the formula<sup>2</sup>

$$S = an (T - t)$$

where  $S$  = correction to be applied to reading;  $a$  = factor representing relative expansion of mercury in glass;  $n$  = number of degrees of mercury emergent from bath;  $T$  = temperature of the bulb or bath;  $t$  = average temperature of emergent mercury column. Of these factors,  $a$  can be taken to be 0.00016 for centigrade temperatures or 0.00009 for Fahrenheit. The value of  $n$  is observed.  $T$  can be approximated by using the reading of the thermometer and if a higher degree of accuracy is desired, a second approximation can be made by adding the correction first found to the reading and using this value for  $T$  to obtain a second correction. The value of  $t$  is most difficult to secure accurately, but it can be taken to be approximately the reading given by an auxiliary thermometer, the bulb of which is placed about three-fourths the way down the exposed mercury thread. A more accurate method for obtaining  $t$  is to use what is known as a "faden" or thread thermometer. This thermometer, which is designed to give the average temperature of a given length of mercury column, is indispensable to the testing laboratory where accurate determinations of stem corrections must be made. The

---

<sup>2</sup> E. Rimbach [*Zeit. Inst.* (1890) 10, 153, 292] gives stem-correction tables, which have been widely published. Their application is limited, however, as the data were obtained by using special thermometers in distillation apparatus.

theory of stem correction and the use of faden thermometers are discussed more in detail in a paper by Buckingham.<sup>3</sup>

For the processes in which the immersion of the thermometer is definitely known, thermometers can be previously graduated for the required immersion. It should be understood that partial-immersion thermometers are subject to error unless the conditions under which the thermometer is used exactly correspond to those of pointing or standardization. Thus, changes in the room temperature or temperature conditions surrounding the stem may introduce errors of several degrees. However, when a high degree of accuracy is not desired, it is probably more satisfactory to use these partial-immersion instruments than to attempt a stem correction with a total-immersion thermometer. Thermometers so graduated should be marked preferably with a ring around the stem indicating the depth of immersion and also with a statement to this effect on the stem. It can be assumed generally that the thermometers not so definitely marked will give erroneous results if used other than total immersion.

A few tests in which thermometers are used under partial-immersion conditions have been investigated at the Bureau of Standards and stem correction data obtained. The results are given in Tables 2 to 4. The

TABLE 2.—*Stem Correction Data for Cleveland Open-cup Flash and Fire-point Tester. Thermometer Range  $-20^{\circ}$  to  $760^{\circ}$  F. in  $2^{\circ}$  Intervals, Length About 15 In.*

| Reading<br>Degrees F. | Degrees Mercury<br>Column Emergent,<br>Degrees F. | Mean Temperature<br>of Emergent Mercury<br>Column, Degrees F. | Stem Correction,<br>Degrees F. |
|-----------------------|---|---|--------------------------------|
| 200                   | 208   | 174   | 0.5                            |
| 300                   | 308   | 177   | 3.5                            |
| 400                   | 408   | 177   | 8.5                            |
| 500                   | 508   | 187   | 15.0                           |
| 600                   | 608   | 203   | 23.0                           |

diameter of the bulb of the flask used in the experiments, the results of which are given in Table 3, was 8 cm., diameter neck 2 cm., height of neck 15 cm., distance of bottom of outlet tube to top 8 cm. The thermometer range was  $0^{\circ}$  to  $400^{\circ}$  C., in  $1^{\circ}$  intervals, the length of the thermometer was 40 cm. The thermometer used for obtaining the results given in Table 4, up to  $150^{\circ}$  C., was graduated from  $40^{\circ}$  to  $160^{\circ}$  C. in  $1^{\circ}$  intervals and had a scale length of 9.5 cm. The thermometer used from  $200^{\circ}$  to  $300^{\circ}$  had a range from  $200^{\circ}$  to  $360^{\circ}$  in  $1^{\circ}$  intervals and had a scale length of 12 cm. It can be seen, from these tables, that if the thermometers had been graduated for total immersion, appreciable errors would have

<sup>3</sup> U. S. Bureau of Standards *Sci. Paper* 170 (1911).

TABLE 3.—*Stem Correction Data for Distillation Flask Used in Distillation of Creosote Oil*<sup>4</sup>

| Reading<br>Degrees C. | Degrees of Mercury<br>Column Above Bulb,<br>Degrees C. | Mean Temperature<br>of Mercury Column,<br>Degrees C. | Stem Correction,<br>Degrees C. |
|-----------------------|--|--|--------------------------------|
| 200                   | 208  | 59   | 4.7                            |
| 250                   | 258  | 111  | 6.0                            |
| 300                   | 308  | 98   | 10.5                           |
| 350                   | 358  | 95   | 15.5                           |

TABLE 4.—*Stem Correction Data for Pensky-Martin Flash-point Apparatus*

| Reading<br>Degrees C. | Degrees of Mercury<br>Column Emergent,<br>Degrees C. | Mean Temperature<br>of Emergent Mercury<br>Column, Degrees C. | Stem Correction,<br>Degrees C. |
|-----------------------|--|---|--------------------------------|
| 50                    | 30   | 35  | 0.1                            |
| 100                   | 80   | 45  | 0.7                            |
| 150                   | 130  | 55  | 2.0                            |
| 200                   | 10   | 75  | 0.2                            |
| 250                   | 60   | 85  | 1.6                            |
| 300                   | 110  | 100   | 3.5                            |

been introduced, if the stem correction had been neglected. Empirical methods are sometimes used for certain more or less standard operations, such as distillation, in which a total-immersion thermometer is specified to be used without regard to the emergent-stem correction.

*Other Sources of Error in Use of High-temperature Mercurial Thermometers.*—Aside from the error that may be introduced in the use of high-temperature mercurial thermometers by a failure to observe the proper condition of immersion, there are two common sources of error that can be attributed to actual defects in the manufacture of the instrument. These are, first, insufficient pressure above the mercury to prevent breaking of the mercury column, or evaporation at the surface of the mercury and, second, improper or insufficient annealing for use at high temperatures. This latter defect may result in a rise of the reading with continued heating amounting to as much as 20° C. in extreme cases.

Mercury boils at approximately 357° C. and evaporates fairly rapidly at much lower temperatures. Experiments have shown that even for use above 100° C. the filling under pressure of that part of the capillary above the column with an inert gas, such as nitrogen, is desirable. The amount of pressure that must exist above the surface of the mercury to prevent evaporation or breaking of the mercury column varies with the temperature and the construction of the upper portion of the stem. This

<sup>4</sup> See Wilhelm: U. S. Bureau of Standards *Tech. Paper* 49 (1915).

pressure may be anywhere from two to twenty atmospheres. The failure to fill high-temperature thermometers under the proper pressure is often the cause of large errors. This defect can be detected, sometimes, by the broken appearance of the mercury column, and by drops of mercury that have distilled from the top, but often the column breaks in a part of the stem not visible, and the defect is not detected.

Improper annealing can be detected only by the checking of the indications of the instruments from time to time. Laboratories usually have facilities for checking the readings either in melting ice or in steam, or perhaps comparing the thermometers from time to time with a thermometer known to give reliable readings.

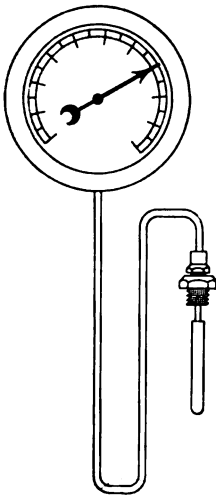

FIG. 3.—DISTANCE READING INDICATING THERMOMETER.

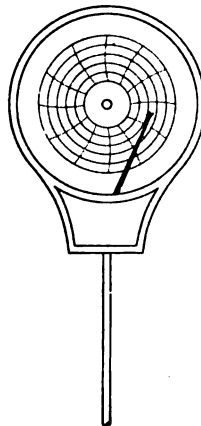

FIG. 4.—RECORDING THERMOMETER.

### INDICATING AND RECORDING THERMOMETERS

The term "indicating" is usually employed to designate thermometers of the dial and pointer type, rather than those constructed of mercury and glass. Indicating thermometers may or may not be distance reading, that is, so constructed as to allow the indicator to be placed at some distance from the bulb. A distance-reading indicating thermometer is shown in Fig. 3. A recording thermometer, as the name indicates, employs a mechanism for making a continuous record of temperatures on a suitable chart, as shown in Fig. 4.

Indicating and recording thermometers may be divided into three general classes, electrical, pressure, and bimetallic. Electrical thermometers are generally classed as pyrometers and will not be discussed here. Pressure thermometers comprise a bulb containing a liquid or gas or both connected by means of capillary tubing to some form of pressure

**gage.** Bimetallic thermometers utilize the turning force produced when a strip consisting of two metals having different coefficients of expansion and brazed to each other is heated. Graphite-metal thermometers indicate temperatures as a result of the relatively large difference in thermal expansion of these two substances. Although of simple construction, the accuracy and adaptability of these types of instruments have not been sufficiently investigated to allow a more detailed discussion of them here.

*Pressure Thermometers.*—Pressure thermometers may be subdivided under vapor pressure, liquid-filled, and gas-filled. From outward appearance, vapor-pressure thermometers may be distinguished from liquid- or gas-filled thermometers by the form of the temperature scales, since the change in vapor pressure, with respect to temperatures, is not linear but increases as the temperature rises. Vapor-pressure thermometers thus have an unequally divided scale, the length of the intervals for a given number of degrees increasing with increasing temperatures. Liquid- and gas-filled instruments have equally divided scales, since their action is based on thermal expansion which is approximately linear with respect to temperature. The bulbs, capillary tubing, and form of pressure gage of any one type may be identical in outward appearance to that of any other.

*Liquids Used in Vapor-pressure Thermometers.*—The volatile liquid used in a vapor-pressure thermometer must possess certain well-defined characteristics. It should be stable, readily obtained, and purified, and should not act upon the metals with which it will be in contact. It must have a sufficiently high pressure at the lower temperatures to which it will be subjected to insure a readable temperature scale, and its critical temperature must be higher than the highest temperature to be measured.

The vapor pressures of the liquids available for use in vapor-pressure thermometers have been determined over wide ranges and it is usually possible, by making use of the data found in the literature on the subject, to select the most suitable liquid for a given range of temperature; or if a liquid is given, to predict the temperature range within which it can be used and the pressures that will be developed. In general, the temperature and pressure range for a given liquid will be included between its boiling point at a pressure of one atmosphere, and its critical temperature. Although these limits are very arbitrary, they are convenient for reference.

Table 5 gives the boiling points, at a pressure of one atmosphere, and the critical temperatures and pressures for various liquids suggested for use in vapor-pressure thermometers.

*Liquids and Gases Used and Pressures in Liquid- and Gas-filled Thermometers.*—The liquids used in liquid-filled thermometers do not need to possess such definite characteristics as those used in vapor-pressure thermometers. It is obvious that pure liquids are to be desired, that

TABLE 5.—*Boiling Points and Critical Data of Liquids Suggested for Use in Vapor-pressure Thermometers*

| Substance          | Boiling Point,<br>Degrees C. | Critical<br>Temperature,<br>Degrees C. | Critical<br>Pressure,<br>Atmospheres |
|--------------------|------------------------------|--|--------------------------------------|
| Ethyl alcohol..... | 80                           | 243                                    | 63                                   |
| Benzine.....       | 80                           | 288                                    | 48                                   |
| Water.....         | 100                          | 365                                    | 195                                  |
| Toluene.....       | 111                          | 320                                    |                                      |
| Aniline.....       | 184                          | 426                                    | 52                                   |

they should not react chemically upon the metals with which they come in contact, and that the highest temperature to which they are to be subjected should not exceed their critical temperature. Alcohol, which has been used in liquid-filled thermometers for lower temperatures would not be satisfactory for temperatures much above 200° C. Aniline has been suggested for temperatures as high as 400° C. Mercury is used almost exclusively in this country in liquid-filled thermometers reading up to 1000° F.

Any inert gas could be used to fill gas-filled thermometers, but nitrogen has been preferred in this country. Gas-filled thermometers are not used in general above 1000° F., since the metal bulbs become permeable to the gas at high temperatures.

The initial pressure and the pressure range of a liquid- or gas-filled thermometer will vary according to the strength of the gage used and the temperature range. The initial pressure is made relatively high (10 or 15 atmospheres).

*Principles Underlying Action of Pressure Thermometers.*—The action of the vapor-pressure thermometer depends on the fact that the pressure inside the thermometer is determined solely by the temperature of the free surface of the liquid. It follows, therefore, that the thermometer must be so constructed that one free surface is always in the bulb. If this condition is fulfilled the reading of the instrument will not be sensibly affected by changes in the temperature of the gage and capillary. This is a decided advantage over other types, if the connecting tubing and gage are both to be subjected to considerable changes in temperature. If the vapor-pressure thermometer is not filled properly (*i.e.*, the proportion of liquid is too great or too small as compared with the volume of the bulb, capillary and gage) very large and uncertain errors may be introduced. As an example, take the condition met with in the use of high-temperature vapor-pressure thermometers. The bulb is usually much hotter than the capillary and is filled, or nearly filled, with vapor. The liquid is condensed in the capillary and there should be sufficient liquid in the capillary to entirely fill it and partly fill the bulb. If the liquid only partly fills the capillary and there is no liquid in the bulb, the

capillary will contain the free surface of the liquid and the temperature indicated will be that of the portion of the capillary containing the free surface of the liquid, as shown in Fig. 5. This temperature, which may be several hundred degrees lower than that of the bulb, will be indicated instead of the true temperature of the bulb.

It is desirable to use capillary tubing of as small a bore as possible for vapor-pressure thermometers, for the smaller the volume of the capillary and gage the smaller is the required volume of the bulb, since the combined volume of the capillary and gage must be less than that of the bulb.<sup>5</sup>

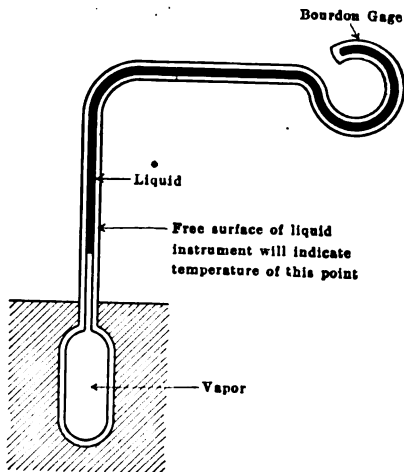

FIG. 5.—VAPOR-PRESSURE THERMOMETER WITH INSUFFICIENT LIQUID. BULB HOTTER THAN TUBING AND GAGE.

Gas- and liquid-filled thermometers operate on the principle of thermal expansion. They are entirely filled with either the liquid or the gas. The expansion of the liquid or gas in the bulb is transmitted through capillary tubing to the pressure gage. These instruments are subject to error if the gage and capillary are heated or cooled to temperatures differing from those under which they were calibrated. This error may be made negligible, in many instances, by reducing the volume of the capillary and gage as compared with that of the bulb, or by using a compensator in the head. Such a compensator, however, will not eliminate errors due to the heating or cooling of the capillary alone.

*Accuracy of Pressure Thermometers.*—On account of the mechanical construction of pressure thermometers, both as regards the mechanism for indicating and recording and the necessity for using comparatively large and heavy bulbs, the accuracy that can be secured with this type of thermometer is lower than that generally obtained with mercury in glass thermometers.

<sup>5</sup> This requirement is not necessary if the bulb is at all times hotter than the capillary and gage.

## TESTING HIGH-TEMPERATURE THERMOMETERS

The testing of high-temperature thermometers for scale errors involves, primarily, either the comparison of the test thermometer with standard thermometers at various temperatures in suitably designed comparators, or the reading of the thermometers in the vapors of various boiling liquids. The 100° point may thus be checked in an apparatus known as a hypsometer or steam-point apparatus, which provides for the immersion of the thermometers directly in the vapor of boiling water. Thermometers may also be tested in the vapors of naphthalene, benzophenone, anthracene, and sulfur, the boiling points of which are 218°, 306°, 340°, and 444.6° C., respectively. The boiling-point method of testing is less frequently used than the comparison method, and is, in general, less convenient and subject to greater errors than the latter.

For testing in the range 100° to 320°, an electrically heated oil bath is most convenient to use. This bath should be well stirred to give a uniform distribution of temperature. The thermometers are immersed directly in the oil.

For obtaining higher temperatures than those that can be secured in the oil bath, two different types of comparators have been designed and used at the Bureau of Standards. One of these, which has been in use up to very recently, is an electrically heated stirred air bath. The air is rapidly circulated around a block of copper, into which holes were drilled for insertion of the thermometers. Two heating coils are used, one of which is wound around the cylinder in which the air circulates, the other is wound horizontally on an asbestos plate covering the top. By means of a differential thermocouple, of which one junction is placed near the bottom of the bath, the other at the top, the difference in temperature between the top and the bottom of the bath can be observed and this difference can be reduced to a minimum by regulating the amount of energy supplied to either the upper or the lower coil.

The latest type of bath designed for high temperatures up to 550° C. uses molten lead or tin as a comparison liquid. This bath is constructed of iron throughout and contains a stirrer for circulating the molten metal. The thermometers are inserted in thin steel tubes closed at the bottom and immersed in the liquid. This molten metal bath has proved, from many standpoints, more satisfactory for testing than the air bath. It can be heated and regulated more rapidly, has a more uniform temperature distribution, and possesses less vibration than the air bath.

*Precautions to be Observed in Testing High-temperature Thermometers.*—It is not possible to read thermometers totally immersed in the comparators mentioned, and since the stem-correction error becomes larger with increasing temperatures, every precaution must be taken to eliminate this error or to compute it accurately. This error is made



negligible if both standard and test thermometers have the same dimensions and the same number of degrees of mercury column emergent when tested. It is seldom possible to fulfill these conditions, however, since the standard and the test thermometers usually have different dimensions, and hence it is necessary to compute stem corrections for both unless the latter are to be standardized for partial immersion. Thermometers graduated for short lengths of immersion, as for example 1 or 2 in., should not be tested immersed to these short lengths on account of the uncertainty as to the temperature of the top part of the baths. Such thermometers are usually tested immersed to a greater length and a correction computed to allow for the difference in reading due to the fact that part of the mercury column is at a higher temperature than it would be in use.

In testing high-temperature thermometers, it should be borne in mind that the observed variations from standard readings will not remain constant if the glass of which the bulb is made was not properly annealed. Even the best-made thermometers change with time and on continued heating. As a result, the correction observed for a thermometer at a given temperature will not hold if the bulb contracts at a higher temperature. If the thermometer is so graduated that it can be read in ice or steam, the amount that the readings have changed can be easily observed by taking check readings in ice or steam directly after reading at the higher temperature. From the results of these observations, allowance can be made for changes that may have taken place, due to a contraction of the bulb. Where no ice point is provided, it is advisable to test the highest point first and the lower points afterward.

If a preliminary test of a thermometer shows that a considerable change in the readings occurs with moderate heating, it is advisable to subject the thermometer to an annealing test, which may be made in an electrically heated annealing oven. The construction of this oven and instructions as to annealing are given in a paper by Dickinson.<sup>6</sup>

This brief description of the testing of high-temperature thermometers pertains more especially to laboratory thermometers of the etched-scale or enclosed-scale types. The comparators mentioned were designed with the view of obtaining the highest attainable precision. These comparators are sometimes used to test industrial thermometers and the other types of high-temperature instruments mentioned in this article. In many instances, however, they do not reproduce conditions of use sufficiently well for testing certain types of thermometers designed for special purposes, such as the measurement of the temperature of gases or superheated steam, and special testing apparatus must, therefore, be built.

---

<sup>6</sup> U. S. Bureau of Standards *Sci. Paper* 32 (1906).

DISCUSSION

A. O. ASHMAN, Palmerton, Pa. (written discussion\*).—Owing to the conflict of the terms thermometry and pyrometry, in numerous cases the entire field of temperature measurements has been divided under these two headings. This confusion is probably due to the fact that originally a pyrometer was understood to be an instrument for measuring temperatures above the range of a mercury thermometer. In modern practice, however, pyrometers are not only used to measure the temperature over the range of the thermometer, but also to a much lower temperature, thereby eliminating the basis of the earlier division. It seems that the modern meaning of the term pyrometry is understood to include the entire field of temperature measurements, of which thermometry is one subdivision. The fact that this paper is presented at a pyrometer symposium would bear out this fact.

The following, I believe, gives the modern idea of the divisions of pyrometry, and shows the relation of thermometry to pyrometry:

- |                                    |                                     |
|------------------------------------|-------------------------------------|
| 1. Expansion pyrometry:            | 4. Optical pyrometry                |
| (a) Expansion of gases,            | 5. Radiation pyrometry              |
| (b) Expansion of liquids,          | 6. Calorimetric pyrometry           |
| (c) Expansion of solids.           | 7. Melting point pyrometry          |
| 2. Thermoelectric pyrometry        | 8. Transpiration pyrometry          |
| 3. Electrical resistance pyrometry | 9. Miscellaneous pyrometric methods |

R. M. WILHELM (author's reply to discussion†).—Although certain types of pyrometers may be used to measure temperatures below the upper range of the mercurial thermometer, it would hardly seem advisable or logical to make so radical a change as Mr. Ashman suggests in the nomenclature of the subject.

---

\* Received Sept. 25, 1919.

† Received Jan. 19, 1920.

### Porcelain for Pyrometric Purposes\*

BY FRANK H. RIDDLE,† PITTSBURGH, PA.

(Chicago Meeting, September, 1919)

THE life of thermocouples is governed, to a large extent, by the protection they receive when in use; particularly when the temperatures being measured are high and the products of combustion are reducing in character. Several types of protection tubes are being used for this work; they are made of ordinary and aluminous porcelain, fused quartz, carborundum, fused alumina, fireclay, and some kinds of metal. All of them may render good service under certain conditions but they must be used for the purpose for which they are intended. For example, fused-quartz tubes are very good when excessive changes in temperature occur, but under certain conditions they will crystallize and lose their strength.

Porcelain is used in several ways in connection with the use of thermocouples: for insulating the two wires of the couple and to prevent short circuits; for protecting the entire couple in a refractory gas-tight tube, which is ordinarily fastened to and is considered part of a properly equipped thermocouple; and for protecting the complete thermocouple from the possibility of physical injury and to support it. This tube is made porous and strong and is ordinarily built right into the wall or crown of the furnace, as the case may be.

The insulating tubes must be small and sufficiently refractory to withstand the temperatures at which they are to be used. The length of the tubes, porosity of the material from which they are made, etc. does not particularly matter. The tubes are sometimes made with two or even four holes, the latter being used where it is desirable to have two couples as close together as possible for calibration work.

The thermocouple protection tube must be of proper size to permit the thermoelements and insulating tubes to be inserted or taken out easily. It must be porous enough to withstand sudden changes in temperature and yet gas-tight, as well as refractory enough to withstand the furnace temperature, even if the tube protrudes into the furnace in a horizontal position without support for a reasonable distance. If the tubes are dense enough to be gas-tight, they do not require glazing but are not so resistant to temperature changes as the porous tubes.

The protection tubes for the noble metals are normally about  $\frac{1}{2}$  in.

\* Published by permission of Director, U. S. Bureau of Standards.

† Chemist, Clay Products Division, U. S. Bureau of Standards.

(12 mm.) inside diameter, have  $\frac{1}{8}$ -in. (3.17-mm.) walls, are closed at one end, and flanged at the other. Their length varies from one to several feet. For base elements, the tubes are usually 1 in. inside diameter, otherwise the same as for the noble metals. Glazed Marquardt mass tubes are commonly employed for the noble elements and ordinary unglazed vitreous porcelain for the base elements.

The outer protection tubes must be refractory and preferably porous. They are usually rather heavy walled and closed on the exposed end. Their inside diameter is great enough to permit the thermocouple protection tube to go in and out with ease. The walls are usually  $\frac{1}{2}$  in. or more in thickness. Alundum and carborundum make excellent tubes for this purpose for high temperatures. Sillimanite is also a good material. Fireclay bodies are not so good but satisfactory for temperatures equivalent to the fusing temperature of cone 10 or less.

As with a good many other products, a shortage of pyrometer tubes was felt shortly after the outbreak of the war, when importations were cut off. After the shortage was overcome, the quality of the product was soon made practically equal to that of Germany. As conditions are at present, there is no reason why it should be necessary to resume the importation of pyrometer tubes.

### MARQUARDT MASS BODY NO. 1

About 4 years ago the Bureau of Standards, in its Clay Products Laboratory, at Pittsburgh, Pa., undertook the duplication of the Marquardt mass tubes.<sup>1</sup> The body composition adopted was as follows:

| BODY                       | PER CENT. | CALCINE NO. 1             | PER CENT. |
|----------------------------|-----------|---------------------------|-----------|
| Calcine No. 1.....         | 45.7      | Calcined alumina.....     | 70.0      |
| Calcine No. 2.....         | 7.3       | North Carolina kaolin.... | 22.0      |
| North Carolina kaolin....  | 17.0      | Potash feldspar.....      | 8.0       |
| Florida kaolin.....        | 5.0       |                           | <hr/>     |
|                            |           |                           | 100.0     |
|                            |           | CALCINE NO. 2             |           |
| Tennessee ball clay No. 5. | 15.0      | Potash feldspar.....      | 64.0      |
| English china clay.....    | 10.0      | Calcined alumina.....     | 36.0      |
|                            | <hr/>     |                           | <hr/>     |
|                            | 100.0     |                           | 100.0     |

Each calcine mixture is ground dry in a ball mill, to insure thorough mixing of the materials. It is then tempered with water to the consistency of a very thick paste and molded, by hand, into balls about  $1\frac{1}{4}$  in. (3.17 cm.) in diameter. An alternate method is to grind the mixture in

<sup>1</sup> W. L. Howat: *Manufacture of Porcelain Pyrometer Tubes*. *Trans. Am. Cer. Soc.* (1916) **18**, 268.

F. H. Riddle: *Marquardt Porcelain*. *Trans. Am. Cer. Soc.* (1917) **19**, 397.

a ball mill in the wet state, having sufficient water to make a creamy slip. When ground sufficiently, the slip is run through a fine silk lawn and filter pressed until sufficient water has been eliminated to permit forming the body. It is then wedged until homogeneous and made into balls as before. The thoroughly dried balls are then placed in a kiln and calcined to a temperature equivalent to the fusing point of Orton pyrometric cone 20. This, at the time-temperature rate used in our case, is about 1525° C. At this temperature calcine No. 2 will fuse sufficiently to allow the balls of the material to flatten out of shape and stick together; calcine No. 1 has the shrinkage well taken out of it but it does not vitrify. The calcined materials are then crushed until sufficiently fine for ball milling. This pebble-mill grinding is continued until the powder is fine enough to pass dry through a lawn with 120 meshes to the square inch.

The body is prepared by ball milling the calcines and raw materials in the proper proportion in the wet state, screening them through a 120-mesh lawn, passing them over a magnetic separator, and then filter pressing. The body is then in the proper condition for manufacture.

#### MARQUARDT MASS BODY No. 2

For particularly high temperatures, it is advantageous to eliminate calcine No. 2 from the mixture and to use only calcine No. 1. This gives a body of the composition

|                                | PER CENT. |
|--------------------------------|-----------|
| Calcine No. 1.....             | 53.0      |
| North Carolina kaolin.....     | 17.0      |
| Florida kaolin.....            | 5.0       |
| Tennessee ball clay No. 5..... | 15.0      |
| English china clay.....        | 10.0      |
|                                | <hr/>     |
|                                | 100.0     |

Calcine No. 1 is the same as is used in Marquardt mass body No. 1. Tubes of this refractory quality, as stated, are necessary only in extreme cases, considered from the ceramic standpoint. In making these tubes, if the product is to hold its shape in use, it must be burned in manufacture to a point at which the shrinkage is eliminated as much as possible.

Both Marquardt mass bodies are porous at the burning temperature used and are dependent on the glaze to make them gas-tight. They have, however, the excellent quality of being able to resist reasonable changes in temperature. If care is used, it is possible to safely insert a cold tube into a furnace heated at 1500° C. in a few minutes time.

ORDINARY PORCELAIN TUBES

These tubes are not as refractory as Marquardt or sillimanite tubes but are good at low temperatures where the temperature changes are not too great. However, they should be supported if inserted horizontally into furnaces far enough to project. Tubes of this sort are vitrified and so are not dependent on a glaze to make them gas-tight. This eliminates the possibility of the tube sticking where in contact. They are also cheaper to manufacture. Numerous compositions may be used for this purpose; two that are satisfactory are:

|                                | No. 1.<br>PER CENT. | No. 2.<br>PER CENT. |
|--------------------------------|---------------------|---------------------|
| Potash feldspar.....           | 18                  | 12                  |
| Flint.....                     | 32                  | 38                  |
| North Carolina kaolin.....     | 30                  | 25                  |
| Florida kaolin.....            | 8                   | 8                   |
| Tennessee ball clay No. 5..... | 12                  | 17                  |
|                                | 100                 | 100                 |

These bodies are prepared in a similar manner to the Marquardt bodies; that is, by pebble milling, screening, passing over the magnetic separator, and filter pressing.

SILLIMANITE TUBES

As is well known, pure dehydrated kaolin,  $Al_2O_3 \cdot 2SiO_2$ , has a melting temperature of about  $1750^\circ C. \pm$  while sillimanite  $Al_2O_3 \cdot SiO_2$  has a well-defined melting point of  $1816^\circ C. \pm$ , which makes it useful for temperature measurements around the melting point of kaolins. Tubes of this sort are difficult to glaze or vitrify except by the use of very high temperatures of firing. For this reason they are usually not gas-tight. The material is useful, however, for Arsem furnace tubes and particularly good for outer protection tubes. The coefficient of thermal expansion of sillimanite is very low and uniform, as compared with that of clay, which is greater and variable at the different temperatures. The addition of free silica (flint) increases the coefficient and causes it to be variable at different temperatures. A workable mixture is as follows:

|                          | PER CENT. | CALCINE No. 1         | PER CENT. |
|--------------------------|-----------|-----------------------|-----------|
| Calcine No. 1.....       | 68.3      | Calcined alumina..... | 28.33     |
| Georgia kaolin.....      | 21.2      | Florida kaolin.....   | 71.67     |
| Tennessee ball clay..... | 10.5      |                       | 100.00    |
|                          | 100.0     |                       |           |

The calcine is prepared in the same manner as the Marquardt mass calcines and burned to cone 20. The longer this temperature can be held in the burning, or the oftener the calcine can be burned, the better the conversion.

MANUFACTURE OF TUBES BY PRESSING

It is possible to make all sizes of tubes from 2 mm. outside diameter by 0.6 mm. inside diameter up to practically any size desired by this method. We have not made tubes more than 15 mm. outside diameter. The machine used is a miniature hydraulic press built similar to a sewer-pipe press. The water cylinder is 8 in. (20 cm.) in diameter, the clay cylinder is  $3\frac{1}{2}$  in. (8.9 cm.) in diameter and the stroke is 10 in. (25 cm.). All dies are made of brass and accurately finished. The water pressure used to operate the press is 80 lb. to the sq. in. This machine works well and makes very dense tubes. The troubles encountered are the ordinary ones that would be expected with a machine of this type; viz., necessity of maintaining absolute water content and uniform pugging to prevent clay running faster on one side of the die than on the other. Ring cracks also form at the point of the die when the column is held so as to throw back the plunger to recharge the clay cylinder. The longer the stroke, consequently, the fewer the ring cracks formed and the greater will be the production. Hence a stroke of 24 in. (60.9 cm.) would be preferable. If the press is vertical, the length of the tube is limited by the tensile strength of the clay, but this will usually permit the making of at least 5-ft. (1.5 m.) tubes. If the press is inclined or horizontal, it is necessary to use a hand-controlled off-bearing belt. We have found that the press is satisfactory for all sizes of tubes we require, and that its capacity is sufficient. However, on account of the greater advantages of casting, the only tubes made on the press are those that cannot be cast on account of their small bore. In our case all tubes with an internal diameter over 5 mm. are cast. This eliminates all tubes but the inner or insulating tubes. It is, however, possible to make the small-bore tubes very successfully and to make tubes with several holes in them.

MANUFACTURE OF TUBES BY CASTING

Cast tubes above 5 mm. inside diameter are superior to pressed ones in many ways. They are much straighter, do not have to be handled until stiff, and are more homogeneous. The speed and trueness of this work, of course, depends primarily on the plaster molds. For long small-diameter molds for tubes closed on one end, the mold should be cast around a cold-drawn steel rod, on account of its trueness. The end of the rod should be rounded off as desired, and a hole about  $\frac{1}{16}$  in. (1.5 mm.) in diameter drilled in the center at this end, probably  $\frac{3}{8}$  in. (9.5 mm.) deep. The other end of the rod should be mounted in the center of a plaster block about 6 in. (15 cm.) high and 4 in. in diameter. The molds are cast by placing the rod vertically on the mounting, and wrapping a "coddle" of roofing paper, or similar flexible material, around the mounting and maintaining this measure up to a height of a few inches

above the top of the rod. Then run a  $\frac{1}{16}$ -in. pin, about 3 in. long, down into the small hole in the top end of the rod. Prepare the plaster and fill the "coddle" so that the pin sticks out of the plaster about  $\frac{1}{2}$  in. This  $\frac{1}{16}$ -in. hole through the bottom of the mold, made by drawing out the pin, serves as an air inlet, making it possible to pull the rod out of the mold; it also serves the same purpose in pulling out the cast tubes.

**Casting.**—The casting process consists in pouring clay suspended in water (slip) into a dry plaster-of-Paris mold and permitting it to remain there a sufficient time for the plaster to absorb the water from the slip in direct contact with the mold. The inside of the mold is, of course, the shape of the outside of the piece of ware. As this absorption continues the clay becomes stiff; the longer it continues, the thicker is the layer of hard clay next to the mold. When this layer has hardened for a sufficient distance from the inner face of the mold to make a wall of the proper thickness, the remaining slip is poured out by turning over the mold. During casting, it is necessary to keep the mold full of slip. The mold absorbs the water from the slip and sufficient slip must be

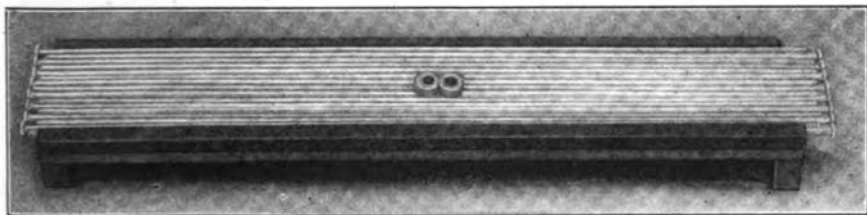

FIG. 1.—PALLET FOR DRYING TUBE.

run in to replace this. Casting necessitates the use of considerable care that is not at first apparent, particularly in pieces of the shape of tubes.

The small hole left in the bottom of the mold as an air inlet, when drawing out the metal core, is also essential in casting. Before the slip is poured into the mold a steel rod of the same diameter as the air vent is placed in this hole and run in until it projects into the mold proper about  $\frac{1}{2}$  in. (12 cm.). It is bent over on the outside of the mold and cut off about 1 in. from the center, and is held in place with soft clay. After the slip is poured and it is time to empty the mold, the pin must be taken out while the mold is being turned. If the pin is taken out too soon, the slip will run down and plug the hole; if it is left in after the slip begins to run out at the other end, the tube will collapse.

Considerable care must be used in drying the tubes, and proper pallets are necessary; plate glass is ideal for the purpose. Where wood is used there should be a stiff reinforcement running lengthwise of the pallet underneath, as well as cleats crossways. The boards should be of the same length as the green tubes and have a stop block running the



entire length, along one edge. The first tube is placed against this stop block, and the next one rolled close to the first, but with the head on the opposite end of the pallet, etc. This method permits the necessary clearance for the heads and each tube is held on both sides for its entire length, see Fig. 1. If the pallets are longer than the tubes, the head end of each tube will be without a brace on either side, for a distance equal to the difference between the length of the tubes and pallet. The last tube from the stop block is held in place by a  $\frac{1}{2}$  in. square steel rod. Twenty-four hours is sufficient for drying.

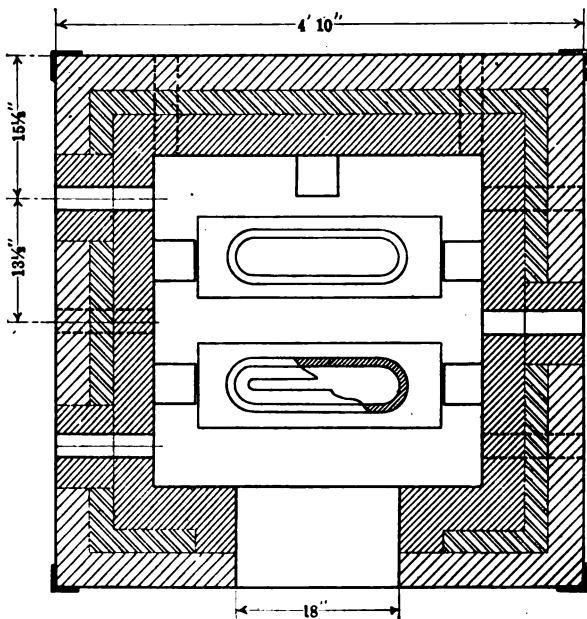

FIG. 2.—COLLAR OF UNIVERSAL JOINT FROM WHICH TUBES ARE SUSPENDED.

Close attention is required in preparing the casting slips as they must always have the same water content and the same casting time in order to secure proper uniformity of production. To keep the shrinkage low, the water content must be kept as low as possible and still have proper fluidity. This decrease in water content is facilitated by the use of alkaline electrolytes.<sup>2</sup>

*Setting.*—Setting must be done with great care, particularly if the tubes are very long. Tubes 5 ft. long or over are difficult to pick up while green, without straining or breaking, unless a small trough is used to support them for their entire length. They must be hung from the top of the furnace by the collar on a universal joint. Fig. 2 shows the collar as used. The tensile strength of the clay must be great enough to hold

<sup>2</sup> A. V. Bleining: U. S. Bureau of Standards *Tech. Paper 51*.

the weight of the tube, but all jars must be avoided in setting as the tubes are easily broken. Figs. 2 and 3 also show the kiln used in burn-

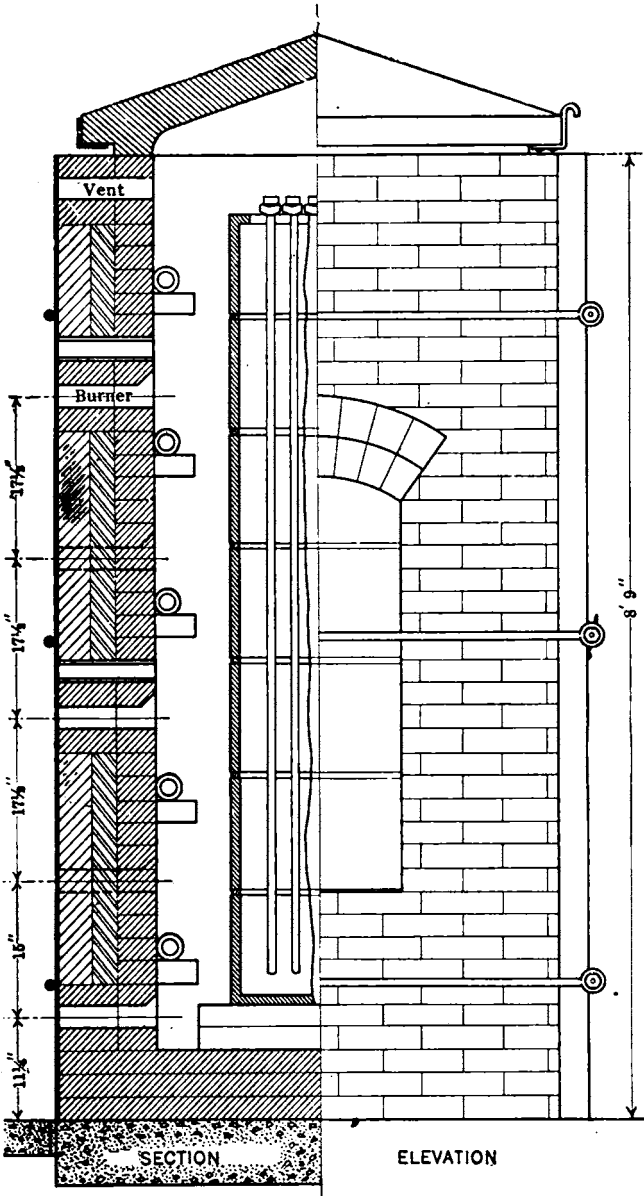

FIG. 3.—SECTION OF FURNACE FOR BURNING TUBES.

ing. It will be noted that the cover of the kiln lifts off so that the ware can be lowered down into the saggars. The kiln and saggars are so

arranged that there is an even temperature distribution on both sides of every row of tubes. This is essential if straight tubes are to be produced, as an irregular temperature causes uneven shrinkage and, consequently, warped tubes. Where a larger capacity is desired, it is possible to make the kiln longer, thus permitting the placing of more bungs of saggars. Each additional sagger will require an additional vertical row of burners. It is important that the refractories used in the kiln and saggars be of high grade. A sagger mixture that has proved satisfactory is,

|  | PER CENT. |
|--|-----------|
| Calcined flint fireclay, sized to pass through an 8-mesh<br>and be retained on a 30-mesh screen..... | 55        |
| Georgia kaolin.....  | 35        |
| Tennessee ball clay No. 5 or No. 9.....  | 10        |
|  | <hr/>     |
|  | 100       |

It is essential that a high-grade flint fireclay be used, that is, one having a softening point of at least cone 32.

*The Bisque Burn.*—If the tubes are to be glazed, they should be burned twice. The glaze is not applied until after the first burn. This first, or bisque, burn need be carried to a temperature only sufficiently high to expel its combined water and make the body hard enough to handle, that is, about cone 1. Practice has shown, however, that a straighter product is obtained by eliminating part of the fire shrinkage in the bisque burn but still leaving the tube porous enough to make it easy to apply the glaze. For Marquardt tubes, this temperature is equivalent to the fusion point of Orton cone 12 or 14 while cone 8 or 10 is sufficient for the ordinary porcelain tubes.

If the tubes are to be left unglazed the burning temperature should be sufficient to mature the body; that is, the temperature at which the body has the proper physical properties for the work for which it is to be used.

The inner insulating tubes and the extreme outer protection tubes, if  $1\frac{1}{2}$  in. (3.8 cm.) or greater in diameter, can be burned in any kiln in which the proper temperature can be reached. The small tubes should be burned in a refractory cradle. Care should be used in covering the tubes well and burning slowly in order to prevent the top tubes from curling up, due to uneven shrinkage. The larger diameter tubes can be burned horizontally without bedding or, if short enough, stood close together on end. It is not necessary to burn the insulating tubes to as high a temperature as the thermocouple protection tubes. They should, however, be burned to a temperature high enough to remove most of the shrinkage.

*Glazing.*—The ground glaze suspended in water may be applied to the bisque tubes in several ways, chiefly by spraying and dipping. Dip-

ping is not as satisfactory as spraying but much cheaper and preferable from a manufacturing standpoint, if done properly. A third, and very satisfactory, method is to arrange a small container with a bottom consisting of a rubber sheet. A hole is cut in the center of the rubber large enough to permit the tube which is to be glazed to slide through it, but tight enough so that the container will hold liquid when the tube fills the hole. The tube is hung in a vertical position and the container pushed up the tube to the top, the tube, of course, passing through the rubber bottom of the container. The container is then filled with the liquid glaze, of proper viscosity, and drawn down the tube at a rate great enough to allow a coat of glaze of just the proper thickness to adhere to the porous walls of the tube. This gives a very uniform thickness of glaze as every part of the tube is exposed to the glaze application for the same length of time, and it is applied slowly enough to prevent running. This is a defect that is apt to occur in dipping. Glazes of the character used for this work are of such a nature that they will not run or mend any defects caused by improper application.

Glazes for use in pyrometer work should be sufficiently refractory so that they will not soften at working temperatures and stick to the furnace or the outside protection tubes. Most of the glazes used are of such a character that they are absorbed into the body of the porous tube when the heat is increased too much. This prevents sticking and keeps the tube gas-tight but eventually decreases its refractoriness and tends to vitrify the tube and make it less resistant to temperature changes.

Two refractory glazes that absorb into the body when the heat is too great are of the chemical composition:



The batch weights are whiting, 100 parts by weight; clay, 516 parts.

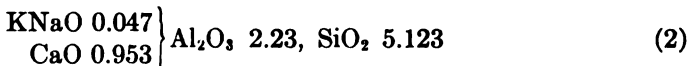

Of the above, the CaO, 2 Al<sub>2</sub>O<sub>3</sub>, 4 SiO<sub>2</sub> are fritted at cone 20, ground and added to the rest of the batch.

| BATCH OF FRITT  | PARTS | BATCH OF GLAZE           | PARTS |
|-----------------|-------|--------------------------|-------|
| Whiting.....    | 100.0 | Fritt.....               | 100   |
| Kaolin.....     | 516.0 | Tennessee ball clay..... | 15    |
| Boric acid..... | 1.3   | Potash feldspar.....     | 6     |
|                 | <hr/> | Flint.....               | 6     |
|                 | 617.3 |                          | <hr/> |
|                 |       |                          | 127   |

The glazes are ground wet in ball mills and lawned through 120-mesh screens before being used. Glaze No. 1 is a beautiful cream matt at cone 17 down while No. 2 is rather harder but vitreous enough to be gas-tight.

Bright glazes for use on tubes that will be exposed to temperatures under 1000° C. are:

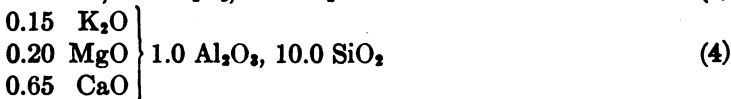

These glazes are very beautiful at cone 17 but soften at cone 10 and are not absorbed into the body and hence stick to anything the tubes may be touching.

A harder bright glaze that is more satisfactory up to the fusing temperature of cone 14 is:



The batch weights are whiting, 100 parts by weight; clay, 258 parts; flint, 120 parts. In all the glazes, the thickness of application has considerable effect on the sticking and should be carefully watched.

*The Glost Burn.*—This burn is handled in the same manner as the bisque burn, the temperature being brought to the proper maturing point of the body and glaze. The body and glaze should mature at the same temperature. Tubes have been made at the Bureau measuring 7 ft. (2.1 m.) in length when finished. For these, body No. 1 and glaze No. 1 were used. The manufacturing loss was 9 per cent. and the tubes were a good quality marketable product. They were used for experimental work.

One very important point in burning is to allow sufficient time at the maturing temperature to permit the heat to penetrate the walls of the ware thoroughly so that it has a uniform effect upon all parts of the ware. It is also essential to burn the ware to a temperature higher than that at which it is to be used, if it is necessary for the tubes to remain straight in use, particularly when the tubes are projected into the furnace horizontally with the inner end unsupported. The reason for this is evident. There is some shrinkage in the tube if the body is still porous and was burned to a lower temperature when manufactured. When the tube starts to shrink gravity assists the shrinkage on the lower side of the projected tube and opposes shrinkage on the top. The result will be a crooked tube.

*Other Refractory Materials.*—Zirconium oxide and magnesium aluminate (Spinel) are both very refractory and tubes made of these materials should prove very useful. The Bureau of Standards has done some work upon these materials but the manufacture of pyrometer tubes made from them has not yet been commercialized.

In conclusion, the writer wishes to express his thanks to his associates for many helpful suggestions.

## Pyrometer Porcelains and Refractories

BY R. W. NEWCOMB, B. S., NEW YORK, N. Y.

(Chicago Meeting, September, 1919)

THE constancy of calibration, and to a great extent the life, of a thermoelement is dependent on the suitability of the primary protecting tube in which the wires are mounted, particularly when used at high temperatures. An ideal thermocouple protecting tube would be composed of materials that would not contaminate the thermoelement wires contained in it—one that would remain absolutely gas-tight at all temperatures of usage, that will not be attacked by gases, or other surrounding agencies, that is not destroyed by heat, that withstands sudden and extreme temperature changes, that affords a high degree of mechanical protection and does not deform at high temperatures, that is a good heat conductor and obtainable in small diameters so as to keep down lag factors.

It has not yet been possible to produce tubes of any known materials that will meet all of these conditions. In selecting protecting tubes, therefore, one should be chosen the characteristics of which best fit it to the particular conditions of usage. Frequently conditions are such that two tubes have to be used, a primary gas-tight protecting tube inside of a secondary protecting tube, because certain agencies will attack the primary gas-tight tube unless it is guarded by the outside tube.

### PRIMARY PROTECTING TUBES

Of primary protecting tubes, there are two classes: those of quartz which are obtainable in three grades, transparent quartz, drawn silica, and molded silica; and those of refractory porcelain (alundum included), which are divided into several grades.

Primary protecting tubes of quartz (silica) are apparently gas-tight when well made and remain gas-tight if not used at too high temperatures. At temperatures where divitrification is considerable, tubes of quartz soon become crystallized and are not impervious to gases. The principal advantage of quartz tubes as a thermoelement protection is in its extremely low-temperature coefficient of expansion. It can be subjected to violent temperature changes without danger of breaking. Because silica is easily reduced, care should be taken when the tube is used over a platinum thermoelement, because silicon is a very bad contaminating agent. Results in practice seem to indicate that for permanent instal-

lation quartz tubes should not be used above  $1000^{\circ}$  C. and for intermittent service not above  $1300^{\circ}$  C. At the latter range deformation should be guarded against.

In the refractory porcelain group of primary protecting tubes, it is difficult to separate the classes. They range from vitrified porcelains to very high refractory porcelains. Alundum tubes, perhaps, should not be included with this group; the body mixture is different, but in characteristics they are not dissimilar. Before the war, practically all porcelain primary tubes were imported. Within the last 3 years, however, American porcelain tubes have been produced that excel in most respects those previously imported.

Vitrified porcelains that stand sudden temperature changes remarkably well are now available and they can be used continuously at temperatures up to  $1200^{\circ}$  C. Vitrified porcelain tubes are usually gas-tight without being glazed, but are frequently glazed as an added precaution. Vitrified porcelain tubes are valuable as a thermolement protection for permanent installation above the practical range of quartz tubes and where moderate temperature changes take place over a short time interval.

Refractory porcelain tubes are obtainable for the range to  $1600^{\circ}$  C. The glaze softens and is absorbed by the body of the tube if subjected to this heat for some length of time. Tests made seem to indicate, however, that the tubes remain impervious to gases. The best American refractory porcelain tubes are now provided with a glaze that does not soften below  $1350^{\circ}$  C. and at this temperature does not flow.

### SECONDARY PROTECTING TUBES

Secondary pyrometer tubes are not ordinarily gas-tight. Their purpose is to give mechanical protection to the primary tube, protect the glaze of the primary tube from abrasive, corrosive, and fluxing conditions, and to prevent deformation at high-temperature ranges. Also, frequently, in the case of refractory porcelain, to introduce sufficient lag to prevent a too rapid temperature change, which otherwise might cause the primary tube to crack.

There are many secondary tubes besides those of metal; those most commonly used are fireclay, plumbago, carborundum, and unglazed refractory porcelain.

Those of refractory porcelain offer the greatest advantage for most conditions other than in molten metal and baths. First, because they stand up under the most severe temperatures at which thermocouples are used and, second, because in themselves they are not a contaminating agent that will attack the thermolement wires in case the primary tube becomes broken. Most of the refractory porcelain secondary tubes have a body with a lower temperature coefficient of expansion than that of the

primary tubes, and they are less liable to crack under severe temperature changes. There are few fluxing agents that act upon them. They deform only at the very highest temperatures. In glass-melting tanks, where conditions are very trying on a thermocouple protecting tube, these tubes remain apparently unaffected under normal conditions.

Fireclay secondary tubes can be used satisfactorily in very large slow-heating furnaces such as brick kilns, continuously operated furnaces, etc. Their characteristics are similar to other fireclay products. For the most part they must be large to give the required mechanical protection, which causes them to be of a size where the lag they introduce is a serious disadvantage.

Plumbago secondary tubes are ordinarily used only in molten metals and baths. When exposed to oxidating conditions, they are rapidly destroyed. It is best to frankly admit that for use in molten metals, lead heat-treating baths excepted, no tubes known to the writer give what can be called satisfactory service. Plumbago tubes last some length of time in molten brass, bronze, copper and aluminum, but the service cannot be compared to the service given by the other tubes under ordinary furnace condition.

Carborundum tubes appear to be a very good secondary protection from the standpoint of heat conduction, mechanical protection, and refractory qualities. The fact that these tubes are so refractory permits them to be used as a secondary protection for high temperatures. When this is done, a primary protecting tube free from silica must be used on account of the strong reducing condition produced by the secondary tube, which causes a reduction of the silica in the primary tube, resulting in a contamination of the thermoelement combined with a very rapid crystallization. The same results could be expected from plumbago secondary tubes were they used at the same temperature range; but this is not usually the case.

While material progress has been made in the perfection of primary and secondary pyrometer tubes, there is still much to be desired. As yet no tube has been developed for molten steel or molten glass nor has there been a tube produced of great mechanical strength that can be used at the higher temperature ranges. Of the tubes now available, a careful selection must be made to obtain a combination of primary and secondary tubes of which the qualities are such as will best fit them to the particular conditions under which they are to be used.

## DISCUSSION

A. O. ASHMAN, Palmerton, Pa. (written discussion\*).—Mr. Newcomb's paper has interested me greatly, as I have had numerous experiences

\* Received Sept. 25, 1919.



along this line. I do not think enough emphasis can be put on his warning to keep platinum couples free from contact with quartz tubes, as silica shows a tendency to alloy with platinum to a surprising degree even at low temperatures. I have frequently had evidence of silica contamination in a perfectly good tube, in which there was seemingly no possibility of a reducing atmosphere.

This is rather important as it seems to be common practice to insulate, as well as protect, the wires by means of capillary silica tubing, thus allowing the entire wire to be in contact with the silica. The best way to mount a couple in a silica protecting tube is by means of double-bore porcelain insulating tubes, the protecting tube being slightly longer than the couple so as to leave a space between the couple and the end of the tube. In this way there is no possibility of contamination from silica. In no case should silica capillary tubes be used to insulate platinum wires.

Mr. Newcomb states that there is still much to be desired in pyrometer protecting tubes; this is in keeping with my experience. From a practical standpoint there is not a satisfactory pyrometer tube on the market for high temperatures; with all due respect to the many improvements and good work recently done in this line. I believe that the whole future development of pyrometry is dependent on the development of suitable refractories. With suitable refractories, for example, Darling's<sup>1</sup> work with liquid couples could be developed to a practical basis, making possible the use of base-metal couples to replace platinum.

CARLETON W. HUBBARD, Greenwich, Conn. (written discussion\*). This paper would have been more valuable if the information in it had been tabulated, giving the author's recommendations for primary and secondary tubes for various temperature ranges and uses. The danger of thermoelement contamination is generally not sufficiently appreciated. This point is touched on several times in the paper, but the actual danger points as to temperatures and conditions of use are not given as elaborately as they should be to be of value to the purchaser or engineer, who, at the same time, is not a chemist. There is need for a definite body of information regarding temperatures at which various kinds of tubes begin to deform. Some test standards for this kind of work should be set, and I would suggest various lengths of overhang for tubes of different diameters and wall thicknesses.

---

\* Received Oct. 8, 1919.

<sup>1</sup>C. B. Darling: Base-metal Thermoelectric Pyrometers. *Jnl. Faraday Soc.*, Meeting Nov. 7, 1917.

## Pyrometer Protection Tubes

BY F. A. HARVEY,\* PH. D., SYRACUSE, N. Y.

(Chicago Meeting, September, 1919)

DURING the last few years, there has been a constant tendency toward increasingly high temperatures in many lines of industry. The necessity for increased production of coke gave a 16-hr. coking period where we used to have 24 or even 30-hr. periods. Mechanical stokers have increased the temperatures in boiler furnaces. The use of a chain-grate stoker with coke-breeze fuel necessitates a low arch in the furnace and temperatures run much higher than firebrick were formerly called upon to stand. These higher temperatures have necessitated more rigid tests and the separation of even high-grade firebrick into separate classes. More severe tests mean higher temperatures and closer control, and this, in turn, means better pyrometer tubes. Platinum couples do not have a very long life when used at temperatures exceeding, say, 1200° C., but the proper selection of a high-grade brick to be used in a boiler setting will save the cost of several couples; and with freight rates continually increasing it becomes increasingly important to know where brick may be bought, nearest the job, that will prove satisfactory. Couples that will stand continuous use at higher temperatures, of tungsten, molybdenum, or other metal, will doubtless be forthcoming as soon as the need becomes sufficiently urgent.

There are on the market several tubes that are entirely satisfactory for temperatures up to 1300° C., if properly protected from heat shock. The Semet-Solvay Co. makes a practice, however, of testing silica and clay firebricks at 1450° C. for 72 hr., and so far we have been unable to find a tube that is entirely satisfactory for this purpose. A graphic record of the temperature during the entire test is extremely desirable and hence we have been trying out anything that gave promise of success.

Several years ago we were using insulating tubes, made purely for electrical work, of vitrified porcelain. These tubes stood up under any temperature we were able to reach and were apparently impervious to gases. When this stock gave out, due to mechanical breakage, we tried other insulation tubes only to have them melt down like glass. Marquardt Masse tubes were tried next under a statement from the distributors' catalog, copied from German circulars without verification, that these tubes "can be used up to 3000° F. (1650° C.) without the slightest risk."

---

\* Laboratory Physicist, Semet-Solvay Co.

This statement is about 300° C. from the truth, as 1350° C. is as high as our experience indicates they can be used. The tubes are uneven in their heat resistance. Many broke through heat shock, but this may be prevented by using an outer protection tube of silfrax. Usalite tubes, Royal Worcester tubes (England), and several unbranded tubes from different makers failed.

The S. C. P. Japan tubes have been tried and have so far been the most successful. They have a slightly too low softening point and will occasionally stick to the silfrax tube or warp so that the inner insulating tube cannot be withdrawn to anneal the couple. They seem, however, to be completely impervious to gases. Even when the glaze has been chipped off, the body of the tube seems to be impervious.

Alundum tubes have been tried. Without a glaze they are too porous and so far the glazes tried seem to lower the fusion point too far. Impervite tubes were tried and found to be anything but impervious under the conditions: *viz.*, an impervite tube inside a silfrax tube. The firm from which these tubes were purchased recommends a secondary tube of unglazed impervite and very kindly supplied us with new outer and inner tubes for experiment. At 1250° C., there seems to be no attack on the tube or couple; at 1300° C., for two 72-hr. runs the tube stood up all right. At 1350° C., during one run of 72 hr. the tube lost its glaze but apparently the couple was not contaminated. At the time of writing it has not been tried at 1450° C. It seems probable that the rate of diffusion of the waste gases will be slow enough to permit the use of the tube in an atmosphere that is not particularly hard on couples. The body of the tube certainly has a very high fusion point.

Mr. F. H. Riddle of the Bureau of Standards has sent us five tubes, but the tests on these tubes have not yet been completed.

At present our method of recording the temperature of our furnaces dodges the difficulty by using two couples. Two silfrax sheaths are used, one just above the other, the top one projecting about 7 in. (17 cm.) into the furnace chamber, while the lower projects only 2½ in. (6.35 cm.). It has been found by trial that a couple in this lower tube does not attain the full temperature of the furnace, but runs about 100° lower. In spite of this the lag over the actual changes in furnace temperature is slight. Two couples are connected to a recording meter, the lower one being left in continuous run. The upper is protected by a fused quartz tube and is pushed clear into the upper silfrax tube, where it attains the full temperature of the furnace in about 5 min. After 10 min., it is withdrawn and the recorder chart thus carries a calibration of the lower couple made every 2 or 3 hr. The workmen run the furnace by the continuous record.

DISCUSSION

F. H. RIDDLE,\* Pittsburgh, Pa.—I understand that these tests at 1450° were for continuous periods, that is, over several hours. Is it possible, for short periods of time, to go to higher temperatures than 1450°? The apparently vitreous tubes that appeared to resist the effect of iron the best are made to vitrify. The Marquardt mass bodies are very porous. When examined after use at high temperatures, the glaze seems to have entirely disappeared. This is due to the fact that when it softens on the porous body it is absorbed into the body. This can be shown by holding a broken portion of a tube in a colored solution and then examining a cross-section.

The vitreous tubes are made to resist detrimental gases, but they will not withstand sudden temperature changes, as a rule, as well as the low-coefficient porous tubes.

F. A. HARVEY.—We have not tried these tubes for shorter periods at higher temperatures for we have no occasion to go above 1450°. There is one definite problem we are trying to solve; that is for a continuous run of 72 hr. at 1450°. We need a more highly refractory tube than we have at the present time. You can protect against heat shocks by putting a carborundum tube on the outside. If you are dealing with a continuous run, the temperatures can be raised as gradually as you wish.

W. E. FORSYTHE, Nela Park, Cleveland, O.—Our experience has been that if you are going to measure temperatures as high as 1550° C. with a platinum platinum-rhodium couple in anything approaching practical conditions, the e.m.f. is very questionable. We have never had a platinum platinum-rhodium thermocouple that would keep its calibration when mounted in an ordinary platinum-wound furnace operated at this temperature for any length of time.

R. B. SOSMAN, Washington, D. C.—We measure temperatures with platinum platinum-rhodium couples, regularly, up to 1755°, the melting point of platinum, and get comparative accuracy, but the platinum must be pure.

---

\* Chemist, Clay Products Division U. S. Bureau of Standards.

## Protecting Tubes for Thermocouples

BY R. B. LINCOLN,\* DETROIT, MICH.

(Chicago Meeting, September, 1919)

THE function of a pyrometer protecting tube is to maintain an atmosphere about the thermocouple most favorable to its continued accuracy and long life, and at the same time permit the weld of the couple to attain the full temperature of the area or object being measured. In addition to protecting the thermocouple from the chemical or alloying effects of the products of combustion or bath being measured, the tube must also protect the couple from mechanical injury. The conditions met in practice vary so much that no one material is suitable for all applications. The usefulness as well as the expense of maintenance of a pyrometer system are influenced greatly by a choice of the most suitable protecting tube. The tube must protect the couple without itself becoming too great an expense item.

The protecting tube should have the following qualities: (1) A melting point well above the highest temperature to be encountered. (2) Sufficient strength through the entire range of temperatures to hold up its own weight and resist such shock and jar as are unavoidable. (3) It must be impervious to the atmosphere or bath to which it will be subject. (4) It must not give off any vapor injurious to the couple. (5) It must not form any oxides fusible below the highest temperature to be measured.

The proper location of the tube in the furnace is almost as important as the choice of material. The tube must be placed as near to the work to be heated as possible. It must be kept out of the direct path of flame, both because that would give too high temperature readings and because partly burned fuel will destroy the tube faster than the quiet products of combustion.

Pyrometer tubes are sometimes buried in the floor or embedded in the wall of the furnace, but usually the lag is so great that the readings are of little use. When rare-metal couples and expensive porcelain tubes are used, there is a temptation not to project the couple far enough into the furnace. Where only approximate results are required, a couple may be projected into a depression in the furnace wall; but for the heat treatment of steel, the couple must be near the work. The tube must always project into a furnace far enough to become fully heated to the furnace

\* Hoskins Mfg. Co.

temperature. A refractory tube will require two or three times its diameter exposed to the heat to get away from the cooling of the tube by the colder parts. A nickel-chromium tube will require twice that much immersion and a steel tube slightly more than the nickel-chromium.

Neither platinum nor platinum-rhodium are injured by oxidation but both absorb carbon, hydrogen, and many metal vapors at high temperatures. Porcelain, kaolin, or fused silica are about the only substances that may be safely allowed to touch a rare-metal couple at high temperatures. Since "chemists triangles" made of nickel-chromium wire do not injure platinum dishes, it may be that if drawn nickel-chromium tubes could be obtained the fragile porcelain tubes could be entirely dispensed with, but as long as cast tubes only are available, porcelain must be interposed between the outer tube and the couple. A rare-metal couple must be protected from contamination even when cold, otherwise bits of metal, salt or paint, and charcoal from a wooden bench may become attached to it when cold and later destroy the accuracy of the couple when placed in the furnace.

Porcelain was one of the first materials to be used for pyrometer protecting tubes. The best grades for this work soften about 1800° C. and are practically impervious to gas. It is one of the few materials that will not alloy with or contaminate platinum. This material is very brittle at temperatures below 1200° C., and its high coefficient of expansion causes it to break from too rapid changes of temperature. It is destroyed by fused alkalis or metallic oxides. This combined with its first cost has limited its use to a protection for rare-metal couples, and it is usually protected by an outer metal tube.

Fused silica, artificial quartz, has a very low coefficient of expansion and is much cheaper than porcelain. It is suitable for protecting rare-metal couples subject to sudden changes of temperature. When subject to temperatures above 1200° C., it undergoes a recrystallization which causes it to become cloudy and weak. It finally breaks from its own internal strains.

Thermocouples made of nickel-chromium, known under the trade name of chromel, and nickel-aluminum, known as alumel, oxidize very slowly and maintain their accuracy best when subjected to oxidizing conditions. They fail quickly when subjected to strong reducing conditions and even more quickly when subjected to alternative reducing and oxidizing conditions. These materials, when used in an electric furnace heated by nickel-chromium or platinum wire, usually require no protecting tube. When used in a fuel-fired furnace, probably the best and at the same time most economical protecting tube is one made of nickel-chromium. Tubes made of an alloy of 80 per cent. nickel and 20 per cent. chromium, known under the trade name of chromel A, are most economical for temperatures between 600° C. and 1100° C., in gas- or oil-fired

furnaces. A cheaper tube is made with somewhat less chromium and an addition of about 25 per cent. of iron. This tube will stand a slightly higher temperature than the straight nickel-chromium but lasts about one-half as long at 1000° C. The life of nickel-chromium tubes is greatly reduced by alternately strongly oxidizing and strongly reducing conditions such as are encountered near the bridge wall of a coal-fired furnace. The tube containing 25 per cent. of iron is rather more satisfactory under these conditions than the straight nickel-chromium, but the best solution is to so locate the tube that it will be subjected to a dead heat. Nickel-chromium tubes are very satisfactory as an outer protection for rare-metal couples.

At temperatures around 1200° and 1300° C., alundum tubes are quite satisfactory but are, of course, very fragile.

For measuring high temperatures in large furnaces, porcelain kilns, and glass tanks, where the conditions are very severe but the change in temperature is very slow, tubes made of fireclay with heavy walls,  $\frac{3}{4}$  to  $1\frac{1}{2}$  in. (19 to 38 mm.) thick give good service.

Iron and steel protecting tubes seem to allow furnace gases to diffuse through the walls of the tube at red heats and, when used with nickel-chromium couples, should always be open to the air at the end away from the heat. If the outer end is plugged, the couples will behave very much as though not protected from the furnace gases. I consider it safest to have all protecting tubes open to the air at the end away from the heat. Care should be taken to see that this end is not surrounded by flame or gas from the furnace. In the case of a bath of molten metal or salt, the tube should be long enough to prevent drops of metal or salt or small pieces of charcoal from dropping down the tube.

Couples of iron versus constantan, iron versus commercial nickel, or nickel-chromium versus nickel-copper (chromel-copel) may be used up to 300° or 400° C. without any protection, and to 500° or 600° C. with light steel tubes. The use of iron-constantan couples at a temperature around 800° and 900° C. requires somewhat different treatment from that given either rare metals or chromel-alumel couples, since the iron and constantan oxidize rapidly at this temperature, while the other couples are injured most by a reducing condition. Iron-constantan couples are frequently installed in iron tubes closed as tightly as possible in order to allow the oxidation of the iron tube and the diffusion of gas through the walls of the tube to create a reducing, or at least non-oxidizing, atmosphere in the tube. Iron-constantan will oxidize very rapidly when used in a nickel-chromium protecting tube that allows free access to the air, and when it is desired to use a tube of this material, an inert material (such as alundum) mixed with a few per cent. of charcoal is packed around the couple to retard oxidation.

Until this time I have considered the protecting tube in its relation to

the couple and assumed that the tube is exposed to products of combustion in a furnace. When the tube is exposed to a molten bath a tube must be chosen that will withstand the bath. A nickel-chromium-iron tube will give good results in molten lead around 700° to 800° C. Seamless steel or extra heavy wrought iron pipe is sometimes used because of its low first cost.

Molten cyanide of potash is one of the most difficult baths to control. It is very injurious to any kind of a couple, it fluxes refractory tubes, and passes through steel tubes. A nickel-plated steel tube has given fair results, and nickel-chromium alloy is good if the casting is entirely free from defects.

An alloy of 75 per cent. iron and 25 per cent. chromium known under the trade name of "chromon" has been developed to withstand the action of molten brass and bronze. A light protecting tube of this material is used with a fairly light couple to take readings in a crucible of molten metal. A reading is secured in 40 sec. to 1 min. Such a tube will give between 100 and 200 readings before failing, depending on the temperature and composition of the melt, and on the perfection of the casting.

In conclusion, to intelligently select a protecting tube the following factors must be considered: Whether the couple should be used under oxidizing or reducing conditions; the atmosphere or bath to which the tube will be subjected; the maximum temperature to be encountered. Care taken in the selection of the proper tube, locating it in the most favorable place in the furnace, and then inspecting and replacing it before it has deteriorated enough to injure the couple, will result in increased accuracy and decreased up-keep charges.



## Pyrometer Protection Tubes

BY OTIS HUTCHINS,\* B. S., NIAGARA FALLS, N. Y.

(Chicago Meeting, September, 1919)

It is intended to discuss in this paper protection appliances used for high-temperature pyrometer installations involving the use of platinum couples and to describe some of the characteristics of a new carborundum protection tube. Of all the components that go to make a complete pyrometer installation, the one given the least attention and the one about which there is the least exact information is the outer protection tube. This condition is unfortunate, as much, and in some cases even the success of the equipment as a whole, depends on the proper type of protection. In the majority of cases, the installation is allowed to operate without attention until some part of the apparatus breaks down. The outer tube is the component that usually fails and, more often than not, the failure causes breakage of the porcelain protection and ruin of the couple. This condition should be recognized and studied as it has a very important bearing upon the upkeep cost of pyrometer equipment. The cost of the outer protection tube is small compared with the cost of the platinum couple and porcelain protection and it would well repay users of this type of equipment to replace their outer protection tubes at certain definite periods, which experience shows is necessary to prevent destruction of the platinum.

Speaking generally, platinum thermocouple equipment is used for measuring temperatures over 2000° F. (1094° C.), and is used extensively for the control of brick and pipe kilns, glass pot furnaces, glass tank furnaces, heat-treating furnaces, open-hearth furnaces, and forge furnaces. A satisfactory protection tube must be sufficiently refractory not to soften at the maximum temperature within the furnace. It must be resistant to cracking due to temperature changes, should be as nearly gas-tight as possible, and should be made of a material with a high thermal conductivity and great resistance toward erosion by the furnace atmosphere.

Carborundum is a refractory that possesses these characteristics to a marked degree. Recent manufacturing improvements have made possible the production of protection tubes composed entirely of carborundum without the addition of any binding material. These tubes possess all the desirable properties of carborundum including great refractoriness, low coefficient of expansion, resistance toward the action of furnace gases and slags, and high thermal conductivity. The effect of the thermal

---

\* Metallurgical Engineer, The Carborundum Co.

conductivity of the protection tube is of great importance and has a very decided bearing on the accuracy with which the pyrometer temperature indication follows the actual temperature condition within the furnace. Carborundum having a thermal conductivity of about eight times that of fireclay and three to four times that of fused alumina refractories would be expected, when used as a protection, to show a considerable advantage in this respect.

To prove this point a series of experiments was conducted with carborundum and fireclay tubes to determine the lag in the pyrometer reading caused by these types of protection. Four chromel-alumel type *P* couples were prepared and standardized. The first couple was used in the form of bare wire without any protection, the second was protected by a porcelain tube and a carborundum tube 1 in. (2.5 cm.) inside diameter,  $1\frac{7}{8}$  in. (4.7 cm.) outside diameter, length outside 19 in. (47 cm.), length inside  $17\frac{3}{4}$  in. (45 cm.); the third was protected by a porcelain tube and a fireclay tube 1 in. inside diameter, 2 in. outside diameter, length outside 18 in., length inside  $17\frac{1}{4}$  in., and the fourth couple was protected by a porcelain tube and a fireclay tube  $1\frac{1}{8}$  in. inside diameter, 3 in. outside diameter, length outside 18 in., length inside  $17\frac{1}{8}$  in. A large electric pot furnace was maintained at a constant temperature by means of a rheostat. The temperature of this furnace was determined by means of a platinum thermocouple, which was allowed to remain in the furnace throughout the experiment.

*Experiment 1.*—The furnace was maintained at approximately 450° C. and the four chromel-alumel couples were plunged into it, one at a time, and allowed to remain there until the millivolt reading of the couple became constant. Readings of millivolts and time were taken and curves plotted.

*Experiment 2.*—The procedure was repeated with the furnace temperature maintained at approximately 950° C. The following results were obtained:

|  | FURNACE AT<br>450° C.,<br>MINUTES | FURNACE AT<br>950° C.,<br>MINUTES |
|--|-----------------------------------|-----------------------------------|
| Time for reading of bare couple to become constant. . . . .                                  | 5                                 | 2½                                |
| Time for reading of couple in carborundum protection to become constant. . . . .             | 25                                | 12½                               |
| Time for reading of couple in 2 in. diameter fireclay protection to become constant. . . . . | 50                                | 35                                |
| Time for reading of couple in 3 in. diameter fireclay protection to become constant. . . . . | 70                                | 50                                |

It was recognized that while the above results were interesting they did not indicate what could be expected from commercial installations where changes of temperature were less rapid. As measuring the temperature of the gases of the open-hearth steel furnace is a promising field for pyrometry, it was decided to make certain tests to determine the effect of couple protection on this work. Three calibrated platinum thermo-

couples were installed side by side in the slag pocket of an open-hearth steel furnace just above the checkerwork. The first couple had porcelain and a  $1\frac{7}{8}$  in. diameter carborundum-tube protection, the second had porcelain and a 2 in. diameter fireclay-tube protection, and the third couple had porcelain and a 3 in. diameter fireclay-tube protection. Leads and switches were arranged so that any one of the couples could be connected with a millivolt meter. Readings were taken of millivolts and time for each couple for seven reversals of the furnace gases. The

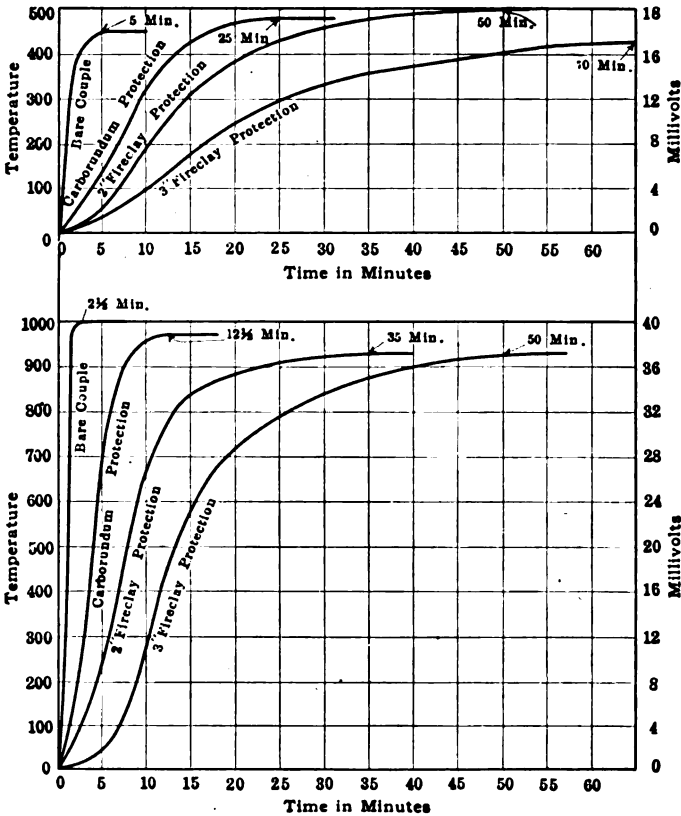

FIG. 1.—CURVES SHOWING LAG IN PYROMETER READING FOR DIFFERENT PROTECTION TUBES.

thermocouple protected by the 2-in. fireclay tube did not operate satisfactorily throughout the entire test and no curve of the readings of the couple is included. The general shape of the curve was the same as that of the couple protected by the 3-in. fireclay tube, the time and temperature lag being less. The average results for this thermocouple are included in the tabulated data. No record was made of the exact time of changing the valves on the furnace so that no data are available to show the time lag of the couple protected by the carborundum tube. However,

judging from the shape of the curve for this couple, the time lag must have been small. The data given in Table 1 are obtained from the curves shown in Fig. 2.

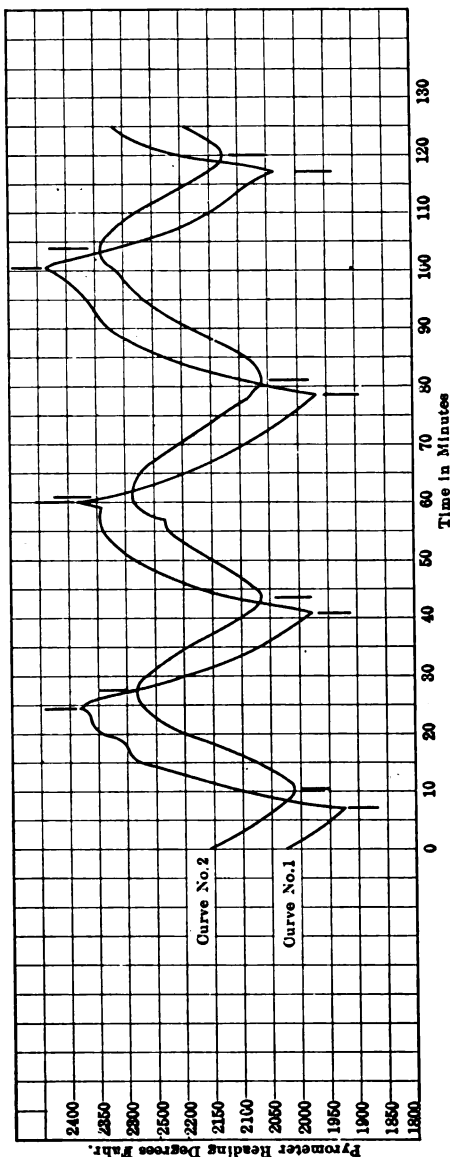

FIG. 2.—CURVES SHOWING TEMPERATURE VARIATIONS OF SLAG POCKET OF OPEN-HEARTH FURNACE. Curve No. 1, couple protected by 1½ in. carborundum tube. Curve No. 2, couple protected by 3-in. fireclay tube.

It will be seen from these results that the use of couple-protecting material having high heat conductivity is of very considerable importance.

In the glass-furnace field carborundum tubes are rapidly becoming the standard type of protection. In Fig. 3 is shown a photograph of a carborundum tube that has had 4 mo. service in an oil-fired glass tank

TABLE I

| Re-<br>versal | Indicated Time of Reversal<br>by Couple with |  | Lag of 3-in.<br>Fireclay<br>Behind<br>Carborundum.<br>Minutes | Indicated Temperature<br>at Time of Reversal by<br>Couple with |   | Temperature<br>Lag of 3-in.<br>Diam. Fireclay<br>Couple as<br>Compared with<br>Carborundum<br>Couple,<br>Degrees F. |
|---------------|--|--|---|--|---|---|
|               | Carborundum<br>Protection,<br>Minutes        | 3-in. Fireclay<br>Protection,<br>Minutes |   | Carborundum<br>Protection,<br>Degrees F.                       | 3-in. Fireclay<br>Protection,<br>Degrees F. |   |
| 1             | 7  | 10½                                      | 3½  | 1923   | 2010  | 87  |
| 2             | 24½  | 27½                                      | 3   | 2382   | 2282  | 100   |
| 3             | 40¾  | 44                                       | 3¼  | 1978   | 2065  | 87  |
| 4             | 60   | 61                                       | 1   | 2385   | 2288  | 103   |
| 5             | 78½  | 81                                       | 2½  | 1962   | 2062  | 100   |
| 6             | 100½   | 104                                      | 3½  | 2435   | 2340  | 95  |
| 7             | 117  | 120                                      | 3   | 2037   | 2125  | 88  |

FIRECLAY PROTECTION TUBE  
 3 INCH      2 INCH

Average time lag of couple protected by fireclay tube  
 over carborundum protected couple..... 2 min. 49 sec. 1 min. 9 sec.  
 Average temperature lag of couple protected by fireclay over  
 carborundum protected couple..... 94.3° F. 56.0° F.

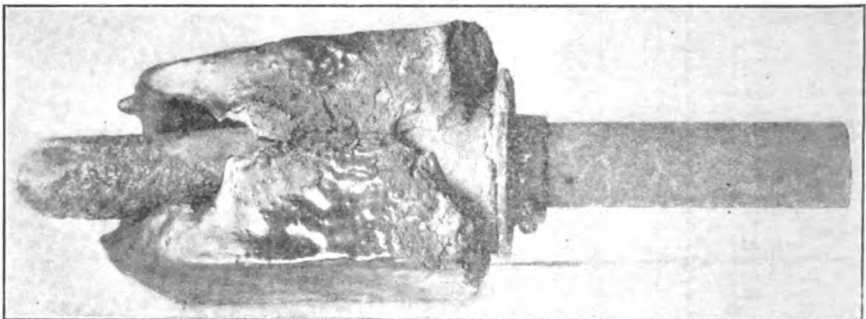

FIG. 3.—CARBORUNDUM TUBE AFTER 4 MO. SERVICE IN AN OIL-FIRED GLASS TANK FURNACE.

furnace. It will be noticed that the fireclay supporting tube has been very badly melted away while the carborundum tube shows only slight signs of wear. A life from 6 to 8 mo. is usual for these tubes and it is not uncommon to find them giving satisfactory service for a very much longer period.

Due to the high thermal conductivity of carborundum tubes it is not necessary, when installing this equipment, to allow the tube to project more than a short distance into the furnace. In some cases it is even desirable to keep the end of the tube flush with the furnace wall; this method of installation will add very materially to the life of the thermo-couple protection.

## Melting Point of Refractory Materials

BY LEO I. DANA,\* B. S., WASHINGTON, D. C.

(Chicago Meeting, September, 1919)

THE object of this paper is to discuss the factors and conditions that affect the observed values of the melting points of refractory materials and to describe practical methods for the determination of these points. While it appeared to be necessary to discuss some of the general properties of silicates and refractories, these subjects have been entered into only in so far as they relate to the melting point and its determination.

Refractory materials such as fireclays, firebricks, and minerals generally, may be considered to be composed of compounds of metallic oxides, solid solutions of the oxides, the pure oxides, or mixtures of the three classes together with small amounts of a variety of chemical compounds. The oxides silica and alumina occur most commonly in refractory materials; in combination with these, oxides of the alkali earth, the alkali, the iron group, and the rare earth metals are frequently found.

### MEANING OF MELTING POINT

In its strictest sense, the term melting point is applied to the temperature at which the solid and liquid phases of a pure crystalline substance can remain in equilibrium; at the melting point, there is usually a discontinuous change of a number of its physical properties. In the case of those refractory materials that are either amorphous or heterogeneous mixtures or compounds of oxides or other substances, the term melting point is not a definite temperature; the change from the solid condition to one in which the material will flow is gradual over a temperature and time interval. In addition, physical and chemical reactions, which are not equilibrium reactions, often take place during melting.

With the rise in temperature of a refractory material, the first phenomenon of importance usually observed is the sintering or vitrification of the particles; that is, the edges of the particles first become soft and liquid and the particles stick together even though all parts of the material are at the same temperature.<sup>1</sup> As a result of surface tension, the soft edges

\* Assistant Physicist, U. S. Bureau of Standards.

<sup>1</sup> J. W. Mellor: "Clay and Pottery Industries," **32**, 247; **37**, 309. Griffin, London, 1914.

of the particles become rounded off. Sintering may also be produced by the fusion of the lower melting-point constituents, the formation of eutectics and solutions, and the chemical reaction of the constituents. If, as a result of these phenomena, a substance of sufficient fluidity to diffuse through the mass is formed, the whole body may flow while the solid particles are held in suspension. From the point at which the substance begins to sinter, it may become more viscous gradually, over a long range in temperature, until it flows, or it may soften and flow distinctly over a short range in temperature. While these materials have a more or less definite temperature interval of melting, or melting range, their softening is also a function of the time.

If the refractory material is a pure crystalline compound, it will have a definite melting point, in the strict sense. Nevertheless, there are such pure refractory compounds as quartz and albite, which soften very slowly and the melting interval of which is an interval of time; that is, a long time is necessary to attain equilibrium between the crystalline solid and the liquid.<sup>2</sup> For these substances, the temperature-time method is not suitable for the determination of the melting point. For practical and technical purposes, the criterion of marked flow is used for such substances. On account of superheating while melting, the melting point found by this method may be much higher than the true melting point, as in the case of quartz, where it is about 50° C. higher.<sup>3</sup>

By the term refractoriness of a refractory material is usually implied its resistance to the action of heat or, more definitely, its ability to retain its shape at high temperatures under accurately specified conditions. The term "refractoriness" is broader and more general in meaning than "fusibility," which is usually measured by the softening point or fusing point. The latter refers to the temperature at which the material begins to lose its shape and flows. The last mentioned phenomena ordinarily take place in several stages over a range in temperature. The sintering of the material produces shrinkage and bending; but this phenomenon should not be considered as taking place in the melting range.

Assuming that the sample is in the form of a cone or cylinder, the beginning of the deformation, bending, or squatting of the specimen marks the first stage of melting; the second stage begins when the material has fused into a lump or ball or, in the case of a cone, when the apex has touched the base; the third stage begins when the lump has flattened out and is fluid. These melting stages occur over temperature intervals of varying magnitude, depending on the substance; in many cases of more or less pure compounds, the material melts at a definite temperature or

---

<sup>2</sup> Day and Sosman: *Amer. Jnl. Sci.* [4] (May, 1911) **31**, 341.

<sup>3</sup> The temperature at which silica begins to flow is about 1750° C. See C. W. Kanolt: U. S. Bureau of Standards *Tech. Paper* 10. True melting point of crystalite is 1710° C. See Ferguson and Merwin: *Amer. Jnl. Sci.* (Aug., 1918) **46**.

over a very small temperature interval and thus it does not serve a useful purpose to demarcate the melting stages. That particular stage in the melting range which is to be considered as the melting point or softening point depends on the material and the extent of softening that will manifest the most information concerning some limitations of use of the material or the conclusions to be derived from the melting-point test. From a general and practical standpoint and wherever the conditions of use of the material are not specifically known, the knowledge of the temperature at which a marked and distinct flow of the sample begins is most important and useful as a fixed temperature as well as a comparison temperature.

The temperature at which a marked flow begins usually occurs after the start of the above-mentioned first stage of melting. Especially with samples in the form of a cone and cylinder and with rapid rates of heating, the beginning of the marked and distinct flow is seen to occur when the sample is about half bent over or halfway between the first two stages.

In general, then, the practical definition of the melting point of a refractory material is identical with that of its softening or fusing point and is arbitrarily stated to be the temperature at which a marked flow of the material begins. In terms of the deformation of a cone or cylinder, the melting point is halfway between the temperature at which the deformation begins and the temperature at which the material fuses into a lump or ball or is completely bent over. For most refractory materials, the melting point is, under specified conditions, reproducible and definite enough to be worth determining.

#### FACTORS AND CONDITIONS AFFECTING OBSERVED MELTING POINT

*Chemical Composition.*—It is evident that the chemical composition of a refractory material will affect, to a large extent, the observed melting point. While attempts have been made to determine a relationship between the melting point and composition of fireclays, no definite and complete connection has been found. In fact, no equilibrium diagram can be established for such complex and heterogeneous mixture as fireclays and firebricks; first, because of the large number of components, and, second, because of the inhomogeneity of the chemical constituents. For the same reasons it is difficult to determine empiric relations between the observed melting point (which is not an equilibrium temperature) and the composition. Nevertheless, chemical analyses will often indicate the relative refractoriness of different materials. Of course, where we have combinations of chemically pure oxides in which are formed definite chemical compounds, solid solutions or eutectics, the temperature versus composition or equilibrium diagrams have been established



for a number of groups of oxides, such as for the combinations of lime, alumina, magnesia, and silica.<sup>4</sup>

The addition of an impurity to a refractory material usually lowers its melting point. For instance, in fireclay substances, the addition of sodium, potassium, iron, titanium, calcium, or magnesium compounds produces a very marked depression of the melting point; the addition of silica to fireclay materials decreases the refractoriness while the addition of alumina increases it.

*Size of Particles and Shape and Position of Body.*—It is well known that, within certain limits, the smaller the particles of a refractory material the lower may be its melting point. The softening of the surface of the particles takes place at a lower temperature than the softening of the whole body en masse; in other words, the particles sinter together before the body flows. It is readily apparent that the smaller the particles or the finer the texture, the greater is the surface area exposed to softening. The fine division of the particles also allows a wider and more thorough distribution of the fluxing agents; consequently, the vitrification will proceed more rapidly, the solution and reaction of the constituents will be facilitated, and the material will flow at a lower temperature. On the contrary, a finer division of the particles may produce a wider and more thorough distribution of the higher melting-point constituents to the extent of raising the melting point.

The total effect on the melting point of varying the size of the particles ordinarily is not large. For example, in the case of a large number of samples of coal ash, those specimens ground "to an impalpable powder tended to soften at a slightly lower temperature than ash that would pass a 100-mesh screen. The difference averaged 6° C. and in no test exceeded 40° C."<sup>5</sup> Experiments made in the pyrometry laboratory at the Bureau of Standards on the melting points of silica foundry sands of particles just passing a 10-mesh screen showed no differences in melting point larger than the experimental error when the particles were ground to pass an 80-mesh screen. Other experiments on a fireclay brick gave a melting point of 1655° C. when ground to pass an 80-mesh screen and 1640° C. when ground to pass a 200-mesh screen. The melting point of the unground brick was found to be 1630° C. In this case it appears that the grinding served to modify the distribution of the different constituents in addition to reducing their size. All of these experiments were made under the same conditions.

Because the melting of a refractory material is accompanied by a more or less gradual decrease in viscosity, the temperature of marked flow

<sup>4</sup>R. B. Sosman: The Common Refractory Oxides. *Trans. Faraday Soc.* (1916-17) **12**, 254; *Jnl. Ind. & Eng. Chem.* (Nov., 1916) 985.

<sup>5</sup>Fieldner, Hall, and Field: U. S. Bureau of Mines *Bull.* 129, 114.

will be dependent on the original geometrical form and position of the substance. For example, pyrometric cones in the shape of a tetrahedron with the axes at various angles from the vertical will be subject to different bending moments while softening and falling over; thus when bent over, the degree of fluidity attained will not be the same. If the same substance were in the form of a short cylinder, it is probable that one would not be able to judge by the squatting of the cylinder the temperature at which the same degree of viscosity occurs as in the case of the cone; hence the melting point observed with a cylinder may be different from that observed with a cone. However, experiments made at this Bureau showed no difference between the melting points of a cone and cylinder of the same height placed vertically and heated under the same conditions. The cylinder measured 2.5 cm. in height and 1.2 cm. in diameter; the cone was in the shape of a tetrahedron, being 2.5 cm. high and having 8-mm. sides for the base.

*Time and Rate of Heating.*—The process of vitrification and melting of refractories is a matter of time as well as of temperature. Obviously, the longer the time during which the substance is held within its vitrification range the greater the extent of sintering; that is, the softening, melting, solution, or reaction of the components. Thus, if a refractory is held for a long time within its vitrification range, its fusibility will be increased; if a refractory is kept for a long time below the vitrification range, the sintering will not be appreciable. The melting point may be increased by the occurrence of a chemical reaction that results in the formation of a compound with a higher melting point than either of the components; rapid heating would, in this case, arrest the formation of such a compound. In the case of some materials prolonged heating brings about volatilization of the more volatile constituents, such as alkali compounds, with a consequent increase of refractoriness.<sup>6</sup>

The observed melting point will also vary markedly with the rate of heating. In accordance with the well-known principle of the increase in the rate of reaction with the rise in temperature, the speed of a vitrification is accelerated by raising the temperature; consequently, the faster the rise in temperature, the smaller is the total amount of sintering or vitrification. At the same time, by rapid heating the solution of the components and the formation of eutectics may be arrested considerably; thus some of the factors that can cause the material to flow are largely diminished in effectiveness.

It takes a long time for some pure refractory compounds to melt; thus the melting temperature will vary with the rate of heating, for the extent of superheating while melting will be different for every rate of

---

<sup>6</sup>J. W. Mellor: *loc. cit.*

heating. In practically all instances of impure refractory mixtures or compounds, the melting range will depend on the rate of heating also because of the time effect in melting. It is believed that the effect of a change of rate of heating is more marked, the closer one approaches the melting point.

As a general rule, and within certain limits, the faster the rise in temperature the higher is the apparent melting point. No better illustration of this can be found than with Seger cones, where the softening temperatures can be easily varied by 50° C. or more by changing the rate of heating.<sup>7</sup> At the Bureau of Standards, no difference in melting point was found in the case of a firebrick heated to the melting point in 1 hr. and one heated for 5 hr. In the case of very rapid rates of heating, the large temperature gradient in the sample may play a part in causing a high value for the melting point.

*Nature of the Surroundings.*—Several possible external conditions affect the melting point. The pressure of the atmosphere, *per se*, will have practically no effect; that is, it would take a pressure of many atmospheres to change the melting point even slightly. In an indirect manner, however, the melting point may be changed considerably in a vacuum; namely, the more volatile and fusible components, such as alkali and alkali earth compounds, may distill or sublime, thus causing a rise in melting point, and vice versa, those substances that go off at atmospheric pressure may not do so at higher pressures.

Due to chemical reaction with the gases in the atmosphere surrounding the refractory, its melting point can be altered considerably. In the case of some materials, coal ash, for example, the nature of the atmosphere is the factor exercising the greatest influence on the melting point.<sup>8</sup> The terms reducing, oxidizing, and neutral atmospheres are not sufficiently definite and, when considering the nature of the atmosphere, the gases present should be indicated. For example, in a reducing atmosphere either carbon vapor and carbon monoxide or hydrogen and water vapor may predominate; and the effect of one atmosphere may be totally different from that of the other.

In a carbon and carbon-monoxide reducing atmosphere, many refractories are very strongly attacked, the extent being dependent on the chemical composition, the pressure, and the temperature. Under some reducing conditions, ferric oxides in fireclay substances or other refractories are reduced to the ferrous state and combine to form low-melting-point silicates, which very materially increase the fusibility. In very strongly reducing carbon atmospheres, all the iron oxides may be reduced

---

<sup>7</sup> R. B. Sosman: The Physical Chemistry of Seger Cones. *Trans. Amer. Cer. Soc.* (1913) 15, 482.

<sup>8</sup> Fieldner, Hall and Field: *loc. cit.*

to metallic iron, thus preventing reactions with the silicates. At high temperatures, silica and silicates are reduced by carbon forming, under certain conditions, various compounds of silicon, carbon, and oxygen. On the other hand, in oxidizing atmospheres, some substances may be oxidized, allowing or preventing them from reacting with the refractory and bringing about a change in the melting point.

*Conditions in Use Affecting Apparent Melting Point.*—Substances coming in contact with the refractory, such as molten metals, slags, fluxes, and flue dust, often attack the refractory and may lower its melting point considerably. Since the temperature at which a refractory begins to flow is related to the degree of viscosity the material has attained, the application of a load will make the material deform faster and at a lower temperature. On account of the more intimate contact of the particles, the application of a load will allow a refractory to sinter at a lower temperature and the continued application of the force will result in the material softening or melting at a lower temperature. It also appears to be true that the larger the load applied, the lower is the temperature at which the material will soften and collapse. For instance, the softening point of a fireclay brick with no load was 1730° C. while with a load of 50 lb. per sq. in. it was 1200° C.<sup>9</sup> A fireclay with a softening point of 1650° C. gave a softening point of 1435° C. with a load of 54 lb. per sq. in.; and one of 1380° C. with a load of 72 lb. per sq. in.<sup>10</sup>

In general, so large a number of complex physico-chemical phenomena enter into the melting of a refractory material that it becomes impossible to predict in most cases in which direction the melting point will change by changing the factors and conditions under which the material is heated.

#### PRACTICAL DETERMINATION OF THE MELTING POINT

The ideal method of determining the melting point of a refractory material would be to observe it under the actual conditions of use; in most cases, however, this is practically impossible. What actually has to be done is to compromise between duplicating the conditions of use, on the one hand, and substituting feasible methods afforded by laboratory facilities, on the other; unfortunately one usually is compelled to decide almost wholly in favor of the latter. To determine the melting point under conditions approximating those of use or in such a manner as to form definite and specific correlations between the melting point and other properties in use very often demands, in the case of each material, extended and elaborate investigation (as, for example, the relation of the

<sup>9</sup> Bleining and Brown: U. S. Bureau of Standards *Tech. Paper* 7 (1911).

<sup>10</sup> J. W. Mellor: *loc. cit.*

melting point of coal ash and the degree of clinkering). Because of the great variation in the properties and characteristics of refractory materials, these conditions of test cannot be made the optimum for all materials; accordingly they cannot be made as detailed and special as if we were dealing with one type of refractory. As far as possible they should be logical, simple, and easily reproducible so that a standard and practical method for the determination of the melting point of refractories may be established.

The fact that conditions in use, such as load and chemical reaction, may give an apparent melting point widely different from that observed in the laboratory is no valid reason for determining the melting point very roughly, as by making Seger cone pyrometric measurements, and by varying and not specifying the size of the particles, the time and rate of heating, and the chemical nature of the atmosphere. Each of these factors introduces a variable into the value for the observed melting point; and if these factors are not specified and are varied from time to time, the observed melting point will not have a definite and reproducible meaning. Since the melting-point test is used as one of a number of tests to determine whether refractories conform to specifications, it is very essential that it should have a definite meaning to the extent that a melting-point test on the same material made in various laboratories should give practically the same value and that the value should be reproducible in the same laboratory. In order that this agreement be possible, the factors and conditions of the melting-point test should be practically the same or, at least, the existing factors and conditions should not be sufficiently divergent to produce large disagreements.

*Sampling, Grinding, and Molding.*—When the material of which the melting point is to be determined is a fireclay brick with comparatively large pieces of grog held together by fireclay, one cannot procure a representative sample by simply breaking off a piece at random. In the case of a firebrick or any other material in which there is not uniformity of texture and composition or the particles are larger than 30-mesh, the material should be carefully sampled. It thus becomes necessary to grind it, which makes molding of the material into a cylinder or cone a requisite. With bricks of fine and uniform texture, however, a piece may be chipped off and shaped into a cone or cylinder. Materials in the form of a fine powder can, after mixing, be briqueted directly.

As the size of the particles may affect the melting point, the degree of fineness to which the material has been ground should be specified, at least approximately. There is the possibility of grinding the material so fine that any further reduction will have no effect on the melting point; also of grinding the material just sufficiently to insure uniformity in distribution of the components and proper consistency to allow the form to retain its shape after briqueting. From the standpoint of the comparison

of the melting points of different refractories, the first is the better, but it involves the labor and time of fine grinding; the second is the more feasible and, for a large variety of materials, when a cylindrical specimen is used, grinding to pass an 80-mesh screen appears to be suitable. When cones are made, the material should be ground to 100- to 200-mesh and molded with a binder. A binder is not necessary with the cylindrical form, because, with the aid of a little moisture, the material can very conveniently be briquetted under pressure. A binder should not be used if it will attack the refractory. A 10 per cent. solution of dextrin in water is a satisfactory binder. After the sample is molded, it is safest to burn off the dextrin in an oxidizing atmosphere at about 600° C., and then determine the melting point.<sup>11</sup>

Since it appears that there is no material difference between the melting point of a cone 2.5 cm. high and having 8 mm. sides for a base and a cylinder 1.2 cm. in diameter and 2.5 cm. high, either may be used. As shown above, the cylinder is the most convenient to use.

Precautions should be taken that in no case the melting-point specimen is too large for the rate of heating used, because large temperature gradients may be set up in the specimen. The smaller the sample, the easier it is to maintain fair temperature uniformity in the sample in a laboratory furnace.

*Time and Rate of Heating.*—In order to approximate the usual conditions of use, the rate of heating would have to be slow and the time prolonged; such a course is not desirable or convenient in the laboratory. The time of heating should not be so long as to waste time nor to make it tedious to watch the specimen; nor should the rate be so fast as to mask the melting effect or to make the melting interval too short to afford sufficient time to measure the temperature at the melting point.

The time of heating from room temperature to about 1000° C. may usually be very short, for it is believed that the rate during this interval is not of much consequence. For materials melting around 1700° C., a total time of heating of not less than 30 min. and up to 2 hr., and a rate of heating (from about 50° below the melting point and during melting) between 5° and 10° C. per minute are satisfactory. The following table represents a temperature versus time curve of heating of a firebrick, the melting point of which was determined at the Bureau, with sufficient approximation:

| TEMPERATURE INTERVAL, DEGREES C.  | TIME, MINUTES |
|-----------------------------------|---------------|
| Room temperature to 1000.....     | 20            |
| 1000 to 1650.....                 | 25            |
| 1650 to 1700 (melting point)..... | 5             |

<sup>11</sup> For description of method of molding into a cone see Hofman: *Trans.* (1894) 24, 57; (1895) 25, 10; or Fieldner, Hall, and Field: *loc. cit.*, 29.

It should be emphasized that in stating the melting point of a refractory material the temperature-time curve must be represented as definitely as necessary to allow the duplication of practically the same value for the observed melting point.

*Type of Furnace and Conditions Existing in Furnace.*—The following may be said to be essential characteristics of a furnace for determining the melting point of refractories: It should be capable of easily reaching a temperature of  $1800^{\circ}\text{C.}$ , since most refractories melt below  $1800^{\circ}\text{C.}$ ; for those materials melting over  $1800^{\circ}\text{C.}$ , special procedure and technique are usually required. The atmosphere in the furnace should not react chemically with the specimen to any appreciable extent. Facilities should be provided for making temperature measurements with an optical pyrometer. Good control of the rate of heating should be possible. The type of furnace chosen depends, to some extent, on the original cost, the cost of operation, and the number of melting-point tests to be made.

The two general types of furnaces in use are the electric-resistance furnaces and the fuel-fired furnaces. They may be classified as follows:

*Electric Furnaces.*—Some form of carbon as resistor; such as graphite tube in air, crushed carbon or Kryptol, carbon plate resistor, graphite resistance vacuum furnace. Metal as resistor; such as iridium tube or wire and tungsten or molybdenum wire or tube.

*Fuel-fired Furnaces.*—Coal, coke, or oil, and gas-air or gas-air-oxygen.

Graphite or carbon-tube furnaces, with or without water-cooled electrodes, have been constructed in many forms. When operated under atmospheric pressure, the tubes do not last long on account of oxidation; they are somewhat protected from oxidation by passing a neutral or reducing gas through or around them. This gas may serve to carry away smoke so that optical temperature measurements may be made. With the graphite resistor, the atmosphere in the furnace is strongly reducing; many refractories are greatly attacked in a carbon and carbon-monoxide reducing atmosphere.<sup>12</sup>

By simple inspection of the melted sample, it is usually not possible to tell whether the reduction has reached appreciable proportions, thereby introducing great uncertainty into the melting-point determination. In many instances, the surface of the sample is attacked and a shell of higher melting point than the inner portion is formed. Thus, while the inner material may have been melted, no outward evidence of this fact is shown. Whenever possible, it is much safer and more desirable to protect the sample from the strongly reducing atmosphere (provided this type of atmosphere does not exist in actual use of the material) with a

---

<sup>12</sup> The gases in the atmosphere of a carbon-resistance furnace at high temperatures are principally carbon monoxide, nitrogen, and carbon vapor.

refractory tube of low porosity; and a slight current of air through this tube will serve to oxidize the reducing gases and drive off smoke. Porcelain tubes of Marquardt, or those approximating the composition of sillimanite  $\text{Al}_2\text{O}_3\cdot\text{SiO}_2$  (melting point,  $1810^\circ\text{C}.$ ) may be used for this purpose up to temperatures as high as  $1800^\circ\text{C}.$ , although they become soft and do not last long at this temperature. Well-sintered tubes or crucibles of alumina or magnesia or mixtures of the two may be used if they are thick enough. Unfortunately, protection tubes for use at higher temperatures are not readily obtainable, although they undoubtedly could be made.

Crushed-carbon, graphite, or kryptol, and carbon-plate resistor furnaces, in addition to the above difficulties, do not allow very accurate regulation. Also, some forms make it difficult to take optical temperature measurements. While a graphite-resistance vacuum furnace presents the difficulties of greater initial cost, of producing a vacuum, and of opening and closing large vacuum-tight joints, the atmosphere is kept free from smoke and good temperature uniformity can be maintained, thus facilitating optical temperature measurements. Higher temperatures can be more conveniently reached in the vacuum furnace.

In order that the carbon atmosphere in the vacuum furnace may have no appreciable chemical effect on the specimen, it is usually necessary to keep the pressure below 1 or 2 mm. Even then it is safer to protect the sample with a refractory porcelain tube closed at one end and suspended from the cool part of the furnace. This prevents the carbon vapor or particles shooting off from the resistor from gaining access to the specimen. Practically all the gases in the tube must come from the cool part of the furnace; and these gases consist of nitrogen and carbon monoxide in low concentration. It is also possible that the tube largely diminishes the convection of the reducing gases past the specimen and consequently the reducing action is not so great as without the tube. To prevent the sample or its container from sticking to the tube, they may be separated by a layer of powdered alundum.

For a laboratory in which a large number of melting-point determinations are made, a graphite-resistance vacuum furnace of the Arsem type is the most desirable electric furnace; the lasting operation of the resistor, the clarity of the atmosphere, the rapidity of action and excellence of control and the good black-body conditions afford, with suitable protection for the sample, the most convenient and precise method of melting refractory materials in an electric furnace,<sup>13</sup> see Fig. 1.

Several furnaces with metals as the resistor and capable of attaining temperatures of  $1800^\circ\text{C}.$  or higher have been constructed. Iridium in the form of tubes or wire has been used by a number of investigators; but

---

<sup>13</sup> For description of use of Arsem furnace in melting refractories see C. W. Kanolt: U. S. Bureau of Standards *Tech. Paper* 10 and *Sci. Paper* 212.



this metal is so expensive and volatilizes so readily that it is ordinarily outside the range of metals accessible for a practical furnace. Tungsten

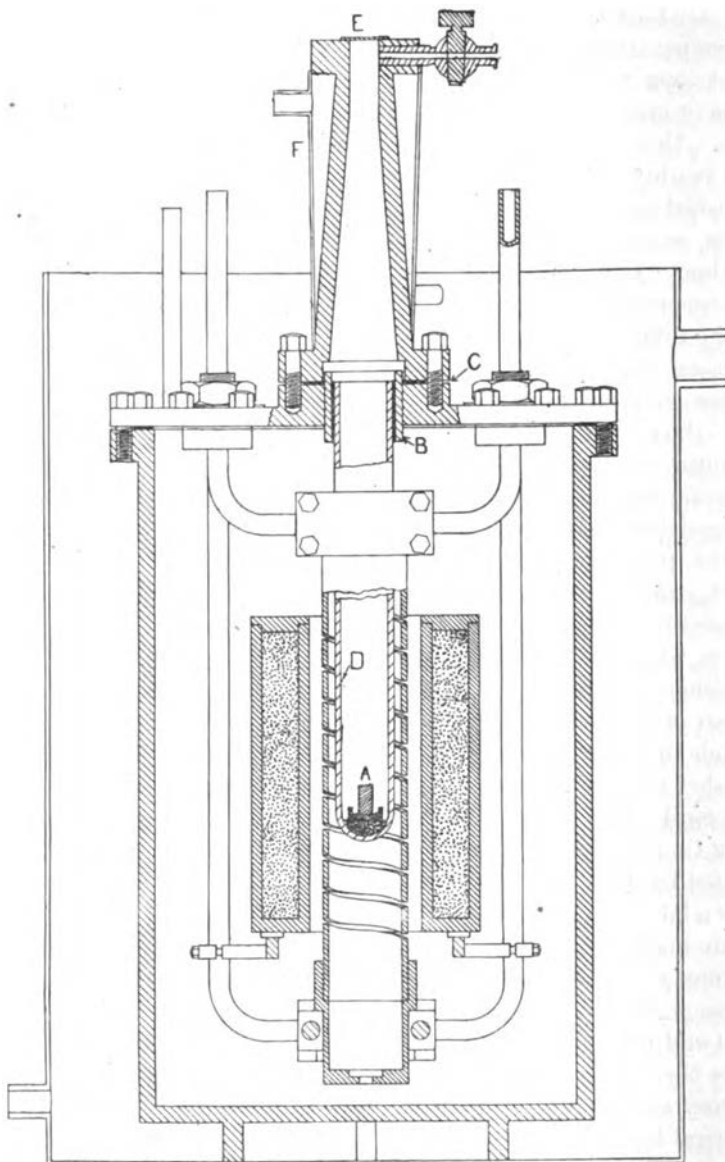

FIG. 1.—CROSS-SECTION OF ARSEM GRAPHITE RESISTANCE VACUUM FURNACE. A IS COMPRESSED CYLINDRICAL SAMPLE. D IS SILLIMANITE PROTECTION TUBE.

and molybdenum have been used considerably in the form of wire wound on refractory tubes. For lasting operation, it is requisite that the wire

be protected from oxidation by surrounding it with a reducing atmosphere, preferably with hydrogen. Obstacles in the way of general adoption of these furnaces are the danger of hydrogen explosions and the difficulty of obtaining hydrogen in sufficient quantity. Even in the reducing atmospheres, the resistors do not have a long life, as they become brittle.

Furnaces with tubes of tungsten, molybdenum, or similar high melting point metals are still in the experimental stage. They should be run in a vacuum or hydrogen and, apart from the absence of a carbon or carbon monoxide reducing atmosphere, they are not so advantageous as graphite resistance vacuum furnaces. Coal, coke, or oil-fired furnaces have been used for melting refractories, but they are unsuitable for laboratory furnaces in which small masses are placed and for which accurate control is an essential. They are too large and are inconvenient on account of dirt, smoke, and possibly a strongly reducing atmosphere; besides, it is not easy to obtain the requisite high temperature.

Gas furnaces offer, besides the electric furnace, the only other practical means of attaining high temperatures. In the case of furnaces using illuminating gas made from coal and air at 2 or 3 lb. (0.9 or 1.4 kg.) pressure, the maximum temperature reached in an ordinary furnace is about 1400° C.; when burning natural gas, temperatures 100° or 200° higher may be attained. With air pressures at 10 lb. (4.5 kg.) and over and illuminating gas, it is possible to obtain temperatures as high as 1650° C.; and in the case of natural gas, as high as 1800° C. By recuperating the waste heat or by preheating the gases, these temperatures could be raised considerably; also, by the addition of oxygen, temperatures over 2000° C. have been maintained. These statements are very general and may not hold in the case of a number of furnaces; they are not intended as a complete statement of the problem of attaining high temperatures in gas furnaces.

It is quite a different matter to obtain a temperature, say, of 1750° C. uniformly over a space of several cubic inches than it is to reach this temperature in a small spot. For melting refractories one should be able to obtain a uniform, high temperature over a sufficient volume to procure reliable results. In order to do this, it is usually necessary to enclose the specimen in a refractory crucible or muffle. At present, one of the difficulties is that of refractories for the lining and crucibles to contain the specimen—a problem that is, perhaps, more difficult of solution for gas furnaces than for electric furnaces.

The Bureau of Standards has been working on the problem of designing a gas furnace suitable for the determination of the melting point of refractories but has not yet perfected it. Gas furnaces can be made in convenient laboratory form and, on account of their simplicity, low initial cost and cost of operation, and the comparative ease with which high

temperatures are obtained, probably will offer, after considerable development, the best solution of the problem.

The question of the atmosphere in the furnace is intimately bound up with the type of furnace used. Probably most refractories used in industry are heated in a reducing atmosphere. But it is not possible to reproduce exactly these conditions in the laboratory. Carbon-resistance furnaces are very liable to have a strongly reducing atmosphere; means for avoiding this have been described before. Gas furnaces, on the other hand, which are intended for use at the higher temperatures usually have oxidizing atmospheres. Since a refractory would ordinarily have its lowest melting point in a slightly reducing atmosphere, such a one may be preferable. At the present stage of development of furnaces, however, the question of the best type of atmosphere must be left unsettled.

*Temperature Measurements and Observation of Melting.*—For a very rough measurement of the melting temperature of a refractory, the temperature as indicated by the melting of a material the melting point of which is known—by a pyrometric cone—has often been taken. The refractory is then said to have a softening temperature corresponding to a certain cone number. The reason given in justification of this process is that cones are used in furnaces, or kilns, in which ceramic products are fired to measure temperatures, or at least heat effects. But the cones are used in the ceramic industry under quite different conditions from those when softening points are determined. First, the rate of heating of the cone is much slower in a kiln than in a laboratory furnace. Second, the cone is heated in the kiln over a short range of temperature. The cone serves in such a case as a sort of integrator of the time versus temperature curve of heating. When a small range of cones is heated under the same circumstances the practical ceramist can draw conclusions from the deformation of those cones, which serve to indicate the proper degree of firing of his products.

But in the laboratory, where a rather large range of cones is used and where the rate of heating is comparatively rapid and may vary from time to time, the determination of the cone softening point is not of much significance and serves no useful purpose in practice. What should be done is to determine the point at which the refractory softens on a uniform and reproducible temperature scale under properly specified conditions. This, we believe, reduces the number of variables in the determination to a minimum and affords more reliable results.

It has repeatedly been shown and emphasized that the softening point of Seger cones depends on a number of factors and conditions similar to those affecting the melting of other refractories. That is to say, the softening point depends, to some extent, on the nature of the atmosphere but, most important of all, on the time and rate of heating. Usually the more rapid the heating, the higher is the softening temperature;

50° to 75° C. difference in softening temperature easily results from varying the rate of heating. Cones do not even measure heat effects with any semblance of precision when employed under different conditions; it is possible to subject a cone to different conditions of heating and still produce the same amount of deformation. As far as an approximate measure of a reproducible temperature or heat effect is concerned, the indication of a Seger cone is unreliable even for commercial precision, unless the nature of the atmosphere in which the cone is heated and the temperature versus time curve of heating are specified. Even though these conditions are specified, there is no way of accurately deducing a common basis of comparison of temperature or heat effect when the cones are used under different conditions.

To measure the temperature of melting with sufficient accuracy, it is necessary to use some form of optical or radiation pyrometer. With relatively slow heating, it is possible to use a Wanner or a Féry optical pyrometer by alternately watching the specimen melt and sighting through the pyrometer to measure the temperature. A more rapid and precise instrument, however, and one which permits the observation of the specimen simultaneously with the measurement of its temperature, is the Holborn-Kurlbaum type of Morse optical pyrometer.<sup>14</sup> In determining the temperature with any form of optical pyrometer, it is essential that sufficiently good black-body conditions exist in the furnace as it is impossible to apply any reliable emissivity correction. With electric furnaces and with gas furnaces containing muffles or crucibles in which the specimen is heated, it is not difficult to obtain good black-body conditions; even a slight departure from a perfect black body will enable one to discern the specimen. To see the specimen with sufficient clarity, it is usually necessary to keep the eye constantly fixed on it and its surroundings.

In sighting on a melting specimen, it is sometimes important to sight on a surface that is rather oblique to the line of vision, for the surfaces that are more or less perpendicular to the line of vision may appear darkened in the field because they do not reflect any light from the surroundings into the pyrometer and because their emissivity is low. In this connection, one should guard against the condition of sighting on a surface reflecting light from a hotter spot for in such a case the measured temperature would be higher than the true temperature. The atmosphere between the pyrometer and the sample must be perfectly clear, that is, free from smoke or flames, because the latter act as an absorption screen, causing errors of an uncertain magnitude.

As a rule the flow of the sample can be observed a great deal more dis-

---

<sup>14</sup> This pyrometer is manufactured in this country by The Leeds & Northrup Co., Philadelphia Pa.

tinctly when sighted on sidewise rather than from above; that is, in the former case the change in linear dimensions and in position appears greater to the eye. In the Arsem vacuum furnace the sample is viewed from above, consequently the point at which a marked flow of the sample begins is rather difficult to observe, being subject to the personal equation of the observer. We see, then, that to measure the temperature of melting of a refractory material it is advisable to use a Holborn-Kurlbaum type of the Morse optical pyrometer; to be sure that sufficiently good black-body conditions are maintained; to sight on the proper part of the specimen; and finally, to be sure that the absorption of the atmosphere is negligible.

### DISCUSSION

J. S. UNGER,\* Pittsburgh, Pa. (written discussion†).—Firebricks intended for the same purpose, but supplied by different manufacturers, may be of entirely different clays, contain different proportions of flint, calcined and plastic clays; the particles may vary widely in size; the water used to make the brick will vary; the pressure in molding will vary, depending on whether the brick is hand made or power pressed; and the degree of burning in the same kiln will differ. These variables affect the melting point and the strength of the brick when heated.

An important property of a firebrick is its ability to resist heat and, at the same time, weight or load without serious deformation. The softening point and the melting point of a firebrick may be several hundred degrees apart, and two bricks may show considerable difference in their softening points, but the melting points may be approximately the same. Bricks are not usually employed at temperatures close to their melting points. If they must withstand very high temperatures, the firebrick is discarded and a brick of more refractory material is used. Under these conditions it is doubtful whether the determination of the melting point of a brick has much practical value.

If the determination of the melting point is necessary, the test should be made on a portion of the original brick and not on a specially prepared sample. A small triangular pyramid with a base about  $1\frac{1}{2}$  in. and 3 in. high can be sawed from the corner of the brick with a thin-bladed carborundum wheel, without injuring or destroying the size of particles, the bond, or degree of burning of the original brick. This specimen can then be compared with standard Seger cones or tested by any other method desired.

P. D. FOOTE, Washington, D. C.—Probably more "melting-point" tests of firebrick have been made at the Bureau than all other high-temperature tests combined and I feel sure that the consensus of opinion

\* Manager, Central Research Bureau.

† Received Sept. 25, 1919.

among manufacturers is that the melting-point determination furnishes some desirable check. Where possible, we cut pyramids and cones from firebrick, but frequently the bricks are of such coarse texture that this method would not give a fair sample. In such cases we make the little cones from the ground material, realizing, of course, that the method influences the results obtained. Obviously the melting-point determinations are not failure tests. The Bureau of Standards makes failure tests but these were not considered in this paper. Mr. Dana has carefully defined what is meant by "melting point" and on the basis of this definition the paper is consistent and the data obtained are reliable and conclusive.

R. C. PURDY, Worcester, Mass.—We should keep in mind that the fusion of clay is only a progressive proposition. When the bricks are burned, that is, formed and burned in the kilns, a certain amount of fusion has taken place, permitting the bricks to attain a mechanical strength. The melting point, erroneously so called, is only the carrying of fusion to the stage where the cone will not sustain its own shape, that is, without a load. The load test or the softening point, as referred to erroneously again, if you will, is a measure of the degree to which the material has been softened by fusion sufficient to be unable to sustain the standard load. Both of them are measuring the same thing except that the softening test is a measure of resistance to pressure of the softened mass. At the temperature of the load test, the clay is more or less molten. The melting-point test or, more properly speaking, the fusion test, gives the temperature or heat treatment required to so soften the clay that it will deform or flow under pressure of gravity.

A protection shield made of fused bauxite will have a great deal of strength. A piece 12 in. by 1 in. by  $\frac{1}{2}$  in. suspended between knife-edge supports 10 in. apart will not be deflected by a 3-lb. load applied midway between supports and heated for several hours at 1450° C.

The same thought can be carried to firebrick. A firebrick made of fused bauxite will sustain loads well up to the fusion point of the crystallized alumina whereas bricks made of fireclay will be deformed under load at temperatures and heat treatments much lower than is required when no load is applied.

There is no such thing as a melting point of clay; it is a progressive fusion, and to speak of melting point or softening point is not accurate.

LEO I. DANA (author's reply to discussion\*).—I believe the determination of the melting point of a firebrick is of great practical value. It serves to show the upper limit of temperature beyond which the brick must not be heated under any conditions of use, under no load included. Of course the conclusions to be drawn from this test should be correlated with the results of a number of other tests made on the re-

---

\* Received Jan. 17, 1920.

fractory, such as the softening point under load, the chemical composition, etc. At any rate, the melting-point test has been included as a desirable test by the American Society for Testing Materials.

In order that this test may have the same meaning and give the same results in various laboratories, it is necessary that it be standardized in such a way that the least number of variable factors possible enter into the test. This I have attempted to do; and the reasons for using a specially prepared sample, and for not employing Seger cones, are fully discussed in the paper.

The fact that the ordinary refractory materials melt, soften, or fuse over a range of temperature and time has been pointed out in the paper. In attempting to fix this phenomenon, the upper and lower limits of the range or some one particular point in it must be defined. Because the phenomenon is one of plastic law, a certain degree of indefiniteness is inherently attached to the upper, lower, or any other point of the melting range. As a result of melting-point determinations of a large number of various refractory materials in the Bureau of Standards' laboratories, it appeared that the simplest and most exact method of fixing the phenomenon so as to be reproducible was to define it as the temperature at which a marked flow of the sample began, other controlling conditions, such as time and rate of heating, being specifically stated. In the light of this definition, the melting, softening, and fusing points are synonymous. The term "melting point" was chosen, because it is the most general phrase describing the phenomenon.

## High-temperature Scale and its Application in the Measurement of True, Brightness, and Color Temperatures

BY EDWARD P. HYDE,\* CLEVELAND, OHIO

(Chicago Meeting, September, 1919)

AT the basis of optical pyrometry lie the theoretical and experimental data of the so-called *black body*. The black body is essentially a theoretical conception, with certain simple properties attributed to it—fundamentally, the property that its radiation at any temperature is a unique function of the temperature and does not involve any other variables. As a theoretical conception, an equation has been developed by Boltzmann connecting the total radiant power with the temperature, and another equation by Planck connecting the distribution of radiant power throughout the spectrum with the temperature. The integral of the latter with respect to wave-length conduces to the former and permits the evaluation of the constant  $c_1$  of the Planck equation, as given in the form

$$J = c_1 \lambda^{-5} \frac{1}{e^{\frac{c_2}{\lambda T}} - 1} \quad (1)$$

assuming that the constant  $\sigma$  of the Stefan-Boltzmann law

$$E = \sigma (T^4 - T_0^4)$$

is known. The other constant  $c_2$  is arrived at by other methods, which will be discussed later. This equation for the black body lies at the foundation of optical pyrometry.

To make the discussion complete, it should be stated that the theoretical black body is quite closely realized by a hollow enclosure with walls at a uniform temperature and radiating through a small orifice. The electrically heated black body, first introduced by Lummer and Kurlbaum, is an essential part of the equipment of a pyrometric research or testing laboratory. Numerous investigations have shown that its radiation conforms to that of the theoretical black body within experimental errors. Hence by operating the electrically heated black body at the melting point of some pure metal for which the temperature of melting has been determined on the gas scale, a standard is obtained for comparison with the radiation from other substances; and starting with this, other high temperatures of the black body may be obtained by the use of Planck's equation.

\* Director, Nela Research Laboratory.



To establish a correct high-temperature scale it is necessary to adopt the melting point of some convenient metal, to determine with accuracy the value of the constant  $c_2$ , and to select some method, free from error, by which a monochromatic radiation may be secured, if the temperature scale is to be extended in the usual way.

Before discussing these various points it is well to note that the Planck equation may be reduced, for all ordinary temperatures and for wave-lengths within the visible spectrum, to the simpler form of the Wien equation

$$J = c_1 \lambda^{-5} e^{-\frac{c_2}{\lambda T}} \quad (2)$$

without introducing any appreciable error. The equation in this form is used in most practical work; and for temperatures not in excess of  $3000^\circ$  K. and for wave-lengths not in excess of  $0.7\mu$ , it is correct to within an error of 0.1 per cent.

It is necessary, in practice, first to connect the experimental black-body scale with the gas scale by the adoption of the melting points of one or more pure metals, the temperatures of melting of which have already been determined. There are a number of these to select from as a result of the classical work of Day and Sosman,<sup>1</sup> who carried the gas scale up to the melting point of palladium, including in their measurements the melting points of gold, copper, tin, etc. Of these various metals, gold and palladium have probably been used most frequently. Gold is given by them as melting at  $1335.6^\circ$  K. ( $273^\circ + 1062.6^\circ$  C.) and palladium at  $1822.5^\circ$  K., and until recently both of these melting points have frequently been adopted as two points on the high-temperature scale. Within the last few years, however, it has been found, as the result of researches at Nela Research Laboratory and at the Reichsanstalt, that the two values are not quite consistent if the most probable value of  $c_2$  is taken and if precautions as to monochromatic radiation are followed. It has therefore been proposed in this country that the melting point of gold, as given by Day and Sosman, be adopted as the standard temperature, since this is several hundred degrees lower than that of palladium, and hence quite probably more nearly correct. On this proposed scale, the melting point of palladium is found to be  $1828^\circ$  K., and the radiation from the black body at the melting point of palladium with this new value is frequently used as a secondary standard in pyrometrical calibrations and measurements.

The constant  $c_2$  has been assigned various values as investigation has proceeded, starting with the value  $c_2 = 14,500\mu$  deg. as found in the early work of Lummer and Pringsheim. As the result of a number of recent investigations, including the extended work of Coblenz and the

---

<sup>1</sup> *Am. Jnl. Sci.* [4] (1910) 29, 93.

careful evaluation by Millikan from data obtained on the photoelectric effect and interpreted in terms of the quantum theory, the most probable value of  $c_2$ , in the light of all data available, is taken as  $14,350\mu$  deg. Recently the laboratories of the General Electric Co.<sup>2</sup> adopted, as the most probable high-temperature scale, that based on the melting point of gold as  $1336^\circ$  K. and the value  $c_2 = 14,350\mu$  deg.

As stated, the only other obstacle in the way of experimentally extending the optical scale from the accepted gold point lay in the difficulty of properly securing monochromatic radiation, or, what amounts to the same thing, of determining the effective wave-length of transmission of the so-called monochromatic red glass filters commonly used in the eye-pieces of optical pyrometers. Since this question will be discussed in another paper to be presented at this symposium, it need only be mentioned here.

### TRUE AND BLACK-BODY TEMPERATURES

With a properly calibrated optical pyrometer, it is a simple matter to measure directly the true temperature of any radiator that has the properties of a black body. But it is well known that no material substance possesses the radiating properties of a black body. At any given temperature not only is the radiant flux<sup>3</sup> less than that of a black body at the same temperature because its emissive power<sup>4</sup> is less than unity, but also the distribution of radiant flux in the spectrum is, in general, different from that of the black body at the same temperature owing to the non-uniformity of the emissive power of the substance throughout the spectrum. For platinum and tungsten, and possibly for one or two other substances, the true temperatures have been determined and the characteristics just described have been verified. Particularly in the

---

<sup>2</sup> *Gen. Elec. Rev.* (1917) **20**, 811.

<sup>3</sup> *Radiant flux* has been defined, in the 1918 report of the Committee on Nomenclature and Standards of the Illuminating Engineering Society, as "the rate of flow of radiation evaluated with reference to energy and . . . expressed in ergs per second or in watts." In the present paper, it is also used to express the rate of flow of radiation per unit wave-length, as well as the integral rate of flow for the entire spectrum. The context will show, in each case in which the expression is used, which significance is intended.

<sup>4</sup> By the *emissive power* of any radiating body at a given wave-length and for a given temperature is meant the ratio of the radiant flux per unit area emitted by the body at the given wave-length and for the given temperature to that emitted by a black body at the same wave-length and for the same temperature. The term *emissivity* has been used by some authors to express this same quantity, but others prefer to use this term to signify the radiant flux emitted per unit area, measured in absolute units. According to these authors the term *relative emissivity* would replace the term *emissive power* employed in the present paper. It is to be understood that unless some spectral limitation is imposed the *emissive power* refers to the *total radiant flux* for the complete spectrum.

case of tungsten elaborate studies of its radiating properties and an accurate determination of its true temperatures have been made.

For practically all substances other than the two or three mentioned, it is necessary to content oneself with apparent temperatures. It is for this reason that the term *black-body temperature* has come into use; but whereas it has been employed in a unique way, there are now recognized at least two essentially different kinds of apparent black-body temperature in optical pyrometry, and still a third kind if total radiation pyrometry is included. Hence it becomes necessary to be more explicit and to adopt a nomenclature that will adequately discriminate between them.

As formerly used, the term *black-body temperature* of a hot, radiating substance signified the temperature of a black body at which its radiant flux at a given wave-length, usually in the neighborhood of  $0.65\mu$ , was the same as that of the radiating substance the temperature of which was desired. This determined temperature was not that of the substance, because the emissive properties of the latter are known to differ by an unknown amount from those of a black body. But by determining the temperature of the black body at which it would have the same brightness in some specified spectral region as that of the substance under investigation, an empirical scale of apparent temperature would be established for the hot substance and so furnish a means of reproducing any given hot condition and of comparing the properties of the radiating matter at various conditions of apparent temperature.

Since recently there has come into fairly common use in optical pyrometry a second kind of apparent black-body temperature, viz., *black-body color temperature*, to which reference will be made shortly, it is necessary to further qualify the general term *black-body temperature* in its older significance. This quantity, in its use in Nela Research Laboratory, has come to be designated as *black-body brightness temperature*, or, in brief, *brightness temperature*, and the author suggests here the acceptance of this term, and furthermore the acceptance of the symbol  $S_{\lambda_i}^{\circ}\text{K.}$  to represent it.<sup>5</sup> The subscript is intended to show the wave-length at which the brightness equality has been obtained, and  $^{\circ}\text{K.}$ , consistent with much good practice, is added to show that the temperature is expressed on the so-called Kelvin scale, that is, in degrees centigrade  $+273^{\circ}$  on the gas scale.

With respect to the second kind of apparent black-body temperature in use in optical pyrometry, attention is recalled to the previous discussion of the various ways in which the radiating properties of a substance may differ from those of a black body. Not only is the emissive power of a substance always different (less) from that of a black body, but in general

<sup>5</sup> See footnote 6.

the emissive power of a material substance will vary from wave-length to wave-length throughout the spectrum. Hence one may establish the hot condition of a substance not only by determining its black-body brightness temperature but also by determining the temperature of a black body at which the ratio of the radiant flux at some two arbitrarily chosen wave-lengths  $\lambda_1$  and  $\lambda_2$  is the same as that for the substance under investigation. This method of obtaining an apparent temperature is based on the distribution of radiant flux, rather than on the absolute amount of it in any one wave-length. It frequently happens in the case of radiating metals that the relative distributions of radiant flux, taken the same for the radiating substance and for the black body at  $0.7\mu$  and at  $0.5\mu$ , *i.e.*, near the two ends of the visible spectrum, are found by experiment to be essentially the same throughout the visible spectrum. In such cases the color of the light from the substance and from the black body would be identical.

Since the application of this method of determining an apparent black-body temperature by comparison of the distribution of the spectral radiant flux of a substance with that of a black body was made first by use of the integral color, this apparent black-body temperature is called the *black-body color temperature*, or, briefly, the *color temperature*. In its more general use, it refers to the relative radiant flux in two wave-lengths, and the following symbol for its designation is proposed,<sup>6</sup>  $T_{C(\lambda_1, \lambda_2)}^\circ \text{K}$ . When the measurement is made by means of the integral light the term in parentheses may be omitted.

As stated, there is a third kind of apparent black-body temperature if total radiation pyrometry is included. Thus the determination of the temperature of a black body at which its integral radiant flux equals that of the given radiating substance at the given unknown temperature furnishes an empirical measure of its temperature. This method of pyrometry is in practical use. The apparent temperature obtained by this method should be designated as the *black-body total radiation temperature*, more briefly, the *total radiation temperature*, or still more briefly in practice, the *radiation temperature*. As a symbol  $T_R^\circ \text{K}$ . is suggested.

#### RELATION BETWEEN TRUE, BRIGHTNESS, AND COLOR TEMPERATURES

It would be well if in every case one could arrive at the true temperature of a hot substance, even though in many cases any means of reproducing definite temperature conditions are satisfactory. But generally

<sup>6</sup> If  $T$  is the symbol chosen to represent temperature it would be more consistent to express brightness temperature by  $T_{B(\lambda_1)}^\circ \text{K}$ . rather than by  $S_{\lambda_1}^\circ \text{K}$ . as proposed. Since, however, the latter term is so generally used, the author hesitates to suggest a change that might cause confusion.

it is not feasible to measure the true temperature. The best that can be done is to measure an apparent temperature such as the brightness or color temperature. In cases where an approximation to true temperature is for some reason particularly desirable, it is helpful to learn what is known regarding the relations, if any, that exist between true, color, and brightness temperatures.

There is one relation that exists without exception, viz., that the brightness temperature of a radiating substance is always less than the true temperature. This then gives a limit in one direction, though it throws no light on the difference between true and brightness temperature for any particular substance. Another relation has been found to hold for tungsten and platinum, and quite probably holds for many other metals but is not universally true, viz., that the color temperature for these metals at high temperatures is always higher than the true temperature, thus giving an upper limit to the true temperature. Moreover, for tungsten and not improbably for many other metals, the color temperature, though higher, is much nearer the true temperature than the lower limit given by the brightness temperature.

The two methods of determining apparent black-body temperatures have their respective merits as applied to different cases, and in many cases both may be used advantageously. It is not the place in this paper, however, to enter upon a discussion of these matters, or to introduce a discussion of accuracy attainable or of special experimental difficulties.

## Theory and Accuracy in Optical Pyrometry with Particular Reference to the Disappearing-filament Type

BY W. E. FORSYTHE,\* CLEVELAND, OHIO

(Chicago Meeting, September, 1919)

WHEN measuring ordinary temperatures, the instrument is generally placed in very close contact with the body the temperature of which is desired. However, if the temperature of the source is continually raised, a point is soon reached where no known substance will, in general, remain constant in any of its temperature-measuring properties if placed in direct contact with the source. Also, it is occasionally necessary to measure the temperature of a source that is so small or so situated that it would be very hard to bring the measuring instrument into direct contact with the source. When these conditions exist, advantage is taken of the well-known fact that all bodies, when at sufficiently high temperatures, send out radiation in amounts readily measurable. This radiation has been found to be related to the temperature. The temperatures of very hot bodies have probably always been judged by the color, or the brightness, of the light given off. With practice, one can estimate probably within  $50^{\circ}$  to  $100^{\circ}$  C. of the correct value. However, if judgment is left to the eye alone, very much larger errors are sometimes made, due to the use that has been made of the eye just previous to the time of estimating. To secure accurate estimates by eye, a comparison source is necessary.

The introduction of a comparison source is the first step toward an optical pyrometer, which consists of a comparison source and some convenient arrangement for matching this source, either in brightness or in color, against the source studied. In Fig. 1 is shown diagrammatically the arrangement used in one form of the Le Chatelier optical pyrometer. The light from the comparison source at *C* is reflected into the eyepiece by a mirror *E* so arranged that one-half of the field is illuminated by light from the comparison source and the other by light from the source studied. The match is obtained either by varying the intensity of the comparison source or by varying the size of the opening before the objective lens *D*. In the Wanner optical pyrometer, the beams of light from the comparison source and the source studied are so arranged that, by the use of a polarizing device, the two beams, as viewed through the eyepiece, are polarized in a plane at right angles to each other. By rotat-

---

\* Physicist, Nela Research Laboratory.

ing another nicol located in the eyepiece, the two sources can be made to appear the same in brightness.

The disappearing-filament type of optical pyrometer is very simple in its construction, being practically a telescope in appearance. It differs from a telescope in that it contains, for use as a comparison source, a lamp filament, called the pyrometer filament, which is located at the focus of the objective lens. In series with this filament is a small battery, a resistance, and an ammeter. To measure the temperature of any hot body with this pyrometer, the instrument is first sighted upon the hot body, which is done as easily and in much the same manner as the focusing of an opera glass. When looked at, the hot object is seen with the pyrometer filament crossing it, so that the filament appears much the same as the cross-hairs in an ordinary telescope. By varying the current, the

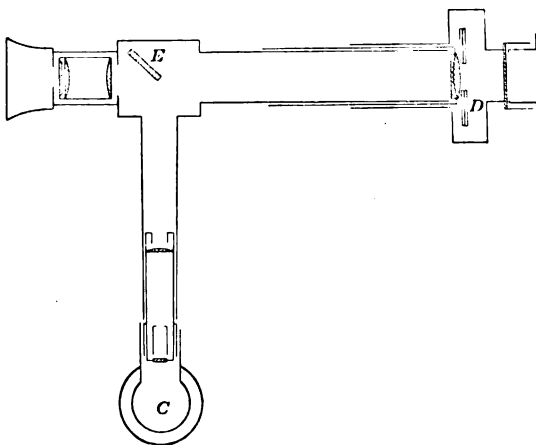

FIG. 1.—ARRANGEMENTS USED IN ONE FORM OF LE CHATELIER OPTICAL PYROMETER.

brightness of the filament will change and it can be made to disappear against the image of the source studied. By mounting a piece of red glass in the eyepiece, it is much easier to tell when the brightness of the object sighted upon and the comparison source are the same.

When working with optical pyrometers, certain precautions are necessary if errors are to be avoided. In this paper an attempt is made to discuss fully some of these precautions and also some of the principles governing the accuracy and use, in particular as applied to the disappearing-filament type of optical pyrometer. There are also included the results of several experiments with this type of pyrometer, and several reasons why it has been used quite extensively in the research laboratories of this country and is being used more and more in industrial work. These experiments show that different observers working with the same pyrometer will obtain almost exactly the same readings and

that different pyrometers of this type, calibrated in different laboratories by different observers, agree very well in their readings.

*Definition of Black Body.*—Kirchhoff has defined the black body as one that will absorb all the radiation that it receives; that is, it will neither reflect nor transmit any of the incident radiation. He also showed that the radiation from such a body is a function of the temperature alone. There is no known substance that has exactly this property, the nearest approach is probably some form of untreated carbon. As a cavity with walls at a uniform temperature possesses the properties of a black body, the radiation issuing from a hole made in the wall of the cavity will obey the laws of black-body radiation.

Many attempts have been made to realize this uniformly heated cavity with an opening through which the radiation can be studied. The one most commonly used for temperatures above 1000° K. consists of a refractory tube more or less uniformly wound with platinum ribbon, and containing a central and other diaphragms with small holes in them. For temperatures as high as the melting point of palladium (1828° K.), it is necessary to have a second refractory tube outside of the first; this tube also is wound with platinum ribbon but the windings are spaced farther apart at the center than at the ends, in order to correct for the end cooling. Such a furnace with the space between these two heater tubes filled with very pure aluminum oxide and with two tubes slipped inside of another tube that has been packed with a good heat-insulating material has been found to work very well. If this outside tube and its packing extend well beyond the ends of the heater tubes, the end cooling will be very much reduced. Such a platinum-wound black-body furnace has been heated to the temperature of melting palladium a dozen times and held at this high temperature for several hours each time, and is still in working order.

In any form of optical pyrometry where the temperature of a black body is determined by a measurement of the brightness for a particular wave-length interval, the temperature is calculated from the brightness measurement by means of Wien's equation  $E_{\lambda} = c_1 \lambda^{-5} e^{-\frac{c_2}{\lambda T}}$ . One of the advantages of optical pyrometers can be seen by an investigation of this equation. For a particular wave-length interval (0.665 $\mu$ ), the brightness varies about twelve times as fast as the temperature for a temperature of about 2000° K. Wien's equation, which is hardly more than an empirical law, has been found experimentally to represent the facts quite accurately for such temperatures and wave-lengths for which the product  $\lambda T$  is less than 3000. Thus for optical pyrometry where the longest wave-length used is less than 0.7 $\mu$ , the equation is valid and an instrument thus calibrated may be used throughout a wide range of temperature.



It is not absolute measurements of brightness that are made with the optical pyrometer, but rather comparisons of brightness, that is, the brightness of the unknown source is compared with that of a standard black body at a particular temperature. Using Wien's equation in this way requires but the one constant  $c_2$ . The value of  $c_2$  that fits best all the different experimental data<sup>1</sup> is  $14,350\mu$  deg. High-temperature scales are based on the brightness of a black body at the temperature of the melting point of some one or more selected metals. Owing to their convenience, both as to their freedom from oxidization and as to the temperatures of their melting points, gold and palladium are generally chosen. The value generally accepted for the melting point of gold is  $1336^\circ$  K., which is the value found by Day and Sosman.<sup>2</sup> This value for the gold point together with the above value of  $c_2$  leads to  $1828^\circ$  K. as the palladium point.

### THE DISAPPEARING-FILAMENT PYROMETER

The disappearing-filament type of optical pyrometer is known in this country as the Morse or the Holborn-Kurlbaum pyrometer. An early

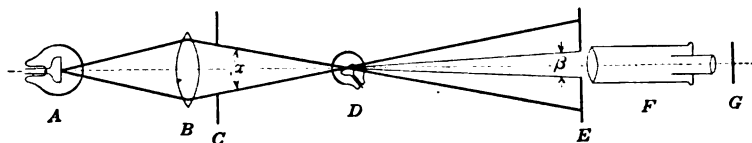

FIG. 2.—ARRANGEMENT OF MORSE PYROMETER. A, BACKGROUND; B, OBJECTIVE LENS; C, ENTRANCE CONE DIAPHRAGM; D, PYROMETER FILAMENT; E, EYEPIECE DIAPHRAGM; F, EYEPIECE; G, MONOCHROMATIC FILTER. FOR THE SET UP AS USUALLY USED, THE DIMENSIONS ARE AS FOLLOWS:  $AB = 40$  CM.;  $CD = 55$  CM.;  $DE = 60$  CM. DIAMETER OF OPENING IN DIAPHRAGM AT C AND E ARE RESPECTIVELY 20 MM. AND 9 MM.

form of this pyrometer was patented by Morse in 1902. In the instrument as now used, a small lamp is mounted at the focus of a telescope, as shown in Fig. 2. An image of the source whose temperature is to be measured is brought to focus at the same point by means of the objective lens A. Theoretically,<sup>3</sup> the image of any source as observed through a particular telescope will not vary in brightness with a change in distance from the source (except, of course, differences due to air absorption, etc.), providing a certain solid angle is always filled with radiation from the source and this angle is of such size that the cone of rays entering the eye is constant. This angle is generally determined by having the eyepiece at a fixed distance from the pyrometer lamp and having before the eyepiece a limiting diaphragm of such size that it is always filled with light from the objective lens. It is also necessary to have a fixed diaphragm between the objective lens and the pyrometer lamp.

<sup>1</sup> Coblenz: U. S. Bureau of Standards *Bull.* 13, 470.

<sup>2</sup> *Am. Jnl. Sci.* (1910) 29, 93.

<sup>3</sup> Schuster's "Theory of Optics," 2d edition, 152

A form of this pyrometer that has been used quite extensively in Nela Research Laboratory is shown in Fig. 3. The objective lens is a very high-grade lens made by Bausch & Lomb, diameter about 6.2 cm., focal length about 30 cm. With a lens of this aperture, it is possible to use very large magnifications and still have the cone of rays large enough to work well. The working parts are mounted on a very substantial optical bench. The telescope, used as an eyepiece, is permanently fastened to one end of the bench and the pyrometer lamp, diaphragm, and lens are so mounted that each is movable in any direction by means of slow-motion screws. This is necessary since for very accurate

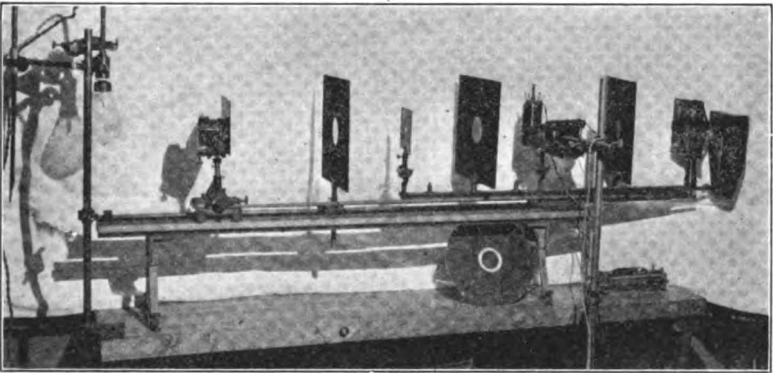

FIG. 3.—LABORATORY FORM OF OPTICAL PYROMETER. LENGTH FROM EYEPIECE TO OBJECTIVE LENS, 225 CM.

work the different parts of the instrument must be very closely in line.<sup>4</sup> By the use of caps with very small holes in the center in front of the lenses and a very small hole in the diaphragm, the different parts are brought into very good alinement. This pyrometer is not portable but is useful in the laboratory when the temperature of small filaments is to be measured; with this set up the temperature of a 2-mil (0.05 mm.) filament has been measured.

#### MONOCHROMATIC SCREEN

In working with an optical pyrometer, it is generally sufficient to use a so-called monochromatic screen between the eye and the pyrometer filament, or other comparison source, in order that brightness comparisons can be made without trouble due to color differences. For the most part, red-glass screens have been used rather than blue screens, or those having a transmission band near the central part of the visible spectrum, because for sources at low temperatures it is the red radiation that first becomes visible. Besides, better red-glass screens than green or blue screens may be obtained. Colored glass to be suitable for a mono-

<sup>4</sup> *Phys. Rev.* [2] (1914) 4, 163.

chromatic screen must have a rather narrow transmission band, in order that there will not be enough color difference between the source studied and the comparison source to prevent accurate comparisons from being made. As there may be more than  $1000^{\circ}$  difference in temperature between the sources compared, this is very important.

In Fig. 4 are shown the spectral transmissions of several red glasses that are nearly enough monochromatic for use under various conditions. The glass having the spectral transmission shown by curve *A* does very well for a commercial pyrometer for low-temperature ranges because the amount of light transmitted is so great. The glass having the trans-

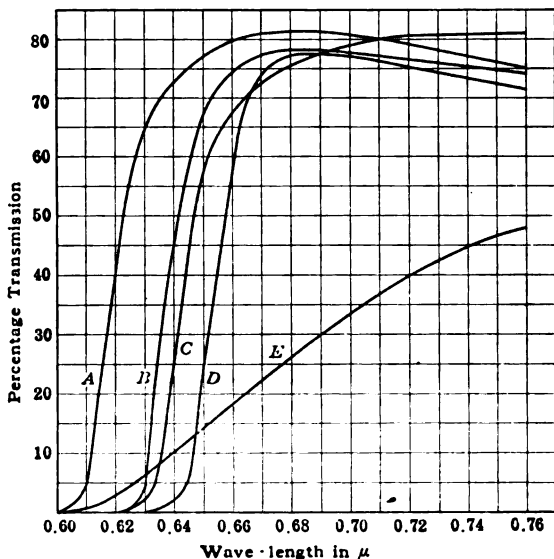

FIG. 4.—SPECTRAL TRANSMISSION OF VARIOUS RED GLASSES. CURVE *C* FOR JENA RED No. 4512, 2.93 MM. THICK. CURVE *E* FOR JENA RED No. 2745, 3.2 MM. THICK. CURVE *A* FOR CORNING HIGH TRANSMISSION RED, MARKED 150 PER CENT., 5 MM. THICK. CURVE *B* FOR CORNING HIGH TRANSMISSION RED, MARKED 50 PER CENT., 5 MM. THICK. CURVE *D* FOR CORNING HIGH TRANSMISSION RED, MARKED 28 PER CENT., 6 MM. THICK.

mission shown by curve *E* was formerly used for this purpose. As the effective wave-length for this glass varies about twice as much as for the other glasses, it is not as satisfactory. The glasses having the transmission shown by curves *B*, *C*, and *D*, are suitable for the most accurate work. To test the constancy of the spectral transmission of the red glass, a piece of the Corning red 50-per cent. glass, curve *B*, the transmission of which had been carefully measured, was placed on the roof of the laboratory, where it was exposed to the direct rays of the sun, for a little more than a year; when it was brought in no change was found in its spectral transmission. Evidently then, the spectral transmission of such glass is constant for all ordinary uses.

*Effective Wave-length of Monochromatic Screen.*—An optical pyrometer can be so calibrated and so used as to make unnecessary a knowledge of the extent to which the screen is monochromatic. To do this requires a black-body furnace that can be operated at various temperatures up to the highest temperature for which the pyrometer is to be used. However, to use Wien's equation to extend the temperature scale either above or below that of the standard furnace by the use of rotating sector disks or absorbing glass, that is, to find the temperature of a black body having a brightness of, say, ten times (assuming a sector or absorbing glass transmission of one-tenth) that of a black body whose temperature can be measured directly, a knowledge of what wave-length to use, or the effective wave-length,<sup>5</sup> is necessary. The effective wave-length also must be known if the pyrometer is used to measure the temperature of non-black bodies. In using the pyrometer, it is the integral luminosities through the red glass that are compared, for which reason the effective wave-length of the red-glass screen for a certain temperature interval has been defined as the wave-length for the definite temperature interval for a black body, such that the ratio of its radiation intensities equals the ratio of the integral luminosities through the screen used.

Knowing the spectral transmission of the red glass, it is possible to calculate the effective wave-length  $\lambda_e$  for any temperature interval by means of the following equation:

$$\left[ \frac{J(\lambda T_1)}{J(\lambda T_2)} \right]_{\lambda_e} = \frac{\int_0^{\infty} J(\lambda T_1) V_{\lambda} t'_R d\lambda}{\int_0^{\infty} J(\lambda T_2) V_{\lambda} t'_R d\lambda} \quad (1)$$

where  $J(\lambda T) d\lambda$  is the energy, as given by Wien's equation, for the wave-length interval from  $\lambda$  to  $\lambda + d\lambda$ ;  $t'_R$  is the spectral transmission of the red glass; and  $V_{\lambda}$  is the visibility. These integrals can be computed by the step-by-step method with sufficient accuracy for this purpose. Using equation 1, the effective wave-length was calculated for the red glass having the spectral transmission shown by curve *B*, Fig. 4, for a number of temperature intervals and plotted, as shown in Fig. 5. By connecting the points where the curve for the effective wave-length from any particular temperature crosses the same temperature ordinate, a curve is obtained, *E*, Fig. 5, that gives the limiting effective wave-length for a particular temperature.

To show how these curves may be used, the effective wave-length for a couple of temperature intervals will be found. The effective wave-length between 1800° and 2900° K. is given by the ordinate of the point where the 1800° K. curve crosses the 2900° K. ordinate, that is, it is 0.6587 $\mu$ . For the range between 2100° and 2900° K. the effective wave-length is likewise given by the point where the 2100° K. curve would cross the

<sup>5</sup> *Astrophys. Jnl.* (1915) 42, 294.

2900° K. ordinate. The 2100° K. curve is not drawn, but will have to be imagined as being drawn parallel to the 1800° K., one point of its position being determined by where the curve *E* crosses the 2100° K. ordinate. The effective wave-length for this interval is 0.6584 $\mu$ . It can be seen from the figure that the effective wave-length for any temperature interval is given quite closely by the mean of the limiting effective wave-length for the two temperatures.

To determine the effective wave-length for a particular red glass requires considerable work both in determining the spectral transmission and in calculating the final values. To determine the effective wave-

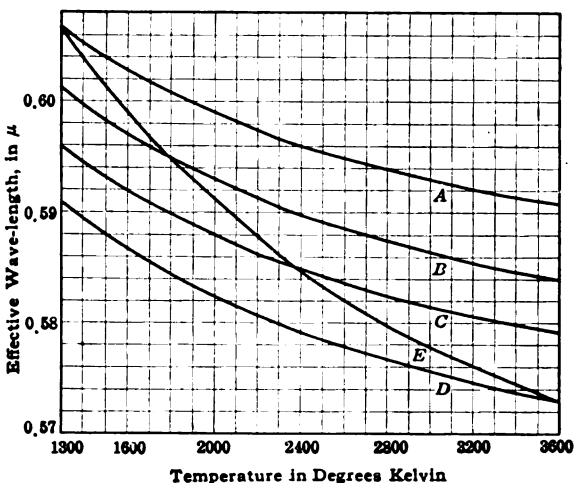

FIG. 5.—EFFECTIVE WAVE-LENGTHS FOR CORNING RED GLASS. SPECTRAL TRANSMISSION SHOWN BY CURVE *B*, FIG. 4. CURVE *A*, EFFECTIVE WAVE-LENGTHS FROM 1300° TO OTHER TEMPERATURE. CURVE *B*, EFFECTIVE WAVE-LENGTHS FROM 1800° TO OTHER TEMPERATURE. CURVE *C*, EFFECTIVE WAVE-LENGTHS FROM 2400° TO OTHER TEMPERATURE. CURVE *D*, EFFECTIVE WAVE-LENGTHS FROM 3600° TO OTHER TEMPERATURE. CURVE *E*, LIMITING EFFECTIVE WAVE-LENGTH.

length for every glass used in optical pyrometry would be laborious. It is fortunately possible to obtain the effective wave-length of an unknown piece of glass in terms of a standard red glass with very few measurements.

If the relative brightness of a black body for two temperatures is measured both with the standard red glass and the glass being investigated, it is possible to compute the effective wave-length of the unknown glass from that of the standard red glass and the ratios of the black-body brightness thus found. From the definition of the effective wave-length and Wien's equation, the following equation is found connecting the effective wave-length and the ratio of the black-body brightness:

$$\frac{(\lambda e)_a}{(\lambda e)_s} = \frac{\log B_s}{\log B_a} \tag{2}$$

where  $(\lambda e)_a$  and  $(\lambda e)_x$  are the effective wave-lengths for the glasses  $a$  and  $x$  for the range studied and  $B_a$  and  $B_x$  the ratio of the brightness of the black body for the two temperatures for red glasses  $a$  and  $x$ . It is often impossible to get a black body that can be operated over the temperature range necessary for an accurate determination of the ratio of brightness. However, it is not necessary to use a black body in this determination, providing a calibrated lamp filament is available. The tungsten filament can be color matched<sup>6</sup> against a black body. Further, the relation between the brightness temperature and the color temperature has been worked out. If a tungsten filament is used and the ratio of its brightness is measured between two particular color temperatures, as described, the effective wave-length can be calculated, using the color temperature in place of the true temperature of the black body.

The tungsten filament does not show the same increase in brightness<sup>7</sup> for the range between color temperatures  $T_{c1}$  and  $T_{c2}$  as does a black body for the same range of temperature where for the black body  $T_{e1}$  and  $T_{e2}$  are the true temperatures. This difference is quite small and for most work would be negligible but for the highest accuracy it must be taken into account. If the brightness of a tungsten lamp is measured between the two color temperatures  $T_{c1}$  and  $T_{c2}$  for both the standard and the unknown glass, the effective wave-length for the unknown glass can be calculated accurately by means of the equation:

$$\log \left( \frac{B_a}{B_x} \right) = c_2 \log e \left( \frac{1}{(\lambda e)_x} - \frac{1}{(\lambda e)_a} \right) \left( \frac{1}{T_{c1}} - \frac{1}{T_{c2}} \right) \quad (3)$$

Because the ratio  $\frac{B_a}{B_x}$  for tungsten is only slightly different from the ratio for a black body between the same color temperatures, equation 3, with a very slight error, may be reduced to equation 2.

Experimentally it has been shown that if the effective wave-lengths are determined for two red glasses that have somewhat the same spectral transmission, the relation between the effective wave-length is given quite approximately by the equation:

$$(\lambda e)_a = (\lambda e)_x + \text{constant}$$

This equation holds for the glasses investigated to all the accuracy needed for temperature measurements.

*Effect of Change of Temperature of Red Glass on its Spectral Transmission.*—In connection with the investigation of the effective wave-lengths it was observed that the transmission of the red pyrometer glass, presumably dependent for the color on a colloidal solution, is subject to a large change with temperature. This has not been investigated thoroughly, but observations were made at two temperatures, 20° and 80° C., by

<sup>6</sup> Hyde: See page 285, this volume.    <sup>7</sup> Hyde: *Astrophys. Jnl.* (1912) **36**, 89.

immersing the glass in water heated to these temperatures; the results are given in Fig. 6. Curve *A* is the transmission of the glass at the lower temperature 20° C., and curve *B* the corresponding curve at the higher temperature 80° C. The transmission is shown to decrease with increase in temperature, the coefficient of change of temperature being greatest in the shorter wave-lengths. The change is such as to make the transmission band appear to shift to longer wave-lengths as the temperature is increased.

A test was made of the effect of this temperature-shift of the transmission band on temperature measurements when the red glass was used as a screen before the eyepiece of the pyrometer. The temperature of a broad carbon-filament lamp operated at a brightness temperature

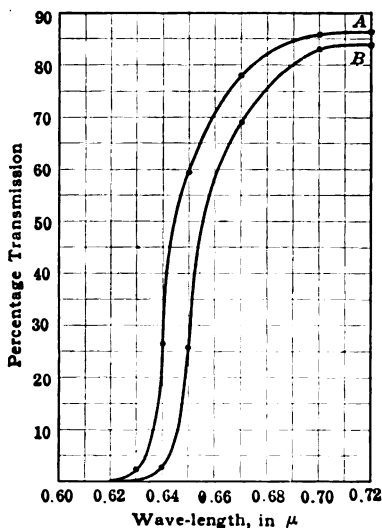

FIG. 6.—SPECTRAL TRANSMISSION OF A SINGLE THICKNESS OF GLASS F-4512: *A* AT 20° C.; *B* AT 80° C.

of 1900° K. was measured with the red glass at room temperature 20° and at 80° C., using a sectored disk with a 2° opening as this gives a larger effect than a sectored disk with greater transmission. It was found that there was a decrease of about 5° C. in the temperature obtained when the glass was heated to 80° C. over that obtained with the glass at room temperature. This shows that for all ordinary temperature changes, the effect is negligible.

#### CALIBRATION OF OPTICAL PYROMETER

An optical pyrometer of the disappearing-filament type is calibrated by finding the current through the pyrometer filament for an apparent brightness match between the pyrometer filament and a black body

at a particular temperature. The direct way is to have a black body that can be operated over the entire range for which the pyrometer is to be calibrated. This quite often is impracticable. An optical pyrometer can be calibrated from a black body held at a particular temperature.<sup>8</sup> To do this it is necessary to have some means, such as a sector disk or an absorbing glass of known transmission, for cutting down the apparent brightness of the incident radiation. If readings of the current through the pyrometer filament for an apparent brightness match with the rotating sector between the pyrometer lamp and the standard black body are taken, there will be obtained a measure, in terms of a current through the pyrometer filament, of a brightness that is some known fraction of that of the standard black body at the standard temperature. If monochromatic radiation is used, it is easy to calculate the temperature  $T_2$  of the black body corresponding to this current through the pyrometer filament, that is, to this measured brightness, from  $T_1$ , the standard temperature by the following formula derived from Wien's equation:

$$\frac{1}{T_1} - \frac{1}{T_2} = \frac{\lambda \log R}{c_2 \log e} \quad (4)$$

where  $R$  is the transmission of the sector and  $\lambda$  the wave-length used. If the measurements are made with a red glass in the eyepiece, the temperature that would correspond to this fraction of the brightness of the standard black body can be calculated just as before, except that in this case the effective wave-length of the red glass for this temperature interval is to be used.

If a potentiometer is used to measure the current through the pyrometer filament, a great deal of time is wasted when a number of readings are taken on the same point. A very good method, which is at the same time quite accurate, is to use the deflection potentiometer principle. The regular Leeds & Northrup potentiometer lends itself quite readily to such an adaptation. By connecting a millivoltmeter in series with the standard resistance and between the binding post marked *Br* and a traveling plug inserted in the proper place on the dial, currents can be read to one part in three or four thousand very easily. The readings can thus be made very rapidly and at the end of the set these same readings can be checked on the potentiometer. This makes the current readings entirely independent of the constancy of any deflection instrument. With a switch in this millivoltmeter line, the potentiometer is left free to check any other current, such as the one through the lamp that is being investigated.

If a rotating sector or an absorbing glass of known transmission is used between the source being investigated and a calibrated pyrometer lamp, the calibration of this pyrometer with the sector can be extended

<sup>8</sup> C. E. Mendenhall: *Phys. Rev.* (1911) **33**, 74.



above the standard black body. In this case the temperature is to be calculated from the temperature corresponding to the current through the pyrometer filament and the transmission of the sector or absorbing glass used by means of equation 3, excepting in case  $R$  is the reciprocal of the transmission of the sector or glass and then  $T_2$  will come out greater than  $T_1$ . A very convenient method is to work out such extrapolated temperatures for the various sectors and absorbing glasses that are to be used and plot the extrapolated temperatures against the temperatures as determined from the pyrometer reading. Such curves can then be used with any pyrometer using the same red glass, providing the same sectors or absorbing glasses are used.

It is very troublesome to operate a standard black body every time it is necessary to calibrate an optical pyrometer. Much time can be saved if a tungsten lamp with a filament of a suitable size is standardized so as to have the same brightness, as observed with the optical pyrometer, as the standard black-body furnace for a particular temperature. The lamp may also be standardized for other temperatures and thus, by its use, the pyrometer can be calibrated very easily.

For the highest accuracy, the tungsten lamp that is to be used for calibration purposes should be standardized with an optical pyrometer, using a red glass that is the same as that on the pyrometer to be compared, or corrections should be made for the difference. If the effective wave-lengths are known, this correction can easily be made by the method outlined below. For practical purposes, however, if similar red glasses are used, the error will be quite small, see Table 7.

Tungsten filaments have been found to depart very markedly from Lambert's cosine law in their radiation.<sup>9</sup> To avoid error due to this cause care must always be taken to determine the temperature of circular filaments by measuring the brightness of the central part of the filament. For this reason the pyrometer filament should always be parallel to the background filament. This of course requires that the pyrometer filament be much smaller than the image of the background filament.

#### PYROMETER FILAMENTS

Some care is required in the selection of the pyrometer filament. Carbon filaments are quite satisfactory for low temperatures but they will not have a very long life if operated at a very high temperature. Each kind of pyrometer filament has its own particular field.<sup>10</sup> For some conditions a carbon filament may be the better, but for most work a tungsten filament should be used. Tungsten pyrometer filaments are just as good as carbon filaments and have a long life if not operated at a brightness above that necessary to match a black body at

<sup>9</sup> Worthing: *Astrophys. Jnl.* (1912) 36, 345.

<sup>10</sup> *Phys. Rev.* [2] (1914) 4, 165.

the temperature of melting palladium (1828° K.). They are often constructed with a small bend at the exact point where the filament is to be observed. A small pointer is also sometimes used to help locate the exact point. The 2½-mil (0.063 mm.) filaments require about 0.46 amp. to apparently match in brightness the black body at the temperature of melting palladium. One lamp that has been in use almost every day for about 2 years, when first calibrated required 0.4573 amp. to apparently match the black body at the temperature of melting palladium; after about 2 years of use, it required 0.4578 amp. This difference in current corresponds to less than 1.5° C.

The statement is often made that carbon-filament pyrometer lamps require a much larger change in current for a given change in brightness than do tungsten-filament lamps. To test this, it was decided to use some data obtained for another purpose. The ratio of the currents through a number of carbon and tungsten pyrometer lamps were found when these pyrometer filaments had been matched in an optical pyrometer against a black body, first, at the palladium point, and, second, at the gold point. Several different carbon-filament pyrometer lamps had been calibrated by the author in the University of Wisconsin and several tungsten lamps had been calibrated in this Laboratory. The ratio of these two currents for all the tungsten pyrometer lamps was about the same, the average being about 1.780. The carbon lamps used were from two lots obtained at different times. The average of the ratio of these two currents for the first lot was the same as the ratio for the tungsten lamps; the average ratio for the other lot was 1.857. This ratio of currents was recently tested for an untreated carbon and was found to be about 5 per cent. greater. The cooling due to the conduction at the ends is the cause of the larger ratio for the carbon at very low temperatures for short filaments. Whatever advantage the carbon filament possesses on account of a larger current variation for a given brightness variation disappears if sufficiently sensitive current-measuring instruments are used, is small in any case, and is usually far outweighed by other advantages possessed by the tungsten filament.

A criticism that has been made concerning the disappearing-filament pyrometer is that there is such a large time-lag between the current and the temperature of the pyrometer filament. It has been shown<sup>11</sup> that for a 2.5-mil filament it would require somewhat less than 2 sec. for a cold filament to reach to within 1° of full brightness after the current is turned on for a maximum brightness corresponding to a temperature of 1828° K. If, however, the pyrometer filament is already heated to within about 50° of its maximum temperature it will require only about 0.6 sec. to reach within 1° of the maximum. (For a lower temperature,

---

<sup>11</sup> Some unpublished work of A. G. Worthing of this Laboratory.

this lag will be somewhat greater.) For the greater part of the work, this small time-lag is negligible.

#### TEMPERATURE OF NON-BLACK BODIES

The value for the temperature of any source obtained with an optical pyrometer must be calculated from the observed brightness for a particular wave-length interval. The only body for which this relation is accurately known is the black body, and for this it is given by Wien's equation. From the definition of a black body and Kirchoff's law, all other bodies that owe their brightness to thermal causes alone are less bright when at a particular temperature than a black body at the same temperature. Thus, if the temperature of any hot non-black body is calculated from a measurement of its brightness, as though it were a black body, values that are lower than the true temperature will be obtained. The temperature obtained, however, is the temperature that a black body must have in order to have the same brightness for the particular wave-length interval as the body being investigated. As the brightness thus measured corresponds to some particular wave-length interval, the temperature obtained corresponds to the particular wave-length. The difference between the true temperature and the temperature thus obtained varies from a few degrees, for such a substance as untreated carbon, to more than 200° C. for such a metal as polished platinum at its melting point.

##### *Wave-length to Which Brightness Temperature Should be Ascribed.—*

If a screen that is absolutely monochromatic is used before the eyepiece it is at once evident to what wave-length the temperature of a non-black body thus measured should be ascribed. However, if a red glass is used, such as those having the transmission shown in Fig. 4, some consideration is necessary.

When the black-body-brightness temperature of a source is determined with an optical pyrometer with a so-called monochromatic screen before the eyepiece, what is really measured is the brightness of the source through the screen. The value of the brightness thus obtained would correspond to a certain temperature  $T$  if it were obtained from measurements of a black body. Therefore, the temperature of the source is to be called a brightness temperature  $S$ , where  $S = T$ .

The color temperature of a particular source has been defined as the temperature of a black body that has the same distribution of energy in the visible spectrum as the source under consideration. It has been found experimentally that most metals when heated radiate in such a manner that they can be color-matched against a black body; these color matches are very easily and accurately made with an ordinary photometer. When two bodies have the same color temperature, it is not necessary that they have the same brightness for any particular wave-length interval.

The brightness temperature  $S$  must be ascribed to a wave-length such that the energy emitted by a black body per unit area at temperature  $T$  ( $= S$ ), for this wave-length will equal that emitted per unit area by the source for the same wave-length. Thus there are two sources with different spectral distributions that have the same brightness when observed through the red screen, a black body at temperature  $T$  and the source being studied which is at a brightness temperature  $S$ . Call the color temperature of the source studied  $T_c$ . As these two distributions are different and yet the sources have the same brightness, the curves representing these distributions must cross if they are plotted with energy emitted per unit area against wave-length. The point at which these two curves cross evidently gives the wave-length to which the brightness temperature  $S$  is to be ascribed.

This brightness temperature is to be ascribed to the effective wave-length of the red glass for black-body radiation for the temperature interval  $T$  to  $T_c$ . The effective wave-length  $\lambda_e$  for the temperature interval is so defined that

$$\frac{B_T}{B_{T_c}} = \left[ \frac{J(\lambda T)}{J(\lambda T_c)} \right]_{\lambda_e} \quad (5)$$

where  $B_T$  and  $B_{T_c}$  represent the brightness for the black body at temperatures  $T$  and  $T_c$  through the screen used and  $J(\lambda T)$  and  $J(\lambda T_c)$  represent the energy emitted by a black body at temperatures  $T$  and  $T_c$  for the wave-length interval whose center is at  $\lambda_e$ .

If the source studied is considered, it will be seen, from the definition of color temperature, that its distribution of energy corresponds to that of a black body at  $T_c$ , the difference being that each ordinate of the curve representing the black-body distribution at temperature  $T_c$  bears a constant ratio  $K$  to the corresponding ordinate for the source studied. Thus the actual energy distribution of the source being investigated is given by  $\frac{J(\lambda T_c)}{K}$ . As stated, this curve and the one representing the distribution of a black body at the temperature  $T$  will cross at the wave-length where  $\frac{J(\lambda T_c)}{K} = J(\lambda T)$ . As each ordinate of the curve representing the distribution of energy from the source studied is a certain fraction  $\frac{1}{K}$  of that for a black body at temperature  $T_c$ , the brightness will be reduced the same amount. Thus, if  $B_s$  is the brightness of the source studied,

$$(B_{T_c}) = K(B_s) \text{ and } \frac{B_T}{B_{T_c}} = \frac{B_T}{KB_s} = \left[ \frac{J(\lambda T)}{J(\lambda T_c)} \right]_{\lambda_e}$$

or

$$\frac{B_T}{B_s} = 1 = \left[ \frac{J(\lambda T)}{J(\lambda T_c)} \right]_{\lambda_e} \quad (6)$$

Thus  $J(\lambda T)$  and  $\frac{J(\lambda T_e)}{K}$  are equal for the wave-length  $\lambda_e$ , in other words the curves representing these two distributions cross at this point. From this it follows that the brightness temperature  $S$  is to be ascribed to the effective wave-length for the screen used for the temperature interval of a black body from  $T (= S)$  to  $T_e$ .

*Corrections of Brightness Temperatures to a Constant Effective Wave-length.*—As the brightness temperatures of a source are measured using a particular screen before the eyepiece, there will be a variation in the wave-length to which these temperatures are to be ascribed. Sometimes it is desirable to know the brightness temperature over quite a range of temperatures for the same wave-length. If the color temperature of the source is known, the brightness temperature can be calculated for any wave-length when it is known for one wave-length. Thus for a source at a color temperature  $T_e$ , using Wien's equation and the conditions that hold for color match, the following relation between two brightness temperatures ( $S_1$  and  $S_2$ ) for two wave-lengths ( $\lambda_1$  and  $\lambda_2$ ) can be derived.

$$\frac{1}{S_2} = \frac{\lambda_2}{\lambda_1} \left[ \frac{1}{S_1} - \frac{1}{T_e} \right] + \frac{1}{T_e} \quad (7)$$

If a double thickness (6.8 mm.) of the red glass known as Jena Rotfilter No. 4512 (spectral transmission shown by curve C, Fig. 4), is used before the eyepiece of the pyrometer, this correction when applied to the brightness temperature of tungsten will be small. It has been shown that the<sup>12</sup> effective wave-length of this red glass changes from  $0.6657\mu$ , for the range between brightness and color temperature of tungsten at a brightness temperature of  $1600^\circ$  K., to  $0.6626\mu$  for this range for a brightness temperature of  $3000^\circ$  K. If the brightness temperatures are corrected to a wave-length  $0.6657\mu$ , this correction will amount to about  $-2^\circ$  K. at a brightness temperature of  $3000^\circ$  K.; for most work when using this screen, this correction will be negligible.

Objections have often been made to the use of red-glass screens on the ground that as the range of wave-length transmitted was so large, there was no method of knowing to what wave-length the resulting temperature was to be assigned. If the effective wave-length of the red glass used is known for different temperature ranges, the results can be treated just as definitely as if an absolutely monochromatic screen were used; in addition, the red glass has the added advantage of transmitting enough light to enable very accurate brightness comparisons to be made.

#### DIFFRACTION AROUND PYROMETER FILAMENT

If an optical pyrometer of the disappearing-filament type is constructed without a limiting diaphragm between the objective lens and the

<sup>12</sup> *Loc. cit.*

pyrometer lamp, an error will be made if the position of the objective lens is changed, even though there is a limiting diaphragm between the pyrometer lamp and the eyepiece. In other words, the current required through the pyrometer filament for an apparent brightness match with a particular source is a function of the angle that the cone of rays from the objective lens makes at the pyrometer filament. This has been found to be due to light from the source being diffracted around<sup>13</sup> the pyrometer filament. If from the central part of the aperture *C*, Fig. 2, a region is blocked out such that, from a consideration of geometrical optics only, none of the light from the background in the immediate neighborhood of the place where the pyrometer filament is seen projected can enter the aperture at *E*, and if no current is passed through the pyrometer filament, this filament can be seen through the eyepiece to be apparently glowing where it crosses the background image. In case the resolving power of the eyepiece is sufficiently great, this apparent brightness of the pyrometer filament is seen to consist of two bright streaks along the edge. Whether or not the axes of these bright streaks lie within or without the boundaries of the pyrometer filaments is very difficult to determine.

It has often been assumed that the pyrometer filament and the background source were at the same brightness (except for a small difference due to lens absorption, etc.) when there was an apparent brightness match between them. This variation in brightness has been studied<sup>14</sup> by varying the angle made at the pyrometer filament by the cone of rays from the objective lens, having at the same time a definite fixed cone of rays from both the pyrometer filament and the background source entering the eyepiece. For very small values of these angles (about 0.006 radian) it was found that the pyrometer filament would be actually much brighter than the background when there was an apparent brightness match. This effect depended on the size of the pyrometer filament, being greater for a small filament. For somewhat larger angles (0.02 radian) a  $2\frac{1}{2}$ -mil (0.063-mm.) pyrometer filament is actually only about 95 per cent. as bright as the image of the background located at this same point for an apparent brightness match as observed in the pyrometer.

A test of this effect was recently made with the pyrometer shown in Fig. 3. Two test pyrometer lamps were used, one having a 10-mil (0.25-mm.) tungsten wire filament and the other a tungsten ribbon filament  $1\frac{1}{2}$  mm. wide. The angle that the cone of rays made at the pyrometer filament was such as would be subtended by a diaphragm with a circular opening 2 cm. in diameter at a distance of 50 cm. These pyrometer filaments were matched against a wide tungsten ribbon background and the current required noted. The exact point on each pyrometer filament and on the background was indicated by means of a small

<sup>13</sup> *Phys. Rev.* [2] (1914) 4, 163.

<sup>14</sup> *Loc. cit.*

pointer, or otherwise. These pyrometer lamps were then replaced by the regular pyrometer lamp and the brightness of the two filaments that had been used as pyrometer filaments, as well as that of the background, was measured. After correcting for the transmission of the lamp bulbs and the projecting lens, the 10-mil tungsten filament was found to be only about 84 per cent. as bright as the background and the ribbon filament only about 88 per cent. as bright as the background, notwithstanding the fact that, as observed through the pyrometer, they were at a brightness match. When wire as large as 10 mil is used for pyrometer filaments, there is some question concerning the disappearance due to the variations from Lambert's cosine law. There is not much doubt that the observer matches the edges of such a filament against the background without any great consideration of the central brightness. When the brightness of the filament is measured in the regular manner, observations are generally made on the central part. There may, therefore, be 2 or 3 per cent. to be added to the brightness measured for the wire filament. These results, considering the difficulties, agree quite well with the results that were previously found. All of these errors can be avoided by keeping the cone of rays from the objective lens to the pyrometer filament as well as the cone of rays entering the eyepiece, fixed for any particular set of measurements. This can readily be done by having fixed limiting diaphragms between both the objective lens and the pyrometer filament and between the pyrometer filament and the eyepiece.

#### ACCURACY TESTS

To test out the accuracy that might be expected in the use of the disappearing-filament type of optical pyrometer, different experiments were made. In the first experiment,<sup>15</sup> readings were made by a number of observers with no experience in this kind of work; in the second experiment readings were made by experienced observers. The instrument used in each case was the laboratory form of pyrometer shown in Fig. 3. The resistance that controls the current through the pyrometer filament was so chosen that the sliding contact had to be moved quite a distance in order to change the apparent brightness of the filament by an appreciable amount. The current was measured by means of a potentiometer.

In Table 1 are given the results of the first experiment. Observers 1 and 2 were high-school graduates with several months' experience as laboratory assistants. Observer 3 was a man with several years' experience in shop work. Observer 4 was a man with several years' experience in a lamp factory. Observers 5 and 6 were girls from the lamp factory; No. 5 had no experience with this kind of work while No. 6 had had experience with the photometer.

<sup>15</sup>*Gen. Elec. Rev.* (1917) 20, 749.

TABLE 1.—*Results Obtained With a Disappearing-filament Type of Pyrometer By Inexperienced Observers*

| Observer            | Value Obtained for Temperature,<br>as an Average of Six Readings,<br>Degrees K. |      | Variation of Single<br>Readings from Mean,<br>Degrees K. |
|---------------------|---|------|--|
| Standards . . . . . | 1438  | 1643 |  |
| 1. L. C. . . . .    | 1439  | 1643 | 4  |
| 2. H. W. . . . .    | 1438  | 1642 | 3  |
| 3. F. G. . . . .    | 1439  | 1642 | 2  |
| 4. E. H. . . . .    | 1436  | 1644 | 3  |
| 5. E. W. . . . .    | 1436  | 1636 | 5  |
| 6. L. R. . . . .    | 1436  | 1640 | 2  |

The table shows that but a single observer made an error greater than 3° K. in the temperature as obtained from the average of six readings. In no instance was a value of temperature obtained from a single reading that differed more than 5° from the mean of the set of readings. These results are thought to be very good and to indicate the character of results that could be obtained with this form of pyrometer in industrial works. The pyrometer used probably enabled the observers to make much more accurate observations than is possible with a commercial form of the instrument. However, even a commercial instrument could be so constructed that very good observations could be obtained. In this work, as in almost all work depending on eye observations, a small amount of training makes a very great improvement in the accuracy of the results.

The second experiment<sup>16</sup> was more extended and had as an object to test out the constancy of readings of different observers when using a sectored disk of low transmission or a dense absorbing glass to cut down the apparent brightness of a source studied. The observers who made these readings obtained very nearly the same readings when using the pyrometer directly; that is, with no sector or absorbing glass.

In this experiment, first with two pieces of Jena red glass No. 4512 (spectral transmission shown by curve C, Fig. 4) and second with two pieces of Corning red 50 per cent. (spectral transmission shown by curve B, Fig. 4) in the eyepiece of the pyrometer, readings were made on the apparent brightness of a particular source as observed through a rotating sector with two 1° openings, the noviweld absorbing glass having the spectral transmission shown by curve C, Fig. 7, and through two pieces of the Jena absorbing glass having the spectral transmission shown by curve B, Fig. 7. The source used was a 15-mil tungsten lamp operated at a color temperature of 2610° K. The brightness was measured in terms of the current through the pyrometer filament for an apparent brightness match. Four observers made the measurements, three of whom had had

<sup>16</sup> *Astrophys. Jnl.* (1919) 237.



considerable experience with this kind of work. Values of the current through the pyrometer filament thus obtained are given in Table 2. The maximum range with the two glasses occurs for K.H.M. and W.E.F. for the noviweld glass when the Jena red No. 4512 was used. This amounted to about 1 per cent. in brightness and to less than 5° in temperature at about 2500° K.

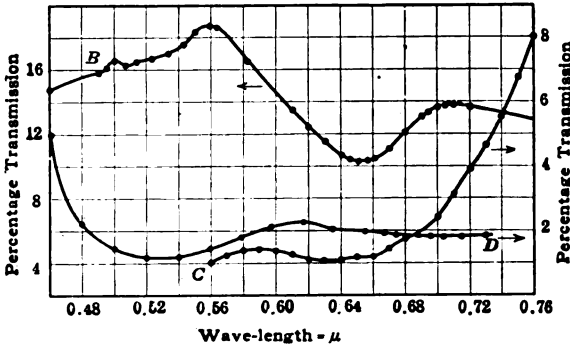

FIG. 7.—SPECTRAL TRANSMISSION OF VARIOUS ABSORBING GLASSES. CURVE B, JENA ABSORBING GLASS 1.5 MM. THICK. CURVE C, NOVIWELD OBTAINED FROM CORNING GLASS WORKS; SHADE ABOUT 6. CURVE D, LEEDS & NORTHRUP ABSORBING GLASS MADE OF PURPLE AND GREEN GLASS.

TABLE 2.—Results Obtained By Experienced Observers Using Different Red Glasses and Different Absorbing Glasses

| Observer        | Red Glass Used | Direct | Current Through Pyrometer Filament for Apparent Brightness Match With |                          |                          |
|-----------------|----------------|--------|---|--------------------------|--------------------------|
|                 |                |        | 2° Sector   | Noviweld Absorbing Glass | Two Jena Absorbing Glass |
| I.A.V . . . . . | Jena No. 4512  | 0.4343 | 0.3358  | 0.3804                   | 0.3547                   |
| K.H.M . . . . . | Jena No. 4512  | 0.4343 | 0.3361  | 0.3807                   | 0.3546                   |
| W.E.F . . . . . | Jena No. 4512  | 0.4344 | 0.3361  | 0.3803                   | 0.3546                   |
| A.G.W . . . . . | Jena No. 4512  | 0.4343 | 0.3358  | 0.3805                   | 0.3547                   |
| I.A.V . . . . . | Corning red    |        | 0.3380  | 0.3784                   |                          |
| K.H.M . . . . . | Corning red    |        | 0.3380  | 0.3785                   |                          |
| W.E.F . . . . . | Corning red    |        | 0.3380  | 0.3783                   |                          |
| A.G.W . . . . . | Corning red    |        | 0.3378  | 0.3784                   |                          |

The visibility curves of the four observers are quite different. Two of the observers (I.A.V. and K.H.M.) are quite blue sensitive, one (W.E.F.) is somewhat red sensitive, and the other (A.G.W.) is very red sensitive. The values of the visibility extend toward the red and only to wave-length 0.66μ. In this work the visibility much beyond this point must be taken into consideration. It is not the visibility in the blue end of the

spectrum that is important but rather the relative shapes of the different visibility curves in the red end. In some other work, it was shown that though there was a great variation in the values given by the individual observers to the brightness in the extreme red in comparison with those in the central part of the spectrum, the relative values in the red end do not vary so widely. From this, it is to be expected that different observers will get very closely the same values of brightness if they are limited to the extreme red. For the currents given in Table 2, a change of 0.0005 amp. corresponds to a change of about 1 per cent. in brightness of the background. This same change in current through the pyrometer filament corresponds to about 3° K. in temperature at about 2500° K.

Another experiment<sup>17</sup> shows what results are to be expected with the optical pyrometer. The temperatures of several tungsten lamps were very carefully measured in this Laboratory for different currents and sent to the Bureau of Standards, the Physical Laboratory of the University of Wisconsin, and the Research Laboratory of the General Electric Co., at Schenectady, where the temperatures were measured for the same currents. The lamps were then returned to this Laboratory for a second check on the temperatures. This gave an intercomparison of the temperature scales that are in use in the different laboratories.

In each of the laboratories, the temperatures were measured by means of a disappearing-filament optical pyrometer using red glass as the monochromatic screen. As the different laboratories used a red glass having a slightly different effective wave-length, a small correction was necessary to reduce the temperature to the same wave-length. Such a correction would have been unnecessary if the sources whose temperatures were measured had been black bodies. A summary of the results, using the data on but three of the six lamps, is given in Table 3; the data obtained on the other three lamps are about the same.

Of the lamps used, all except one had flat filaments about 3 cm. long and about 1½ mm. wide. The exact point at which it was desired to have the temperature measured was indicated either by a pointer, a notch in the supporting lead, or a small notch in the filament itself. Three of the lamps were gas-filled and two were of the vacuum type; the other lamp, which was gas-filled, had a 20-mil (0.5-mm.) filament in the shape of a hairpin loop. As the loop was rather sharp, the exact point at which it was desired to have the temperature measured was easily indicated. This Laboratory is planning to send similar lamps to several other laboratories for like comparisons in the near future.

In Fig. 8 is shown a picture of three of the lamps used in this temperature intercomparison. The flat-filament lamps have been quite useful in intercomparing the calibration of pyrometers and in calibrating a pyrometer. Such a lamp has been used as a source for work with the

---

<sup>17</sup> *Phys. Rev.* [2] (1918) 11, 139.

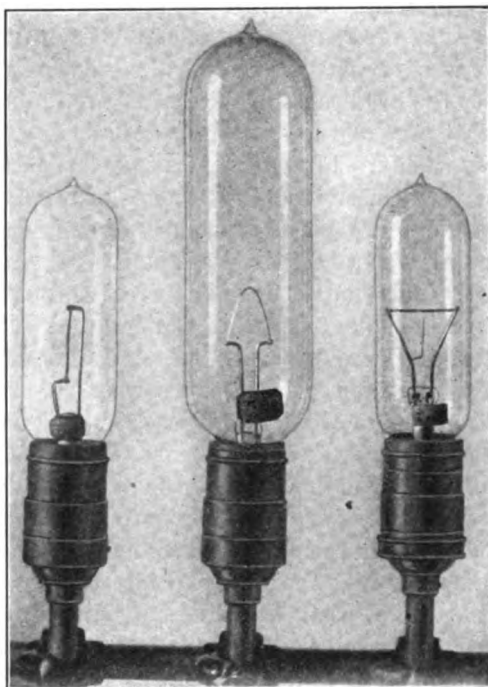

FIG. 8.—LAMPS USED IN INTERCOMPARISON OF TEMPERATURE SCALES.

TABLE 3.—Results of Intercomparison of Temperature Scales

| Lamp  | $c_2 = 14350\mu \text{ deg.}$                           |  | $\lambda = 0.665\mu$                                    |                     | Melting Point of Au = 1336° K.<br>(Pd = 1828° K.)      |  |
|-------|---|--|---|---------------------|--|--|
|       | Nela Research Laboratory<br>Oct. 17, 1916<br>Degrees K. | Research Laboratory General Electric Co. (Schenectady)<br>Degrees K. | Nela Research Laboratory<br>Nov. 28, 1916<br>Degrees K. | Bureau of Standards | Nela Research Laboratory<br>Apr. 2, 1917<br>Degrees K. |  |
| T-16B | .....   | .....  | 1429  | 1431                | 1427   |  |
| T-30C | 1813  | 1813   | 1813  | 1814                | 1813   |  |
| T-30C | .....   | 2307   | 2304  | 2302                | 2303   |  |
| T-30C | 2756  | 2752   | 2752  | 2762                | 2752   |  |

| Lamp   | Nela Research Laboratory<br>Mar. 27, 1916<br>Degrees K. | Physical Laboratory University of Wisconsin |                        | Nela Research Laboratory<br>July 14, 1917<br>Degrees K. |
|--------|---|---|------------------------|---|
|        |   | C. E. M.<br>Degrees K.                      | G. R. G.<br>Degrees K. |   |
| T 17-c | 1810  | 1813  | 1816                   | 1810  |
|        | 2193  | 2197  | 2202                   | 2196  |
|        | 2499  | 2506  | 2516                   | 2497  |

spectroscope. The high intensity attainable, together with its size and the fact that it will remain so constant, makes it a very good source for this kind of work.

The table shows that the results by the Bureau of Standards, Research Laboratory of the General Electric Co., Schenectady, and Nela Research Laboratory agree very well for the entire range studied. The results obtained in the Physical Laboratory of the University of Wisconsin do not agree quite so well, but even here the differences are quite small.

#### ABSORBING SCREENS FOR OPTICAL PYROMETRY

A sector that has been very carefully calibrated, if used properly, is without doubt the best means that can be used for cutting down the apparent intensity of a source that is being studied. In a research or a standardizing laboratory, the rotating sector is thus a very valuable instrument. However, for commercial work where a portable instrument is desired, a rotating sector adds to its size and makes necessary another source of power to drive the sector, so for a commercial pyrometer absorbing glasses are generally used, and when properly calibrated and properly used are very satisfactory.

When it is necessary to use glass absorbing screens to reduce the apparent brightness of the source studied, the main requirement is to have a screen that approximates a neutral-tint screen sufficiently well to enable comparisons in brightness to be made by different observers with the same results. The degree to which it is necessary for the absorbing screen to have a spectral transmission independent of the wave-length, depends on the so-called monochromatic glass used in the eyepiece. It is quite evident that if this eyepiece glass is absolutely monochromatic, any absorbing glass will answer.

In Fig. 7 are shown the spectral transmissions of a piece of noviweld (curve *C*) and of a piece of a Jena absorbing glass (curve *B*). Either of these glasses is nearly enough neutral tint for use with the red glasses having transmission curves shown by *B*, *C*, and *D* in Fig. 4. The noviweld absorbing glass and the samples of Corning high-transmission red glass were obtained from Mr. F. P. Gage of the Corning Glass Works, Corning, New York. This absorbing glass is made in different shades with transmissions, when used in connection with red glass, ranging from less than 1 per cent. to several per cent.

If a red glass is used in the eyepiece, by total transmission for a particular temperature is meant the ratio of the brightness of the source observed through both the red glass and the black glass, to the brightness of the same source observed through the red glass alone. Without a red glass, using the entire visible spectrum, it is generally very hard to make such measurements owing to the color differences introduced by even the

best absorbing glasses, but with a good red glass in the eyepiece, such transmission measurements can be made easily.

The total transmission of the absorbing glass, when used with a red glass, can be calculated for any black-body distribution by the following formula, taken from Preston's "Theory of Light":

$$T_B = \frac{\int_0^\infty J_\lambda V_\lambda t'_R t'_B d\lambda}{\int_0^\infty J_\lambda V_\lambda t'_R d\lambda} \quad (8)$$

where  $J_\lambda d\lambda$  = black-body energy for interval  $\lambda$  to  $\lambda + d\lambda$ .  $V_\lambda$  = visibility,  $t'_R$  and  $t'_B$  = spectral transmission of red and absorbing glasses, respectively. It is very evident that if the spectral transmission of

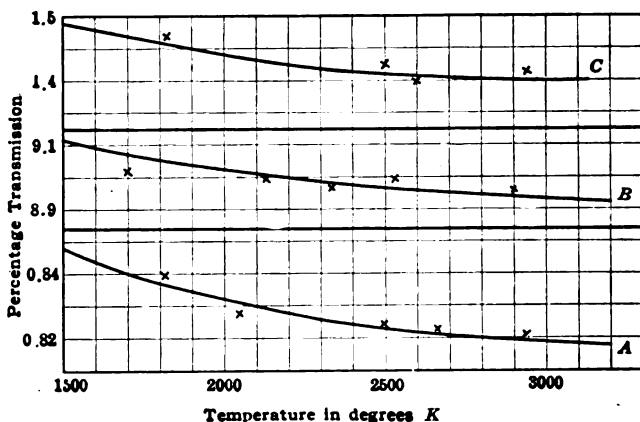

FIG. 9.—TOTAL TRANSMISSION OF ABSORBING GLASSES, AS A FUNCTION OF TEMPERATURE WHEN USED WITH RED GLASS NO. 4512—5.8 MM. THICK. CURVE A, TWO PIECES JENA ABSORBING GLASS. B, ONE PIECE JENA ABSORBING GLASS. C, NOVIWELD GLASS FROM CORNING GLASS WORKS. CURVES DRAWN THROUGH POINTS CALCULATED FROM

EQUATION  $T_B = \frac{\int_0^\infty J_\lambda V_\lambda T_R T'_B d\lambda}{\int_0^\infty J_\lambda V_\lambda T_R d\lambda}$ . CROSSES REPRESENT VALUES OF TRANSMISSION OBTAINED WITH OPTICAL PYROMETER.

the absorbing glass is different for different wave-lengths, the total transmission will be a function of the temperature of the source under investigation.

In Fig. 9 is shown, as a function of the temperature of the source, the total transmission for red light of the absorbing glasses having the spectral transmission given by curves B and C, Fig. 7. The measured points were determined by the author and the calculated values were obtained by means of equation 8 by using an average visibility curve<sup>18</sup> for this spectral region. Transmission values were also calculated, using the writer's visibility curve. Values thus obtained, using the two different

<sup>18</sup> *Astrophys. Jnl.* (1918) 48, 87.

visibility curves, differ from each other by only a small fraction of a per cent.

There has been some question<sup>19</sup> as to the effect on the effective wave-length of a red glass for a certain temperature interval due to using with it an absorbing glass that is not neutral tint. It has been stated several times that the effective wave-length that should be used is the effective wave-length that would be obtained by substituting in equation for the spectral transmission of the red glass the product of the spectral transmission of the red glass and the absorbing glass, that is, the spectral transmission of the two glasses together. In what follows, it is shown that such is not the case but that the same effective wave-length is to be used with an absorbing glass as is used with a sector of the same transmission.

Suppose that using the same red glass in both cases, a sector with a transmission  $T_s$  were found such that the brightness observed through the black glass would equal that observed through the sector (*i.e.*, sector and glass have same transmission). Then

$$\int_0^{\infty} J_{\lambda} V_{\lambda} t'_{B'} t'_{R} d\lambda = \int_0^{\infty} J_{\lambda} V_{\lambda} t'_{R} t'_{S} d\lambda = t_s \int_0^{\infty} J_{\lambda} V_{\lambda} t'_{R} d\lambda \quad (9)$$

Since the brightness is measured in terms of the current through the pyrometer filament, this current will be the same in the two cases. This means that in both cases the temperature  $T_2$  that is being determined must be calculated from the same initial temperature.

The question to be considered is: What effective wave-length is to be used in calculating the temperature of the source having the brightness thus measured? When the brightness is measured by using the rotating sector, the temperature  $T_2$  is calculated from the transmission of the sector and  $T_1$  the temperature corresponding to the pyrometer reading when no sector is used. For this calculation, as was previously pointed out, the following formula derived from Wien's equation is used.

$$\frac{1}{T_2} - \frac{1}{T_1} = \frac{\lambda_e \log T_s}{c_2 \log e}$$

In this expression  $\lambda_e$  is the ordinary effective wave-length for the red glass for the temperature interval  $T_1$  to  $T_2$ , and is defined as the wave-length such that the ratio of the radiation intensities for the temperature interval for this wave-length shall equal the ratio of the integral luminosities through the screen used.

When the brightness is measured by using an absorbing glass, the temperature  $T_2$  must be calculated, using the same formula, from the transmission of the absorbing glass, and  $T_1$ , the temperature corresponding to the pyrometer current when no absorbing glass is used. As the transmission of the absorbing glass is equal to that of the sector and the two

<sup>19</sup> Footnote: U. S. Bureau of Standards Bull. 12 (1915-16) 483.

temperatures are the same in both cases, the other unknown, that is the effective wave-length, must be the same. That is, since the transmission of the absorbing glass given by equation 8 is the same as that obtained experimentally by comparing its transmission with that of a sector, the same effective wave-length of the red glass is to be used with both the absorbing glass and a sector having the same transmission. Thus, to calculate the extrapolated brightness temperature of a source whose brightness temperature is measured, using an absorbing glass, it is necessary to know the transmission of the glass as a function of the temperature of the source studied, and also the ordinary effective wave-length for the red glass used. In calculating the extrapolated temperature when using a sector disk, it is necessary to know this temperature approximately in order to find the effective wave-length for the interval. The calculation is, therefore, one of successive approximation. When a so-called neutral-tint glass is used, additional care is required because both the effective wave-length and the transmission depend on the temperature reached.

Attempts have been made to obtain an absorbing glass that is strictly neutral tint or even one that has such a transmission as to correct for the change in effective wave-length of the red glass used. Such a glass would probably be very nice but it is not necessary. What is wanted is a glass that will permit comparisons of brightnesses to be made by different observers with the same result. If a good red glass is used, suitable absorbing glasses can easily be found. The same thing might be said about the red glasses. Many attempts have been made to obtain absolutely monochromatic screens for optical pyrometry. This is very nice for some purposes but is not necessary, in general, and such screens have the disadvantage of not transmitting enough light to permit of accurate brightness comparisons at low temperatures. A good red glass can easily be obtained that transmits enough light to permit brightness comparisons at low temperatures and at the same time is sufficiently monochromatic to enable different observers to obtain the same results, even under the unfavorable conditions existing when the comparison source and the source studied are quite different in temperature. In addition to this, if the effective wave-length of the red glass is known, all results can, in general, be readily reduced to the condition for a common wave-length.

*Effect of Change in Temperature of Absorbing Glass on its Transmission.*

—As the spectral transmission of the red glass showed such a marked change with a change in its temperature, it was thought worth while to investigate the transmission of the absorbing glass as a function of temperature. Accordingly a heater was built and so mounted that different absorbing glasses could be heated in position to a temperature of about 200° C. Their transmissions were then measured as recorded in Table 4. These transmissions correspond to a color temperature of

TABLE 4.—*Transmission of Absorbing Glasses at Different Temperatures When Used with Red Glass No. 4512, 5.8 mm. Thick*

| Temperature, Degrees C. | Noviweld Absorbing Glass,<br>Per Cent. | Jena Absorbing Glass,<br>Per Cent. |
|-------------------------|--|------------------------------------|
| 20                      | 1.70                                   | 8.96                               |
| 102                     | 1.55                                   | 8.90                               |
| 200                     | 1.39                                   | 8.87                               |

the source of 2380° K. The Jena glass has the spectral transmission shown by curve *B*, Fig. 7. The noviweld is a piece of shade 5, which was obtained somewhat later than that used in the preceding work. These two pieces of noviweld probably have somewhat the same spectral transmission. The Jena absorbing glass shows but a very small change in transmission due to a change in its temperature. If the spectral transmission of this glass behaves in the same manner as that of the red glass discussed above, this is what would be expected from the shape of the spectral transmission curve.

The change in transmission of the noviweld absorbing glass is such as to indicate that the spectral transmission curve has shifted in the same direction as that shown in Fig. 6 for the red glass. No attempt has been made to investigate the effect of this temperature shift on the transmission of the glass as a function of the temperature of the source studied. The relative changes would probably be about the same as those shown in the table. The changes in transmission in the Jena glass are so small as to be negligible for any temperature change met with in practice. The changes in the noviweld, however, are enough to cause a small error due to the temperature changes met with in practice. For a glass of this kind calibrated at a temperature of 20° C. and used at a temperature of 30° C. in extrapolating from 1800° K. to 2400° K. and 3000° K., the errors would be respectively +7.5° K. and +11.5° K.

GENERAL NOTES

If an optical pyrometer, as shown in Fig. 3, is constructed so as to transmit sufficient light to enable temperatures to be measured as low as 1000° K., this pyrometer will transmit too much light for comfort at high temperatures. The diaphragm before the eyepiece telescope at *E* can be constructed as shown so as to have several openings of various sizes. For a low temperature, the larger opening is to be used, thus transmitting more light, while for a higher temperature, a smaller opening should be used. In this manner the same instrument can be used over a wide range without discomfort.

If too large an opening is used before the telescope eyepiece, the



pyrometer filament will not disappear against the image of the background but there will be dark streaks along the edges of the pyrometer filament. If these dark streaks are too prominent, it is impossible to make consistent settings. The resolving power of whatever eyepiece is used should be so adjusted that the pyrometer filament disappears as a whole, that is such that one does not see either dark or bright streaks along the edge of the pyrometer filament. To see what error would result due to such dark streaks, the diaphragms and the pyrometer filament were so chosen as to give very marked dark streaks along each edge of the pyrometer filament. A 4-mil (0.1-mm.) pyrometer filament was used. The arrangement of the different parts was as is shown in Fig. 2, except that the opening in the diaphragm before the eyepiece telescope was 2 cm. in diameter. The results, in terms of the current through the pyrometer filament for a brightness match with a 15-mil (0.38-mm.) tungsten lamp at a temperature of 1735° K., are given in Table 5. As everything was kept constant during the three days these readings were made these variations are errors due to a change in the criterion for a brightness match. For the value of the current given in Table 5, a change of about 0.0009 amp. corresponds to 1° in temperature.

TABLE 5.—*Results Obtained by Experienced Observers Using Pyrometer with Dark Streaks along Edges of Pyrometer Filament*

| Day   | A.G.W. | K.H.M. | W.E.F. |
|---|--------|--------|--------|
| Current, in amperes, through pyrometer filament |        |        |        |
| 1   | 0.9162 | 0.9124 | 0.9152 |
| 2   | 0.9187 | 0.9120 | 0.9179 |
| 3   | .....  | 0.9125 | 0.9169 |
| Average.....                                    | 0.9174 | 0.9123 | 0.9168 |

The greatest error was made by W.E.F. In this case the range was about 2° K.

It is thus seen that for bad conditions, as to disappearance, the error for experienced observers though small is much larger than occurs when the conditions are good. The results given in Table 2 show that when the conditions are good these three observers get practically the same reading. However, in this case the differences are quite large. If for any reason it is necessary to use a large resolving power eyepiece, good disappearance can be obtained by increasing the size of the cone of rays that reach the pyrometer filament from the objective lens. If this is pushed too far, an objective lens with a very large aperture is required. If the light is too intense for comfort, it can be cut down by using one or more additional red glasses before the eyepiece. If two red glasses are

used in the eyepiece, the addition of a third red glass will reduce the apparent intensity of the image by about 50 per cent. If more light is desired for sources at lower temperatures, it is often quite a help to remove one of the two red glasses that are being used. If two red glasses are being used and one of them is removed, the brightness of the image observed will appear about twice what it did with two red glasses. If no sector or absorbing glass is used with the pyrometer there will be very little effect on temperature measurements if the number of red glasses in the eyepiece is changed. If a sector or absorbing glass is used corrections will have to be made for the change in effective wavelength for the number of red glasses that are used.

*Polarization.*—To test out the effect of polarization with this type of pyrometer, a large nicol was mounted directly in front of the pyrometer lamp and readings made with the position of the nicol varied with respect to the pyrometer filament. It was found that, with a red glass before the eyepiece of the pyrometer, the apparent brightness of the background (a black body) was about 1 per cent. more when the nicol was so set that the transmitted light was polarized in a plane at right angles to the pyrometer filament than with nicol turned through  $90^\circ$ . Since the source is known to be free from polarization, this shows that the effect of polarization is almost negligible even when all the light is polarized. From the work on diffraction<sup>20</sup> around the pyrometer filament already referred to, a small difference would be expected even with this instrument.

*Position of Rotating Sector.*—If the rotating sector is used to cut down the apparent intensity of the background, care must be taken as to the location of the sector. There is a very marked difference in the results of temperature measurements, depending on whether the sector is located near the objective lens or as near as possible to the pyrometer lamp. There is also a difference depending on the relative position of the openings in the sector and the source, providing the source is a lamp filament. If a sector of small transmission is mounted near the lens and so placed that the openings of the sector are parallel to the axis of the background filament when the sector is passing across the center of the lens, the definition will be very bad, while if the openings of the sector are turned through  $90^\circ$ , so that they are perpendicular to the axis of the filament, the definition will be quite good, but not as good as if the sector is located near the pyrometer lamp, see Fig. 10. When the rotating sector is located near the pyrometer lamp, the definition is good and practically independent of the position of the opening of the sector. If a very large source is used no such effect is noted. Using a pyrometer calibrated against such a large background, and thus independent of the position of the sector to measure the brightness temperature of a small

<sup>20</sup> *Phys. Rev.* [2] (1914) 4, 163.

tungsten filament, large variations in temperature were found when different sectors were used near the objective lens. No such differences were found when the sector was located near the pyrometer filament.

In Table 6 are given results of a test showing the effect of the position of the sector. A 15-mil (0.381-mm.) tungsten lamp operated at a brightness temperature of about 2275° K. was used as a background and readings were made on the current through a 2½-mil (0.063-mm.) tungsten pyrometer filament, for an apparent brightness match with a sector having two 1° openings. From the table it can be seen that the position of a sector of this size can cause an error of about 14° K. for this condition if care is not taken as to its location. When a sector is used, it should be rotated so fast that no flicker is noticeable. Not only is an error apt to be made if the sector is not rotating fast enough, but the flicker is very bothersome in making accurate brightness comparisons.

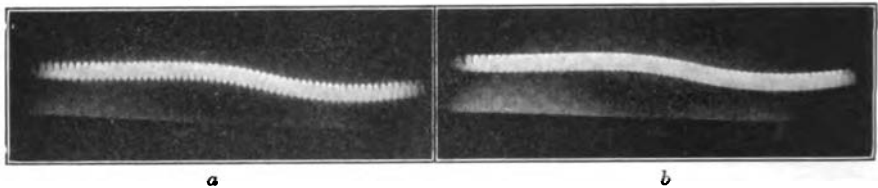

FIG. 10.—APPEARANCE OF IMAGE OF SPIRAL TUNGSTEN FILAMENT WHEN ROTATING SECTOR WITH TWO 1° OPENINGS IS MOUNTED NEAR LENS; a, WITH OPENINGS OF SECTOR PARALLEL TO AXIS OF COIL, THAT IS, PERPENDICULAR TO INDIVIDUAL TURNS, WHEN SECTOR IS PASSING IN FRONT OF CENTER OF LENS; b, WITH OPENINGS OF SECTOR PERPENDICULAR TO AXIS OF COIL WHEN SECTOR IS PASSING IN FRONT OF CENTER OF LENS.

TABLE 6.—Errors in Temperature Measurements Due to Improper Location of Sector

| Position of 2° Sector   | Near Lens   |  | Near Pyrometer Lamp                               |  |
|---|---|--|---|--|
|   | Opening of Sector Parallel to Background Filament | Opening of Sector Perpendicular to Background Filament | Opening of Sector Parallel to Background Filament | Opening of Sector Perpendicular to Background Filament |
| Current, in amperes, through pyrometer filament for brightness match..... | 0.3332  | 0.3354   | 0.3357  | 0.3357   |
| Apparent relative brightness.....   | 0.9390  | 0.9950   | 1.0000  | 1.0000   |
| Temperature of background for these readings, in degrees K.....           | 2263  | 2275   | 2277  | 2277   |

Errors Due to Various Causes.—In Table 7 is given the variation in extrapolated temperature due to a variation in initial temperature, in

effective wave-length, in transmission of absorbing glass or transmission of sector, and in current through pyrometer filament. First is given the change in the temperature due to one percentage variation of each and then some other possible variation. An inspection of this table will show that in extrapolated temperatures quite an error is allowed in the effective wave-length or the transmission of the sector or of absorbing glass without any great error in the final results. However, any error in calibrating at the initial temperature will cause a much larger error in the final result.

If a tungsten lamp is used as a background to standardize pyrometer lamps, for the highest accuracy, either the same kind of red glass must be used in calibrating the standard as is used with the pyrometer being calibrated, or correction must be made for the difference. The example given in the table corresponds to the difference between two glasses having the spectral transmissions shown by curves A and C, Fig. 4.

TABLE 7.—Changes in Temperature of 2400°, and 3000° K. Extrapolated from 1800° K. as Initial Temperature, Using Wien's Equation, Due to Various Changes

| Variation Leading to Error   | Percentage Change |      |      | Actual Change, Degrees K. |      |      |
|--|-------------------|------|------|---------------------------|------|------|
|  | 1800              | 2400 | 3000 | 1800                      | 2400 | 3000 |
| Change of 1 per cent. in initial temperature..   | 1.0               | 1.30 | 1.70 | 18.0                      | 32.0 | 50.0 |
| Change of 3° K. in initial temperature.....  | ...               | .... | .... | 3.0                       | 5.0  | 8.0  |
| Using a wave-length that is 1 per cent. in error.....  | ...               | 0.30 | 0.70 | ....                      | 8.0  | 20.0 |
| 0.001 $\mu$ error in wave-length.....  | ...               | 0.05 | 0.10 | ....                      | 1.2  | 3.0  |
| If in extrapolating the $\lambda_c$ of red glass between 1300° and 1800° K. is used, see Fig. 5.....   | ...               | 0.10 | 0.30 | ....                      | 2.4  | 7.5  |
| Calibrating pyrometer filament against tungsten lamp as background that was standardized with a red glass different from one used in pyrometer being calibrated. Suppose $\lambda_c$ to change from 0.665 $\mu$ to 0.650 $\mu$ ..... | ...               | .... | .... | 3.5                       |      |      |
| Error of 1 per cent. in value used for transmission of sector or absorbing glass.....  | ...               | 0.11 | 0.14 | ....                      | 2.7  | 4.2  |
| Variation of 1 per cent. in current through 2½-mil pyrometer filament.....   | 0.5               | 0.70 | 0.80 | 9.0                       | 16.0 | 25.0 |

If with the use of sectors or otherwise the pyrometer is calibrated to give relative brightness instead of temperature, the pyrometer is quite valuable for measuring the relative brightness of different sources. The pyrometer, thus calibrated, can also be used to measure the transmission of different glasses as, for instance, the transmission of the lamp bulb when an attempt is made to get the actual temperature of a filament.

These transmissions and relative brightnesses will correspond to the monochromatic glass used in the eyepiece.

This type of pyrometer possesses several advantages over other forms. In the first place, the observer is able to see the object whose temperature is being measured directly through the pyrometer, the same as through a telescope. It is hard to overestimate this advantage. Often it is very desirable to measure the temperature of a particular point of an extended body, as for instance, a mass of molten iron in the furnace or a particular spot on an ingot that is being rolled. This can be easily done with this pyrometer while it is very difficult with most other forms. For this reason, this form of pyrometer gives the temperature of a particular small area of the object whose temperature is being measured rather than an average over a more extended area. Also, it is not necessary to have an extended source in order to measure its temperature. Some pyrometers require a source that is very large if the observer is at any distance; such is not the case with this form.

Another advantage that is to be considered is the fact that this form of pyrometer is almost free from any error due to polarization. Any effect due to this cause would be negligible in almost the worst case possible.

#### DISCUSSION

C. O. FAIRCHILD, Washington, D. C. (written discussion\*).—Referring to the paragraph entitled "Effect of change in temperature of absorbing glass on its transmission," Dr. Foote and the writer have been using, since June, 1916, a correction for room temperature with absorbing glasses. For Jena black glass No. 3815, with a red-glass eyepiece the effective transmission increases instead of decreases with a rise in room temperature, corresponding to a decrease in the quantity  $A$  where

$$A = \frac{\lambda_0 \log T_r}{c_2 \log e}$$

The change in  $A$  was found to be approximately 0.02 per cent. per degree. Also noviweld of shade No. 7, having a very low transmission, was found to give a decreasing  $A$  when used with a red glass although the total transmission decreases and the spectral transmission curve shifts toward the red. The last is readily detected by noting the change in the tint of the glass when heated. This is also indicated by a marked improvement in the color match (upon heating) when the glass is used with a thin red-glass eyepiece. If a green glass, such as Jena 4930, is used in the eyepiece, an exceedingly great decrease in transmission is observed, consistent with the shift of the spectral transmission curve. Dr. Forsythe has not stated whether the values given in Table 4 are for a red-glass

---

\* Received Sept. 20, 1919.

eyepiece. It is readily apparent that the room-temperature factor is quite dependent on the particular eyepiece used, in cases where the spectral transmission of the absorbing glass varies rapidly in the region of transmission by the eyepiece. So there is considerable interest in measuring the change in spectral transmission of absorbing glasses, such as has already been done with red and other colored glasses.

W. E. FORSYTHE, (author's reply to discussion\*).—The transmission of each sample of absorbing glass that has been examined in this laboratory for different temperatures of the glass has changed in such a direction that this change could be accounted for by a shift of the transmission curve to longer wave-lengths. Thus, whether the transmission increased or decreased depended on the shape of the spectral transmission curve. Mr. Luckiesh of this laboratory has examined the transmission for the visible radiation for a number of glasses.<sup>21</sup> Among the glasses that he studied was a cobalt glass, the transmission of which increased with an increase in temperature. This is what is to be expected if the transmission curve shifted toward the red end of the spectrum when the glass was heated.

From the spectral transmission curve of Jena glass, No. 3815, given by Doctor Foote,<sup>22</sup> one would expect that its transmission for red radiation would decrease when it was heated, if the spectral transmission of this glass changes like the other glasses examined. However, not enough work has been done in this field to enable any definite general conclusion to be drawn.

The values given in Table 4 of the transmissions of different absorbing glasses are for red radiation, such as would be transmitted by red glass No. 4512, 5.8 mm. thick.

---

\* Received Jan. 19, 1920.

<sup>22</sup> U. S. Bureau of Standards *Bull.* 12, 489.

<sup>21</sup> *Jnl. Amer. Cer. Soc.*, 2, 759.

### Optical and Radiation Pyrometry

BY PAUL D. FOOTE,\* PH. D., AND C. O. FAIRCHILD,† B. S., WASHINGTON, D. C.

(Chicago Meeting, September, 1919)

THE temperature of a material may be ascertained by measurement of the intensity of the radiant energy it emits. This measurement may refer to the radiation of all wave lengths emitted by the material, or, if the material is glowing, the measurement may refer to the visible light emitted, or to the radiation in a very restricted portion of the visible spectrum. In general, the intensity of radiation depends not alone upon the temperature of the source, but also upon its nature. Thus, glowing carbon appears to the eye about three times as bright as glowing platinum, at the same temperature. This is technically expressed by saying that the emissive power or emissivity of carbon is about three times that of platinum.

A material having the highest theoretically possible emissivity is known as a "black body;" it is customary to assign a numerical value of 1 to the emissivity of a black body. A black body is experimentally realized by uniformly heating a hollow enclosure and observing the radiation coming from a small opening in the wall. The intensity of radiation emitted from this opening depends only on the temperature of the walls, and not on the material of which they are constructed. If  $E$  is the emissivity of any non-transparent material and  $R$  is its reflection coefficient, it can be shown that  $E + R = 1$ . If a material having an emissivity of, say, 0.40, and hence a reflection coefficient of 0.60, is placed inside a black body it becomes indistinguishable from its surroundings, because the total intensity of radiation leaving the material is the same as that emitted by the black body. While the material actually emits only 40 per cent. of the intensity of a black body at the same temperature, 60 per cent. of the radiation falling upon it from the walls of the enclosure is reflected. However, if the material is removed from the black body and placed in the open air, the reflected intensity is no longer present and the object appears but 40 per cent. as bright as a black body at the same temperature.

Optical and radiation pyrometers are usually calibrated to read correctly when sighted upon a black body. Fortunately, many technical processes are carried out under black-body conditions. Muffle furnaces, many annealing furnaces, etc., are sufficient approximations to "black

---

\* Physicist, U. S. Bureau of Standards.

† Associate Physicist, U. S. Bureau of Standards.

bodies" to give practically correct temperature readings with the optical or radiation pyrometer. Some materials are nearly "black" in the open; for example, the oxide formed on iron and steel ingots, rails, etc. In general, however, corrections must be applied to the pyrometer readings to obtain the correct temperatures of materials in the open. These corrections are very large in the case of clean molten metals. The presence of an oxide film on the molten metal greatly reduces the corrections.

The temperature scale for the optical pyrometer is based upon Wien's law for the distribution, in the spectrum, of the energy of a black body. This law may be stated by equation (1) in which  $\lambda$  denotes the wave length in microns;  $c_2$  is a constant = 14,350;  $\vartheta$  is the absolute temperature of the black body;  $J_\lambda$  is the intensity at the wave length  $\lambda$  (i.e., at a particular color, such as red); and  $c_1$  is a constant, the value of which is of no moment in pyrometry, since, as will be seen, it disappears from the actual working equation.

$$\text{For a black body, } J_\lambda = c_1 \lambda^{-5} e^{-\frac{c_2}{\lambda\vartheta}} \quad (1)$$

The intensity of radiation,  $J'_\lambda$ , of wave length,  $\lambda$ , from a non-black body of temperature  $\vartheta$  and emissivity  $E_\lambda$ , is given by equation (2).

$$\text{For a non-black body, } J'_\lambda = c_1 E_\lambda \lambda^{-5} e^{-\frac{c_2}{\lambda\vartheta}} = c_1 \lambda^{-5} e^{-\frac{c_2}{\lambda S_\lambda}} \quad (2)$$

In the third term of (2) we define  $S_\lambda$  as the apparent temperature, in degrees absolute of the non-black body. This is the temperature measured by the optical pyrometer and is less than the true temperature,  $\vartheta$ , for all materials except black bodies, when it becomes equivalent to  $\vartheta$ . From (2) we have:

$$\frac{1}{\vartheta} - \frac{1}{S_\lambda} = \frac{\lambda \log E_\lambda}{0.4343c_2} = \frac{\lambda \log E_\lambda}{6232} \quad (3)$$

Thus, knowing  $\lambda$  and  $E_\lambda$ , it is always possible to compute the true temperature  $\vartheta$  from the observed temperature  $S_\lambda$ .

An optical pyrometer is simply a photometer using monochromatic light (usually red), in which the intensity of radiation from either a standard or a constant source (electric lamp, oil flame, etc.) is compared with that from the object of which the temperature is desired. Frequently the two intensities are made to appear equal by adjusting various types of absorbing devices (absorption glasses, iris diaphragms, etc.) interposed either on the furnace side or the standard-lamp side of the pyrometer, depending upon which source is normally the brighter. In this process of comparison the term  $c_1 \lambda^{-5}$  of equation (1) is embodied as one of the calibration constants of the instrument.

The temperature scale for the radiation pyrometer is based upon the Stefan-Boltzmann law expressing the relation between the total energy  $J$  radiated per unit time per unit area by a black body, and its absolute temperature,  $\vartheta^\circ$  abs. as follows:

$$J = \sigma(\vartheta^4 - \vartheta_0^4) \quad (4)$$



where  $\vartheta_0$  denotes the absolute temperature of the surroundings or of the measuring instrument receiving the radiation, and  $\sigma$  an empirical constant. In general  $\vartheta_0^4$  is negligible in comparison with  $\vartheta^4$  so the above relation becomes:

$$J = \sigma\vartheta^4 \quad (5)$$

For a non-black body we have:

$$J' = \sigma E\vartheta^4 = \sigma S^4 \quad (6)$$

where  $E$  is the total emissivity and  $S$  is the apparent absolute temperature of the object sighted upon as measured by the radiation pyrometer. From (6) we obtain:

$$E = \frac{S^4}{\vartheta^4} \text{ or } \log E = 4 (\log S - \log \vartheta) \quad (7)$$

Thus, knowing the total emissivity  $E$  of any material, it is possible to obtain the true temperature  $\vartheta$  from the apparent temperature  $S$  as measured by a radiation pyrometer.

Equation (1) states that the intensity of radiation of a fixed wavelength from a black body is proportional to  $e^{-\frac{\text{constant}}{\vartheta}}$

Equation (5) states that the total radiation of all wave-lengths emitted by a black body is proportional to  $\vartheta^4$ . These two laws, which form the basis of optical and radiation pyrometry respectively, are in agreement with the temperature scale defined by the gas thermometer up to 1550° C., the upper limit at which a gas thermometer has been used satisfactorily. Above this range, to 2500° C., the scales defined by these two laws have been found, experimentally, to be in mutual agreement, and it is believed that they correctly represent the thermodynamic scale for all temperatures.

#### OPTICAL PYROMETRY

Fig. 1 illustrates the principle of the Fery optical pyrometer.  $G$  is a means for producing a divided photometric field. In the later instruments a Lummer-Brodhun or silver-strip cube is employed. Part of the field of view is illuminated by the source sighted upon and part by the gasoline lamp  $L$  which burns at a constant brightness. By moving the wedges of black glass,  $pp'$ , the thickness of absorbing glass in the line of sight can be varied until the part of the field illuminated by the source has the same brightness as that illuminated by the lamp. A red glass screen is used in the ocular so that fairly monochromatic light of this color (0.65 $\mu$  to 0.63 $\mu$ ) is compared. The relation between the thickness of the wedges  $x$ , read on a scale, and the absolute temperature  $\vartheta$  is  $x + P = Q/\vartheta$ , where  $P$  and  $Q$  are constants determinable by two calibration points. The instrument must be focused upon the radiating source but no corrections for sighting distance need be applied. The Le Chatelier optical pyrometer is similar in principle but is not of constant aperture and important corrections must be made with change of focus.

*Directions for Use of Fery Optical Pyrometer.*—Fill standard lamp about two-thirds full of gasoline (or amyloacetate, if originally calibrated for this illuminant) and adjust flame until tip burns on a level with the top of the slit cut in the tube encasing the lamp. Focus eye piece by drawing in or out until the field illuminated by the lamp is well defined. Focus the objective by thumb screw *C* until the source sighted upon is clearly outlined. Turn into the field the red glass screen in the eye cup and match the two photometric fields by adjusting the thumb screw which moves the wedges. Observe the reading on the scale. This reading is converted into temperature by use of a table or plot of scale readings furnished with the instrument. For varying and extending the range of

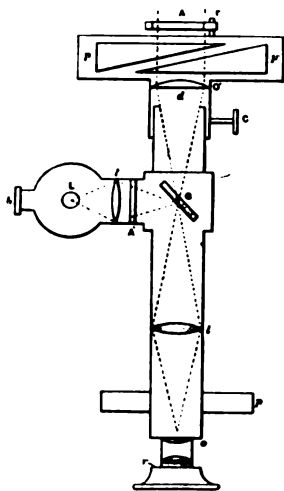

FIG. 1.—FERY OPTICAL PYROMETER.

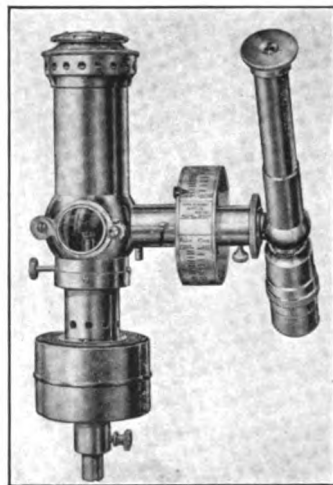

FIG. 2.—SHORE PYROSCOPE.

the instrument, two removable absorption glasses are used, one, *A'*, on the standard lamp side and one, *A*, immediately in front of the adjustable wedges. Care must be taken in making observations, to note whether these glasses are in or out, and in converting scale readings to temperature, to observe that the correct table or plot corresponding to the particular combination employed is used.

### *Shore Pyroscope*

The Shore pyroscope, Fig. 2, operates upon a principle very similar to that of the Fery optical pyrometer. The instrument has a scale graduated to read temperatures directly, which is a material advantage. The design of optical parts is rather unnecessarily complicated and it is difficult to match the two fields on account of color differences. The pyroscope is used extensively and with satisfactory results where high precision is not required.

*Directions for Use of Shore Pyroscope.*—Fill lamp two-thirds full of kerosene oil. Adjust the flame to burn at a height of about  $\frac{3}{4}$  in. (19 mm.). Focus on source by turning knurled ring on end of telescope tube. Turn knob by side of scale until the inner and outer fields match in brightness. Read temperature of source directly from scale setting.

*Wanner Pyrometer*

Fig. 3 illustrates the arrangement of the optical parts in the Wanner pyrometer. The comparison light is a six-volt incandescent lamp illuminating a glass matt surface in front of the slit  $S_2$ . The slit  $S_1$  is illuminated by the source sighted upon. Light from each slit passes through the collimating lens  $O_1$ , the direct-vision spectroscope  $P$ , a Wollaston prism  $R$ , a bi-prism  $B$ , the second collimating lens  $O_2$ , and is brought to a focus at  $F$ . The Wollaston prism produces two images of each slit, which are polarized at right angles to each other. The bi-prism again doubles the number of images, so that there are finally four images of each slit at  $F$ . Six of these images are diaphragmed off by the screen  $D$ . The two remaining images, one of each slit, are superposed and are

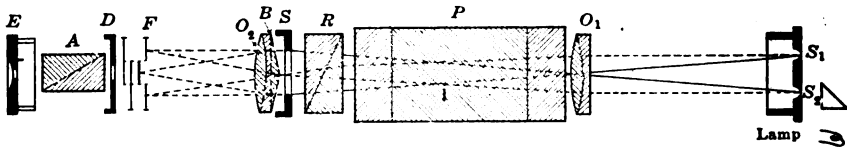

FIG. 3.—WANNER PYROMETER.

polarized at right angles to each other. From this point the light passes through the nicol prism  $A$  and the ocular lens  $E$ . The direct-vision spectroscope is so adjusted that only red light of wave length about  $\lambda = 0.65\mu$  reaches the eye, the other colors being diaphragmed off by the screen  $D$ . The ocular is focused on the dividing edge of the bi-prism  $B$ . The eye perceives a circular photometric field half of which is illuminated by the slit  $S_1$  and half by the slit  $S_2$ . The light from the two fields is plane polarized, the plane of polarization in one field being at right angles to the plane of polarization in the other field. Consequently, on rotating the nicol prism  $A$ , one field increases and the other field decreases in intensity. A setting is obtained when the two fields match.

In order to determine the proper brightness at which to operate the electric lamp illuminating the slit  $S_2$ , the pyrometer is sighted on a source of standard brightness. This consists of an amyacetate lamp with a flame gage having a window of ground glass, which illuminates the slit  $S_1$ . The analyzer nicol  $A$  is set at a specified normal point or angle, marked on the instrument. The current through the electric lamp is then varied by a rheostat until the two fields are matched, and the current is read from the ammeter. This process should be repeated

several times and a mean value of the current settings obtained; when using this instrument the current is adjusted to this mean value. The electric lamp burns at a high temperature and consequently deteriorates noticeably. Hence the above adjustment of the normal point requires frequent redetermination. For high precision the adjustment should be made both before and after a series of temperature readings. In the industrial plant, once a day or once a week is sufficient, depending upon the amount of use.

The calibration of the instrument follows the law

$$\log \tan \varphi = a + b/\vartheta$$

where  $\varphi$  is the angular reading of the analyzer,  $\vartheta$  the absolute temperature, and  $a$  and  $b$  empirical constants. Since the relation between  $\log \tan \varphi$  and  $1/\vartheta$  is linear, two calibration points serve to determine  $a$  and  $b$ , and  $\varphi$  may be plotted against  $t^\circ \text{C.}$  ( $t^\circ = \vartheta - 273^\circ$ ). Usually such a table is furnished with the pyrometer, or the instrument may be sent to the Bureau of Standards for calibration.

The instrument described above is satisfactory for temperatures greater than  $900^\circ \text{C.}$  At temperatures between  $700^\circ$  and  $900^\circ \text{C.}$ , the intensity of light from the furnace sighted upon is insufficient to permit accurate settings. For such temperatures, the direct-vision spectroscope  $P$  is replaced by a red glass screen, or the objective lens  $O_1$  is made of red glass, and the slits  $S_1$  and  $S_2$  have much wider openings. For very high temperatures, an absorption glass is mounted in front of the slit  $S_1$  which decreases the light from the furnace in a known ratio.

On account of stray light, the Wanner pyrometer is not accurate at very small or very large angular readings. Moreover, at large angles the temperature increases so fast that the angles would have to be observed with extreme precision to give accurate results expressed in degrees of temperature. The range of the instrument is thus confined to from about 10 to 80 angular degrees.

With the Wanner pyrometer, the tip of the flame of the amylacetate lamp should burn level with the top of the flame gage. The setting on the normal point is tedious because the flame flickers over the field. A screen of black paper placed around the lamp helps to reduce the flicker, and the observations should be made in a closed room free from drafts. Any error in the adjustment of the normal current is carried over to the final temperature measurements, so that it is exceedingly important to exercise all possible care in those preliminary adjustments. Examine the screen of the flame gage to assure that no smoke has deposited upon it. A slight film of smoke from the lamp may cause an error of  $100^\circ$  or more. The amylacetate used in the lamp need not be of high purity.

From experience with several hundred instruments in use in the tech-

nical industries, it is evident that these pyrometers are subjected to great abuse. The instrument is composed of delicate optical parts and should not be allowed to become heated. Many of the parts are set in wax and the various optical surfaces are cemented by Canada balsam. The Wollaston prism, and the nicol prism in the rotating eye piece are made of calcite. In about half the instruments examined these parts have been deeply cut by knives or pointed steel tools. All persons using this pyrometer should be cautioned not to touch any optical part except the lens in the eye cup, which requires occasional cleaning. Do not change the setting of any screw, as this may throw the pyrometer out of the adjustment and cause errors of  $500^{\circ}$ . If the position of any screw on the

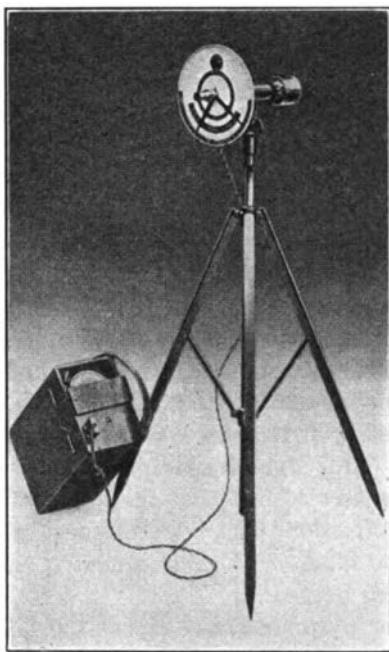

FIG. 4.—SCIMATCO PYROMETER.

body of the instrument is altered, do not attempt to readjust the instrument but return it to the maker. Also, do not take the instrument apart to find out what is wrong. The replacement of the electric lamp will not alter the calibration of the pyrometer.

#### *Scimatco Pyrometer*

Fig. 4 illustrates the Scimatco pyrometer formerly sold by the Scientific Materials Co. This is an improved form of the Wannier pyrometer. All but one of the screws, the tampering with which affects the calibration of the instrument, are enclosed in a metal sheath. The instrument

has both an angular scale and a scale graduated directly in degrees of temperature. The box at the left contains a 6-volt storage battery, an ammeter, and an adjustable rheostat. For obtaining the proper setting of the current, the pyrometer is clamped in its carrying case. The amyacetate lamp and flame gage are so mounted that the ground glass of the gage is directly in contact with the glass window of the pyrometer, opening to the slit  $S_1$  of Fig. 3. The tip of the flame is adjusted until it is just visible on looking through the bottom of the red glass window in the dial of the instrument. With the Wannier or Scimatco pyrometer, the observer cannot see, through the instrument, the object sighted upon. This may cause inconvenience if it is desired to measure the temperature of a small crucible in a furnace.

### *Foote & Fisher Pyrometer*

Fig. 5 illustrates the arrangement of optical parts in the Foote & Fisher pyrometer made by the Scientific Materials Co. Light from the furnace is focused at the center of the silver-strip cube  $C$ . This cube

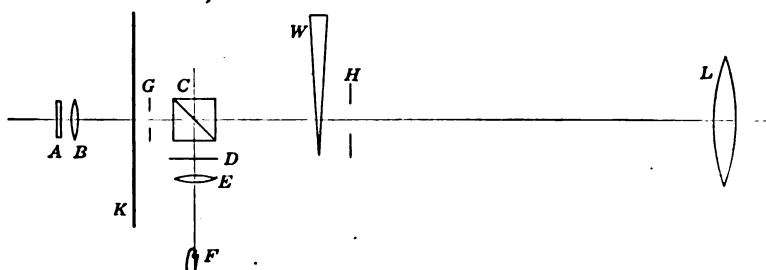

FIG. 5.—FOOTE & FISHER PYROMETER.

produces a circular field divided through the middle. One half of the field receives light from the furnace, and the other half from the ground-glass screen  $D$  which is illuminated by the electric lamp  $F$  through the condenser lens  $E$ . The ocular containing the red glass screen  $A$  and lens  $B$  is focused on the dividing edge of this photometric field.  $G$  and  $H$  are diaphragms which limit the cone of rays employed. The two fields are matched by turning a thumb screw which moves the black glass wedge  $W$  across the path of the light from the furnace. By a system of gears this movement is transferred to a circular scale on the dial  $K$  of the instrument. In appearance the pyrometer resembles the Scimatco, and is used in the same manner. For a normal point setting, the pointer is adjusted to read the normal angle and after removing the tube carrying the lens  $L$  the instrument is clamped in its case. The flame gage of the amyacetate lamp is so mounted that its ground-glass window is adjacent to the diaphragm  $H$ . A table is furnished with the instrument giving the relation between the scale reading in angular degrees and degrees of

temperature. This instrument is so designed that the object sighted upon is clearly imaged, a distinct advantage over the Wanner pyrometer. The relation between the scale reading  $\alpha$  and the absolute temperature  $\vartheta$  is  $\alpha + P = Q/\vartheta$  where  $P$  and  $Q$  are constants determinable by two calibration points.

*Morse, Holborn-Kurlbaum, and Leeds & Northrup Optical Pyrometers*

The filament of a small electric lamp  $F$ , Fig. 6, is placed at the focal point of an objective  $L$  and ocular, forming an ordinary telescope which superposes upon the lamp the image of the source viewed. Red glass, such as Corning "High Transmission Red," is mounted at the ocular to produce approximately monochromatic light. In making a setting, the current through the lamp is adjusted by rheostat until the tip or some definite part of the filament is of the same brightness as the source viewed.

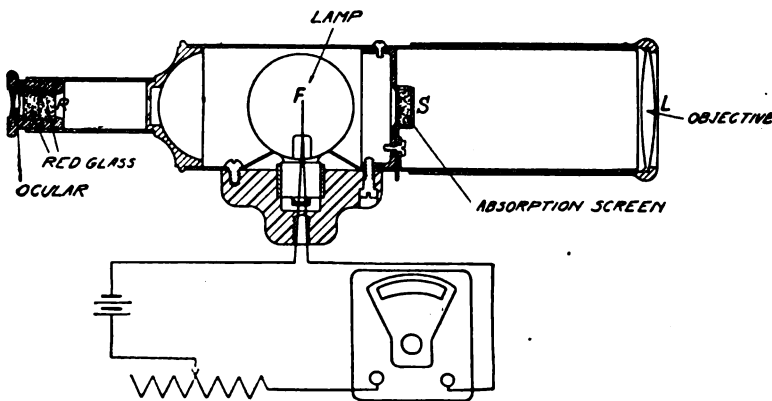

FIG. 6.—LEEDS & NORTHRUP OPTICAL PYROMETER.

The outline, or detail, of this section of the filament is then indistinguishable from the surrounding field, as illustrated by Fig. 7; in the third setting the central portion of the filament vanishes against the background. The current is read on an ammeter and the corresponding temperature is computed from a plot or table. The relation between the current,  $i$ , through the lamp and the temperature  $t^{\circ} C.$ , is of the form:  $i = a + bt + ct^2$  where  $a$ ,  $b$ ,  $c$ , are constants requiring for their determination at least three standardization points.

The lamps should not be operated at temperatures higher than  $1500^{\circ} C.$ , on account of deterioration of the tungsten filament. If this temperature is not exceeded, the calibration of the lamp is good for hundreds of hours of ordinary use. For higher temperatures, absorption glasses,  $S$ , Fig. 6, are placed between the lamp and the objective, or in front of the objective, to diminish the observed intensity of the source.

The relation between the temperature of the source,  $\vartheta^{\circ}$  abs., and the observed temperature,  $\vartheta_0^{\circ}$  abs., measured with the absorption glass interposed, is as follows:  $\frac{1}{\vartheta} - \frac{1}{\vartheta_0} = A$ , where  $A$  is for most practical purposes a constant.

Usually the instrument is furnished with a table showing the relation between the current through the lamp and the temperature both with and without the absorption glass. If, however, this relation is not given for the use of the absorption glass, it may be readily determined by measuring the constant  $A$  in the above formula. To do this, sight without the ab-

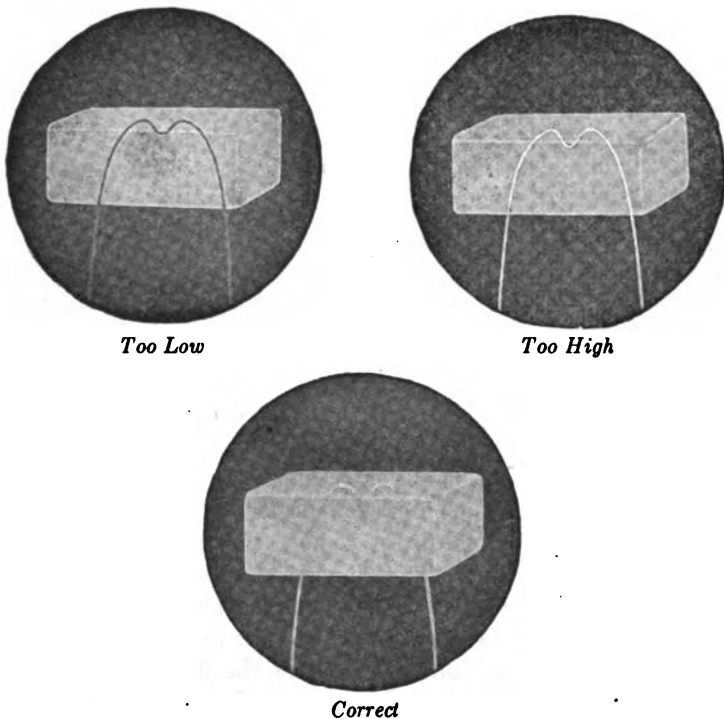

FIG. 7.—APPEARANCE OF FIELD OF VIEW WHEN ADJUSTING THE CURRENT THROUGH THE LAMP OF LEEDS & NORTHRUP PYROMETER.

sorption glass on a muffle or any uniformly heated furnace at  $1200^{\circ}$  to  $1500^{\circ}$  C. and observe the temperature  $\vartheta$ , in degrees absolute. Then, with the absorption glass in place, match the filament again and observe to what temperature,  $\vartheta_0$ , in degrees absolute, the current through the lamp corresponds. The difference in the reciprocals of these two temperatures is the constant  $A$ , which is usually of the order of magnitude  $-0.0002$ . This determination should be repeated several times and at several different temperatures of the furnace. The separate values of  $A$  should not differ by more than 1 per cent. and the mean value is used for computing



the relation between the observed absolute temperature with the absorption glass and the true temperature of the source. In making these computations, care must be exercised that all temperatures are converted to degrees absolute. Table 1 illustrates the calibration of a certain pyrometer, both with and without the absorption glass, the constant of which has the value  $A = -0.000280$ . By use of this glass, temperatures as high as  $2730^{\circ}\text{C}$ . can be measured, although the temperature of the lamp does not exceed  $1360^{\circ}\text{C}$ .

TABLE 1.—*Example Calibration of Optical Pyrometer*

| Current,<br>Amp. | Temperature, Deg. C.     |                       |
|------------------|--------------------------|-----------------------|
|                  | Without Absorption Glass | With Absorption Glass |
| 0.26             | 634                      | 943                   |
| 0.28             | 765                      | 1190                  |
| 0.30             | 860                      | 1386                  |
| 0.32             | 936                      | 1555                  |
| 0.34             | 1002                     | 1710                  |
| 0.36             | 1060                     | 1854                  |
| 0.38             | 1113                     | 1992                  |
| 0.42             | 1201                     | 2237                  |
| 0.46             | 1281                     | 2478                  |
| 0.50             | 1359                     | 2733                  |

It will be noted that the range of current required is small, in general about 0.3 to 0.6 ampere. Thus, if the ammeter is designed to give full-scale deflection with 0.6 ampere, nearly half of the scale, from 0 to 0.26 ampere, is never used. The Hickok depressed-zero ammeter, now furnished with the Leeds & Northrup pyrometer, meets this objection. The moving-coil system, including the supports, pivots, and pointer, may be adjusted relative to the magnet by turning a lever on the case of the instrument to one of two positions. In one position the pointer is adjusted *on open circuit* so that it falls over the first graduation on the scale; this adjustment is similar to the ordinary zero adjustment on any ammeter. In the second, or working, position the zero is depressed from the scale an amount equivalent to 0.26 ampere. The entire scale from 0.26 to 0.60 ampere is thus utilized for the range of the pyrometer lamp.

*General Use of Optical Pyrometers*

Optical pyrometers and radiation pyrometers, described later, afford the only means yet developed for measuring temperatures above  $1500^{\circ}\text{C}$ . The high-temperature scale, above  $1500^{\circ}\text{C}$ ., is based on the extrapolation of Wien's radiation law by means of a pyrometer of the Leeds & Northrup type. When the instrument is especially designed for precision work it is possible to measure a temperature difference of  $0.2^{\circ}\text{C}$ .

at 1500° C. The commercial form of the instrument, when properly calibrated, can be relied upon to 5° C. With a well-designed optical pyrometer there is a perfect color match of the two fields at all times. Hence, contrary to the general impression, color is not matched at all but simply brightness of uniform color. A color-blind observer will obtain the same settings as a normal observer. Forsythe<sup>1</sup> has compiled data observed with an optical pyrometer of the Leeds & Northrup type by six operators, none of whom had ever used an optical pyrometer before. The average variation from the mean was 3° C., and the maximum variation, 5° C.

Although the optical pyrometer is essential for the measurement of temperatures above 1500° C., its usefulness is by no means confined to the high-temperature range. To many processes at low temperatures, the thermocouple cannot be adapted, for example, to measure the temperature of steel rails as they pass through the rolls, of ingots and forgings in the open, and of small sources such as a heated wire or lamp filament. In such cases, the temperatures may be accurately measured by the optical pyrometer. The temperature of a microscopic sample of any material can be measured by a modified form of the Leeds & Northrup pyrometer.<sup>2</sup> Also, in many processes a thermocouple is not so convenient as an optical pyrometer, especially when measurements of temperature are not required often enough to warrant a permanent installation of thermocouples.

One serious objection to the optical pyrometer, from the industrial point of view, is the fact that it has not been made automatically recording. Since a photometric match is required for every setting, the instrument necessitates the attention of an observer, although possibly a satisfactory automatic device will be developed eventually. Another objection is the introduction of the human element into the readings, thus affording an opportunity for dishonest or prejudiced settings. The observer, if he is the operator of the furnace, should be taught that the instrument is for his own assistance and is not to be considered as a police measure. Otherwise, the measurements should be made by a disinterested party. In a plant operating several furnaces, an intelligent boy can be profitably employed whose sole work is to make the rounds of the various furnaces and measure and record the temperatures.

#### *Black-body and Non-black-body Conditions*

Optical pyrometers are usually calibrated to read correctly when sighted on a black body. Many furnaces approximate black-body conditions quite satisfactorily. In a perfect black body, the details of the

---

<sup>1</sup> *Gen. Elec. Rev.* (Sept., 1917) **20**, 753.

<sup>2</sup> *Burgess*: U. S. Bureau of Standards *Sci. Paper* 198.

inside of the furnace vanish and a piece of steel, for example, which is being heated cannot be distinguished from the background. If the objects in the furnace can be distinguished, but only on close observation, and if much of the detail is lost, *after the objects have been in the furnace some time*, it is not likely that the temperature measurement will be seriously in error. If in error at all, the observed temperature will be too high when the furnace walls are brighter than the material being heat treated, and too low when the walls are less bright. This latter condition is possible if the heat supply is variable, or if it is shut off and the furnace is allowed to cool.

That a steel ingot placed in a heated furnace may appear much hotter than it really is, is a fact not always appreciated. The surface of the ingot appears hot because it reflects the bright light from the walls of the furnace. Of course, in comparison with the much greater brightness of the walls, the cold ingot appears black, but this is due to the intense contrast. If the ingot is viewed alone while the *direct* radiation from the furnace is screened from the eye, it also is bright. Thus, when an optical pyrometer is sighted on an ingot in the furnace, part of the light reaching the instrument comes from the side walls and is reflected by the surface of the ingot. Iron oxide reflects about the least light of all materials met with in metallurgical practice. Its emissivity is approximately 0.95; hence its reflection coefficient is 0.05. Suppose an iron ingot at room temperature were suddenly placed in a furnace at 1200° C. Although the surface of the ingot is cold, it reflects 5 per cent. of the light falling upon it from the hot side walls; this 5 per cent. of reflected radiation gives the ingot the appearance of an object at 950° C., and measurement by the optical pyrometer accordingly would be 950° C. The greater the reflecting power of the material the higher is the observed temperature under the above conditions. Thus, cold platinum would appear to be at about 1160°, or at almost the same temperature as that of the furnace. One method for reducing the error due to reflected radiation is to view the object through a large open door, sighting on a surface parallel to the opening. When the material has attained the temperature of the side walls, it is of course not desirable to open a large door since the opening would then affect the black-body conditions. The pyrometer should be sighted through a small peep hole as soon as approximate temperature uniformity is obtained. A more satisfactory method for reducing the stray reflections than by opening a large door is to sight into a deep wedge-shaped cavity or hole made in the metal being heat treated. If this cavity is deep enough, very little radiation from the furnace walls can be reflected from it. If such a hole cannot be made conveniently, a length of iron pipe closed at one end, or a porcelain tube, may be placed on the material and so aligned that the pyrometer may be sighted through a peep hole directly into the bottom of the tube.

The effect of reflected light is very noticeable in an empty coke oven, the reflection coefficient of the brick walls being comparatively high. The walls may therefore appear equally bright, even though they differ considerably in temperature. Frequently a patch of the wall on one side becomes coated with a layer of coke. Since the coke has a higher emissive power than brick, this patch appears much hotter; actually it is about the same temperature as the surrounding wall. On account of reflection, a corresponding bright patch appears on the opposite wall, although this wall may be free from coke.

TABLE 2.—*True Temperatures and Apparent Temperatures Measured by Optical Pyrometers Using Red Light ( $\lambda = 0.65\mu$ ) when Sighted upon Various Materials in the Open*

| Observed Temp. | True Temperature, Degrees C. |              |                  |                    |                     |              |                 |
|----------------|------------------------------|--------------|------------------|--------------------|---------------------|--------------|-----------------|
| Degrees C.     | Molten Copper                | Molten* Iron | Solid Iron Oxide | Solid Nickel Oxide | Nichrome or Chromel | Molten Slag† | Bright Platinum |
| 700            |                              |              | 700              | 701                | 702                 |              | 750             |
| 800            |                              |              | 801              | 802                | 804                 |              | 861             |
| 900            |                              |              | 902              | 904                | 906                 |              | 973             |
| 950            | 1088                         |              | 953              | 955                | 958                 |              | 1030            |
| 1000           | 1150                         |              | 1004             | 1007               | 1010                |              | 1087            |
| 1050           | 1213                         |              | 1055             | 1058               | 1063                |              | 1144            |
| 1100           | 1277                         | 1183         | 1106             | 1110               | 1116                |              | 1202            |
| 1150           | 1341                         | 1239         | 1158             | 1162               | 1170                |              | 1260            |
| 1200           | 1405                         | 1296         | 1210             | 1215               | 1224                |              | 1320            |
| 1250           | 1470                         | 1353         |                  | 1267               |                     |              | 1375            |
| 1300           | 1536                         | 1410         |                  | 1320               |                     |              | 1435            |
| 1400           |                              | 1525         |                  |                    |                     | 1455         | 1555            |
| 1500           |                              | 1641         |                  |                    |                     | 1565         | 1675            |
| 1600           |                              | 1758         |                  |                    |                     | 1670         |                 |
| 1700           |                              | 1876         |                  |                    |                     | 1780         |                 |
| 1750           |                              | 1935         |                  |                    |                     | 1830         |                 |

\* Computed for  $E_\lambda = 0.40$ , this being the best value for ordinary steel practice.

† Computed for  $E_\lambda = 0.65$ , an average value for liquid slags.

When an optical pyrometer is sighted on a glowing material in the open, it reads too low. Certain materials, important industrially, have a high emissivity, so that the corrections necessary to add to the observed temperatures are small; for example, for iron oxide the correction is only 10° at 1200° C. The corrections are very large for clear molten metals, but are smaller for the oxides which soon form on the molten surface when exposed to the air. Table 2 shows the true temperatures corresponding to the temperatures observed when sighting on certain materials in the open. For temperature control it is unnecessary to apply these corrections; the observed temperatures will be low by

the same amount from time to time, and hence will serve just as satisfactorily as the corrected temperatures for reproducing temperature conditions in any process. This statement must be modified if factors other than emissivity of the material require consideration. For example, reproducible results cannot be expected if heavy clouds of smoke are in the line of sight one day and not on the next day. If the pyrometer is sighted on a stream of molten iron during pouring or tapping, the surface of the metal is usually free from oxide. If the stream should at any time contain much slag, the surface will show bright patches on account of the higher emissivity of the slag. To make the readings conform with those taken on the clear stream, one must sight on the darker spaces between the slag patches or sight also upon the slag and correct both sets of data according to Table 2.

The above table was computed from the following equation, where  $\vartheta$  is the true absolute temperature,  $S$  the observed absolute temperature, and  $E_\lambda$  the emissivity for the wave length  $\lambda$ . This wave length has been selected as  $\lambda = 0.65\mu$ , the approximate value for optical pyrometers.

$$\frac{1}{\vartheta} - \frac{1}{S} = \frac{\lambda \log E_\lambda}{6232} = \frac{\log E_\lambda}{9588}$$

Table 3 gives the emissivity of various materials for the above wave length. The change of emissivity with temperature is usually small for metals.

TABLE 3.—*Monochromatic Emissivity for Red Light ( $\lambda =$  about  $0.65\mu$ )*

| Material               | $E_\lambda$ | Material                        | $E_\lambda$  |
|------------------------|-------------|---------------------------------|--------------|
| Silver.....            | 0.07        | Cuprous oxide.....              | 0.70         |
| Gold, solid.....       | 0.13        | Iron oxide, 800° C.....         | 0.98         |
| Gold, liquid.....      | 0.22        | Iron oxide, 1000° C.....        | 0.95         |
|                        |             | Iron oxide, 1200° C.....        | 0.92         |
| Platinum, solid.....   | 0.33        | Nickel oxide, 800° C.....       | 0.96         |
| Platinum, liquid.....  | 0.38        | Nickel oxide, 1300° C.....      | 0.85         |
| Palladium, solid.....  | 0.33        |                                 |              |
| Palladium, liquid..... | 0.37        |                                 |              |
| Copper, solid.....     | 0.11        | Iron, solid and liquid.....     | 0.37         |
| Copper, liquid.....    | 0.15        | Nickel, solid and liquid.....   | 0.36         |
| Tantalum, 1100° C..... | 0.60        | Iridium.....                    | 0.30         |
| Tantalum, 2600° C..... | 0.48        |                                 |              |
|                        |             | Rhodium.....                    | 0.30         |
| Tungsten, 1000° C..... | 0.46        |                                 |              |
| Tungsten, 2000° C..... | 0.43        | Graphite powder (estimated).... | 0.95         |
| Tungsten, 3000° C..... | 0.41        |                                 |              |
|                        |             | Carbon.....                     | 0.85         |
| Nichrome, 600° C.....  | 0.95        |                                 |              |
| Nichrome, 900° C.....  | 0.90        | Porcelain (? ?).....            | 0.25 to 0.50 |
| Nichrome, 1200° C..... | 0.80        |                                 |              |

Table 4 shows the corrections which must be added to the readings obtained with an optical pyrometer using light of wave length  $\lambda = 0.65\mu$ , for various emissivities, in order to obtain the true temperatures. These data are especially useful when carefully plotted with observed temperatures as abscissas and corrections as ordinates. A family of curves is thus obtained corresponding to the different values of the emissivity.

TABLE 4.—*Corrections to Observed Temperatures for Pyrometer Using Red Light ( $\lambda = 0.65\mu$ ;  $c_2 = 14,350$ )*

| Emissivity | Add Corrections Below for the Following Observed Temperatures, °C. |     |     |      |      |      |      |      |      |      |      |
|------------|--|-----|-----|------|------|------|------|------|------|------|------|
|            | 700  | 800 | 900 | 1000 | 1100 | 1200 | 1300 | 1400 | 1600 | 1800 | 2000 |
| 0.30       | 55   | 67  | 80  | 95   | 111  | 129  | 148  | 168  | 213  | 264  | 322  |
| 0.40       | 41   | 50  | 60  | 71   | 83   | 96   | 110  | 125  | 158  | 195  | 237  |
| 0.50       | 31   | 37  | 45  | 53   | 62   | 71   | 82   | 93   | 117  | 144  | 175  |
| 0.60       | 22   | 27  | 33  | 39   | 45   | 52   | 59   | 67   | 85   | 104  | 126  |
| 0.70       | 16   | 19  | 23  | 27   | 31   | 36   | 41   | 47   | 59   | 72   | 87   |
| 0.80       | 10   | 12  | 14  | 17   | 19   | 22   | 25   | 29   | 36   | 44   | 54   |
| 0.90       | 5  | 6   | 7   | 8    | 9    | 10   | 12   | 14   | 17   | 21   | 25   |
| 1.00       | 0  | 0   | 0   | 0    | 0    | 0    | 0    | 0    | 0    | 0    | 0    |

*Temperature of Glowing Gauze*

An interesting application of the optical pyrometer is for the measurement of the temperature of gauze electrically or otherwise heated. In certain chemical processes, platinum gauze electrically heated is used as a catalyzing agent, and must be maintained at a constant temperature. This is readily done by sighting normally on the surface of the gauze with an optical pyrometer. The observed temperatures may be thus exactly reproduced from day to day. If it is required to convert the observed temperatures into exact true temperatures of the wire forming the gauze the problem is difficult. An approximate solution satisfactory for all industrial work is, however, easily obtained.

We will assume that the mesh of the gauze is sufficiently coarse so that multiple reflection between the separate wires is negligible. Let  $A_1$  be the fractional part of the total area of the gauze comprised by the wire, and  $A_2$  be the fractional part of the total area representing the space between the wires. Let  $E_\lambda$  be the emissivity of the metal employed, and  $E'_\lambda$  be the effective emissivity of the gauze as a whole, that is, taking into consideration the spaces between the wires, which, of course, are not radiating surfaces. The following equations are readily apparent.

$$E'_\lambda = \frac{A_1}{A_1 + A_2} E_\lambda = A_1 E_\lambda \text{ since } A_1 + A_2 = 1$$

$$\frac{1}{\vartheta} - \frac{1}{S} = \frac{\log A_1 E_\lambda}{9588}$$

where  $\vartheta$  is the true absolute temperature of the wire of the gauze, and  $S$  is the absolute temperature observed with an optical pyrometer sighted normal to the surface.

A platinum gauze commonly employed is 80-mesh (80 wires to the inch) of 0.003-in. (0.07 mm.) wire; for this gauze,  $A_1 = 0.42$ . The emissivity of bright clean platinum is 0.33. The platinum of this gauze soon becomes somewhat corroded; possibly an emissivity of 0.4 is more nearly the correct value under these conditions. Hence the effective emissivity of the gauze is  $A_1 E_\lambda = (0.42) \times (0.4) = 0.17$ .

Usually the gauze must be viewed through a glass window. A thin glass window (see below) transmits about 90 per cent. of the light falling upon it. Hence the final effective emissivity, using a glass window, is  $E'_\lambda = (0.17) \times (0.90) = 0.15$ .

Table 5 was computed by the formula  $1/\vartheta - 1/S = \log 0.15/9588$ . A similar table for other gauzes may be computed in the manner outlined.

TABLE 5.—*Platinum Gauze, 80-mesh, 0.003-in. Wire.*  
 (Temperatures Observed Through One Window by Optical Pyrometer Sighted Normal to Surface of Gauze, and True Temperature of Gauze)

| Observed Temp.,<br>Deg. C. | True Temp.,<br>Deg. C. | Observed Temp.,<br>Deg. C. | True Temp.,<br>Deg. C. |
|----------------------------|------------------------|----------------------------|------------------------|
| 600                        | 675                    | 850                        | 975                    |
| 650                        | 730                    | 900                        | 1035                   |
| 700                        | 790                    | 950                        | 1095                   |
| 750                        | 850                    | 1000                       | 1160                   |
| 800                        | 910                    | 1050                       | 1220                   |

*Observations through a Window*

It is frequently necessary, especially in the laboratory, to sight an optical pyrometer into a furnace through a window, necessitating a correction to the observed temperatures. Kanolt has measured the transmission coefficient for a number of ordinary glass windows at  $\lambda = 0.65 \mu$ , and obtained a mean value of 0.904. Hence we have

$$\frac{1}{\vartheta} - \frac{1}{S} = \frac{\log 0.904}{9588} = -0.0000046$$

where  $\vartheta$  is the true absolute temperature of the source and  $S$  is the observed absolute temperature. Table 6 is computed from the above formula.

*Flames and Smoke*

The optical pyrometer cannot be used satisfactorily when sighted through flames or smoke. Usually the presence of dense flames increases

the temperature reading, and the presence of smoke clouds absorbs so much radiation that the pyrometer may read several hundred degrees too low. The optical pyrometer can be used to measure the temperature of the slag in an open-hearth furnace but the flames prove a serious hindrance except during reversals, when observations may be taken to advantage. In a cement kiln the dust, smoke, and flames all combine to make the observations very untrustworthy. Carbon dioxide, water vapor, and other invisible gases produce no effect.

TABLE 6.—*Correction to Observed Temperatures for Absorption of Light by a Single Clean Window*

| Observed Temp.,<br>Deg. C. | Correction to add,<br>Deg. C. | Observed Temp.,<br>Deg. C. | Correction to add,<br>Deg. C. |
|----------------------------|-------------------------------|----------------------------|-------------------------------|
| 600                        | 3.5                           | 1600                       | 16.0                          |
| 800                        | 5.4                           | 1800                       | 20.0                          |
| 1000                       | 8.0                           | 2000                       | 24.0                          |
| 1200                       | 10.0                          | 2500                       | 36.0                          |
| 1400                       | 13.0                          | 3000                       | 50.0                          |

*Method of Sighting into a Closed Tube*

In many processes where smoke cannot be eliminated, or where black-body conditions are not satisfactory, a porcelain or other refractory tube with a closed end is inserted into the furnace. The pyrometer is sighted into this tube which, if fairly uniformly heated over a sufficient area, affords an excellent black body. This method has been employed also for obtaining the true temperature of molten metals, but suitable refractory tubes for many molten metals have yet to be developed.

RADIATION PYROMETRY

An optical pyrometer measures the intensity of a narrow spectral band of radiation emitted by a glowing object; the radiation pyrometer measures the intensity of all wave lengths, the light rays and the heat rays combined. Usually the energy radiated by the source is focused in some manner upon the hot junction of a small thermocouple. The temperature to which this junction rises is approximately proportional to the rate at which energy falls upon it, which in turn, by the Stefan-Boltzmann law, is proportional to the fourth power of the absolute temperature of the source. The rise in temperature of the hot junction of the couple generates a thermoelectric force; hence the calibration of a radiation pyrometer consists in determining the relation between the e. m. f. developed and the temperature of the source sighted upon. This relation follows the law  $e = a\vartheta^b$  where  $\vartheta$  is the absolute temperature of source,  $e$  is the e. m. f.



developed by the instrument, and  $a$  and  $b$  are empirical constants determinable by two standardization points. The e. m. f. may be measured by a potentiometer or galvanometer, or by any of the methods applied to thermoelectric pyrometry. The galvanometer should have as high a resistance as is consistent with the requirement of robustness. The same type of instrument is used with the radiation pyrometer as with the ordinary thermocouple. The temperature of the cold junction of the couple in the radiation pyrometer is not controlled; the hot and the cold junction are in fairly close proximity and hence are equally affected by changes in room temperature. The cold junction is always shaded from the heat radiated by the source sighted upon.

### Thwing Radiation Pyrometer

Fig. 8 illustrates the principle of the pyrometer made by the Thwing Instrument Co. Radiation from the furnace enters the diaphragm  $A$  and falls upon the hollow conical mirror  $K$ . The hot junction  $C$  of a minute thermocouple is located at the apex of the cone, and the cold

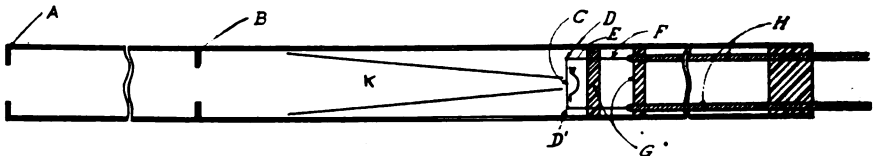

FIG. 8.—RECEIVING SYSTEM OF THWING RADIATION PYROMETER.

junctions are at  $D$  and  $D'$ . By multiple reflection along the sides of the conical mirror the radiation is finally concentrated upon the hot junction of the couple. The e. m. f. is measured by a galvanometer graduated to read temperature directly. Fig. 9 shows the method of using this instrument for measuring the temperature of a large furnace. Except for incidental errors, which will be considered later, the reading of the instrument is independent of the sighting distance, provided the diameter of the source is sufficient to fill the cone of rays defined by the geometrical design of the receiving tube; this is shown in Fig. 10. The amount of radiation falling upon an element  $D$  of the conical mirror is proportional to the solid angle  $HDA'$ , which is independent of the distance from the point  $D$  to the source; this is true of every point on the base of the cone  $DD'$ . Hence, the total energy entering the cone is independent of the distance from the pyrometer to the source, provided the source is of sufficient size. The minimum size of source for any distance is determined by the lines  $A''D'$  and  $A'D$ . Thus, for the distance  $BA$  the diameter of the source must be at least  $A'A''$ , and for the distance  $BP$  the diameter of the source must be at least  $P'P''$ . The Thwing instrument is so con-

structed that the source must have a diameter at least one-eighth of the distance from the source to the receiving tube; thus, at 8 ft. (2.4 m.) from a furnace the opening into the furnace must be 1 ft. (0.3 m.) in diameter.

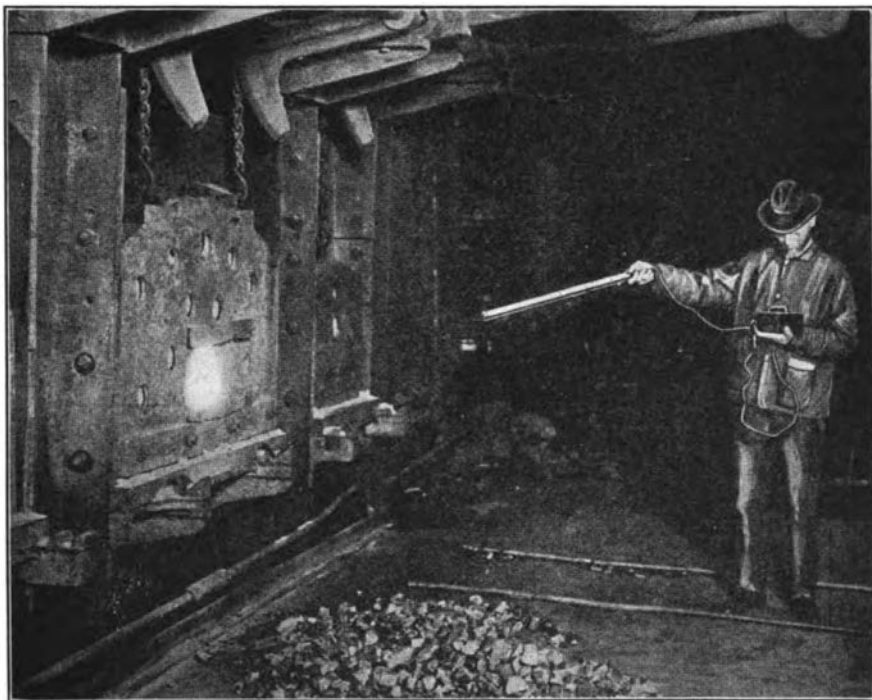

FIG. 9.—OBSERVING TEMPERATURE OF A FURNACE WITH THWING RADIATION PYROMETER.

For permanent installations, the tube is ventilated and has several extra diaphragms to prevent local heating of the instrument and re-

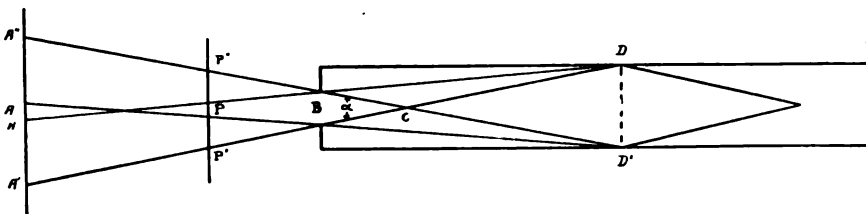

FIG. 10.—CONE TYPE OF FIXED-FOCUS RADIATION PYROMETER.

radiation to the couple. Fig. 11 shows a permanently installed Thwing radiation pyrometer sighted into the bottom of a closed metal tube which projects into the furnace.

*Foster Radiation Pyrometer*

Fig. 12 illustrates the principle of the Foster radiation pyrometer, made by the Taylor Instrument Companies. The thermocouple  $b$  and a front diaphragm  $B$  are located at the conjugate foci of a concave mirror  $DD'$ . As in the case of the Thwing pyrometer, the source must be large enough to fill the cone of rays defined by the angle  $\alpha$ , or the lines  $A'CA''$ . The position of the point  $C$  is marked by a wing nut on the telescope tube.

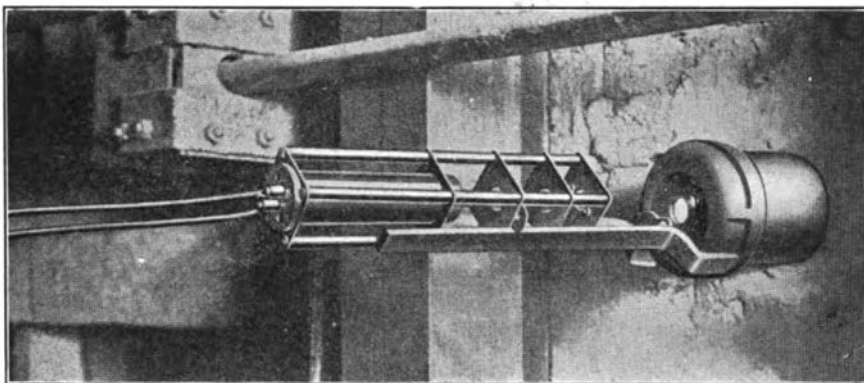

FIG. 11.—THWING RADIATION PYROMETER FOR FIXED INSTALLATION ON FURNACE WALL.

The angle  $\alpha$  is made such that the diameter of the source sighted upon must be at least one-tenth the distance from the source to the wing nut. The Brown Instrument Co. makes a radiation pyrometer similar in principle to the Foster pyrometer, but its receiving tube is collapsible for convenience in carrying.

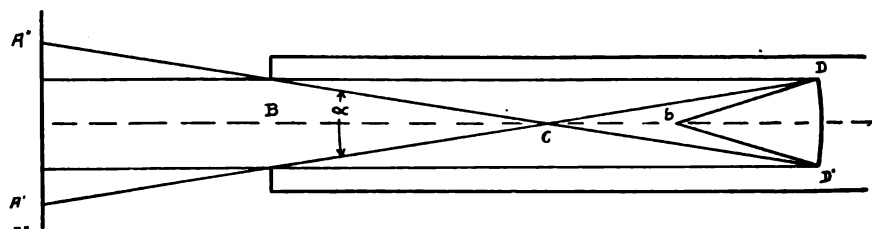

FIG. 12.—MIRROR TYPE OF FIXED-FOCUS RADIATION PYROMETER.

*Fery Radiation Pyrometer*

Fig. 13 is a cross-section of the Fery pyrometer, made by the Taylor Instrument Companies. Radiation from the source sighted upon is concentrated by the concave mirror of speculum metal or gold, upon the hot junction of a minute thermocouple. Unlike other types of radiation

pyrometer, this instrument requires focusing for each sighting distance, this being accomplished by an ingenious device due to Fery. Two semicircular mirrors (*a*), Fig. 14, inclined to one another at an angle of

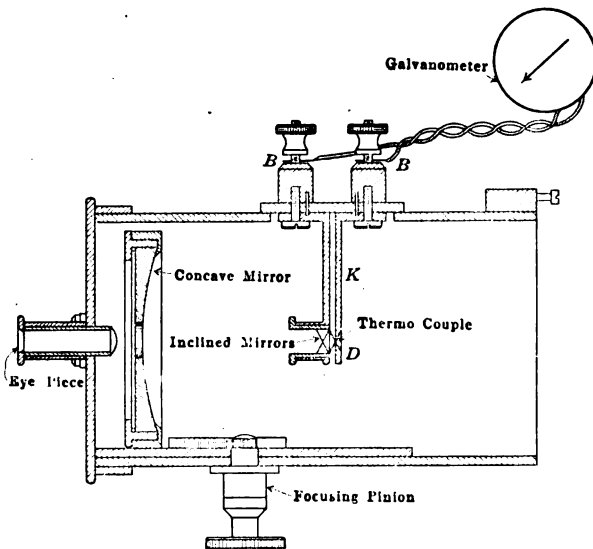

FIG. 13.—FERY RADIATION PYROMETER.

$5^\circ$  to  $10^\circ$ , are mounted in the thermocouple box, an opening of about 1.5 mm. at the center of the mirrors forming the limiting diaphragm immediately in front of the couple. The observer views, by means of the telescope *D*, the image of the furnace formed by the large concave mirror *MM'*

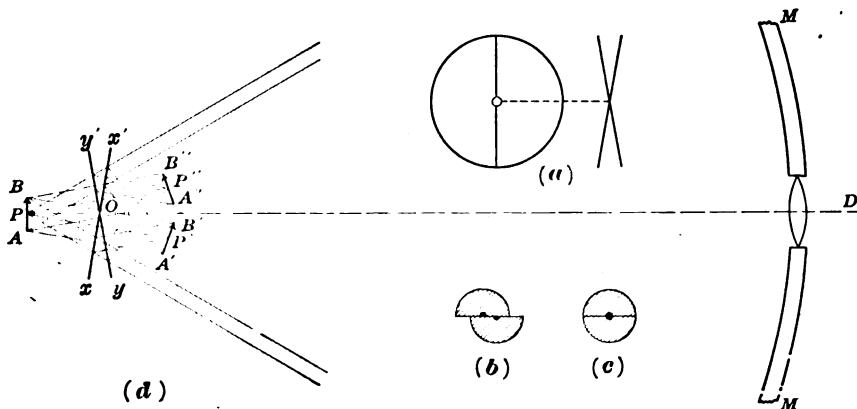

FIG. 14.—OPTICAL SYSTEM OF FERY RADIATION PYROMETER.

and reflected by the inclined mirrors *xx'* and *yy'* through a hole in the large mirror. If the image is not correctly focused at *O*, the intersection of the two small mirrors, the image appears broken in half, as shown by

(b). Correct focus is obtained when the two halves of the image are in alignment (c). This breaking of a line is illustrated on a magnified and distorted scale by (d). Suppose that the pyrometer were incorrectly focused upon a line source, say an arrow, the image falling at position  $AB$  instead of at  $O$ . The image of the arrow reflected from the mirror  $yy'$  lies at  $A''B''$  and that reflected from the mirror  $xx'$  at  $A'B'$ , and to the observer at  $D$  the projections of these images appear as two distinct arrows. As the pyrometer is brought into the correct focus by turning the pinion screw and moving the large concave mirror in the direction

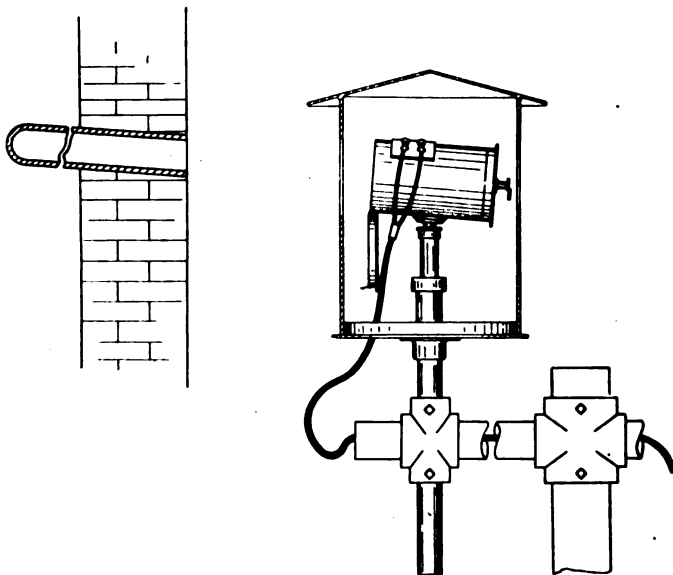

FIG. 15.—FERY RADIATION PYROMETER IN WEATHER HOOD, SIGHTED INTO A FIRE-CLAY TUBE.

$OD$ , the points  $P'$  and  $P''$  of the reflected images move along the lines  $P'O$  and  $P''O$ , coinciding at  $O$ , when the correct focus is obtained.

For the measurement of very high temperatures, usually above  $1500^{\circ}$  C., the cover to the front of the telescope is provided with a sectored opening which may be adjusted to reduce the radiation falling upon the receiver by any definite amount, and in this manner the upper temperature limit of the instrument may be greatly extended. This adjustment is made by the manufacturer and should not be altered; for the lower scale range the cover is open, as shown in Fig. 15.

The readings with a Fery pyrometer, when properly focused, and neglecting secondary errors discussed later, are independent of the sighting distance, as is the case with the fixed-focus radiation pyrometer.<sup>3</sup>

<sup>3</sup> For the geometrical demonstration of this fact, see U. S. Bureau of Standards *Sci. Paper* 250, 97.

The image of the source, as viewed through the small telescope, must cover *completely* the limiting diaphragm of the thermocouple. This diaphragm appears as a black circular area, shown at the center of the field on Fig. 14 (b) and (c). An excellent rule is to sight at such a distance that the area of the image overlaps this hole and extends half-way to the edge of the focusing mirrors. The Fery pyrometer requires a smaller source than the fixed-focus instruments. Table 7 indicates the size of source required for various sighting distances, in accordance with the above rule.

TABLE 7

| Sighting Distance,<br>Cm. | Diameter of Source,<br>Cm. | Sighting Distance,<br>Cm. | Diameter of Source,<br>Cm. |
|---------------------------|----------------------------|---------------------------|----------------------------|
| 70                        | 3.2                        | 200                       | 11.2                       |
| 80                        | 3.7                        | 300                       | 16.8                       |
| 100                       | 4.8                        | 500                       | 28.5                       |
| 150                       | 8.3                        |                           |                            |

*Errors to which Radiation Pyrometers are Subject*

Dust and dirt allowed to accumulate upon the concave reflecting mirror may so decrease its reflection coefficient as to develop errors amounting to 100° or even 200° C. Frequently the dust can be removed from the mirror by carefully brushing with a camel's hair brush. The mirror may be removed from the instrument and washed, but this must be done with great care to insure that the delicate thermocouple or its mounting is not disturbed. The safest practice is to take all possible precautions to prevent dust from entering the instrument. Keep the case closed, or the front diaphragm of the fixed-focus instrument plugged with a cork when not in use.

As shown above, radiation pyrometer readings are theoretically independent of the sighting distances or the size of source, provided the source is larger than the minimum size demanded by the geometry of the instrument. Actually this ideal condition is not always realized. Some stray radiation is reflected down the walls of the telescope case, which become heated and re-radiate to the couple; the same is true of the limiting diaphragms. For these reasons, a radiation pyrometer tends to read low the greater the sighting distance or the smaller the size of source. It is therefore desirable to use a radiation pyrometer as nearly as possible in the same manner from day to day, and to have it specially calibrated for such conditions. In the Fery pyrometer, both the proper size of source and the correct focusing distances are secured by following the rule previously suggested.

*Advantages and Disadvantages of Radiation Pyrometers*

For temperatures above 1400° or 1500° C., either a radiation or an optical pyrometer must be employed. The optical pyrometer is capable of higher accuracy and is less susceptible to errors than the radiation pyrometer. Smoke and dust affect the readings of both instruments, but the radiation pyrometer is seriously affected by the presence of cooler strata of carbon dioxide and other gaseous combustion products in the furnace. Carbon dioxide and water vapor absorb the heat rays, and hence the radiation pyrometer will read too low when sighted through such gases. The main advantage of the radiation pyrometer is the fact that it can be made automatically recording. The recording mechanism is the same as that employed for ordinary thermocouples. The radiation pyrometer is desirable for many processes requiring lower temperatures, where thermocouples can not be conveniently installed. It is also useful in measuring the surface temperature of large ingots.

*Black-body and Non-black-body Conditions*

Radiation pyrometers are calibrated to read correctly when sighted through upon a black body. Most furnaces approximate black-body conditions sufficiently well, but when sighting on materials in the open, certain corrections must be applied to the observed temperatures. For temperature control or reproducibility the apparent temperatures may be

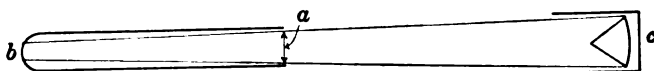

FIG. 16.—METHOD FOR DETERMINING PROPER DIAMETER OF SIGHTING TUBE.

used uncorrected if desired, since, although known to be low, they will be low by the same amount from day to day. In case the temperature of one portion of an unequally heated furnace is required, or if the furnace contains much smoke or dust, it is frequently desirable to sight the radiation pyrometer into the bottom of a fire-clay or porcelain tube, as illustrated by Fig. 15. The tube should be uniformly heated at its end for a length at least three times its diameter. The tube must also be of such diameter that the cone of rays entering the telescope is not intercepted by the front of the tube. In Fig. 16, suppose the distance from the bottom of the tube to the mirror of the Fery pyrometer is 100 cm. Referring to the above table, the required diameter of the source is 4.8 cm. Lay off the distance  $b = 4.8$  cm. and draw straight lines from the bottom of  $b$  to the bottom of the mirror  $c$ , and from the top of  $b$  to the top of the mirror. The tube must have such a diameter at its front end  $a$  that it does not cut in on the cone of rays represented by these two straight lines. This can be determined only by actually mak-

ing the above drawing to scale, or by computing; it cannot be decided by looking through the telescope of the pyrometer, since the front end of the tube would not necessarily appear even if it did cut in on the cone of rays. In the case of the fixed-focus instruments, the diameter of the tube must be such that the cone of rays represented by the diameter  $A'A''$ , Fig. 12, cuts the tube in the region which is uniformly heated.

Table 8 shows the true temperatures corresponding to the apparent temperatures observed with a radiation pyrometer when sighted upon various materials in the open. This table must not be confused with Table 2 relating to the optical pyrometer; it will be noticed that the corrections are entirely different for the two types of pyrometer.

TABLE 8.—*True Temperatures and Apparent Temperatures Measured by Radiation Pyrometers when Sighted Upon Various Materials in the Open*

| Observed Temperature, Degrees C. | True Temperature, Degrees C. |               |              |            |              |
|----------------------------------|------------------------------|---------------|--------------|------------|--------------|
|                                  | Molten Iron                  | Molten Copper | Copper Oxide | Iron Oxide | Nickel Oxide |
| 600                              | ....                         | 1130          | 720          | 630        | 710          |
| 650                              | ....                         | 1210          | 775          | ...        | 755          |
| 700                              | ....                         | 1290          | 830          | 735        | 800          |
| 750                              | ....                         | ....          | 890          | ...        | 845          |
| 800                              | 1200                         | ....          | 945          | 840        | 895          |
| 850                              | 1270                         | ....          | 1000         | ...        | 940          |
| 900                              | 1340                         | ....          | 1060         | 945        | 985          |
| 950                              | 1410                         | ....          | 1115         | ....       | 1030         |
| 1000                             | 1475                         | ....          | 1170         | 1050       | 1075         |
| 1050                             | 1550                         | ....          | ....         | ....       | 1120         |
| 1100                             | 1610                         | ....          | ....         | 1155       | 1165         |
| 1150                             | 1680                         | ....          | ....         | ....       | 1210         |
| 1200                             | 1750                         | ....          | ....         | 1260       | 1255         |

DISCUSSION

E. F. Northrup,\* Trenton, N. J.—The theory of the optical pyrometer is so simple, I am speaking now of the disappearing-filament type, and the instrument works so well in the laboratory and is, comparatively, so inexpensive that one wonders there should be any use of any kind of direct insertion pyrometers at all, because all industrial temperatures we wish to measure very accurately are high enough to give off luminous rays. In the field, however, there are a few features with which the laboratory does not have to contend.

I was visiting a copper works at Perth Amboy where the copper

\* President, Pyroelectric Instrument Co.



was run into the molds as they were carried on a belt. At one time a dozen of these molds were filled at once when I stood about 15 ft. away. When the copper ran in, its surface was very bright and I felt a certain amount of radiation on my face. In a moment, quite suddenly, an oxide film spread all over these molds at the same time, and those standing by me said they noticed a great increase in the amount of radiation striking the face, but the surface of the copper was very much duller. Now, if there had been set up at that place, directed upon this molten surface of copper, a radiation pyrometer and an optical pyrometer, before the oxide film had formed, the radiation pyrometer would have indicated a lower temperature than the optical pyrometer. Immediately after the film had formed, the reverse would have been true. In foundries and in glass works, physical conditions limit the general usefulness of the optical pyrometer in many cases, for which reason the direct-insertion pyrometers are used in large numbers.

Doctor Foote did not mention the fact that the radiation pyrometer, which generates an e.m.f. in a thermocouple, can be made with suitable contrivances for recording the results. An optical pyrometer, where the filament of a lamp is matched in brightness against the brightness of the background, affects only the human eye and there is no apparent means of making the optical pyrometer record.

THE CHAIRMAN (G. K. BURGESS, Washington, D. C.)—Both the radiation and the optical pyrometer will have higher readings when sighted on the copper oxide at the same temperature as the liquid copper.

E. F. NORTHRUP.—You mean it will look brighter to the optical pyrometer after the film has formed?

CHAIRMAN BURGESS.—Yes.

E. F. NORTHRUP.—It does not look brighter to the eye.

A. G. WORTHING, Nela Park, Cleveland, O.—Doctor Foote spoke of the optical pyrometer as being a photometer. In the laboratory, at least, there are dangers that may occur on the assumption that that is true. With a photometer, a person naturally moves the sight box along the bars until he has two illuminations that appear to be equal; in other words, he equates the illuminations. In the case of the disappearing-filament pyrometer, that is not quite true. Apparently the pyrometer filament is as bright as the background filament, but the equality is not necessarily real. Doctor Forsythe and I found, in some cases, by small variations of angular aperture, that for an apparent match we could have the pyrometer filament as much as 1.6 times as bright as the background it was sighted upon, that is, 1.6 times as bright after we had made corrections for the glassware in between. In other cases it might be only nine-tenths as bright as the background. If a person uses the pyrometer

in the right way, there is no trouble, but there have been applications of this pyrometer in the past in which that method has not been employed and erroneous results have been obtained. Such troubles, of course, are not likely to appear in the industrial world; they are more likely to appear in the laboratory.

P. D. FOOTE.—It is true that the brightness of the filament of the pyrometer lamp may be different from that of the background when the condition of a match is obtained. It is, however, correct to call the optical pyrometer a photometer since, in use, the brightness of the source sighted upon is compared to the brightness of the black body used in the calibration of the pyrometer, the lamp serving merely as a transferring device.

F. A. HARVEY, Syracuse, N. Y.—In focusing the optical pyrometer, it is necessary to focus both the eyepiece and the objective. The usual method is to focus the eyes on infinity and adjust the eyepiece until the filament is sharply defined and then the objective. In the types with which I am familiar the pyrometer must be removed from the eye while the eyepiece is focused, by screwing it in or out. This makes the process of focusing very tedious and difficult.

Dr. Foote spoke of the unreliability of a platinum couple for high temperatures. When a controversy arises over specifications on firebrick, if you bought firebricks under certain temperature specifications, the first thing the firebrick manufacturer questions is your temperature. If that is measured by an optical pyrometer, it is necessary to know the skill and honesty of the one who made the test. But with a recording pyrometer, it is possible to show the records, which may also show a calibration of the couple. He will seldom question these. We find the optical pyrometer exceedingly useful as a check up but not as an operating instrument.

## Industrial Applications of Disappearing-filament Optical Pyrometer

BY F. E. BASH,\* CH. E., PHILADELPHIA, PA.

(Chicago Meeting, September, 1919)

A GREAT many industrial operations require the application of heat to carry on or complete processes, in which cases the temperatures must often be controlled within very narrow limits. For the lower temperatures, this control is not, as a rule, difficult as a number of types of reliable pyrometers are available for the work; for example, the mercury and resistance thermometers and the thermocouple. For temperatures above a red heat, thermocouples, platinum resistance thermometers, and total radiation and optical pyrometers may be used, depending on conditions.

It is often undesirable, and sometimes impossible, to take temperatures of material by immersing the pyrometer in it or by placing the temperature-measuring device in a position in which it will attain the temperature of the material. The pyrometer may contaminate the product; the temperature may be so high that the pyrometer will not hold its calibration, due to ineffectual protection and consequent contamination; the object may be inaccessible, as a lamp filament, etc. In such cases, a total radiation or optical pyrometer must be used.

The disappearing-filament, or Morse, type of optical pyrometer works on the following principle: An objective lens, Fig. 1, focuses the image of the object whose temperature is desired in the plane of the lamp filament at  $F$ , which is at the principal focus of the ocular lens shown in the eyepiece. By this arrangement the eye will not have to accommodate itself first to the lamp filament and then to the object at a distance, and the lamp filament will appear superposed on the object. To balance the instrument, the current is adjusted by means of a rheostat until the tip of the lamp filament just disappears against the object as a background. Figs. 2, 3, and 4 show the appearance of the filament when too cold, too bright, and just balanced.

To find the temperature of the incandescent body, the current through the lamp is read from the ammeter and reference made to a calibration sheet on which are tabulated values of temperature corresponding to different currents.

The calibration of an optical pyrometer is for "black-body" temperatures. A black body is a perfect radiator, or a body that absorbs all radiation which falls upon it, reflects none, and transmits none away.

---

\* Research Engineer, Leeds & Northrup Co.

Any material that is not a black-body radiator gives off less radiation than a perfect radiator and, if it is incandescent, appears colder and less bright than a black body at the same temperature. For this reason corrections have to be made to optical pyrometer readings on selectively radiating bodies that depend on their "emissivity," or the amount of light they emit. If the emissivity is known, the following formula de-

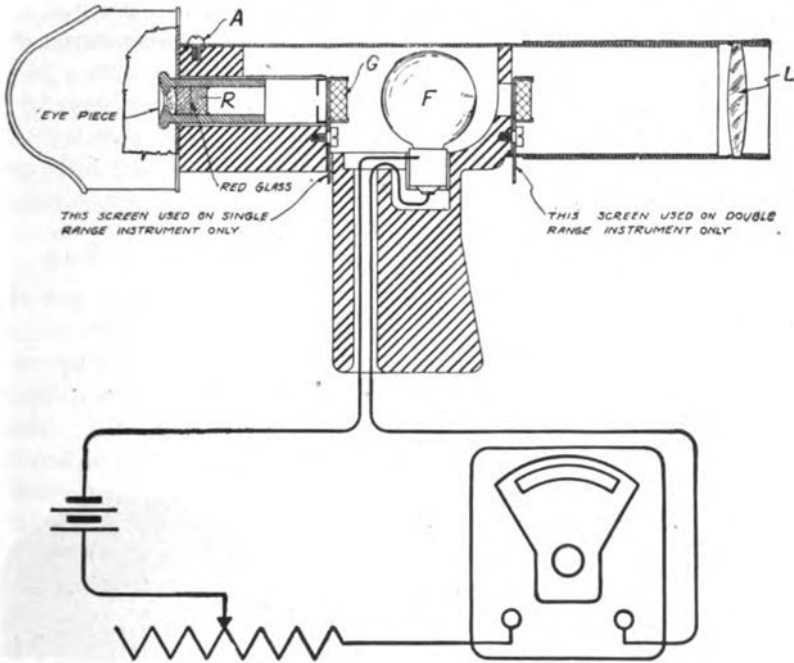

FIG. 1.

rived from Wien's Law may be used to find the relation between apparent temperature and true temperature.

$$\text{Log } E = \frac{c_2 \log \epsilon \left( \frac{1}{T_2} - \frac{1}{T_1} \right)}$$

- In which  $E$  = emissivity;
- $\lambda$  = wave length of light used;
- $C_2 = 14,500$ ; •
- $\epsilon$  = base of Napierien logarithms;
- $T_1$  = apparent temperature of body;
- $T_2$  = true temperature of body.

If the emissivity is not known, it can be found by this relation, if the true and apparent temperatures are determined, by various methods that have been discussed in publications of the Bureau of Standards<sup>1</sup> and elsewhere.

<sup>1</sup> Burgess and Waltenberg: U. S. Bureau of Standards *Sci. Paper* 242.

Black-body conditions are closely approximated in furnaces and uniformly heated enclosures and by a number of commonly used materials, so that small errors, if any, are encountered for the majority of industrial conditions. However, for molten metals and material with reflecting surfaces, certain corrections must be made or black-body conditions secured by some means or other if the true temperature is desired. Often all that is required is to be able to repeat a certain temperature under the same conditions. In such cases, the "apparent" temperature suffices

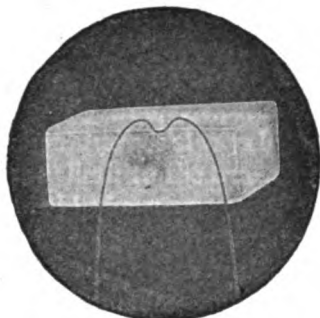

FIG. 2.—FILAMENT WHEN TOO COLD.

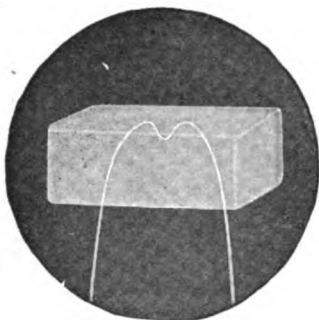

FIG. 3.—FILAMENT WHEN TOO BRIGHT.

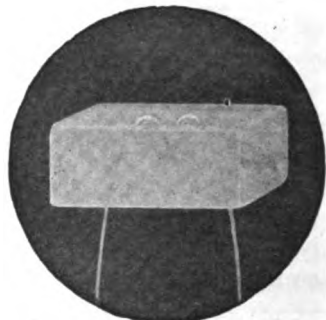

FIG. 4.—FILAMENT WHEN JUST BALANCED.

without its being necessary to determine the true temperature. It is generally desirable, however, to know the true temperature in order to be able to compare with other operations.

One precaution that must be observed in making optical pyrometer readings is that the instrument must not be sighted through any considerable amount of smoke or flame, particularly smoke. Flame increases the reading but is not generally serious for light flames; smoke decreases the reading. Smoke absorbs the light from the object and has a large effect on the readings. It is generally possible, however, to

sight under the smoke and flame or to get rid of them while the reading is being made.

To secure black-body conditions, a number of methods may be used. If the material is not reflecting and is in a uniformly heated furnace, the pyrometer may be sighted directly on it and true temperatures will be read. If the material has cracks or holes in it, true temperatures will be obtained by sighting into them as the radiation from them closely approximates that of a perfect radiator. If the temperature of a gas is desired, a closed-end tube may be placed so that the gas will heat the end and its temperature can be ascertained by sighting down the tube at the end. Another method is to hang a metal target in the gas and sight on that. The temperature of molten metal can also be taken by pushing a closed-end tube into it.

#### APPLICATION OF OPTICAL PYROMETER TO STEEL INDUSTRY

It has been determined that oxide of iron is approximately a black body and that the difference between true and apparent temperatures for an optical pyrometer using red light is only a few degrees, so that no correction is made when sighting on an iron billet either in a furnace or outside. This is a fortunate circumstance as no precautions need be observed to procure black-body conditions. The main difficulty is that the scale on an iron billet is generally loose and does not adhere closely to the piece. This means that the scale will be much colder than the billet, but if a little judgment is used when readings are made and the observations are made on the bright spots or the loose scale is knocked off where it is desired to read, no difficulty will be encountered from this source. If a piece has an angle or hole or crack in it, the reading can be made at those points.

One of the advantages of the disappearing-filament type optical pyrometer is that the object can actually be seen through the telescope and it is an easy matter to select any portion or particular spot, no matter how small, and balance on that. This is particularly desirable in the case of hot steel that is being worked. It has a mottled appearance due to the loose scale on it so that any instrument which has to focus on a comparatively large field will give a temperature that depends on the average brightness of that portion of the billet.

*Molten Steel and Slag.*—In the case of molten steel or slag, we have conditions that are not black-body and corrections must be made to optical pyrometer readings. In the open-hearth furnace, according to Burgess, temperatures can be taken of the walls and roof and slag surface without making any correction for emissivity.<sup>2</sup> It is questionable, however, how close the temperature of the slag surface is to the

---

<sup>2</sup> Temperature Measurements in Bessemer and Open-hearth Practice. U. S. Bureau of Standards *Tech. Paper* 91.

steel temperature; as a matter of fact, quite large differences are often noted when tapping. Sometimes the steel is hotter and sometimes colder than the slag, depending on furnace conditions.

Tapping temperatures can be taken very readily by sighting on the steel or slag stream and applying the corrections as worked out by Burgess. These corrections are for an emissivity of 0.40 for steel and an average emissivity of 0.65 for slag. Curves showing the relation between true and apparent temperatures for steel and slag are shown in

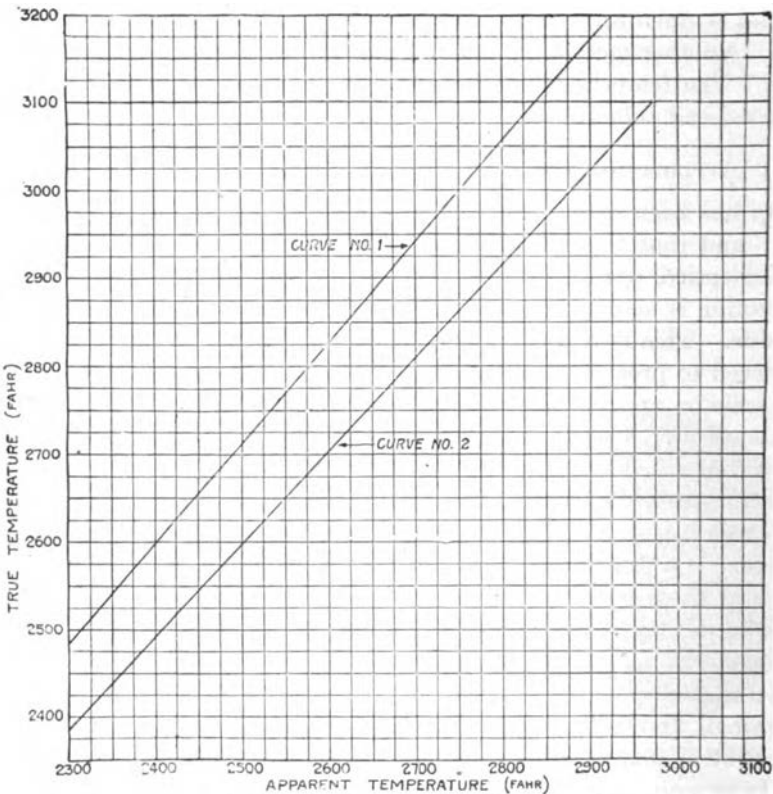

FIG. 5.—EMISSIVITY CORRECTIONS FOR STEEL AND SLAG.  
Curve 1—Steel. Curve 2—Slag.

Fig. 5. When taking tapping temperatures, the observer should stand on the windward side of the stream, if possible, and thus avoid smoke. Readings can be made on the slag or steel stream with ease and, when corrected, very consistent results will be noted.

Teeming temperatures can also be taken very readily by sighting on the metal stream from the ladle and thus obtaining the temperature at which each ingot is teemed. The temperature of the metal rising in

bottom-poured molds can also be taken if there is no smoke to interfere.

Stream temperatures of molten cast iron and pig iron have also been taken successfully, the emissivity of 0.40 being used, although this value has not been satisfactorily checked. It serves, however, to get comparable results and is probably very close to the actual emissivity.

To take temperatures in the blast furnace is a difficult, although not impossible, matter if the proper precautions are taken. If the tuyere glass is first calibrated for its absorption effect on the optical reading, observations may be made and very interesting and instructive data can be obtained.

*Forging.*—Temperatures in forging furnaces can be taken with the disappearing-filament type optical pyrometer and can be used to good advantage in determining when an ingot is sufficiently hot to forge. To make sure that the temperature taken on a billet of steel in a forging furnace is not too high, due to loose scale becoming hotter than the piece, it is sometimes well to run a bar into the furnace and clean the surface at the point where the reading is made.

Forging temperatures are a more or less uncertain matter due to the cooling of the outside surface and loose scale. Readings can be made, however, as the scale falls off after the first blows of the hammer. If the temperature gradient through the piece is known approximately, the optical reading on the surface will serve as an indication of the temperature of the piece. The rule to follow is always to pick the brightest spot and a place free from loose scale. With a little practice and judgment, much useful information can be obtained.

*Rolling.*—It is often very desirable to know the finishing temperatures of rolling operations; they may be easily obtained with the disappearing-filament optical pyrometer. If small stock is being rolled, temperatures may be determined accurately after the first pass, as all loose scale has dropped off and the iron oxide is tightly packed and is, therefore, at the temperature of the steel. The pyrometer operator can judge if the conditions are favorable for temperature measurements by noting if there are black spots on the piece, these being indications of loose scale.

In the case of material of greater cross-section than 2 in. or thereabouts, it generally takes more than one pass to free it of scale. This depends a great deal on conditions, however, and each case can readily be settled by bearing in mind to sight on the bright spots. This particularly applies to rolling sheets where the scale lies loosely on the surface. In this case the temperature reading can be made very readily just after a pass while it is momentarily stationary before reversing.

To make quick readings, it has been found advantageous to set the current through the lamp at a value corresponding to the approximate temperature of the piece so that a slight adjustment will serve to make a balance. If this is done, temperatures of small rolling stock can be



taken in a couple of seconds and it will not be necessary to halt the operation to make the reading.

*Heat Treating.*—Temperatures of steel in heat-treating or annealing furnaces can be taken accurately by the use of the optical pyrometer, which has the added advantage of being able to take temperatures of any piece in the furnace or any section of a particular piece, whereas a thermocouple may give the gas temperature, which may not bear any relation to the piece being treated.

#### USE OF OPTICAL PYROMETERS IN THE GLASS INDUSTRY

The optical pyrometer may be used in determining the temperature of molten glass under various conditions but proper precautions must be taken in each case to avoid incorrect results. The errors arise from a lack of black-body conditions and may be avoided in all cases by using a closed-end sight tube. This, however, is not always necessary and a number of experiments have been made to determine the practicability of a sight tube and other methods by which glass temperatures could be most readily taken under practical working conditions. To this end, observations of glass temperatures were made in various factories on different types of furnaces. Until experience indicated no further need, results were checked by using a thermocouple as well as the optical pyrometer. The thermocouple was finally discarded, as it was possible to secure the same results with greater ease by producing black-body conditions. The employment of thermocouples in practical work is somewhat difficult for a number of reasons. If a silica or porcelain protecting tube is used, it will withstand the effects of the glass long enough to get a few checks but the couple is rendered useless for practical routine tests because the tubes soon crack due to the contraction of the cooling glass, which adheres to them. If a noble-metal couple is immersed bare in the glass, it becomes contaminated and brittle so that incorrect results are obtained as a consequence.

Iron or nichrome protecting tubes were not used for fear that the batch of glass might become colored by material being dissolved from them. They can be used occasionally in window glass, as iron tools are used continually for stirring and skimming. This would probably be objectionable with plate or optical glass, in which cases, however, clay tubes could be and have been used successfully.

After a number of checks between a thermocouple immersed in the glass and an optical pyrometer reading on the bottom of a closed-end tube beside the thermocouple, in which the two checked each other within 10° F., it was decided that there was no further necessity of using a thermocouple for checking as the tube was much simpler and the extra apparatus could be dispensed with.

In most cases, errors due to reflection will arise when sighting on

the surface of molten glass. In one tank furnace, a difference of 117° F. in apparent temperature was found by sighting on the same spot from different angles, due to reflection from flames and walls. These reflections are entirely done away with when a black-body tube is used.

The best way to determine the proper method of taking temperatures in a glass furnace is to immerse a tube in the glass and, when it has come to temperature, select a point free from reflections, if there is any, and compare the readings. A sight in the shadow of a clay floater that lay close to the wall in a large tank furnace was found to agree with the optical reading in a tube to 18 °F. A similar test in a pot furnace, where the optical reading was made on the angle of intersection of the black wall of the pot with the glass surface, gave a check of 5° F.

It appears probable, although it has not been conclusively proved, that the radiation from an uncovered pot or kiln of glass that has no hotter bodies surrounding it is that of black body for a wave length of approximately 0.65 microns. The evidence to support this is that readings made with the optical pyrometer of the disappearing-filament type on the center of a window-glass kiln checked a thermocouple immersed in the glass to 3° F. The optical-pyrometer readings were made almost from a vertical position from an operating tower and also from an angle of about 60° with the glass surface and both seemed to agree equally well with the thermocouple. It would be well to check up each individual case with a black-body tube or thermocouple, however, as conditions vary from one plant to another.

In each case it is usually possible to find a point, the optical reading on which will give the true temperature. This can be determined by experiment in each case. In a large tank furnace of the reverberatory, regenerative type, for example, the surface of the "metal" will give very discordant results unless care is taken to avoid reflection from the gas flame. In this case, however, by sighting in the shadow on the vertical face of a floater, the true temperature will be secured, providing there are no surfaces of large extent illuminating that face. In any case, it is possible to check the accuracy of such measurements and their constancy by temporarily employing a black-body tube of iron or clay. In a pot furnace where the pots are open and in tank furnaces, care must be taken in selecting a sighting point because of the strong reflections. In a furnace where there are flames playing or the walls are hotter than the glass sighted on, the optical reading will always be high due to reflections unless a place can be found that is protected from such reflections.

A method that has proved satisfactory for taking tank temperatures is to drill diagonal holes through the walls just above the glass surface and to insert through them closed-end clay tubes that project into the glass and remain there permanently. In this manner, it is possible to keep a

check on the glass temperatures around the tank and also control them to the desired value. The use of the optical pyrometer has the added advantage, in this case, that when the clay tubes break no damage results, as would be the case if platinum couples were used.

When determining temperatures in a pot furnace where the individual pots have closed tops, it will doubtless prove correct to take the temperature as that optically observed on the pot wall near the glass, owing to the fact that in the angle practically black-body conditions prevail. In any case, it is well to remember that the material of the pot and its top, while they may be such as to give black-body radiation, will not necessarily do so when covered with a surface of molten glass.

In plate-glass pot furnaces, it was found that readings made on the intersection of the glass surface and the pot wall gave the true glass temperature; but readings on the glass surface in the center of the pot were too high due to flames playing over them.

When the purpose of the measurement is to insure repetition of working conditions, the actual temperature may not be necessary and, therefore, a single point may be chosen for observation from day to day without regard to the real temperature. It is recommended, however, that true temperatures be found in every case and recorded as the actual operating condition. The value of so doing is evident, for it makes data of value in comparison with other observations and other conditions. Furthermore, any new furnaces that are to be installed may differ in their natures from older ones. In such a case true temperatures would be necessary for comparison.

A black-body tube of clay may be used if care is taken to heat it gradually before plunging it into the molten glass. An ordinary gas pipe also makes a very satisfactory black body, but should be well burned out to remove oil and grease from the interior before being used. The presence of any smoke within the pipe will, by reason of its absorption, give false readings. A 2-in. (5-cm.) gas or water pipe capped at the far end has been found very satisfactory as a black body. Such a pipe has been used successfully up to a length of 10 or 12 ft. (3 or 3.6 m.) in furnace gases.

The accuracy of measurement with the disappearing-filament optical pyrometer depends somewhat, but not greatly, on the skill of the observer. Even those using the instrument for the first time will find that they can check each other to within 5 to 10° F., depending on the care they may exercise in balancing.

#### OPTICAL PYROMETERS IN THE NON-FERROUS FOUNDRY

Many alloys of widely varying composition are made in the non-ferrous foundry at the present time and for many of them the tempera-

ture at which the metal is poured is a vital factor, as the mechanical properties of an alloy often depend largely on the casting temperature. The writer ventures to state that a great many rejections would never occur if the foundry pouring temperatures were carefully controlled. In many foundries, as soon as a pot of metal is pulled from the furnace and skimmed, the molder is anxious to pour immediately for fear of its getting too cold, even though it may be a great deal hotter than necessary. Temperatures of a brass alloy from a number of different pots, all for the same kind of castings, varied in temperature from 1937° to 2337° F. (1058° to 1281° C.).

The taking of temperatures of non-ferrous alloys may be done in a number of ways. A protected base-metal thermocouple may be used for the lower melting alloys and platinum thermocouples for the higher melting alloys. There are a number of disadvantages, however, in their use. If a metal protecting tube is used, it will be attacked by the molten metal and finally spoil the couple. Another disadvantage is that the metal of the protecting tube goes into solution in the alloy, which in many cases is very undesirable. Protecting tubes of different ceramic materials may be used but, as they are somewhat fragile, the couple is soon contaminated, which in the case of platinum thermocouples is somewhat expensive.

The difficulty in using an optical pyrometer on non-ferrous alloys is that practically all of them contain copper and oxidize readily. As a result, when a molten metal surface is exposed, it immediately oxidizes; and the longer it is exposed, the thicker the coat of oxide becomes, so that the reading of the optical varies greatly, depending on the instant at which the balance was made. To remedy this difficulty, a number of experiments were tried with closed-end, quartz, sight tubes immersed in the metal and the readings were checked against a protected platinum-rhodium thermocouple. The ends of the quartz tubes were immersed to the same depth as the thermocouple, which was enclosed in a silica protecting tube. The following readings were obtained on nickel-silver from different pots.

| No. | THERMOCOUPLE<br>TEMPERATURE,<br>DEGREES F. | OPTICAL PYROMETER<br>TEMPERATURE,<br>DEGREES F. | DIFFERENCE,<br>DEGREES F. |
|-----|--|---|---------------------------|
| 1   | 2165                                       | 2161  | 4                         |
| 2   | 2170                                       | 2170  | 0                         |
| 3   | 2207                                       | 2200  | 7                         |
| 4   | 2193                                       | 2193  | 0                         |
| 5   | 2112                                       | 2115  | 3                         |
| 6   | 2142                                       | 2147  | 5                         |
| 7   | 2211                                       | 2210  | 1                         |
| 8   | 2211                                       | 2213  | 2                         |
| 9   | 2226                                       | 2227  | 1                         |

The thermocouple was read with a potentiometer indicator with automatic cold-junction compensation.

Similar tests were made on manganese-bronze, yellow brass, and other alloys of which the following readings are representative.

| No. | THERMOCOUPLE TEMPERATURE, DEGREES F. | OPTICAL PYROMETER TEMPERATURE, DEGREES F. | DIFFERENCE, DEGREES F. |
|-----|--------------------------------------|---|------------------------|
| 1   | 1698                                 | 1699                                      | 1                      |
| 2   | 1836                                 | 1830                                      | 6                      |
| 3   | 1800                                 | 1805                                      | 5                      |
| 4   | 2067                                 | 2070                                      | 3                      |

From the above results, it was concluded that no errors would result from using a sight tube in taking these molten metal temperatures so the device shown in Fig. 6 was designed. The optical pyrometer *A* is clamped on one end of a light steel tube *B* and the sight tube *C* on the other in such a manner that the pyrometer is always sighted on the bottom of the sight tube. To make a temperature observation, the quartz sight tube is

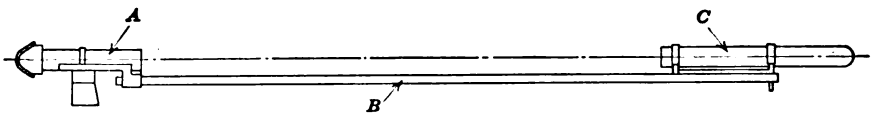

FIG. 6.—OPTICAL PYROMETER WITH SIGHT TUBE ATTACHED.

plunged directly into the metal and after a period of approximately 45 sec., while the tube is coming to temperature, a balance is made and the tube withdrawn. In this manner the temperature of metal in a pot may be taken before it is withdrawn from the furnace, the tube being pushed down through the charcoal on the surface, and the final temperature may thus be controlled at will.

It was attempted to determine the approximate emissivity of some alloys by taking a reading in the tube just after a pot was skimmed and immediately sighting on the oxidized surface of the metal and determining the emissivity from the two readings, using the formula previously given. The emissivity values obtained would only be approximate as the reading in the tube would give the temperature of the metal about 6 in. below the surface and not the true surface temperature. However, they would give the desired relation between surface and true temperature of metal. In Table 1 are given a few readings taken in this manner. The first column gives the true temperature  $T$ , the second the apparent temperature  $S$ , the third the calculated emissivity  $E$ , the fourth gives the temperature  $T_1$  calculated from the apparent temperature and the mean emissivity found. This would be the calculated temperature if no tube were used and a correction for a mean emissivity of 0.69 is made to readings on the surface of the oxidized metal. The fifth column gives

the errors that would result in using this value instead of actually measuring the true temperature with the aid of a sight tube.

TABLE 1.—*Pyrometer Readings Taken to Determine Emissivity of Non-ferrous Alloy*

| Metal                  | Tube Temperature, Degrees F.<br><i>T</i> | Appar-ent Temperature, Degrees F.<br><i>S</i> | Calcu-lated Emis-sivity<br><i>E</i> | Calcu-lated Temperature, Degrees F.<br><i>T<sub>1</sub></i> | Differ-ence in Temperature, Degrees F.<br><i>T - T<sub>1</sub></i> | Remarks  |
|------------------------|--|---|-------------------------------------|---|--|--|
| 1. No. 1 composition.  | 2147                                     | 2110  | 0.80                                | 2170  | -23  | Mean emissivity for Nos. 1 and 2 composition is 0.69. Both metals have practically same composition. No. 2 is more im-pure and all virgin metal is in No. 1. |
| 2. No. 1 composition.  | 1978                                     | 1928  | 0.71                                | 1980  | -2   |  |
| 3. No. 1 composition.  | 1934                                     | 1934  |                                     |   |  |  |
| 4. No. 1 composition.  | 1945                                     | 1928  | (?)                                 |   |  |  |
| 5. No. 2 composition.  | 2258                                     | 2184  | 0.66                                | 2247  | +11  |  |
| 6. No. 2 composition.  | 2337                                     | 2206  |                                     |   |  |  |
| 7. No. 2 composition.  | 2170                                     | 2117  | 0.73                                | 2178  | -8   |  |
| 8. No. 2 composition.  | 2275                                     | 2217  | 0.73                                | 2283  | -8   |  |
| 9. No. 2 composition.  | 2170                                     | 2110  | 0.71                                | 2173  | -3   |  |
| 10. No. 2 composition. | 2183                                     | 2102  | 0.63                                | 2160  | +23  |  |
| 11. Monel.....         | 2364                                     | 2263  | 0.59                                |   |  |  |
| 12. Gun metal.....     | 2247                                     | 2165  | 0.63                                | 2226  | +21  |  |
| 13. Gun metal.....     | 2254                                     | 2173  | 0.64                                | 2234  | +20  |  |
| 14. Gun metal.....     | 2185                                     | 2147  | 0.80                                | 2209  | -26  |  |

\*This column shows the error in calculated temperature due to using mean emissivity.

It will be seen that an error of + or -25° F. may result from using a mean emissivity value and taking the temperature by sighting on the surface of the skimmed metal. It is questionable, however, if this would ever prove to be a satisfactory method of taking temperatures as there are bright and dark spots on the surface of the metal in the pots and various readings may be obtained. In this tabulation the brightest spot was always chosen to sight upon. In the case of brasses, the zinc fumes make it very questionable what the reading would be and it was not attempted to make any observations for them other than in the sight tube.

After making temperature measurements on a number of different alloys in three different foundries under variable conditions, it was concluded that the use of the optical pyrometer in a foundry for determining the temperatures of brasses, bronzes, nickel-silver, monel, and special alloys of various kinds is entirely feasible and satisfactory if a sight tube is used; or if certain precautions are observed and no great accuracy required, the optical pyrometer may be used without a sight tube by sighting on the surface of the skimmed metal and applying a predetermined

correction. The optical pyrometer with sight-tube attachment is particularly useful in determining metal temperatures in the furnace previous to pulling the pot and pouring the metal. In this manner great uniformity of pouring temperatures may be obtained. It was shown conclusively that a silica tube immersed in a metal has black-body characteristics as borne out by the excellent checks against a carefully calibrated thermocouple.

The time required to make a temperature observation is short and the use of a quartz sight tube allows it to be plunged cold into the metal without breaking, which is a big advantage. If the tube breaks it is easily and quickly replaced and the instrument is not injured in any way, as a thermocouple would be.

### COPPER, NICKEL, SILVER, AND GOLD TEMPERATURES

Temperature observations were made on streams of copper from refining furnaces with the optical pyrometer and the emissivity determined by finding the true temperature both with a thermocouple and a sight-tube attachment to the optical. The values obtained agreed very well with that determined by Burgess, which was 0.17. Readings made on the oxidized surface of a freezing ingot of pure copper and corrected for the emissivity of copper oxide, as determined by Burgess,<sup>3</sup> gave the following results:

| APPARENT TEMPERATURE,<br>DEGREES F. | TRUE TEMPERATURE,<br>DEGREES F. |
|-------------------------------------|---------------------------------|
| 1915                                | 1983                            |
| 1920                                | 1990                            |
| -----                               | -----                           |
| Mean.....1917.5                     | 1986.5                          |

When considering that the melting point of copper is given as 1985° F., this is a very good agreement and shows Burgess' value for emissivity to be correct for these conditions.

No readings were made on nickel but a number were taken on streams of approximately 55-45 cupro-nickel with very good results. The emissivity was not determined but, from observations in the furnace and on the stream, the value of 0.285 was chosen. This may be considerably in error, but served for comparative values.

A number of observations were made on both fine and sterling-silver streams, but there is great difficulty in determining the proper emissivity value to use as silver is so a good a reflector. The reflection of windows and lights can easily be seen in a stream of silver, so that the optical reading may easily be in error if great care is not taken. Sterling silver has a greater tendency to oxidize, due to the presence of copper, so that

<sup>3</sup> U. S. Bureau of Standards *Bull.* 6.

care must be taken in choosing the place where the sight is made. For these reasons it was decided not to be practicable, as an every-day operation, to take silver temperatures by sighting on the stream. The method of the optical sight tube, however, was found to be entirely satisfactory. Silver is usually melted in tilting furnaces or small open hearths so that it is not difficult to insert the tube into the molten metal and take a reading while refining or just before casting and the temperature controlled as desired.

In the determination of gold temperatures, approximately the same problems are met with as with silver except that the gold temperatures are higher. The sight-tube method can be used as with silver with success.

#### CEMENT TEMPERATURES

Clinker temperatures may be taken very readily as they fall in a stream from a kiln; or if it is desired to take them part way up a revolving kiln into the end of which a flame is projected, the flame can be shut off momentarily while the reading is taken.

#### FUEL BEDS AND GAS TEMPERATURES

The temperature of the surface of beds of incandescent coal or coke may be taken with the disappearing-filament optical pyrometer, providing there is no smoke or much flame intervening. It is questionable, however, what relation there is between the surface temperature and that of the center of a large mass. It is also possible to pick out hot spots in a fuel bed and take their temperature with the optical pyrometer. This should give the clinkering temperature under the actual firing conditions and not under artificial ones.

If it is desired to take gas temperatures in flues or firing chambers, a closed-end ceramic tube can be set in the wall and readings made in it. Porcelain, alundum, clay, and carborundum have been successfully used under these conditions in taking gas temperatures of forging furnaces, marine boilers, etc., etc.

#### DETERMINING TEMPERATURES IN CERAMIC INDUSTRIES

In the ceramic industries, temperatures are often very high and a matter of great importance, but often can be taken only with a radiation or optical pyrometer. The disappearing-filament type has the advantage that the temperature of any particular object can be determined regardless of the temperature of surrounding walls or objects, providing, of course, that the object is a black body, which would generally be near enough to the case in a furnace or kiln unless the material was glazed. The uniformity of a kiln may also very readily be obtained by making observations on different points. This is often very important and may have a great effect on the quality of the product.



### MISCELLANEOUS USES OF OPTICAL PYROMETERS

For electric-furnace temperatures, particularly laboratory and experimental furnaces, the optical pyrometer can be used to great advantage in taking either the arc temperature or that of the material it heats or the walls of the furnace. Another use for this type of optical pyrometer is the checking of base-metal thermocouples. This may seem strange to many who consider that an optical pyrometer does not approach the accuracy of a thermocouple. As a matter of fact, the optical pyrometer, in the useful range of a base-metal thermocouple, has an absolute accuracy of  $+$  or  $- 15^{\circ}$  F. or better and can repeat readings to  $5^{\circ}$  F., while the thermocouple may be much further off calibration than that. The advantage of this method of checking is that a couple may be very quickly checked as it is used by sighting on the fire end and comparing the reading with that of the thermocouple indicator. As this takes only a few minutes a large number of checks can be made in the course of half a day; while if it were attempted to check the couples with another couple, at least  $\frac{1}{2}$  hr. would be consumed in each check. This time would be required for the two couples to come to equilibrium, if they were protected as most couples are; and even then, unless the furnace conditions were good, it would be difficult to tell if both couples were at the same temperature.

In concluding, the writer can say that the Morse type of disappearing-filament optical pyrometer has been found to be very useful in taking temperatures in many industries where thermocouples cannot be used or where it is not necessary to have a continuous record of temperatures. To obtain true temperatures, black-body conditions must prevail or a correction for emissivity must be made. Temperature observations taken in furnaces are generally true temperatures if the material in them is not reflecting. All molten metals must have emissivity corrections. Materials like iron oxide, graphite, and most rough materials give black-body radiation in the open.

To obtain black-body conditions, it is necessary for a black body to take the temperature of the material and sight on that or at an angle or hole in the piece that will radiate as a black body.

The use of the Morse type optical pyrometer does not require a highly skilled operator; a man can generally be trained for the works use of the instrument in a few days. The balancing of the instrument is very simple and a very short time is required to acquire speed.

## Emissive Powers and Temperatures of Non-black Bodies

BY A. G. WORTHING,\* PH. D., CLEVELAND, OHIO

(Chicago Meeting, September, 1919)

*Black Bodies.*—In the ordinary conception, a black object is an opaque object that reflects but little of the light that is incident on it. This means naturally that such an object is a good absorber of luminous radiation. The black body, which is so closely connected with high-temperature measurements, represents the limit in blackness of all black objects. It is a body that not only absorbs all visible radiations but also all other radiations in the infra-red and the ultra-violet regions of the spectrum which are incident on it. No substance is known that is completely black; platinum black, one of the nearest if not the nearest representative of the ideal, reflects 1 per cent. or so of ordinary visible radiation. The closest approach to the ideal is a small opening in the wall of a relatively large opaque cavity. Any radiation incident on this black body will be almost completely absorbed if the relative dimensions are properly chosen no matter what the material may be. The great difference between the blackness of such a cavity and of lampblack, for instance, will be apparent to one who makes the simple test.

*Non-black Bodies.*—The field of non-black bodies covers all real bodies. Their characteristics are extremely varied. So far as absorption of radiation is concerned, these bodies range practically from the almost completely black, platinum-black, and lampblack, which absorb all but a fractional part of 1 per cent. or so of the incident radiation, by an infinite variety of steps to freshly polished silver, which ordinarily absorbs only a few per cent. The exact percentage absorbed depends not only on the nature of the incident radiation, but also on the temperature of the body, the condition of its surface, the angle of incidence, the nature of the surrounding medium, and on certain other less important conditions. As consequences of these varied characteristics, we have not only the differences of color of ordinary objects, but also the changes of color that any one object undergoes on heating or when lighted from various directions. This complexity of the phenomena, in a way, is responsible for the meagerness of knowledge regarding materials at elevated temperatures.

*Measurement of High Temperatures.*—Excepting in cases where the thermocouple or the gas thermometer is applicable, in which case the

---

\* Physicist, Nela Research Laboratory.

### 368 EMISSIVE POWERS AND TEMPERATURES OF NON-BLACK BODIES

temperatures obtained are true temperatures regardless of the material studied, high temperatures are almost always, if not always, determined from measurements of radiation. In fact, determinations of temperature from this latter point of view are often so much more convenient than the thermocouple and especially the gas-thermometer determinations that, in the region where all of these types of measurements may be made, the radiation measurements are often preferred. This is true even though the temperatures usually thus directly determined are not the actual temperatures, a consequence of the sources of the radiation being non-black bodies; in other words, a consequence of being concerned with iron, or glass, or tungsten instead of small openings leading to relatively large cavities uniformly heated.

*Coördination of Experimental Results.*—In order that data on iron, glass, tungsten, or other non-black bodies obtained in one laboratory, may be correlated with similar data obtained elsewhere, temperatures must be expressed on a common scale. The true temperature scale is the natural scale for this purpose. It is ordinarily the scale to which all other temperatures can be most directly reduced. When the measurements depend on the radiation, a knowledge of emissive powers represents a means whereby such measured temperatures may be converted simply into the actual temperatures. Because of this, we herewith give consideration to the significance of emissive powers, how they are obtained, and how they are applied in the determination of the real true temperatures of non-black bodies.

#### FUNDAMENTAL CONCEPTS REGARDING EMISSIVE POWERS

*Two Classes of Emissive Powers.*—There are two classes of emissive powers that are commonly applied to temperature measurements. One of these, called the total emissive power, is based on the total heating effects due to the radiation from a non-black body source; the other, called spectral emissive power, is based on the monochromatic brightness of the source. Total emissive powers are used generally in connection with radiation pyrometry to determine true temperatures; spectral emissive powers are similarly used in connection with optical pyrometry. We shall consider these later in considerably more detail.

*Kirchhoff's Law.*—A fundamental law underlying the temperature radiations from non-black bodies was originally put forth by Kirchhoff and is universally known as Kirchhoff's law. The fundamental aspect of this law may be readily demonstrated in the home. Let one take, for instance, a piece of broken crockery with a decorative pattern, and heat it over a gas flame in a dark room. When the crockery becomes incandescent, the darker portions of the pattern will be noticeably the brighter. Those portions that were good absorbers of light show themselves, when

heated, to be good emitters. This effect is not due to a change in the characteristics of the pottery or the painted design, for if the pottery when hot is illuminated relatively strongly by means of some other light, the different parts of the pattern will appear in their natural colors.

Kirchhoff's law, which is directly applicable here, states that the rate of emission of radiant energy (the radiant flux) by a non-black body divided by its absorption factor (the ratio of the radiation absorbed by the body to the incident radiation—strictly speaking, this radiation should be like that from a black body at the same temperature) is equal to the rate of emission of radiant energy (the radiant flux) by a black body of the same size and temperature. Thus using concrete values, it would appear, from the work of Thwing<sup>1</sup> on cast iron and of others on black-body radiation, that cast iron at 1600° K. (1327° C.) radiates energy at a rate of 10.8 watts per sq cm., that it absorbs at this temperature about 29 per cent. of the radiation from a black body at the same temperature that is incident on it, and that in agreement with this a black body at 1600° K. radiates energy at a rate of  $\frac{10.8 \text{ watts}}{0.29 \text{ cm.}^2}$  or  $37.3 \frac{\text{watts}}{\text{cm.}^2}$ .

The reasoning underlying this law is simple. Suppose a non-black body and a black body are placed in an opaque enclosure possessing a uniform temperature. According to experience these two bodies would, in time, come to the same temperature. Moreover, according to the common conception, these two bodies will function as ordinarily; in other words, they will radiate energy, absorb radiant energy, and reflect radiant energy. In order that these two bodies shall finally maintain a steady common temperature, they must radiate energy at the same rate that they absorb it. The black body will absorb all of the radiation falling on it and must radiate at that same rate. The non-black body will absorb only a certain part of the radiation falling on it (29 per cent. if cast iron at a temperature of 1600° K.), and must therefore radiate energy at a lower rate given by that same percentage of the black-body rate—a give-and-take policy of the fairest kind. Kirchhoff's law, the generalization resulting from this reasoning, as already given, states that the rate of radiation of energy by a non-black body divided by its absorption factor is equal to the rate of radiation of energy by a black body of the same surface area at the same temperature, a statement that might pithily be replaced by "As a body absorbs, so does it radiate." One of the most striking facts expressed by this law is that all non-black bodies radiate energy at lower rates per unit of area than do black bodies at the same temperature. The same reasoning may be applied to radia-

<sup>1</sup> *Phys. Rev.* (1908) 26, 190.

370 EMISSIVE POWERS AND TEMPERATURES OF NON-BLACK BODIES

tion of any particular wave-length of radiation, with exactly similar results.

The relation just developed may be put in mathematical form, thus

$$\frac{E_n}{a_t} = E \tag{1}$$

where  $E_n$  and  $E$  represent respectively the rates of emission of energy per unit area for a non-black body and for a black body and  $a_t$  is the total absorption factor for the non-black body.

Anticipating later developments, let us carry this discussion slightly forward. Evidently, the opaque non-black body must reflect all incident radiation that it does not absorb. If molten iron has an absorption factor of 0.29, it must also have a reflection factor of 0.71, that is,

$$r_t = 1 - a_t \tag{2}$$

where  $r_t$  is the total reflection factor.<sup>2</sup> Similar reasoning may be applied to radiation of any wave-length with corresponding similar results.

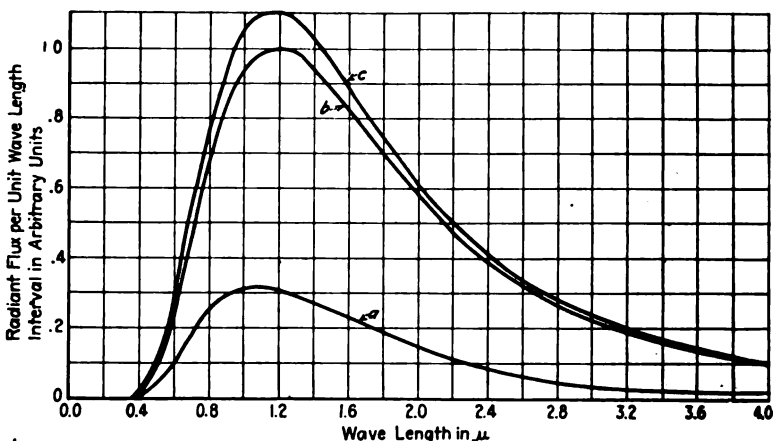

FIG. 1.—SPECTRAL DISTRIBUTION CURVES FOR THE RADIANT FLUXES FROM: a, TUNGSTEN AT 2450° K.; b, A BLACK BODY AT 2450° K.; c, A BLACK BODY AT 2500° K.

It is well to emphasize the fundamental basic character of this law for the measurement of high temperatures. Exactly how this is the case will appear to some extent as we proceed. That it also underlies the laws of Stefan and Boltzmann and of Planck, to be considered later, will not be made evident there, though true.

*Illustrative Data.*—Let us consider, further, specimen data illustrating the relation between emissive powers and radiation. In Fig. 1, curve a represents the spectral distribution of the radiant flux from tungsten at 2450° K., the normal operating temperature of the 60-watt vacuum tungsten lamp. It shows the relative heating effects of radiant flux associ-

<sup>2</sup>For radiation having the same spectral distribution as that from a black body having the same temperature.

ated with the various wave-lengths of the source. Thus, for instance, the maximum effect is in the infra-red spectrum at  $1.05\mu$ , being about a third greater than at the red edge of the visible spectrum ( $0.78\mu$ ) and about three and one-half times as great as at the blue edge of the visible spectrum ( $0.38\mu$ ). The area enclosed by this curve and the X-axis in accord with this represents the total heating effect or radiant flux from the source per unit area, a quantity to be measured ordinarily in  $\frac{\text{watts}}{\text{cm.}^2}$ .

Similarly, curve *b* shows the relative heating effects or radiant flux associated with the various wave-lengths of the radiation from a black body at  $2450^\circ\text{K}$ . The area enclosed by this curve and the X-axis likewise represents the total heating effect or radiant flux from a black body per unit of area, a quantity likewise expressed ordinarily in  $\frac{\text{watts}}{\text{cm.}^2}$ . Curve *c* refers in an exactly similar manner to a black body at  $2500^\circ\text{K}$ . At this temperature a black body possesses the same color as does the tungsten at  $2450^\circ\text{K}$ .

*The total emissive power of a substance is the ratio of the radiant flux per unit of area from that substance to the radiant flux per unit of area from a black body at the same temperature.* Thus, the ratio of the area under curve *a* to the area under curve *b* gives at once the total emissive power for tungsten at  $2450^\circ\text{K}$ . Taking due account of the units in which the ordinates and abscissas of Fig. 1 are expressed, we find from the area under curve *b* that the rate of emission of energy or the radiant flux from a black body at  $2450^\circ\text{K}$ . is about  $205 \frac{\text{watts}}{\text{cm.}^2}$  and that the corresponding radiant flux from tungsten at the same temperature is about  $50 \frac{\text{watts}}{\text{cm.}^2}$ . This<sup>3</sup> leads to 0.27 for the total emissive power of tungsten at  $2450^\circ\text{K}$ . This ratio for tungsten is not constant with temperature.

From the same set of curves, in Fig. 1, the significance of spectral emissive powers may be obtained; but, since they are more commonly obtained for high-temperature work from visual observations, we shall consider them from this point of view. A similar plating of the visual effects against the wave-length for the radiation from a tungsten filament at  $2450^\circ\text{K}$ . and a black body at  $2450^\circ\text{K}$ . and  $2500^\circ\text{K}$ . lead to the spectral luminosity or more truly the spectral brightness distribution curves of Fig. 2. Curve *a* thus shows the relative visual effects associated with the various wave-lengths of the luminous flux from tungsten at  $2450^\circ\text{K}$ . It shows that, for a certain small wave-length interval, the visual effect

---

<sup>3</sup> In computing curve *a*, it was assumed that Lambert's cosine law of emission was fulfilled. There are marked deviations from this, however, which undoubtedly explain largely the discrepancy between the value for the radiant flux per unit of area here given and the value obtained from direct measurement.

### 372 EMISSIVE POWERS AND TEMPERATURES OF NON-BLACK BODIES

is greater at about  $0.575\mu$  than elsewhere, that at  $0.5\mu$  the visual effect is roughly one-sixth of the maximum value, and at  $0.6\mu$  about five-sixths of the maximum value. Curves *b* and *c* represent similar spectral brightness distribution curves for a black body at  $2450^\circ$  and  $2500^\circ$  K. As in the case of the spectral radiant-flux curves, the areas included under the curves represented the rates of emission of radiant energy per unit of area, quantities measurable in  $\frac{\text{watts}}{\text{cm.}^2}$ , so here the areas included under the curves may be taken to represent the brightness of the tungsten filament

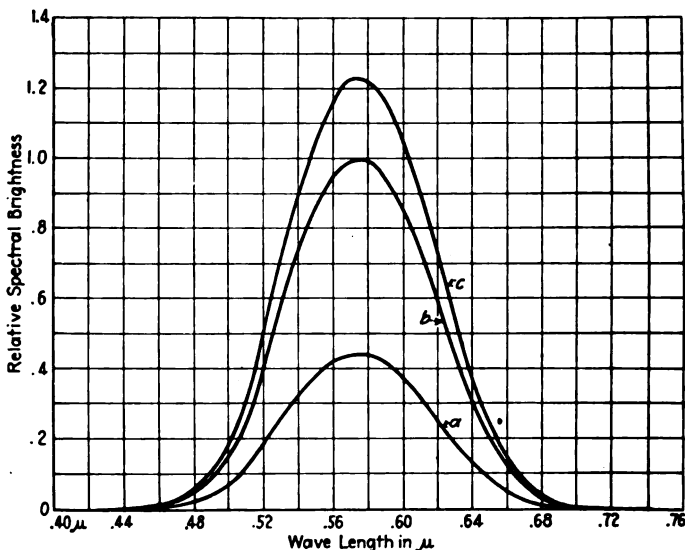

FIG. 2.—SPECTRAL DISTRIBUTION CURVES FOR THE LUMINOUS FLUXES FROM: *a*, TUNGSTEN AT  $2450^\circ$  K.; *b*, A BLACK BODY AT  $2450^\circ$  K.; *c*, A BLACK BODY AT  $2500^\circ$  K.

or of the black body; and, if due account of the units in which the ordinates and abscissas are expressed is taken, one will obtain about  $195 \frac{\text{candles}}{\text{cm.}^2}$  and  $440 \frac{\text{candles}}{\text{cm.}^2}$  for the tungsten filament and for the black body at  $2450^\circ$  K., respectively.

*The spectral emissive power at a given wave-length and temperature for a certain substance is defined as the ratio of the spectral brightness for that substance for the given temperature and wave-length to the corresponding spectral brightness of a black body at the same temperature.* Thus, the ratio of the ordinate at  $0.6\mu$  for curve *a* to the ordinate at the same wave-length for curve *b* gives the spectral emissive power at  $0.6\mu$  for tungsten at  $2450^\circ$  K. Actual carrying out of the operation in the present case yields quite closely 44 per cent. Similarly, the ratio of the correspond-

ing ordinates at  $0.7\mu$  gives the spectral emissive power connected with that wave-length. The actual value is about 42 per cent. These values might be obtained also, as stated, from the spectral radiant-flux curves; and in conformity with this the ratios of their ordinates at  $0.6\mu$  and  $0.7\mu$  should likewise be 44 and 42 per cent.

### TOTAL EMISSIVE POWERS

*Theoretical Basis.*—The theoretical basis underlying total emissive power determinations and applications is the relation applicable to black-body radiation, known as the Stefan-Boltzmann law,

$$E = \sigma T^4 \quad (3)$$

It states that  $E$ , the radiant-flux density (that is the rate of radiation of energy per unit of area) by a black body is a constant times  $T$  its temperature on the absolute scale raised to the fourth power. When  $E$  is expressed in  $\frac{\text{watts}}{\text{cm.}^2}$  and  $T$  in  $^{\circ}\text{K.}$ ,  $\sigma$  is as a result of a great deal of experimental work commonly taken<sup>4</sup> as about  $5.70 \times 10^{-12} \frac{\text{watts}}{\text{cm.}^2 \text{ deg.}^4}$ . We find thus that for a black body at  $1000^{\circ}\text{K.}$ , the radiant-flux density is  $5.70 \frac{\text{watts}}{\text{cm.}^2}$ ; at  $2000^{\circ}\text{K.}$ ,  $16 \times 5.70 \frac{\text{watts}}{\text{cm.}^2}$  or  $91.2 \frac{\text{watts}}{\text{cm.}^2}$ ; and at  $2450^{\circ}\text{K.}$  the normal operating temperature of the vacuum tungsten lamp, as already mentioned,  $206 \frac{\text{watts}}{\text{cm.}^2}$ .

For a non-black body the radiant-flux density  $E_n$  may be represented by a similar equation:

$$E_n = \epsilon_t \sigma T^4 \quad (4)$$

where  $\epsilon_t$  represents the total emissive power. This equation serves, in fact, as the defining equation for this quantity. As has been indicated elsewhere  $\epsilon_t$  may, and usually will, vary with the temperature. In Fig. 1. curves  $a$  and  $b$ ,  $E_n$  and  $E$  are graphically represented for a tungsten filament and a black body at  $2450^{\circ}\text{K.}$ , by the areas included between the  $X$  axis and the corresponding curves.

Evidently we may also write,

$$E_n = \sigma T_R^4, \quad (5)$$

an equation exactly similar to (3) in which  $T_R$ , a temperature less than the true temperature  $T$ , is the temperature of a black body that radiates energy at the same rate per unit of area as does the non-black body at  $T$ . So far as the writer is aware, no definite name has been attached to this

<sup>4</sup> Coblenz: U. S. Bureau of Standards *Bull.* 13 (1916) 459.



374 EMISSIVE POWERS AND TEMPERATURES OF NON-BLACK BODIES

temperature heretofore. For the purposes of this paper<sup>5</sup> let us call it "radiation temperature" in analogy with brightness temperature and color temperature. We may thus expect to say, for instance, that molten iron at a true temperature of 1600° K. has a radiation temperature of 1174° K., or that silver at a true temperature of 1200° K. has a radiation temperature of 720° K., or that iron oxide at a true temperature of 1200° K. has a radiation temperature of 1160° K.

From equations (4) and (5) there follows:

$$T_R = \sqrt[4]{\epsilon_t T}. \quad (6)$$

Evidently we may determine  $\epsilon_t$ , the total emissive power, when  $T$  and  $T_R$  are known, or we may determine  $T$  when once  $\epsilon_t$  and  $T_R$  are known.

*Radiation Pyrometry.*—At present there are several types of radiation pyrometers that may be used in determining total emissive powers or, once these total emissive powers are known, to determine true temperatures. Radiation pyrometers, their underlying principles, methods of use, and sources of error, have been discussed by Burgess and Foote.<sup>6</sup> In this discussion of total emissive powers, this important contribution is freely referred to. While different types of radiation pyrometers differ greatly in construction, they all depend necessarily on effects due to the absorption of radiant energy that is focused, by one means or another, upon a receiving instrument sensitive to heating effects, a thermocouple, a bimetallic coil, or some other radiation-sensitive device.

Let us fix our attention, for illustrative purposes, upon the Fery mirror thermocouple radiation pyrometer in which the radiation from the object whose temperature is being measured is reflected by a gold-plated mirror on to a blackened thermocouple receiver. For a description of the apparatus and the method of operating, reference should be made to the paper by Burgess and Foote or to another paper of this symposium dealing with radiation pyrometers. It would seem perfectly simple to make use of such a pyrometer in the determination of emissive powers, by sighting a radiation pyrometer with a known black-body calibration (see Fig. 3, in which is shown such a calibration curve as determined by Burgess and Foote) at a non-black body at a known temperature and computing the result by means of equation (6). In practice, difficulty is often experienced in determining the true temperature. Further, account must be taken of reflected radiations.

True temperatures are usually determined by means of a thermocouple, or by shaping the material so that from certain portions black-body radiation is obtained, or by placing in contact with the non-black

---

<sup>5</sup> See also paper by E. P. Hyde: High-temperature Scale and its Application in the Measurement of True, Brightness and Color Temperatures. This volume.

<sup>6</sup> U. S. Bureau of Standards *Bull.* 12 (1915) 91.

body some other body whose temperature is known or measurable. As an illustration, making use of the results obtained by Thwing<sup>7</sup> for molten iron, and of the calibration curve of Fig. 3, we should find for a particular case an e.m.f. of 1.32 millivolts when the pyrometer is sighted on a certain mass of iron and 4.21 millivolts when sighted on some body in contact shaped so as to give black-body radiation. From the calibration curve it follows at once that the temperature of the iron is 1600° K. (1327° C.) and that the molten iron has a radiation temperature (subject to a slight correction, shown in the next paragraph) of 1174° K., that is, molten iron

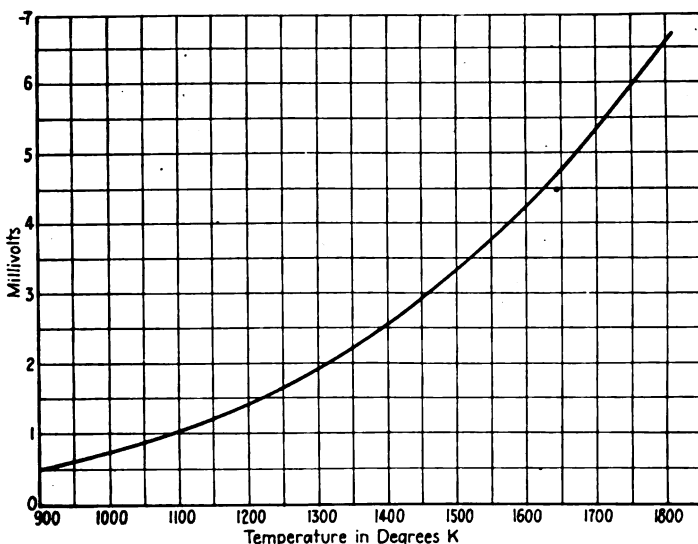

FIG. 3.—CALIBRATION CURVE OF A FERY MIRROR PYROMETER, ACCORDING TO BURGESS AND FOOTE.

at 1600° K. radiates energy at the same rate as does a black body at 1174° K., the common rate in this case being  $10.8 \frac{\text{watts}}{\text{cm.}^2}$ , as will appear from the Stefan-Boltzmann equation. Using equation (6) we have at once 0.29 as the total emissive power.

That account must be taken of radiations reflected by the non-black body the radiation pyrometer is sighted on is readily seen. In this case, the radiation leaving the non-black body is made up in part of the natural radiation from the non-black body and in part of radiation reflected by it. Naturally the effect of the combined radiations on the receiver of the pyrometer is greater than that due to the non-black body alone. Exactly how much the reflected portion amounts to in per cent. depends

<sup>7</sup> *Loc. cit.*

376 EMISSIVE POWERS AND TEMPERATURES OF NON-BLACK BODIES

on the temperature of the non-black body, the temperature of the surroundings, and the reflectivity of the non-black body. Under ordinary conditions the portion reflected may often be neglected, but it is a factor that must be considered. Let us consider expressions for the net rates of transfer of radiant energy to a black receiver at temperature  $T_1$  from a non-black source at temperature  $T$  in surroundings assumed opaque and at a temperature  $T_0$ , and from a black body of the same size at the same distance from the receiver and in the same surroundings but at a temperature  $T_R$ , an uncorrected radiation temperature for the non-black body such that the effects on the black receiver will be the same in the two cases. Suppose the dimensions of the sources and the receiver to be small in comparison with the distance  $l$  from the source to the receiver and the areas of their projections on a plane normal to the line joining them to be, respectively,  $A_1$  and  $A_2$ . For the common net rate of transfer of radiant energy from the source to the receiver  $\frac{dH}{dt}$ , we have for the black-body source and the non-black-body source, respectively, from purely geometrical considerations,

$$\frac{dH}{dt} = \frac{A_1 A_2 \sigma}{l^2 \pi} (T_R^4 - T_1^4) \quad (7)$$

and

$$\frac{dH}{dt} = \frac{A_1 A_2 \sigma}{l^2 \pi} (\epsilon_t T^4 + r_t T_0^4 - T_1^4) = \frac{A_1 A_2 \sigma}{l^2 \pi} (T_R^4 + r_t T_0^4 - T_1^4) \quad (8)$$

where  $r_t$  is the total reflectivity of the non-black body for radiation from a black body at  $T_0$ . From equations (7) and (8) we have, at once,

$$\epsilon_t = \frac{T_R^4 - r_t T_0^4}{T^4} \quad (9)$$

Replacing  $r_t$  by  $1 - \epsilon_t$ , we have another form which has been considerably used:<sup>8</sup>

$$\epsilon_t = \frac{T_R^4 - T_0^4}{T^4 - T_0^4} \quad (10)$$

<sup>8</sup>Dr. Foote has called the writer's attention to the fact that (10) is not exact, due to  $r_t$  being equal to  $1 - \epsilon_t$  only when the incident radiation has the same spectral distribution as that from a black body at the same temperature. Following much the plan adopted by Aschkinass [Aschkinass: *Ann. d. Phys.* (1905) 17, 960; Foote: U. S. Bureau of Standards *Bull.* 11 (1915) 607] in arriving at an expression for the total emissive power of a metal as a function of temperature, Foote has arrived at the following equation,

$$\epsilon_t = \frac{T_R^4 - T_0^4}{T^4 - T_0^4 \sqrt{T_0}} \quad (10^1)$$

which likewise is applicable to metals only. Equation (10<sup>1</sup>) eliminates the very difficult and tedious determination of  $r_t$  and may therefore usually be used. For precision work, however, equation (9) should be used.

Evidently equations (6) and (9) give for the radiation temperature of the non-black body in terms of the uncorrected observed temperature,

$$T_R^4 = T_{R'}^4 - r_i T_0^4 \tag{11}$$

The discrepancy between  $T_R$  and  $T_{R'}$  is often negligible but, on the other hand, may become of considerable importance. A few random illustrations showing this discrepancy and  $\frac{\Delta \epsilon_t}{\epsilon_t}$  the error in the emissive power due to neglecting the reflected radiation term of (9) are incorporated in Table 1. The discrepancies are small for high temperatures and high emissive powers of the source and for low temperatures of the surroundings.

TABLE 1.—Errors Resulting from Neglecting Reflected Radiation Term of Equation (9)

| Material        | $T_o$<br>Degrees K. | $T_s$<br>Degrees K. | $\epsilon$ | $r_i$ | $T_R$<br>Degrees K. | $T_{R'} - T_R$<br>Degrees K. | $\frac{\Delta \epsilon_t}{\epsilon_t}$<br>Per Cent. |
|-----------------|---------------------|---------------------|------------|-------|---------------------|------------------------------|---|
| Platinum.....   | 1000                | 300                 | 0.100      | 0.945 | 562                 | 10.4                         | 8.0   |
| Platinum.....   | 1200                | 300                 | 0.118      | 0.941 | 704                 | 5.4                          | 3.1   |
| Platinum.....   | 1500                | 300                 | 0.142      | 0.936 | 921                 | 2.4                          | 1.0   |
| Platinum.....   | 2000                | 300                 | 0.177      | 0.931 | 1297                | 0.8                          | 0.3   |
| Platinum.....   | 1000                | 400                 | 0.100      | 0.937 | 562                 | 31                           | 24  |
| Silver.....     | 1000                | 300                 | 0.045      | 0.975 | 461                 | 19                           | 17  |
| Iron oxide..... | 1000                | 300                 | 0.86       | 0.14  | 963                 | 0.3                          | 0.13  |
| Black body....  | 1000                | 300                 | 1.00       | 0.00  | 1000                | 0.0                          | 0.0   |

A second method of obtaining total emissive power consists in applying Kirchhoff's law. As already stated this law is represented by

$$E = \frac{E_n}{a_t}$$

From our definition of emissive power, it follows that the emissive power of any substance is equal to the absorption factor for black-body radiation corresponding to the same temperature as that possessed by the non-black body. This equality has been used in the discussions of the absorption factor and total emissive power for molten iron at 1600° K., for which the common value is 0.29. As  $a_t = 1 - r_i$  where  $r_i$  is the reflection factor,

$$\epsilon_t = 1 - r_i \tag{12}$$

The method embodied in this equation consists essentially in measuring for a non-black body the fractional part of the radiation from some other source reflected by the non-black body. Only in relatively few cases will the method be satisfactory and not entail many corrections. These simple cases demand non-black bodies that have either well polished

### 378 EMISSIVE POWERS AND TEMPERATURES OF NON-BLACK BODIES

or perfectly matt surfaces and black-body or very similar sources at about the same temperature as the non-black body.

Given the total emissive power of a substance, it is possible to compute its true temperature when once the radiation temperature is known. The expression employed here is the same as the one used in determining the emissive power, or equation (6). The radiation temperature  $T_R$  will be determined ordinarily from a direct reading of the e.m.f. of a radiation pyrometer receiver and an interpolation from a calibration curve such as is given in Fig. 3. Corrections as shown above, if appreciable, must be made in order to obtain the corrected radiation temperatures. Suppose  $T_R$  for a certain specimen of molten iron to be  $1200^\circ \text{K.}$ ; then using 0.29 as  $\epsilon_t$ ,  $1635^\circ \text{K.}$  is its true temperature.

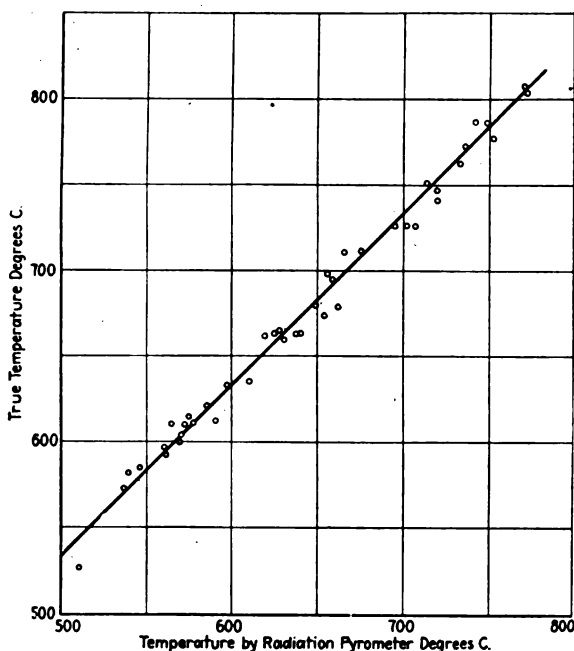

FIG. 4.—RADIATION TEMPERATURE AND TRUE TEMPERATURE RELATION FOR IRON OXIDE ACCORDING TO BURGESS AND FOOTE.

Ordinarily, when one has occasion to work repeatedly on samples of the same material at different temperatures, he will have computed a curve showing the relation between radiation temperature and true temperature. In case one has measured the total emissive powers by the first method outlined, the data obtained may be platted directly to give this relation without going through emissive power computations. In Fig. 4 such a plat of results by Burgess and Foote<sup>9</sup> on iron oxide is shown. An average deviation of about  $5^\circ$  from the curve is shown by the individual

<sup>9</sup> U. S. Bureau of Standards *Bull.* 12 (1915), 83.

readings. From such a plat, the corrections to be applied to radiation temperatures in order that true temperatures may be obtained may be readily determined. Thus, according to this plat, at a radiation temperature of  $500^{\circ}\text{C.}$  ( $773^{\circ}\text{K.}$ ), we have to add about  $33^{\circ}$  to get the true temperature; for  $600^{\circ}\text{C.}$ ,  $35^{\circ}$ ; for  $750^{\circ}\text{C.}$ ,  $39^{\circ}$ . These correspond to an emissive power varying from somewhat less than 0.85 for the lowest temperature to 0.86 for the highest temperature. For the lowest of these temperatures, the authors have assigned a total emissive power of 0.85 and, for reasons we need not consider here, for the highest temperature 0.87. Considering difficulties, especially the relatively large temperature drop between metal iron and the outer surface when oxidized as shown by Burgess and Foote, this is not a bad agreement with the careful work by Randolph and Overholser<sup>10</sup> who, apparently not aware of this difference, obtained 0.78 and 0.79 respectively for oxidized cast iron and oxidized steel at  $600^{\circ}\text{C.}$

Data of this type are rather meager. There should be mentioned, however, among recent works, including those already alluded to, that by Thwing<sup>11</sup> on molten copper and molten iron, that by Burgess<sup>12</sup> on molten copper and cuprous oxide, that by Randolph and Overholser<sup>13</sup> on cast iron and the oxides of zinc, aluminum, copper, nickel, lead, calorized copper, monel, calorized steel, brass, cast iron, and steel, that by Burgess and Foote<sup>14</sup> on iron oxide and nickel oxide, and that by Foote<sup>15</sup> on platinum.

The question might well be asked, why we pay any attention to such a quantity as total emissive power since usually we obtain it from measurements of radiation temperature and true temperature. The answer is that emissive powers give to the individual who tries to compare various radiating substances and to rate them accordingly, a more convenient and significant basis for these purposes than does a statement of the radiation-temperature true-temperature difference.

*Solar Radiation Temperature.*—As another application of radiation pyrometers, which for this type of work are usually known as pyrheliometers, there are the investigations of Pouillet, Langley and others, and finally of Abbot, Fowle, and Aldrich,<sup>16</sup> on the intensity of the solar radiation and the radiation temperature of the sun. The work in this case has been greatly complicated by the fact that all observations were necessarily made with a great thickness of the earth's atmosphere between the observer and the source. In order to take account of the absorption of the sun's radiation by the earth's atmosphere, Abbot, Fowle, and Aldrich have used stations at Mt. Whitney and Mt. Wilson, in California, Bassour, Algeria, and Washington, D. C., which are

<sup>10</sup> *Phys. Rev.* [2] (1913) 2, 144.

<sup>11</sup> *Loc. cit.*

<sup>12</sup> U. S. Bureau of Standards *Bull.* 6 (1910) 111.

<sup>13</sup> *Loc. cit.*

<sup>14</sup> U. S. Bureau of Standards *Bull.* 11 (1914) 41; *Bull.* 12 (1915) 83.

<sup>15</sup> U. S. Bureau of Standards *Bull.* 11, 607.

<sup>16</sup> *Annals, Astrophys. Obs., Smithsonian Inst.*, 2 and 3; Abbot: "The Sun."

380 EMISSIVE POWERS AND TEMPERATURES OF NON-BLACK BODIES

approximately 3 mi., 1 mi.,  $\frac{3}{4}$  mi., and 0 mi., respectively, above sea level. The precise method of obtaining the transmission of the earth's atmosphere will be found in the paper already referred to and probably in another paper to be presented at this symposium. With such integral transmissions, it is theoretically simple to obtain the radiation temperature of the sun, as viewed outside the earth's atmosphere  $T'_R$  from the radiation temperature at the earth's surface  $T_R$  observed with a calibrated pyrheliometer. Evidently

$$T'_R = \sqrt[t]{T_R} \quad (13)$$

where  $t$  is the total transmission of the earth's atmosphere.

The method employed, however, has been somewhat different. In calibrating pyrheliometers, instead of sighting the receiver on a calibrated black body, heat was usually developed electrically at known rates within it, and the effect on the recording instrument noted. It is this effect, suitably chosen in the calibration work, that was compared with the effect noted when the pyrheliometer was sighted at the sun. Thus there were obtained measurements in absolute units of the sun's radiation at the various stations. For instance, during a certain interval on Sept. 5, 1912, at Mt. Wilson, the pyrheliometer indicated that radiation was being received at a rate given by  $1.264 \frac{\text{calories}}{\text{cm.}^2 \text{ min.}}$ ; the integral transmission of the atmosphere was found to be 63.8 per cent. at this time. There results by simple division  $1.985 \frac{\text{calories}}{\text{cm.}^2 \text{ min.}}$ . For the average for the day in question,  $2.014 \frac{\text{calories}}{\text{cm.}^2 \text{ min.}}$  was obtained. From results extending over many years Abbot, Fowle, and Aldrich have arrived at  $1.932 \frac{\text{calories}}{\text{cm.}^2 \text{ min.}}$  as giving the most probable value according to their observations. Combining this with 149,560,000 km. as the mean radius of the earth's orbit, and 696,000 km. as the mean solar radius, and using equation (3) with  $5.70 \times 10^{-12} \frac{\text{watts}}{\text{cm.}^2 \text{ deg.}^4}$ , or what is the same thing  $81.8 \times 10^{-12} \frac{\text{calories}}{\text{cm.}^2 \text{ min. deg.}^4}$  as the up-to-date value of  $\sigma$ , one obtains  $5750^\circ \text{ K.}$  as the radiation temperature of the sun.

The determination of the true temperature of the sun is a matter of great scientific interest. It appears not to be possible to make use of any total emissive power in connection with the radiation temperature obtained, for from our present understanding of the situation, the radiations in different parts of the sun's spectrum effectively have their sources at different depths within the sun and, therefore, at different temperatures. Attempts have been made to determine true temperatures from other points of view than that of the total radiation. Generally, as was

expected, they have given temperatures noticeably in excess of the radiation temperature values, in the neighborhood of 6200° K. to 7000° K.

### SPECTRAL EMISSIVE POWERS

The theoretical basis underlying spectral emissive power measurements is given by Planck's equation, a law mathematically formed that gives very closely the spectral distribution of radiant flux found for black-body radiation. It is

$$J = c_1 \lambda^{-5} \frac{1}{e^{\frac{c_2}{\lambda T}} - 1} \quad (14)$$

in which  $J$  represents the spectral intensity of the radiant flux at wave-length  $\lambda$  and temperature  $T$ ,  $e$  the base of natural logarithms, and  $c_1$  and  $c_2$  constants. For a black body at 2450° K., this equation is graphically represented by curve  $b$  of Fig. 1. The various ordinates  $J$  of this curve represent the relative heating effects associated with the corresponding wave-lengths. Curve  $c$  represents the spectral distribution of radiant flux from a black body at 2500° K. Equation (14) shows not only how  $J$  varies with wave-length  $\lambda$  at any one temperature  $T$  but also how it varies with the temperature  $T$  at any one wave-length. Thus curves  $b$  and  $c$  show that at 0.467 $\mu$ , for instance, the values of  $J$  at 2450° and 2500° K. are in the ratio 2.51 and at 0.665 $\mu$  in the ratio 1.76. This latter characteristic of Planck's law, representing the variation with temperature, is the one of vital importance in the theoretical discussion of spectral emissive powers.

The corresponding spectral radiant-flux curve of a non-black body may be represented by a similar equation

$$J_n = \epsilon_\lambda J = \epsilon_\lambda c_1 \lambda^{-5} \frac{1}{e^{\frac{c_2}{\lambda T}} - 1} \quad (15)$$

in which an added term  $\epsilon_\lambda$ , the emissive power of the non-black body at wave-length  $\lambda$  is included. Ordinarily  $\epsilon_\lambda$  is a variable changing both with temperature and wave-length. Curve  $a$  of Fig. 1 represents such a distribution for tungsten at 2450° K. The ratio of an ordinate of this curve for any given wave-length  $\lambda$  to the corresponding ordinate of curve  $b$  gives  $\epsilon_\lambda$  for tungsten at 2450° K. at that wave-length. Thus for 0.467 $\mu$  and 0.665 $\mu$  we have, respectively, 0.464 and 0.428 as the corresponding emissive powers of tungsten at 2450° K.

In any special case where the product  $\frac{c_2}{\lambda T}$ , the exponent of  $e$  in the equations (14) and (15), is more than, say 6, the term  $-1$  may be neglected without appreciable error. For this limit, the error introduced in  $J$  or  $J_n$  is about 0.25 per cent. For this condition, which includes all optical measurements where  $\lambda$  does not exceed 0.7 $\mu$  up to temperatures of



### 382 EMISSIVE POWERS AND TEMPERATURES OF NON-BLACK BODIES

about 3500° K., the simplified approximation known as Wien's equation is employed. We then have

$$J = c_1 \lambda^{-5} e^{-\frac{c_2}{\lambda T}} \quad (16)$$

and

$$J_n = \epsilon_\lambda J = \epsilon_\lambda c_1 \lambda^{-5} e^{-\frac{c_2}{\lambda T}} \quad (17)$$

Since for most purposes these equations are accurate well within the limits set by the uncertainties of experiment, we shall assume these latter equations for the further discussion, with the understanding that the reasoning employed may be carried without loss of generality to the cases where Planck's equation must be used.

For the further consideration of spectral emissive powers, let us consider the disappearing-filament type of pyrometer,<sup>17</sup> in which one views through a more or less monochromatic screen a pyrometer filament projected against the object whose temperature is being measured. Several precautions<sup>18</sup> should be observed in using such an instrument, primary among which are the keeping of the entrance cone angle constant and the obtaining of an axial alignment. The setting of the instrument consists in changing the current through the pyrometer filament until it disappears against the background. In the operation, we are not directly concerned with distributions given by the curves of Fig. 1. Instead we are directly concerned with spectral distributions of luminous flux, or more truly the spectral brightness distributions, such as are shown in Fig. 2, the equations for which are usually derived from the relation

$$b' = V_\lambda J \quad (18)$$

where  $b'$ , a quantity like  $J$  varying with wave-length and temperature, represents the luminosity or luminous effect of the radiation associated with the heating effect  $J$ .  $V_\lambda$  represents the visibility, a factor varying with the wave-length, which permits of a mathematical representation for the spectral brightness distribution when once the spectral distribution of the radiant-flux emission density is known. Thus the curves of Fig. 2, may be, and actually were, computed from the data used in plating the curves of Fig. 1, and the values of relative visibility accepted by the nomenclature and standards committee of the Illuminating Engineering Society.<sup>19</sup> Equations for the spectral brightness distributions of a black body and a non-black body follow at once from the last three. Since  $V_\lambda$  changes with wave-length only, it is evident that the ratio of an ordinate of curve  $a$  of Fig. 2, to the ordinate of curve  $b$  for any wave-length is the same as the corresponding ratio for curves  $a$  and  $b$  of Fig. 1. Thus at

<sup>17</sup> Forsythe: *Bull.* 153 (September, 1919).

<sup>18</sup> Worthing and Forsythe: *Phys. Rev.* [2] (1914) 4, 163.

Hyde, Cady and Forsythe: *Astrophys. Jnl.* (1915) 42, 303.

<sup>19</sup> *Trans* Ill. Engng. Soc. (1918) 13, 512.

0.467 $\mu$  and 0.665 $\mu$ , the ratio of the ordinates determined visually are also 0.464 and 0.428.

In case the disappearing-filament pyrometer is provided with a spectrometer so that the luminous flux employed in the determination of emissive powers or of temperatures is quite homogeneous, it is merely necessary to determine the ratio of the luminosity of the non-black body at the desired wave-length to the corresponding luminosity of a black body at the same temperature. The working equation becomes merely:

$$\epsilon_{\lambda} = \frac{b'_{\lambda}}{b'} \quad (19)$$

There is, of course, no question then as to what wave-length to ascribe the emissive power determinations.

In case the disappearing-filament pyrometer is not so provided with a spectrometer and the comparisons of black-body and non-black-body radiations are made with a considerably extended spectral range of wave-lengths, the procedure is not so simple. So-called monochromatic screens, usually transmitting a considerable range of wave-lengths at the red end of the spectrum, are commonly used in order to eliminate color differences between the source and the pyrometer filament. What is really compared, in this case, is a certain brightness of the non-black body with that of a black body at the same temperature; the ratio represents an average emissive power, and as such must naturally be ascribed to some wave-length. For a particular so-called monochromatic screen one might expect this wave-length to change with a change in the temperature of the sources. This is the case. How it changes with the temperature will be discussed later. Up to within a few years it was assumed, questioningly in many cases, that the wave-length to be used is that which visually appears to be at the center of the transmitted band on the passage of the flux through a spectrometer. On this assumption, one naturally proceeds using equation (19) just as in the case where the transmission band is limited by means of a spectrometer.

Just as in measuring non-black bodies with the total radiation pyrometer we make use of radiation temperatures, so here we use a similar quantity called brightness temperature.<sup>20</sup> It is defined by the equation:

$$b'_{\lambda} = V_{\lambda} \epsilon_{\lambda} c_1 \lambda^{-5} e^{-\frac{c_2}{\lambda T}} = V_{\lambda} c_1 \lambda^{-5} e^{-\frac{c_2}{\lambda S}} \quad (20)$$

or more simply by

$$\frac{1}{T} = \frac{1}{S} + \frac{\lambda}{c_2} \ln \epsilon_{\lambda} \quad (21)$$

where  $S$  is the brightness temperature at wave-length  $\lambda$  corresponding to the true temperature  $T$ . This is analogous to equation (6), relating

<sup>20</sup> Hyde, Cady and Forsythe: *Phys. Rev.* [2] (1917) 10, 395.  
 Hyde: *Bull.* 153 (September, 1919).

### 384 EMISSIVE POWERS AND TEMPERATURES OF NON-BLACK BODIES

to total radiation pyrometry. As in the application of the former equation, we may determine  $S$  in terms of  $T$  without consideration of  $\epsilon_\lambda$  or we may determine  $\epsilon_\lambda$  in terms of  $T$  without consideration of  $S$ . The determination of either  $\epsilon_\lambda$  or  $S$  as a function of  $T$  is effectually also a determination of the other one of the two quantities as a function of  $T$ , since the one unknown may at once be obtained with the aid of equation (21). As is true of total emissive powers, it is likewise true of spectral emissive powers that their values give a more convenient and significant basis for comparing radiating substances than do statements of differences between brightness temperatures and true temperatures.

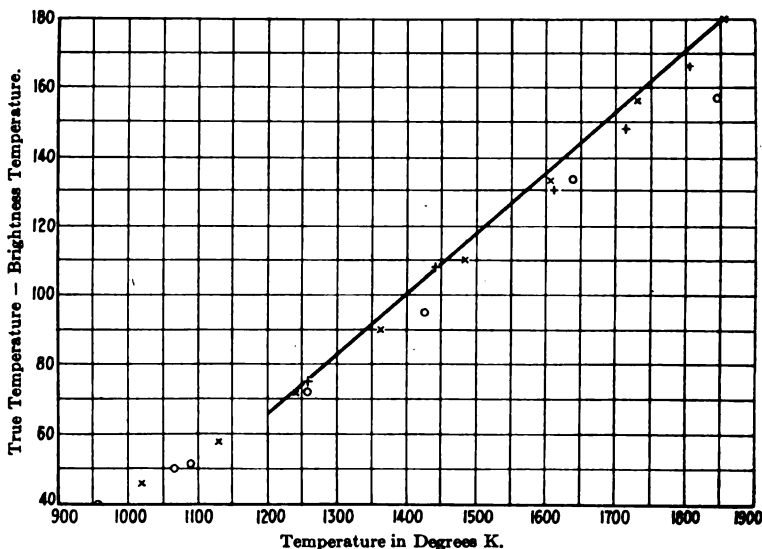

FIG. 5.—BRIGHTNESS TEMPERATURE, TRUE TEMPERATURE RELATIONS FOR PLATINUM ACCORDING TO MEASUREMENTS MADE WITH DISAPPEARING-FILAMENT PYROMETERS WITH RED-GLASS ABSORBING SCREENS. °, HOLBORN AND KURLBAUM; X, WAIDNER AND BURGESS; —, MENDENHALL; +, SPENCE.

*Experimental Methods and Results.*—In the experimental work, the greatest difficulty is experienced in determining the true temperature of the material investigated. In connection with their original work on the disappearing-filament pyrometer, Holborn and Kurlbaum<sup>21</sup> investigated the radiation properties of platinum and palladium, obtaining  $S$  as a function of  $T$ . This was accomplished by forming an enclosure of platinum sheet that was heated electrically. True temperatures were measured by means of a thermocouple, one junction of which was located within the enclosure. Brightness temperatures were measured by sighting a pyrometer, previously calibrated against a black body, on the outer surface of the enclosure. Their results are incorporated in Fig. 5, along

<sup>21</sup> *Ann. Phys.* [4] (1903) 10, 225.

with the results of Waidner and Burgess,<sup>22</sup> who somewhat later used essentially the same method, and of Mendenhall<sup>23</sup> and Spence,<sup>24</sup> both of whom made use of a wedge opening to be described presently. Due to lack of specification of the characteristics of the so-called monochromatic screens used, it is impossible to be sure to what wave-lengths the measured brightness temperature should be ascribed. On the assumption that the monochromatic screens were much the same and that the wave-length to which these should be ascribed is roughly  $0.66\mu$ , the value assumed by Waidner and Burgess, these results lead to approximately 0.36, 0.32, and 0.29 as the emissive powers at  $1000^{\circ}\text{K.}$ ,  $1400^{\circ}\text{K.}$ , and  $1800^{\circ}\text{K.}$ , respectively. Emissive power determination using a spectrophotometer have been carried out by Stubbs and Prideaux<sup>25</sup> on liquid and solid gold and by Stubbs<sup>26</sup> on liquid and solid copper and silver. Bidwell<sup>27</sup> determined, with a disappearing-filament pyrometer, the spectral emissive powers of silver, gold, copper, steel, and nickel. In the three last mentioned investigations, temperatures were obtained from thermocouples embedded in the heated material.

Mendenhall<sup>28</sup> seems to have been the first to suggest a fundamentally sound way to eliminate uncertainties as to the true temperature of the radiating material being investigated. This he accomplished by means of a narrow wedge opening formed by folding on itself a sheet of the material being studied. Regarding this he says:

The device to be described promises to be of some value because it enables one with a calibrated optical pyrometer to determine the true temperature of a radiating surface. It is, of course, nothing but a special scheme for obtaining the Kirchhoff black-body conditions—a black body being defined, as usual, by the conditions,  $a =$  absorptive power  $= 1$ ; it will have, of course, the maximum possible emissive power at any temperature. The special scheme referred to is shown in Fig. 6 (this paper) where  $F$  is a flat conducting ribbon, heated by a longitudinal electric current, as shown, and folded on a line parallel to the length so that the resulting cross-section perpendicular to the current-flow is a very narrow V—say with about  $10^{\circ}$  angular opening. If the ribbon is of uniform thickness and width, it will be raised to a uniform temperature by a given current, except near the ends. The inside of the V might be then expected to be a close approximation to a black body, or total radiator, since it has but a small opening and uniformly heated walls, and if this were so, observations on it with an optical pyrometer would give the true and not the “black-body” (brightness) temperature of its inside walls. The outside of the V will give radiation characteristics of the material of the ribbon, and could be used to study this radiation; but before we can draw conclusions as to the temperature of the outside surface we must evidently consider two questions:

<sup>22</sup> U. S. Bureau of Standards *Bull.* 3 (1907) 163.    <sup>23</sup> *Astrophys. Jnl.* (1911) 33, 191.

<sup>24</sup> *Astrophys. Jnl.* (1913) 37, 194.    <sup>25</sup> *Proc. Roy. Soc. Lond.* (1912) 87A, 451.

<sup>26</sup> *Proc. Roy. Soc. Lond.* (1913) 88A, 195.    <sup>27</sup> *Phys. Rev.* [2] (1914) 3, 439.

<sup>28</sup> *Loc. cit.*

### 386 EMISSIVE POWERS AND TEMPERATURES OF NON-BLACK BODIES

1. How closely does the radiation from the inside of the V approximate that of a black body at the temperature of the inside walls?
2. How much real temperature difference is there between the inside and outside surface of the wall of the V?

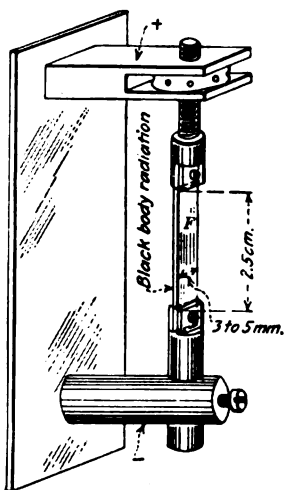

FIG. 6.—WEDGE OPENING USED BY MENDENHALL FOR TRUE-TEMPERATURE MEASUREMENTS.

The first of these two questions was answered by considering the building up of radiation within the V-opening to black radiation. In Fig. 7, a V-opening is formed by bending a specular reflecting sheet. Points *A*, *B*, *C*, *D*, *E*, and *F* are points of reflections for a ray which may be imagined as entering at *P*. If the material of the V is radiating, in consequence of its temperature, for any range of wave-lengths, the bright-

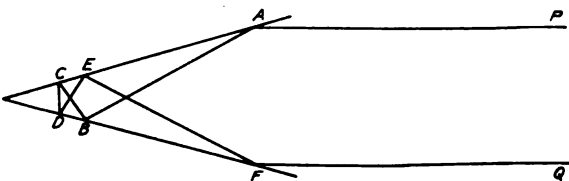

FIG. 7.—DIAGRAM SHOWING HOW RADIATION WITHIN A NARROW V BUILDS UP TOWARD BLACK-BODY RADIATION.

ness of the point *F*, as viewed from *Q* may be considered as made up of various components: first, that due to the natural radiation from *F*, second, that due to the natural radiation from *E* reflected at *F*, third that due to the natural radiation from *D* which is twice reflected at *E* and at *F*, etc. Limiting ourselves to a small wave-length interval, remembering according to Kirchhoff's law that the reflection factor  $r_\lambda$  is equal to  $1 - \epsilon_\lambda$ , and representing by  $b'_\lambda$  the spectral brightness of a black body at

the temperature of the material of the V, and by  $b''$  the corresponding spectral brightness of the point  $F$  as viewed from  $Q$  we have,

$$b'' = \epsilon_\lambda b' + r_\lambda \epsilon_\lambda b' + r_\lambda^2 \epsilon_\lambda b' + \dots + r_\lambda^n \epsilon_\lambda b' = b'(1 - r_\lambda^n)$$

With a V-opening of  $10^\circ$ , as suggested by Mendenhall,  $n$  will be equal to 18. Thus with  $r_\lambda$  equal to 0.7 (about that for the material used originally by Mendenhall)  $\frac{b''}{b'}$  is found to be 99.8 per cent., that is the radiation from the V-cavity may be said to be 99.8 per cent. black, a satisfactory approach to black-body radiation.

The second question relating to the temperature difference between the inside and the outside of the V-opening was settled by computing the difference in temperature from the known dimensions, the electrical input, and the thermal conductivity of the material. For the platinum wedges used, Mendenhall found a difference of the order of a few tenths of a degree. His results on platinum agreed quite well with the previously mentioned results by Holborn and Kurlbaum and by Waidner

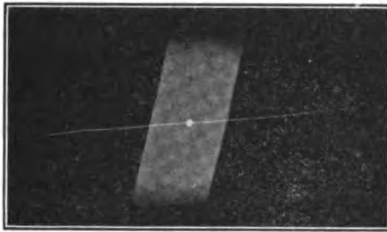

FIG. 8.—PYROMETER FILAMENT PROJECTED AGAINST HOLE AND SURFACE OF A PERFORATED TUBULAR TUNGSTEN FILAMENT AS BACKGROUND, AS USED IN EMISSIVE POWER DETERMINATIONS OF TUNGSTEN.

and Burgess (see Fig. 5). Later Mendenhall and Forsythe<sup>29</sup> applied this method with considerable success to tungsten, tantalum, molybdenum, and carbon.

While the V-method of obtaining the true temperature of the material being investigated was theoretically a considerable advance, it left some uncertainties. The method demanded a uniform temperature over a relatively large plane surface. Moreover, in certain cases, particularly in connection with tungsten, trouble was experienced due to the two separate sheets, found necessary at that time in making up the V, separating so as to leave a gap between the two parts.

The question of the emissive power as a function of the temperature, and therewith also the relation between brightness and true temperature, for tungsten has also been attempted by the writer.<sup>30</sup> It is believed

<sup>29</sup> *Astrophys. Jnl.* (1913) **37**, 380.

<sup>30</sup> *Phys. Rev.* [2] (1917) **10**, 377.

388 EMISSIVE POWERS AND TEMPERATURES OF NON-BLACK BODIES

that in so doing the uncertainties occurring in the work using the V-method have been largely eliminated. In this work long tubular filaments with small holes, Fig. 8, penetrating the side walls at various places have been used. Here again the desirability of the method has depended on the fact that we have accurate means of measuring the temperature of the material being studied. In general terms, the procedure consisted of determining with an optical pyrometer the ratio of the brightness of the filament surface adjacent to a hole, to the brightness of the hole, in a region suitably chosen from the standpoint of constancy of temperature, when the filament was heated to incandescence in a vacuum or in an atmosphere chemically inert. On the assumption that the radiation from the hole is black and that there is a negligibly small difference of temperature between the interior and the surface, such a ratio represents an emissive power for a wave-length depending on the light transmitted by the pyrometer glass screen and for a temperature corresponding to that of the radiation from the hole. This latter temperature was obtained in the standard manner with the aid of Wien's law by comparing the black radiation with that from a calibrated black body of the ordinary type at the palladium point. A brightness-temperature true-temperature relation follows simply.

Several sources of error were of course necessarily considered and corrections were made on account of two of these; one on the difference in temperature between the interior and the exterior surfaces of the tubular filament, the other for the lack of monochromatism in the light used. These corrections were both small; the first correction was by far the more important. A formula proposed by Mendenhall and used by Angell,<sup>31</sup> together with data previously obtained by the writer<sup>32</sup> were used. How important this correction was is shown in a later figure giving emissive power results. The latter correction, one essentially of determining to what wave-lengths measured results shall be applied, will be now considered.

In Fig. 9, exaggerated, curves  $\alpha$ ,  $\beta$ ,  $\gamma$  and  $\delta$  represent for a given filament, at a temperature  $T$ , certain spectral brightness  $b'$  distributions related to the luminous flux transmitted through the pyrometer system including the colored-glass screen at the eyepiece. Let  $\alpha$  refer to the black-body radiation at the temperature  $T$  coming from a hole in the filament wall;  $\beta$  the natural tungsten radiation arising from the adjacent external surface;  $\gamma$  the radiation from a black body having the temperature  $S$ , the measured brightness temperature of the natural tungsten radiation; and  $\delta$  that black-body radiation whose relative brightness distribution is the same as that given by  $\beta$ . These diagrammatic distributions assume

<sup>31</sup> *Phys. Rev.* (1911) **33**, 421.

<sup>32</sup> *Phys. Rev.* [2] (1914) **4**, 535.

the possibility of color matching the tungsten radiation with black-body radiation. Thus curve  $\delta$  is, according to Hyde, Cady and Forsythe,<sup>33</sup> the brightness distribution of a black body at a temperature given by the color temperature of the natural radiation. Evidently, from the definition of brightness temperature, the areas included under curves  $\beta$  and  $\gamma$  are equal. It is also evident that only at the wave-length  $\lambda'$  is the brightness temperature of the natural radiation equal to  $S$ , being progressively less than  $S$  as the wave-length is increased beyond  $\lambda'$  and progressively greater than  $S$  as the wave-length is decreased below  $\lambda'$ .

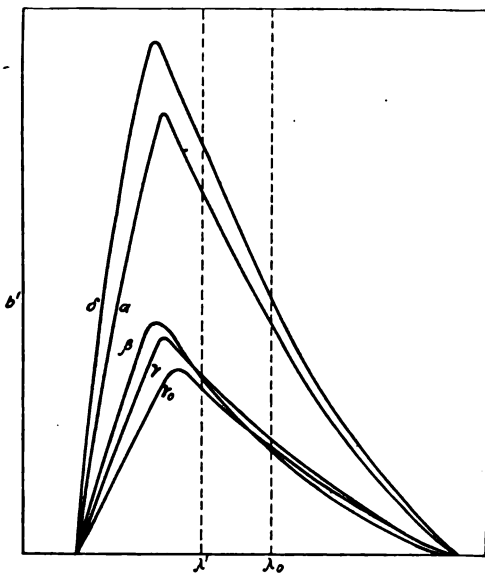

FIG. 9.—VARIOUS SPECTRAL BRIGHTNESS,  $b'$ , DISTRIBUTIONS CONNECTED WITH TUNGSTEN FILAMENTS, WHICH ARE HELPFUL IN DETERMINING THE WAVE-LENGTH TO WHICH TO ASCRIBE BRIGHTNESS TEMPERATURE MEASUREMENTS.

Representing by  $b'_\alpha, b'_\beta$ , etc., values of  $b'$  corresponding to curves  $\alpha, \beta$ , etc. and by  $b_\alpha$ , etc., the total brightnesses  $\int_\sigma^\infty b'_\alpha d\lambda$ , etc. we then have

$$b_\beta = b_\gamma \tag{23}$$

$$\frac{b'_\beta}{b'_\delta} = \frac{b_\beta}{b_\delta} = \frac{b_\gamma}{b_\delta} = \left( \frac{b'_\gamma}{b'_\delta} \right)_\lambda \tag{24}$$

where in the first member  $\lambda$ , of course, refers to any wave-length within the range concerned. The last of these equations, according to Hyde, Cady and Forsythe,<sup>34</sup> is also the defining equation of the effective wave-length of the pyrometer screen for black-body radiation for the tempera-

<sup>33</sup> *Phys. Rev.* [2] (1917) 10, 395.

<sup>34</sup> *Astrophys. Jnl.* (1915) 42, 294.



390 EMISSIVE POWERS AND TEMPERATURES OF NON-BLACK BODIES

ture interval given by curves  $\gamma$  and  $\delta$ . It follows, therefore, that the wave-length  $\lambda'$  to which the brightness temperature  $S$  is to be ascribed is the effective wave-length of the screen for black radiation in going from the brightness temperature of the tungsten to its color temperature. In the writer's work,  $\lambda'$  for tungsten has varied from  $0.6662\mu$  at  $1600^\circ$  K. true temperature to  $0.6628\mu$  for  $3200^\circ$  K.

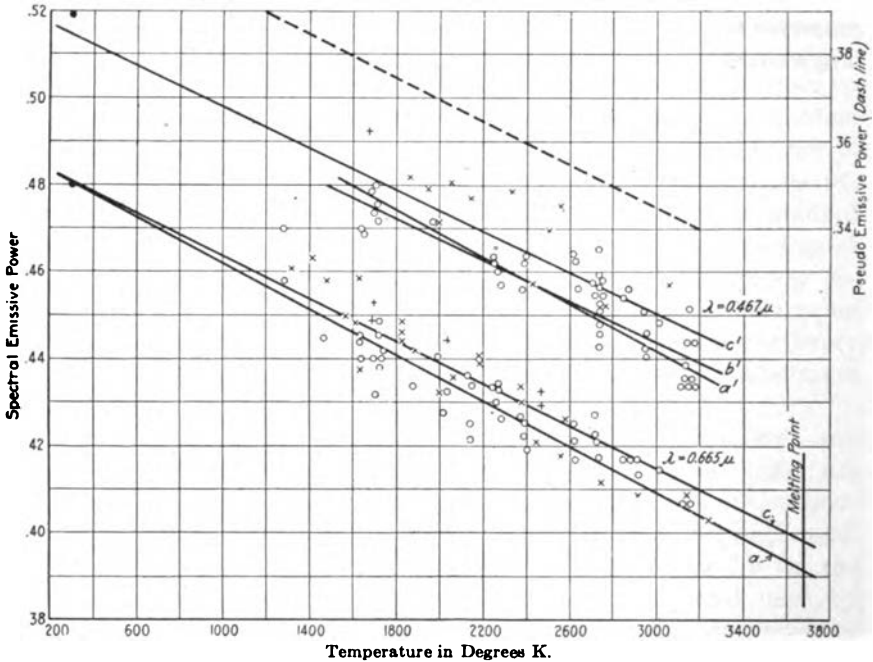

FIG. 10.—EMISSIVE POWER RESULTS AND A COMPUTED PSEUDO-EMISSIVE POWER CURVE FOR TUNGSTEN AS A FUNCTION OF THE TEMPERATURE AT  $0.665\mu$  AND  $0.467\mu$ . X VALUES OBTAINED ON UNPOLISHED FILAMENT IN MUCH STRIATED BULBS; + VALUES OBTAINED ON POLISHED FILAMENTS IN MUCH STRIATED BULBS; ° VALUES OBTAINED ON POLISHED FILAMENT IN FAIRLY CLEAR BULBS; ● VALUES OBTAINED AT ROOM TEMPERATURE BY REFLECTION METHOD; a, a', WEIGHTED CURVES FOR DATA OBTAINED; b', CURVE a' CORRECTED FOR LACK OF MONOCHROMATISM FOR THE UVIOLETT GLASS; c, c', FINAL CURVES CONTAINING CORRECTIONS FOR DIFFERENCES IN TEMPERATURE BETWEEN INTERIOR AND EXTERIOR SURFACES OF THE FILAMENTS.

Having once determined  $\lambda'$ , the method of determining  $S_0$ , the brightness temperature that will correspond to some common wave-length  $\lambda_0$  arbitrarily chosen, is simple. It consists in finding the temperature of a black body corresponding to  $\gamma_0$  (Fig. 9). Choosing  $\lambda_0$  as  $0.665\mu$  means, in the writer's work, that the values of  $S_0 - S$  for tungsten for red light are respectively  $+0.2^\circ$  and  $-1.4^\circ$  at true temperatures  $1600^\circ$  and  $3200^\circ$  K. The corrections for the blue violet screen are somewhat greater.

In a similar way, the wave-length to which to ascribe the emissive

power measurement may be determined. Imagine another spectral brightness distribution curve added to the somewhat complicated figure, which will enclose underneath it an area equal to that enclosed by  $\beta$ , and which will bear the same relation to  $\alpha$  that  $\beta$  does to  $\delta$ . Call this curve  $\beta'$ . The ratio of its ordinates to that of  $\alpha$  will everywhere be equal to the measured emissive power. It will cross the curve  $\beta$  at some wave-length  $\lambda''$ . Evidently at this wave-length only is the ratio of the ordinate of  $\beta$  to that of  $\alpha$  equal to the measured emissive power. Hence strictly the emissive power measured should be ascribed to  $\lambda''$ . As in the case of  $\lambda'$  just described,  $\lambda''$  may be shown to be the effective wave-length for the optical system in passing from distribution  $\alpha$  to distribution  $\delta$ ,  $\lambda''$  is slightly shorter than  $\lambda'$ . On considering later the change in emissive power in going from  $0.665\mu$  to  $0.467\mu$ , together with color-matching possibilities, it will be seen that the changes in the emissive power in going from  $\lambda''$  to  $\lambda_0$  are very small. In this work such corrections at  $0.665\mu$  were inappreciable, those at  $0.467\lambda$  were just appreciable, as will appear later.

The emissive power results are given in Fig. 10. In accord with what has previously been stated, at  $0.665\mu$  and  $0.467\mu$ , the emissive powers for  $2450^\circ$  K, the normal operating temperature of the vacuum tungsten lamp, are respectively 0.428 and 0.464. These values have been used in computing the curves  $a$  of Figs. 1 and 2. It is evidently now possible, with the aid of equation (21), to compute for tungsten the relation between the brightness temperature and the true temperature, the method of determining to what wave-length to assign the brightness temperature having been shown. Previous to the publication of these results (see Table 2), there had been various temperature scales<sup>35</sup> (relation between the brightness temperature at some wave-length and the true temperature) proposed for tungsten. Each of these appeared to be faulty in one respect or another in comparison with that reported in Table 2. As a consequence thereof, these results have been accepted by the laboratories of the General Electric Co. as their temperature scale for tungsten.

For other methods for determining emissive powers, reference should be made to papers by Langmuir,<sup>36</sup> Shackelford,<sup>37</sup> Hulburt,<sup>38</sup> and Weniger and Pfund.<sup>39</sup> In Langmuir's work the emissive power of molten tungsten was determined from the brightness of the images of opposing electrodes

<sup>35</sup> Pirani: *Phys. Zeit.* (1912) **13**, 753.

Mendenhall and Forsythe: *Astrophys. Jnl.* (1913) **37**, 380.

Pirani and Meyer: *Elektrotech. u. Masch.* (1915) **33**, 397, 414.

Langmuir, *Phys. Rev.* [2] (1915) **6**, 138 and (1916) **7**, 302.

<sup>36</sup> *Phys. Rev.* [2] (1915) **6**, 183.

<sup>37</sup> *Phys. Rev.* [2] (1916) **8**, 470.

<sup>38</sup> *Astrophys. Jnl.* (1917) **45**, 149.

<sup>39</sup> *Jnl. Frank. Inst.* (1917) **183**, 354

392 EMISSIVE POWERS AND TEMPERATURES OF NON-BLACK BODIES

in a tungsten arc. The main difficulty with this method lay in the temperature variations across the arc terminal and in the extraneous brightness, due to the arc proper. Shackelford, using helical tungsten coils of varying pitch, determined with the aid of a disappearing-filament pyrometer the ratio of the external brightness to the maximum internal helix brightness and extrapolated to the case of a closed cylinder to obtain emissive powers. In theory, the method is very nice, though one is not inclined to give such results, when unsupported, the full confidence they deserve. The actual values obtained agreed well with those reported by the writer. Hulburt worked in the ultra-violet region and used the photo-electric effect of such radiations. Comparisons were made directly with a black body operated at the palladium point. Temperatures of the tungsten filament were obtained from other work. The actual values of emissive power depend considerably on the accuracy of this temperature. Weniger and Pfund have worked in the infra-red region of the spectrum. They measured the reflectivities of tungsten for various wave-lengths directly. From Kirchhoff's law, it follows at once that unity less the measured reflectivities give the corresponding emissive powers. Their results slightly extrapolated as to temperature have been used in computing the infra-red parts of curve *a*, Fig. 1, in which is given the spectral radiant flux distribution for a vacuum tungsten lamp at its normal operating temperature.

TABLE 2.—*Emissive Power and Allied Data for Tungsten*

| <i>T</i><br>Degrees K. | $\epsilon_{0.612\mu}$ | <i>S</i><br>0.612μ<br>Degrees K. | $\epsilon_{0.447\mu}$ | <i>T</i><br>(0.447μ, 0.612μ)<br>Degrees K. | $\epsilon'$<br>(0.447μ, 0.612μ) | <i>T</i> † |
|------------------------|-----------------------|----------------------------------|-----------------------|--|---------------------------------|------------|
| 1200                   | 0.458                 | 1150                             | 0.493                 | 1211                                       | 0.391                           |            |
| 1600                   | 0.448                 | 1510                             | 0.484                 | 1620                                       | 0.380                           | 1611       |
| 2000                   | 0.438                 | 1858                             | 0.474                 | 2032                                       | 0.370                           | 2031       |
| 2400                   | 0.429                 | 2193                             | 0.465                 | 2448                                       | 0.360                           | 2442       |
| 2800                   | 0.419                 | 2516                             | 0.455                 | 2868                                       | 0.350                           |            |
| 3200                   | 0.409                 | 2826                             | 0.446                 | 3292                                       | 0.340                           |            |
| 3600                   | 0.399                 | 3121                             | 0.436                 | 3720                                       | 0.329                           |            |
| 3675*                  | 0.398                 | 3176                             | 0.435                 | 3800                                       | 0.328                           |            |

\* Melting point.

† Measurements using integral color match method, according to Hyde, Cady and Forsythe.

The method of employing emissive power, or the brightness-temperature true-temperature relation, in determining true temperature when once the brightness temperature is obtained is obvious. For example, suppose it is desired to find the true temperature of tungsten at its melting point. Suppose, as in Table 2, that 3176° K. is the observed brightness temperature of just molten tungsten, the use of a table or a plat

giving  $T - S$  or  $\epsilon_\lambda$  as a function of  $S$  leads either directly, or through equation (21), to  $3674^\circ \text{K}$ .

*Variations in Emissive Powers of Substances.*—There are many possible types of variation of which only three will be considered here; viz., variation with wave-length, temperature, and angle of emission. Data referring to certain of these, particularly that due to temperature, have already been given at least in part.

One of the most fruitful works relating to emissive power variations was the derivation based on Maxwell's theory which was obtained by Drude. It is

$$\epsilon_\lambda = \text{const.} \sqrt{\frac{\rho}{\lambda}} \quad (25)$$

where  $\rho$  is the resistivity of the material and  $\lambda$  the wave-length. When  $\rho$  is measured in ohm cm. and  $\lambda$  in  $\mu$ , the constant is numerically equal to 0.365. This equation has been subjected to a very great number of tests, most of which have referred to measurements at moderate temperatures. However, measurements at high temperatures have been made; particularly, the works of Hagen and Rubens,<sup>40</sup> McCauley,<sup>41</sup> Weniger and Pfund<sup>42</sup> may be referred to. Generally speaking, this law which applies to a temperature variation as well as a wave-length variation has been found satisfactorily fulfilled at long wave-lengths, usually those far in the infra-red, beyond  $14\mu$  for silver, beyond about  $2\mu$  for tungsten. Deviations from this law, as one proceeds from this region to the near infra-red, have usually, if not always, become greater and greater. In the near infra-red and the visible, the formula generally fails completely, the variation with temperature being often in the opposite direction from what might be expected, as is shown by the results on platinum and tungsten already quoted. Theories of atomic structure have been productive in explaining these variations, but no completely satisfactory working theory for this region of failure of equation (25) has yet been developed.

The question of selectivity of radiation, a question of very great practical interest to incandescent-lamp manufacturers, is in a broad way likewise connected with spectral emissive powers. By saying that a body radiates selectively, we mean that its spectral radiant-flux distribution for a given temperature is different from that for a black body at the same temperature. A direct method of testing a substance for selectivity would be to compare its spectral radiant-flux curve with that for a black body at the same temperature. Thus we might compare curve  $a$ , Fig. 1, with curve  $b$ . If in so doing we should arbitrarily plot the data represented by curve  $a$  in such a fashion that it coincides with curve  $b$  at one point, let us say  $0.7\mu$ , we should find that the two curves

<sup>40</sup> *Ann. Phys.* (1903) 11, 888.    <sup>41</sup> *Astrophys. Jnl.* (1913) 37, 164.    <sup>42</sup> *Loc. cit.*

would not continue to coincide throughout the whole range of wave-length. We should find, in fact, that for wave-lengths shorter than  $0.7\mu$  the curve for tungsten would lie everywhere above the curve for the black body, and that for wave-lengths greater than  $0.7\mu$  the curve for the tungsten radiation would lie everywhere below that for a black body. In general, the discrepancy, expressed in per cent., would become greater and

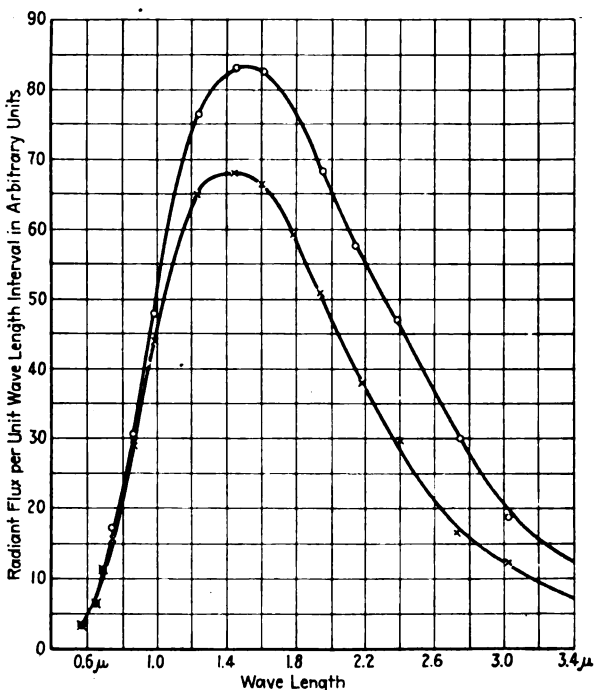

FIG. 11.—SPECTRAL RADIANT FLUX CURVES FOR TUNGSTEN, X, AND CARBON, O, AT A COLOR TEMPERATURE OF APPROXIMATELY  $2200^{\circ}$  K. ACCORDING TO COBLENTZ.

greater the further we get from the arbitrarily chosen wave-length  $0.7\mu$ . While such a method of comparing substances is the most direct, it generally entails a great amount of work and has seemed practically impossible in some cases.

There is another method, much more convenient, dependent on the possibility of color-matching various light sources, a method that seems first to have been employed by Morris, Stroud, and Ellis.<sup>43</sup> The method has been developed independently by Hyde and others<sup>44</sup> in a much

<sup>43</sup> *Elec.* (1907) **59**, 584 and 624.

<sup>44</sup> Hyde: *Phys. Rev.* (1908) **27**, 521; *Astrophys. Jnl.* (1912) **36**, 89.

Hyde, Cady and Middlekauff: *Trans. Ill. Engng. Soc.* (1909) **4**, 334.

Hyde: *Jnl. Frank. Inst.* (1910) **169**, 439; (1910) **170**, 26.

Hyde, Cady and Forsythe: *Phys. Rev.* [2] (1917) **10**, 395.

more far-reaching way. Data obtained by them for various light sources are shown in Table 3, in which  $k$  represents the ratio of the relative change in candlepower  $I$  to the accompanying relative change in wattage  $W$  for the source studied. It is to be noted that proceeding down the table there is a like progressive change in this quantity  $K$  as well as in the efficiency. Both of these quantities may be used in determining selectivities. In particular, values of efficiency are of interest in that they show in a very direct and convenient manner how the different sources differ in their methods of radiating energy. In order that two sources shall have the same distribution throughout the visible spectrum and have different efficiencies, there necessarily must be a difference in the infra-red distribution. Exactly what this is like for the case of carbon and tungsten is well shown in Fig. 11, taken from a paper by Coblentz. In his work, the color temperature seems to have been somewhere in the neighborhood of 2200° K. Taking account of the results given in Table 3, we should expect that the ratio of the areas included under these curves should be about  $\frac{3.5}{4.4}$  or 0.80. This is fairly closely 0.76, the value actually obtained. Just how data of this type are valuable to the lamp industries is perfectly evident. The table shows a good

TABLE 3.—Radiating Selectivities of Various Sources at Two Color Temperatures, according to Hyde

| Source                   | $T_c = 1700^\circ \text{ K.}, \text{ approximately. } T_s = 2160^\circ \text{ K.}, \text{ approximately}$ |                            |
|--------------------------|---|----------------------------|
|                          | $K = \frac{dI}{I} / \frac{dW}{W}$   | Efficiency in lumens watts |
| Black body observed..... | 3.50  |                            |
| Black body computed..... | 3.60  | ....                       |
| Untreated carbon.....    | 3.45  | 0.39                       |
| Flashed carbon.....      | 3.35  | 0.41                       |
| Graphitized carbon.....  | 3.40  | 0.41                       |
| Platinum.....            | 3.10  |                            |
| Tantalum.....            | 3.00  | 0.50                       |
| Tungsten.....            | 2.85  | 0.59                       |
| Osmium.....              | 2.85  | 0.72                       |

reason (not the only one) for the transition that has actually occurred in incandescent lamps from the use of untreated carbon to flashed carbon, to graphitized carbon, to tantalum, and finally to tungsten. The fact that there has not been a further change to osmium is a consequence of

### 396 EMISSIVE POWERS AND TEMPERATURES OF NON-BLACK BODIES

other properties (particularly the rate of vaporization), which osmium possesses to a less favorable extent than does tungsten.

From the standpoint of emissive powers, a favorable selectivity means that the emissive powers of the substance in the visible spectrum are, on the average, greater than the average emissive powers in the infra-red spectrum; and, on the whole, the greater the favorable selectivity from the light production point of view the greater is this difference between the average emissive powers.

Another variation of emissive powers that has been but little studied, but which may be of considerable importance, is that which occurs with a change in the angle of emission of radiation. The cosine law of emission, the standard by which these variations are measured, was first enunciated

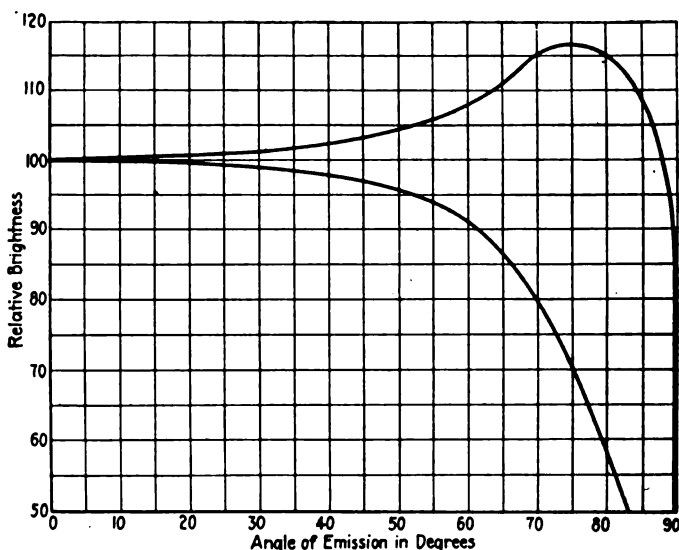

FIG. 12.—VARIATION IN BRIGHTNESS OF TUNGSTEN (UPPER CURVE) AND OF CARBON (LOWER CURVE) WITH ANGLE OF EMISSION.

by Lambert. It states that the luminous intensity, or candlepower, of an element of source varies as the cosine of the angle of emission; a consequence of the fact that the element of source when viewed at greater and greater angles of emission is smaller in proportion to the cosine of the angle. Wherever the cosine law is fulfilled, a source appears equally bright from all directions. Quantitative measurements relating to the fulfillment of Lambert's law seem first to have been made by Moller.<sup>45</sup> He investigated the light emitted by a glowing strip of platinum and con-

<sup>45</sup> *Ann. Phys.* (1885) 24, 266.

cluded from his measurements that the cosine law of emission was fulfilled. Later Uljanin,<sup>46</sup> as a result of computation and measurement, concluded that the law was not fulfilled for platinum, but that for certain wave-lengths in the infra-red there was an increase from the normal brightness for a zero angle of emission to 1.17 times the normal brightness for an angle of 70° decreasing at somewhat larger angles. The writer<sup>47</sup> has also made measurements of this kind on tungsten and carbon at incandescent temperatures. Inasmuch as these results represent, so far as the writer knows, the extremes of variation found as well as representing a use of the optical pyrometer, the results obtained are given in Fig. 12. It is to be noticed in this connection that the brightness of tungsten, viewed at an angle of 75°, for the temperature considered is about 17 per cent. greater than the brightness viewed normally. With increase of the angle beyond this, there occurred a more or less gradual diminution in brightness to a zero value at 90°. For carbon, on the other hand, a gradual falling off in brightness with increasing angles of emission was observed, even at small angles of emission. Using the data given in the figure, it is easy to show, by computation, that the average brightness of tungsten, taking into account the light emitted in all directions, is a trifle more than 5 per cent. greater than the brightness viewed normally. What has been said very definitely shows the importance in all optical pyrometric measurements of noting whether observations are made normally on the material studied, or if not, at what angles of emission they are made.

#### PSEUDO-EMISSIVE POWER DEPENDING ON COLOR OF AN INCANDESCENT BODY

The possibility of color-matching various light sources already mentioned leads to the consideration of a pseudo-emissive power. Consider in this connection, curves *a* and *c*, of Fig. 2, which represent the spectral brightness distribution of tungsten at 2450° K. and a black body at 2500° K. at which temperatures such a color match exists, a condition summarized by saying that the color temperature of tungsten at 2450° K. is 2500° K. Naturally, it follows that everywhere through the visible spectrum the ratio of the spectral brightnesses, whatever the wave-length, is constant and therefore the same as for the total luminous flux. This ratio, as can be readily verified, is quite closely 0.358. It represents a pseudo-emissive power. Representing by *T*, as before, the true temperature of the tungsten filament, by  $T_{c(\lambda_1\lambda_2)}$  its color temperature, 2500° K. in the case noted above, by  $\epsilon_\lambda$  and by  $\epsilon'$  the spectral emissive power and the pseudoemissive power, and by  $\lambda_1$  and  $\lambda_2$  two arbitrarily chosen wave-lengths, we have, following the applications of Wien's equation,

<sup>46</sup> *Ann. Phys.* (1897) **62**, 528.

<sup>47</sup> *Astrophys. Jnl.* (1912) **36**, 345.



$$\epsilon_{\lambda_1} e^{-\frac{c_2}{\lambda_1 T}} = \epsilon'_{(\lambda_1 \lambda_2)} e^{-\frac{c_2}{\lambda_1 T_c(\lambda_1 \lambda_2)}} \quad (25)$$

and

$$\epsilon_{\lambda_2} e^{-\frac{c_2}{\lambda_2 T}} = \epsilon'_{(\lambda_1 \lambda_2)} e^{-\frac{c_2}{\lambda_2 T_c(\lambda_1 \lambda_2)}} \quad (26)$$

whence by elimination of  $\epsilon'_{(\lambda_1 \lambda_2)}$  we have

$$\frac{1}{T_c(\lambda_1 \lambda_2)} = \frac{1}{T} \frac{\ln \frac{\epsilon_{\lambda_1}}{\epsilon_{\lambda_2}}}{c_2 \left( \frac{1}{\lambda_1} - \frac{1}{\lambda_2} \right)} \quad (27)$$

From this equation, we may compute the color temperature as a function of the true temperature from such data as are given in Fig. 10. Provided the true temperature scale of tungsten is known, this relation may also be determined by a direct comparison of tungsten with a black body in which the integral luminous flux is used. This has been done by Hyde, Cady and Forsythe.<sup>48</sup> How well the two methods agree is shown by a comparison of the fifth and seventh columns of Table 2. It should be noted that these results refer to tungsten and not to tungsten lamps. The principal difference is due to the cooling effects in the neighborhood of junctions and supports and the selective absorption of the glass bulb that occur in lamps. The variation of  $\epsilon'_{\lambda_1 \lambda_2}$  with temperature for tungsten as computed by means of equations (25), (26), and (27) is also shown in Fig. 10 in connection with the true emissive powers. For the relation between brightness, color, and true temperature for tungsten lamps, reference must be made to the paper by Hyde, Cady, and Forsythe.

A method of determining variations in pseudo-emissive powers that holds rigidly in case absolute color matches exist between the radiating source and a black body at appropriate temperatures makes application of what Hyde<sup>49</sup> has called criterion 1 in his synthetic development of radiation laws. In case a rigid color match cannot be obtained, the variations obtained in the pseudo-emissive powers may be only approximate. The fulfillment of the criterion requires that, when a radiating source and a black body are raised from one condition of color match to another color match, the relative increases in luminous intensity, or candlepower, shall be the same. To within experimental errors, he found that this criterion was fulfilled in the radiation from carbon and from tantalum. In the case of tungsten, however, he found that the criterion was not fulfilled. In going from a color temperature of about 1740° K. to another of about 2130° K. there was found a lack of fulfillment amounting to 3.7 per cent. This means that, when tungsten is raised from color temperature 1740° K. to color temperature 2130° K., the relative change in candlepower is only 96.3 per cent of the corresponding change in the candlepower of a black body raised through the same tem-

<sup>48</sup> *Loc. cit.*

<sup>49</sup> *Astrophys. Jnl.* (1912) **36**, 89.

perature range. A comparison of this result with what is given in Table 2 indicates a moderately good agreement. From the data given in the sixth column, one would expect instead of 96.3 per cent. something like 0.367 or 97.6 per cent. How much of this difference may be ascribed to experimental error and how much to an inability to obtain a perfect color match is of course uncertain. The agreement, everything considered, is quite satisfactory and the method may be looked upon as one of considerable value in studying other substances.

#### CONCLUSION

In conclusion, it may be said that a knowledge of the temperature relation for non-black bodies is necessary if industrial processes and products are to be satisfactorily described and standardized; that the true temperature in a broad way is the reasonable basis on which to coordinate such data; that a study of emissive powers total, spectral and pseudo, or of the radiation-temperature true-temperature, brightness-temperature true-temperature or color-temperature true-temperature relations represents in many cases our only means of measuring high true temperatures; and that therefore a study of these relations is of the highest commercial as well as scientific significance.

## Recording Thermocouple Pyrometers

BY LEO BEHR,\* M. E., PHILADELPHIA, PA.

(Chicago Meeting, September, 1919)

RECENT years have seen important practical advances in the construction of recording instruments for use with thermocouples. The difficulties of the problem will be appreciated when it is remembered that a 10° F. change in temperature of a base-metal couple at 1500° means a change in the electromotive force of about 0.00035 volt. In a circuit having a resistance of 350 ohms, this means a change in the current of 0.000001 amp.; and despite this requirement of great sensitivity the instruments must be sufficiently robust to withstand the rough usage which is so often their lot.

Two methods are in common use for the measurement of the electromotive force produced by a thermocouple:

1. The milliammeter method, in which the current produced by the thermocouple in a circuit of known resistance is measured and from this the electromotive force is deduced by Ohm's law.

2. The potentiometer method in which a known potential difference is opposed to the thermocouple electromotive force.

The use of thermocouple and milliammeter for measuring temperature introduces some possible sources of error, for the reading depends on a number of factors, including the following: (1) Electromotive force set up at the hot junction, (2) electromotive force set up at the cold junction, (3) resistance of the circuit including thermocouple, lead wires, and meter, (4) field strength of magnets, (5) strength of controlling springs in meter, (6) friction at pivots, of pointer on paper, etc.

It is obviously necessary to so design and maintain the installation that the reading is independent of all the factors except the first. The electromotive force set up at the cold junction can easily be taken care of provided it is constant. This has been approximately accomplished by burying the cold junction in the ground or actually secured by locating it in a container, the temperature of which is kept constant by means of a thermostat.

A more flexible arrangement and one requiring less attention from the user is to incorporate some automatic cold-junction temperature compensator in the recording instrument. The installation of the pyrometer

---

\* Research Engineer, Leeds & Northrup Co.

is then reduced to merely connecting the thermocouple terminals to the recorder. Numerous schemes for automatic cold-junction compensation have been proposed. These consist essentially of resistances shunted around the meter or in series with it. These resistances are supposed to be so affected by a change in temperature at the cold end as to properly compensate for such changes by varying the amount of the total current passing through the meter. A consideration of Ohm's law, however, shows that any arrangement that consists solely of resistances can satisfactorily compensate for variations in the cold-junction temperature for only a limited range of temperatures at the hot end, for any such arrangement can merely fix a ratio between the currents for different cold-end temperatures instead of changing the current by an additive constant.

A device that permits of accurate compensation is shown in Fig. 1. It consists of a Wheatstone bridge network in series with the thermocouple, one arm of the bridge is of nickel and is located at the cold end of the thermocouple. The remaining arms  $R_1$ ,  $R_2$ , and  $R_3$  are of manganin and are located in the meter. The variable resistance  $R$  is so adjusted that the pyrometer reads the temperature of the cold end with the thermocouple out of circuit and the leads connected together. Changes in temperature of the nickel coil vary its resistance and determine the extent of unbalance of the Wheatstone bridge and, therefore, the amount of current added to the thermocouple circuit. If the thermocouple leads are extended to the meter, it is desirable to make  $R_2$  also of nickel because the current drawn from the storage battery  $B$  may then be reduced.

Probably the most insidious source of error is the change in resistance of the circuit containing the thermocouple, lead wires, and meter. All joints that are not welded or soldered are possible sources of trouble because, in time, they will corrode or work loose. If a central-station installation is in use, the resistance of all the thermocouple circuits should be equal and the switches must be kept scrupulously clean. The change in the resistance of the thermocouple through oxidation is a source of error that does not make its presence evident but gradually increases the amount of error. The percentage error in the temperature reading is directly proportional to the change in resistance and inversely proportional to the total resistance. The designer can reduce this

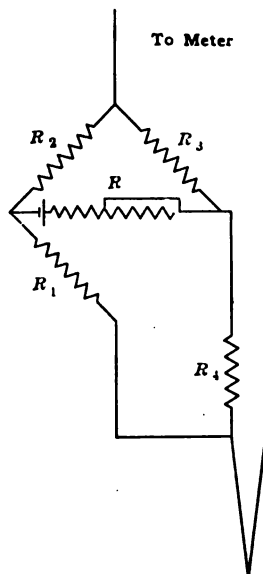

FIG. 1.—DEVICE PERMITTING ACCURATE COMPENSATION FOR TEMPERATURE CHANGES.

error by increasing the total resistance in the circuit. Such an increase in resistance decreases the current for a given temperature and a more sensitive and, therefore, essentially less robust meter element results. The meters are generally designed to operate on circuits of 300 to 400 ohms.

The temperature coefficient of the meters is a summation effect of the temperature coefficients of resistance of the coils and the strength of the magnets and springs. The springs are weaker at higher temperatures while the magnets may be either weaker or stronger. The copper coil

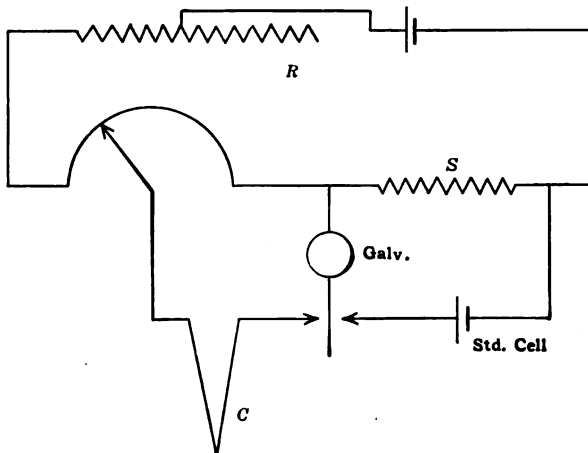

FIG. 2.—SIMPLE POTENTIOMETER CIRCUIT.

of the moving system is in series with a coil of small temperature coefficient and their combined temperature coefficient is of the order of 0.05 per cent. per degree Fahrenheit or more. Among the methods used to compensate for the change in sensitivity of the meter may be mentioned the use of a mercury column to short-circuit a resistance and a compound metallic strip to change the field strength.

On account of the small forces used to turn the pointer, friction of the moving element must be reduced to a minimum by careful design and construction of the pivots and pen. The meter case must be dust-proof, because even the most minute particles of dirt on the pivots is sufficient to give trouble. There are several devices for reducing pen friction. The one in most general use is that of having the pen touch the paper intermittently so that the moving system is entirely free from the paper part of the time and able to assume its equilibrium position without being affected by friction on the chart.

In the potentiometer recorder, the electromotive force of the couple is opposed to the potential drop across a known variable resistance through which a definite current is flowing.

The simple potentiometer circuit is shown in Fig. 2. The current in the circuit is adjusted to a predetermined value by means of the battery regulating rheostat  $R$  until the voltage drop across the resistance  $S$  is equal to the electromotive force of the standard cell. The electromotive force of the couple  $C$  is measured by opposing it to the potential drop along a length of the slide wire. A balance is reached when the galvanometer stands at zero, at which time no current is drawn from the thermocouple circuit and therefore a change in resistance produces no error. Before balance, the extent and direction of unbalance is indicated by the galvanometer deflection.

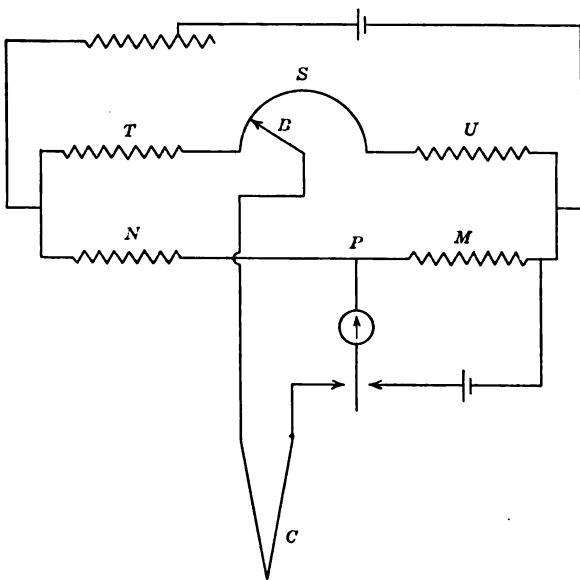

FIG. 3.—SPLIT-CIRCUIT POTENTIOMETER.

The change in temperature at the cold junction can be compensated for by the use of a "split circuit" potentiometer. In Fig. 3,  $T$ ,  $U$ , and  $M$  are fixed resistances of manganin,  $S$  is a slide wire, and  $N$  is a nickel coil the resistance of which is a function of the temperature. As before, a standard current is obtained by adjusting the regulating rheostat until the drop across  $M$  is equal to the electromotive force of the standard cell. The potential difference opposed to the couple  $C$  is that from  $P$  to the brush  $B$  on slide wire  $S$ . For a fixed temperature at the hot end, any changes in the cold-end temperature will be accompanied by a change in the resistance of  $N$ . This in effect moves  $P$  electrically an amount just sufficient to compensate for the change in the electromotive force so that the position of  $B$ , and therefore the temperature reading, is independent

of the cold-junction temperature. This compensation for cold-junction temperature is correct for all values of hot-junction temperature.

The problem in constructing a recording potentiometer lay in devising a mechanism capable of rotating a slide wire in a definite manner according to the indications of a galvanometer. Such instruments have been constructed in which the galvanometer pointer, when it deflected, closed a circuit, which started a brush moving over the slide wire. This construction has always given trouble due to overshooting as the speed of the brush is not dependent on the amount of unbalance and, moreover, the small force available for producing a contact with the galvanometer

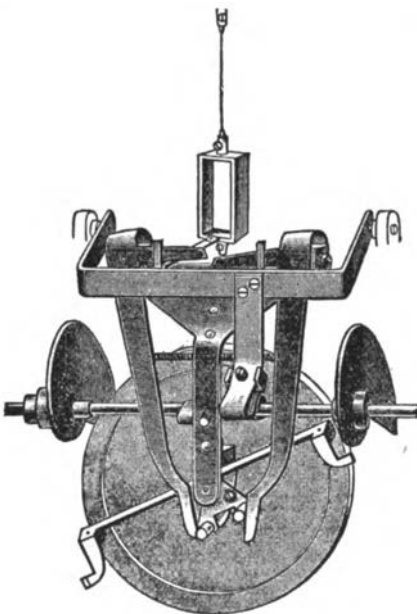

FIG. 4.—MECHANISM UNBALANCED.

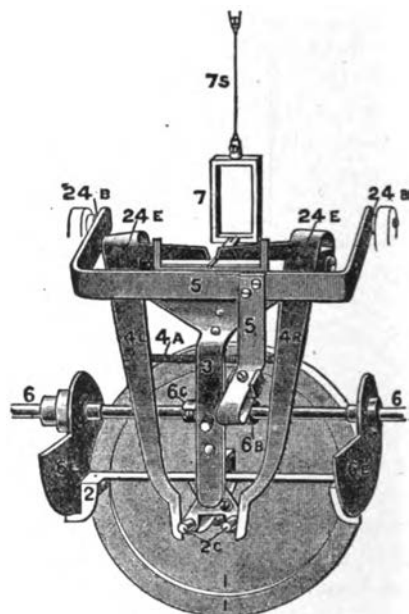

FIG. 5.—MECHANISM BALANCED.

BALANCING MECHANISM OF POTENTIOMETER RECORDER.

pointer does not always insure the necessary electrical circuit. The mechanism finally devised to solve this problem is rather interesting and its general features will be described.

As shown in Figs. 4 and 5, the position of the galvanometer indicates in which direction and to what extent the potentiometer is out of balance. When the measuring circuit is balanced, the pointer is, as in Fig. 5, directly under the space between the two right-angle levers  $4L$  and  $4R$  which are pivoted at  $24E$ . When the potentiometer circuit is out of balance, the galvanometer pointer will move under the horizontal arm of  $4L$  or  $4R$ . The rocker-arm  $5$  is pivoted at  $24B$  and is periodically raised by the cam  $6B$  on the motor-driven shaft  $6$ . As the rocker-arm moves upward, it lifts the galvanometer pointer. When the measuring

circuit is balanced the pointer will merely be raised into the space between  $4L$  and  $4R$ . If, however, the measuring circuit is unbalanced and the galvanometer is under  $4L$ , for instance, the resultant position of the parts is as shown in Fig. 4. As the galvanometer pointer is now raised by the rocker-arm it rotates  $4L$  about the pivot  $24E$ . This motion is transmitted to the horizontal lever  $2$ , which is rotated in a counter-clockwise direction by the action of the lower extremity of  $4L$  on the pin  $2C$ . At the completion of this motion, the lever  $2$  is forced into contact with disk  $1$  through the action of the cam  $6C$ . The cam  $6E$  is attached to the shaft  $6$  and rotates with it. The shape of the cams is such that they return the lever  $2$  to its horizontal position. In this particular case the lever  $2$  and the disk  $1$  with which the former is now engaged must both rotate in a clockwise direction. The power required for this rotation is obtained from a motor, therefore sufficient can be supplied to balance the measuring circuit, move the recording pen, and operate signals or relays.

The amount of rotation per cycle given to arm  $2$  and disk  $1$  depends on the galvanometer deflection, for as the pointer moves out from its zero position it approaches the fulcrum of  $4L$ . Consequently the rebalancing is large or small according as the unbalance is large or small.

As there is no current flowing in the thermocouple circuit, variations in resistance there have no effect on the accuracy of the meter. As the galvanometer is used as a null instrument, change in the strength of the springs or magnet have no effect on its accuracy. The galvanometer is a suspended instrument; this construction is permissible because the only requirement imposed on the galvanometer is that it has a reasonably stable zero. There is consequently no friction trouble, such as is found in pivot and jewel instruments, and the galvanometer is much more sensitive.

#### DISCUSSION

R. W. NEWCOMB, New York, N. Y. (written discussion\*).—In this paper, the author has enumerated the various sources of error that may, under certain conditions, develop in instruments of the direct-deflection type, but through a failure to mention possible sources of error in instruments of the potentiometer type, he leaves the reader with a wrong impression. If he would carry his criticisms further and give a list of the possible sources of error on potentiometer instruments, the paper would be more complete.

---

\* Received Oct. 15, 1919.



### Recording Pyrometry

BY C. O. FAIRCHILD,\* B. S., AND PAUL D. FOOTE,† PH. D., WASHINGTON, D. C.

(Chicago Meeting, September, 1919)

ONE of the fundamental principles of efficiency is the use of adequate and permanent records. The rapid increase in the manufacture and use of recording pyrometers is a proof of the appreciation of efficiency principles on the part of the manufacturers engaged in the various technical industries. Where recording pyrometers are not employed in an industry in which temperature measurements are necessary, one will generally find that a printed form is used upon which is written, periodically, the temperatures measured by an indicating instrument. It is no serious condemnation of the workman to state that such records are often "doctored," but it is rather a reflection upon the executive who puts such temptation in the way of a workman. One of the well-known "tricks of the trade" is to "force" a furnace so that it will be at the proper temperature during the periodic trips of the foreman or other official.

Indicating instruments and recorders may be used together to great advantage. The recorder furnishes a printed record and a check upon the operator of the furnace, and a record of value in correlating properties of the finished product with the heat treatment. The indicator should be of assistance to the operator in controlling the furnace or oven.

Modern practice requires a temperature-recording instrument that is as simple as possible, rugged, reliable, and sufficiently accurate. Of these qualifications reliability is paramount, particularly in cases where the recorder is used for controlling the temperature automatically. By a reliable instrument is meant one that will run continuously with little attention and with a consistent degree of accuracy. That is, if it is in error by 5 per cent. one day, it must be in error by a like amount on any other day, and not by 2 per cent. or 10 per cent. The earlier forms of recorders were complex and delicate, or mechanically unsatisfactory and inaccurate, and required considerable attention to keep them in operation. Within the past few years, however, the development in the manufacture of temperature-recording devices has been highly satisfactory and many excellent instruments are now available.

The pyrometers that can be made to record automatically fall under

\* Associate Physicist, U. S. Bureau of Standards.

† Physicist, U. S. Bureau of Standards.

the following classifications: (1) Gas, saturated vapor, and liquid thermometers; (2) resistance thermometers; (3) thermoelectric pyrometers; (4) radiation pyrometers.

Of these four types, the thermoelectric pyrometer recorder has the greatest applicability, especially for the higher temperatures at which the first two named are not suitable. The constant-volume, industrial, gas thermometer is successful up to about 400° C. The resistance thermometer is capable of very high accuracy up to 1000° C. At such high temperatures, however, thermocouples are more serviceable since deterioration of the wire from continual heating does not so seriously alter the electromotive force developed by a couple as it does the resistance of a resistance thermometer. Base-metal couples serve satisfactorily up to 1100° C.; and platinum platinum-rhodium couples up to 1500° C., although above 1400° C. it becomes very difficult to protect the couple from contamination by the furnace gases and vapors. Radiation pyrometers are useful at the highest attainable temperatures, but processes in which temperatures greater than 1600° C. are used are not in general subjected to very precise temperature control.

#### FORMS OF TEMPERATURE RECORDS

The most usual form of temperature record is that in which temperature appears as one coördinate and time as the other coördinate. The temperature-time curve drawn on such a record has been called an autographic record. This type of curve is the most easily obtained mechanically and is valuable as a continuous record of the temperature of a furnace over a prolonged run. It is also occasionally used to detect transformation points in steel, which appear as flexures or indentations on the plot when the furnace containing the sample is uniformly heated or cooled. For this latter work, however, the "differential temperature" curve recorder is especially adapted and will be described later. Other types of curves obtained with special recorders, and used mainly for laboratory work, are the temperature-rate curve, the inverse-rate curve, and the derived differential curve. The various special methods have been discussed by Burgess<sup>1</sup> and will not be considered in the present paper.

#### GENERAL TYPES OF THERMOCOUPLE RECORDERS FOR TEMPERATURE-TIME CURVES

A recorder for obtaining a temperature-time curve consists essentially of an electrical measuring instrument with a mechanism for periodically

<sup>1</sup> U. S. Bureau of Standards *Sci. Paper* 99.

recording its indications upon a chart that moves with a uniform speed. As in the case of simple indicators, there are two general types of recorders, one operating on the galvanometric principle and one operating on the potentiometric principle. Also, as in the case of indicating instruments, the potentiometric principle while somewhat more complicated has the especially desirable feature that its indications are independent of the thermocouple resistance. The readings of a recorder operating on the galvanometric principle depend on the variations in the resistance of the external electric circuit, although the effect of these variations can be reduced by using an instrument of high internal resistance or, with less satisfaction, by keeping the resistance of the external circuit very low. In many of the recorders now obtainable the resistance is sufficiently high so that these effects become of little practical importance.<sup>2</sup>

### RECORD CHARTS

There are three types of record paper in general use, the roll charts and drum charts shown in Fig. 1, and the disk or circular charts, shown in Fig. 2. The roll chart may contain enough paper to last a month or more while usually the drum or circular charts are renewed every 24 hr. For single-point recorders, all of these forms are employed; but, with one or two exceptions, multiple-point recorders use record paper in the roll form.

Upon circular charts, the lines of equal temperature (time coördinates) are represented by concentric circles, and lines of equal time (temperature coördinates) by arcs following the course of the galvanometer pointer. The distorted appearance of such a record is at first somewhat confusing but, with practice, the record is easily read even when the complete curve is allowed to extend around the chart for several revolutions. If an extended and open temperature scale is required, the disk record becomes somewhat unsatisfactory on account of its size, since the diameter of the circular sheet must be more than twice the width of the temperature scale. The necessity of opening the recorder case, usually every 24 hr., to mount a new record sheet means greater liability for an accumulation of dust which, in the cheaper forms of recorders, becomes a really serious factor.

In filing records for future reference, the circular and drum type one-day records offer some advantage over the continuous roll records, although the latter may be cut to any convenient length when removed from the recorder. With the drum and roll records, the coördinates can be made rectangular. In some cases, however, the temperature coördi-

---

<sup>2</sup> The requirement of high resistance is discussed by Foote, Harrison and Fairchild: *Met. & Chem. Engrg.* (1918) 18, 404.

nates are parts of a circle, as shown in Fig. 1 where the radius of the circle is the length of the galvanometer needle. The roll record is

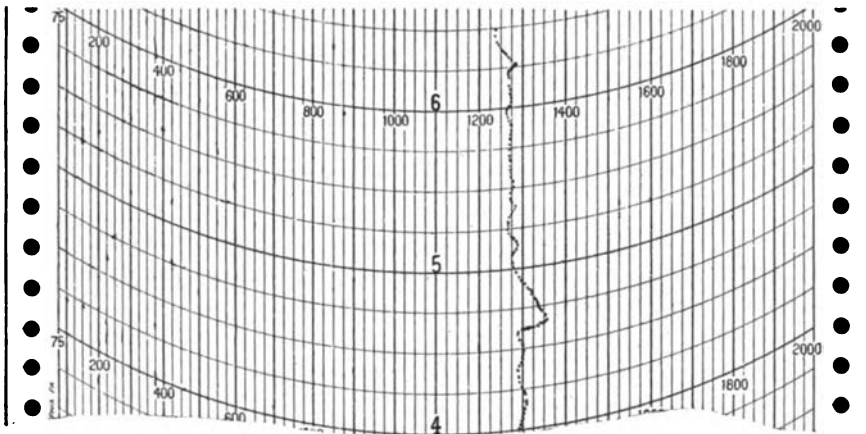

FIG. 1.—ROLL OR DRUM CHART.

particularly adapted to multiple-point recording and for adjusting to very slow or very rapid record speeds.

The methods by which the printing of the record is accomplished will be described in the discussion of the various instruments. The record

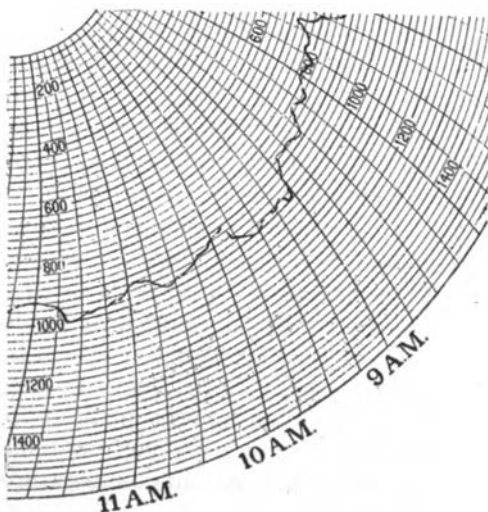

FIG. 2.—DISK CHART.

may be obtained by pen and ink, stylus and inked ribbon, inked thread, carbon paper or coated paper; by puncturing the record paper by means

of an electric spark; or by stamping upon the record sheet some imprint from a stencil. The difficulty in making several distinct records upon the same chart, required by a multiple-point recorder, has been met in various ways, but there is still opportunity for development and improvement in this regard. The advantage of a multiple-point recorder for extensive installations is obvious in that, for a small additional cost, the instrument will do the work of several single-point recorders.

#### THERMOCOUPLE RECORDERS OPERATING ON THE GALVANOMETRIC PRINCIPLE

The recording millivoltmeter, or galvanometer, may employ the same galvanometer system used in the portable indicating instruments. A more rugged instrument is desired, however; this ruggedness is obtained by increasing the strength of the springs, boom, coil, and jewel bearings of a pivot instrument, etc. To compensate for the resulting decrease in sensitivity, the density of magnetic flux through the coil may be increased, the number of turns of wire on the moving coil may be increased, and the so-called swamping resistance in series with the moving coil may be decreased. Most indicators have a single magnet while recorders have as many as four or six magnets. A portable instrument would become too heavy with so many magnets. In general, the resistance of a recorder is less than that of an indicator of the same type. On account of the very small electromotive forces developed by thermocouples and on account of the necessity of using a comparatively high resistance in series with the galvanometer coil to minimize the effect of a varying resistance, the torque that can be produced on the moving coil is small. Pivots, suspensions, etc. must be very carefully made and the moving coil must be accurately balanced and so mounted that it swings perfectly free.

The galvanometer pointer cannot be used to trace a legible record directly since the friction between the paper and the pointer would entirely alter the readings. One common method for obtaining the record is illustrated by the Siemens and Halske recorder, shown in Fig. 3. The paper is unwound by clockwork at a uniform speed from a roll. An inked ribbon lies below the paper and above a metal plate. At periodic intervals the chopper bar *B* falls pressing a stylus on the end of the galvanometer boom *N* into contact with the paper and against the ribbon and metal plate underneath. This makes a small dot on the under side of the thin record paper, which shows through from the top as illustrated. The paper is ruled with the proper time and temperature coördinates and the row of dots obtained by continuous operation constitutes the required temperature-time curve. The maximum frequency with which the dots can be recorded depends on the natural period of vibration of the moving coil. In general practice, the dots appear at intervals of 10 to 30 seconds.

This principle is employed in many instruments of American make. The chopper bar may be operated by an electric motor, clockwork, or electromagnet, and the design must be such that the galvanometer boom swings clear of the bar, between the intervals of depression, and such that the depression of the bar against the boom in no way damages the coil mounting. These conditions may be satisfied in pivot, suspension, and combination pivot-suspension systems.

Recorders may be classified according to the type of support employed in mounting the moving coil. The double-pivot support is the most common and was developed for its greater ruggedness and the constancy of sensitivity obtained. The outstanding fault of the double-pivot instruments is the tendency to stick and the failure of the manu-

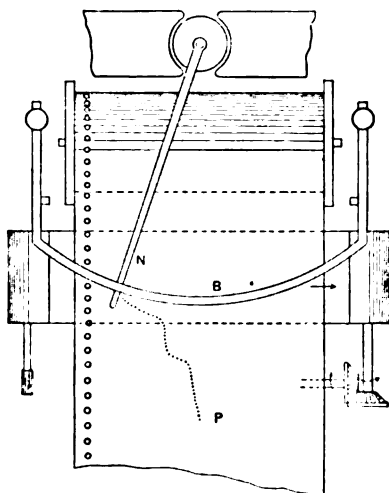

FIG. 3.—PRINCIPLE OF AUTOGRAPHIC RECORDER.

facturers to make them sufficiently dust-proof. An indicator of the double-pivot type may have its moving coil so mounted that the pivots do not center in the jewel bearings but roll around in a small arc over the cup-shaped surface of the bearings. This reduces the friction considerably, but the method is not applicable for recorders, in which the pointer is periodically struck by a bar with sufficient force to move the pivots in their bearings. Unipivot galvanometers are not used for recorders because the moving coil is free to swing in a plane at right angles to the scale and the action of the chopper bar would be to keep the coil in continual vibration.

Unipivot-suspension instruments are not common and are not widely known. The suspension can be made very long and hence comparatively heavy and strong. By crimping the suspension or by supporting it on a spring, a definite fraction of the weight of the moving coil may be taken

from the pivot. The coil requires clamping during shipment and must be mounted in such a way that it will always seat properly if jarred out of the bearing. There is, of course, very little danger of the suspension breaking and this type of construction can be followed in making an instrument of good constancy and sensitivity at relatively low cost.

All the advantages of the foregoing type of galvanometer construction are found in the double suspension, and with the latter a still greater sensitivity and constancy are possible. The coil is mounted so that jarring can move it a very small distance and the spring supports of the suspensions are so made as to allow this amount of motion without undue tension. The coil is usually clamped when the instrument is not in use. This construction is somewhat better in case the recorder is unavoidably subject to jar, the characteristic vibration of the moving part being of shorter period with greater damping. It is still necessary to keep the recorder quite free from vibration, a precaution that should always be taken.

Recorders may also be classified according to their motive power. For most precise movement of the chart, a clock must be used either alone or in conjunction with an electromagnet, which may be applied to do most of the work. The clock alone must be large, and have plenty of power, particularly for multiple-point recorders. The commutators of multiple-point recorders must operate with considerable friction; this is best overcome by means of an electromagnet operated by the clock. The magnet is also used in some instruments to operate the chopper bar. By having the magnet lift a weight with each stroke, it can be used to furnish power for driving the chart; this is done in one of the instruments described below. A motor may be used for the driving power, and by attaching a governor, very satisfactory control of the chart motion is obtained. The motor requires somewhat more attention than a clock, but in some recorders is indispensable.

#### INDUSTRIAL TYPES OF RECORDERS

Foreign designs will not be described, for the writers believe that no foreign-made recorders can compare favorably with the American makes in simplicity of construction, ruggedness, and general applicability for industrial use. The American manufacturers first in the field supplied a need by making a fairly cheap form of single-point recorder, simply made, and sufficiently accurate to be well worth its use. This was done at a time when the imported instruments were expensive; complicated, and only accurate when cared for by an expert.

#### THE CIRCULAR-CHART SINGLE-POINT RECORDER

The circular-chart, single-point recorders are made by Beighlee Electric Co., the Bristol Co., the Brown Instrument Co., and the Hoskins

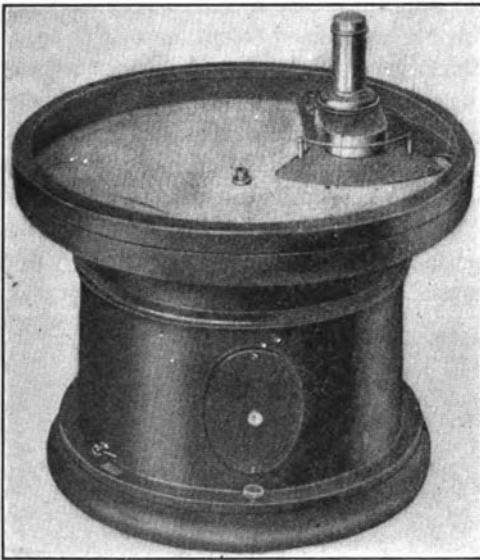

FIG. 4.—BEIGHLEE RECORDER.

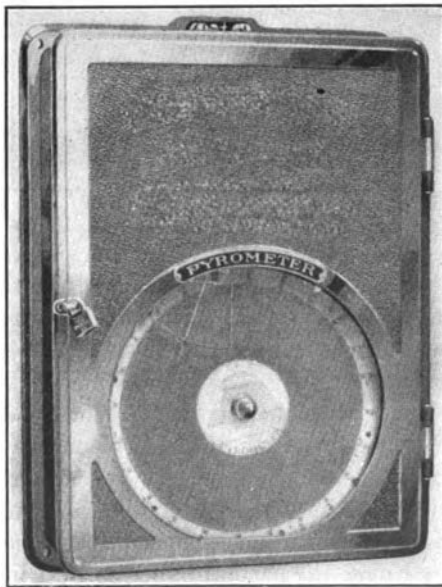

FIG. 5.—BRISTOL RECORDER.



Mfg. Co. Figs. 4 to 6 illustrate the various forms of this type of instrument. With the exception of the Beighlee recorder, Fig. 4, this type is not made for multiple records. Attention might be called to the fact that the time coördinates of the circular-chart recorders are relatively short and thus these charts are unsuited to the measurement of rapidly changing temperatures. They are best suited for furnace or oven operation where a fixed temperature is maintained or desired, or a slow rise or fall, as met with in the ceramic industry and in annealing ovens.

Fig. 6 shows the simple construction of this recorder. The millivoltmeter is mounted on the door so that charts may be renewed without danger of injuring the millivoltmeter pointer. The presser frame is also

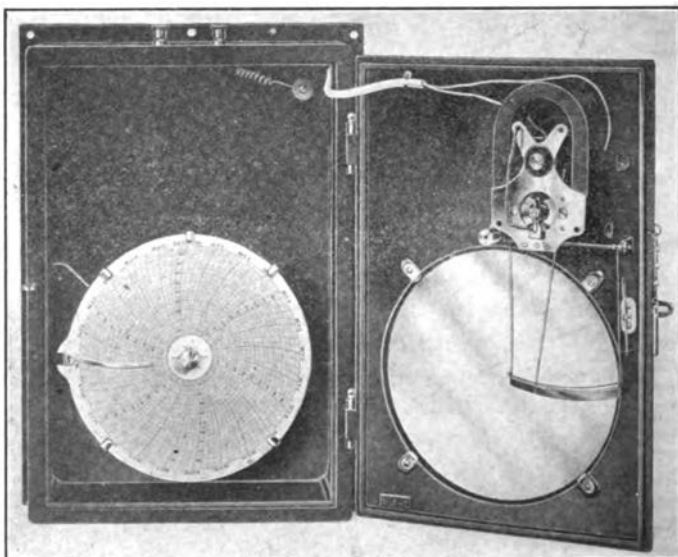

FIG. 6.—BROWN RECORDER.

mounted on the door and is operated by the reciprocating arm shown at the upper left-hand side of the chart. This arm is slowly drawn back by the clock (hidden by chart) against the tension of a spring. Its release throws the presser frame against the pointer and a dot is registered on the chart. The pointer is made flexible; that of the Bristol instrument has a flattened part, which results in a slight rubbing action on the chart, necessary in the use of smoked paper. In Fig. 6 is seen a metal guide extending across the paper just below the point where the record is made. A heavy paper having a slot along this guide is placed underneath the thin paper chart and over the carbon paper so that in changing records the paper is not easily soiled. The small spool seen in the upper right-hand corner is a resistance in series with the moving coil of the meter. One of its purposes is for calibrating the instrument or changing the

temperature range, *e.g.*, to change a range 0 to 1000° to 0 to 1500° the total resistance of the instrument would be increased by approximately 50 per cent. This should not be done with low resistance instruments without also correcting the lead resistance; *i.e.* the correction for range should apply to the entire electric circuit.

The Hoskins millivoltmeter is unique in the fact that the meter is behind the record and the glass window closes flat against the chart, sustaining the pressure of the pointer when the latter is raised by the pressure bar. This construction gives greater convenience in changing records.

The Beighlee recorder is much less simple in construction than the foregoing types. Its distinctive features are: a somewhat more open scale (larger chart), a unipivot-suspension meter, and a unique method of making the record. The pointer is not periodically depressed but swings free with its tip close to the record. Every 30 sec. an electric spark passes from the pointer to the chart plate puncturing the paper. The record is a series of holes with seared edges, which are easily seen. There is a tendency of the spark to jump the gap at an angle, causing a slight error, which, however, is not serious. This instrument is not designed particularly for installation near the furnace, but in an office or central pyrometer station. Its high resistance makes it possible to use very long leads of small wire. The clock is electrically wound and requires no attention except regulation. To accomplish multiple recording with this instrument, the chart is divided into sectors, and if six records are to be made, the chart moves forward slightly more than a sixth of a revolution each  $\frac{1}{2}$  min. The time coördinates are very short and the instrument is adapted in this form only to large furnaces with constant or slowly changing temperatures. It should be used combined with an indicator for controlling temperatures.

The only drum-chart recorder is made by the Stupakoff laboratories. It is the double-pivot type with a high resistance and ordinary scale length. The drum is rotated once in a day or a week. This company also makes a single-point recorder of the roll-chart type. The galvanometer is the double-suspension type with 300 ohms resistance for a 15-millivolt range. In the manufacture of these instruments an effort is made to get the greatest accuracy consistent with the length of scale, and not to furnish an instrument that will stand hard knocks. These instruments should be mounted under cover in a place free from vibration.

#### ROLL-CHART RECORDERS

Roll-chart recorders are made by The Brown Instrument Co., Charles Engelhard, Hoskins Mfg. Co., S. H. Stupakoff,<sup>5</sup>Taylor Instrument Co., Thwing Instrument Co., Wilson-Maeulen Co. The general advantages

of the roll chart are legibility (coördinates are parallel and may be made rectangular), width of scale, and adaptability to rapidly changing temperatures, and the recording of more than one record on a single chart. With a paper speed of 1 in. an hr. a 20-yd. roll will last 1 mo. Rolls are usually furnished in 20-yd. lengths and longer.

Fig. 7 illustrates the Brown continuous recording pyrometer. The fundamental principles of its operation are the same as those of the circular-chart recorders. The scale is nearly twice the width of that on the circular chart. An inked ribbon is extended across the paper under the meter pointer and is slowly changed by the clock. The scale seen above the chart is mounted on the presser bar.

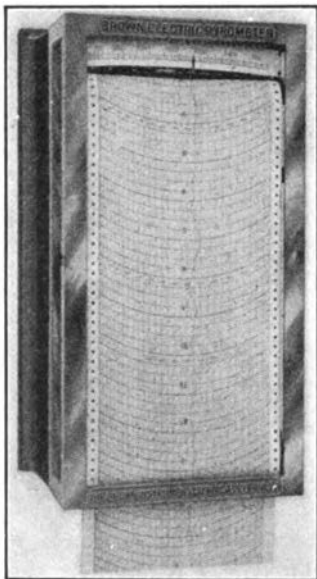

FIG. 7.—BROWN ROLL-CHART RECORDER.

The instrument is not made to record for more than one thermocouple. The Brown multiple recording pyrometer is a multiple-galvanometer double-scale instrument. For taking two to eight records, two millivoltmeters are mounted side by side and two temperature scales are printed on one width of paper. This results in a very narrow chart, limiting the usefulness of the instrument and the accuracy with which the record can be read. It differs from the single-record instrument in having a commutating switch and a multicolored ribbon, both of which are operated by the clock. The latter instrument is sometimes constructed with a galvanometer having a double coil on the one moving system, and is applied for detecting transformation points in steels. This is discussed more in detail in the section on transformation-point indicators.

Charles Engelhard has heretofore handled imported instruments, but has recently developed a recorder of the high-resistance double-suspension type. The chart has rectangular coördinates, and a graduated width of  $4\frac{1}{2}$  in. (11.4 cm.). The resistance is upward of 700 ohms for rare-metal thermocouples.

The Hoskins multiple recording pyrometer, which has been recently developed, is shown with cover and chart removed in Fig. 8. It is made for ten records of base-metal thermocouples. The scale is over 7 in. (17 cm.) wide, the highest range instrument reading to  $2500^{\circ}$  F. ( $1371^{\circ}$  C.). The essential features are an electric drive (*C* is a solenoid arm) and a clock operating only the electric contact device *D*. The motion of the

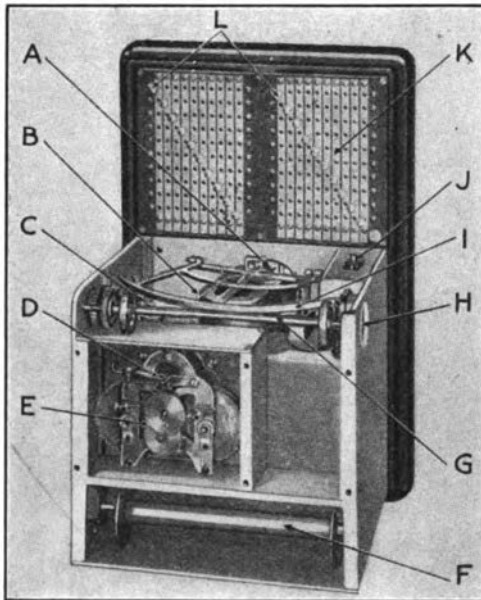

FIG. 8.—HOSKINS RECORDER.

solenoid arm raises the frame *I* (which is depressed in other instruments), changes the commutator or rotary selective switch *H*, and moves the chart a step forward every third contact. Records are made every 20 sec., the change from one couple to the next occurring every minute. Instead of using different colors or symbols for different couples, the chart is divided by parallel lines, between any two of which only one couple records. The spaces are numbered consecutively and the records are distinguished by referring to the parts of the chart in which they fall. This is more clearly seen by pointing out that the selective switch is fastened directly on the shaft *G*, which holds the toothed wheels engaging perforations in the paper chart. A plug switchboard *LK* mounted

within the case is so made that it is possible to arrange the couples in any order, or to put any couple on more than one number. The resistance of the millivoltmeter is 150 to 300 ohms, and it is intended to operate with a fixed lead resistance adjusted to 50 ohms. The high external resistance is selected to take care of compensating leads, the resistance of which is about 0.13 ohm per foot. Calibration can, of course, be made for any external resistance met with in practice.

Fig. 9 illustrates the thread recorder for single records, made by the Taylor Instrument Co. Using an inked thread gives rectangular coördinates.

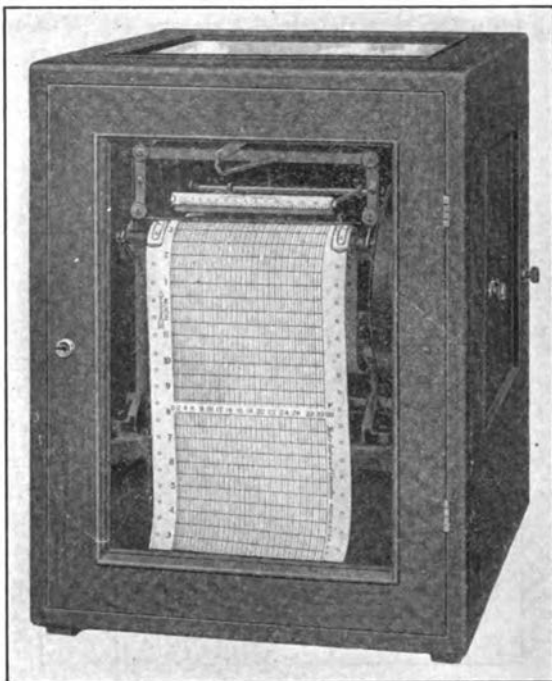

FIG. 9.—THREAD RECORDER.

minates. The illustration shows the ease with which replacements are made over the five small pulleys, one of which keeps the thread taut. The large clock has two parts, one of which moves the chart while the other lifts the depressor frame. The depressor frame or bar is lifted by the clock through a pawl, which engages a slowly turning ratchet. The pawl is tripped out of engagement, allowing the bar to fall pressing the pointer against the thread and record paper. The small resistance plug is a range control series resistance, which allows the employment of two sensitivities.

Figs. 10, 11, and 12 are three views of the multipyrograph, a thread recorder for multiple records. The mechanism is built on a heavy metal

frame that slides in grooves, so that the entire works may be pulled forward for examination and cleaning, etc. The principal additions to the thread recorder are an electromagnet, commutating switch, and index dial showing numbers through the small opening in the left-hand box. The commutating switch is inclosed in the rectangular box below and is connected through the sprocket chain, which is turned in steps by the electromagnet. The switch consists of a row of long flat phosphor-bronze springs with platinum-rhodium contacts. One spring at a time is pressed by a cam, which is properly synchronized with the numbers and

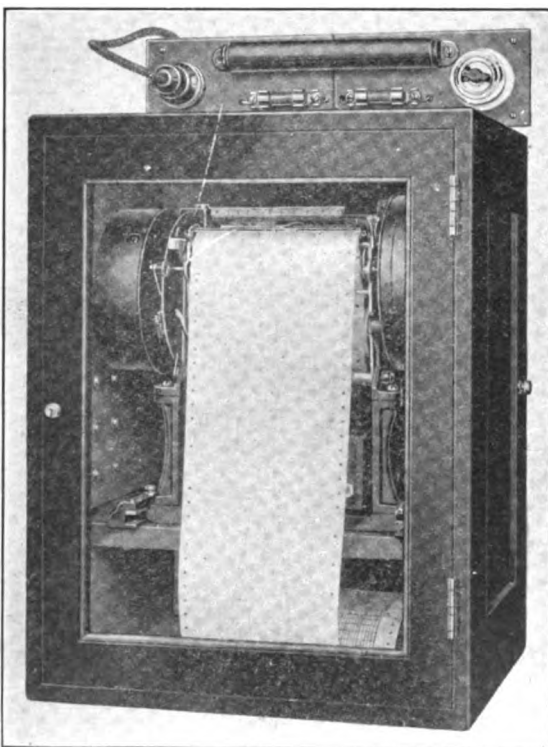

FIG. 10.—MULTIPLE-POINT THREAD RECORDER.

colors of the threads. A wiping action is given the contacts by an offset arrangement, assuring good contact. This principle of a wiping, or sliding, action of contacts is applied quite universally, though only in the better class of recorders are rare-metal contacts used. A high-resistance (500 ohms and more) galvanometer would render unnecessary the assured perfection of contact which is afforded by a wiping action and platinum points.

The clock of this recorder does not require winding, but only provides an escapement for the gradual release of power supplied by the electro-

magnet. The solenoid coil raises a heavy bar, which is retained in the upper position by a pawl catching on a ratchet. The latter is allowed to turn at a uniform rate by the escapement. The motion of the magnet turns the switch cam shaft and operates the depressor arm. The chart is run through the power supplied to the ratchet by the fall of the lifted parts. Electric contact is made every  $\frac{1}{2}$  min., the interval being governed by the position of the pawl, that is the number of ratchet teeth passed during the rise of the magnet.

Three inked threads of different colors are mounted on a frame as shown in Fig. 11, in which the chart rolls are shown lowered into the posi-

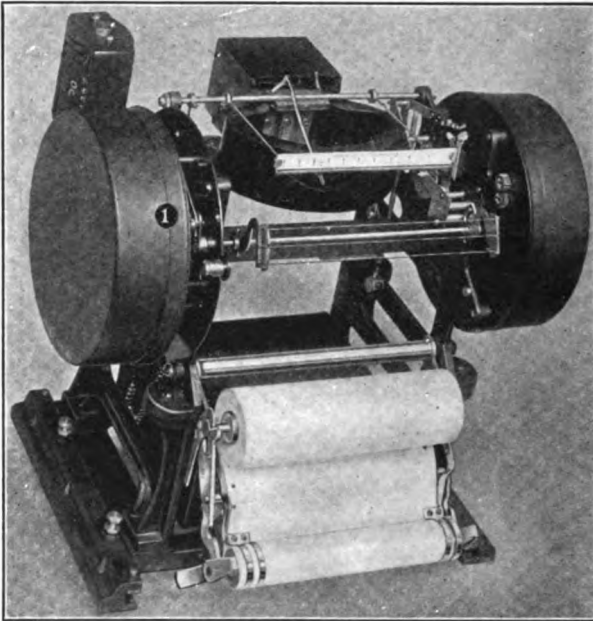

FIG. 11.—MULTIPLE-POINT THREAD RECORDER.

tion for replacement. The threads are brought alternately into positions governed by the commutating mechanism. Six records are obtained by changing the order of records in such a way that three records appear as a line of uniformly spaced dots, and three appear as lines of dots spaced in pairs. The proper selection of numbers will usually keep records of the same color well separated. The moving coil of the millivoltmeter is given additional protection from dust by the casing shown in Fig. 11.

To make this recorder operate on one thermocouple, the couple is connected to the six terminals in parallel. If a record of only one color is

desired the threads may be replaced by three of like color. The scale of the chart is  $4\frac{1}{2}$  in. (11.4 cm.) wide and may be graduated in various ranges of degrees Fahrenheit and centigrade.

The Thwing recording pyrometer is illustrated in Fig. 13, which shows a type making six records with two galvanometers. Records are distinguished on this instrument by making one record of 3-min. dashes, the second of  $1\frac{1}{2}$ -min. dashes, and the third with dots. The cycle requires 7 min., since both galvanometer pointers are depressed at once. After the third record, the thermocouple circuit is opened and the pointer returns to zero where it is pressed upon an inking pad. This method of

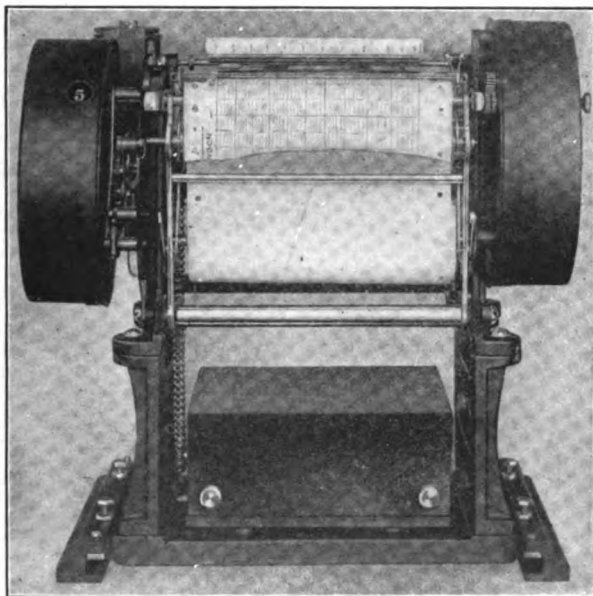

FIG. 12.—MULTIPLE-POINT THREAD RECORDER.

making easily distinguished records is simple and results in no confusion. The Thwing recorders are also made with three or four galvanometers giving nine or twelve records. The width of scale decreases with the number of records, and for twelve records is but  $2\frac{1}{2}$  in. (6.3 cm.) wide. The mechanism of the instrument is very simple and can be made so even with considerable friction in operation, because the clock is very powerful, and is wound once daily. The clock does all the work, turning the paper roll, depressing the needle, and closing and opening the thermocouple circuits. The commutator contacts are of silver and should give good results with a slight wiping action, which is obtained. This recorder is often furnished to operate on combinations of thermocouples and one or more radiation pyrometers, which is frequently very convenient.



The galvanometers used are double-pivot instruments of a standard Thwing type, which has been described by the writers in a previous article. The resistance can be made fairly high, but varies widely with different instruments, remaining high enough to give considerable latitude in length of leads (copper) used.

The Tapalog, a single- or multiple-point recorder made by the Wilson-Maeulen Co., is illustrated in Figs. 14 and 15. The figures illustrate a

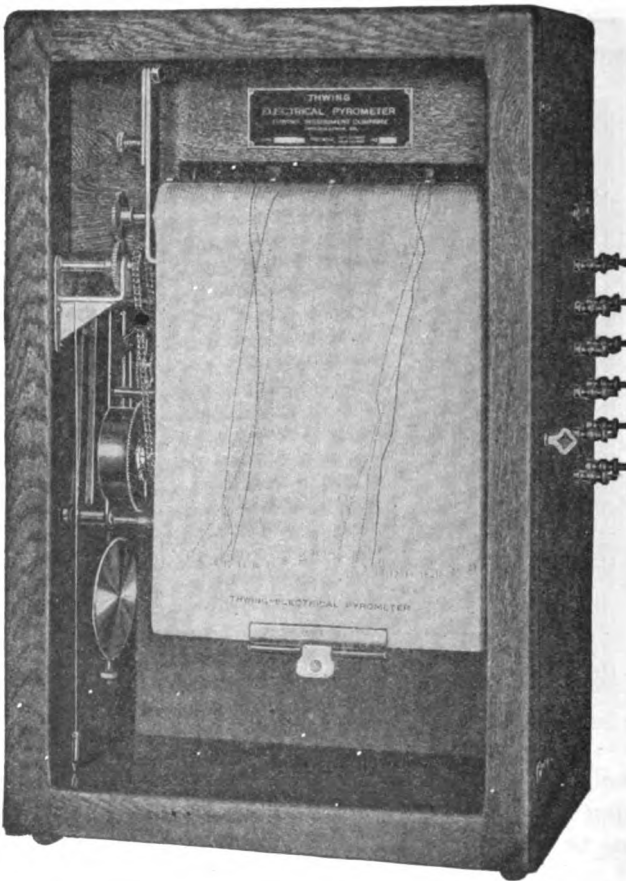

FIG. 13.—THWING RECORDER.

four-record instrument which is the most common form. The very heavy and strong construction of this instrument is easily recognized in the illustrations. The case is heavy enameled cast iron with  $\frac{1}{4}$ -in. plate-glass windows. The works are mounted on an iron casting supported on a shelf. There is no need of an extra dust-proof cabinet and this case is bolted directly to a wall.

Rectangular coördinates on the chart are obtained by pressing the

galvanometer pointer against a nearly sharp straightedge extending across and underneath the record paper. In Fig. 15, the chart carriage is lowered into position for change of paper and inked ribbon, which here have been removed. The sharp straightedge is visible midway between the sprocket roller *W* and the sprocket drum *D*. The front of the depressor frame, sometimes called the chopper bar, is straight and in line with

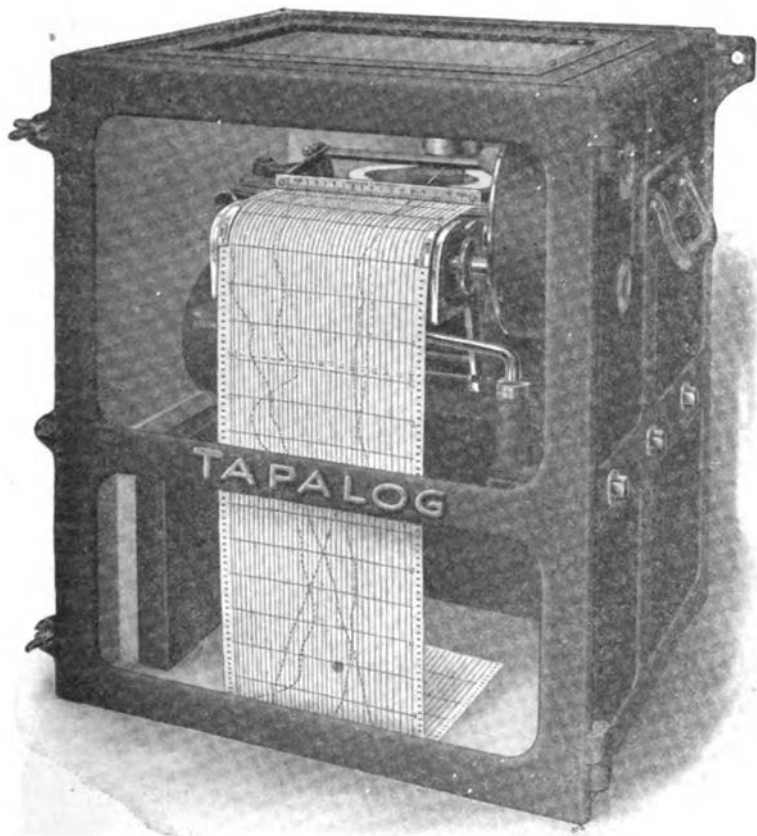

FIG. 14.—WILSON-MAEULEN RECORDER.

the sharp straightedge. The pointer is thus caught between two edges, giving a dot under the paper which is thin and translucent. The records are distinguished by different colors. Dots are made at 10-sec. intervals, eight dots to a thermocouple, and a change of couples every 80 sec. The recorder may be made to persist in indicating the temperature of one couple by moving the lever to "Single," which disconnects the commutator within the cylindrical box on the left.

Power is obtained from three dry cells placed within the case, and the

speed of recording operations is regulated by the clock in the box at the upper right-hand side. The clock case is the background in Figs. 16 and 17. It is a powerful eight-day clock with two springs. The escape-

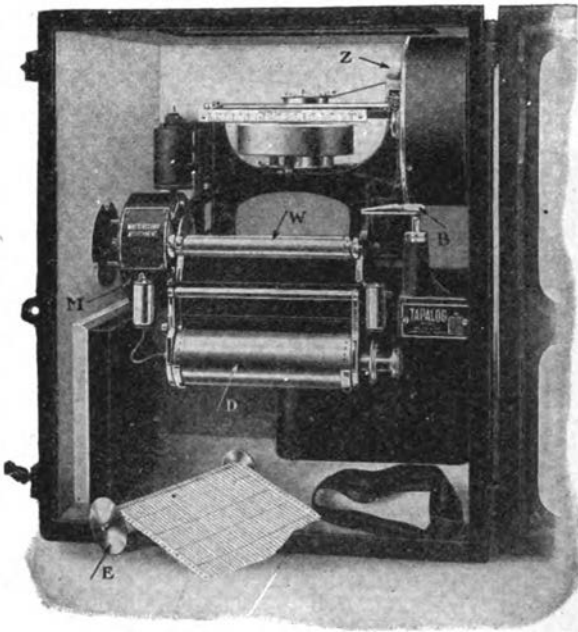

FIG. 15.—WILSON-MAEULEN RECORDER.

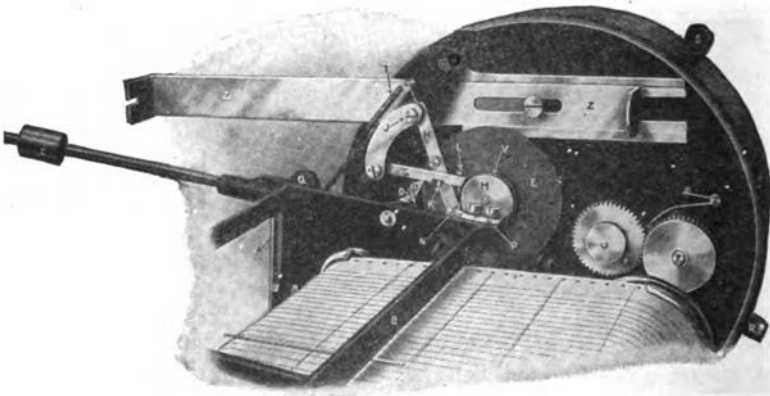

FIG. 16.—CONTACT MECHANISM OF TAPALOG.

ment is mechanically linked with the recorder parts through the sprocket *E*, Fig. 16, which is engaged by the pawl *D*. The chart drum is driven by the pair of gear wheels seen in the lower right-hand corner. The following description explains the operation of the contact mechanism and

the method of taking the load off the clock. The depressor frame *B* is held up by the overbalancing weight *C* and is allowed to rise slowly by the slow motion of the escapement sprocket *E*, which is engaged by the pawl *D* and its spring *O*. In Fig. 17, the corner of *B* has been cut away to show parts *P* and *W*. When electric contact (battery circuit) is made, the electromagnet forces the frame *B* down with a sharp blow. This lifts the weight *C*. The part *P* bolted to *B* engages the lug *W* on the arm *H*, forcing the latter to the left until it is caught by a lug entering the notch *K* in the arm *G*. As soon as the frame *B* is depressed, it starts rising slowly with the motion of *E*. When the frame *B* reaches a certain point, it lifts the arm *G* (*P* strikes *L*) disengaging it from the lug on *H*, allowing *H* to be pulled into its original position by the spring *T*. The latter

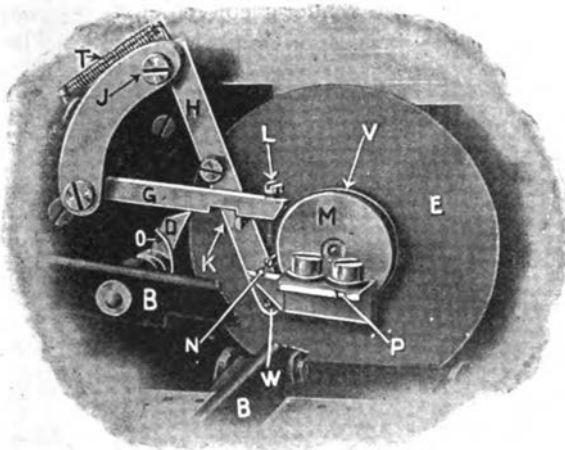

FIG. 17.—CONTACT MECHANISM OF TAPALOG.

operation is sudden, so that the lower end of *H* strikes the spirally wound wire *V* on *M*, making electric contact in the battery circuit. Thus the cycle is complete. In this cycle, energy is intermittently stored up in the spring *T* and the weight *C*. The contact on *H* and the wire *V* are platinum-rhodium and platinum, so that good contact is always made.

Eight strokes of an electromagnet store up sufficient energy to shift the commutator. This is not shown in detail as the parts are so small and superimposed as to make it difficult to show their operation photographically. The commutator is thoroughly tested before incorporation in the recorder, by running it for a month in the factory. The contacts are of rare metal and a combined blow and wipe contact is employed.

Until recently the galvanometer of this recorder was made only with double pivots and having a resistance—including the swamping resistance—of 50 to 150 ohms. In 1919, the manufacturers began furnishing the instrument with a monopivot galvanometer, and were able to

increase the total internal resistance to 450 ohms for a 55-millivolt range. The armature and springs of the galvanometer have, in this case, a combined resistance of 46 ohms. The period of vibration of the moving coil about a horizontal axis is such that very rarely may trouble be expected due to jarring of the recorder. The galvanometer parts are particularly strong and the method of lowering the chart carriage for replacing ribbon and paper precludes any likelihood of injury to them.

### THERMOCOUPLE RECORDER OPERATING ON THE POTENTIOMETRIC PRINCIPLE

The principle of operation of the potentiometer circuit and the various arrangements, as it is applied in pyrometry, has been described by the writers<sup>3</sup> elsewhere. For the reader's convenience the diagram of the simple potentiometer circuit is given again in Fig. 18. The three steps

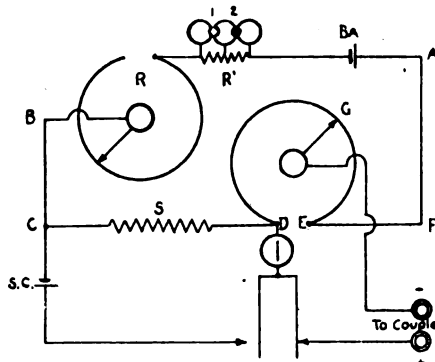

FIG. 18.—SIMPLE POTENTIOMETER CIRCUIT.

in the operation, adjusting the current through *DE*, connecting the thermocouple (the galvanometer is deflected), and turning the point *G* until the galvanometer deflection is zero, are done automatically in the multiple-point potentiometer recorder.

The curve-drawing recorder made by the Leeds & Northrup Co. is a potentiometer recorder for one couple only. The ink pen remains in contact with the paper chart at all times and a continuous terraced curve is drawn. In this single-point recorder, the current through the slide wire is set by hand, since a commutator would be required to do this automatically, and the addition of a commutator converts the instrument into a multiple-point recorder, as illustrated in Figs. 19 and 20. The potentiometer recorder consists essentially of a potentiometer with the mechanical device shown in Fig. 21 for automatically changing the

<sup>3</sup> See paper by Foote, Harrison and Fairchild on Thermoelectric Pyrometry, this volume.

slide-wire contact and moving the pen across the chart. It is the perfection of this simple device that has made possible the application of the potentiometric principle to the autographic recorder.

Figs. 19 and 20 show the construction of this instrument in some detail. The case consists of a cast-iron back with an oak and glass cover, which is raised in Fig. 20. On the left of the case are shown the main switch, the thermocouple, and battery binding posts; and on this particular instrument an automatic cold-junction compensator.<sup>4</sup> On the left, within the case, is the double-pole commutator with five sectors, one of which is for the standard-cell connection. The motor is mounted above the box containing the governor, which is attached to the end of the motor shaft. The gears and cams on the right connect the main

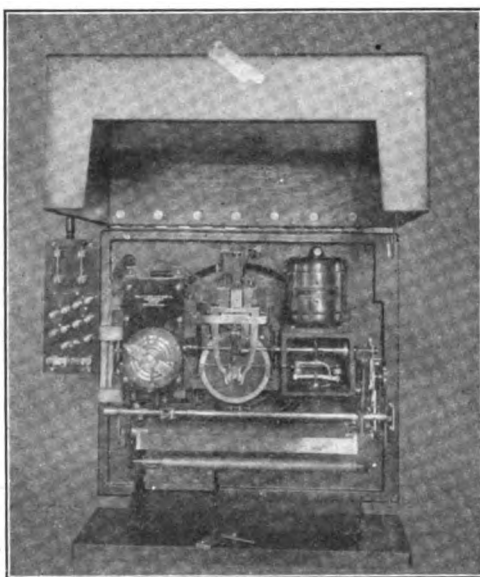

FIG. 19.—LEEDS & NORTHRUP RECORDER.

shaft with the commutator, print wheel (in place of pen), and paper chart. In Fig. 21, the moving coil of the galvanometer is marked 7 and this is seen in Fig. 19 between the pole pieces of the horseshoe magnet.

The chart of the Leeds & Northrup recorder is 10 in. (25 cm.) wide and has rectangular coördinates. The paper has been removed in Fig. 19 showing, near the bottom of the case, the empty roll. The paper goes from this roll over the drum and out of the case through a slot in the bottom. The pen in single-point recorders, or the print wheel in the instrument illustrated, travels on a rod above the drum and is attached to a cord. In Fig. 19, this rod is turned in synchronism with the commu-

<sup>4</sup> See paper on Thermoelectric Pyrometry.

tator so that the proper number on the print wheel is down. The rod is kept away from the paper, against the tension of two helical springs, by arms at each end, which are pressed against the peripheries of two cams on a shaft running in the rear of the frame seen in Fig. 20 where the entire works is swung outward, on a heavy cast iron frame.

A short description of the device shown in Fig. 21 and its cycle of operations will explain how the deflection of the galvanometer results in a movement of the slide wire and pen without requiring that the galvanometer do any work. The disk 1 is mounted on the same shaft as the slide resistances *R* and *DE*, Fig. 18, which are wound on the circumferences of the disks visible in Fig. 20. The power supplied by the motor

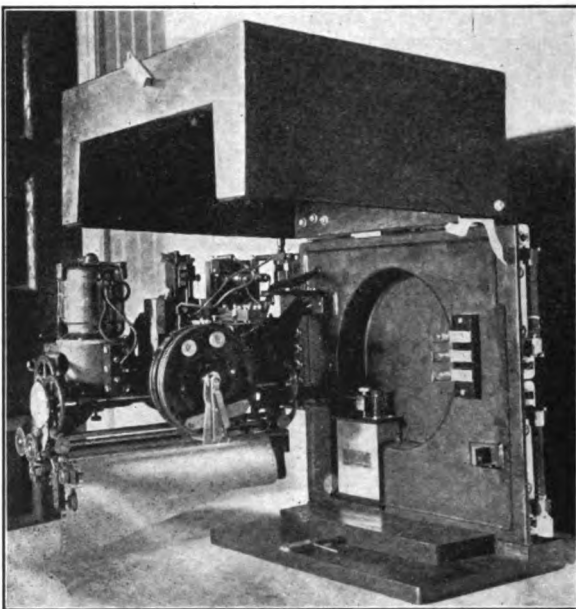

FIG. 20.—LEEDS & NORTHRUP RECORDER.

enters this mechanical system through the shaft 6 carrying the large cams 6*E* and the small cams 6*B* and 6*C*. At each revolution of the shaft 6, the cams 6*E* straighten out the arm 2, which perchance has been tilted a moment before, and in doing this rotate the disk 1, arm 2 being pressed at this time against the disk 1 by the spring 3. The arm 2 is pivoted on the spring 3, which is fast to the frame of the instrument. When the cams 6*E* have rotated until their longest radii are passing the extensions of arm 2, the cam 6*C* begins to raise 3, lifting 2 away from the disk. When 2 is free, the cam 6*B* raises the rocker-arm 5, which, in case the galvanometer is unbalanced, catches the pointer under one of the right-angle levers 4*L* and 4*R* pivoted at 2*E*. The lever 4*L* or 4*R* is thus made

to swing the arm 2 by pressing against one of the eccentrically located lugs, 2C. The rocker-arm 5 is then immediately lowered to allow the galvanometer to swing freely. Cam 6C is so shaped and fixed on the shaft 6 that it will recede from the spring 3, allowing 3 to press 2 against the disk just before the cams 6E begin once more to straighten 2.

This mechanism, in its cycle of operations, moves the contact on the slide wire whenever the potentiometer is out of balance with the thermocouple and in so doing operates to obtain or restore the balance. The shaft 6 rotates once in about 2 sec., which is slow enough to allow the galvanometer time to come to rest or nearly so. This design is such that

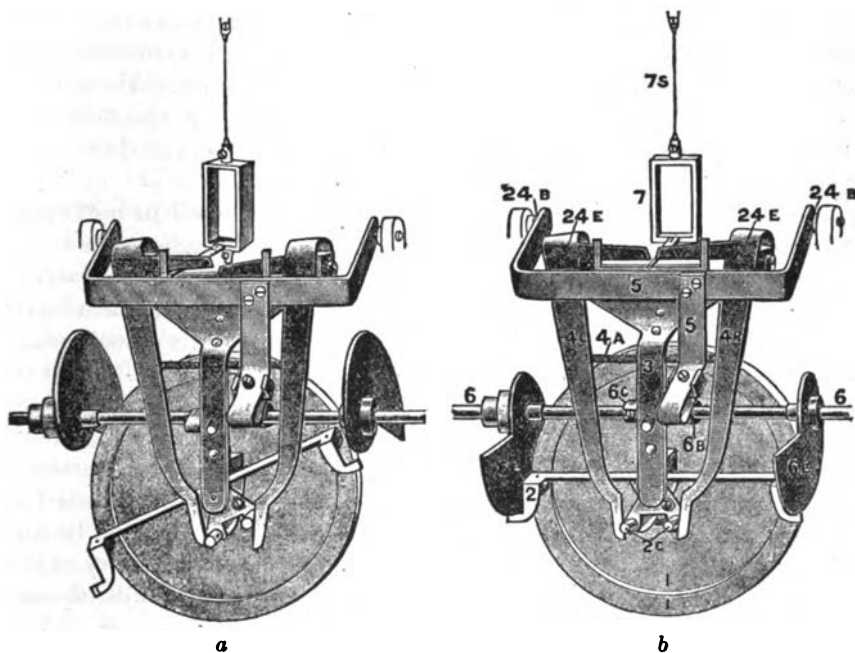

FIG. 21.—BALANCING MECHANISM OF POTENTIOMETER RECORDER. *a*, MECHANISM UNBALANCED; *b*, MECHANISM BALANCED.

the amount of rotation of the arm 2 increases with the extent of the galvanometer deflection, since the pointer approaches the fulcrum of the lever 4L or 4R as the deflection increases. The motion of 5 is adjusted so that the rotation of 2 will correspond to a rebalancing step of the pen, of  $\frac{3}{4}$  in. (19 mm.) when the deflection is a maximum, and decreases uniformly to about  $\frac{1}{50}$  in. when the deflection is just sufficient to catch the boom under one of the right-angle levers. This gives sufficient rapidity of the various actions to take the pen the width of the scale in somewhat less than 1 min. A record is made once a minute on the multiple-point recorders of standard design. The position of the pen,



when a balance has been obtained just before each record, corresponds to a definite point on the slide wire, for the pen is fixed to a cord fast to the slide-wire disk and is wound or unwound with the rotation of the disk.

Once during a revolution of the commutator, the thermocouple is disconnected and the standard-cell connection made. At the same time the potentiometer slide wire is let loose from its shaft and the clutch engages a second resistance  $R$ , Fig. 18. Movements of the disk then result in changing the resistance of the battery circuit and the current is thus set to its proper value. The pen does not follow this adjustment and no record is made of variations in the current. With batteries in fair condition, the current is easily maintained constant; but if there arises any doubt of this constancy, the recorder may be watched for a few minutes and when the standard-cell connection is made, the first deflection of the galvanometer is an indication of the change in the current since the last adjustment. A short-circuiting contact on the slide wire carries the pen to zero on the chart when the battery has run down, thus providing ample warning under most circumstances.

The scale of this recorder is uniform when graduated in millivolts, and departs from uniformity for a temperature graduation according to the temperature-electromotive force relation of the thermocouple. The standard galvanometer is sufficiently sensitive to work satisfactorily with a full-scale range of 10 millivolts, which gives a very open scale, particularly for base-metal couples, when  $\frac{1}{10}$  in. (2.5 mm.) of scale corresponds to  $2\frac{1}{2}^{\circ}$  C. This recorder is used with resistance thermometers, in which case the electrical circuit takes the form of a Wheatstone bridge, and the scale can be opened until the entire range corresponds to as little as  $2^{\circ}$  C. The zero of the scale can be adjusted to correspond to any fixed electromotive force, so that the scale may be put within any range of temperature desired. The great adaptability of the instrument is readily apparent. Some of the applications will be considered in a section on temperature control.<sup>5</sup>

#### TRANSFORMATION-POINT INDICATORS AND RECORDERS

Instruments for obtaining transformation or critical points in steels have been in use for a number of years, and are fairly well known in the steel industries. The simplest, being also the least accurate method of measuring the temperature at critical points, is to record or plot, from indicator readings, the temperature-time of the sample of steel when placed in a furnace and heated. This method requires a very steady rate of heating and the sensitivity is ordinarily only sufficient for high-carbon steels. It is possible, by using a potentiometer and very sensitive galvanometer and forcing the furnace to rise in temperature at a fixed

<sup>5</sup> This volume.

rate, to obtain a temperature-time curve that will indicate plainly all the transformations. There is great difficulty in keeping the rate of heating constant, and it is not necessary to control this rate better than to keep it from changing rapidly. However, in the research laboratory, good heating rate control, sufficient sensitivity, and an accurate method of measuring time intervals, as with a chronograph or stop watch, will give all the necessary data, sometimes requiring for a complete interpretation, the replotting of the data<sup>6</sup> as temperature versus inverse rate,  $\frac{1}{\frac{\Delta\theta}{\Delta t}}$ .

Burgess has described<sup>7</sup> the use of a neutral body and the differential-couple arrangement (first devised by Sir Roberts-Austen), which tends to avoid to a large extent the destruction of useful data by variations in heating and cooling rates. The differential couple is mounted with one hot junction in the test piece and the other in a neutral body (one with no transformation points).

The data obtained are curves of temperature of test piece versus temperature difference between test piece and neutral body. These are mounted side by side in the furnace and must be of such size, specific heat, emissivity, etc. as to heat and cool at nearly the same rate.

The industrial laboratory requires a method of automatic, or at least semi-automatic, recording of cooling curves. Simplicity of the apparatus implies a limited scale range, incompatible with the direct  $\theta$  versus  $t$  method and requiring the use of the differential thermocouple. To avoid errors due to improper measurement of time intervals, the records of temperature and temperature difference must be on one chart and are best obtained from a single galvanometer connected alternately to the thermocouple in the test piece and the differential couple. A curve of temperature versus temperature difference may be obtained simply, in a semi-automatic recorder using two galvanometers.

*The Brown Transformation Point Recorder.*—Fig. 7 illustrates the type of recorder applied for this purpose. The single galvanometer of this instrument has two windings of low resistance, one of which has in series with it a high resistance and is employed to measure temperatures. This coil is connected permanently to the thermocouple in the test piece. At intervals, a record is made of its temperature. At alternate intervals, the other coil is connected to the differential couple and a record made of its temperature difference. This difference shows on the chart as the distance apart of the two curves of  $\theta$  and  $\theta-\theta'$ . If the first coil were disconnected during the time the other is connected

---

<sup>6</sup> G. K. Burgess: On Methods of Obtaining Cooling Curves. U. S. Bureau of Standards *Sci. Paper* 99.

<sup>7</sup> *Loc. cit.*

$\theta-\theta'$  would be measured by the deflection from zero on the chart. But  $\theta-\theta'$  may be positive or negative and this arrangement would necessitate a reversing switch and offer no advantage. To obtain sufficient sensitivity base-metal couples and rather large test pieces are used. The instrument will show a curve with a very marked jog at the eutectoid transformation point, and by close observation the allotropic transformation point  $A_1$  may be detected in pure iron. There is not an excessive sensitivity, but practically the best that can be done with a double-pivot galvanometer.

*The Leeds & Northrup Transformation-point Indicator.*—This instrument is a semi-automatic recorder giving a continuous curve of  $\theta$  vs.  $\theta-\theta'$ . One observer is required and no time measurements are made; it is illustrated, in part, by Fig. 22. The wall-type reflecting galvanometers (two) are not shown. The complete apparatus includes the two galvanometers, furnace, rheostat, and thermocouples.

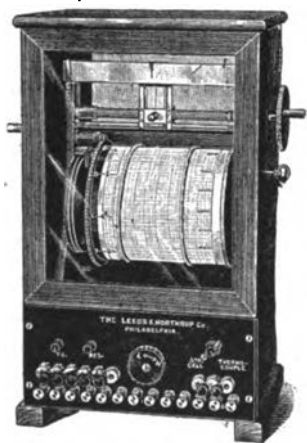

FIG. 22.—LEEDS & NORTHROP TRANSFORMATION POINT INDICATOR.

The recorder consists, in the main, of a potentiometer with a slide wire and drum chart on the same shaft. In moving the slide wire to obtain a balance of the potentiometer galvanometer, the chart, with ordinates graduated in degrees (or millivolts), turns simultaneously and its position with reference to a pen held in contact indicates the temperature of the test piece. The pen is mounted above the chart on a carriage, which may be moved by turning a screw across the width of the chart. Upon the carriage is a ground-glass screen with a central vertical mark. A spot of light from the differential galvanometer is focussed on this screen. The differential couple is connected directly to this galvanometer and its deflections are followed by turning the pen-carriage screw keeping the mark on the glass coincident with the light beam from the galvanometer. A separate glass scale is provided for balancing the other galvanometer. The observer has two motions to perform, viz., turning the slide wire (and drum) and turning the pen-carriage screw. The zero temperature point is suppressed and the end of the slide wire is usually made to correspond to 2 millivolts or the corresponding temperature. The other end of the slide wire corresponds to 10 millivolts giving 8 millivolts, or about 800° C., over the whole chart length of 20 in. (50.8 cm.). This is a sufficiently long temperature scale for all practical purposes.

In series with the differential galvanometer is a resistance that may be used to cut down the sensitivity of the galvanometer, which will be

usually deflected off the scale at a eutectoid transformation point. The sensitivity is ample for detecting all the transformation points ordinarily required in practice. The period of the galvanometer is short enough to allow the heating and cooling to be done in less than 1 hr. The curve obtained is a continuous line, slightly ragged due to manual operation, and is easily translated into metallurgical terms. It can be replotted into a curve of  $\theta$  vs.  $\frac{\Delta(\theta - \theta')}{\Delta\theta}$ , the so-called "Derived Differential Curve," due to Rosenhain,<sup>8</sup> especially if errors are suspected due to considerable differences in the cooling curves of the test piece and the neutral. This curve also aids in the interpretation of results and corresponds to the inverse-rate curve when only measurements of temperature and time are made without the use of a neutral body and differential thermocouple.

## DISCUSSION

R. W. NEWCOMB, New York, N. Y. (written discussion\*).—On page 417 mention is made of a new instrument with an exceptionally high resistance that has been developed by Charles Engelhard. All friction and wear of moving parts of the moving system has been eliminated by replacing the hardened steel pivots and jeweled bearings, commonly used on other instruments, by a double metallic filament, one at the top and one at the bottom, under slight tension. Any possible distortion of the moving coil, because of tension, has been eliminated by introducing a solid spindle as the axis of the coil between the points on the coil where the metallic filament is attached. The filaments serve not only as a support for the moving coil, but also to lead in the current from the binding posts to the moving coil, and as a source of counter-torque; instruments so constructed do not require leveling, and are mechanically very robust.

The clock of the recorder serves only to drive the chart at its specified rate and to operate a small contact-making device; *i.e.*, there is no other mechanical load on the clockworks. The contact-making device is so constructed that there is a quick-make, a quick-break, and a wiping effect while the contact is being made. Contact surfaces on this switch are of platinum-platinum-iridium. The operation of this contact, which occurs once each minute, sends a current, from a 6-volt supply, through a solenoid magnet, which operates the depressor bar mechanism in the case of the single-record instrument; in the case of the multiple-record instrument, it operates the automatic switch and color-changing features, as well as the depressor bar.

A new method of inking is employed. On the single-record recorders

<sup>8</sup>Observations on Recalescence Curves. *Proc. Phys. Soc. Lond.* (1908) **21**, 180.

\* Received Nov. 1, 1919.

the paper passes over a small roller about  $\frac{1}{4}$  in. in diameter, which is located directly across the instrument, beneath the depressor bar. The paper is held clear from the roller surface by small hubs located at each end. The roller is covered with a fabric tube, impregnated with the inking compound, and is slowly turned by the passage of the paper. The pointer swings above the chart and below the depressor bar. When the depressor bar falls, the position of the pointer at its intersection with the color-carrying roll underneath the chart is recorded. On the multiple-record instruments, there are as many rollers as the capacity of the multiple-recorder in thermocouples, *i.e.*, on a four-point recorder there are four rollers, on a six-point recorder, six rollers, etc.

The operation of the automatic switch that controls the rollers, the depressor bar, and the color-changing mechanism is accomplished by the solenoid magnet; the up-and-down motion of the magnet is changed into a rotating motion for the operation of the switch and color-changing mechanism, by a double-acting locking pawl engaged with a pinion. When the small contact switch on clockwork makes contact, the armature of the magnet is drawn down, allowing the depressor bar to record the position of the pointer corresponding to the temperature of the thermocouple. As soon as the contact is broken, the reacting spring on the solenoid magnet turns the automatic switch and color-changing mechanism to the next point.

## High-temperature Control

BY C. O. FAIRCHILD,\* B. S., AND PAUL D. FOOTE,† PH. D., WASHINGTON, D. C.

(Chicago Meeting, September, 1919)

THE meaning of temperature control can be extended to cover not only the control of temperatures but also the control of processes through a knowledge of the temperatures involved. In this sense it has a very wide interest. A list of the industries in which temperature control is used in one way or another would cover nearly the entire industrial field. This discussion will be confined to the field of high temperatures.

In practically all industries involving operations at high temperatures, pyrometers are used or men are paid for their ability either to estimate temperatures or gage an operation by some physical or chemical change or condition dependent on temperatures. As progress is made in the development of instruments and of methods for measuring temperature, some of these highly skilled artisans are learning the use of a new tool. Many processes have been, in recent years, improved by means of exact measurement thus substituted for estimation, but in a great many industries the pyrometer has had practically no opportunity to demonstrate its usefulness. The perfecting of instruments must be accompanied with a dissemination of the knowledge that new instruments are available and can be economically used. The demand at present, however, is ahead of the supply, and many industries are handicapped by the want of pyrometers.

One of the highest paid skilled tradesmen of the present time is the man in the steel rolling mill who knows when proper working temperatures are attained. The metallurgist in his development of steels is continually demanding closer adherence to given temperature ranges in the processes, and the pyrometer is rapidly becoming indispensable. Properties of the finished products are being correlated with working temperatures and so closely that in some cases even the pyrometer is taxed to give the required accuracy. The greatest progress has been made in those industries in which the lower temperatures are used, particularly below 500° C. In this lower range automatic control has been highly developed.

---

\* Associate Physicist, U. S. Bureau of Standards.

† Physicist, U. S. Bureau of Standards.

### GENERAL DISCUSSION OF PROBLEM OF CONTROL

Some of the factors that increase the difficulty of the regulation of furnaces, ovens, kilns, tanks, etc., are: Inconstancy of heat supply, variation in internal absorption or generation of heat, variation of heat lost by radiation, etc., and unsteady supply or composition of material to be heat treated. As each of these items is intimately associated with temperature and temperature variations, there is little room for doubt that furnace control is best accomplished with and through a knowledge of the temperatures and temperature variations. Further, this knowledge becomes increasingly important at high temperatures, finally becoming the prime requisite in all cases. How are the temperature and its variations to be determined? Where (in what part of the furnace, kiln, or oven) is it to be determined? What is the best way in which the temperature may be indicated so that it will aid in control? Or can automatic temperature control be accomplished?

There is generally some point, or perhaps several, in a furnace, the temperature of which is more intimately connected with the desired conditions than any other. In a hardening furnace, it is a simple matter to put a thermocouple at some point and find the temperature in the immediate vicinity. But it is another matter to determine the actual temperature of a piece of steel in the furnace. This particular case will be treated later. In open-hearth furnaces two temperatures are particularly desired, that of the metal and that of the roof.<sup>1</sup> It is essential to tap the furnace when the metal is in a certain temperature range, but before this range is reached the temperature of the roof is considerably more useful for furnace control. In forcing the furnace to maximum production, the maximum rate of heating the charge is limited by the refractoriness of the brick making up the roof. Other factors, of course, enter but this serves as an example of the necessity for a study of where to install the pyrometer. Burgess found that remarkably uniform results are obtained without the use of pyrometers, at least with the temperatures of the metal. The roof temperature was found to vary over wide limits. The exceptionally consistent results obtained in open-hearth practice are due to highly skilled men who have learned, by long practice, how to estimate temperatures and run the furnace by the appearance of the slag, etc. However, suppose that an optical pyrometer is used to measure the temperature of the roof and that the bricks of the roof melt at 1710° C. At this temperature, then, the deterioration of the roof is quite rapid. But at only a slightly lower temperature, possibly 1690°, at which there are no signs of melting to aid the furnace man, the life of the roof is very much greater. Only

---

<sup>1</sup>G. K. Burgess: Temperature Measurements in Bessemer and Open-hearth Practice. U. S. Bureau of Standards *Tech. Paper* 91 (1917).

by means of a pyrometer can so close a regulation of temperature as this be attempted and production forced to a uniform high value without too rapidly burning down the roof.

In the example cited, the furnace can be operated quite satisfactorily without a pyrometer, because a physical change (the melting of the roof) begins at a certain temperature but does not at this temperature attain a disastrous rate. The argument is not affected by the fact that numerous other changes occurring serve to guide the furnace man. A pyrites dead-roast furnace tends to become too hot and reach a temperature at which the pyrites softens. This is a danger point as the ore begins to ball up, but before this tendency has become too great the operator has some leeway and can cool the furnace by prompt action without coming to disaster. With a pyrometer in the hottest bed of the furnace, the temperature can be kept consistently at the highest safe point, without the necessity of occasional drastic action to cool the furnace, thus lowering production.

The working of glass is an excellent example of an operation that can be carried on without a pyrometer because the glass grows softer very slowly with a rise in temperature. But since it works best in a small range of temperature, a pyrometer is of considerable advantage, and glass manufacturers are speeding up production and increasing the quality and uniformity of the product by installing pyrometers. These instruments have been found practically indispensable in the lehrs, where it is difficult to make any estimate of the temperatures. Here it is necessary to know the highest temperature reached and also the rate of cooling of the ware.

In order to control a furnace with a pyrometer, or at least to obtain the most help, it is desirable to have the pyrometer indicate the temperature where the widest variations occur and where these changes take place the earliest. In industries such as glass, steel, and ceramics, in which very high temperatures are reached, this generally cannot be done unless a radiation or optical pyrometer is used. The position in which a thermocouple is placed sometimes depends on its ability to withstand the maximum temperatures attained and the expense involved in using thermocouples at high temperatures. Often the position is so chosen as to protect the thermocouple even though the temperature indicated is not the one it is most desirable to know. One of the severest tests of permanently installed thermocouples is found at the pyrex glass tanks of the Corning Glass Works. Platinum-platinum-rhodium couples are installed in the walls of these tanks so that the hot junctions do not reach into the inner face of the wall. The indicated temperature, 1475–1500° C., is possibly 100° below the actual temperature of the glass. The couples are found to deteriorate very rapidly and means are provided



for frequently checking them by inserting a test couple into the same protecting tube.

The question of what pyrometer to use in a certain case is always a vexing one, unless the user has had considerable experience. A proper answer to the question would be a table of industrial operations and descriptions of pyrometers.

The methods of rendering temperature information useful, that is the method of indicating and recording temperatures and their variations, are very numerous and must be adapted to special needs in a plant. The simplest way is to put the pyrometer indicator, preferably of the wall type, in a conspicuous place, where the operator can read it with the least trouble; special means must often be employed for making the scale sufficiently legible. The scale must be as open as possible, so that small changes of temperature can be readily detected. Some indicators are provided with two pointers, one of which can be turned to the temperature desired. This second pointer may be made a single line or a double one, the latter indicating the limits of variation allowable. In the absence of a recorder, the second pointer is nearly indispensable as a means of judging rates of change. In poorly lighted rooms, illuminated scales can be used. If cheap labor is employed and the operator is unable to adequately interpret the indicator reading, signaling lights or alarms may be operated either manually or automatically. In larger plants, the indicators may be situated at a central station, where the pyrometer man reads them and transmits the proper signal to the operator. Colored lights are best used for this purpose, white for correct temperature, green for too low, and red for too high, and white with red or green for small departures from the correct temperature. The lighting circuit is, of course, completely separated from the pyrometer circuit. If the plant electrician is allowed to install the wiring, he must be convinced that electrical insulation and leakage take on a new significance in electrical pyrometry. The use of these colored lights or a signal system is not restricted to control at a fixed temperature; they may be employed for governing the rate of heating up a kiln for instance. In the ceramic industries, pyrometers are particularly useful as a means of avoiding loss of time and curtailment of production on account of a non-uniform rate of firing.

The operator, in controlling a furnace to reach a desired temperature, bases his action on experience and judgment. Possibly, he turns a gas or oil valve a certain part of one turn according to the change just observed in the condition of the furnace. Obviously the adjustment can best be made with a knowledge of the changes that have occurred over a considerable interval of time rather than by watching the change occurring from moment to moment. This is one of the most prominent advantages of a recording pyrometer; and when it is possible and the class of labor

employed warrants it, the operator should be given the advantage of inspecting the recorder chart. It is necessary that the record be made with a frequency greater than that of significant changes that are liable to occur in the furnace, particularly when a multiple recorder is used. In case a single-record recorder is used, or a multiple galvanometer recorder in which each galvanometer is always connected to one pyrometer, the position of the pointer or pen will always show the change that is occurring. The recorder should be so constructed that the record is visible to the last minute.

When pyrometers have been installed where they have not been used before, the immediate result is usually confusion. Difficulty is encountered in correlating the indicated temperatures with other conditions, so that there may be less efficient operation than before. Perhaps there exists a notion that the pyrometer will run the furnace. Too much attention is given to temperature and the attempt is made to operate without regard to other necessary factors, or the new knowledge is misinterpreted because of the errors of previous ideas. The logical way, of course, is to observe and record temperatures and related phenomena until the full significance of temperature is discovered. The pyrometer may fail to indicate correctly or consistently, which is more likely to be the fault of the user than of the manufacturer. But the greatest confusion results from previously conceived and erroneous notions of what temperatures have existed in former practice and quite frequently of what conditions signify a rising or falling temperature. A furnace fired with some fuel, as gas or oil, will usually have a damper in the vicinity of the waste-heat flue or exit, with which the draft is or can be controlled. A certain position of this damper corresponds to a certain temperature gradient in the furnace. As the damper is closed, this temperature gradient is gradually changed, either increasing or decreasing, depending on the draft and fuel supply. Some point is easily reached at which, if the draft is reduced further, the temperatures will decrease. There is, then, this possible condition: With the damper initially wide open, there will be a point or section of the furnace that will get hotter and then colder as the damper is gradually closed. So it is conceivable that a pyrometer installed at a certain point will show a temperature change exactly the reverse of what a most experienced furnace operator will expect, when certain changes in draft or firing are made. Of course the pyrometer is not the only available means of learning the truth; draft and carbon-dioxide indicators and gas analyses properly distributed will predict temperature changes correctly, but few furnace operators are able to do this without one or more such instruments. In some industries in which the heat treatment of materials is essential pyrometers are not needed, for the heat treatment results in a chemical or physical change that is perfectly definite and sufficient for control, or operating conditions can

be maintained so constant, for example in certain distillation processes, that a pyrometer will do nothing more than indicate a fixed temperature within the accuracy of the instrument. In some such instances, a more sensitive and accurate instrument may result in unexpected improvements and in perfecting a process to a degree of refinement not considered possible.

In general, however, a furnace is kept operating as near to desired conditions as possible in spite of the persistent and often perplexing effects of the variables mentioned. Temperature measurements, where they have not been made before, have no known relation to the rates of change and the values of these variables. So, at first, these measurements are almost useless. The initial attitude of the operator is similar to that which he would have toward the introduction of a new variable for him to worry about, when as a matter of fact he is gaining exact knowledge of what he had before been guessing. It is evident that this is only a transition period which is bridged with difficulty, and during which there must be a little faith in the pyrometer and its usefulness.

The employment of pyrometers is generally least in those industries in which operating conditions are the worst because of the great difficulty met with in maintaining uniformity of conditions. It is particularly true of such an industry as the ceramic, in which the chemical constitution of raw materials is of prime importance and difficult to control. The kiln operator cannot fire his kiln according to any certain time-temperature relations because he does not know how, not because it is impossible. He will never know how so long as pyrometers are not installed and the time-temperature relations are associated with other variables. Pyrometers are now being used in kilns in order that the rate of heating may be maintained with greater certainty and a loss of time due to too slow firing be avoided, but the finishing time is determined with Seger cones. It is hoped that the Seger cones will eventually be supplanted by even more useful pyrometric methods.

Once installed, pyrometers are useful in so far as they have been properly selected and the installation properly completed. The installation of thermocouples is discussed elsewhere, but in temperature control it is necessary not only to attain correct temperature, where this is desired, but also to attain a correct temperature at some other point in the furnace, variations of which have a known significance and relation to proper operation. That is, in some furnaces it is possible to so place a thermocouple that should the furnace tend to become too hot this tendency would be seen in the pyrometer indication so quickly that the cause could be removed and a cooling action initiated before any vital part of the furnace would be overheated. The pyrometer should obviously function in a like manner during cooling. The maximum temperature that a thermocouple can withstand is more often exceeded when

thus installed, and this fact is directly responsible for the slow development of automatic control at higher temperatures.

Control, either automatic or manual, and automatic signaling are always accomplished by the employment of a method of forcing the furnace to heat or cool between limits, at a rate and through a range depending on the process and constancy required. Ordinarily there is little difficulty in obtaining enough sensitivity of the instrument for either automatic signaling or control, except in the research-laboratory furnaces, where at times the limit of sensitivity is employed. In control of a furnace through pyrometric measurement, it is not necessary that the pyrometer be accurately calibrated. It must, however, be particularly reliable and have a consistent error, as has been stated elsewhere.

#### DEVICES USED FOR CONTROL

*Automatic Alarm.*—An ordinary pyrometer galvanometer of low resistance may be fitted with two contacts on pivoted arms, between which the meter pointer plays. No relay is necessary for the small current and voltage required to operate a bell. The automatic alarm is seldom used in this form since the alarm operates for too large a part of the time unless the contacts are placed wide apart, when their usefulness is much lessened. The action may be made intermittent on more complicated instruments. The alarm should properly be employed only when the departure from a certain temperature range results in real danger to life or property.

*Manual Signaling.*—The development of manual signaling has taken place, for the most part, in the larger plants having extensive pyrometric installations of such scope that a central pyrometer station is necessary. Fig. 1 illustrates a form of central station developed in part by Charles Engelhard. With such an installation, only the thermocouples and signal lights are in the furnace room and the indicators in the station are connected to different couples by means of push buttons on switchboards. The more sensitive types of double-suspension or unipivot-suspension millivoltmeters or thermocouple potentiometers are used and can indicate easily temperature variations of 0.2 per cent. of the scale range. The substitution of manual operation for automatic is necessary to attain the closest correlation of temperature measurements and other physical conditions and the physical and chemical properties of the products.

Signaling is accomplished by colored lights, using three at each furnace. Temperatures are read at frequent intervals, determined by furnace operation and the operator's interpretation of signals. In some plants, pneumatic tubes are installed between the furnace room and the station for transmitting notes concerning the process or measurements. The furnace man can signal the station with the ordinary enunciator,

as shown in Fig. 1 at the top of the switchboard. Such a signaling system of colored lights, enunciators, and pneumatic tubes is, of course, not peculiar to pyrometry. This is, however, a very fitting application of such means of communication.

*Automatic Signaling.*—The descriptions of the various types of recorders makes it clear how automatic signaling may be accomplished with pyrometer galvanometers. In a similar manner to the way in which autographic records are made, a depressor bar or frame, in its rise and fall, closes either of two pairs of contacts depending on the position of the pointer. The device may be attached to an indicator according to Fig. 2, or a recorder may be made to do both recording and signaling. The latter arrangement has not been very successfully applied to the galva-

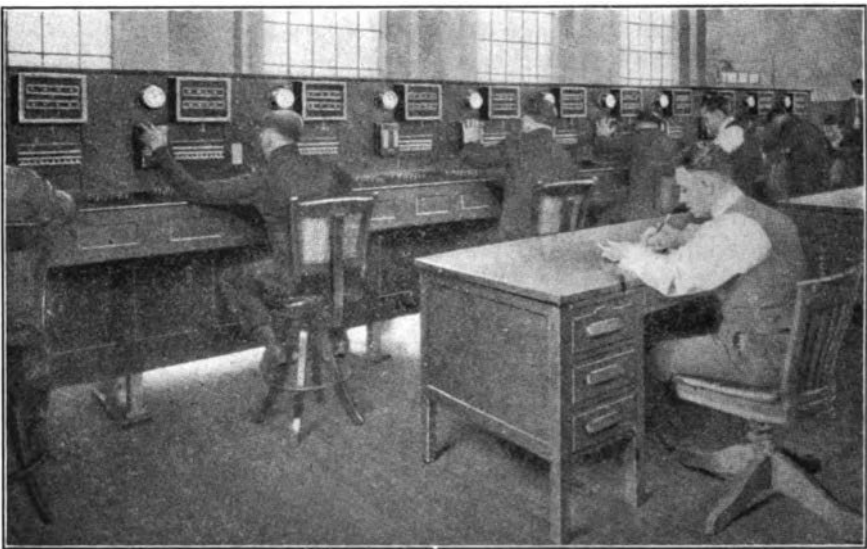

FIG. 1.—CENTRAL PYROMETER STATION OF CHARLES ENGELHARD.

nometer type of recorder, but is easily adapted to the potentiometer recorder of The Leeds & Northrup Co. In this case two contacts move with the slide wire on its shaft and the third is stationary.

The galvanometric instrument illustrated in Fig. 2 has two platinum contacts mounted on an arm which swings across the scale to adjust the signaling range. The signaling-circuit current does not flow to the galvanometer pointer but each platinum contact is double, one above the other, and the two are brought together by the pressure of the depressor arm transmitted through the pointer. The pointer is, in this case, a selector. The arrangement of Bristol differs from this in that a tipping device restrained by springs is tipped by the pointer when the depressor arm falls, in a direction determined by the pointer. If the latter is either

side of the apex of a triangular dividing piece, this will determine the direction of tipping. The springs are arranged to snap the contact when the pressure has reached a certain value; by this means the selection can be made to take place over a smaller interval than with two contacts placed side by side and close together.

The electromagnetic switches operated by closing these contacts hardly need description. They are made applicable to any range of voltage and require a small fraction of an ampere. The circuit may include any of the well-known signaling devices, some of which have been mentioned.

Figs. 3, 4, and 5 illustrate, diagrammatically, the arrangement of the curve-drawing potentiometer recorder with signaling lamps and furnace indicator. The diagrams are self-explanatory but the new method of supplying power to the indicator may be mentioned. This is not taken

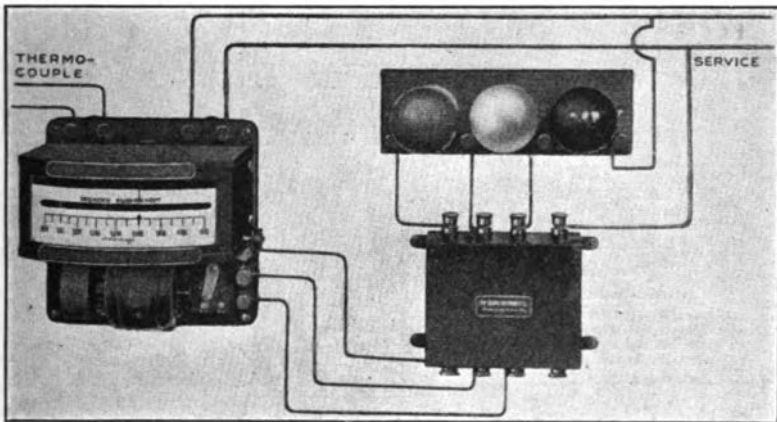

FIG. 2.—AUTOMATIC SIGNALING PYROMETER.

from the thermocouple but the indicator is shown in a Wheatstone bridge attached to the line, preferably 110-volts alternating current. The movement of the disk carrying the slide wire *S* and the three contacts connected to the lamps results in connecting the proper lamp and in unbalancing the bridge circuit. The meter may be of high resistance and its indications are easily checked by the recorder indication and correction accomplished with the adjustable resistance in the circuit. It is only intended to show the magnitude of departures from correct furnace temperatures and a large variation in line voltage would not be serious. Fig. 5 shows the use of the double recorder, or curve-drawing recorder, with a commutator for two couples, which gives the form of record shown in Fig. 6. This instrument is also used in the automatic control arrangement shown in Fig. 9.

The advantages of automatic signaling are not always well defined and

HIGH-TEMPERATURE CONTROL

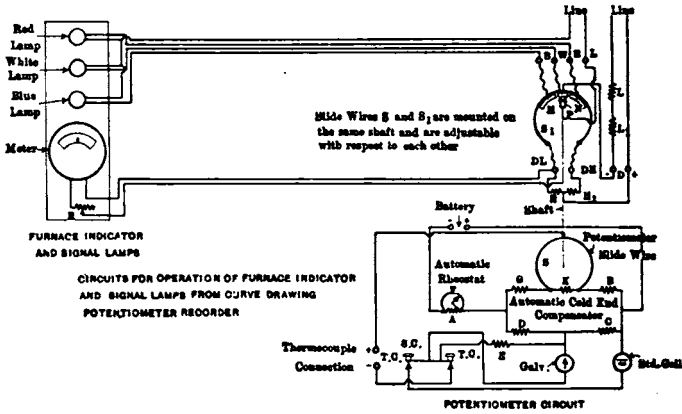

FIG. 3.

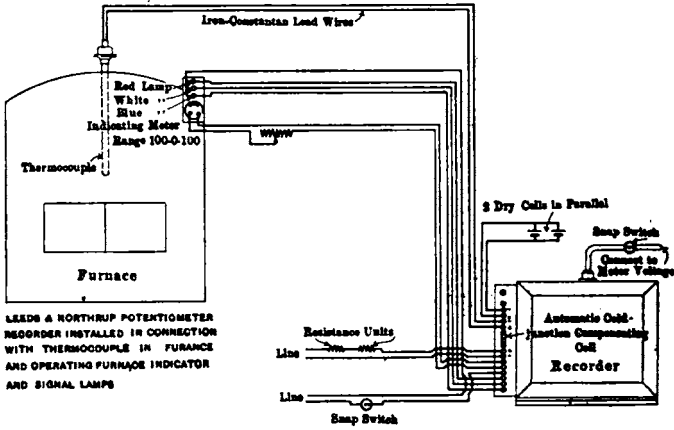

FIG. 4.

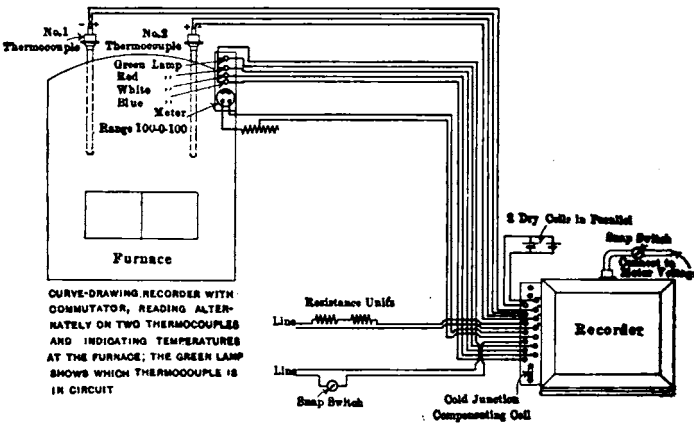

FIG. 5.

FIGS. 3, 4, 5.—AUTOMATIC SIGNALING RECORDER, POTENTIOMETER TYPE.

the method has not been put to very extensive use. In cases where very exact temperature measurements and control are necessary and the sensitivity demanded results in an instrument that must be removed a distance from the furnace or oven, automatic signaling may be required; but in most circumstances, the proper placing of the indicator or indicators will make automatic signaling unnecessary. To make one indicator operate many separate systems of signaling would require a complicated and cumbersome commutator. Such an arrangement might take the place of some of the observers in the central pyrometer station of a large plant, but sensitivity and flexibility would be sacrificed.

*Automatic Temperature Control.*—Temperature control at low ranges is termed thermostating and is ordinarily obtained by means of the movement of bimetallic springs, or the thermal expansion of rods or fluid columns. At high temperatures these devices are utilized only with great

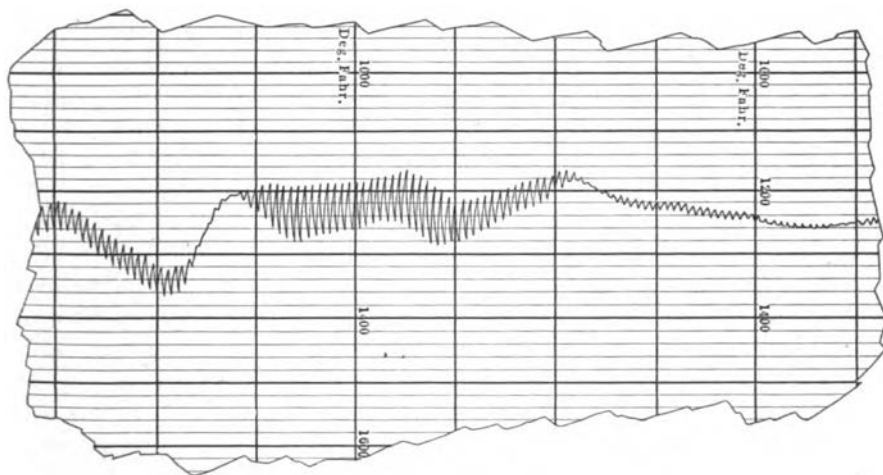

FIG. 6.—RECORD OF LEEDS & NORTHRUP DOUBLE CURVE-DRAWING RECORDER.

difficulty, and thermoelectric instruments are substituted. The principle of operation is similar to that used in automatic signaling. Electromagnetic impulses arising in the pyrometer indicator or controller are utilized to operate oil or gas valves or electric switches. In case the valve or switch is large and the electromagnetic operation requires more than a few hundred watts, electric relays are incorporated between the controller and the valve.

Automatic temperature control is complicated by the interrelation of such factors as thermal lag and the magnitude of the corrective change in heat supply during each period of reversal. The sensitivity of the control instrument determines the range of temperature that must be covered by the thermocouple (or other pyrometer) during each reversal of the valve or switch. The range of temperature covered at the source of heat is greater than this and the difference is determined by the type of



furnace, the method of heating, and the locating of the thermocouple. For closest regulation, which is best accomplished electrically, the couple must be very near if not in contact with the heater. Considering the cycle of operations, if a furnace is cooling the current will be increased when the couple has dropped a certain amount, the heater being at a still lower temperature. The current may be increased by a single step upon reaching this point or a mechanical arrangement may be used, which will continue to increase the current so long as the couple has not reached the upper limit of temperature. The single step will ordinarily give the least over-correction of heat supply and the method is the most simple to apply. It will fail to give the desired result, however, if there exists a condition of wide variation in the amount of heat absorbed or lost in the furnace operation, for in this case the heating current change during a reversal must be large. A mechanism that is always increasing or decreasing the heat supply in small steps may often be advantageous and is practically indispensable in the arrangement mentioned below for automatic control of heating or cooling rates.

In industrial equipment only the single-step method has been applied. In electric heating, the heating current is changed by opening or closing a switch, which will shunt a rheostat, change the series or parallel connections of the heater, or change the secondary side of an automatic transformer. In gas or oil heating, the supply pipe is by-passed and the control valve is placed in this shunting line.

Fig. 7 illustrates the Brown automatic temperature-control pyrometer, showing the galvanometer, motor for raising and lowering the depressor frame, and the solenoid switches. The galvanometer is the high-resistance type with 300 ohms for a base-metal couple and a scale range of  $1100^{\circ}$  C. The control is between limits 1 per cent. of the scale range in extent; that is, it will control to about  $10^{\circ}$  for the above range. The range can be lowered considerably for closer regulation, say to  $3^{\circ}$  C. without serious disadvantage. By using a method for manual correction for resistance and a low-resistance meter with a very open scale, the control may be easily perfected for less than a  $1^{\circ}$  variation. Obviously the cold junction of the thermocouple must either be buried deeply in the ground or placed in ice or a thermostated box. For temperatures below  $425^{\circ}$  C., Brown substitutes a nitrogen-gas thermometer, which makes it possible to control to  $0.2^{\circ}$  and better, with a scale range of 10 or  $15^{\circ}$  C. Fig. 8 illustrates the form of electromagnetically operated valve that has been developed. The Bristol company has also adapted the instrument described for signaling, so that it will control the furnace temperature automatically. This company has patented a valve somewhat different from the one illustrated, but designed to accomplish the same results.

The General Electric Co., in conjunction with the Leeds & Northrup Co., has developed an apparatus for automatically controlling the opera-

tion of electric furnaces for hardening steels. Fig. 9 is a wiring diagram of the control panel. This equipment automatically heats a hardening furnace up to a temperature, say  $1000^{\circ}\text{C}$ ., somewhat above that desired, say  $900^{\circ}\text{C}$ ., and holds it there until the piece being treated reaches  $900^{\circ}$ , when the furnace temperature is dropped to this value and held there. This unique operation is accomplished by placing one thermocouple,

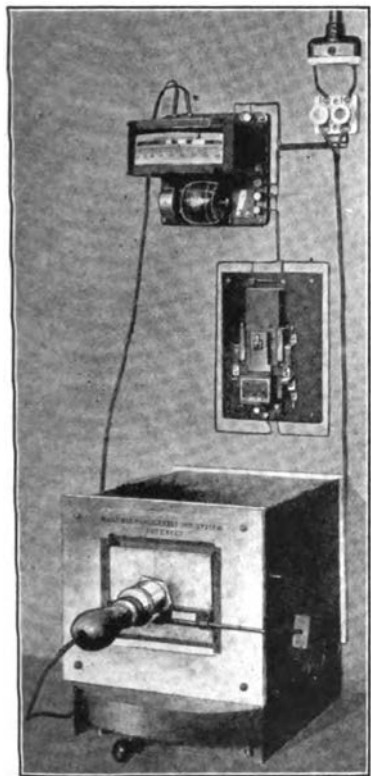

FIG. 7.—AUTOMATIC TEMPERATURE-CONTROL PYROMETER.

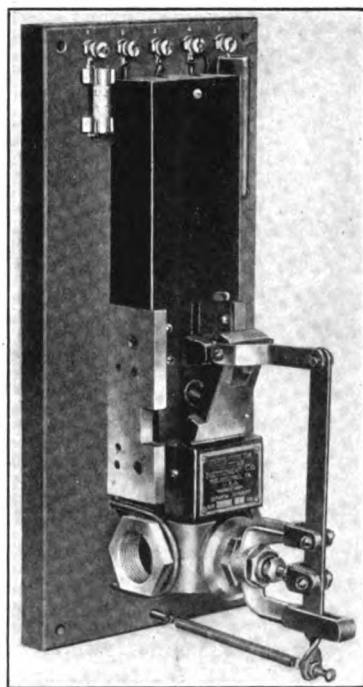

FIG. 8.—ELECTROMAGNETICALLY OPERATED GAS OR OIL VALVE.

called the contact couple, in contact with the piece, and another, called the air couple, in the furnace near the wall. The air couple is kept hot until the contact couple reaches the proper temperature when the air temperature is lowered to this value. The wiring diagram of Fig. 9 is clear upon close study of the connections and a discussion is scarcely necessary.<sup>2</sup> The

<sup>2</sup> In this diagram the following must be noted: (1) Control relays are closed when *E* is connected to 6 and *S*<sub>1</sub> is connected to 7. (2) Connecting *S*<sub>1</sub> and 7 closes the heating circuit by the magnetic switch on the left. (3) Contact thermocouple operates through contacts marked *S*<sub>1</sub>, *R*<sub>1</sub>, and *R*<sub>2</sub>, and air-couple contacts *S*<sub>2</sub>, *R*<sub>3</sub>, *RS*, and *E*. (4) *S*<sub>1</sub> and *R*<sub>2</sub> are connected and open a relay when contact-couple reaches the desired temperature.

contacts that operate the relays are opened and closed by the automatic adjustment of the potentiometer slide wire. By disconnecting either of these thermocouples and one of the control relays, the instrument may be used simply to hold a furnace at a fixed temperature. Another application of the potentiometer type of automatic controller maintains the temperature of the box ovens used in japanning at the proper point.

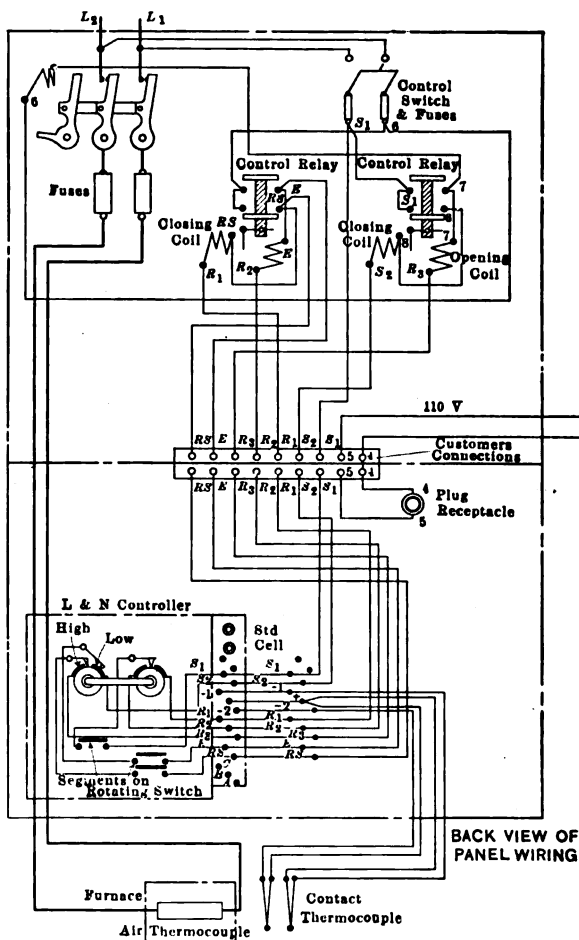

FIG. 9.—WIRING DIAGRAM OF AUTOMATIC CONTROL PANEL FOR ELECTRIC FURNACES.

It is made to control at one temperature for a certain interval and then automatically changes to another temperature and maintains this.

Still another operation can be performed with this instrument. One of the writers has constructed an apparatus that will heat or cool a furnace at a predetermined rate; the rate may be constant or a function of the temperature. This apparatus has been used in studying the annealing

of glass, especially the fine annealing of optical glass. This type of control is obtained by placing one contact on the potentiometer slide wire and the other two contacts upon a disk that is made to turn slowly at a chosen rate. The disk is turned by the controlling recorder itself, so that the whole apparatus is automatic. This principle of moving contacts is applicable to any of the controllers described, but at present such control has not been utilized industrially.

As a thermostat, the potentiometer recorder-controller can be made capable of operating upon  $0.01^\circ$  changes in the temperature of a resistance thermometer and upon less than  $0.5^\circ$  with base-metal thermocouples. Very rapid progress is properly expected in the future development of instruments for automatic temperature control at higher temperatures. The field is a comparatively new one and undoubtedly offers possibilities that are not fully appreciated at the present time.

#### SUMMARY

The general problem of the control of furnaces, kilns, ovens, tanks, etc. operated at high temperatures is intimately associated with the measurement of temperature and its variations. A knowledge of existing temperatures may be made useful by the proper selection and installation of pyrometers and a careful study of the relation of temperature variations to other factors involved in control. These general considerations have been discussed and a short description has been given of the devices used in high-temperature control.

#### DISCUSSION

R. W. NEWCOMB, New York, N. Y. (written discussion\*).—On page 446, the middle paragraph states that, in industrial equipment, only the single-step method of automatic regulation has been applied. Quite recently, there has been developed an automatic temperature regulator, operating in conjunction with a pyrometer of the thermoelectric type, in which the control is a slow regulation, with a range capable of regulating valves, dampers, rheostats, or any other rotatable member, through one or more complete revolutions. It can control two valves at the same time, with a fixed definite ratio between them.

Aside from those conditions in which it is necessary to control two valves with a definite ratio one to the other, the greatest advantage that this slow, even control will have over those controls that are either all on or all off, will be for use in connection with processes where a large temperature variation is required, extended over a considerable period of time; that is, where the temperature must be regulated along an increasing or decreasing time-temperature curve.

---

\* Received Oct. 15, 1919.

### Resistance Thermometry

BY F. W. ROBINSON,\* M. SC., NEWARK, N. J.

(Chicago Meeting, September, 1910)

THE temperature coefficient of electrical resistance of pure metals is high and therefore the resistance increases rapidly with rising temperature. In 1871, Siemens suggested the use of this property as an accurate means of temperature determination. Owing to practical difficulties, particularly the contamination of the metal and consequent permanent change in its resistance and its resistance-temperature relation, this method fell into disrepute as a practical standard until revived later by Callendar and Griffiths, and subsequently by Holborn and Wien, all of whom showed that the earlier difficulties were not inherent in the method but incident to the mode of protection of the resistance coils. Following the work of these investigators, the problem of temperature measurement by this means has been the subject of careful study and has now assumed an importance second only in practical adoption to the thermo-electric method.

It is generally recognized, both here and in Europe, that the standard temperature scale should be the thermodynamic as it permits the evaluation of high temperatures on the basis of the radiation laws of Stefan and Boltzmann, of Rayleigh, and of Wien and Planck, on a scale consistent with that obtained by means of the gas thermometer at low temperatures. Lord Kelvin showed that only a very small correction, amounting to about  $+0.7^{\circ}$  at  $1000^{\circ}$  C.—almost within the limits of experimental errors—is necessary to adjust the constant-volume nitrogen thermometer to the ideal thermodynamic scale.

On this basis the Bureau of Standards, Washington, and the National Physical Laboratory, London, have established a fixed-point scale giving fixed-point temperatures up to  $1083^{\circ}$  C., the melting point of copper in a reducing atmosphere. This scale has now been generally adopted in this country and in England, but progress in this important subject was undoubtedly hindered by the war. A most significant conference of the Bureau of Standards and the National Physical Laboratory was to have been held in Berlin in September, 1914, with the German authorities of the Reichsanstalt. The loss to science and the industries dependent on pyrometry through the enforced cancellation of the meeting has unquestionably been great.

---

\* Manager, Electrical Dept., Hanovia Chem. & Mfg. Co.

For the standardization of the resistance thermometer, we are limited, for all practical purposes, to the fixed points of the standard scale falling within the range of practical usefulness of the resistance thermometer. In the case of the platinum resistance thermometer, these are the freezing point of mercury at  $-38.88^{\circ}$  C., the melting point of ice  $0^{\circ}$ , the transformation point of sodium sulfate  $32.384^{\circ}$ , the vapor of water boiling under atmospheric pressure  $100^{\circ}$ , the boiling point of naphthalene  $217.96^{\circ}$ , the boiling point of benzophenone  $305.9^{\circ}$ , and the boiling point of sulfur  $444.5^{\circ}$ .

The temperature on the international scale  $t$  is then deduced from the formula

$$t - pt = \delta \left[ \left( \frac{t}{100} \right)^2 - \frac{t}{100} \right]$$

Where  $pt = 100 \times \left( \frac{R - R_0}{R_{100} - R_0} \right)$  and  $R$ ,  $R_0$ , and  $R_{100}$  are the measured resistances of the thermometer at temperature,  $t^{\circ}$ ,  $0^{\circ}$ ,  $100^{\circ}$ . Over the limits of this scale, the deviations of the platinum resistance thermometer from the hydrogen scale of the International Bureau lie within the limits of experimental error and for most practical purposes the correspondence is sufficiently close down to the boiling point of oxygen  $-182.9^{\circ}$  C. and up to the boiling point of copper  $1083^{\circ}$  (in reducing atmosphere). The accuracy within these wide limits, as determined by various experimenters, has shown somewhat varying results and might well be made the subject of a careful and thorough investigation. For use in making resistance thermometers, the platinum should be of such purity that the value of  $\delta$  in the above equation is not greater than 1.52, and  $\frac{R_{100}}{R_0}$  should not be less than 1.386.

#### ADVANTAGES OF ELECTRIC RESISTANCE METHOD

The resistance method of temperature determination possesses for the practical range of the instrument, as indicated in the foregoing, several very important advantages over all other methods of determination. The temperature coefficient of resistance of pure platinum is such that for an increase of temperature of  $300^{\circ}$  from  $0^{\circ}$  C. the resistance of the spiral is more than doubled and this increase is maintained at practically the same rate up to the highest temperatures. Knowing the high degree of accuracy with which electrical resistance may be determined by relatively simple apparatus, the great sensitiveness of this method is at once apparent. Using the usual Wheatstone bridge method in one or other of its forms, the temperature scale on commercial instruments can be arranged for any desired temperature interval. Taking a common type of galvanometer with a scale 5 in. (12.7 cm.) long, the instrument may be graduated,

in degrees, for a temperature scale beginning at 600° and ending at 700°. Such a scale can be read without difficulty to one-fourth of 1°. In comparison with the thermoelectric instrument in which the scale must always begin at zero, the increase in sensitiveness of the electric resistance method is very great. A further advantage of the electric resistance method is the avoidance of cold-junction errors inherent in the thermoelectric type.

#### LIMITATION OF ELECTRIC RESISTANCE METHOD

For practical purposes, the range of the electric resistance thermometer covers the field from -200° C. to +900° C. For the measurement of temperatures by this method, an outside source of current is essential; and for most of the commercial instruments of a direct-reading type, a storage battery or standard cell is used to provide this current. The care of the storage battery under circumstances where direct current is not available for charging is one disadvantage of the method. This may be overcome by the use of dry cells; but owing to the inconstancy of the dry-cell voltage, the remedy is rather worse than the disease.

#### CONSTRUCTION AND PROTECTION OF RESISTANCE SPIRALS

Platinum is most generally used as the resistance metal. It can be readily obtained in a chemically pure state and is applicable to a wide temperature range. Iridium, palladium, and rhodium have all been suggested, but are apparently not in commercial use. Nickel is sometimes used, but is not recommended for temperatures higher than 250° C., owing to the change in the temperature-resistance curve as the transition temperature of nickel is approached and to the danger of oxidation of the metal at higher temperatures. According to Marvin,<sup>1</sup> the equation  $\log R = a + mt$  holds approximately over the range 0-300° C. Molten tin was recommended in 1916 by E. F. Northrup and R. C. Sherwood,<sup>2</sup> who find that the resistance temperature relation gives a straight-line curve up to temperatures between 1600° and 1700° C.

One common method of mounting the resistance wire is that devised by Callendar, consisting of crossed serrated mica plates on which the platinum wire is spirally wound. This form is used by the Leeds & Northrup Co. and by the Cambridge Scientific Instrument Co., though in some instances Leeds & Northrup replace the mica frame by steatite. With this form of spiral, it is necessary, in order to protect the platinum from contamination, to mount it in an impervious tube such as

<sup>1</sup> Electric Resistance of Nickel to 300° C. *Phys. Rev.* (1910) **30**, 522.

<sup>2</sup> *Jnl. Frank. Inst.* (1916) **182**, 493.

glazed porcelain, usually protected on the outside by a tube of iron or nickel. For very high temperatures, the Leeds & Northrup Co. uses a form of potential lead thermometer. Heavy wire is used in the coil and is freely suspended between steatite disks. Owing to its very low resistance, special precautions are necessary with this instrument to obtain a satisfactory degree of sensitivity.

Another type of spiral is that manufactured by the Hanovia Chemical & Mfg. Co., in which the platinum spiral is wound on a thin tube of transparent quartz with an outer jacket of transparent quartz melted down on to the inner core so that the platinum wire is firmly embedded in the quartz. This construction gives an instrument of very small volume in which the resistance wire is thoroughly protected from the contaminating influence of dirt and reducing gases. Owing to the small volume of the instrument, this form of thermometer follows temperature changes very rapidly and each spiral can be accurately adjusted to a standard resistance within 0.04 per cent. This standardization of the resistance coil obviates the necessity of auxiliary manganin coils in the headpiece used with other types of resistance thermometers. For the most accurate calorimetric work, this construction is not recommended, owing to the slight change in the constants of the equation. This change, however, is not of sufficient magnitude to impair the accuracy for ordinary laboratory and industrial measurements. As mounted for industrial use in a steel or copper tube, or in a perforated sheath for air temperatures, the quartz resistance thermometer forms a very rugged and convenient instrument.

When measuring at relatively high temperatures, the resistance of the thermometer leads, graduating from the high temperature to be measured down to the comparatively cool headpiece, requires special precautions to avoid the introduction of errors. In the quartz thermometers of the Hanovia Chemical & Mfg. Co., this source of error is obviated by terminating the leads immediately above the spiral and continuing the electrical connection with the headpiece through heavy metal rods of low-temperature coefficient. The method originally suggested by Siemens and adopted by Leeds & Northrup Co. for industrial use consists of a third lead of the same wire connected on the upper end of the thermometer spiral to one of the thermometer leads proper. This loop is connected in series with the balancing resistance of the bridge and accurately compensates the lead resistance where a zero-deflection instrument is used. In a direct-reading Wheatstone bridge, however, the relation of the thermometer resistance to the fixed resistance is slightly altered by this arrangement and a small error remains in the reading. Appended is a table showing the resistance, up to 900° C., of platinum thermometers having a resistance 25 or 50 ohms at the temperature of melting ice.



RESISTANCE THERMOMETRY

TABLE 1.—Resistance Values for Quartz Resistance Thermometers

$$R_t = R_0 (1 + \alpha t + \beta t^2)$$

| Degrees C. | 50 $\Omega$ at 0 Degree | Difference | Degrees C. | 50 $\Omega$ at 0 Degree | Difference |
|------------|-------------------------|------------|------------|-------------------------|------------|
| -200       | 9.50                    | ....       | +400       | 123.60                  | 1.72       |
| 190        | 11.58                   | 2.08       | 410        | 125.31                  | 1.71       |
| 180        | 13.66                   | 2.08       | 420        | 127.02                  | 1.71       |
| 170        | 15.73                   | 2.07       | 430        | 128.72                  | 1.70       |
| 160        | 17.79                   | 2.06       | 440        | 130.42                  | 1.70       |
| 150        | 19.85                   | 2.06       | 450        | 132.10                  | 1.68       |
| 140        | 21.90                   | 2.05       | 460        | 133.78                  | 1.68       |
| 130        | 23.95                   | 2.05       | 470        | 135.46                  | 1.68       |
| 120        | 25.99                   | 2.04       | 480        | 137.13                  | 1.67       |
| 110        | 28.03                   | 2.04       | 490        | 138.79                  | 1.66       |
| -100       | 30.06                   | 2.03       | +500       | 140.45                  | 1.66       |
| 90         | 32.08                   | 2.02       | 510        | 142.10                  | 1.65       |
| 80         | 34.09                   | 2.01       | 520        | 143.75                  | 1.65       |
| 70         | 36.10                   | 2.01       | 530        | 145.39                  | 1.64       |
| 60         | 38.11                   | 2.01       | 540        | 147.02                  | 1.63       |
| 50         | 40.11                   | 2.00       | 550        | 148.65                  | 1.63       |
| 40         | 42.10                   | 1.99       | 560        | 150.27                  | 1.62       |
| 30         | 44.08                   | 1.98       | 570        | 151.88                  | 1.61       |
| 20         | 46.06                   | 1.98       | 580        | 153.49                  | 1.61       |
| 10         | 48.03                   | 1.97       | 590        | 155.09                  | 1.60       |
| $\mp$ 0    | 50.00                   | 1.97       | +600       | 156.69                  | 1.60       |
| 10         | 51.96                   | 1.96       | 610        | 158.28                  | 1.59       |
| 20         | 53.91                   | 1.95       | 620        | 159.86                  | 1.58       |
| 30         | 55.86                   | 1.95       | 630        | 161.44                  | 1.58       |
| 40         | 57.80                   | 1.94       | 640        | 163.01                  | 1.57       |
| 50         | 59.74                   | 1.94       | 650        | 164.57                  | 1.56       |
| 60         | 61.67                   | 1.93       | 660        | 166.13                  | 1.56       |
| 70         | 63.59                   | 1.92       | 670        | 167.68                  | 1.55       |
| 80         | 65.51                   | 1.92       | 680        | 169.23                  | 1.55       |
| 90         | 67.42                   | 1.91       | 690        | 170.77                  | 1.54       |
| +100       | 69.33                   | 1.91       | +700       | 172.30                  | 1.54       |
| 110        | 71.23                   | 1.90       | 710        | 173.83                  | 1.53       |
| 120        | 73.12                   | 1.89       | 720        | 175.35                  | 1.52       |
| 130        | 75.00                   | 1.88       | 730        | 176.86                  | 1.51       |
| 140        | 76.88                   | 1.88       | 740        | 178.37                  | 1.51       |
| 150        | 78.76                   | 1.88       | 750        | 179.88                  | 1.51       |
| 160        | 80.63                   | 1.87       | 760        | 181.38                  | 1.50       |
| 170        | 82.49                   | 1.86       | 770        | 182.87                  | 1.49       |
| 180        | 84.34                   | 1.85       | 780        | 184.35                  | 1.48       |
| 190        | 86.19                   | 1.85       | 790        | 185.82                  | 1.48       |
| +200       | 88.03                   | 1.84       | +800       | 187.30                  | 1.47       |

**TABLE 1.**—*Resistance Values for Quartz Resistance Thermometers  
 (Continued)*

| Degrees C. | 50 Ω at 0 Degrees | Difference | Degrees C. | 50 Ω at 0 Degrees | Difference |
|------------|-------------------|------------|------------|-------------------|------------|
| 210        | 89.87             | 1.84       | 810        | 188.77            | 1.47       |
| 220        | 91.70             | 1.83       | 820        | 190.23            | 1.46       |
| 230        | 93.52             | 1.82       | 830        | 191.68            | 1.45       |
| 240        | 95.34             | 1.82       | 840        | 193.13            | 1.45       |
| 250        | 97.15             | 1.81       | 850        | 194.57            | 1.44       |
| 260        | 98.96             | 1.81       | 860        | 196.01            | 1.44       |
| 270        | 100.76            | 1.80       | 870        | 197.44            | 1.43       |
| 280        | 102.56            | 1.80       | 880        | 198.86            | 1.42       |
| 290        | 104.35            | 1.79       | 890        | 200.28            | 1.42       |
| +300       | 106.13            | 1.78       | +900       | 201.69            | 1.41       |
| 310        | 107.90            | 1.77       |            |                   |            |
| 320        | 109.67            | 1.77       |            |                   |            |
| 330        | 111.43            | 1.76       |            |                   |            |
| 340        | 113.19            | 1.76       |            |                   |            |
| 350        | 114.94            | 1.75       |            |                   |            |
| 360        | 116.68            | 1.74       |            |                   |            |
| 370        | 118.42            | 1.74       |            |                   |            |
| 380        | 120.15            | 1.73       |            |                   |            |
| 390        | 121.88            | 1.73       |            |                   |            |
| +400       | 123.60            | 1.72       |            |                   |            |

**COMMON TYPES OF MEASURING APPARATUS**

Any of the usual methods of measuring electrical resistance may be applied to resistance thermometers. For precision work, where high laboratory standards of accuracy are required, either the Kelvin double bridge may be used or the potential drop measured across the terminals of the thermometer. A very sensitive arrangement is the thermometer bridge designed by the National Bureau of Standards and manufactured by the Leeds & Northrup Co. using a four-lead thermometer to compensate for the temperature rise in the thermometer leads.

For most industrial instruments, however, the method in vogue is almost universally some modification of the Wheatstone bridge. The method of the Hanovia Chemical & Mfg. Co. and of the Cambridge Scientific Instrument Co., as shown in Fig. 1, gives the favorite form of direct temperature reading instruments. All the resistance coils, *I*, *II*, and *III* of the bridge are of fixed value and the variations in the thermometer temperature are graduated on the galvanometer, in temperature degrees. By selecting the corresponding resist-

ance values for the coil *III*, the temperature scale is so arranged as to begin at any desired temperature.

The other system in current use is that of the ohmmeter. This method is used by the Leeds & Northrup Co., by Paul of London, by Carpentier, and others. In it a variable resistance, that of the thermometer, is balanced against a known resistance by means of a zero-point galvanometer reading. The temperature scale is usually indicated by a dial and pointer on the resistance box. For temperature indicating in shop practice, the Leeds & Northrup Co. use a slide-wire balancing resistance marked in degrees of temperature with a center zero voltmeter as the indicator. The slide-wire resistance is adjusted to correspond to the temperature desired in the furnace and the indicator shows a deflection + or - according as the furnace temperature is higher or lower than that for which the balancing resistance is set. When the indicator needle

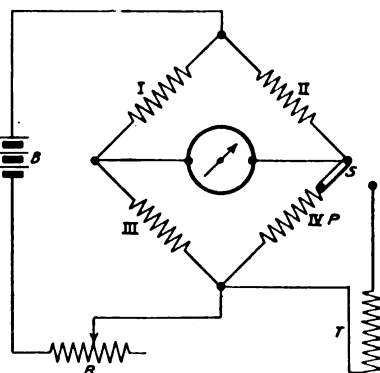

FIG. 1.—COMMON ARRANGEMENT OF RESISTANCES OF DIRECT TEMPERATURE-READING INSTRUMENTS.

is in the center, the bridge is in equilibrium and is independent of the voltage of the applied current. The instrument is therefore made to use lighting-circuit current. For the control of certain types of furnace, this arrangement gives a convenient and satisfactory instrument; but for the measurement of unknown temperatures, the constant adjustment of the balancing resistance is somewhat annoying and the temperature variations + or - are vitiated by voltage fluctuations, which always occur in commercial lighting circuits.

In the direct-reading type of measuring instrument, a recording galvanometer is often substituted for the indicating type and most manufacturers put out such instruments either for recording on a single thermometer, or, through the medium of an automatic switch arrangement, for recording on a number of points simultaneously on a running paper chart. Records of the individual thermometers are either num-

bered or are made of different colors to identify the record of the respective thermometers.

All in all, the platinum resistance thermometer over the range for which it is applicable ( $-200^{\circ}$  to  $+900^{\circ}$  C). provides the most convenient and reliable method of temperature determination and record, particularly where the measurements are required at one central point or at some distance from the source of heat. They possess, generally speaking, a much greater freedom from errors liable to be overlooked in other types of instruments. With reasonable care in use, they are little subject to disturbance in operation, can be calibrated for any temperature scale, and with suitable protection almost any degree of sensitiveness can be secured for any desired temperature range.

Some of the more important industrial applications of the resistance thermometer are: Marine, railway, and stationary refrigerating plants, both for control of the operating temperatures of the refrigerating plant and of the cold storage rooms; drying ovens of various types, such as photographic-film drying rooms, core ovens, baking ovens for enamel, metal, and leather, and wood-drying kilns; the control of the lehr temperatures in glass annealing; the control of reaction temperatures in the manufacture of sulfuric acid by the contact process; the control of fractionating temperatures in oil refineries; for boiler testing, flue gases, feedwater, and superheater temperatures as well as the temperature of the bearings in turbine engines; and the control of innumerable chemical processes.

## Resistance Thermometry for Industrial Use

BY CHARLES P. FREY,\* PHILADELPHIA, PA.

(Chicago Meeting, September, 1919)

THE fundamental principle of resistance thermometry lies in the determination of temperatures by the measurement of an electrical conductor subjected to various temperatures and the translation of the resultant changes, in ohms, into temperature equivalents. Such resistance measurements can be made with maximum precision by the use of a standard Wheatstone bridge and a reflecting galvanometer of high sensitivity. Under such conditions, results are obtainable that may be accurate within 0.1 or even 0.01 per cent., and the "idiosyncrasies" of heated electrical conductors can be studied with advantage and profit, even if the latter is not of a financial nature.

The chief requisites for producing a serviceable commercial instrument may be enumerated as follows: First, there must be a resistor or "bulb" that can stand the maximum temperature without deterioration and which has a pronounced temperature coefficient. Second, there should be constructed an "even" bridge, having two fixed arms of equal values, in ohms. Third, a rheostat, the maximum resistance of which will be equal to the total change in the resistance of the bulb, between temperature extremes, is required. Fourth, there must be a sensitive galvanometer which is aperiodic, or nearly so. Finally, there should be a fairly steady source of direct current.

The general scheme of this type of apparatus, in its simplest form, can be readily understood by reference to Fig. 1. Resistors *A* and *B* are constructed of manganin, therlo, or some other resistance wire having a negligible temperature coefficient. The sensitive D'Arsonval galvanometer *G* has its zero in the center. *R* is a rheostat and *X* is a resistor or bulb made of insulated platinum wire, or else of nickel, copper, or some alloy, according to requirements. *K* is a battery, but a direct-current service line is often used instead, with sufficient ballast in series to properly reduce the current.

The operation of the instrument is very simple. All that is necessary is to insert the bulb in a source of heat and adjust the rheostat until the pointer of the instrument is at zero. The temperature of *X* is then determined by reading a scale fastened in front of the rheostat. A number of bulbs may be used with one instrument, placed at different distances

---

\* Chief Electrical Engineer, The Brown Instrument Co.

and connected by means of leads with a switch, so that their indications may be read successively. But in order that the resistance of these leads may not introduce an error in the indications of the instrument, the arrangement has to be somewhat modified, as shown in Fig. 2. Leads  $L$  and  $L^2$  connect the bulb with the instrument and  $L^1$  connects the galvanometer as shown. Leads of equal resistance are hence added to  $R$  and  $X$ .

But, in dealing with the foregoing conditions in the construction of resistance thermometers for practical purposes, consideration must be given to the fact that the user wants an instrument that is direct reading, accurate, and convenient. The first question that arises is: "What constitutes accuracy?" If the manufacturer can guarantee that the indications of the apparatus are correct, such a statement will content most prospective purchasers. But, if we consider construction as a whole

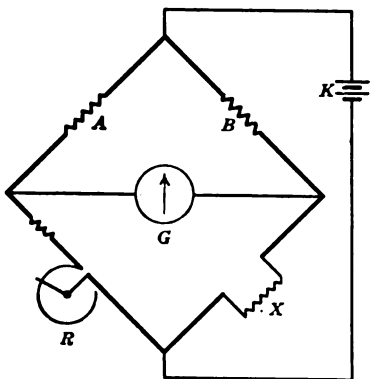

FIG. 1.

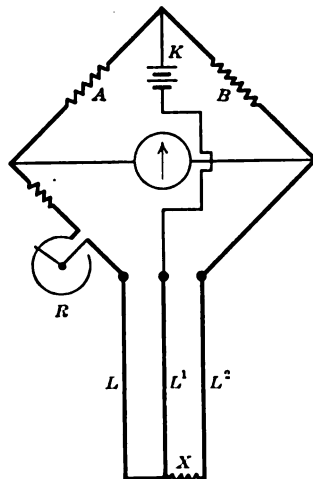

FIG. 2.

from the technical standpoint, it will be well to bear in mind that the maximum degree of accuracy attainable depends, from the very outset, on how closely the thermometric scale of the indicator may be read. For instance, if the scale is 12 in. (30.48 cm.) long, the subdivisions are uniform, and each subdivision is equivalent to  $\frac{1}{16}$  in. (1.58 mm.), the limit of accuracy near the upper end of the scale is 1 part in 200. Temperatures may, therefore, be determined within 0.5 per cent., or possibly 0.25 per cent., by interpolation. They can be read even closer, if the galvanometer is calibrated. But in any event, within these limitations we need not concern ourselves unduly about Lord Kelvin's thermodynamic scale, or its relation to the constant-volume hydrogen thermometer.

Among the problems assigned to our experimental department during

the past 12 mo. were two relating to resistance thermometry, which were of interest because extreme opposite conditions had to be met. The first of these was the production of an apparatus having a range of  $0^{\circ}$  to  $850^{\circ}$  F. ( $-18^{\circ}$  to  $454^{\circ}$  C.) which was to be used with eight interchangeable bulbs, for the determination of flue temperatures.

The main consideration was the selection of suitable materials for constructing the bulbs. Platinum wire would doubtless have been best, but owing to cost and war conditions it was practically unprocurable. A wire said to be pure nickel, but which actually contained some slight impurities, as was found later, was used; but these impurities were not a detriment under the circumstances. This wire was wound upon threaded lava insulators about 1 in. (25 mm.) long, and  $\frac{1}{2}$  in. diameter, forming the bulbs, and these bulbs were then adjusted to equal values at  $32^{\circ}$  F. They were next coated with a thin layer of cement, consisting chiefly of quartz and carborundum. After being provided with copper leads of large diameter, they were placed in a calorimeter and heated to a temperature of  $900^{\circ}$  F. This operation was repeated several times until it was certain that they had become "aged," and that their respective resistances were fixed at any temperature. An intercomparison by bridge measurements established the fact that while differences in their individual resistances and temperature coefficients existed, both at scale extremes and at intermediate stages, such differences did not exceed 0.1 per cent., and, consequently, were well within the observable limit of accuracy of the scale calibration. It was also found that it would be comparatively easy to produce additional bulbs with different samples of nickel, by the well-known method of adding a small resistor of manganin, which could be placed most conveniently in the head of the protecting tube containing the bulb, so that it would not be damaged by the higher temperatures.

It should be added that the subdivisions of the scale were not uniform but progressively larger from  $0^{\circ}$  to  $500^{\circ}$ , after which they diminished, being of about the same width at  $800^{\circ}$  as at  $100^{\circ}$  F. Since the normal temperatures to be measured were about  $600^{\circ}$  F. ( $315^{\circ}$  C.) the scale had the widest divisions where it was most used, which was an almost ideal condition. The extreme change in the resistance of these bulbs was approximately 38 ohms for  $750^{\circ}$  F.; hence it was comparatively easy to construct a finely divided helical rheostat to counterbalance these changes.

A galvanometer of sufficient sensitivity to respond to the smallest observable change in the scale index was produced by using a light three-layer copper-wire coil. The resistance of this coil was approximately 50 ohms; and since current for the operation of this apparatus was obtained from a 110-volt, direct-current, service line, 10,000 ohms or more of ballast resistance was used in series so that the galvanometer had a

negligible temperature coefficient. This apparatus has been in successful operation for nearly 10 months.

Another instrument, designed and constructed to meet unusual conditions, was a precision resistance thermometer having a range of only  $6^{\circ}$ , namely from  $-1^{\circ}$  to  $+5^{\circ}$  C. We were informed that this apparatus was to be used for determining "frazil" temperatures. Reference to the dictionary revealed the fact that "frazil" is idiomatic Canadian French, and is used in referring to ice under water, or "anchor ice." Now, we have been, and still are under the impression that ice floats, and that its temperature is never above  $0^{\circ}$  C., so we assumed that the outfit must also have been intended to test water near the freezing point. The specifications called for a bulb protected with a copper tube at least 10 ft. (3 m.) long and hermetically sealed. This was to be connected with the instrument by means of about 75 ft. (22 m.) of highly insulated triple-conductor wire.

The main obstacles to be overcome in the successful construction of this apparatus were due to the narrow range of scale and the problem of insulation. In ordinary cases, when the scale range is about  $650^{\circ}$  C. the average change in the resistance of a standard platinum bulb is approximately 0.068 ohm per degree centigrade. If such a bulb were used in this instrument it would give a total change in its resistance of only about 0.4 ohm for  $6^{\circ}$  C. Under such conditions, the rheostat would also have to have a resistance of approximately 0.4 ohm; and in order to obtain sufficient galvanometric sensitivity, it would be necessary to pass an excessive current through the bulb, producing a heating effect and introducing a "variable" that would cause a radical error in the scale reading.

Another problem that called for consideration was due to the fact that while, theoretically, it is easy to determine temperatures near  $0^{\circ}$  C., this cannot be done empirically with accuracy, without setting up a rather elaborate outfit. To minimize this difficulty, we decided to use pure electrolytic copper wire specially prepared and having a constant temperature coefficient of  $0.00393^{\circ}$  C. at  $0^{\circ}$  C. This wire was wound upon a hollow cylinder of very thin copper tubing, about  $\frac{1}{4}$  in. (6 mm.) in diameter and 7 in. (17 cm.) long. The cylinder was first given a thin coating of silk and insulating varnish. The wire, which was of very small diameter, was also silk covered. After the bulb had been constructed in this manner, it was impregnated with insulating compound and then alternately baked and frozen, until it was "aged." It was then adjusted to 2600 ohms at  $0^{\circ}$  C. Its temperature coefficient was next determined between  $20^{\circ}$  C. and  $-1^{\circ}$  C. and again between  $-1^{\circ}$  and  $+5^{\circ}$  C. Hence the increase in resistance at any temperature between  $-1^{\circ}$  and  $+5^{\circ}$  C. could be determined by  $2600 \times [1 + (0.00393 \times \text{temperature})]$ . The total change in resistance between  $-1^{\circ}$  and  $+5^{\circ}$  C. was very nearly 60 ohms. This permitted the construction of a rheostat to be used in the indicating



instrument having a resistance of 10 ohms per degree centigrade or 0.2 ohm per scale division. Consequently the instrument would be sensitive and the required galvanometric deflections were obtained when a current of less than 5 milliamperes was passing through the bulb. The maximum P. D. at the bulb terminals was 13 volts, and the  $C^2R$  loss was 0.065 watt, which was a negligible factor.

But since the scale of the instrument was about 11 in. (28 cm.) in length, and was subdivided to permit the determination of temperature to  $\frac{1}{50}^\circ$  C., it was necessary to provide an extremely sensitive aperiodic galvanometer. For this purpose a pivoted movable system was used, the coil of which was made of aluminum alloy wire, coated with specially prepared enamel, only 0.0003 in. (0.007 mm.) thick, and equipped with delicate springs and a hollow knife-edged pointer, also of aluminum. The weight of this movable system was only 430 milligrams. The scale of this instrument was then calibrated on a Wheatstone bridge by using the bulb resistance equivalents already referred to.

The final operative tests were made as follows: The bulb terminals were soldered to the ends of the triple conductor wire and it was lowered to the bottom of the copper protecting tube, which was provided with a covered funnel-shaped head. Then the tube and funnel were filled with an insulating compound having a negligible expansion coefficient below  $40^\circ$  C. A test with 110-volt direct current proved that the insulation resistance between the bulb and the outer casing was over 70 megohms. After completion the apparatus was tested by placing the bulb and a sensitive thermometer in a freezing mixture.

Before shipment, when the temperature of the outside air happened to be a little above  $0^\circ$  C. the bulb was hung out of a window and the temperature measured. It was then found that there was practically no lag in the response of the bulb to temperature changes, since if the tip of a finger was placed on the lower end of the protecting tube, the galvanometer would be immediately thrown out of balance and would almost instantly return to normal when the finger was removed.

## DISCUSSION

G. A. ROUSH,\* South Bethlehem, Pa. (written discussion†).—Mr. Frey is correct in his impression that ice floats, but "frazil" ice happens to be the exception to the rule. The requirements for the formation of frazil ice seem to be a clear, cold night and water on a bed of clean rock. The exact causes of its formation are not definitely known, but are supposed to be somewhat as follows. The rock bottom has a greater emissive power for radiant heat than the surface of the water, hence, on a clear,

\* Assistant Professor of Metallurgy, Lehigh University. † Received Oct. 18, 1919.

cold night, when conditions are most favorable for the loss of heat from the surface of the earth by radiation, the rock cools faster than the water over it, due to the greater radiating power of the rock and the partial transparency of the overlying water to the radiant heat. This may result in the formation of a film of ice of considerable thickness forming in contact with, and adhering to the rock, without the surface of the water having even reached the freezing point. When the sun strikes the spot the next morning, a reversal of the action takes place and the rock warms up faster than the overlying water, with the result that the surface of the rock soon becomes warm enough to melt the film of ice in immediate contact with the rock, and the whole mass then floats to the surface.

## Tin: An Ideal Pyrometric Substance

BY E. F. NORTHRUP,\* TRENTON, N. J.

(Chicago Meeting, September, 1919)

THESE brief notes respecting the properties of pure tin that make it useful as a pyrometric substance summarize information gathered by the writer in an extensive experimental investigation on the electrical properties of metals in the molten state.

Tin in quantities sufficient for pyrometric purposes may be obtained at relatively low cost and in a state of high purity. The metal melts at 232° C. and, according to determinations made by Greenwood, 1909, does not begin to boil until a temperature of 2270° C. is reached. The writer can assert, from personal observations carefully made, that tin shows no tendency to boil at a temperature of 1680° C. If Greenwood's observations are correct the temperature interval, 2038° C., in which tin exists as a liquid under atmospheric pressure, exceeds that of any other substance.

It has never been observed, as far as the writer is aware, that tin forms any chemical union, as carbide, with carbon at the highest temperatures at which it can exist as a liquid. It is quite certain from the writer's personal observation that tin heated in Acheson graphite to 1680° C. remains chemically uncontaminated.

Wires of pure tungsten do not dissolve in molten tin at temperatures at least as high as 1680° C. Tungsten wires or rods may, therefore, be used as electrodes dipping into molten tin when required for measuring the resistance of the molten metal at very high temperatures.

When tin is raised to a high temperature in a covered graphite container, the CO atmosphere that exists above its surface has a reducing action, which maintains this surface of mirror brightness. Incidentally, tin maintained molten in a crucible of Acheson graphite makes a most excellent bath into which may be inserted several pyrometers that are to be intercompared at the same temperature.

But the two properties of tin that, in its molten state, make it particularly valuable as a pyrometric substance, are the strictly linear character of the increase of a given volume in resistivity with increase in temperature and the decrease of a given volume in density with increase in temperature. The increase in the resistivity of tin in the molten state has been studied by the writer with very great care and he can assert positively that up to a temperature at least as high as 1680° C., and very probably beyond this temperature, the resistivity of the metal increases

---

\* President, Pyroelectric Instrument Co.

linearly with increase in the temperature. The same can be asserted in regard to the decrease in the density with increase in temperature.

When the coefficients have once been accurately determined, assuming that suitable methods are available for accurately measuring either the resistivity of the tin or the expansion of a given volume of the tin, one can in the former case deduce the absolute temperature and in the latter case the change in the absolute temperature.

Methods for accomplishing these results in a practical way have been described by the writer in numerous publications. The most refined method and the one yielding the most accurate results in an exceedingly simple manner for determining the relation between temperature and resistivity has been given in a paper by Northrup and Sherwood.<sup>1</sup> A method for determining the expansion of tin or its decrease in density with increase in temperature has been outlined by the writer.<sup>2</sup>

There is no more reason why one should go back to the volume expansion or increase in pressure of a given quantity of gas as a final standard of temperature than that one should go back to a pure element like tin as a final standard, provided the properties of this latter substance are related to temperature in a manner as simple as the former. It is now, at least in the writer's mind, quite as certain that the resistivity of a given volume of molten tin is related by a straight-line law to the absolute temperature as is the pressure of a given volume of gas. Gas thermometry, for practical reasons, ends at the melting temperature of palladium, 1550° C., while there are no practical limitations to prevent the accurate determination of an absolute temperature by measuring the resistivity of a definite volume of tin when the temperature is at least as high as 1680° C. and probably as high as the melting point of platinum.

If at the time the writer's researches were made on the resistivity of molten metals a high frequency induction furnace had been available in its present perfected form for laboratory use, all his determinations could have been made with much greater ease and rapidity and higher temperatures could have been obtained. It is earnestly hoped that some investigator with the simple means now at his disposal will make a redetermination of the melting points of the higher melting metals in terms of the known resistivity of pure tin.

## DISCUSSION

P. D. FOOTE, Washington, D. C.—Another metal very similar to tin in respect to the long temperature range for the liquid phase is gallium. This metal is liquid at room temperature and has a boiling point probably near 2000° C. It appears much like mercury except that it wets glass.

<sup>1</sup> New Methods for Measuring Resistivity of Molten Materials: Results for Certain Alloys. *Jnl. Frank. Inst.* (Oct., 1916) **182**, 477.

<sup>2</sup> Production of High Temperature and Its Measurement. *Trans. Faraday Soc.* (1918) **13**.

## Thermocouple Installation in Annealing Kilns for Optical Glass

BY E. D. WILLIAMSON,\* M. A., B. SC., AND H. S. ROBERTS,\* WASHINGTON, D. C.

(Chicago Meeting, September, 1919)

DURING the wartime rush to prepare the glass necessary for the needs of our army and navy, the problem of the temperature control of the annealing kilns became most serious. The narrow limits of strain allowable (all the specifications called for less internal strain than the average of the previously used German glass) made necessary a very exact procedure and the methods had to be used on a much larger scale than theretofore. At the Charleroi plant of the Pittsburgh Plate Glass Co., the members of the staff of the Geophysical Laboratory, which was coöperating with the company, had occasion to study the methods available, and reached a number of conclusions (many of them by no means new except in their application) that may interest and assist those who have to meet similar problems in other fields. The following is a short account of the essential features of the system of temperature control evolved, along with a rather abridged statement of the reasons that led to the adoption or rejection of various schemes.

### REASONS FOR USING THERMOCOUPLES

In the annealing of optical glass, temperatures up to 650° C. have to be measured with an accuracy of better than 5° and with a sensitivity exceeding this; a 10° error will practically double<sup>1</sup> the time necessary for the annealing of the glass. The sensitivity is necessary since the cooling rate must be carefully regulated during the beginning<sup>1</sup> of the cooling.

The conditions at once limit us to two measuring devices for the temperature: the thermocouple and the resistance thermometer. Either device will fulfil the conditions, and we chose thermocouples for the following subsidiary reasons: (1) Heavy wires may be used, so that there is no danger from rough handling. (2) Large numbers of duplicate couples may be prepared without the need of any skill, while the preparation of resistance thermometers calls for delicate workmanship. If the couples are made from the same spool of wire, the calibration curves will be sufficiently close to render calibration of individual couples unnecessary until they have been used for some time or under bad conditions. (3)

\* Physical Chemist, Geophysical Laboratory, Carnegie Institution of Washington.

<sup>1</sup> The data collected on these points will be published very shortly by L. H. Adams and E. D. Williamson.

The installation is somewhat cheaper. (4) A large variety of well-made electrical instruments is available to cover most of the possible requirements.

### CHOICE OF KIND OF WIRE

Since the temperatures to be measured are comparatively low, it is unnecessary to use the expensive rare-metal couples such as platinum-platin-rhodium (Pt: 90 Pt - 10 Rh), which is the combination most used in scientific high-temperature work. The sensitivity of this couple is also rather low.

There are two main factors to be considered in addition to those previously mentioned: reproducibility and length of service under given conditions. The first of these gives support to the idea of using pure metals. There are, however, very few combinations of this kind that give the necessary sensitivity<sup>2</sup> and none of these would last long at the required temperature. Nickel-iron<sup>3</sup> gives fair service if the atmosphere is not too oxidizing. By using alloys, it is possible to get the required sensitivity and service but, of course, the reproducibility is not so good, although quite good enough for many purposes.

The three most generally useful combinations<sup>4</sup> are copper-constantan, iron-constantan, and chromel-alumel. The first is good only at temperatures up to 300° C. or thereabouts, but either of the others gives good service up to about 1000° C., except that the iron must not be in an oxidizing atmosphere and the last combination should not be used in a reducing atmosphere. For our particular use we chose chromel-alumel (supplied by the Hoskins Co.) as it met all our requirements and could be put to use in some other furnaces where we had an oxidizing atmosphere quite unsuited for an element with iron in it.

### CHOICE OF ELECTRICAL INSTRUMENT

There remains the question of the type of measuring instrument, of which three must be considered: Direct-reading millivoltmeters, potentiometers, and instruments on the same principle as the "Pyrovoltmeter." The direct reader may be neglected where accurate work is called for. In our opinion it is the direct cause of innumerable troubles and costs, in a short time, far more than the difference in initial cost between it and a better type of instrument.

The potentiometer has one drawback: it requires that a constant, though very small, current be kept passing through its coils while measure-

---

<sup>2</sup> See paper by L. H. Adams, this volume.

<sup>3</sup> The changes in the slope of the thermoelectric-temperature curve due to inversion points in the metals are awkward although not fatal.

<sup>4</sup> For relative sensitivities, see L. H. Adams, *op. cit.*

ments are being made. It is sufficient to adjust the current once a day by balancing the battery against a standard cell. On the other hand, provided the standard cell is kept balanced, there is no possible way of reading wrong with the potentiometer,<sup>5</sup> if a reading is got at all it must be right. This constitutes its great advantage. We found it easy to get the average American workman to understand the reason for the settings and had little trouble on account of mistakes by the temperature readers. A more serious objection to the standard cell is that it does not stand excessive changes of temperature and may easily be ruined some cold winter night. This we found really troublesome in the case of the portable

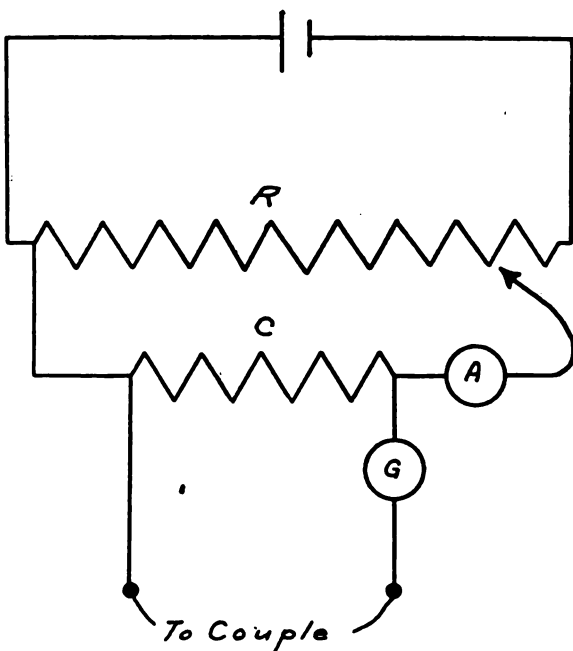

FIG. 1.—SET-UP FOR VARIABLE-CURRENT TYPE OF POTENTIAL MEASURER. IN THE "PYROVOLTER" ONLY ONE ELECTRICAL INSTRUMENT IS USED. AN EXTRA RESISTANCE AND A SWITCH ARE ADDED SO THAT THE RESISTANCE AND INSTRUMENT CAN TAKE EITHER THE POSITIONS A AND G OR G AND A.

instruments during the winter of 1917-18. This suggests the use of an instrument which does not need a standard cell. At least a partial answer is found in instruments on the same principle as the pyrovolter.

An instrument of this kind consists of three parts: a fixed resistance, a galvanometer, and an ammeter. A battery is also needed with suitable resistances to cut down its current. The connections are represented in Fig. 1. The variable resistance  $R$  is varied until no current passes

<sup>5</sup> See W. P. White (this volume) for a discussion of the potentiometer used in this type of work.

through  $G$ . The fall of potential through  $C$  (the fixed resistance) must then be equal to the thermo-electromotive force of the couple. By Ohm's law this is equal to the product of the current (as read at  $A$ ) and the resistance  $C$ . The resistance  $C$  being fixed, the current immediately gives a reading of the voltage and hence of the current. If  $C$  is small it is not necessary to read very small currents; *e.g.*, if  $C$  is 0.01 ohm, a current of 1 milliamperere, which is well within the sensitivity of possible measurement, would represent a voltage of 0.01 millivolt in the thermocouple. This type of instrument is capable of practically unlimited sensitivity and will probably prove very popular if a well-designed instrument is put on the market. The attempts to put a portable instrument of this type on the market have not, in our opinion, been successful, owing to the attempt to economize more than was possible. It is useless to try to use one and the same electrical instrument both as ammeter and galvanometer and expect to get good results, since the very features that are desirable for the one use are undesirable for the other.

#### ARRANGEMENT OF LEADS AND OTHER APPARATUS

There were in one room eleven kilns, in a second twenty kilns, and in a third four kilns. It was, however, never necessary to read the temperature in all of these simultaneously. We immediately determined on having a central booth to which every element could be connected. This arrangement seemed much preferable to the system of having an instrument in each room, as it allows all the readings to be made conveniently by one man per shift and recorded by him. It also makes possible the automatic recording of the temperature in any special kilns. It necessitates, however, a large amount of wiring and may seem a little complicated to a new hand who has not seen the stages of development.

In considering the disposition of the lead wires, it is necessary to refer for a moment to the simplest principles of the thermocouple. If a circuit consists of two metals as in *a*, Fig. 2, and there is a difference of temperature between the junctions of the metals  $J_1$  and  $J_0$ , a definite electromotive force is set up in the circuit. If a cut is made at a point in the circuit, as in *b*, and a potentiometer is inserted to read the potential, the difference in temperature between the hot and cold ends may at once be measured. In practise, one junction is kept at a constant temperature. The only necessary precaution is to see that the ends  $A$  and  $A'$  remain at the same temperature, as otherwise additional thermoelectric forces may be generated by the differences.

When a number of couples are being used, it is convenient to use a single constant-temperature junction for several of the variable junctions. This necessitates a switch or plug system for bringing it in the necessary circuit. The last two diagrams, *c* and *d*, show two of the schemes used



at the Charleroi plant. In one case *c*, the lead from the constant-temperature junction  $J_0$  and the similar leads from the variables  $J_1, J_2, J_3$  were led to terminals  $A', A_1, A_2, A_3$  enclosed in a box, so that all were approximately at the same temperature, and copper wires were used from

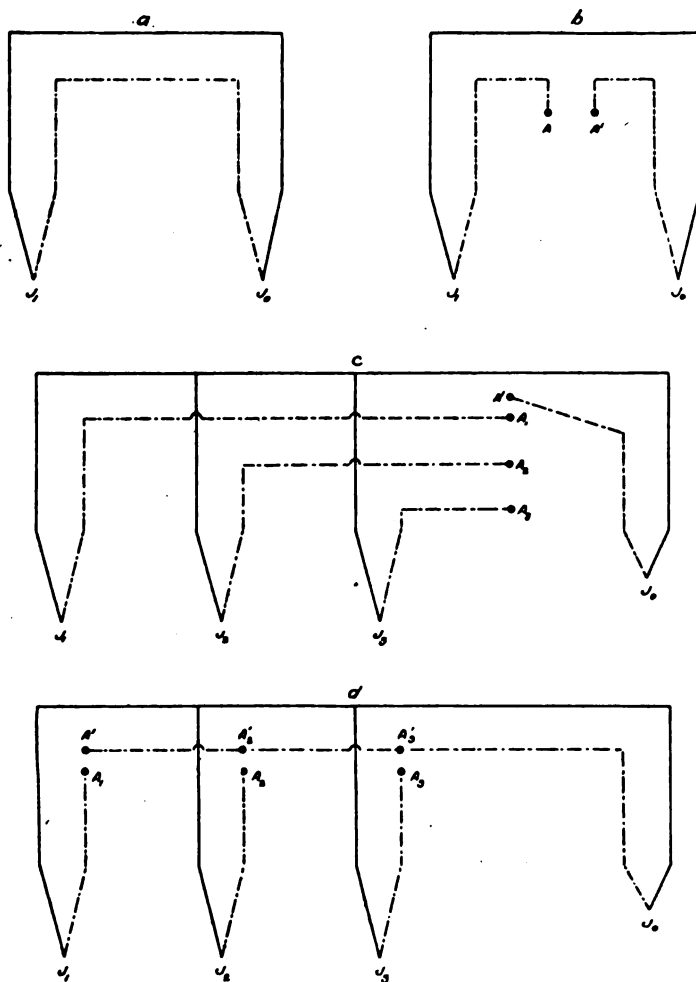

FIG. 2.—EVOLUTION OF LEAD-WIRE DISTRIBUTION.

there to the potentiometer. In the other case *d*, the lead from the constant junction  $J_0$  was brought close to the terminals of those from the variables  $J_1, J_2, J_3$  so that the connections to the copper are close together for each pair  $A_1A', A_2A', A_3A'$ .

The first set-up was generally adopted as most suitable for the work in hand. There were banks of kilns in several rooms and in each of these we put a box in which the connections  $A', A_1, A_2,$  etc., were enclosed,

and from this box ordinary copper wires were led to the temperature station where the potentiometer was kept. The lead from  $A_1$  was connected to the similar leads from the other rooms, thence to one terminal on the potentiometer. The leads from  $A_1, A_2$ , etc., were led to a switchboard so that any one of the junctions might be connected to the other terminal of the potentiometer.

The ideal way to handle the constant-temperature junction is to keep it immersed in ice, say in a thermos (vacuum) flask. If this is imprac-

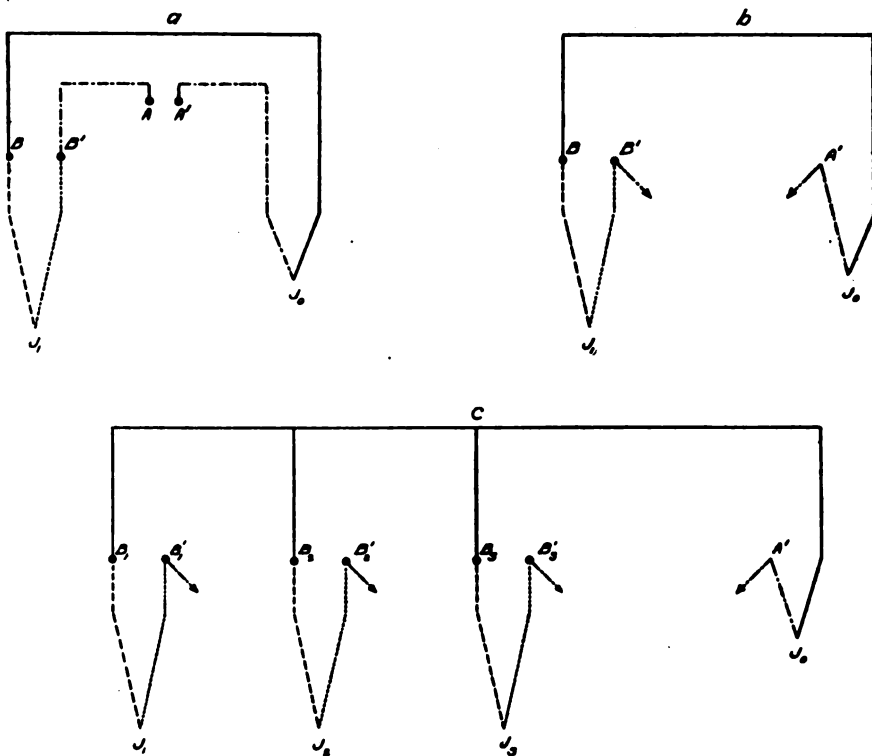

FIG. 3.—SPECIAL EVOLUTION OF LEAD-WIRE DISTRIBUTION WHEN COMPENSATING LEADS ARE USED.

ticable, it may simply be enclosed in any fairly constant temperature container and a correction made for the difference between this and melting ice temperature. This correction<sup>6</sup> should be made to the electrical reading before conversion to degrees. In practise, it is often useful to run the wires into a pipe driven 10 or 12 ft. into the ground. This provides sufficient constancy.

A distinct simplification, as regards the disposition of the leads, is possible if one of the couple wires is copper, as by making the points  $A, A'$ ,

<sup>6</sup> See L. H. Adams for a complete discussion of this point.

Fig. 2, on the copper side the necessity of their being at the same temperature vanishes, because the leads to the potentiometer will naturally be of copper also, leaving no chance for extraneous thermoelectrics. Even in using chromel-alumel couples, it is possible to take advantage of this owing to the fact that at low temperatures the junctions chromel-alumel and copper-constantan are almost equivalent as regards electromotive force. It is necessary in this case to have the junction of the copper-constantan to the chromel-alumel at a temperature not exceeding  $100^{\circ}\text{C}$ .

Fig. 3 shows the evolution of a scheme for using such leads. At *a* is shown simply a couple with leads of different metals from the metals of the couple. In this set-up there are two pairs of points *AA'* and *BB'* where the temperature has to be the same at both junctions of the pair. At *BB'*, this is generally nearly the case, as normally the two points will be close together because the junctions will be between double-twisted wires and will be very close together. The thermoelectromotive force from this combination will be the sum of two: that generated by the couple for the difference in temperature between the hot junction *J*<sub>1</sub> and *BB'* and that generated by the combination used as leads between *BB'* and the constant junction *J*<sub>0</sub>. The lead wires must, therefore, be chosen to give the same electromotive force as the couple combination for the range of temperature through which *BB'* is likely to vary. As already stated, the combination copper-constantan gives the same electromotive force at low temperatures as chromel-alumel.<sup>7</sup> The other two diagrams *b* and *c* show the disposition of the leads as we used them, the arrowheads indicating that the copper wires are carried to the temperature station. This use of compensating leads, one of which is copper, greatly simplifies the wiring.

If it is desired to use a recording instrument, say of the Leeds & Northrup type, it is necessary to have some convenient type of switch so that one can read on the potentiometer any of the couples, which are also attached to the recorder. This switch should be of a double push-button type so that a single push breaks one connection and makes another. It should also spring back to the old position when released. Such a switch is used in telephone work. We also used the type provided by the Leeds & Northrup Co. and found it very satisfactory. We found an automatic recorder exceedingly useful as a check to take a record of a certain number of the kilns—especially those on which particularly close control was necessary. In any case it is a good check on the work of the men who control the temperatures.

#### GENERAL REMARKS ON ANNEALING

The question of the annealing of optical glass has been fully discussed by Adams and Williamson.<sup>8</sup> They have concluded that optimum results

<sup>7</sup> L. H. Adams, *op. cit.*

<sup>8</sup> See footnote 1.

are obtained by holding the glass at a temperature where the strain takes about 6 hr. to disappear and then cooling it at a rate that may be rapidly increased as the temperature decreases. It is necessary that all the glass be at the required temperature, and it is therefore almost essential to have more than one thermocouple in each kiln and to have the heating apparatus arranged so that different adjustments can be made at different parts. A difference of a few degrees between different parts of the kiln would mean that one part of the lot of glass would not be annealed if the control was just right for some other part. If any trouble is found in actual practice, one of the first things to do is to test the variations of temperature by placing couples in different positions in the kiln. The source of the trouble is frequently to be found there.

The highest temperature necessary is less than  $600^{\circ}\text{C}.$ , so there is little trouble in this work due to corrosion of the couple. In the furnaces where the glass was softened before shaping for lenses, etc., it was necessary to measure higher temperatures, but by using heavy wires we found it possible to read to  $1000^{\circ}\text{C}.$  without any very bad effects. With the set-up described, there is no difficulty in reading accurately to within  $2^{\circ}\text{C}.$  The initial rate of cooling has to be somewhat carefully watched, but the difficulties involved were not due to the temperature measurements and do not concern us here.

The only one point left worthy of notice is the care of the instruments. The recording instrument needs occasional oiling, which should be done by some one who knows a little about handling delicate implements. New batteries must be provided periodically for all types, except the direct reader. The expense connected with this is not serious, as the amount of current used is very small and one dry cell lasts for several weeks at the very least. When it becomes impossible to make a standard-cell setting, this fact gives immediate notice that a new battery is required.

The lead connections, if made as described, will probably cause no trouble whatever unless (as did happen in one or two instances) the workman who has been bricking up a kiln gets the end of a wire completely covered with mortar or something similar; this, however, is unlikely.

#### SYNOPSIS OF OPERATIONS

The thermocouples used were generally about 4 or 5 ft. (1.2 or 1.5 m.) long and were made of No. 8 wire (0.128 in. or 3.3 mm.) where hard service was required; otherwise of No. 14 (0.064 in. or 1.63 mm.). The junction was made in an oxyacetylene flame using borax as a flux. Short lead wires of the same material as the couple wires were soldered on with ordinary solder. Before tinning, it is necessary to clean the ends well; tinning is then most easily accomplished by dipping the ends after heating into a small crucible of molten solder. During the soldering it is useful

to keep the heavy couple wires heated with a small flame. Zinc chloride makes a useful flux. The other end of these leads was attached to the permanent leads by small double connectors (Fahnestock connectors). The couple wires were insulated from each other by means of the double-holed porcelain insulators furnished by the Hoskins Company.

Lengths of  $\frac{1}{2}$ -in. (12.7 mm.) iron pipe closed at one end were used to protect the couples and to allow of ready readings at different spots in the kilns. These pipes were fixed in during the bricking-up process in the muffle-type furnaces, and were fixed permanently in the other furnaces. This, along with the double connectors on the couples, enabled us to insert or remove couples as desired. The temperature should always be taken at more than one point in the kiln.

Any kiln that required especially close watching had the temperature of at least one point automatically recorded at intervals of 15 min., while the man controlling the heating and cooling recorded all temperatures at least once an hour and frequently oftener, using a potentiometer. We found no difficulty in training men to take the readings properly and mistakes in temperature measurements were 100 per cent. eliminated.

It is also recommended that a consistent scheme of testing couples be used. The couples should be disconnected in rotation and sent to the laboratory to be compared with a standard element. In a well-equipped factory it should be a simple matter to test each couple every 2 or 3 weeks by having a number of extra couples ready to insert.

## Annealing of Glass\*

BY A. Q. TOOL,† PH. D., AND J. VALASEK,‡ B. S., WASHINGTON, D. C. .

(Chicago Meeting, September, 1919)

THE necessity of accurate temperature measurements in the glass-making industries is today being much more widely appreciated than in the past. The introduction of the modern simplified and perfected pyrometric methods in connection with exact regulation of furnace temperatures has caused a marked improvement in the glass product with a quickened rate of production. An example of the processes in which much improvement has been and still can be made is that of annealing or heat-treating the glass. This is one of the most delicate processes in glass manufacture and one that requires a most careful furnace control.

The heat treatment is undertaken to decrease the possibility of breakage and, in glass for fine optical instruments, to prevent serious warping of accurately ground and polished surfaces and to make the glass more uniform throughout to the passage of light waves. These objects are accomplished by removing all the harmful stresses that exist in a piece of glass when it has been cooled too quickly or unevenly. Such stresses exist, for example, after it has been pressed, cast, or otherwise worked. Thus the process of annealing consists of heating the glass evenly to the temperature at which it softens just enough to relieve these stresses in a reasonable time and then cooling slowly and uniformly until the glass hardens again. Accordingly, the things that must be investigated and determined in order to anneal glass without loss of time are: the annealing temperature, the time that the glass should be held at this temperature while the stresses relax, and the quickest cooling procedure that will give satisfactory results. After these characteristics of the glass are known the problem is one of pyrometry and temperature control entirely.

In cases when it is known that a glass article will be required to withstand some definite type of heat or mechanical shock it is often possible, by a proper heat treatment, to produce such a distribution of the stresses in the glass that it will be enabled to resist these shocks more effectively. This process is usually termed "toughening" or "hardening" the glass, although in all probability it consists entirely in distributing the stresses properly.<sup>1</sup> Although this article will deal chiefly with the applications

\* This is a general synopsis of a paper to appear later in the *Bulletin* of the U. S. Bureau of Standards.

† Associate Physicist, U. S. Bureau of Standards.

‡ Assistant Physicist, U. S. Bureau of Standards.

<sup>1</sup> Lord Rayleigh: *Phil. Mag.* [6] (1901) 1, 178.

of pyrometry to the determination of the characteristics of glass in the annealing range and to furnace control, as related to the removal of stresses, much that may be said applies also to this "toughening" process.

While it is often possible to obtain fair results and, accidentally, even good results by heating to an indeterminate temperature and then cooling in some haphazard way, it is impossible to obtain even a semblance of efficiency or consistency in result by such procedure. In fact, to carry out the process with the least loss of time and an assurance as to the result, the nature of the specific glass to be annealed must be well known; then after the proper schedule has been drawn, the problem becomes one that demands a most exact control of the temperature.

### ANNEALING TEMPERATURE RANGE

The first step in determining the annealing procedure for any given glass is to locate the most satisfactory temperature at which to remove the stresses. The best temperature range for this purpose is quite narrow, as a study of the results published by Twyman,<sup>2</sup> Zschimmer and Schulz<sup>3</sup> and others will make clear. The total range does not in any case extend over more than 100° C., while the really satisfactory range is probably less than one-half as great. The upper limit of this range is determined by the danger of serious deformation, especially in the case of thin articles, and also by the fact that a proper cooling is difficult when the glass is soft. The lower limit is fixed by the lack of mobility of the glass preventing the relaxation of the stresses in a reasonable time. Within certain limits, it may be said that the lower annealing temperatures will prove more satisfactory if the time required for the stresses to relax is not too great. This arises from the fact that the cooling then requires a less exact control and may be much more rapid. However, when the lower temperatures are employed, especial care must be taken that the glass assumes, and is maintained at, the proper temperature for the required time.

It is somewhat difficult to specify definitely the lower limit but the upper limit is more easily determined, since there are a number of phenomena appearing at those temperatures where the deformability becomes too great for annealing. It is here that the deformability appears to increase with extreme rapidity, speaking comparatively, as the temperature is raised. This region may be located, then, by observing either the deformation of strips or rods of the glass under load or the rapid decrease in the restored light, shown by a polariscopic study of cylinders that are being heated. This rapid softening is also accompanied by an increased absorption of heat<sup>4</sup> by the glass and a marked increase in the thermal

<sup>2</sup> *Trans. Soc. Glass Tech.* (1917) 1.

<sup>3</sup> *Ann. Phys.* (1913) 42, 345.

<sup>4</sup> M. So: *Proc. Tokyo Math. and Phys. Soc.* (Sept., 1918).

A. Q. Tool and J. Valasek: *Phys. Rev.* (Feb., 1919) 13, 147.

expansion<sup>5</sup> and probably other effects. These changes may also be used to locate the upper limit. The requirements in the use of any of these phenomena for such determinations are standardized methods and careful temperature measurements.

Methods based on the deformation of glass used in a number of plants to determine the annealing temperature consist usually in slowly heating a standard-sized rod, loaded in a definite way, until it stretches, bends, or twists (as the case may be) at a certain rate. The rate of heating and other conditions under which the test is performed and the annealing temperature determined vary according to the experience or custom of the plant. The optical method, or the determination of the annealing range by observing the temperatures at which the double refraction disappears, is also quite generally used. This double refraction results from stresses due to, or at least modified by, the heating. In using this test, the amount of strain should be small, or at any rate constant. When the conditions are all standardized, the results become comparatively consistent. It is also possible to arrange the annealing kiln so that such observations can be made on some of the blocks while the annealing is being carried out. Some of these methods were tested in this laboratory and gave very consistent qualitative results when the proper precautions were taken, especially in regard to the temperature measurements. They are much more valuable, however, when modified, as described later, so that the law of decrease of the stresses may be quantitatively determined.

Results that are more satisfactory in many ways can be obtained, for the upper limit of the annealing range, by finding the points at which the heat absorption or the abnormal expansion begins on heating. A good differential thermocouple method will locate a relative heat absorption in the glass on heating and a corresponding evolution on cooling. Although the quantity of heat involved is not very great, the effect is quite definite, especially on heating. Experiments have shown that the beginning of this effect should be regarded as the upper limit of the annealing range. Observations of this sort have the advantage of giving a definite, easily located temperature. The absorption, at least, can be located with a simple couple if the Osmond inverse time method with a chronograph or stop watch is used.

The form of the curve obtained on heating is very much the same for most glasses and shows a transformation covering a range of 30° to 60° between the beginning and maximum. One type of borosilicate glass, however, shows a decidedly peculiar form of curve with a very long transformation range. The temperatures at which these transformations begin make it appear that the effects are closely connected with the softening of the glass. Glasses of varying composition were tested.

<sup>5</sup> C. G. Peters: *Phys. Rev.* (Feb., 1919) **13**, 147.

W. P. White: *Am. Jnl. Sci.* (1919) **47**, 1.



They ranged from simple boric-acid glass, which shows the effect at 240° C., to heavy barium crown, which does not show the absorption of heat beginning until 575° C.

TABLE 1.—Transformation Temperatures of Various Glasses

| Glass    |                         | Beginning of Heat Absorption on Heating, Degrees C. |
|----------|-------------------------|---|
| Number   | Name                    |   |
|          | Boric acid.....         | 240   |
|          | Borax.....              | 450   |
| B.S. 76  | Dense flint.....        | 460   |
| B.S. 110 | Medium flint.....       | 445   |
| B.S. 188 | Light flint.....        | 485   |
| B.S. 145 | Barium flint.....       | 520   |
| B.S. 20  | Light crown.....        | 495   |
| B.S. 94  | Borosilicate crown..... | 515   |
| K 266    | Borosilicate crown..... | 545   |
| B.S. 87  | Light barium crown..... | 575   |
| B.S. 124 | Heavy barium crown..... | 575   |
|          | Pyrex.....              | 520   |

Within the errors of observation, this effect begins at the same temperature as the increased thermal expansion observed by C. G. Peters. The exact nature of the transformation causing this behavior is not to be determined from the limited data now available. Further data on these characteristics should throw considerable light on the nature of glass and the relation of the critical range to the composition. An immediate application of these effects lies in their value for determining the upper limit of the annealing range.

RELAXATION TIME

While the methods described appear to give the upper limit satisfactorily, they do not necessarily determine the most desirable annealing temperature, since that depends to a great extent on the time required for the stresses to relax. This time can be most easily estimated when Maxwell's<sup>6</sup> relation time *T* is obtained. This constant *T* may be defined as the time required, while the strain remains constant, for the stresses in a viscous medium to decrease to  $\frac{1}{e}$  times their original value, where *e* is the base of natural logarithms. The time *T* is most easily determined by the stretching or bending methods previously mentioned. In such tests the temperature of the glass sample should be kept constant and uniform to a fraction of a degree during the observations. The rate of

<sup>6</sup> J. Maxwell: *Phil. Mag.* [4] (1868) 35.

deformation  $ds/dt$  is measured and the stress  $F$  calculated from the load, and the dimensions of the strip or rod with a consideration of the mode of support. From these data, the relaxation time may be obtained by means of the equation

$$ET = F / \frac{ds}{dt}$$

when  $E$  the elastic coefficient involved is known.

At a steady temperature,  $T$  remains constant for a considerable range in load. When the temperature  $\theta$  is changed, it will be found that  $T$  changes very nearly according to Twyman's empirical relation<sup>7</sup>

$$T_1 = T_0 e^{\frac{\theta_0 - \theta}{k}}$$

Where  $T_1$  and  $T_0$  are the relaxation times at the temperature  $\theta$  and  $\theta_0$ , and  $k$  is a constant, depending on the nature of the glass. From tests on various glasses it would appear that  $k$  may be as large as 13 or as small as 10. On the average, however,  $T$  may be said to double for each  $8^\circ$  drop in temperature.

The relaxation time may likewise be determined from observations on the changes in the restored light in a polariscope. This method can be applied in the proper annealing range where the rate of deformation becomes too slow to be measured conveniently by a mechanical means. A comparison of these results and those obtained by an extrapolation of the bending or stretching method is interesting. The relaxation time, as determined by the optical method, changes very greatly with the magnitude of the stress, but for some amount of double refraction usually has the same value as that determined by the mechanical method. Thus larger stresses relax more quickly and small stresses more slowly than would be expected from the extrapolation. These observations lead to some interesting conclusions as to the manner in which the elastic and viscous properties<sup>8</sup> of glasses change when they harden. In the case of fine annealing proper allowance must be made for these changes.

It was found through experimental annealing that the best annealing temperature for most glasses lies within  $20^\circ$  C. of the beginning of the critical range. For certain special cases, however, lower or even higher temperatures may be desirable. The relaxation time  $T$  and also  $k$  should be determined in this range, if possible. The value of  $T$  for any other temperature may be calculated from Twyman's formula. If the initial stresses  $F_0$  are to be reduced to any fraction of their original value, so that after a time  $t$  they become equal to  $F$ , then

$$t = T \log_e F_0/F$$

This relation is derived from Maxwell's formula on assuming a constant

<sup>7</sup> F. Twyman: *Op. cit.*

<sup>8</sup> Butcher: *Mess. of Math.* (1879) 8, 168.

strain. A degree of annealing such that  $F/F_0 = 0.01$  is usually sufficient for glassware, and in this case  $t_a = 4.6T$ , which may be considered as a satisfactory annealing time for most purposes. The temperature that appears to give the best results is the one corresponding to a value of about 2 hr. for  $t_a$ . During this time it is important that this temperature is taken up by the glass, and that it is constant and uniform. It is at this point that modern pyrometry and methods of temperature control become of great assistance in obtaining and maintaining the required conditions during the annealing time.

It might appear that the choice of a still lower temperature would reduce the need for extreme care in control and also make cooling easier. Although this is partly true, the advantage gained by the employment of a temperature low enough to produce a marked gain would be offset by the increased annealing time and the necessity of maintaining a constant temperature over a longer period. That is, the additional time necessary for annealing could not be compensated by the time saved by the more rapid cooling.

#### COOLING PROCEDURE

After the glass has been annealed sufficiently, the cooling may begin at a rate that depends on the size, the physical and chemical nature, the relaxation time, thermal expansion, and other constants of the glass. The mode of packing and the number of pieces must also be considered if a large quantity are packed together. Unless these conditions are known, it is difficult to outline any definite cooling procedure. Moreover, any general or theoretical discussion is not convincing when the number of variables entering the problem is so large.

In general, the cooling should proceed in such a manner that the rate is approximately the same throughout the glass. That is, the rate of cooling should not be changing so rapidly that the inner portions lag far behind when making the same changes in rate that are occurring at the surface. For small or thin pieces, like lens blanks or thin bottles, this does not preclude a rate that increases rapidly to a maximum, which, when the expansion coefficient is small and the conductivity and relaxation time are large, may approximate free cooling in air, starting at about 250° C.

When the article has an appreciable thickness, the cooling must proceed much more slowly at all stages. If the temperature differences involved are not too great, the rate at any stage should be, roughly speaking, inversely proportional to the square of the thickness unless the other dimensions vary too greatly. Tests on increasing the rate as the temperature falls show that the procedure suggested by Twyman gives good results. In this case the rate is doubled, for a time, after each 10° C. drop in the temperature. This doubling must cease and the cooling rate

become linear considerably short of a rate that would produce stresses approaching the breaking limit. The condition requiring a uniform temperature over the surface must, in every case, be satisfied.

It is physically impossible to cool large pieces, such as telescope lens blanks, very rapidly as a whole, even if the stresses were not to become dangerous. Because of the slow cooling, the stresses produced by the gradient act for a long time and produce their full effect unless the relaxation time is very large. Accordingly it is desirable to anneal large pieces, if possible, at lower temperatures than are employed for small ones. Otherwise the cooling would have to be extremely slow over a wide range. For fine annealing, it is extremely important to maintain surface-temperature uniformity.

In all these cases some permanent strain will evidently result from the cooling and it is necessary to adjust the rates so that this strain is too small to be harmful. Ultimately, the product should always be tested and, if its condition is not satisfactory, readjustments in the procedure must be made. The nature of these readjustments will always be evident when sufficient data of the sort described concerning the properties of the glass are at hand. A temperature record of the heat treatment taken by a recording pyrometer will be found of great assistance to determine whether and how the furnace control must be modified.

Practically the only method for testing the finished product for strain is to examine for double refraction in polarized light. This method is really not very satisfactory since, as Pockels<sup>9</sup> has shown, the double refraction exhibited by the various glasses under the same stress varies greatly with their composition. He was able, in fact, to calculate the composition of glass that would show no such effect and later to verify the result by experiment. However, there are not sufficient data available on this point to be of aid in testing. Moreover, there are no reliable specifications as to the magnitude of stresses allowable, although a number of purely arbitrary standards are in use. When the annealing process is carried out in a scientific and efficient manner, it is, as a rule, not difficult to eliminate the stresses to such a degree that the amount of double refraction is very small if not negligible. Consequently there should be no difficulty in meeting any reasonable standard.

#### SUMMARY

In summarizing the requirements to be observed in annealing, the following points are to be noted:

It is well to study carefully the glasses to be annealed and obtain all the information bearing on the choice of the annealing temperature and time and mode of cooling. If the temperature of the glass is above the annealing temperature (and in case the stresses are large, it may be

<sup>9</sup> F. Pockels: *Ann. Phys.* (1902) 7, 745.

advisable to heat it somewhat above) the glass may be cooled with comparative rapidity to this steady temperature and then annealed for the required time. After the stresses have practically vanished, the cooling must proceed at a rate such that the amount of strain introduced is negligible. This rate may be increased for a time. This time and the manner of increasing the rate must be determined from the nature of the glass and the character of the ware.

In order to profit by an investigation into the nature of the glass and by former experience in annealing, it is necessary to have a complete pyrometric record and control of the entire process. The subject of temperature control and recording pyrometers in this connection is discussed by Fairchild and Foote in this symposium. An automatic furnace control that gave good service in this laboratory consisted of a General Electric control panel used in connection with a Leeds & Northrup recorder, with some modifications devised by C. O. Fairchild.

It must be emphasized that the temperatures of interest in annealing are those that are taken up by the glass, and that for good work the heating must be uniform. An ideal system is naturally unattainable but a study of modern methods of pyrometry and temperature control will make it clear that much improvement in the usual plant conditions is possible.

## DISCUSSION

E. D. WILLIAMSON,\* Washington, D. C. (written discussion†).—The paper is interesting and suggestive and the work described should be carried to completion, as it presents points of interest quite apart from the immediate application in glass manufacture. It ought to help, for instance, in throwing light on the chemical nature of glasses and on all questions of viscous flow.

In practice, we have found that it is much safer to use temperatures some 40° or 50° below those given in the authors' table, especially where large muffles, which have considerable lag, are used. It is exceedingly difficult in many cases to regulate the initial rate of cooling closely and this trouble can be completely avoided by working at a point where the strain takes several hours to vanish.

Results based on Maxwell's equation are of doubtful significance as this equation is made up on a definite assumption as regards the relation of stress to strain, which does not hold in the case under consideration.

A point that is insufficiently emphasized is that the exceedingly small conductivity of glass causes a large temperature difference between the outside and the center while heating or cooling. This means that for larger pieces the initial rate of cooling must not only be less but the point at which the cooling is speeded up must be lower.

\* Physical Chemist, Geophysical Laboratory, Carnegie Institute of Washington.

† Received Sept. 18, 1919.

## Pyrometry Applied to Bottle-glass Manufacture

BY R. L. FRINK, LANCASTER, OHIO

(Chicago Meeting, September, 1919)

I FEAR that my treatment of this subject may not, in all instances, meet the approval of those who read my opinion as to the utility and efficiency of pyrometers in the making of glass, or bottle-glass. It may be superfluous for me to add that this opening statement is based on over 15 years' experience in an endeavor to successfully apply pyrometers, or heat-measuring instruments, to glass-melting furnaces, particularly the type known as tank-furnaces, and that such endeavors have proved more or less futile. It is my desire, therefore, to herein set forth the problems encountered, hoping thereby to stimulate further effort in the successful application of pyrometers. It is my desire, also, to invite criticism of the methods used and suggestions from those who may have a wider experience, or who may have better methods.

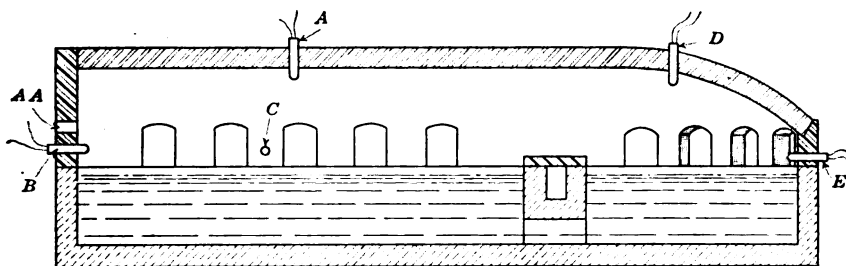

FIG. 1.—GLASS TANK FURNACE.

In general, I believe that the inefficient application of pyrometry to the melting of glass in tank furnaces is not due as much to the instruments as to the conditions under which they must be used and the character of the medium in which they must reside. Most of those present no doubt, are familiar, at least in a general way, with the methods and apparatus used in the melting and making of bottle-glass, or glass that is formed into containers of various shapes and designs. Most of this glass is made in what is known as a tank furnace. These furnaces vary widely in design and construction. In general, they consist of a rectangular tank-like form, built up of fireclay blocks, and range from 2 by 4 ft. (0.6 by 1.2 m.) to 24 by 140 ft. (7.3 by 42.6 m.) with a depth of glass from 2 to 5 ft.; or a capacity of from approximately 2 to 700 tons. Fig. 1 shows the general

design. The material is charged in at *AA*. It is pushed into the furnace by means of an iron tool and floats on the molten glass in mounds, or what might be relatively termed "bergs" of batch materials. Here it comes into contact with the fire and temperature, which effects a chemical combination of the batch material. As it melts the material flows forward and passes downward through the throat in the bridge-wall. This throat is a comparatively small opening, usually not exceeding 24 in. (61 cm.) in width by 18 in. (45 cm.) in height. The glass then enters what is known as "the refining chamber," or "working end" of the furnace. This chamber, above the bridge-wall, is in open communication with the melting end.

As no fire is introduced into the working end of the furnace, obviously its temperature is considerably lower than that of the melting end. Consequently the temperature of the glass decreases as the glass flows toward the ring holes, or working positions. If more glass is taken from any one working position, or ring hole, than from the opposite side, there will flow to this point a greater quantity of the hotter glass issuing from the throat. As a result, the workman working this glass will be required to regulate his gathering or the machine he is operating accordingly. Should he for any reason cease to operate his machine, or gathering, and the flow of glass to this point is checked, a change in the temperature of the glass will ensue. This necessitates a change in the working conditions when again starting up, also a further change when operations have been resumed until the normal flow has been produced.

It would seem that a simple answer to this would be to introduce into the glass at this point some form of temperature-measuring apparatus, or to sight upon the glass at this point a pyrometer working upon the optical principle, or the disappearing-filament principle. However, none of these have been found to be satisfactory. The thermoelectric pyrometer is absolutely unsuitable for this purpose, because we have not as yet been able to construct a sheathing or protecting tube for the element that will withstand the erosive action of the glass. The optical pyrometer is likewise unsuitable because the glass has not only light and heat transmitting properties, but is highly reflecting. As a consequence, the glass temperature at the surface is not measured but measurements are obtained of the underlying glass if it should be hotter than the surface, or possibly the temperature of the crown or side walls, or of the flame, which is reflected from the surface.

At the melting end of the furnace, the batch materials, which constitute the glass, are composed mainly of sand, soda ash, or salt cake, burned or raw lime, with possibly the addition of small amounts of borax, arsenic, antimony, nitrate of soda. In some rare instances, barium carbonate, zinc oxide, etc. are being introduced in varying proportions and in a dry state. As they are injected into the furnace, the charges float on

the surface of the glass and come into contact with the fire, which plays across the furnace. As a result more or less of these materials is entrained in the gases that pass across and carried forward impinging upon the side wall, into the ports, checkers, and flues. To some extent this pervades the whole atmosphere of the furnace, producing a severe erosive action upon the whole interior lining, combining with the material forming the side walls, which effects a glaze that is more or less light reflecting.

#### THERMOELECTRIC PRINCIPLE

If pyrometers are introduced either through the crown at point *A*, Fig. 1, through the back wall at *B*, or the side walls at *C*, the protecting or sheathing tubes of the elements (if it is a thermoelectric equipment), are attacked by the entrained and volatilized alkali. It only requires a short time, in some instances a week or possibly a month or two, for this alkali to dissolve and erode these protecting tubes sufficiently to expose and destroy the element itself. Therefore it is not only expensive, but extremely difficult, to keep these elements in an operative condition.

In order to minimize this erosive action, perforated silica block has been used as a protection tube, particularly where the element has been introduced through the crown, as at *A*. While this was satisfactory so far as reducing the erosive action and destruction of the element is concerned, it was not entirely satisfactory because it was necessary to make these blocks rather large in order that they would have sufficient mechanical strength. This results in there being considerable heat conducted through the block into the crown, consequently lowering the temperature readings below the actual temperature of the furnace, and also decreasing the sensitiveness of the instrument.

What has been said of the elements introduced at *A* is also true of those introduced at *B* and *C*. Those located at the two latter points, even where they are protected by a silica block, do not resist the erosive action nearly as well as those at *A*.

Another great drawback to the use of pyrometers as a control medium for governing melting conditions when located in the melting end is the fact that they do not give readings that truly represent the temperature or fire conditions which perform effective work on melting the materials. To illustrate, a pyrometer element located at *A*, Fig. 1, reads only the temperature produced at *A*, which is perhaps 3 in. (7.6 cm.) below the crown. Conditions can be produced in the furnace whereby, with a high stack draft and with gas and air valves adjusted, a perfect combustion can be obtained. A higher temperature can then be produced at the surface of the glass, or impinged upon the batch materials, than will be produced at the thermal element at *A*; but if the stack damper should be lowered, with other conditions remaining the same, the travel of the fire



across the furnace will be retarded and a greater quantity will be forced up to the crown. As a result, the temperature at *A* will be increased while the temperature of the furnace may be lowered, and at the surface of the glass will be very much lower than is found at *A*, or at least, melting will be retarded. This result I have been able to produce many times. For this reason it is my candid opinion that a pyrometer in the melting end of a tank furnace really does more harm than good, for where such conditions can be obtained the instrument must be misleading in its efficacy as a means for furnace control.

This is true to a greater extent when the elements are located at *B* and *C*, for not only do the fire conditions have a pronounced effect on the element at *B*, but the quantity and proximity of the batch piles also affect it. While an element at *C* not only suffers from the two conditions mentioned, it also has the disadvantage that when the fire is traveling away from this side of the furnace, it receives that temperature only arising from the imperfect combustion as the stream of gas and air issues from the ports; while if the fire is approaching the element, the latter receives the greatest intensity of heat because of the impingement of the gases of final combustion.

A thermoelectric element introduced at *D*, Fig. 1, or in the refining end of the furnace, under certain conditions when correctly understood, is of considerable utility and value to the furnace operator. This element not only reads the temperature radiated from the glass immediately below, but it also indicates the temperature of the gases that surround the glass in the refining end of the furnace. This results indirectly in its being an indicator of the stack damper and air-valve settings that control the quantity of gases of combustion forced to this end, or the influx of air into the furnace. However, it gives but a secular indication of temperature, and cannot be accepted as any true guide of the temperature of the glass.

An element located at *E*, Fig. 1, is more efficacious, when properly installed, in giving the temperature of the glass immediately adjacent to it but, as pointed out, this may be at a point where the glass is substantially quiescent, and consequently cooler than at any other point. If located between two ring holes from which relatively large quantities of glass are being taken, it will indicate a higher temperature than at other working points of the furnace.

As a means of furnace control, a pyrometer introduced in the flue, between the stack damper and air valve, and at *D*, in conjunction with an efficient type of draft gage, provides as good a means of regulating the furnace conditions and the requirements of adjustment as it is possible to obtain. However, so far as furnace control as related to the melting conditions is concerned, I have never found anything that affords as good a criterion as the appearance of the melting batch piles, the flux line,

and the surface of the glass between the batch piles and the bridge-wall. Here we have indications that are directly the result of quantity, quality, and intensity of fire affecting the material to be acted upon.

### OPTICAL PRINCIPLE

Some furnace men and operators have found that the optical pyrometer meets all their requirements in furnace control by using it as a criterion upon which to regulate their fire conditions, or the degree and speed of combustion. This is done by sighting through an opening in the rear wall of the furnace, at some convenient point, whereby the instrument may be focused upon some given point in the flame and the temperature read at this point. The readings are then empirically applied to adjust or regulate valves and damper settings.

I do not question but that after careful study and correlation of readings with the valve and damper settings, the optical pyrometer can be utilized to give valuable aid to the operator in governing furnace adjustments. However, I have never been able to obtain results that are as satisfactory as other means. Further, I have never been able to use an optical pyrometer of the Wanner or disappearing-filament type, and obtain any satisfactory results in controlling temperature of the glass, for, as before pointed out, the emissivity of the glass is dependent entirely on its composition, homogeneity, uniformity of temperature, and freedom from reflections of hotter or colder bodies.

As an example, if one will take out of the furnace in any convenient manner, a mass of glass of, say, 100 lb., having but a small part of its area exposed to radiation, and then attempt to measure the temperature of the surface, he will find that this surface temperature is very much lower, in some instances, 200° to 300°, than will be registered by the optical pyrometer.

### RADIATION AND DISAPPEARING-FILAMENT PRINCIPLE

What has been said of the optical principle is, to a great extent, true of the radiation and disappearing-filament types of pyrometer. In the disappearing-filament and optical types, we also have the calibration factor to contend with, while in the radiation type we have the perfectness of focus and reflecting surface to maintain in order to obtain anything like accuracy.

It is indeed regrettable that some one cannot devise a means or material whereby temperatures of glass can be accurately measured. However, it is not strictly essential and, in fact, I believe it is not wise to attempt to measure the temperature of the melting end of these furnaces, for the reason that the position at which such temperatures are measured is so

small in proportion to the volume and areas involved that such measurements do not give information of any practical value. If we could devise a means whereby the temperature of the glass as it is being worked could be continuously and accurately measured, we would solve a problem that would be of inestimable value to the manufacturer.

In regard to this statement, let us consider some of the conditions wherein this temperature plays such an important part. Fig. 2 is a diagrammatic view of what is known as the Owens revolving pot, which consists of a furnace and a revolving clay vessel situated adjacent to the tank furnace, as shown in Fig. 1. A spout introduced in the refining end of the furnace, some inches below the surface of the glass, has a gate member arranged so that by adjusting the gate a quantity of glass flowing into the revolving pot marked *AB* can be regulated so as to maintain a constant level, or the gate can be lowered so as to completely shut off

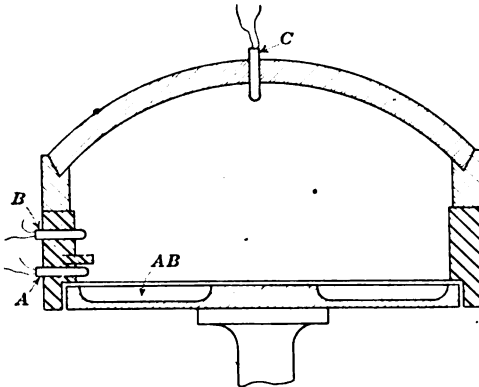

FIG. 2.—OWENS REVOLVING POT.

the flow of glass to the pot. A heating chamber surrounds this revolving pot and is entirely separate from the melting furnace and its refining chamber, and is supplied with auxiliary means for obtaining the required temperature therein; this is done by means of oil, natural gas, or producer-gas fuel. The glass that flows into this pot is formed into various articles, such as bottles of all sizes, fruit jars, packers' ware, etc., by means of what is known as the Owens bottle machine, the fundamental principle of which, briefly stated, is as follows:

A parison mold is lowered so that its opening and under surface just comes into contact with the surface of the glass; as a vacuum is created in this mold, the glass is forced up into it and around a plunger, which produces the required cavity within the parison blank. Subsequently, this parison mold is opened and removed from the blank, and the blow mold, or the mold that governs the shape of the article, is closed around the blank, the plunger is removed, the opening closed where the plunger passed through, compressed air is admitted into the cavity in the blank,

and the blank distended to fill the contour of the mold, after which the mold is opened and the article is ejected upon a suitable conveyor, or is removed manually.

The perfectness of the article depends, primarily, on the temperature of the glass as it is drawn into the parison mold. It is a serious and perplexing problem as to what this temperature should be, and after the temperature has once been determined, for a given size and weight of ware, its effect must also be determined as related to the condition of the molds, speed of operation, distribution of glass in the article, vacuum and air pressures, etc. and should be maintained uniform and constant. Numerous ways have been suggested, and I have tried nearly every suggestion, but I have not found a method for measuring the temperature of the glass at exactly the location where the mold takes up the glass, that has been entirely satisfactory or successful.

A pyrometer element introduced, at *C*, Fig. 2, is subject to the same criticism as the one introduced at *A*, Fig. 1, in the melting end of the furnace, as its registrations are susceptible to all the variations in temperature that may be produced by varying fire conditions, draft, and glass temperature. The same is true of an element introduced at *B*, Fig. 2. However, there is no flying flux or alkali to attack the sheathing tube or element. An element introduced, at *A*, Fig. 2, as near to the glass as is possible, gives about as effective results and as satisfactory as any, by introducing the element through an open-end protecting tube so that possibly from  $\frac{1}{2}$  to 1 in. of the element proper, with just a thin coating of clay over the element wires, protrudes beyond the open end of the sheathing tube. This will bring the element about 2 in. above the surface of the glass. Over this I construct a clay tile shield about 2 in. thick and 6 in. long, to protect the element as much as is possible from radiation above and the direct flame or fire in the furnace. In this manner, a registration of the temperature radiated from the glass in the pot is obtained; and while the results are fairly satisfactory, they are far from what might be desired, for the temperature of the glass must be measured to insure the best results.

We have made numerous attempts to use optical and radiation pyrometers to obtain the temperature of the glass in this pot at the required point, but these attempts have proved utter failures.

What has been said as to the difficulties encountered in applying pyrometers to the Owens pots is true of other modes of gathering or working the glass. In the Hartford-Fairmont process, the glass flows into a channel, is then paddled over a weir, discharged through an orifice, cut off by means of shears, and discharged into an open parison mold. Here it is essential, in order that a given weight of glass shall be discharged into the mold each time, that the glass be maintained at a definite and uniform temperature. In the Tucker-Reeves method, the

glass flows through a refractory channel to an orifice (as shown in Fig. 3) of a predetermined size and then through controllable periods of time of such flow is sheared off so as to discharge predetermined weights and quantities of glass to the molds. In the Brookes device, wherein there is no means for regulating, with precision, the quantity of glass flowing through the orifice and the time period of shearing, by a gate in the channel, obviously the amount discharged is directly related to the temperature.

In all of these processes, *i.e.*, Hartford-Fairmont, Tucker-Reeves, and Brooks, numerous attempts have been made to use pyrometers as a means of controlling the temperature of the glass, but so far all attempts have been unsatisfactory. It has been found that to introduce the thermoelectric element in any part of this apparatus, it is necessary to keep the same out of contact with the glass. Therefore, the elements are usually introduced at some point approximating the position marked *A*, as shown in Fig. 3. Although I have used, in some experimental work, an element introduced at *B* and into the glass stream with satisfactory results, so far

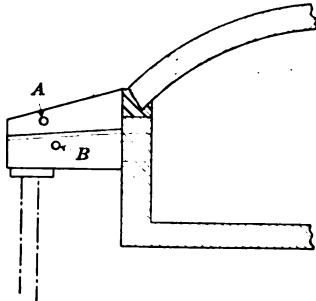

FIG. 3.

as indicating the true temperature of the glass is concerned, it is substantially impossible, from a practical standpoint, to use this method of installation, because of the high erosive action of the glass upon the sheathing tubes, which necessitates the shutting down of the machine and serious damage to the spout if a new element is to be installed.

### CONCLUSIONS

My conclusions on this subject are as follows:

That pyrometers applied to the melting of glass in tank furnaces perform no useful function in determining the regulations or control of fire conditions. To a minor degree, they do assist in keeping a check upon the furnace operation, and, more effectively, function to effect a psychological stimulus for the operator.

That they are woefully inadequate as a means for controlling the temperature of the glass at the working or refining end of the furnace, although they are of great value in controlling the conditions at this point.

That the thermoelectric type is greatly superior to the radiation, optical, or disappearing-filament types, except in possibly special or isolated cases.

That the invention or design of a protecting tube that will withstand the erosive action of the glass will give to the glass manufacturer a means whereby he will be able to utilize a pyrometer in such a manner as to make it indispensable and of inestimable value.

## Pyrometry in the Manufacture of Optical Glass

BY ALBERT J. WALCOTT,\* ROCHESTER, N. Y.

(Chicago Meeting, September, 1919)

THE success of various operations in the manufacture of optical glass depends, in a large measure, on the ability to maintain proper heat control. A good pyrometer system is, therefore, a very necessary part of the equipment needed. Men of long experience in dealing with high temperatures, who have acquired through constant practice the ability to judge approximate temperatures by means of color, are undoubtedly valuable, but even the most competent are not as reliable as a good pyrometer system. They admit that their ability to judge accurately varies from day to day and that their judgment is affected considerably by the condition of the sky, whether it is clear or cloudy. Besides, where it is a matter of only a few weeks to train a man to operate a pyrometer system, it takes about as many years to train him to judge temperatures by the state of incandescence.

The pyrometer outfit in use in the glass plant of the Bausch & Lomb Optical Co. consists of the following: Platinum elements, optical pyrometers, base-metal elements, indicators, potentiometers, and recording pyrometers.

*Platinum Elements and Optical Pyrometers.*—Temperature control in the melting operation is of such great importance that it is very desirable to know the exact temperatures, relative temperatures being of little value. The use of the platinum element is to determine the rate of heating or cooling of the furnace. The platinum couple is installed in either the crown or the wall of the furnace. It is placed first in a porcelain protecting tube and this is placed in a permanently fixed fireclay tube projecting from  $1\frac{1}{2}$  to 2 in. into the fire-chamber. It has been found impractical to use the platinum couple for determining exact temperatures of the melting furnace, for the platinum element deteriorates rather rapidly at the high temperatures used,  $2500^{\circ}$  to  $2700^{\circ}$  F. ( $1371^{\circ}$  to  $1482^{\circ}$  C.). When protected and installed as described, though, the temperature determined is local and varies from  $150^{\circ}$  to  $200^{\circ}$  F. ( $83^{\circ}$  to  $111^{\circ}$  C.) from the actual temperatures of the glass in the furnace.

For the greater part, the platinum element is used for general control. When the same temperature schedule is followed day after day the plati-

\* Research Physicist, Bausch & Lomb Optical Co.

num element might be used satisfactorily for exact temperature control by making necessary corrections for deviations from actual temperatures. Temperatures are read by means of a direct-reading indicator.

For determining actual temperatures in the melting operation the more satisfactory way is by means of an optical pyrometer. The Leeds & Northrup optical pyrometer has been found quite satisfactory. The instruments are frequently checked against each other and also against a standard reserve lamp. A water-cooled platinum element has also been used as a check. At temperatures from 2500° to 2600° F., the optical pyrometer has been found to be correct within 5 to 10° F. Errors are likely to be introduced in the use of the optical pyrometer by not focusing on the proper places in the furnace. Parts of the furnace coming in actual contact with the flame are considerably hotter than the pot and should therefore be avoided. By focusing on the surface of the glass while flame is in the furnace, errors as high as 90° F. are introduced, caused by the reflection of the flame from the glass. Fairly satisfactory results have been obtained by focusing on the rim of the pot.

After the flame has been turned off, temperature determinations may be made from the surface of the glass. When this is done it must be understood, however, that the temperature determined is that of the bottom of the pot and not of the surface of the glass, the color from the bottom of the pot being transmitted through the glass.

*Base-metal Couples.*—A very important application of pyrometry in optical glass industries is the use of base-metal couples for maintaining temperature control in annealing optical glass. Considerable literature has been published recently on various phases of the optical-glass manufacture, including annealing, so that it will not be necessary to give details here. All optical glass, before it can be prepared by the Precisions Optics Department to be put into work, must be comparatively free from internal stresses, so that very careful annealing is necessary. A large amount of optical glass is pressed into prisms and lenses, varying in size from a few cubic inches to 35 and 40 cu. in., and then annealed; some glass is annealed in the form of large cast sheets. The kilns and lehrs used for annealing in the glass plant of the Bausch & Lomb Optical Co. are gas-fired; the kilns are well insulated, thus giving a fairly uniform distribution of heat.

A 3-ft., heavy-type, base-metal couple of Hoskins make, placed in a chromel protecting tube, is inserted through the crown of the kiln. An immersion of about 18 in. in most cases brings the end of the protecting tube near the center of the chamber in which the glass is placed. The kilns are grouped in batteries containing from six to ten. All the couples of a battery are connected to a cold-junction well, 8 to 10 ft. deep, near the battery, and to a junction box immediately above the well by means

of compensating wire. From the junction box, copper lead wires, conducted through conduits, are brought to a selective switch, arranged for 50 couples, in a special pyrometer room. Temperatures are read by means of a Leeds & Northrup portable potentiometer. By means of a double-throw switch, it is possible to connect with a direct-reading, high-resistance, Taylor indicator. The potentiometer has been found the more satisfactory; hence the indicator is used only in cases of emergency. A man is employed to make temperature readings, make a careful record of temperatures and regulate the burners, a satisfactory automatic temperature control having as yet not been found. A reading of each kiln is taken every 15 minutes.

The couples in use are frequently checked against a standard platinum-platinum-rhodium couple. All checks are made in a small auxiliary furnace and done with considerable care. Besides these checks the couples are checked, while in place in the kiln, every other time the kiln is brought to a maximum temperature. Such checks are made by inserting a "master" base-metal couple through an extra aperture about 4 in. away from the regular couple. Careful records are kept of all checks made. Temperature observations of cold-junction wells are made once a month.

Besides the installation of base-metal couples used for fine annealing, a separate installation of nine couples is used in connection with a large lehr. Here also a special man is employed to watch the action of the couples and regulate the burners of the lehr. The highest temperature used for any part of the annealing work is about 1200° F. (648° C.). There is, therefore, no great danger of rapid deterioration of the couples.

Since the maximum temperature to which a kiln is heated is a matter of considerable importance, where several different kilns may be used for annealing the same class of work, the couples should agree so closely as to be interchangeable. Whatever variation from the standard does exist in any of the couples is recorded and taken into account in bringing kilns to maximum temperatures. A couple whose millivoltage for any given temperature varies from day to day is very undesirable for fine annealing work. The greatest variation of any of the couples in use at the Bausch & Lomb plant, as determined there, is 10° F. at 1000° F. (5.6° C. at 538° C.).

Another practical application of base-metal couples has been found in determining temperatures of furnaces used for bending and annealing large searchlight mirrors. The potentiometer is used for determining temperatures while the furnace is being heated to maximum temperature. After the gas has been turned off, the cooling curve is determined by means of a recording pyrometer.



The heat control of pot arches, used for heating glass pots before being placed in the melting furnaces, does not require a high enough degree of accuracy to justify the installation of a pyrometer system. However, since the maximum temperature used for this operation is approximately 1800° F., base-metal couples, properly protected, could be used in case a higher degree of accuracy than is used at present should be desired.

Acknowledgment is due Mr. R. J. Montgomery, of the Bausch & Lomb Optical Co.'s glass plant, for furnishing information concerned with the use of the platinum element and the optical pyrometer in connection with the melting operation.

## Use of Optical Pyrometers for Control of Optical-glass Furnaces

BY CLARENCE N. FENNER,\* WASHINGTON, D. C.

(Chicago Meeting, September, 1919)

THE manufacture of optical glass is a process that demands careful regulation and control at all stages in order that satisfactory results may be obtained. The product, to serve its purpose, must meet stringent requirements, which can be assured only by careful procedure in manufacture. During the greater part of the time that a pot of glass is in the furnace, temperatures should be kept within certain rather narrow limits; a departure on either side is likely to be detrimental to the glass and may result in total loss. If the temperature during melting and fining be low, the melt is likely not to fine properly and the glass will contain quantities of bubbles, or "seed," or it may become milky and unfit for use; too high a temperature, on the other hand, is severe on the pot and may cause it to leak or cast stones, or the increased solution of pot material in the melt may add to the color of the glass and decrease its transmission. Moreover, variations in the working temperature will mean variations in the amount of selective volatilization and, consequently, variations in optical properties from pot to pot. Furthermore, in the closing stages of furnace treatment, the melt is cooled until a certain degree of stiffness is attained, when the pot is withdrawn. The quality of the glass—its freedom from striæ and bubbles—will depend in large measure on whether the temperature to which cooling has been carried is suitable. For each type of glass there is a narrowly restricted range of temperature to which each pot of the given type should be cooled before withdrawal. A quick and reliable method of measuring temperatures is, therefore, of the first importance. In the optical-glass work conducted by the staff of the Geophysical Laboratory during the period of the war, much attention was given to the matter of determining what methods would meet the requirements. This article will deal with these investigations and with the application of the results to actual practice at various plants.

At the time that the work of the Geophysical Laboratory was begun at the Bausch & Lomb plant, each melting furnace was equipped with a thermocouple, of which the elements were platinum and an alloy of platinum and rhodium. The elements were inserted in tubes set in the back walls of the furnaces and so placed that the position of the thermojunctions was nearly flush with the inner, or heated, side of the rear

---

\* Petrologist, Geophysical Laboratory, Carnegie Institution of Washington.

walls and a little above the level of the top of the pot. Leads were brought to a direct-reading instrument conveniently placed for observation by the furnace men, and regulation of temperatures was dependent on these readings. Although the thermocouples were protected from contamination by tubes of dense and apparently impervious porcelain, it was recognized that their readings were not entirely reliable. Later work showed that the unreliability was greater than had been supposed. It seemed that, for constant use, a pyrometer of the Morse or Holborn-Kurlbaum type would meet the requirements much better than thermocouples, and an instrument of this design was obtained from the Leeds & Northrup Co.

This instrument consists essentially of a telescope with a small incandescent-lamp filament placed in the front focal plane of the eyepiece. The telescope is directed at the object of which the temperature is required and an electric current is sent through the lamp filament. The strength of the current is regulated by a rheostat until the brightness or intensity of illumination of the filament matches that of the object sighted upon. The strength of current is then read upon a milliammeter, and the corresponding temperature is obtained from an empirical calibration table, which is supplied with the instrument. For measuring very high temperatures, the degree to which the heating of the filament would have to be carried to match the luminosity of the furnace or other object would be likely to produce such changes in the filament as would affect its calibration and shorten its life. Therefore, the instrument is provided with an absorption screen, which may be readily inserted between the lamp filament and the object of which the temperature is to be measured, and which cuts down the intensity of radiation from the latter. Naturally, a separate calibration table must be used when the screen is inserted and the sensitiveness of the instrument is greatly diminished. The limit at which it is considered safe to make frequent use of the instrument without the absorption screen is about 1400°; and as the accurate determination of temperatures much higher than this is seldom necessary in optical-glass furnaces, the use of the screen may generally be dispensed with.

According to the Stefan-Boltzmann law, the complete emission of what is known as a "black body" is proportional to the fourth power of the absolute temperature.<sup>1</sup> From this, it follows that the brightness of a luminous object changes very rapidly with the temperature and that comparatively small differences of temperature (as small as two or three degrees) may readily be perceived. This fact is of great importance in the practical application of the instrument.

In order to obtain a trustworthy foundation for the use of this instrument a rather thorough exploration and study of furnace temperatures

---

<sup>1</sup> R. W. Wood: "Physical Optics." 614. 1911.

was carried out by means of devices to be described. The first information sought was as to the reliability of the calibration table; to obtain this it was necessary to use a device that would give "black-body radiation." A "perfectly black" body is a perfectly absorbing body and emits radiation whose intensity is a function of the temperature alone. Most substances are of such a nature that when they are heated until they become luminous the intensity of their radiation is dependent upon an emissivity factor, the effect of which is such that two bodies at the same temperature may appear unequally bright. Naturally a substance with a surface possessing the power of reflection will send to the eye reflected rays proceeding originally from colder or hotter objects adjacent to it, and to a proportional degree will fail to send forth the luminous rays corresponding to its own temperature. A good example of an almost perfectly reflecting body is a highly polished metallic mirror. Though cold itself, it may reflect an image of the sun, for instance, representing a temperature of many thousand degrees; or, it may be heated to a temperature of, say,  $1000^{\circ}$  and (if the surface does not become tarnished) may reflect the image of a cold and black substance nearby and fail to send out its own proper radiation. On the other hand "black-body radiation" is given out by a substance with a surface that possesses no reflecting power and therefore absorbs all radiation falling upon it.<sup>2</sup> No substance fulfills this condition perfectly, but the requirements may be met satisfactorily by heating uniformly throughout its length a long tube of poorly reflecting material, closed at one end, so that all rays proceeding from the bottom, whether they originate there or are reflected from another part of the tube, correspond to one and the same temperature.

To meet the required conditions we used a porcelain tube about 1 m. long that had an orifice of 18 mm., and was stoppered at one end with clay. This tube was inserted into the furnace and the far end was allowed to rest upon the rim of the glass pot until it became well heated. The optical pyrometer was then sighted through the orifice upon the clay plug at the far end, and a reading taken. A new and reliable thermocouple of platinum and platinum-rhodium was then inserted into the tube and readings of electromotive force were taken with a direct reading millivoltmeter. These readings, with the necessary cold-junction correction, were believed to represent true temperatures, and were taken as the standard of reference. Thus tested, the temperatures given by the calibration tables for this instrument were found to agree surprisingly well with true temperatures. Some of the results are given in Table 1. Later tests with other instruments indicated that this instru-

---

<sup>2</sup> For a more complete discussion of the laws of radiation and absorption see, for example, "Physical Optics," by R. W. Wood (1911), especially 591 and following; or "A Text-book of Physics," edited by A. W. Duff (1913), 279 and following.

ment was somewhat exceptional and that not equal care in calibration had been used in all cases.

TABLE 1.—*Test of Optical Pyrometer by Comparison with Thermocouple Readings for Black-body Radiation*

| Optical Pyrometer, Degrees C. | Thermocouple, Degrees C. | Difference, Degrees C. | Optical Pyrometer, Degrees C. | Thermocouple, Degrees C. | Difference, Degrees C. |
|-------------------------------|--------------------------|------------------------|-------------------------------|--------------------------|------------------------|
| 1122                          | 1126                     | -4                     | 1392                          | 1390                     | +2                     |
| 1076                          | 1080                     | -4                     | 1392                          |                          |                        |
| 1022                          | 1022                     | 0                      | 1389                          | 1389                     | 0                      |
| 1246                          | 1246                     | +2                     | 1371                          | 1365                     | +3.5                   |
| 1248                          |                          |                        | 1366                          |                          |                        |
| 1250                          |                          |                        |                               |                          |                        |

The next matter on which information was desirable was that of the degree of agreement of temperatures as indicated by readings on the

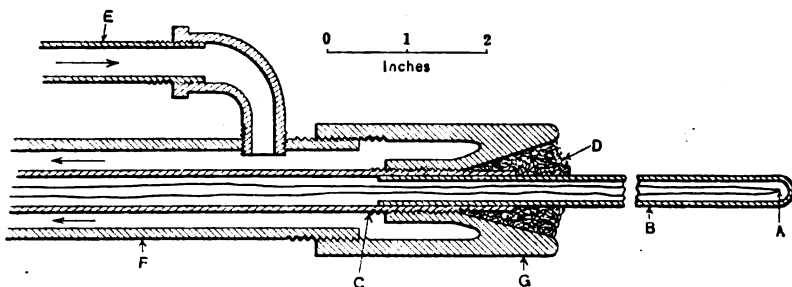

FIG. 1.—CONSTRUCTION OF TERMINAL PORTION OF WATER-COOLED DEVICE FOR EXPLORING FURNACE TEMPERATURES.

furnace walls with true temperatures; that is, to ascertain whether the radiation given out by the heated walls corresponded with black-body radiation, or whether reflections from the somewhat glazed surfaces of the refractory lining would cause significant departures from correct results. To obtain this information the furnace temperatures were explored with a specially constructed device, by which a thermocouple could be brought to any desired spot and readings obtained, and to compare these readings with the results obtained by sighting the pyrometer on the adjacent wall. The device, shown in Fig. 1, consisted of a water-cooled iron tube *C* (or assemblage of tubes) 9 or 10 ft. (2.74 or 3.04 m.) in length, through the inner orifice of which the compensating leads of a thermocouple were carried. The thermocouple proper (consisting of platinum and platinum-rhodium) extended into a porcelain tube *B* 35 cm. long that projects beyond the water-cooled part. Fig. 1 shows the terminal portion of this device. The thermojunction is shown at *A*; in

the water-cooled part the wires are connected with compensating leads of alloys of which the thermoelectric force over the range of temperature here used is very closely equivalent to that of the platinum and platinum-rhodium wires of the thermocouple, so that no appreciable error is introduced by subsidiary currents set up at the junctions. Their use obviates the need of carrying the platinum and platinum-rhodium wires back 10 or 15 ft. (3.04 or 4.57 m.) to the meter. The thermocouple wires are in-

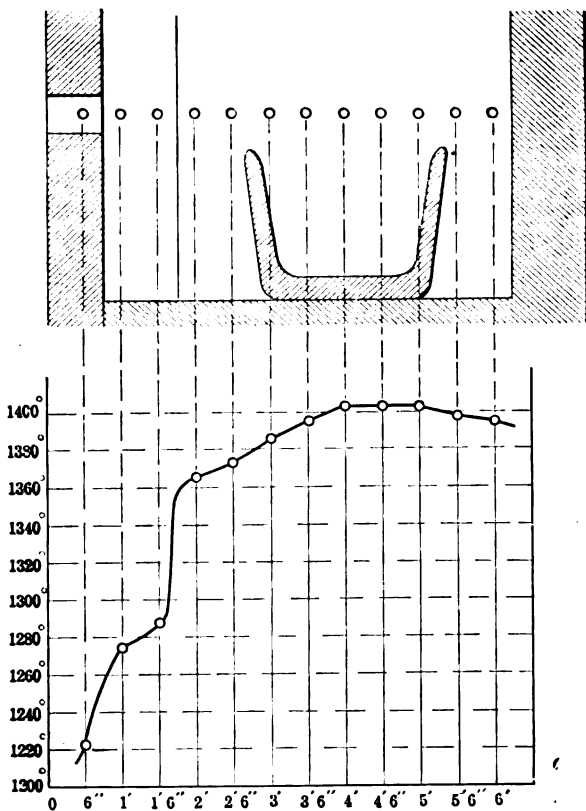

FIG. 2.—CROSS-SECTION OF FURNACE, SHOWING POINTS AT WHICH TEMPERATURE MEASUREMENTS WERE MADE, AND THE CORRESPONDING DISTANCE-TEMPERATURE CURVE.

sulated by porcelain capillaries (not shown) and the compensating leads by glass tubes. Asbestos wool *D* is packed around the porcelain tube to hold it in place and also to serve as a heat insulator and prevent a too severe temperature gradient where the porcelain tube *B* enters the iron tube *C*. The iron tube *C*, supply pipe *E* for the water-circulating system, and the return pipe *F* extend back to the outside of the furnace, where hose connections are made to pipes *E* and *F* and a bushing is fitted to the tube *C*, through which the leads are carried. The fitting *G* by

which the various parts are held together and kept in position was the only special construction required. This device had to be carefully handled and was not adapted for constant use, but it served the purpose for which it was devised and gave the required information. One of the first purposes for which it was used was to ascertain the distribution of temperatures from the front to the rear of a furnace in which a pot of glass was being held at fining temperature. The results are shown in Table 2 and Fig. 2.

TABLE 2.—*Distribution of Temperatures in a Furnace under Fining Conditions*

| Distance from Front Face of Tuiile, Feet | Temperature, Degrees C. | Distance from Front Face of Tuiile, Feet | Temperature, Degrees C. |
|--|-------------------------|--|-------------------------|
| 0.5                                      | 1222                    | 3.5                                      | 1396                    |
| 1.0                                      | 1273                    | 4.0                                      | 1403                    |
| 1.5                                      | 1287                    | 4.5                                      | 1403                    |
| 2.0                                      | 1365                    | 5.0                                      | 1403                    |
| 2.5                                      | 1373                    | 5.5                                      | 1398                    |
| 3.0                                      | 1386                    | 6.0                                      | 1395                    |

A comparison of temperatures as determined by the exploratory thermocouple and by the optical pyrometer showed that the interior walls of the furnace gave radiations that agreed to a very satisfactory degree with black-body radiations at the temperatures at which most of the furnace operations are conducted. The results of the determinations are given in Table 3.

TABLE 3.—*Comparison of Furnace Temperatures as Read by Exploratory Thermocouple and by Optical Pyrometer*

| Thermo-couple Reading, Degrees C. | Pyrometer Reading, Degrees C. | Difference in Readings, Degrees C. | Thermo-couple Reading, Degrees C. | Pyrometer Reading, Degrees C. | Difference in Readings, Degrees C. |
|-----------------------------------|-------------------------------|------------------------------------|-----------------------------------|-------------------------------|------------------------------------|
| 1320                              | 1322                          | +2                                 | 1273                              | 1274                          | +1                                 |
| 1315                              | 1320                          | +5                                 | 1398                              | 1397                          | -1                                 |
| 1311                              | 1320                          | +9                                 | 1398                              | 1397                          | -1                                 |
| 1309                              | 1312                          | +3                                 | 1411                              | 1413                          | +2                                 |
| 1278                              | 1282                          | +4                                 | 1412                              | 1413                          | +1                                 |

The very close agreement shown is doubtless due, in some measure, to a counterbalancing of errors, as the methods used were not of the degree of precision indicated by these figures. We believed, however, that the necessary dependability of readings at these temperatures by the optical pyrometer was established. At lower temperatures the agreement

was less perfect. At a temperature of  $1000^{\circ}$  or  $1050^{\circ}$ , the readings taken by the optical pyrometer on the rear wall were likely to be as much as  $40^{\circ}$  or  $50^{\circ}$  too high, and might be even more in error. This was probably to be ascribed to departure from theoretical black-body conditions. The rear wall of the furnace probably receives and reflects radiations from hotter regions adjacent, such as the cap on which the flames play or from the flames themselves, and a source of error is thus introduced. It was noticeable that when the temperature was not very high the parts of the rear and end walls that are immediately adjacent to each other were likely to appear of unequal brightness, though there could hardly be much actual difference in temperature.

These investigations supplied sufficient data to enable us to use the instrument with confidence during the operations of melting and fining. It was therefore used daily as a substitute for the thermocouples, though the latter were still considered useful to a certain extent when properly controlled by the pyrometer. It was necessary, however, in order to use the thermocouples at all, to keep a constant check upon their readings. Not only were their indications always too low by  $100^{\circ}$  to  $150^{\circ}$ , but the error was not constant; there were likely to be gradual fluctuations each day. No investigation was made into the reason for this, but the supposition was that the fluctuations were to be attributed to contamination by the combustible gases or by material volatilized from the melts.

The furnace men were instructed in the use of the optical pyrometer, and a number of them showed considerable skill, so that we felt confident that during the night shifts the pyrometer would be properly used for regulating or maintaining temperatures. Immediately following its introduction, two gratifying results ensued: The occasional pots of milky glass ceased almost entirely and the losses from leakage of pots were almost eliminated. We think these results were due to the better knowledge of temperatures than was possible before and to the ability to keep the temperatures where wanted.

Our experience with the optical pyrometer at the Bausch & Lomb plant caused us to install similar instruments at the plants of the Spencer Lens Co. at Hamburg, New York, and of the Pittsburgh Plate Glass Co. at Charleroi, Pa., when the work of the Geophysical Laboratory was extended to these plants. We felt it advisable to check the calibration of the new instruments, as so much depended on their correctness. The results were not as favorable, upon the whole, as with the first instrument.<sup>3</sup> The data obtained in one case are given in Table 4. In this instance we did not use an exploratory thermocouple and therefore were not able

---

<sup>3</sup> From a mechanical standpoint also these instruments were defective in a number of respects, and this caused us a good deal of annoyance and trouble. Later instruments have been considerably improved.



to obtain as full information regarding the distribution of temperatures, but the method employed was adequate for the main purpose in view. It consisted of inserting into the furnace a long porcelain tube, stoppered with clay (similar to that already described), so that the closed end was over the center of the pot; of reading temperatures with the optical pyrometer sighted through the tube upon the stopper (which corresponded to a black body) and also upon the furnace wall back of the pot; and of comparing these with readings obtained by a new and tested thermocouple introduced into the tube. These readings were taken under conditions that were probably rather less favorable than those ordinarily met in similar testing work in a commercial establishment; that is, they were made during the pressure of other duties and at a time when the demands upon furnace capacity forbade much delay and made it undesirable to attempt to hold the temperatures exactly constant during each set of readings. The degree of precision attained was, therefore, considerably less than would be possible under laboratory conditions, but the results may be taken as fairly representative of what may be easily realized in practical work and they are therefore given in some detail. Two observers *A* and *B* worked in conjunction.

A porcelain tube 39 in. (1 m.) long was inserted through the small opening in the tuille and rested on the empty pot. The distance to the end of the tube from the outside of the tuille was 37 in. (93.9 cm.) and the distance of the thermojunction from the outside of the tuille was 33 in. (83.8 cm.). The cold junction of the thermocouple was in ice water and the readings were taken by a direct-reading millivoltmeter. Table 4 shows that the readings of the optical pyrometer were in general 20° to 30° low; 25° was adopted as representing the error with a reasonable degree of closeness.

A calibration of this kind is not very difficult and should always be carried out when a new instrument is put in service. Without this calibration, it may be possible to use the instrument empirically and get reproducible results, when all the conditions are kept constant, but the object should be to determine the true temperature values. It is only by means of such information that comparisons may be made with other establishments or that reproducibility may be secured when a change of furnace construction is made or a new working procedure is put into effect. Such a calibration is necessary in order not only to check the manufacturer's calibration, but also to determine whether the furnace walls indicate a temperature that corresponds to that of the pot.

There is probably some change in the latter respect with length of service of the lining. A new lining is likely to have less reflecting power and to give truer readings than one that has been in service for several months and has become somewhat glazed. Moreover, the calibration of the pyrometer itself may change. With several instruments that we

TABLE 4.—Data Obtained in Calibration of Optical Pyrometer

| No.       | Thermo-couple Reading, Degrees C. | Optical Pyrometer Reading, Degrees C. | Observer         | Part Sighted On With Optical Pyrometer | Average of Optical Pyrometer Readings, Degrees C. | Error of Optical Pyrometer, Degrees C. |   |                          |      |        |
|-----------|-----------------------------------|---------------------------------------|------------------|--|---|--|---|--------------------------|------|--------|
| 1         | 1046                              | 1028                                  | B                | Inside of porcelain tube               | 1027  |  |   |                          |      |        |
|           |                                   | 1028                                  | B                | Inside of porcelain tube               |   |  |   |                          |      |        |
|           |                                   | 1025                                  | A                | Inside of porcelain tube               |   |  |   |                          |      |        |
|           |                                   | 1028                                  | A                | Inside of porcelain tube               |   |  |   |                          |      |        |
|           |                                   | 1028                                  | A                | Inside of porcelain tube               |   |  |   |                          |      |        |
|           |                                   | 1022                                  | A                | Rear wall of furnace                   |   |  |   |                          |      |        |
|           |                                   | 1028                                  | B                | Rear wall of furnace                   |   |  |   |                          |      |        |
|           |                                   | 1028                                  | B                | Rear wall of furnace                   |   |  |   |                          |      |        |
|           |                                   | 1028                                  | B                | Rear wall of furnace                   |   |  |   |                          |      |        |
|           |                                   | 1028                                  | B                | Rear wall of furnace                   |   |  |   |                          |      |        |
| 2a        | 1103                              | 1076                                  | A                | Inside of porcelain tube               | 1074  | 28 low                                 |   |                          |      |        |
|           |                                   | 1076                                  | B                | Inside of porcelain tube               |   |  |   |                          |      |        |
|           |                                   | 1066                                  | B                | Inside of porcelain tube               |   |  |   |                          |      |        |
| 2b        | 1110                              | 1076                                  | B                | Inside of porcelain tube               | 1084  | 26 low                                 |   |                          |      |        |
|           |                                   | 1082                                  | B                | Rear wall of furnace                   |   |  |   |                          |      |        |
|           |                                   | 1082                                  | B                | Rear wall of furnace                   |   |  |   |                          |      |        |
| 2c        | 1110                              | 1087                                  | A                | Rear wall of furnace                   | 1089  | 21 low                                 |   |                          |      |        |
|           |                                   | 1085                                  | A                | Rear wall of furnace                   |   |  |   |                          |      |        |
|           |                                   | 1087                                  | B                | Inside of porcelain tube               |   |  |   |                          |      |        |
| 3a        | 1189                              | 1089                                  | A                | Inside of porcelain tube               | 1157  | 32 low                                 |   |                          |      |        |
|           |                                   | 1092                                  | A                | Inside of porcelain tube               |   |  |   |                          |      |        |
|           |                                   | 1155                                  | B                | Inside of porcelain tube               |   |  |   |                          |      |        |
|           |                                   | 1157                                  | B                | Inside of porcelain tube               |   |  |   |                          |      |        |
|           |                                   | 1154                                  | A                | Inside of porcelain tube               |   |  |   |                          |      |        |
|           |                                   | 1161                                  | A                | Inside of porcelain tube               |   |  |   |                          |      |        |
| 3b        | 1189                              | 1161                                  | A                | Inside of porcelain tube               | 1150  | 30 low                                 |   |                          |      |        |
|           |                                   | 1152                                  | A                | Inside of porcelain tube               |   |  |   |                          |      |        |
|           |                                   | 1161                                  | B                | Rear wall of furnace                   |   |  |   |                          |      |        |
| 4         | 1225                              | 1156                                  | A                | Rear wall of furnace                   | 1218  | 13 low*                                |   |                          |      |        |
|           |                                   | 1156                                  | A                | Rear wall of furnace                   |   |  |   |                          |      |        |
|           |                                   | 1200                                  | B                | Inside of porcelain tube               |   |  |   |                          |      |        |
|           |                                   | 1208                                  | B                | Inside of porcelain tube               |   |  |   |                          |      |        |
|           |                                   | 1216                                  | B                | Inside of porcelain tube               |   |  |   |                          |      |        |
|           |                                   | 1219                                  | A                | Inside of porcelain tube               |   |  |   |                          |      |        |
|           |                                   | 1219                                  | A                | Inside of porcelain tube               |   |  |   |                          |      |        |
|           |                                   | 1223                                  | A                | Inside of porcelain tube               |   |  |   |                          |      |        |
|           |                                   | 1226                                  | B                | Inside of porcelain tube               |   |  |   |                          |      |        |
|           |                                   | 1228                                  | B                | Inside of porcelain tube               |   |  |   |                          |      |        |
|           |                                   | 1219                                  | B                | Inside of porcelain tube               |   |  |   |                          |      |        |
|           |                                   | 1221                                  | B                | Rear wall of furnace                   |   |  |   |                          |      |        |
|           |                                   | 1221                                  | B                | Rear wall of furnace                   |   |  |   |                          |      |        |
|           |                                   | 1219                                  | A                | Rear wall of furnace                   |   |  |   |                          |      |        |
|           |                                   | 1216                                  | A                | Rear wall of furnace                   |   |  |   |                          |      |        |
| 1219      | A                                 | Rear wall of furnace                  |                  |  |   |  |   |                          |      |        |
| 5         | Av., 1231<br>1248                 | 1212                                  | B                | Inside of porcelain tube               | 1222  | 26 low                                 |   |                          |      |        |
|           |                                   | 1219                                  | B                | Inside of porcelain tube               |   |  |   |                          |      |        |
|           |                                   | 1216                                  | B                | Inside of porcelain tube               |   |  |   |                          |      |        |
|           |                                   | 1223                                  | A                | Inside of porcelain tube               |   |  |   |                          |      |        |
|           |                                   | 1226                                  | A                | Inside of porcelain tube               |   |  |   |                          |      |        |
|           |                                   | 1228                                  | A                | Inside of porcelain tube               |   |  |   |                          |      |        |
|           |                                   | 1225                                  | B                | Inside of porcelain tube               |   |  |   |                          |      |        |
|           |                                   | 1221                                  | B                | Inside of porcelain tube               |   |  |   |                          |      |        |
|           |                                   | 1224                                  | B                | Rear wall of furnace                   |   |  |   |                          |      |        |
|           |                                   | 1224                                  | B                | Rear wall of furnace                   |   |  |   |                          |      |        |
|           |                                   | 1226                                  | A                | Rear wall of furnace                   |   |  |   |                          |      |        |
|           |                                   | 1223                                  | A                | Rear wall of furnace                   |   |  |   |                          |      |        |
|           |                                   | 1223                                  | A                | Inside of porcelain tube               |   |  |   |                          |      |        |
|           |                                   | 6                                     | 1316 }<br>1323 } | 1298                                   |   |  | B | Inside of porcelain tube | 1298 | 20 low |
|           |                                   |                                       |                  | 1292                                   |   |  | B | Inside of porcelain tube |      |        |
| 1295      | B                                 |                                       |                  | Inside of porcelain tube               |   |  |   |                          |      |        |
| 1285      | A                                 |                                       |                  | Inside of porcelain tube               |   |  |   |                          |      |        |
| 1300      | A                                 |                                       |                  | Inside of porcelain tube               |   |  |   |                          |      |        |
| 1302      | A                                 |                                       |                  | Inside of porcelain tube               |   |  |   |                          |      |        |
| 1297      | A                                 |                                       |                  | Rear wall of furnace                   |   |  |   |                          |      |        |
| 1300      | A                                 |                                       |                  | Rear wall of furnace                   |   |  |   |                          |      |        |
| 1306      | B                                 |                                       |                  | Rear wall of furnace                   |   |  |   |                          |      |        |
| 1304      | B                                 |                                       |                  | Rear wall of furnace                   |   |  |   |                          |      |        |
| Av., 1318 |                                   |                                       |                  |  |   |  |   |                          |      |        |

\* The inconsistency of this result with the others of the series is evidently due to variations in the temperature of the furnace while the readings were in progress.

were using, the current required to produce a given intensity of filament luminosity changed gradually with use. For these reasons it is essential to make occasional recalibrations of the instruments in order to be able to place reliance upon their indications. The most troublesome part of such a calibration is sighting through the long porcelain tube upon a rather small area at the end. Naturally there is likely to be some variation in the results, and therefore sufficient readings should be taken to lessen the error. To match the luminosity of the filament with that of a large object, such as the furnace wall, is comparatively easy, and in a series of such readings the difference between the highest and lowest should seldom exceed  $5^{\circ}$  or  $6^{\circ}$ . Different observers also should agree closely in their readings. Unless extraordinary demands are being made upon furnace capacity, which will forbid keeping the furnace out of operation for any considerable period, it will usually be possible to hold the temperature steady during a set of readings, which will aid greatly in giving consistent results. If a laboratory is available, in which an electric resistance furnace forms part of the equipment, the work of calibrating the lamp may be considerably facilitated, as the necessary apparatus may be set up in more convenient form and more constancy of temperatures may be maintained. In order to obtain black-body conditions under such circumstances we used, in some of our calibration work, baffles so disposed around the orifice of the furnace as to cut off from the chamber into which the instrument was sighted practically all radiation from regions of lower temperature.<sup>4</sup> The true value of the temperature within the chamber was given by a thermocouple. It should be noted that such a method of calibration gives results that apply to black-body conditions only, and that for practical use it is still necessary to determine to what degree the walls of a given furnace fulfill these conditions.

The use of the instrument in daily work hardly requires extended description. During a large part of the time that a pot of glass is in the furnace the temperature should be maintained at a constant high level, usually about  $1400^{\circ}$  C., and all that is required is that the pyrometer is used often enough to maintain the constancy of temperature. Later, in the final stages of stirring, the fire is turned off and the temperature is allowed to drop. When a certain temperature is reached (which will vary with the type of glass) stirring is stopped and the pot is removed. It is of great importance that this be done at the proper moment, and the optical pyrometer is well adapted for following the temperature of the cooling glass. A few minutes before the end of operations, an extrapolation is made on a plot of the cooling curve to the required temperature and the corresponding time for removal is thus determined. A pre-

---

<sup>4</sup> See "Methods of Measuring Temperature," by Ezer Griffiths (1918), 116, or "Measurement of High Temperatures," by G. K. Burgess and H. Le Chatelier (1912), 240.

caution that should be kept in mind is to observe some definite rule as to the part of the surface of the glass upon which readings are taken, as there are noticeable differences in brightness over the surface during the final stages of stirring. A good plan is to sight upon the area immediately behind the stirring-rod, as the movement of the rod through the glass brings hotter material to the surface and the area mentioned is likely to give the brightest glow.

Although the paper has referred more especially to the procedure adopted when open pots are used, the same principles apply to covered pots. With these the arrangement is such that in sighting at the interior wall of the pot the reading is even more likely to correspond to that of a black body and to represent the temperature of the melt than when the wall back of the pot is sighted upon, as is done when open pots are used. There is a little uncertainty as to the effect upon the readings produced by the volatilized sublimates, but it does not seem that they should be a factor of significance. It is only as these fumes escape into the open air and are condensed that sighting through them should have a noticeable effect upon the readings, and even there they are so tenuous that it is doubtful whether the effect is appreciable. Moreover, they often come out in such a manner that it is possible to sight under or over them rather than through them.

Some workmen may be found to whom the regulation of temperatures by means of an instrument of this kind may be entrusted with confidence. Naturally, such operations as plotting a temperature-time curve of a pot of cooling glass require some special ability, but the procedure may be simplified by having sheets of coördinate paper prepared, with the hours of the day printed along the bottom and the degrees of temperature at the side. The use of these is quite easily understood. Nevertheless, the superintendent or foreman must exercise considerable supervision in order to get the best results. This, however, is true of all steps in the making of optical glass.

#### DISCUSSION

CLARENCE N. FENNER.—Mr. Gelstharp, chief chemist of the Pittsburgh Plate Glass Co., has directed my attention to the fact that that company was using optical pyrometers obtained from the Leeds & Northrup Co. several months before the members of the Geophysical Laboratory arrived at Charleroi. I am glad to make this correction. The chief object of my paper was to emphasize the necessity of careful temperature control in the making of optical glass and to describe the kind of tests to which an optical pyrometer should be subjected at a glass plant in order to obtain information regarding the closeness with which its readings correspond with true temperatures under the conditions which prevail in each particular case.

## Pyrometry as Applied to Manufacture of Optical Glass

BY CARL W. KEUFFEL,\* M. E., NEW YORK, N. Y.

(Chicago Meeting, September, 1919)

THE manufacture of optical glass is a new industry in this country. In 1914, after the war started, the supply of optical glass from Europe was cut off, but as there was a fairly large stock of glass on hand, it was not until the end of 1915 that the optical instrument makers made serious efforts to produce their own glass. These early attempts were generally made by practical glass men and, due primarily to the fact that very little scientific help was used, the first attempts were unsuccessful. It was not until the whole problem was attacked by technically trained men who used advanced methods of research that good results were obtained. These researches proved that the accurate control of the temperature was a most important factor in the manufacture of optical glass.

The early glass maker judged temperatures with his eyes; later, Seger cones were introduced into the furnace at various stages of the melt. Then radiation, indicating and recording pyrometers with rare-metal thermocouples were introduced. Now, in addition to these, an optical pyrometer every hour or so is sighted right into the pot and on the molten glass.

Figs. 1 and 2 show how pyrometers are used to control the melt. In Fig. 2, *Y* is the clay pot in which the batch is melted to glass within the furnace *X*. The rare-metal thermocouple *S*, protected by a clay tube, extends through the wall and about 4 in. into the furnace. This couple is connected to an indicator *T* and a recorder *U* so that a complete record of the furnace temperatures is obtained. The section of the curve *ABCD*, Fig. 1, shows how gradually and carefully the clay pot must be heated to get rid of moisture *AB* and during the calcining at *CD*. The stem of an expansion pyrometer *R* is extended through a hole in the door *Z* of the furnace and into the pot in order to more closely follow the temperatures of the clay pot itself during the burning process, that is from *A* to *D*. After the pot is calcined, the temperature can be rapidly raised to *E* (about 1430° C.); from *E* to *F* this temperature is much higher than at any other stage in order to slightly overburn the pot, which will become very dense and shrink to its final size. The temperature is then lowered to about 1400° C. and at *G* to *H* the batch is introduced in about four to five charges. From *H* to *M* the glass is thoroughly mixed by

---

\* Supervisor, Optical Department, Keuffel & Esser Co.

means of a stirring machine and a clay stirring rod until it is homogeneous. This stirring is kept up until a certain point *N* is reached, where the glass becomes quite viscous, when the whole operation is stopped. The temperature is then reduced to room temperature at such a rate that the

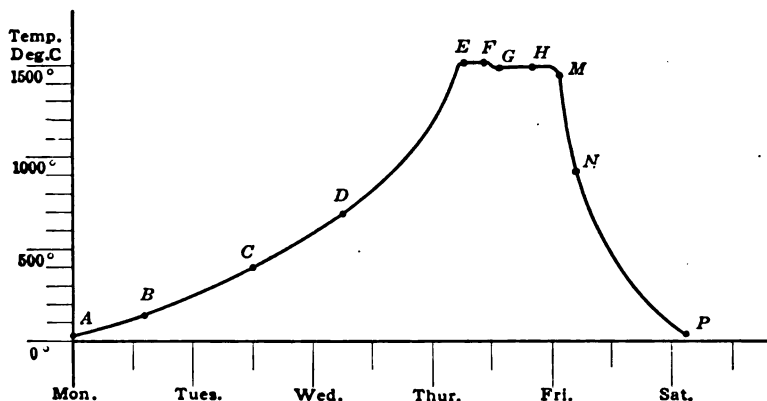

FIG. 1.—TEMPERATURE CYCLE.

glass in the pot will solidify and, due to strain formed during this cooling, break up into small chunks. The size of the chunks depends on the rate of cooling. During the part *GHMN* of the cycle, accurate temperatures are taken on the surface of the glass *Y*, Fig. 2, in the pot by means of an

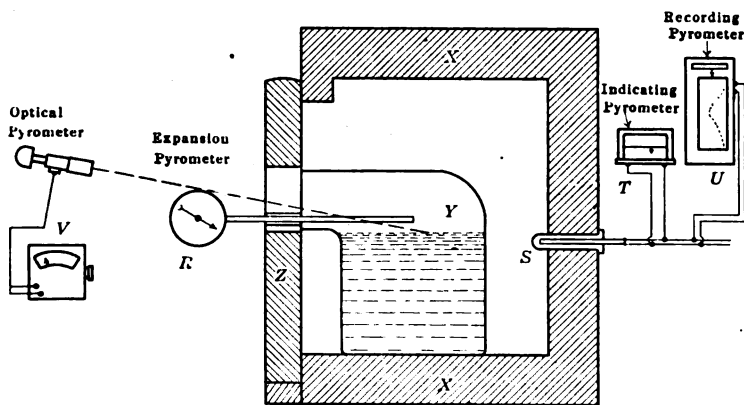

FIG. 2.—SECTION OF MELTING FURNACE.

optical pyrometer *V*. It is by watching this part of the cycle closely, and controlling temperatures accurately, that it has been possible to reproduce successfully the various kinds of optical glass. In fact, the quality of the glass produced depends more on accurate temperature control than on any other one factor.

The chunks of glass produced must be molded or pressed into various

508 PYROMETRY AS APPLIED TO MANUFACTURE OF OPTICAL GLASS

forms to make them ready for use in optical instruments. This is done by slowly heating the chunks to a bright red, when they will be soft enough to be pressed into form. These formed pieces must then be cooled at a certain rate and in such a way that no internal strains are set up. A lens or prism made from glass that is not reasonably free from strain may very seriously affect the definition of the instrument. Prisms and large lenses for high-grade instruments, such as range finders and periscopes, are, therefore, annealed in an electric furnace that is controlled by an automatic pyrometer regulator. This regulator is so constructed that between 600° and 200° C. the furnace temperature can be made to drop anywhere from 1° C. every 2 or 3 hr. to 10° C. per hr. or more. For every different kind of glass a special cooling curve must be followed; and here again it has been proved that perfect temperature control is absolutely essential in order to produce a good product.

## Pyrometer Shortcomings in Glass-house Practice

BY W. M. CLARK,\* PH. B., AND CHARLES D. SPENCER,\* CLEVELAND, OHIO

(Chicago Meeting, September, 1919)

OUR interest in the matter of pyrometers and pyrometry is primarily that of a user of considerable quantities of heat-measuring equipment; and while we may be somewhat critical on the subject we have aimed to make the nature of these comments constructive.

The glass industry in America dates back to 1609, when Capt. John Smith started a small glass plant near Jamestown, Va., with a few Italian workmen, to manufacture glass beads for trading with the Indians. While the industry has expanded until it has reached a volume of over \$200,000,000 per annum, the means of heat determination in Colonial days was the human eye, and in much of the industry the same means is used today. About 15 yr. ago the largest glass-house supply dealers began to sell platinum pyrometers, but as nearly all of these proved unsatisfactory, pyrometers met a temporary rebuff from the old-time glass manufacturers. As their ruggedness of construction, reliability, and stability have been improved, however, pyrometers have gradually won their way into more and more extensive use throughout the glass trade. But there are still many applications where pyrometers are not used, largely because of cost and upkeep considerations.

There are two distinct fields in glass works for pyrometry. The first calls for accurate temperature measurement and the second only demands knowledge of relative comparative fluctuations of temperature, to know whether the work is becoming hotter or colder. For example, in a lehr for annealing glassware and removing strain we want accurate temperatures to know that the ware is heated to the critical temperature for rapid removal of strain. On the other hand, in a glass pot furnace nearly 120 ft. (36 m.) in circumference, where the pyrometer couples only project inside the furnace wall for less than 2 in. (50 mm.), it is inconceivable that these few inches represent the accurate temperature at every point of the 120-ft. circumference but the relative readings as to whether the pyrometer shows schedule temperature fluctuations are valuable indications for control. The glass melting in the pots is, however, a sensitive pyrometer because the duration of the time of melting shows clearly whether the furnace is too hot or too cold. If the glass

---

\* National Lamp Works of General Electric Co.



## 510 PYROMETER SHORTCOMINGS IN GLASS-HOUSE PRACTICE

melts and is workable in 22 hr. when it should be ready in 20 hr., the cause must be insufficient heat.

### LACK OF STANDARDIZATION OF COUPLES

One of the manufacturers maintains that platinum-platinum-iridium couples are more stable under glass-house conditions. Others use Heraeus platinum-platinum-rhodium wire of two different diameters. Others use platinum-platinum-rhodium wire of different manufacture and different electromotive force from the preceding. Couples of different manufacture are not interchangeable. The porcelain tubes are also from diversified sources and of varying degrees of excellence.

### COLD-JUNCTION COMPENSATION

There are a variety of schemes proposed to meet this condition, such as burying the cold junction, introducing it into a thermos bottle, using compensating lead wires and returning to a thermostat box, water-jacketing the cold junction, etc. The average glass manufacturer does not understand the subject and generally omits cold-junction compensation altogether, because it is usually presented in a bewildering indefinite manner and an impractical arrangement proposed at considerable expense. Standardized practical cold-junction compensation methods would be desirable.

### LACK OF STANDARDIZATION OF INSTRUMENTS

Some of the most successful developments along the line of machinery and equipment have resulted from producing standard lines to meet good manufacturing practice so that the reasonable requirements of the trade are met. The resulting concentration of production on a few types has led to volume production and warranted an investment in molds, machinery, jigs, punches, and dies, etc., enabling the manufacturer to turn out more perfect fittings, interchangeable parts and a much better piece of equipment mechanically and at a greatly reduced cost, over hand-fitted parts and small-scale production.

A survey of the various types of indicators and recorders on the market will show a wide variety of instruments built to meet similar requirements with different meritorious and bad features combined, because they are turned out by small-scale manufacturing, combining various patent features, or attempts to evade competitors' patents. Patent-license arrangements between the manufacturers and centralized production of the different types would tend to bring about greater stability, accuracy, and lessened cost.

Where setscrews and binding posts are involved some of the manufacturers upset the heads of the screws so that the turning knobs cannot be screwed off, dropped, and lost. This should be universally adopted in the interest of avoiding loose connections and the substitution of makeshift nuts and binding posts to replace special parts belonging to instruments and couples.

Brief directions for the setting up, wiring, and adjustment of every instrument should be pasted on the instrument itself or on the case containing the instrument. Or a label should state that information regarding the instrument would be sent by the manufacturer, on request.

In some cases the temperature readings desired lie within a range of a few hundred degrees but the scale on the instrument may be divided equally over 1600° C. In the case of furnace temperatures, for instance, the part of the scale that is read will lie only between 800° C. and 1400° C. Greater accuracy in reading temperatures results from suppressing the zero point and opening up the scale over the part where readings are desired.

After platinum has been exposed to reducing gases for some time, it becomes "sick," or brittle and crystallized. By boiling in nitric acid and heating to redness for a prolonged period it is possible to revivify the platinum and prolong its life materially.

Standardization and calibration of the couples is the next problem. The average plant is not equipped for this maintenance or calibration and couples are generally used until they break. It would seem as if this was properly a function of the service department of the pyrometer manufacturer.

With optical pyrometers our experience has been somewhat limited, but we have used one of the latest model recommended by the Geophysical Laboratory. It is quite expensive, heavy to carry around, and the focusing lens on the end is not fastened on by a catch in a slide or by some other safety arrangement such as could easily be applied, so that it is only a question of time before the lens is dropped off and broken.

#### GLASS-HOUSE NEEDS

In a glass works there are a multitude of places where it would be desirable to have temperature control in the melting and heating processes and equipment relating to combustion. To properly equip a plant with heat indicators or recorders at every point where this knowledge would be of value to the operator would involve prohibitive expense in the present stage of the development of the art of pyrometry. Therefore only the most important locations are equipped. If an instrument, like the Northrup tin pyrometer for example, could be developed at a reasonable cost and of a rugged type it should have great value and extensive application in glass works. Large numbers of the graphite ex-

512 PYROMETER SHORTCOMINGS IN GLASS-HOUSE PRACTICE

pansion type pyrometers are still in use, although they are inaccurate, because they are cheap, rugged, and convenient. An accurate instrument combining these good points would have a still wider field.

Briefly, the need of glass manufacturers, as we see it, is to have reliable heat gages rather than refined instruments. It is customary in machine shop practice to furnish to skilled workmen gages and fine tools of close precision, below 0.001 in. Close-precision instruments, however, are generally confined to the laboratories. Our plea is, therefore, for pyrometer development along similar lines, to have practical apparatus for the skilled, non-technical craftsman to handle and use; to have pyrometer production for the trade become a utility industry producing articles that are bought by the consumer principally on the basis of quality or efficiency for the price and without thought of their pleasing his taste or fancy. They should be judged solely on the basis of performance in proportion to price. What mechanical principles are employed and whether the designs are pleasing to the eye should not be the consideration if efficiency is predominant.

In brief, we feel that if pyrometer equipment resulted from the same intensive organized industrial methods that produce typewriters, adding machines, time clocks, and other modern office and factory appliances, there would be a widely increased usage of applied pyrometry, improvement in design, and much reduced cost due to improved standardized production and distribution methods. The quality, accuracy, and precision of special, more refined pyrometers for scientific work would also benefit from standardization of the utilitarian types.

## Pyrometry in the Manufacture of Clay Wares

BY F. K. PENCE,\* B. A., CER. E., ZANESVILLE, OHIO

(Chicago Meeting, September, 1919)

THE reduction of the firing of clay wares to a science has been one of the most difficult problems of modern ceramic engineering. The number of factors involved in the treatment of these wares has been such a complicated composite of the chemical and the physical properties that, according to the old practice, results depended rather on the art of the operator than on any scientific data available.

The combined influence of the chemical and physical properties of clay minerals renders it difficult to apply the data obtained in one operation to the forecasting of details to be applied in another.

In maturing clay-ware bodies by the application of heat, the chemical reactions involved are, in general, incomplete. The object frequently is to secure a certain physical quality, as density, color, or strength, rather than any particular chemical composition or development. This is more generally true of the so-called crude clay products. In the case of certain more high-grade wares, as the porcelains, it is necessary to reach the temperature required to bring about a certain molecular development or crystalline structure; but even here, time and temperature are at work and must be considered jointly.

The conditions attending the firing of clay wares has led to the use of certain devices in the measurement of the progress of the firing process whereby the influence of the various burning factors on the clay composition under fire is indicated. In the simplest application of this practice, samples of the ware itself are so placed as to be drawn for observation at various intervals during the burn. Although the appearance is affected by the quick cooling treatment, by experience, this practice is successfully used, particularly in the brick industry. The settle of the setting of brick, as measured from the top of the kiln may also serve as a guide in the firing operation. Another example is found in the stoneware industry, where the practice of arranging test pieces made of the same composition as the ware, including the glaze coating, is of assistance, particularly as the appearance of the slip glaze in fusion gives a fairly definite end point.

---

\*Production Superintendent and Ceramic Engineer, American Encaustic Tiling Co.

This pyrometric principle, in which there is indicated the influence of temperature treatment rather than absolute temperature, has its most general application in the use of shrinkage disks and pyrometric cones. The shrinkage disks are so composed as to parallel in their action the progress of the maturing processes in the ware; in this way their field is more limited than that of the pyrometric cones. In the latter case, the slender, pointed, triangular-shaped pieces are composed, in general, of mineral composition similar to that of clay bodies or glazes maturing at the same temperature at which the cone fuses. The cones are made in a series of succeeding numbers with an approximate temperature difference of  $20^{\circ}$  C. between the fusion point of succeeding cones. By using numbers of the series covering the maturing temperatures of a given ware, the end point in the firing of the ware can be established. A convenient practice is to use both shrinkage disks and pyrometric cones, in which the former serve as a guide during the earlier stages of the firing and the latter afford a more delicate indication of the conditions near or at the temperature of maturity. In all these operations, there must be a preliminary study in which the relation between the action of the clay ware and the action of the pyrometric indicator has been established. This relation then serves as a guide to succeeding operations.

This principle is fundamental in the application of devices measuring absolute temperatures in the manufacture of clay wares. The electrical pyrometer, with accessory recorders, affords a means of obtaining time-temperature curves, showing heat development at all stages of the burning process. By determining through preliminary research, the time-temperature curve suited to a given ware, a convenient guide is afforded. Some difficulty is encountered in locating the metal couple at desired points in the kiln, particularly in the case of large kiln installations. The expense of first cost and upkeep in equipping the ordinary periodic kiln with couples at all points where heat observations are desired is also a deterring factor. In the case of the continuous tunnel kiln, a series of metal couples at proper intervals is of distinct service in controlling a temperature level under conditions where slight influences produce rapid changes.

Modern developments in the optical pyrometer have brought it to a state of accuracy which makes it a valuable addition to pyrometric equipment. It is particularly serviceable in the wide distribution of temperature readings that may be obtained. Its application in the use of research furnaces and of high-temperature installations is especially convenient.

In practically all cases, however, in which absolute or approximate temperatures are measured by means of metal-couple (electrical) or

optical pyrometers, the use of shrinkage disks, pyrometric cones, or similar devices is also recommended. In this way, influences other than absolute temperature may be noted and, in general, a more convenient means of obtaining a record from all parts of the kiln contents afforded.

It must be remembered, however, that for each type of clay ware, or wares of the same type where size, shape, or physical property is markedly changed, a preliminary study must be made to determine the relation between the action of the ware and the record of the pyrometer or combination of pyrometers used.

## Application of Pyrometry to the Ceramic Industries

BY C. B. THWING,\* PH. D., PHILADELPHIA, PA.

(Chicago Meeting, September, 1919)

It is likely that among most races, owing to the ease of finding and working clay, the making of clay utensils was learned earlier than the molding of metal implements. The ancients made good pottery and durable brick in kilns that wasted fully one-half the heat and spoiled fully one-fourth of the ware; and, taking the clayworking industry as a whole, we are doing the same today.

The chemical and physical changes involved in the burning of clay are so many and vary so much with the composition of the clay that it is not surprising that the rule-of-thumb methods so commonly employed fail to give uniform results. In its passage from plastic clay to the vitreous or stonelike character the mingled minerals and accidental organic impurities of which the clay is blended must pass through four stages, the second and third usually overlapping and the fourth often beginning before the third is complete. These stages in their order with the rising temperature are drying, dehydration, oxidation, vitrification.

In the first part of the drying stage, usually accomplished in part outside the kiln, the water mixed with clay is dried out at temperatures not much exceeding the boiling point of water. In the later part of this stage, within the kiln, the hygroscopic water absorbed from the air is expelled at somewhat higher temperatures, this stage being known as watersmoking. Some clays are very sensitive to temperature during the drying stage and if the temperature exceeds 100°, the ware becomes checked. Other clays may be dried more rapidly without danger.

In down-draft kilns, the draft is slight during the watersmoking stage and the water driven off from the top rows condenses on the ware in the bottom of the kiln, with the result that high temperatures are likely to be reached at the top of the kiln before the bottom is fully dry. The lag in temperature of the bottom persists to the second stage in spite of the better draft then prevailing.

In the second stage, the water of crystallization, or so-called "chemical water," is set free at a temperature of about 600° C. The liberation and evaporation of this chemical water requires much heat, the result fortunately being that the temperature advances but little even if the firing is continued uniformly.

During the third stage the organic matter, carbon chiefly, is oxidized.

---

\* President, Thwing Instrument Co.

The amount of carbon may vary from  $\frac{1}{2}$  to 6 per cent. With clays high in carbon, considerable time is required to complete the oxidation; especially if much iron in the form of ferrous oxide is present, since the latter takes oxygen to convert it to the ferric state, which imparts the red color to red brick and terra cotta.

If care is not taken to admit enough air and to keep the temperature below 800° C. until the second and third stages are complete, weak and porous ware will result, due to the explosive action of the steam and carbonic gas formed within the ware. More ware is ruined or damaged at this stage than during all of the rest of the burn combined.

During the fourth and last stage of burning, the ware shrinks in volume. Part of it becomes vitrified and binds the unvitrified particles together to give the hardness and strength desired. At this stage also occur the changes, such as oxidation of iron, which determine the color of the finished product.

The first to attempt to measure the temperatures in ceramic kilns was Josiah Wedgwood, the famous English potter. He inserted blocks of standard dimensions in the kiln and withdrew them at intervals, after the beginning of shrinkage, and measured their length. The method has been revived in recent years, the specimens, however, being in the form of rings. Seger's pyrometric cones were an attempt to use the principle of observing the effect of heat on material similar to that being burned and to extend the range of temperature measured. The cones are designed to cover intervals of 30° C. but cannot, of course, be said to indicate temperature as closely as 30° C., as the softening point is a function not only of the temperature but also of the time and, in the case of the lower numbers in particular, of the nature of the kiln gases. An advantage of the method is that it permits taking comparative indications at several places in the kiln at small expense and that some of the locations may be near the center of the kiln, where it is not practicable to measure the higher temperatures with thermocouples.

A third method of roughly measuring the temperature is that of withdrawing samples of the ware itself and observing its appearance.

A fourth method, often used where brick of standard size are burned, is to judge when the kiln is finished by the "settle," or measured shrinkage, of the entire mass in the kiln.

All of the methods named are useful but they give no indications during the earlier part of the burn, when damage is most likely to be done; they cover, at the best, only a few temperatures; and they take no account of falling temperatures and give no clue to the duration of time at which any temperature attained was carried. What is required is a device that will give a graphic time-temperature chart of the temperature of two or more points in the kiln over the entire period of the burn. Such a record makes it possible to establish a standard curve, and by



## 518 APPLICATION OF PYROMETRY TO THE CERAMIC INDUSTRIES

following such a curve, at the same time observing proper condition as to oxidizing or reducing atmosphere, etc., men of ordinary intelligence can burn ware of uniform quality even though they have had little firing experience.

It is now possible to equip any ceramic plant with pyrometers to give accurate records meeting the requirements described at a cost that is soon repaid in improved quality of ware and enormous saving in fuel. Such time-temperature records result in more intelligent as well as more faithful service on the part of the burner, while giving at the same time to the head burner, ceramist, or superintendent, full information on which to base changes in practice, with a view to further improvement in operation.

At present most ware is burned in periodic kilns of the down-draft type, in which the hot furnace gases enter from the sides of the kiln, rise to or toward the top, and escape by openings at the bottom through ducts to the stack. This method of burning is being superseded by continuous tunnel kilns of various types, differing in details, but alike in general method. The tunnel kiln provides a long kiln of small cross-section, divided into a series of zones, in which the temperature increases to a maximum and then diminishes toward the exit end, through which small loads of ware are passed at a suitable rate. The circulation of hot gases is in the direction opposite to the direction of flow of the material through the kiln. The gas and air for combustion enter over the cooling ware and so, being heated to the combustion point on reaching the hot zone, the products of combustion serve to heat the entering stream of ware at any desired rate of increase, determined by the length of the kiln.

The control of temperatures by pyrometers is much easier in the continuous kiln than in the intermittent kiln, since, owing to the dimensions and shape of the kiln, the ware need never be far distant from a pyrometer during its passage through the kiln. In continuous kilns, it is advisable to record the temperatures at six points in the kiln, while the same number of additional couples are connected to an indicating pyrometer. In a round down-draft kiln, at least one point in the crown and one point near the bottom should be recorded; while in a rectangular kiln, top and bottom temperatures should be recorded near each end of the kiln. It is desirable to have the top and bottom temperatures recorded on the same galvanometer for easy comparison, while on the rectangular kiln a chart having two sections, each showing the two records at one end of the kiln, is a convenient arrangement.

For temperatures not exceeding 1200° C. (2200° F). good base-metal couples, properly protected in high-grade porcelain tubes, have proved entirely adequate; for higher temperatures, platinum couples must be used. For the ranges where they are available, base-metal couples are preferable because of their greater ruggedness and low cost and because

they generate three times as much current as platinum at the same temperature, thus making possible the use of more rugged galvanometers in the recorders.

While the use of pyrometers for controlling the burning of clay ware ought to become universal, pyrometers plus fire will not burn good ware; fire suitably controlled by means of the information furnished by pyrometers will surely do the work. Pyrometers will unquestionably furnish most important information, which will be valuable just in proportion as it is studied and applied to the problem in hand. I am a firm believer in putting all of the information given by the pyrometer at the disposal of the burner. It is usually easy to locate the recorder where the burner can follow the record. A glance at the chart tells him not only the temperature at the moment but also the trend of temperature change in a way that no number of observations read from an indicator can do. When the records are made accessible to the burners, they will inevitably vie with one another in making the best possible chart.

Where waste heat from the kilns is used for drying the ware it is very desirable to record the temperature in the drying tunnels, especially if the clay is sensitive to drying conditions. Multiple-record recorders of the base-metal thermocouple type make it possible to obtain such records in compact form at a moderate outlay.

## DISCUSSION

FRANCIS T. OWENS,\* Watsonstown, Pa. (written discussion†).—In the second paragraph, Dr. Thwing mentions the various stages through which clay ware must pass but he does not analyze the third stage, oxidation, sufficiently. There are two elements to dispose of in a great many of the shales that must be burned; these elements are carbon and sulfur. Dr. Thwing speaks of the carbon, but intimates that it is safe to have a temperature of 800° C., which we find to be rather dangerous on a great many shales. With one shale that we handle, we cannot go above 535° C. until we have passed this particular stage. At 800° C. the sulfur will begin to pass off and it is very necessary that plenty of air be admitted at this time and a very even temperature maintained. I realize fully that this paper is not meant to be much more than a suggestion in the use of pyrometers in burning of clay wares, but lest some one be led astray, I call attention to the above results of our practice.

Our experience with cones is that if a cone is brought to a temperature near its fusion point and is then allowed to cool off 80° to 100° F., the cone will show an error of from 30° to 100° in its fusion point. We have not discovered just why this is, but have had this experience in two or three

\* Factory Manager, Fiske & Co., Inc.

† Received Sept. 18, 1919.

## 520 APPLICATION OF PYROMETRY TO THE CERAMIC INDUSTRIES

instances. For that reason, cones are not a sure guide and, while we use them, we would not think of attempting to burn a kiln without pyrometers.

Dr. Thwing speaks of the necessity for study of the information obtained when using pyrometers; this is one of the points that should be emphasized greatly. It is not enough to have records to look at, the heat records of each kiln should be traced on cross-section paper. A study of the records will soon show that no two kilns act in exactly the same way. Charts should be drawn of those burns showing the best results, then a composite chart should be made from these various charts; in this way a burning guide that will insure good results throughout the entire burning plant may be obtained.

The writer strongly advises the use of a recording pyrometer both at the hot end and the cold end of the dryer. We have found that where wares are difficult to dry, the trouble is due chiefly to conditions in the dryer that we were not aware of until we began to make records for the entire 24 hr. A recording mercury thermometer will do the work nicely in a dryer, but, as every one understands, is not adapted for kilns.

R. C. PURDY, Worcester, Mass.—The Norton Co. has 86 periodic kilns, hence considerable experience with pyrometry and other methods of control. Better regulation has been obtained since pyrometers have been installed for the control of every kiln. There are three central stations in which twelve-point and six-point recorders are placed. Before these pyrometers were installed, Seger pyrometric cones were the sole means of judging the rate of increase in temperature. There was no way of telling how the burning had progressed in the initial stages; there was nothing on which to base changes in procedure; and there was no control over the men who fired the kilns. The men were easily trained to follow a desired time-and-temperature curve. The firemen now plot on a small coordinate chart, independent of the automatic record in the recorder, on which chart is recorded all other data of the burn so that when the kiln is finished the entire record is on one sheet or chart. Besides this permanent complete record of each kiln firing, the pyrometers have proved very valuable in transferring the kiln control from the shop man, without records, to the laboratories, where complete records are used as a basis for instructions and rules.

It is important to control the time-temperature treatment of a kiln throughout the entire burn. Some of the kilns are 8 ft. in diameter, others 15, 18, and 20 ft., and each has its own rate of heat treatment and maximum temperature. All kilns are finished to the same Seger cone, but with cones exactly alike the temperature recorded will vary widely, dependent on size of the kiln. Fundamentally, the cause of differences in temperatures with the same cone indication is the difference in rate of heat treatment necessitated by difference in size of kiln.

A grinding wheel, to the uninitiated, appears as a rough looking thing in the burning of which almost any degree of heat treatment would suffice. As a matter of fact, our heat-treatment specifications are close. We must produce an exact grade of toughness or hardness, denoted by the penetration of a tool. We have learned by practice the time-temperature treatment that is best for each size of kiln, a knowledge we did not have before the installation of recording pyrometers.

The burning of ceramic ware is a heat-treatment proposition and is affected by both time and temperature. No clay ware is absolutely homogeneous. It is composed of sizable particles of different minerals. The size of particles, or the surface exposed by the fluxing mediums in the ceramic ware, determines the rate at which fusion will progress. Fusion of clay ware is a progressive reaction and generally that progress increases in rate as the temperature increases. It is the rate of fusion that determines the character of the ware. Pyrometry people often forget that. They seem to think it is sufficient if we have a measured temperature. We must have a time-temperature treatment for which the cones are absolutely necessary, as they are the only available means of control that positively measures the total effect of heat treatment. We finish the kilns by the cones, bringing the cones to the specified stage of deformation by holding the kiln at a specified maximum temperature. The burning is carried on at a specified time-temperature rate until a specified temperature is obtained. The kiln is then held at that temperature until the cones show that the kiln has had the desired heat treatment. Cones show by their deformation a given intensity of heat treatment which cannot be measured, even approximately, by a temperature recorder. The pyrometers are valuable tools when the data obtained from them are used with an understanding of their limitations in a given case. For ceramic ware, the Seger pyrometric cones are the best tools we have for determining when sufficient heat treatment has been given.

## Pyrometry in Rotary Portland Cement Kilns

BY LEO I. DANA,\* B. S., AND C. O. FAIRCHILD,† B. S., WASHINGTON, D. C.

(Chicago Meeting, September, 1919)

As a part of an investigation conducted by the Cement Section of the Bureau of Standards, at the plant of the Security Cement & Lime Co., Security, Md., the High-temperature Measurements Section was called upon to measure temperatures in a dry-process, coal-burning kiln. Although the measurements were made only under the conditions existing in one plant, the methods employed and the conclusions drawn apply, in a general way, to those existing in most plants. As far as we have been able to learn, no sufficiently thorough methods of making accurate pyrometric measurements in the sintering zone and in the rear end of rotary cement kilns have been described. It is believed that in this investigation, data were obtained that can serve as a foundation for further study of the problems of pyrometry in cement kilns.

### IMPORTANCE OF TEMPERATURE MEASUREMENTS IN ROTARY CEMENT KILNS

The manufacture of Portland cement is today fairly well standardized. The various steps in the manufacture have been developed to such an extent that the process is almost automatic. In spite of these strides the efficiency of utilization of heat in the kiln is very low and an undue proportion is wasted; for example, about 50 per cent. ordinarily goes up the stack. In order to prevent these losses, not only should means be provided to utilize the waste heat but instruments, such as pyrometers, should be installed to study and control the operation with the view of minimizing the losses. At the same time such control will produce a more uniform product. The saving in fuel that may be effected by the proper use of pyrometers would be much more than their cost. Where these pyrometers should be installed and what they can show are very briefly indicated in the following paragraphs and discussed in greater detail later.

The problem of temperature measurements in rotary cement kilns may be divided into two parts: Temperatures in the sintering zone and temperatures at the rear end of the kiln and in the stack. A knowledge

---

\* Assistant Physicist, U. S. Bureau of Standards.

† Associate Physicist, U. S. Bureau of Standards.

of the temperature in the clinkering zone can serve to indicate the uniformity with which the clinker is being-burned. Of greater importance, however, is the determination of the burning temperature, required by mixes of various chemical compositions.

Temperature measurements in the rear end of the kiln are useful as a general pyrometric control of kiln operation. Records of these temperatures can show whether the fuel is burning properly and record certain abnormalities of kiln operation such as the stopping of the kiln and the fuel, the occurrence of "rings," and the "flooding" of fuel. A pyrometer in the stack, in addition to following, in a general way, the temperature variations indicated by a couple in the rear end, can show the regularity of the draft and whether the temperature of the gases is proper for treater dust precipitators or waste-heat boilers.

The measurement of temperatures in the clinkering zone is the more difficult problem and has hitherto been seldom attempted; in order to measure these temperatures some form of optical or radiation pyrometer is necessary. To measure the temperatures in the rear end, however, is simpler and can be accomplished with base-metal thermocouples.

#### TEMPERATURES IN THE CLINKERING ZONE

*General Considerations.*—Investigations conducted by the Geophysical Laboratory, of Washington, have shown that with the proper proportions of lime, alumina, and silica of the highest purity, a temperature of 1650° C. for a sufficient length of time is required for the complete burning of a perfectly burned Portland cement. The resulting clinker consists of three compounds, dicalcium silicate, tricalcium silicate, and tricalcium aluminate, all of which are cementing constituents. Of the three, tricalcium silicate is the most active and important. At 1335° C., however, a flux, which is a molten eutectic, begins to form; this flux promotes the formation of the above-mentioned cementing constituents. As the temperature is raised above 1335° C., the amount of the three compounds increases, particularly the tricalcium silicate, until they are completely formed at 1650° C.

These statements hold for materials of the highest purity. In the case of commercial Portland cement, which, in addition to the lime, alumina, and silica, contains impurities such as the oxides of iron, magnesium, sodium, potassium, and sulfur, the temperature for complete burning has been found to be considerably lower than 1650° C.<sup>1</sup>

Temperature measurements for two days in the kiln investigated by this Bureau gave an average burning temperature of 1380° C. for a clinker of the following average composition.<sup>2</sup>

---

<sup>1</sup> G. A. Rankin: Portland Cement. *Jnl. Frank. Inst.* (1916) 181, 776.

<sup>2</sup> We are indebted to Mr. H. A. Bright of the Chemistry Division of this Bureau for the analysis.

|                                      | PER CENT. |
|--------------------------------------|-----------|
| CaO.....                             | 61.80     |
| Al <sub>2</sub> O <sub>3</sub> ..... | 6.67      |
| SiO <sub>2</sub> .....               | 23.64     |
| MgO.....                             | 3.00      |
| Fe <sub>2</sub> O <sub>3</sub> ..... | 3.01      |
| Alkalies.....                        | 1.33      |
| SO <sub>3</sub> .....                | 0.50      |
| Ignition loss.....                   | 0.05      |

Thus the total impurities amounted to about 7.9 per cent. Rankin states that a cement containing 6.7 per cent. impurities required a burning temperature of 1425° C. This means, in the case of the first-mentioned clinker, that the temperature at which the flux begins to form must be considerably lower than 1380° C., probably around 1100° C.; thus because of the presence of impurities, the burning temperatures of commercial raw mixes are considerably lower than those of materials of the highest purity. In addition, it has been shown that the same cementing compounds are formed in the commercial clinker in approximately the same proportions as occur in pure clinker, even though the commercial clinker has been burned at a considerably lower temperature. The burning temperature of a commercial Portland cement is widely varied by its composition; to what extent each impurity affects the burning temperature has not yet been determined.

*Possible Methods.*—In rotary cement kilns, there is a zone of high temperature beginning a few feet from the end at which the fuel is burned and extending for 10 to 20 ft. (3 to 6 m.) (the dimensions of a kiln being 125 by 8 ft.). The average temperature in this zone is supposed to be that necessary to sinter or burn the clinker. As a rule there undoubtedly is a small temperature gradient in this zone. The temperatures one may encounter in commercial practice range from about 1200° to 1500° C.

Two types of pyrometers can be used, thermoelectric and radiation or optical pyrometers. In the case of thermoelectric pyrometers, a long couple may be pushed in through a hole in the end of the kiln to the center of the burning zone. Such a couple would have to be made of platinum platinum-rhodium. To procure the required refractory protection tube about 15 ft. (4.5 m.) in length would be very difficult; besides, such a couple would measure the temperatures of the hot gases and not of the clinker. This method, therefore, is hardly feasible.

A method that has been suggested is the installation of a couple in a hole bored in the side of the kiln approximately at the center of the hot zone and flush with the surface of the lining. In addition to the problem of a proper protection tube for a rare-metal thermocouple and the mechanical difficulties of taking measurements on a rotating kiln, there is great uncertainty as to what temperature this couple would measure. It is well known that a coating of varying thickness builds up on the refractory

lining of the kiln and consequently there would be a variable temperature gradient from the surface of the coating to the hot junction of the thermocouple.

The only means that at present give promise of reasonable accuracy are the optical or radiation pyrometers. Of these the types most suitable are the Wanner and Morse optical pyrometers and the Fery and Thwing radiation pyrometers. The indication of the latter departs from the true temperatures more widely than does the indication of the former due to the high absorption of infra-red radiation by carbon dioxide and water vapor. The Holborn and Kurlbaum modification of the Morse optical pyrometer, in addition to allowing the observer to distinctly see the object sighted upon while measuring its temperature, is more reliable, more precise, and more rapid than the other types.<sup>3</sup>

The work of this Bureau has shown that accurate temperature measurements cannot be made with an optical pyrometer in a rotary kiln using coal as fuel, while the fuel is burning or while the kiln is rotating, for the following reasons: Powdered-coal (as well as oil) flames possess very great intrinsic brilliancy and by sighting through the flame on the lining of the kiln or on the clinker the apparent temperature of the flame is being measured. This apparent temperature is usually considerably higher than the true temperature of the clinker and is much the same under constant coal and air conditions irrespective of the temperature of the clinker. If one sights on the lining or on the clinker, but not through the flame, an error is introduced by the reflection of light from the brilliant flame. That is, in addition to light received from the hot lining or clinker, reflection from the latter of light from the brilliant flame occurs. Another source of error is caused by the cement dust resulting from the rotation of the kiln, the unburned coal dust, and the ash dust. This dust, in the line of sight, acts as an absorption screen and reduces the intensity of the light reaching the pyrometer. Errors arising from dust and flame are indeterminate and consequently make accurate temperature measurements impossible while the fuel is burning and the kiln is rotating.

*Procedure Recommended.*—We believe it to be necessary to stop the flame and the kiln in order to measure the temperature in the hot zone. It may also be found advisable to cut off the air supply to prevent the dust blown up by the air from interfering with the measurements. Because of the air currents blowing through the kiln and because of radiation, the kiln cools rapidly after cutting off the fuel supply. Since it may take from 5 to 15 sec. for the smoke to clear sufficiently to allow measurements to be taken and about 10 sec. after this to get the measurement, the temperature of the spot sighted upon will fall appreciably.\*

---

<sup>3</sup> This pyrometer is manufactured in this country by the Leeds & Northrup Co., Philadelphia, Pa.



Therefore, the temperature of the kiln cannot be estimated by a single measurement. By taking a series of temperature-time measurements, as rapidly as possible, the temperature of the kiln at the stopping of the flame can be estimated with a fair degree of accuracy by extrapolation of the temperature-time curve, as described in more detail below.

The proper spot to sight upon should be the hottest in the kiln, which, as a rule, will be found in the center of the sintering zone; this is about 8 to 10 ft. (2.4 to 3 m.) from the end of the kiln. The proper position of the sighting spot around the circumference may be determined by the following observations. After stopping kiln, coal, and air, the dust begins to clear and the clinker that had built up on the lower right-hand quadrant of the kiln (the direction of rotation being anti-clockwise facing the kiln) falls in slides for about 2 or 3 sec. About 10 sec. (an average value) after stopping the kiln the uppermost layer of clinker in the quadrant falls over, uncovering the lining. The thickness of the layer that falls over may vary from about 6 to 12 in. (15 to 30 cm.). In all the measurements, a spot on the lining that is uncovered by the falling of the clinker should be sighted upon with the optical pyrometer.

The alternative of sighting on the surface of the clinker should not be employed, for the following reasons. First, it has been found by experiment that the surface of the lining cools more slowly than the surface of the clinker, probably because the former is smoother and slightly less exposed than the latter. Second, the surface of the cooling clinker represents a mottled appearance, which makes matching of the pyrometer filament against this surface difficult. Third, the lining under the thick layer of clinker (the latter falling on the average 10 sec. after stopping the kiln) does not cool appreciably until the clinker does fall, for the only way it can cool is by conduction through the hot lining and bed of hot clinker—and this cooling is relatively slow. The surface of the clinker, on the other hand, starts to cool almost immediately after stopping the coal. Thus, as far as the cooling of the uncovered spot of the lining is concerned, the interval from the stopping of the kiln and the falling of the clinker layer is time gained in measuring the temperature; that is, during the interval most of the dust disappears and for this interval no extrapolation would be necessary. Extrapolated curves of readings taken on the surface of the clinker and on the surface of the lining show that the temperatures obtained by the two methods are in substantial agreement; but those readings taken on the lining are more reliable because the slower cooling of the lining and the interval between stopping the kiln and the falling of the clinker results in a smaller correction being necessary from the extrapolation of the temperature-time curve.

The pyrometer should be kept fixed in position. The direction in which it is sighted will depend on the position of the hole in the front-

end housing of the kiln and the distance of the center of the sintering zone from the end. The procedure in taking the measurements may be as follows: On signal, the burner throws off the belt feeding the coal and stops the kiln and air blast, practically simultaneously. At the instant of shutting off the coal, a stop watch is started. The observer notes the instant at which the heavy layer of clinker falls and the assistant records the time. As soon as possible after the clinker falls, the observer matches the pyrometer filament against the uncovered spot on the lining, sighting near the layer of clinker; the assistant records the time and the current through the lamp. Four or five such readings are made as rapidly as possible, the usual interval between each reading being about 10 sec. A signal is then given to the burner to start the kiln and the time of starting may be noted.

In the Bureau investigation, of sixty-three observations of the time the layer of the clinker fell after stopping the kiln, the mean value was 10 sec. with an average deviation of 3 sec. The average time of stopping the kiln for a reading, computed from 104 measurements was 1 min. and 20 sec. The kiln was stopped for a measurement every  $\frac{1}{2}$  hr., which it is believed is a satisfactory interval.

In the case of plants burning oil as fuel we believe the same considerations as outlined above should hold. In those burning gas, the flame is not so bright and does not emit so much light; at any rate, the kiln should be stopped because of the dust. Thus, probably the same procedure as in coal plants should be followed.

*Errors in Measurements.*—Even though the lining in the burning zone is heated fairly uniformly while the kiln rotates, there probably is a slight departure from black-body conditions due to rapid cooling after stopping the fuel supply. Nevertheless the emissivity of the surface of the lining and also of the clinker, is high; the error due to departure from black-body conditions perhaps does not amount to more than  $10^{\circ}$  C. Thus, while the absolute values of the temperature readings may all be  $10^{\circ}$  C. too low, this departure is very probably the same for all readings, and the comparison of the readings, which is the most important object, is not affected by this source of error.

The smallest increment of temperature that can easily be measured with the Leeds & Northrup optical pyrometer in its industrial form is about  $4^{\circ}$  C. The calibration of the pyrometer, with reference to a standard optical pyrometer, may generally be relied upon to remain good to  $\pm 10^{\circ}$  C. Including the possible error due to departure from black-body conditions, it is believed that the temperature measurements, considering only pyrometry errors, may be estimated good to  $\pm 20^{\circ}$  C.

The fact that the temperature-versus-time curve is extrapolated to estimate the temperature of the kiln is not regarded as introducing any uncertainty into the measurement, but rather to make it more reliable

than any single measurement. On account of the rapidity with which the matching must be made, a single measurement might be in error because of incorrect matching. These errors are partly eliminated by drawing the temperature-time curve through the points. Nevertheless, occasionally it is impossible to see the clinker fall because of dust; in such cases the average value for the time of fall of the clinker counted from the instant of stopping the coal and kiln, may be assumed and the curve extrapolated for this average time. In these instances, as well as in others where the points do not fall very well on a straight line, the error is greater. As a rule the temperature-time points follow very closely a straight line, thus making the extrapolation easy and precise, see Fig. 1.

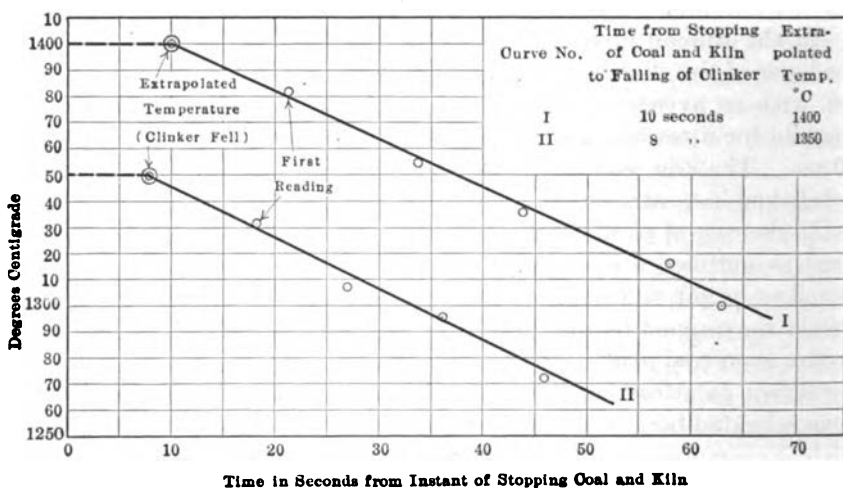

FIG. 1.—TYPICAL EXTRAPOLATION PLOTS OF TEMPERATURE READINGS.

Since in the investigation made by the Bureau the average time from the fall of the clinker from the lining to the first reading was 13 sec. and the average rate of cooling of the lining was 2° C. per second, the average value of the correction resulting from extrapolation was 26° C.

It is a peculiarity of kiln operation that the sintering zone fluctuates back and forth for several feet. One of the functions of the burner is to keep this zone the proper length and in the proper position by control of the kiln speed, the rate of addition of the raw feed—these two factors are coupled and controlled together—and the coal and air supply. Since the pyrometer is kept fixed in alignment, it may be that the maximum temperature is not always being measured. It is not ordinarily possible to observe the extent of these small fluctuations. At times, however, the sintering zone can be observed to be flagrantly out of position, in which case the temperature readings should indicate that such a condition exists.

*Significance of Measurements.*—The extent to which the cementing constituents in the burning of a Portland cement clinker are formed depends principally on two factors: the temperature of burning and the time of burning. In actual operation of the kiln, the burner judges the proper degree of burning by the appearance of the clinker in the kiln and as it leaves the kiln. To say the least, this is a very imperfect method. He controls the degree of burning by varying, first, the speed of the kiln together with the amount of raw feed and, second, the amount of coal. By the former operation, the time of burning is controlled; and by the latter, the temperature of burning is controlled. Within certain limits, it is possible to burn a clinker, on the one hand, for a short time at a high temperature and, on the other, for a longer time at a lower temperature and still produce the same degree of burning. Since, in practice, both the time and temperature are varied to some extent and since ordinarily only the burning temperature can be measured, it is evident that the temperature measurements cannot properly be compared and correlated unless the time of burning is approximately the same. Although the speed of the kiln can be measured, other factors that enter into the time of burning cannot be estimated; these are the length of the sintering zone and the inside diameter of the kiln, both of which vary from time to time. With normal operation of the kiln, it is believed that the times of burning are not sufficiently divergent to vitiate comparison of the burning temperatures.

Several conditions occasionally arise, however, which produce abnormal operation of the kiln and, accordingly, the temperature readings taken during these intervals should not be considered as taken with the normal time of burning. Some of these conditions are:

1. When the partly calcined raw material builds up around the circumference just before the sintering zone and restricts the opening of the kiln at this point, the distribution of temperature along the kiln changes considerably. The ring formed in such a case tends to cut down the draft making the front part of the kiln hotter than normal. In addition, the sintering zone appears to be shorter than normal and closer to the front of the kiln. Thus, whenever a ring forms in the kiln, the clinker is probably burned at a higher temperature for a shorter time or may even be overburned.

2. Sometimes an excess of raw feed enters the kiln. This large amount of the material abstracts considerable heat from the sintering zone, tending to lower its temperature. When this condition goes too far it is necessary to slow down the kiln, or even to stop it, in order that the large mass of material may be burned to the proper degree.

3. Excess of coal, or "flooding" of coal, causes a lowering in temperature of the sintering zone. Such a large amount of powdered coal may come through that very little will burn, owing to the limited amount of air.

The excess of coal absorbs a large quantity of heat and cools the hot zone. At the same time, some of the coal burns all along the kiln, and the rear end becomes hotter.

*Conclusions from Measurements.*—Emphasis should be placed on the fact that a single measurement of the burning temperature has little meaning; for a gross accidental error may have occurred in the measurement; or, for some reason, the kiln may not have been operating normally. Consequently conclusions from the data can only be drawn when a succession of temperatures over a sufficient length of time have been taken. For this purpose, readings should be taken through 8 or 10 hr. of each day and for several days. A very vital correlation is one between the chemical compositions of the raw mix and clinker and the burning temperatures. It may not be amiss to point out the factors and conditions that may exist to make this correlation uncertain.

1. In the first place, there are the abnormal conditions of kiln operation, mentioned before, under which temperatures are not being measured properly.

2. The factors of time and temperature of burning, as well as the chemical composition of mix and clinker, control the extent of formation of the cementing constituents in the clinker. The question of variation in time of burning has been discussed previously. A cement of the same composition may be burned over a considerable range of temperature and for the same time and still produce a cement passing specifications. That is, the part burned at the higher temperatures will contain a greater proportion of cementing constituents. Thus a petrographic examination of the clinker would be necessary in order to judge this factor. To properly compare burning temperatures with chemical composition, it is necessary to assume that equilibrium has been attained; that is, that the maximum amount of cementing constituents possible has been formed or that about the same proportion of the theoretical quantity has been formed in each burn.

3. Several other external factors of more or less indeterminate effect enter into making the chemical composition uncertain. (a) It is known that part of the fine coal ash blowing through the kiln enters into combination with the raw mix or partly burned mix. Since the quantity and composition of the coal may vary from time to time, this effect may not be constant. (b) Part of the coating on the kiln lining falls off occasionally into the partly burned mix or the clinker. This coating is composed of material from previous mixes and its admixture possibly can change the composition of the mix very appreciably. (c) Two raw mixes may have identical chemical compositions but require different burning temperatures for the reason that the raw mix materials are in different physical or chemical conditions. For example, a mix in which treater dust is added may have the same chemical composition as one in which none is

added; but the treater dust mix would no doubt require a different burning temperature because that part of the mix represented by the treater dust had been burned previously.

In case the temperature readings are fairly constant, say within 50° C., we believe it is proper to average the readings. Such a mean, however, is not considered as having much significance when the temperature rises or falls considerably during the day. In the latter cases, the range of temperature covered by the best representative line drawn through the separate readings may be found. This process is justified and is probably of value when only a few chemical analyses of the raw mix or clinker, composed of a number of samples taken during a period of several hours, are made.

When correlating the burning temperature with the chemical composition of the raw mix, one should not forget to take account of the time of travel of the mix from the feed end to the clinkering zone at the point where the temperature is measured.

The measurement of the temperature in the clinkering zone is not an easy and convenient matter; to do it properly requires considerable practice, two persons, and the assistance of the burner. In addition, the kiln must be stopped for about 1½ min. for each temperature measurement. However, the loss of production entailed is very slight. The measurement of temperature in the clinkering zone is not to be recommended for a continuous pyrometric control of a kiln, but rather as a special aid to be used at intervals in the study of the relation between the chemical composition of the raw mix and clinker with the burning temperature, and in the introduction and investigation of any new factors that may have an appreciable effect on the burning temperature.

#### TEMPERATURES AT REAR END OF KILN AND IN STACK

There probably are considerably greater differences in the various cement plants in the temperatures of the rear end and stack gases than there are in the temperatures in the sintering zone. The reason for this is that the rear end and stack temperatures depend, to a large extent, on the construction of the rear-end housing and stack and on the process while the temperature in the burning zone is governed principally by the mix. Kiln construction and the process differ widely in various plants, while the composition of the mix must lie within definite limits. Consequently, in the following discussion we shall have to refer in more detail to the conditions that existed in the kiln investigated by this Bureau, and the statements cannot be as general as in the discussion of the temperatures of the clinkering zone.

*Rear-end Temperatures.*—The average temperature of the gases leaving the end of the kiln experimented on was about 650° C. Occasion-

ally the temperature rose as high as 800° C. and fell as low as 500° C. The temperature of the couple fluctuated as much as 10° or 15° C. in 5 min. The atmosphere at the rear end was extremely dusty, containing the alkaline cement dust, and was sometimes slightly reducing or slightly oxidizing.

The hot junction of the thermocouple was placed near the axis of the kiln about 1 ft. in from the plane of the rear end. As far as the position of introduction and the length of the couple are concerned, these depend on the construction of the rear-end housing of the kiln. It was found possible to place a 7-ft. couple through a hole in the top of the stack base so that the hot junction would be in the correct position.

One of the difficulties that occurs with the rear-end couple is the building up of cement dust on the pyrometer protection tube. This dust cakes to such an extent that a large mass of dust may form around the hot junction, introducing a large time lag in the indications and even swamping out short-period variations in temperature of the surrounding gases. If the couple is placed too near the feed pipe, a bridge of caked dust may form between the pipe and couple making the effect worse. To prevent this, every part of the couple should be placed at least 2 ft. from any part of the caked feed pipe. It may be necessary to bend the couple in order to do this. At present the only way that appears feasible to prevent the caked dust from affecting the temperature readings materially is to remove this dust periodically; at least once every 12 hr. Perhaps as simple a way as any is to have the couple protection tube rest in a sleeve which extends from the head of the couple to about half way down the tube and which fits the tube rather closely. Each time the tube is to be cleaned, it is pulled up through this sleeve and the accumulated dust is shaved off.

The choice of the proper material for the protecting tube of the thermocouple is another source of difficulty. It has been demonstrated that iron tubes will not last long in the atmosphere existing in the end of a dry-process kiln because they are oxidized and rapidly attacked by the dust. A porcelain, clay, or other such refractory tube would also be attacked. Probably the best tube that can be obtained at present is one of nichrome or chromel of fairly thin walls. In wet-process plants where the temperature at the rear is considerably lower and the atmosphere less dusty than in dry process plants, it is probable that little trouble would be experienced from the corrosion of protecting tubes and the caking of dust. A base-metal thermocouple of iron-constantan or chromel-alumel is satisfactory. The chromel-alumel couple will have a longer life and can withstand a higher temperature but is slightly more costly.

To record the temperature of the couple any one of the galvanometric thermocouple recorders on the market may be used. Since most of these

recorders are not as dustproof as they should be for use in a cement plant, they should be mounted in a dust proof cabinet. Information concerning thermocouple and recorder installations is given elsewhere.<sup>4</sup>

The installation of pyrometers in the rear end of rotary kilns has not been common in cement-mill practice. Because they can serve a useful purpose, we believe that they should be employed more frequently. In plants that do not attempt to save some of the heat carried away in the gases leaving the kiln, records of temperatures at the rear end should indicate how to reduce this loss to a minimum by correlating the changes in temperatures with the length of flame, the draft through the kiln, and other factors. In plants where the waste gases are utilized to heat boilers, a pyrometer at the rear end, as well as one at the waste-gas entrance and exit of the boiler, will show, in addition to the above-mentioned correlations, the optimum temperature of the gases, and will give a record of the attainment of this condition. Although there are other means of recording the time of stopping of a kiln (the supply of fuel is usually stopped when the kiln stops), a pyrometer in the rear end by recording the temperature of the gas will more nearly approximate the true time the kiln was ineffective in production. As stated before, the temperature at the rear end is abnormally low when a ring occurs in the kiln; as a rule one should be able to tell from the records the duration of a ring. Again, when there is a large excess of fuel the temperature at the rear is abnormally high. It appears, from data obtained, that when the kiln is operating normally, the rise and fall of the maximum temperature in the clinkering zone is followed by a similar change in temperature of the rear-end couple greatly diminished in magnitude.

*Stack Temperatures.*—The stack temperatures encountered in the kiln investigated averaged about 250° C.; they ranged from about 200° to 300° C. The gases after passing out the rear end of the kiln were purposely cooled by the admixture of air entering the stack base from the outside. The atmosphere was considerably less dusty than at the rear end; and because the dust was at so low a temperature it was not corrosive and did not cake to the extent it did in the end of the kiln.

The couple was placed in the stack about 15 ft. from the floor of the stack base. This couple should be a sufficient distance up the stack to measure the temperature of the well-mixed gases in case air is admitted below.

If the temperatures are as low as indicated, the installation may be similar to the rear-end couple but much simplified because there should be no trouble from errors in measurements due to caking of dust on the pyrometer tube and no corrosion of an iron protecting tube. An iron-constantan couple should be very satisfactory for these low temperatures.

---

<sup>4</sup> Thermoelectric Pyrometry, by Foote, Harrison, and Fairchild. Recording Pyrometry, by Fairchild and Foote. This volume.



On the other hand, if the temperatures are considerably higher, for example above 500° C., the same precautions will probably have to be taken as with rear-end couples.

If air is mixed with the gases leaving the end of the kiln and the temperature, humidity, and quantity of this air are constant, the indications of the stack couple should correspond in direction of variation to those of the rear-end couple. Usually, however, the air conditions are not constant, and the couples will not correspond.

With less exactness than the rear-end couple, the records of the stack pyrometer will also indicate the stopping of the kiln, the formation of a ring in the kiln, and flooding of fuel. In case the waste gases pass through dust precipitators, the stack couple should show whether the temperature of the gases is proper for the precipitators.

This discussion of the application of pyrometric methods to the operation and control of cement kilns, while far from complete, will possibly serve to indicate some of the advantages and possibilities of such methods. We are indebted to Mr. J. C. Pearson, of the Cement Section of this Bureau, for affording us the opportunity of undertaking this investigation.

## Application of Pyrometers to the Ceramic Industry

BY JOHN P. GOEHN,\* PHILADELPHIA, PA.

(Chicago Meeting, September, 1919.)

RECENTLY the head burner at a brick plant with over 40 years' experience said that he had burned brick by guess for over half his lifetime and had used pyrometers for  $2\frac{1}{2}$  years but hoped that he would never have to burn kilns without pyrometers again. The ceramic engineer in making a special study of the burning of clay ware and the effect the heat of the kiln has on color and vitrification is also rapidly placing the burning of clay on a twentieth-century basis.

Clay ware may be divided into various groups, brick and drain tile; sewer pipe; firebrick; and pottery, which, in turn may be subdivided into special classes. As nearly as the analysis of the clay type of kiln, etc., will allow, there are practically the same problems to solve in burning in all of the processes or operations. The underlying objective is the same, namely, the production of the best grade of ware under the most efficient and economical manufacturing system.

The principal problem in the production of clay ware is the burning off of the kilns. The most modern steam shovel may dig the clay and the most advanced types of pug mills and wire cut machines or molds of various kinds may be installed, but unless the drying and burning of the ware is successful, all of the previous operations will be useless. On this final operation depends the entire result of the plant.

In reality, burning of all clay ware is purely a heating proposition. The kilns, or furnaces, should be so designed as to give equal distribution of heat. Consequently, the problems of design and construction of kilns to produce equal distribution of heat require serious consideration, as do also the questions of heat control and draft control. The three most important factors in the burning of practically all types of kilns may be summarized as follows: The installation of dependable pyrometers by which the temperature can be accurately measured; the draft gage to show just how much air or draft should be allowed to come in over the grate bars to effect good combustion and to allow the rate of heating to be controlled by adjustment of the dampers; the construction of the kiln; since it is the container of heat, it must be built according to modern principles. These three primary factors are here considered with reference to the burning of the ware and the resultant economical advantages.

---

\* Secretary, The Brown Instrument Co.

### PYROMETER INSTALLATION

The first requisite for efficient burning is a pyrometer. The equipment to best meet the condition of each particular plant should be carefully selected in order to secure the greatest returns from the investment. The purchaser who buys on a price basis alone is not doing justice to his business experience. The equipment that will be most suitable for all plants should consist of a thermocouple in each kiln, a high-resistance indicating pyrometer for the use of the burner, and a recording pyrometer to be used as a check to prove whether or not the burning has been carried out as directed; also rotary-type and plug-type switches to permit any thermocouple to be connected to indicating and recording instruments.

*Thermocouples.*—While, in general, the equipment outlined is suitable for all plants, particular attention should be given to the selection of the thermocouples. There have been developed within the past 2 to 3 years a number of types of thermocouples composed of base-metal alloys. These alloys are somewhat limited in their application on account of the rapid oxidation of the elements under high temperature, and, therefore, should only be used under favorable circumstances. The most satisfactory thermocouple is composed of pure platinum wire on one side, and on the other side a wire composed of 90 per cent. platinum and 10 per cent. rhodium. The melting point of the wire in the couple is over 3150° F. (1732° C.) so that it may be used in nearly all kilns. Protecting tubes composed of a very dense and highly glazed porcelain are used to protect the platinum wire from attack and contamination of the gases of combustion. These tubes are in turn protected by outside tubes of "corundite" fireclay. This thermocouple should be used in nearly all applications, particularly when the temperature will exceed 2000° F. (1093° C.). Some plants use base-metal thermocouples for kilns burning sewer pipe and firebrick, which require temperatures frequently in excess of the melting point of the base-metal elements.

Should the conditions warrant, a base-metal thermocouple composed of a nickel-chromium alloy, with a melting point of 2600° F. (1427° C.), may be used. In order to protect this couple from oxidation, porcelain tubes must be used and preferably another outer tube of fireclay to protect the porcelain tube from injury.

*Indicating and Recording Instruments.*—The indicating and recording instruments should be built up with an internal resistance of at least 600 ohms, in order to overcome the change in lead wire resistance either due to the use of different length of leads or temperature changes along the leads. The possible source of error is proportionate to the resistance of the meter to the ratio of increased resistance of lead wire or thermocouple over the normal external resistance of the circuit. Accordingly instru-



a

b

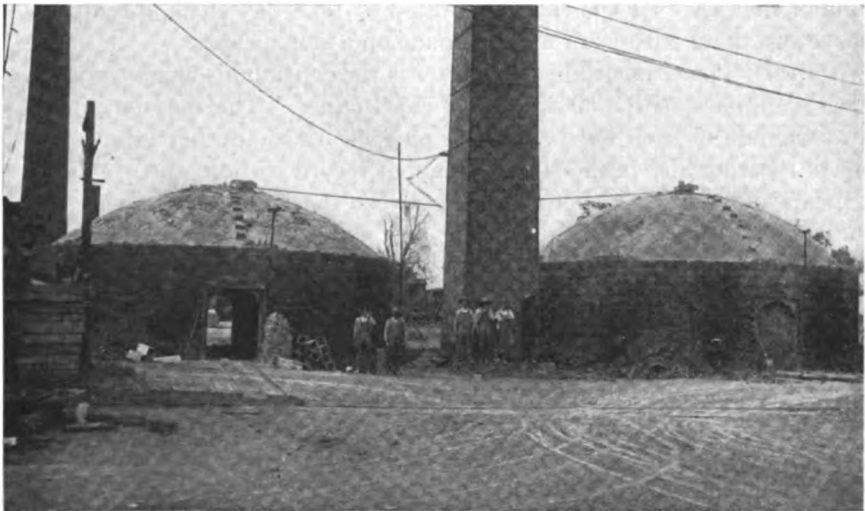

c

FIG. 1.—a, RECORDING INSTRUMENT IN OFFICE; b, INDICATING INSTRUMENT FOR BURNER; c, GROUP OF KILNS.

ments of a lower resistance than 600 ohms only minimize the error. This can readily be shown by the following example: Assume that a pyrometer reads accurately when using 50 ft. (15 m.) of No. 12 gage single-conductor copper wire. If 500 ft. of this wire is added, as the resistance per foot is 0.00159 ohm, for 500 ft. this resistance will be 0.795 ohm. If a 5-ohm instrument is used, the error produced by this wire is its resistance 0.795 ohms divided by the resistance of the instrument, or 5 ohms, which equals 15.9 per cent.; or at 1500° F. (816° C.), an error of 238.5° F. (132.5° C.). If a 500-ohm instrument is used, the error will be the resistance of the wiring, 0.795 ohm, divided by the resistance of the instrument, 600 ohms, which equals 0.13 per cent., or at 1500° F. an error of 2° F. This error is so small that it would be impossible to read on the scale of a pyrometer graduated to 2000° F. or 3000° F.

It can be readily understood that only the most improved form of construction will embody these advantages. The recording pyrometer should also be of similar high-resistance construction and of a simplified design. It is best to use an individual-chart instrument for each kiln under fire so that when filed the charts can easily be referred to. A recorder producing more than one record is more complicated; and as the various kilns are brought up to heat and burned off, it is difficult to decide just when to tear off the chart. In Fig. 1 is shown the indicating pyrometer and switchboard for use of the burner and also a circular-chart high-resistance recording pyrometer with rotary type switch so that any kiln may be connected with the recorder as placed under fire. Additional recorders may be used if desired. The chart is produced by means of a circular carbon-paper disk which revolves with the chart. This eliminates the use of ink in any form and the consequent cleaning and filling of the pen. As the chart is rotated by an 8-day clock, a temperature record of an entire run may be made on a single chart.

Another type of recording pyrometer is the continuous-chart recorder, which is supplied with a 60-day roll of chart paper. This may be clipped off at the end of each burn and then plugged on to another kiln. This type of recorder also produces a permanent record without the use of ink by means of a carbon ribbon passing between the chart and the recording arm.

*Installation of Pyrometers.*—In the installation of pyrometer equipment on kilns, extreme care should be taken to follow the best practice. The thermocouples should extend about 3 in. (7 cm.) inside the kiln crown so that the temperature recorded should be as close to the true temperature as possible and not seriously affected by heat radiation from the kiln walls. At some plants, an effort was made to protect the thermocouple by placing it so that it did not extend through the crown inside the kiln. Naturally the temperature was seriously affected by the heat radiation and heat absorption of the brick composing the

crown, and dependable results could hardly be expected. Moisture-proof caps should be provided for the couples, so that rain or dust cannot seep down the porcelain or firebrick tubes. The wire should be supported by staybolts at proper intervals so that undue stresses will not be placed on the thermocouple.

In general, the results that may be expected by the installation of pyrometers are as follows: (1) Securing proper temperature of kiln from which the best temperature curve may be plotted and used for burning all similar clays. (2) Efficient operation of the kilns by the burner, who has definite temperature curves to designate the condition of the kiln at various periods of the burn. (3) Elimination of uneven firing, thus enabling the burner to bring the kilns up to heat without any set-backs. (4) Saving of fuel, by shortening the time of burn due to more even rate of firing. (5) Making more rapid turnover of plant capacity due to shorter time of burning. (6) Producing actual records of the proper burning conditions so that the management will have access to this information at any time. (7) Providing valuable data for the ceramic engineer, in analyzing the clay and the relation that certain temperatures have on shades and quality. (8) Eliminating careless firing of the kilns, especially during the night shift when the firemen are inclined to shirk their work, as the records would show their negligence. Statistics show that approximately 75 per cent. more fuel is used in bringing up a kiln with 30,000 or 50,000 brick that has been allowed to drop back 150° F. than if the set-back had not occurred.

#### DRAFT EFFECTS IN KILN BURNING

The second requisite for good kiln control is the use of proper draft conditions. It is almost impossible to secure good temperature control of the kiln without knowing the amount of draft and the change in draft conditions. A very simple form of draft gage is shown in Fig. 2. This consists of an inclined glass tube with oil and spirit line level. The gage is graduated in hundredths of inches and may be attached permanently to each kiln stack or used portably by mounting on a tripod or stand. The effects of changes in draft in the control of the kiln are very important, but apparently receive little attention. When there is a strong draft, the kiln will burn faster and the dampers in the stacks should be adjusted accordingly.

#### KILN CONSTRUCTION

Apparently every burner and superintendent has original ideas concerning kiln construction, which they have carried out at the various plants so that there are almost as many different types of kiln construc-

tion as there are plants. One of the most common mistakes is to build a kiln without giving proper attention to the flue capacity. As a result the burner is unable to bring his heat down to the bottom and only the upper courses will be burnt to color, proper degree of hardness, or complete vitrification, depending on which of these is desired. Kilns with proper flue regulation to support the pyrometric control should have a uniform burn from the third course upward, if used to advantage. Flues should be arranged so that the draft can be easily regulated by the burner; hot spots or cold spots are entirely unnecessary. By closing or opening the dampers, quick changes in draft should be secured which in turn is shown by the information given by the pyrometer readings.

While there are innumerable types of kilns a few seem to have proved their worth and, accordingly, have become practically the standard of their type. The installation of the pyrometer equipment depends considerably on the general scheme of burning.

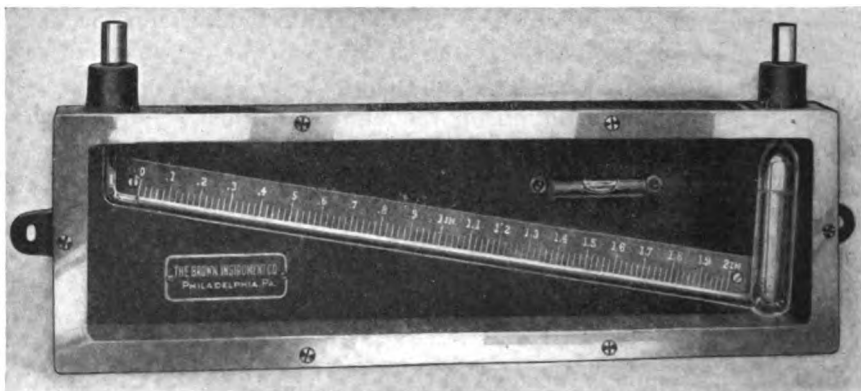

FIG. 2.—DRAFT GAGE 0 TO 2" OF WATER.

The old-fashioned scove kiln can be eliminated entirely, as this has no practical manner of control and depends entirely on natural draft. The round down-draft kiln is very largely used for burning brick, drain tile, and sewer pipe, and is known as a periodic kiln. The thermocouple is placed in the top of the kiln near the apex. The heat from the fire boxes passes to the top and is then drawn down through the brick, which are piled in courses with about 1 in. (2.5 cm.) space between each brick. The necessity for good draft conditions can readily be understood as the heat must be drawn down through the brick and out through the flues in the bottom of the kiln to the stack. In Fig. 1 is shown a plant with its pyrometer equipment controlling the burning of the round down-draft kilns. The indicating and recording instruments are very similar for all kilns but the application of the thermocouple to the kilns differs with the construction of the kilns.

In installing a pyrometer equipment on the periodic kiln, the thermocouple is usually installed about 3 in. inside the kiln and about 3 ft. from the apex. The couple is then in the hottest part and registers the highest temperature. This is a very important point in connection with the use of pyrometers for kiln burning. The temperature readings give the burner a working temperature with the highest temperature as the guide. Thermocouples installed through the side of the kiln may be more affected by local changes in draft conditions. More than one thermocouple for the average size of round kiln has proved unnecessary, though some plants have attempted to use them for determining bottom temperatures. As it requires an extremely long thermocouple to penetrate sufficiently far toward the center of the kiln, this extra thermocouple has not proved very popular. Also, with good conditions for controlling the draft, the burner can soon learn how to bring the heat at the top of the kiln down to the lower courses while he holds the top steady. Such good control has been secured at some plants that the temperature records show where kilns have been held for periods as long as 48 hr. without showing a rise or drop in temperature exceeding 25° F. while the heat was being pulled down and allowed to soak through the lower part of the kiln. It is in this distribution of the heat uniformly all through the kiln that pyrometers have proved so useful.

Pottery kilns are somewhat more difficult to handle from the viewpoint of an installation of pyrometers, due to their construction, which requires the thermocouple to be frequently installed first through the outside wall and then through the bag wall into the kiln chamber. The length of couple necessary and the peculiar draft conditions in the bottle-shaped kilns have not encouraged many pyrometer installations at these plants, but the urgent need of pyrometric control is recognized. An elaborate system of shrinkage scales has been devised at some plants, where tests are taken from the kiln and measured for their shrinkage on a shrinkage scale.

In addition to the periodic kilns there are continuous kilns, which by a process of rotation keep certain parts or chambers under fire at all times. The surplus heat from the chamber under fire is used to heat up other chambers and accordingly save a great quantity of fuel. Some of these kilns have as many as 60 to 90 chambers of 40,000 brick capacity. A number of ingenious methods have been adopted to carry the heat from one chamber to another. Some types of kilns carry the heat through flues while one kiln of the Haigh continuous type uses a paper curtain, which burns away when the kiln has reached a certain temperature and automatically connects the next chamber to the one being burned. The fuel used is generally producer gas; it is then only necessary to light the burner of the new chamber at the proper time and advance the



542      APPLICATION OF PYROMETERS TO CERAMIC INDUSTRY

burning of the various chambers in rapid succession. The remaining chambers are meanwhile cooling off or are being loaded or unloaded.

If possible to stress the importance of pyrometer control of continuous kilns over periodic kilns, it would seem that when more than one chamber is intimately connected with the hot zone the advantage of a pyrometer is greatly enhanced. By proper regulation of the temperature in the hot chamber, the rate of heating of the two or three chambers in advance is affected proportionately. The thermocouples, whether of rare metal or a nickel-chromium alloy, are installed through the crown. Usually the crown of a continuous kiln is very thick to prevent heat waste so the thermocouples are about 30 to 36 in. (76 to 91 cm.) long and penetrate about 3 in. inside the chamber. As the kilns often have as many as 90 chambers, the pyrometer installation should be carefully installed with the wiring out of the way. Usually the kilns are covered with a shed so that the wires may be carried overhead.

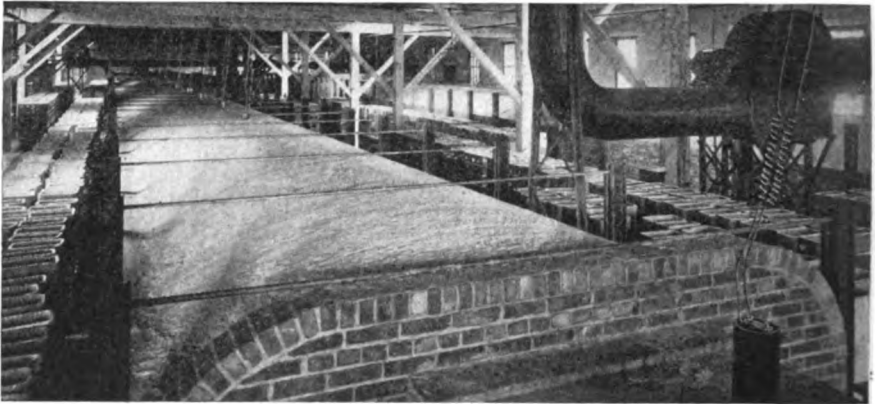

FIG. 3.—AMERICAN DRESSLER TUNNEL KILN.

Another kiln of interest, namely the American Dressler tunnel kiln, is a continuous kiln in which the floor of the kiln moves along at a certain rate and the material is passed through a hot zone. Platinum-rhodium thermocouples are located in the hot zone while nickel-chromium thermocouples are placed at intervals of about 20 ft. down the kiln. After the ware is loaded on the movable floor it is not touched until ready to be unloaded at the other end. Again the degree of success is dependent on good kiln operation and the pyrometer is of very great importance in establishing proper temperatures. Fig. 3 shows this type of continuous kiln with the thermocouples located along the top. Indicating and recording instruments are placed in the office of the head burner where complete data of the temperatures are kept. It might be of interest to note that this kiln has also been placed in service at steel plants for the annealing and heat treatment of various grades of steels.

### DRYING CLAY WARE

Another important temperature problem in clay-working plants is the proper drying of the ware. Much improvement has been brought about in equipment for this work. The waste heat from the kilns is largely used to heat the dryers, so it is necessary to control the amount of heat allowed to reach the dryer. A recording thermometer has become instrumental in aiding in proper dryer regulation. In construction, the equipment consists of a bulb filled with a nitrogen gas under pressure. This pressure is carried, by means of capillary tubing protected with bronze flexible armor, to a helix to which the recording arm is attached. A 24-hr. record chart is supplied so that an actual temperature record is produced of the temperature in the dryer. By properly drying the clay ware, the very start of trouble in burning can be greatly eliminated.

### CONCLUSIONS

Almost any plant can show the results of poor burning either from carelessness or "hard luck" with that particular kiln. Almost all plants will show the result of good burning and it is to increase the percentage of good burns that pyrometers have been so widely recognized as a real essential for the up-to-date plant management. Other checks on the kiln must not be overlooked, such as "tests" and cones. Cones show the relative kiln condition but have little to do with the temperature of the kiln. It is their function to tell whether a certain condition of the kiln has been reached, but their limit of usefulness practically stops there. Pyrometers, however, serve as a continuous guide for the burning of the kilns from the start until the kiln is finally burned off.

It is due to the persistent demand by the ceramic engineer and up-to-date manager that this somewhat severe condition for the application of pyrometers has been solved. It is for the future to decide whether pyrometric control will be carried to the extent where the burner sets the pyrometer and by means of automatic control the pyrometer will control the heating of the kiln by a certain gradual increase. The automatic control of temperature has already been solved for the control of metallurgical furnaces, and its applications for gas-fired kilns is not beyond the impossible. Comparatively much bigger things may be expected through the future development of pyrometers for the ceramic industry.

### Pyrometry in Blast-furnace Work\*

BY P. H. ROYSTER† AND T. L. JOSEPH,‡ WASHINGTON, D. C

(Chicago Meeting, September, 1919)

FOR a number of years the Bureau of Mines has been investigating certain problems relating to the blast furnace. In the course of these investigations it was desirable to measure, with the optical pyrometer, the temperatures occurring in the hearth of the furnace. Since no systematic measurements of these temperatures have been published a statement of the results may be of interest. The data given in this paper were obtained at thirty-two blast furnaces operated by seventeen companies; twenty of these furnaces were making iron, eight ferromanganese, and five spiegeleisen. The collection of this information was made possible by the coöperation of the American Manganese Co., Bethlehem Steel Corpn., Brier Hill Steel Co., Buffalo Union Furnace Co., Clinton Iron & Steel Co., Donner Steel Co., John B. Guernsey & Co., Jones & Laughlin Steel Co., E. E. Marshall, the McKinney Steel Co., National Tube Co., New Jersey Zinc Co., Republic Iron & Steel Co., Seaboard Steel & Manganese Corpn., Southeastern Iron Corpn., the Youngstown Sheet & Tube Co., and the Wharton Steel Co.

#### TEMPERATURE OF BLAST-FURNACE HEARTH

The blast furnace was, by long odds, the earliest piece of industrial apparatus operating at what it is now the fashion to call high temperatures, *i.e.*, above 1400° C. (2552° F.). It is a furnace, moreover, whose operation is believed to be extremely susceptible to small changes in hearth temperature. Since these temperatures have not been measured by the majority of the men who have originated or accepted this theory of the importance of hearth temperature, it is perhaps permissible to wonder just how this theory came to receive such universal acceptance. The men operating blast furnaces did not—in fact could not, if the theory

---

\* Published by permission of the Director of the U. S. Bureau of Mines. Report of research under the joint auspices of the U. S. Bureau of Mines and the National Research Council.

† Assistant Physicist, U. S. Bureau of Mines.

‡ Assistant Metallurgical Chemist, U. S. Bureau of Mines.

is correct—wait for the invention of pyrometric instruments to supply the means of temperature control. Just as they invented the theory that hearth temperature should play an important part in furnace control, they also invented a method of measuring that temperature. It would be difficult to assign a date to the origin of this pyrometric theory. Blast-furnace legend, in fact, may claim for itself the invention of the first high-temperature pyrometer; that is, if other conditions are the same, high silicon and low sulfur in the metal indicate a high hearth temperature and a drop in silicon while a rise in sulfur, not attributable to other causes, indicates a fall in hearth temperature.

This has never been shown to be true, of course. Moreover, it is difficult to get such a statement from many furnacemen who believe in and act on it. Nevertheless, the most readily apparent phenomenon in blast-furnace practice is the implicit faith of the furnace operator in the theory and the confidence with which he changes his burden or his blast temperature, or puts on extra coke in answer to the chemist's report on the last cast. A chemist's report on the last cast means silicon and sulfur. A cloud of uncertainty often hangs over much that goes into and comes out of a blast furnace. Complete analyses of slag are not often made and gas analyses are almost rare, but the writers are not aware of any furnace now operating at which silicon and sulfur is not run on each cast, reported immediately, scrutinized carefully, and discussed earnestly. The furnace operator has found this theorem so satisfactory a guide to furnace operation that he has had no cause to worry over his inability to set down his knowledge of the temperature of his hearth in terms of such and so many degrees centigrade on the gas-thermometer scale. It is easy to understand, therefore, why no attempt at pyrometric control has been made, although instruments able to measure the temperatures encountered have been available for two decades.

It was the writer's purpose in making the temperature measurements reported in this paper to establish, on as definite a quantitative basis as possible, the relation between the temperature in the furnace hearth and the analysis of the metal made. The silicon-sulfur theorem is unfortunately rather indefinite. The silicon, for example, is alleged to depend not only on the temperature but also on the slag composition and volume, the size of the furnace, the tonnage made per day, and the character of the charge. These factors are in doubt in that each can mean one or more of several things. The temperature of the hearth may mean the temperature of the metal or of the slag in the hearth, or it may mean the temperature of the solid stock in the combustion zone or of the products of combustion arising from that zone. By the composition of the slag one usually means its "basicity." This again doesn't mean anything in particular; it may refer to the percentage of lime or of bases, or to the ratio of lime to silica, of bases to silica, of lime to acids, or of bases to

acids. The size of the furnace may mean its hearth diameter, its bosh diameter, or its volume; the "character of the stock" may mean anything. In order successfully to correlate the temperature measurements obtained at the several furnaces, therefore, it was necessary at the same time to secure all the information available concerning both the furnaces and the furnace practice.

#### TEMPERATURE MEASUREMENTS AND OPERATING DATA FROM IRON BLAST-FURNACE OPERATION

A summary of the temperature measurements made by the writers and some of the operating data obtained from the furnace records for twenty iron furnaces are given in Table 1. The furnaces are numbered arbitrarily from 1 to 20, as shown in the first column. Temperatures measured with a set of Morse type optical pyrometers are given in the second, third, and fourth columns. Under the caption Tuyere Temperatures are given the temperature readings observed when the pyrometer was sighted through the tuyere stock and along the axis of the blow-pipe, through the tuyere and into the furnace. These temperatures are corrected, as well as was practicable, for the absorption of the glass screen in the tuyere sight. The slag and metal temperatures are those observed when the pyrometer was sighted on the surface of the slag and metal streams in their respective runners at flush and at cast. To the observed readings has been applied an appropriate emissivity correction. The details of the measurements and their probable accuracy will be discussed later. The metal and slag analyses were made by the companies' chemists. The figures in the last four columns were taken from the furnace records and have their usual significance. The fuel consumption is given in terms of pounds of carbon in place of the usual pounds of coke per ton of metal.

#### COMPARISON OF SILICON-SULFUR PYROMETER WITH OPTICAL PYROMETER

A casual examination of the figures in Table 1 reveals little to support the theorem that the temperature of the furnace can be determined from the silicon or sulfur in the metal or from any simple relation based on metal and slag analyses. The silicon varies from 0.92 to 2.40 per cent., the tuyere temperature from 1595° to 1862° C. (2903° to 3384° F.), the slag temperature from 1437° to 1543° C. (2619° to 2809° F.), and the metal temperature from 1426° to 1473° C. (2599° to 2683° F.). The range of variation found in this limited number of furnaces is: silicon, 1.48 per cent., tuyere temperature 267° C., slag temperature 106°, and metal temperature 47°. The silicon in the hottest metal is 1.14 per cent.

TABLE 1.—Operating Data from Twenty Furnaces

| Furnace Number | Temperature, Degrees C. |            | Metal Analysis |      |       |       |       | Slag Analysis |                                |                  |      |       | Blasf Temperature, Degrees C. | Pounds of Carbon per Ton of Metal | Pounds of Slag per Ton of Metal | Tons of Metal Per Day Per Square Foot of Hearth Area |
|----------------|-------------------------|------------|----------------|------|-------|-------|-------|---------------|--------------------------------|------------------|------|-------|-------------------------------|-----------------------------------|---------------------------------|--|
|                | Tuyere                  | Slag Metal | Si             | S    | Mn    | P     | CaO   | MgO           | Al <sub>2</sub> O <sub>3</sub> | SiO <sub>2</sub> | S    |       |                               |                                   |                                 |  |
|                |                         |            |                |      |       |       |       |               |                                |                  |      |       |                               |                                   |                                 |  |
| 1              | 1643                    | 1526       | 1463           | 2.40 | 0.033 | 0.56  | 0.081 | 41.5          | 3.1                            | 17.6             | 35.0 | 1.58  | 2090                          | 1412                              | 2.81                            |  |
| 2              | 1629                    | 1524       | 1467           | 1.99 | 0.025 | 0.62  | 0.080 | 42.5          | 3.1                            | 16.6             | 35.4 | 1.77  | 1765                          | 1500                              | 2.57                            |  |
| 3              | 1627                    | 1530       | 1462           | 1.97 | 0.026 | 0.71  | 0.082 | 43.0          | 3.1                            | 16.4             | 35.0 | 1.77  | 1183                          | 1183                              | 2.28                            |  |
| 4              | 1648                    | 1506       | 1470           | 1.32 | 0.034 | 0.33  | 0.089 | 46.3          | 3.5                            | 13.0             | 35.9 | 1.60  | 1645                          | 890                               | 2.97                            |  |
| 5              | ....                    | 1473       | 1443           | 1.09 | 0.036 | 0.56  | 0.208 | 46.3          | 3.5                            | 13.3             | 35.4 | 1.62  | 1678                          | 932                               | 2.68                            |  |
| 6              | 1649                    | 1531       | 1428           | 1.05 | 0.044 | 0.32  | 0.094 | 46.7          | 3.5                            | 11.8             | 37.2 | 1.53  | 1631                          | 985                               | 2.70                            |  |
| 7              | 1648                    | 1473       | 1444           | 1.51 | 0.035 | 0.68  | 0.100 | 48.5          | 2.0                            | 13.1             | 34.9 | 1.62  | 1150                          | 1150                              | 2.44                            |  |
| 8              | 1640                    | 1451       | 1437           | 1.29 | 0.049 | 0.65  | 0.096 | 48.3          | 2.2                            | 13.0             | 35.0 | 1.74  | 1720                          | 1132                              | 2.17                            |  |
| 9              | 1595                    | 1437       | 1437           | 0.96 | 0.049 | 1.62  | 0.206 | 46.1          | 3.5                            | 14.7             | 34.0 | 1.81  | 1685                          | 1020                              | 2.44                            |  |
| 10             | 1656                    | 1449       | 1456           | 1.37 | 0.031 | 0.71  | 0.084 | 46.5          | 2.3                            | 15.7             | 32.6 | 1.30  | 1631                          | 1020                              | 2.44                            |  |
| 11             | 1802                    | 1469       | 1467           | 1.42 | 0.024 | 1.30  | 0.233 | 47.5          | 2.0                            | 16.3             | 31.1 | 1.59  | 1720                          | 1132                              | 2.17                            |  |
| 12             | 1710                    | 1493       | 1454           | 1.14 | 0.030 | 0.73  | 0.084 | 46.5          | 2.2                            | 16.4             | 33.7 | 1.22  | 1631                          | 1020                              | 2.44                            |  |
| 13             | 1700                    | 1511       | 1473           | 1.14 | 0.020 | 1.73  | 0.350 | 45.0          | 6.2                            | 11.9             | 35.3 | 1.38  | 1631                          | 1020                              | 2.44                            |  |
| 14             | 1731                    | 1481       | 1437           | 1.08 | 0.036 | 1.90  | 0.315 | 43.9          | 6.0                            | 12.5             | 36.0 | 1.33  | 1720                          | 1132                              | 2.17                            |  |
| 15             | 1862                    | 1514       | 1468           | 1.27 | 0.034 | 1.34  | 0.131 | 43.0          | 2.3                            | 17.4             | 34.2 | 1.43  | 1190                          | 1190                              | 2.32                            |  |
| 16             | 1821                    | 1528       | 1459           | 1.59 | 0.032 | 0.80  | 0.085 | 38.9          | 7.3                            | 15.5             | 36.0 | 1.70  | 1502                          | 971                               | 2.52                            |  |
| 17             | 1849                    | 1543       | 1471           | 1.70 | 0.041 | 0.71  | 0.084 | 36.5          | 7.1                            | 16.0             | 37.1 | 1.83  | 1720                          | 1000                              | 2.21                            |  |
| 18             | 1800                    | 1525       | 1471           | 1.76 | 0.029 | 0.76  | 0.084 | 37.3          | 7.3                            | 16.6             | 36.6 | 1.84  | 1629                          | 946                               | 2.34                            |  |
| 19             | 1712                    | 1499       | 1463           | 1.57 | 0.040 | ..... | ..... | 39.4          | 9.5                            | 15.5             | 32.4 | ..... | 1845                          | 1030                              | 3.40                            |  |
| 20             | 1668                    | 1501       | 1448           | 0.97 | 0.032 | ..... | ..... | 42.5          | 9.4                            | 12.8             | 33.0 | ..... | 1641                          | 890                               | 2.28                            |  |

and in the coldest metal 1.05 per cent.; the silicon in the metal corresponding to the hottest slag is 1.70 per cent., and in the metal accompanying the coldest slag it is 1.05. The metal made by the furnace having the highest tuyere temperature carries 1.27 per cent. silicon. The furnace showing the coldest tuyeres, however, made metal with the lowest silicon; that is, furnace 9, tuyere temperature 1595° and silicon 0.92 per cent.

The twenty furnaces were arranged in the order of the increasing silicon content of the metal and were divided into four groups. The operating quantities for these furnaces were averaged by groups and the results are shown in Table 2. It is rather difficult to establish any basis for the silicon-sulfur theorem from these data. The three temperatures that might possibly indicate hearth temperature are included in this table as well as the three expressions that might indicate the basicity of the slag; for the most part none of these six quantities vary markedly with the silicon in the metal. Group I has average basicity and a low hearth temperature; group IV has average hearth temperature and a low basicity; groups II and III have both average hearth temperature and average basicity.

TABLE 2.—Furnaces Grouped According to Silicon Content

| Group   | I                  | II                  | III                  | IV                 |
|---|--------------------|---------------------|----------------------|--------------------|
| Furnaces included.....  | 5, 6, 9, 14,<br>20 | 4, 8, 12, 13,<br>15 | 7, 10, 11,<br>16, 19 | 1, 2, 3, 17,<br>18 |
| Silicon in metal.....   | 1.02               | 1.23                | 1.49                 | 1.96               |
| Sulfur in metal.....  | 0.038              | 0.034               | 0.033                | 0.031              |
| Tuyere temperature, degrees C.                                    | 1661               | 1712                | 1728                 | 1718               |
| Slag temperature, degrees C....                                   | 1485               | 1495                | 1483                 | 1530               |
| Metal temperature, degrees C..                                    | 1438               | 1460                | 1458                 | 1467               |
| CaO/SiO <sub>2</sub> .....  | 1.28               | 1.31                | 1.33                 | 1.12               |
| CaO + MgO/SiO <sub>2</sub> .....                                  | 1.39               | 1.41                | 1.47                 | 1.25               |
| CaO + MgO/SiO <sub>2</sub> + Al <sub>2</sub> O <sub>3</sub> ..... | 1.04               | 1.01                | 1.01                 | 0.86               |
| Viscosity of slag.....  | 480                | 814                 | 1048                 | 690                |

TABLE 3.—Furnaces Grouped According to Tuyere Temperatures

| Group   | V                     | VI                    | VII               | VIII        |
|---|-----------------------|-----------------------|-------------------|-------------|
| Furnaces included.....                                      | 11, 15, 16,<br>17, 18 | 12, 13, 14,<br>19, 20 | 1, 4, 6, 7,<br>10 | 2, 3, 8, 9, |
| Tuyere temperature, degrees C.                              | 1827                  | 1704                  | 1649              | 1623        |
| Slag temperature, degrees C....                             | 1516                  | 1497                  | 1497              | 1491        |
| Metal temperature, degrees C..                              | 1467                  | 1455                  | 1452              | 1450        |
| Silicon in metal.....                                       | 1.55                  | 1.18                  | 1.48              | 1.59        |
| Slag temperature minus metal<br>temperature, degrees C..... | 49                    | 42                    | 45                | 41          |

In order to look at these data in the other direction, the furnaces were rearranged in the order of decreasing tuyere temperatures, and averaged in four groups. The results of this arrangement, as given in Table 3, show that the slag is quite uniformly 45° hotter than the metal and that the metal temperature is quite closely proportional to the tuyere temperatures, the metal temperature rising 8° for every 100° increase in tuyere temperature. In this case group IV, with the coldest hearth, shows the highest silicon.

CALCULATION OF SILICON IN METAL

With the aid of more or less complete data on a number of furnaces, it is usually impossible to miss a relation existing between the various quantities once preconceived theories have been discarded. In the present case it can be shown that the silicon in the metal can be calculated from the following equation with an average error of ten points of silicon and a maximum error of twenty points.

- If  $S$  = per cent. of silicon in metal;
- $t$  = temperature of slag, degrees C.;
- $T$  = tons of metal made in 24 hr.;
- $D$  = hearth diameter, in feet;
- $F$  = pounds of coke per ton of metal;
- $M$  = per cent. of silica in the coke.

then

$$S = \frac{FM}{47.7} \left[ 0.238 + 0.143 \frac{T}{D^2} + 0.0012 (t - 1500) \right] \quad (1)$$

There are insufficient data from the first six furnaces to enable one to compare the actual results with the equation. For the remaining fourteen furnaces sufficient data of sorts are available, and the silicon has been calculated from this equation; the results are shown in Table 4.

TABLE 4.—*Calculated Silicon Contents*

| Furnace Number | Silicon, Actual, Per Cent. | Silicon, Calculated, Per Cent. | Difference, Per Cent. × 10 <sup>2</sup> | Furnace Number | Silicon, Actual, Per Cent. | Silicon, Calculated, Per Cent. | Difference, Per Cent. × 10 <sup>2</sup> |
|----------------|----------------------------|--------------------------------|---|----------------|----------------------------|--------------------------------|---|
| 7              | 1.51                       | 1.58                           | - 8                                     | 14             | 1.08                       | 1.03                           | 5                                       |
| 8              | 1.29                       | 1.21                           | 8                                       | 15             | 1.27                       | 1.36                           | - 9                                     |
| 9              | 0.96                       | 1.07                           | -11                                     | 16             | 1.59                       | 1.45                           | 14                                      |
| 10             | 1.37                       | 1.26                           | 11                                      | 17             | 1.70                       | 1.61                           | 9                                       |
| 11             | 1.42                       | 1.26                           | 16                                      | 18             | 1.76                       | 1.57                           | 19                                      |
| 12             | 1.14                       | 1.24                           | -10                                     | 19             | 1.57                       | 1.46                           | 11                                      |
| 13             | 1.14                       | 1.19                           | - 5                                     | 20             | 0.97                       | 1.01                           | - 4                                     |

In Fig. 1 the calculated and the actual values of the silicon are shown diagrammatically. It is rather difficult to attribute the agreement solely



to coincidence; in fact, it is definitely evident from Table 4 and Fig. 1 that the equation is an approximation of the true relation. It must not be concluded, however, that the equation can give the answer to the problem with any finality. It can be regarded as nothing more than the best quantitative expression that has so far been offered for predicting the silicon in the metal.

The interpretation of the equation 1 is rather simple.  $FM$  is the pounds of silica per ton of metal in the form of coke ash. This quantity, divided by 47.7, indicates the silicon the metal would carry if all the silica in the coke ash were reduced to silicon and entered the metal and if none of the silica from the ore or from the stone were reduced. Actually, the silica required to produce the silicon in the average metal, for these

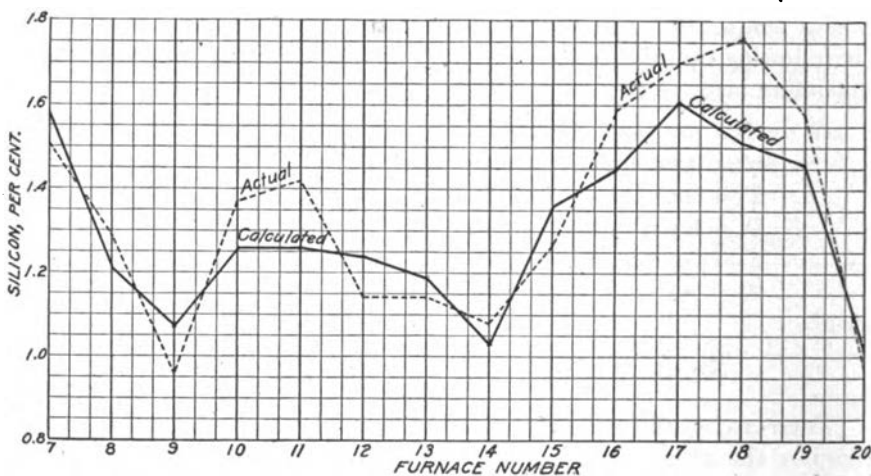

FIG. 1.

fourteen furnaces, is about 54 per cent. of the silica in the coke ash. The values for the individual furnaces vary from 47.4 to 66.5 per cent. The furnace "recovers" therefore something better than 50 per cent. of the silicon in the coke ash. This silicon recovery varies largely, and almost exclusively, with the tons of metal made per square foot of hearth area. In addition, but to a much less important extent, it varies with the temperature of the slag. An increase of  $100^{\circ}$  in slag temperature increases the silicon about 0.06 per cent. Since the silicon is thus so slightly affected by the slag temperature, it is obviously impossible practically to determine the slag temperature from the silicon in the metal. It is scarcely within the scope of the present paper to discuss this problem further; although the question of silicon control may be of importance to the general problem of furnace operation and control, the sole reason for considering it here was to show that it is but a slight indication of the hearth temperature theoretically and that practically it is no indication at all.

Furnaces have been operated many years on the assumption that the silicon in the metal is a hearth thermometer, and it is undeniable that a cold furnace (*i.e.*, a furnace producing low-silicon metal) can be cured by increasing the coke charge per ton of metal. Equation 1 shows that the silicon can be raised by increasing the coke consumption, by virtue of the fact that such an increase in coke consumption increases the amount of silicon in the coke ash, quite independent of any change it might produce in the temperature of the hearth.

SULFUR IN THE METAL AS A PYROMETER

- If  $s$  = per cent. sulfur in metal;
- $S$  = per cent. sulfur in slag;
- $t$  = temperature of metal, in degrees centigrade;
- $B$  = ratio  $\text{CaO} + \text{MgO} \div \text{Al}_2\text{O}_3 + \text{SiO}_2$

it can be shown that the empirical equation

$$s = 0.074 + 0.0183 S - 0.00061 (t - 1400) - 0.037 B \quad (2)$$

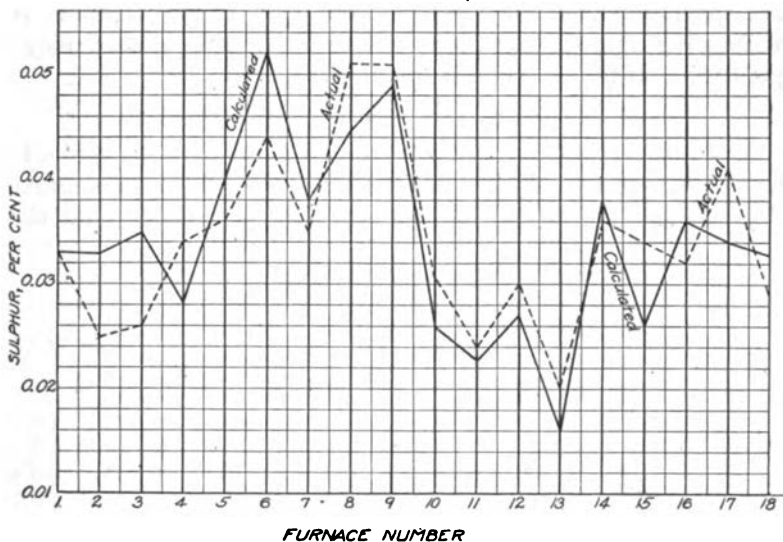

FIG. 2.

agrees with the facts shown in Table 1 within an average error of 0.0045 per cent. sulfur. Unlike the expression found for the silicon in the metal, this relation between sulfur and the related operating quantities agrees in a general way with the usual ideas held by furnacemen. The values of the actual sulfur and of the calculated sulfur in the metal for the first eighteen furnaces are given in Table 5 and are shown diagrammatically in Fig. 2.

The sulfur is lowered by increasing the ratio of bases to acids, by

raising the temperature of the metal, and by lowering the sulfur in the slag. This is the old story of sulfur control but for the first time in quantitative form, and substantiated by a certain amount of proof. The ratio of bases to acids is used as an independent variable here merely because it gives more concordant results than the ratio either of bases to silica, or of lime to silica. In the same way the temperature of the metal is used in preference to the temperature either of the slag or of the tuyeres, because the agreement is better. It must be remembered that both equations 1 and 2 are offered merely as empirical equations found by trial to agree with the observed facts with the consistency shown in Figs. 1 and 2. There will be ample time to theorize about these relations when their truth has been satisfactorily established. It may be of interest to notice, however, that of the three proposed expressions for the "basicity" of the slag the ratio of bases to acids seems to be the most significant.

DETERMINING METAL TEMPERATURE WITHOUT PYROMETRIC MEASUREMENT

The sharply defined effect of metal temperature on the sulfur in the metal suggests immediately the use of equation 2 for determining this temperature. If the equation is rewritten

$$t = 1521 + 30 S - 61 B - 1666 s \tag{3}$$

the temperature of the metal can be directly computed. Since from Table 3 the slag temperature averages 45° hotter than the metal an approximation to the slag temperature can also be made. This has been done and

TABLE 5.—*Calculated Sulfur Content*

| Furnace Number | Sulfur, Actual Per Cent. | Sulfur, Calculated Per Cent. | Difference, Per Cent. | Furnace Number | Sulfur, Actual Per Cent. | Sulfur, Calculated Per Cent. | Difference, Per Cent. |
|----------------|--------------------------|------------------------------|-----------------------|----------------|--------------------------|------------------------------|-----------------------|
| 1              | 0.033                    | 0.033                        | 0.000                 | 10             | 0.031                    | 0.026                        | +0.005                |
| 2              | 0.025                    | 0.033                        | -0.008                | 11             | 0.024                    | 0.023                        | +0.001                |
| 3              | 0.026                    | 0.035                        | -0.009                | 12             | 0.030                    | 0.027                        | +0.003                |
| 4              | 0.034                    | 0.028                        | +0.006                | 13             | 0.020                    | 0.016                        | +0.004                |
| 5              | 0.036                    | 0.040                        | -0.004                | 14             | 0.036                    | 0.038                        | -0.002                |
| 6              | 0.044                    | 0.050                        | -0.006                | 15             | 0.034                    | 0.026                        | +0.008                |
| 7              | 0.035                    | 0.038                        | -0.003                | 16             | 0.032                    | 0.036                        | -0.004                |
| 8              | 0.049                    | 0.045                        | +0.004                | 17             | 0.041                    | 0.034                        | +0.007                |
| 9              | 0.049                    | 0.047                        | +0.002                | 18             | 0.029                    | 0.033                        | -0.004                |

the results are given in Table 6. It is observed that the maximum discrepancy between the observed and the calculated temperatures is 16° and that the average discrepancy is 7.4°. As the calculated value involves all the errors in chemical analyses for *S* in the metal, and for CaO, MgO, Al<sub>2</sub>O<sub>3</sub>, SiO<sub>2</sub>, and *S* in the slag, the agreement is remarkably

close. Moreover, as will be mentioned later, the uncertainty in the pyrometer readings on the metal is easily 7°. For any ordinary purpose, calculation gives perfectly satisfactory metal temperatures but the calculated slag temperatures may be 50° in error; the average error for slag temperature is 19.5°. As was shown by Table 3, a change of 8° corresponds, in a general sort of way, with a 100° change in tuyere temperature. Hence it would be expected, and it is found to be true, that an attempt to trace back from the sulfur in the metal to the tuyere temperature fails.

### CONCLUSIONS CONCERNING RELATIONS BETWEEN SILICON, SULFUR, AND HEARTH TEMPERATURE

The facts presented and discussed above appear to point to a number of conclusions many of which are quite contrary to what has heretofore been accepted, and which may be of importance to furnace operators. In summary form they may be stated:

TABLE 6.—*Calculated Metal and Slag Temperatures*

| Furnace Number | Metal Temperature, Degrees C. |            |            | Slag Temperature, Degrees C. |            |            |
|----------------|-------------------------------|------------|------------|------------------------------|------------|------------|
|                | Actual                        | Calculated | Difference | Actual                       | Calculated | Difference |
| 1              | 1463                          | 1463       | 0          | 1526                         | 1508       | +18        |
| 2              | 1467                          | 1480       | -13        | 1524                         | 1525       | -1         |
| 3              | 1462                          | 1478       | -16        | 1530                         | 1523       | +7         |
| 4              | 1470                          | 1459       | +11        | 1506                         | 1504       | +2         |
| 5              | 1443                          | 1449       | -6         | 1473                         | 1494       | -21        |
| 6              | 1426                          | 1436       | -10        | 1531                         | 1481       | +50        |
| 7              | 1444                          | 1448       | -4         | 1473                         | 1492       | -19        |
| 8              | 1437                          | 1430       | +7         | 1451                         | 1474       | -23        |
| 9              | 1437                          | 1434       | +3         | 1437                         | 1479       | -44        |
| 10             | 1456                          | 1448       | +8         | 1449                         | 1494       | -46        |
| 11             | 1467                          | 1466       | +1         | 1469                         | 1511       | -42        |
| 12             | 1454                          | 1449       | +5         | 1493                         | 1494       | -1         |
| 13             | 1473                          | 1464       | +9         | 1511                         | 1509       | +2         |
| 14             | 1437                          | 1441       | -4         | 1481                         | 1486       | -5         |
| 15             | 1468                          | 1456       | +12        | 1514                         | 1501       | +13        |
| 16             | 1459                          | 1465       | -6         | 1528                         | 1510       | -18        |
| 17             | 1471                          | 1459       | +12        | 1543                         | 1504       | -39        |
| 18             | 1471                          | 1477       | -6         | 1525                         | 1522       | +3         |

1. The silicon in the metal is not dependent on the chemical composition of the slag; the temperature of the hearth; the silica content of the ore; the viscosity of the slag; the blast temperature.

2. The silicon in the metal is dependent on the silica in the coke ash; the speed of operation expressed as tons of metal per day per square

foot of hearth area; the slag temperature, but to an almost negligible extent.

3. It is impossible, practically, to estimate the temperature of the combustion zone of the metal, or of the slag from any simple expression involving the silicon content of the metal.

4. The sulfur in the metal is not, in general, lower with high silicon metal.

5. The sulfur in the metal is dependent on the sulfur in the slag; the temperature of the metal; the ratio of bases to acid.

6. The temperature of the metal can be calculated from the sulfur in the slag, the sulfur in the metal, and the ratio of bases to acids in the slag. The maximum error in this calculation is  $16^{\circ}\text{C}$ . and the average error is  $7.5^{\circ}$ . This error may easily be attributed to errors in chemical analyses, in pyrometric measurements, to both, or to the inaccuracy of the equation from which the temperatures were calculated.

7. The temperature of the slag can be calculated from the same variables with a maximum variation of  $50^{\circ}$  and with an average error of  $19.5$  degrees.

To the extent that the furnace operator is satisfied with the production of metal that meets the silicon and sulfur specifications, the pyrometer has little to offer. Knowing the temperature of the slag and of the metal it is possible to predict the analysis of the following cast. Knowing the analysis of the metal and of the slag, it is possible to estimate the temperature of the preceding cast. The pyrometer has something to tell about what is going to happen and that perhaps is an advantage. Often a few hours mean much in the operation of a furnace. Nevertheless it is easily possible to overrate this advantage.

There is more to the operation of the blast furnace, however, than controlling the silicon and sulfur content of the metal. The real furnace problem is the production of a given tonnage of metal in the shortest possible time and with the least expenditure of materials. The preceding discussion has not touched that problem. The existence of certain temperatures in the hearth has been shown and their effect has been discussed. A complete pyrometric study of the blast furnace should go further than this, it should attempt to find out the reason for the temperatures observed. Every furnaceman is trying to keep his coke consumption at a minimum; the mark of that minimum, the sign which says he shall not go further, is a cold hearth. It has been shown that a reduction in coke lowers the silicon in the metal without indicating a drop in temperature. There is a possibility, therefore—the writers insist, however, that it is only a possibility—that some furnacemen have stopped on the high side of the minimum from fear of low-silicon iron. It is where a serious attempt is made for a low-coke campaign that the pyrometer promises to be most useful. Take the case of furnaces

15 and 16 in Table 1, which were burning 1518 and 1502 lb. of carbon per ton of metal. The pyrometer readings show that there was no danger here of a cold hearth. The metal and slag temperatures are above the average, and the tuyere temperatures are, respectively, the highest and the third highest observed.

### MANGANESE IN THE BLAST FURNACE

Manganese oxide, like silica, is reduced at a higher temperature than iron oxide. It is generally believed, therefore, that a blast furnace making high-silicon pig, spiegeleisen, or ferromanganese must operate with a hotter hearth than a furnace making basic iron. The Bureau of Mines has published<sup>1</sup> a summary of the temperatures observed in the hearth of seven ferromanganese furnaces and five spiegeleisen furnaces. The following figures will show how the temperatures in the manganese-alloy furnaces compare with the temperatures in the iron furnaces discussed above.

| FURNACE             | TUYERE<br>TEMPERATURE,<br>AVERAGE,<br>DEGREES C. | SLAG<br>TEMPERATURE,<br>AVERAGE,<br>DEGREES C. | METAL<br>TEMPERATURE,<br>AVERAGE,<br>DEGREES C. |
|---------------------|--|--|---|
| Iron.....           | 1706   | 1498   | 1455  |
| Spiegeleisen.....   | 1597   | 1427   | 1392  |
| Ferromanganese..... | 1550   | 1426   | 1386  |

The manganese-alloy furnaces are considerably colder than the iron furnaces in spite of the higher temperature required to reduce manganese oxide and in spite of the fact that the average carbon per ton of metal consumed is 5323 lb. (2414 kg.) for the ferromanganese furnace and 3444 lb. (1562 kg.) for the spiegeleisen furnace.

It was concluded as a result of the Bureau's investigation of manganese furnaces that an improvement in practice would result from the use of less coke and from increasing the ratio of bases to silica in the slag. As an illustration of the use of the pyrometer in furnace control, the following figures may be of interest. The writers observed the operation of a furnace making ferromanganese for 12 days. Certain of the daily operating quantities are shown in Table 7. The charging of this furnace was done on the basis of the silicon in the metal and of the operator's judgment of the hearth temperature. The ratio of bases to silica was quite irregular, but in general much too low. It was only on the fourth and twelfth days that it was anything near what it should have been.

<sup>1</sup> P. H. Royster: Production of Ferromanganese in the Blast Furnace. *Bull.* 146 (Feb., 1919); Bureau of Mines *War Minerals Investigation Series* No. 5 (Dec., 1918).

P. H. Royster: Production of Spiegeleisen in the Blast Furnace. Bureau of Mines *War Minerals Investigation Series* No. 6 (Dec., 1918).

TABLE 7.—Daily Results of Furnace Making Ferromanganese

| Day | Pounds of Coke per Ton of Metal | Ratio Bases/Silica in Slag | Silicon in Metal, Per Cent. | Temperature of Metal, Degrees C. | Temperature of Tuyeres, Degrees C. | Per Cent. Manganese in Slag |
|-----|---------------------------------|----------------------------|-----------------------------|----------------------------------|------------------------------------|-----------------------------|
| 1   | 7,718                           | 1.34                       | 2.20                        | 1,412                            | 1,571                              | 11.0                        |
| 2   | 8,826                           | 1.36                       | 2.30                        | 1,426                            | ....                               | 7.8                         |
| 3   | 7,974                           | 1.38                       | 2.05                        | 1,450                            | 1,611                              | 6.1                         |
| 4   | 8,109                           | 1.52                       | 1.58                        | 1,475                            | 1,622                              | 4.9                         |
| 5   | 8,333                           | 1.45                       | 0.61                        | 1,456                            | ....                               | 9.3                         |
| 6   | 8,154                           | 1.48                       | 0.77                        | 1,456                            | 1,598                              | 6.3                         |
| 7   | 7,885                           | 1.48                       | 1.78                        | 1,460                            | 1,614                              | 6.1                         |
| 8   | 8,534                           | 1.45                       | 0.40                        | 1,514                            | ....                               | 8.8                         |
| 9   | 10,326                          | 1.42                       | 0.41                        | ....                             | ....                               | 9.9                         |
| 10  | 8,669                           | 1.33                       | 0.40                        | 1,480                            | 1,546                              | 8.5                         |
| 11  | 8,579                           | 1.40                       | 0.93                        | 1,480                            | 1,633                              | 6.6                         |
| 12  | 6,797                           | 1.52                       | 1.85                        | ....                             | ....                               | 4.9                         |

On these two days the "basicity" was 1.52, and the manganese in the slag was 4.9. The coke consumption was in every case much too high, its effect being to increase the slag volume, lower the basicity, and increase the manganese lost in the slag. The coke consumption on the twelfth day was but 82 per cent. of the coke used on the fourth day, but the results were much better, the per cent. manganese in the slag being equally low and the slag volume lower. The failure of the silicon thermometric theorem to give the true temperatures or to serve practically as a guide to good operation is evident throughout. Bearing in mind that the average metal temperature in ferromanganese practice is 1386°, it will be seen that this was a very hot furnace. On the eighth day, the metal was extremely hot (1514° C.) and yet the silicon had dropped over night from 1.78 per cent. to 0.40 per cent. The operator, fearing a cold hearth, put on extra coke that day, which took about 24 hr. to pass down the stack, running up the coke consumption on the ninth day to the remarkable figure 10,326 lb. per ton but did not raise the silicon. The tons of metal made on the ninth day was only 38 compared with 47 on the eighth day and an average of about 50 tons per day for the first seven days. It can be shown that it cost the furnace profits about \$3000 on the ninth day to conclude that the furnace was getting cold because the silicon dropped from 1.78 per cent. to 0.40 per cent.

MEASUREMENT OF TEMPERATURES AT THE BLAST FURNACE

The pyrometric measurements upon which the figures in this paper are based comprise over thirty-six hundred readings at iron furnaces and about forty-one hundred readings at manganese furnaces. The instruments used were Morse type optical pyrometers, the outfit consisting of

two telescopes and absorption screens, four lamps, and three Weston milliammeters. The lamps and one of the absorption screens were calibrated by Leeds & Northrup. The milliammeters were calibrated at intervals during the investigation in the Bureau's laboratories against a standard resistance and a standard cell. Effort was made to avoid instrumental errors by frequent interchanging of the four variable combinations; observer, lamp, screen, and milliammeter. There were forty-eight of such combinations possible and the concordance was satisfactory at all times, except in the case of the Weston ammeter. One of them suddenly began reading  $110^{\circ}$  C. high, and it was necessary to attach a shunt to it. All of them persist in collecting particles of iron, or magnetic iron oxide, on the magnets obstructing the movement of the swinging coils.

The measurement of the metal temperature is the simplest of the three measurements the writers have attempted. The telescope can be sighted from a distance of about 10 ft. (3 m.) on the metal stream flowing over the dam just below the skimmer. Occasionally the presence of traces of slag carried along with the metal causes trouble. Following Burgess, the emissivity of iron has been taken to be 0.40.

The measurement of the slag temperature is somewhat more difficult. The viscosity of the slags observed varied from 3 to 20 C. G. S. and the arrangement of the slag runner is different at each furnace, although in general all of them are difficult to observe. Considerable "spitting" at the cinder notch, clouds of sulfur-bearing gases arising from the stream, the presence of small pieces of chilled slag on the surface of the flowing cinder combine often to tax one's ingenuity to get a fair sight on the slag. The emissivity of the slag has been taken to be 0.65 although it seems probable that 0.70 is more nearly correct. This change in assumed emissivity would necessitate subtracting  $10^{\circ}$  C. from the slag temperatures as recorded in Table 1.

The most difficult reading of all is that of the so-called "tuyere temperature." In the first place, there are several different things visible through the tuyere glass. Coke in dancing lumps, each at a different temperature, can be identified with certainty; very rarely can anything resembling a liquid be seen. The falling "globules" of slag and metal on their way from the bosh to the hearth have doubtless been described more often than they have been seen. About a third of the time, at the average furnace, nothing is visible except a flame. The tuyere temperatures recorded in Table 1 are merely the average of several hundred readings at each furnace taken at random through unselected tuyeres with the hope that such an average will more or less approximate the average temperature. There is no combustion-zone temperature apart from the average combustion-zone temperature. The uncertainty here is not so much due to difficulties in reading as to difficulty in defining a tempera-



ture. A correction to the observed temperature must be made in the case of tuyere temperatures on account of the absorption of the glass screen in the tuyere sight. This has been taken to be 25° C., which is probably low. This absorption with a very clean glass may be as low as 15°; but due to the flue dust in the hot blast, picked up in its journey through the stoves, the tuyere glass is never perfectly clean. To add another 25° to the tuyere temperatures in Table 1 would probably more closely approach the truth.

## DISCUSSION

A. L. FEILD, Cleveland, Ohio (written discussion\*).—In equation 2,  $B$  is used to denote the ratio of bases (lime plus magnesia) to acids (alumina plus silica) it being stated that this ratio gives more concordant results than the ratio either of bases to silica, or of lime to silica. I find, however, that, by making use of the ratio between true CaO (CaO by analysis minus sulfur calculated to CaS) to acids, equation 2 may be modified to agree with the observed facts within an average error of 0.0041 per cent. sulfur instead of 0.0045 per cent. The revised equation is

$$s = 0.072 + 0.0183S - 0.00061(t - 1400) - 0.0403B$$

where  $B$  is the ratio of true CaO to  $Al_2O_3$  plus  $SiO_2$ , and the other symbols have the same significance as before.

I would not appear to stress too much this slightly better agreement of the revised equation with the observed sulfur. Yet I believe that the use of this ratio of true CaO to acids is to be preferred, if for no other reason than the fact that it is more in harmony with the previous findings of the Bureau of Mines with regard to the effect of magnesia and other impurities on slag viscosity.<sup>2</sup>

The empirical relations found for the twenty furnaces investigated should be of great interest both to the metallurgist and the furnaceman, but to establish firmly the validity of these equations, the investigation should include a somewhat wider range of practice. For instance, Table 1 includes no pig iron with more than 0.050 per cent. sulfur. So far as this element is concerned, all the cases cited fall within what is generally designated as good practice in the case of foundry, basic, or Bessemer iron, but the examples do not cover the entire range of good practice. Iron with 0.060 per cent. sulfur is quite commonly used in the basic open-hearth. Data for several irons a little high in sulfur or off-grade would permit a proper estimate to be placed upon the value of equation 2 as an instrument in everyday works control. Similarly, equation 1,

\* Received Sept. 24, 1919.

<sup>2</sup> A. L. Feild and P. H. Royster: Slag Viscosity Tables for Blast-furnace Work. *Tech. Paper* 187 (1918) 4 et seq.

dealing with the per cent. of silicon in the metal, would be even more convincing if it were to apply to a wider range than from 0.96 to 1.76 per cent. silicon. Nevertheless, even within the range of practice covered, it is remarkable that any arithmetical relations, however empirical, have been established.

Probably the statement that will meet the most opposition from furnacemen is that the sulfur in the metal is not, in general, lower with high-silicon metal. I believe, however, it is possible to reconcile the accepted silicon-sulfur theorem with this radical conclusion. The latter is based on observations on twenty different furnaces, operated under diverse conditions and with the usual differences in dimensions, tendency toward slips, uniformity of blast distribution and stock descent. While it has been possible to derive from such data empirical formulas that hold remarkably well for the case of silicon and of sulfur, taken separately, it would be much more difficult to correlate silicon and sulfur over the wide range of practice selected. It is hoped that the validity of equations 1 and 2 will be further proved by a series of experiments on a single furnace, covering a considerable range of sulfur and silicon values. By confining the application of the two equations to a single furnace, a relation may be deduced which will show that, in these circumstances, the sulfur in the metal is, in general, lower with high silicon content.

By making a single assumption, which appears permissible, it can be shown from the data in Table 1 that there is a well-defined relation between silicon and sulfur, and of the sort expected. It will be observed that the corresponding temperatures of slag and metal, given in columns 3 and 4 respectively, do not differ on the average by more than 51°. Measurements of slag and metal temperatures are subject to experimental errors, particularly the former. If 10° is subtracted from the slag temperatures, as suggested by Messrs. Royster and Joseph, to correspond to an emissivity of 0.70 instead of 0.65, the average difference between slag and metal temperatures will be only 41°. For our present purpose, we will assume that the temperatures of slag and metal are equal for any given furnace. It is then readily proved that equations 1 and 2 may be combined, thus

$$Si + 2s \left( \frac{FM}{47.7} \right) = \frac{FM}{47.7} \left( 0.263 + 0.36S - 0.0732B + 0.143 \frac{T}{D^2} \right) \quad (a)$$

where  $Si$  is equal to the silicon in the metal,  $S$  the per cent. of sulfur in the slag, and the other symbols have their former significance.

If desired,  $B$  may be replaced by  $B'$ , where  $B'$  is equal to the ratio of true lime to alumina plus silica, in which case the equation becomes

$$Si + 2s \left( \frac{FM}{47.7} \right) = \frac{FM}{47.7} \left( 0.260 + 0.36S - 0.0792B' + 0.143 \frac{T}{D^2} \right) \quad (b)$$

An examination of equation *a* shows that when the pounds of coke per ton of metal, the per cent. of silica in the coke, the tons of metal made in 24 hr., the sulfur in the slag, and the basicity of the slag are held constant, the quantity

$$Si + 2ks = \text{constant} \quad (c)$$

where *k* is a constant equal to  $\frac{FM}{47.7}$ . In order for (*Si* + 2*ks*) to be constant, it is necessary for the silicon to go up when the sulfur goes down, and vice versa. Such a change might be produced by a fall in blast temperature, an increase or decrease in atmospheric moisture, or a change in the regularity of movement of the stock. For this particular furnace, therefore, a sudden unexpected increase or decrease in silicon is accompanied by an opposite change in the sulfur content. If lime or coke is put on or taken off, there is another set of conditions to which equation *c* applies, but with a different value for the constant on the right hand side of the equation.

Since the values for *M*, the per cent. silica in the coke, and for *D*, the diameter of the hearth are not given, it is not possible to apply equations *a* or *b*. Such a computation would be interesting as it would indicate what percentages of silicon would be expected for various arbitrarily chosen sulfur values. The silicon-sulfur curves for each of the twenty furnaces might disclose some important relationships.

With regard to the effect of slag viscosity on silica reduction, it has been deduced elsewhere,<sup>3</sup> on theoretical grounds, that a fluid slag is not necessary because diffusion is a minor item. I would like to see, however, some attempt made to correlate desulfurizing power with slag viscosity, temperature, and basicity. The sulfur distribution between slag and metal is probably largely a matter of diffusion, although we do not possess such quantitative proof of the theory as Messrs. Royster and Joseph have offered in support of the principal conclusions of their paper.

C. P. LINVILLE, Elizabeth, N. J.—I am thoroughly convinced that silicon in pig iron is directly correlated with slag temperature, and I want to outline, perhaps in a little different way, some work I did about 10 years ago.

It might be well, first of all, to state that the temperature obtained by burning coke in a blast furnace is affected by several things. That temperature is merely a result of heat-forming reactions, the principal one of which is the burning of carbon to carbon monoxide, and the heat is absorbed by the products of the combustion and the materials in the hearth. The temperature to which those materials are raised is directly proportional to their amount and to the amount of heat available. That, of course, has all been worked out before.

---

<sup>3</sup> Bureau of Mines *Tech. Paper* 187, 14-15.

Now, in the blast furnace, the variables are the hot-blast temperature and the composition of the air used, particularly as regards moisture. We get a hotter fire with a heated blast than with cold blast and with dry air than with moist air on account of the heat of decomposition of the water vapor present and the variable specific heats of the gaseous products of combustion. It seems to me, therefore, that data which leave out of consideration the matter of hot-blast temperatures and the moisture content of the air blown neglect two very important things. I admit that this paper seems to show that with average conditions being practically the same, there is perhaps no correlation between observed slag temperature and percentage of silicon in the pig iron; but if you take a single furnace and observe that furnace from cast to cast, you will find

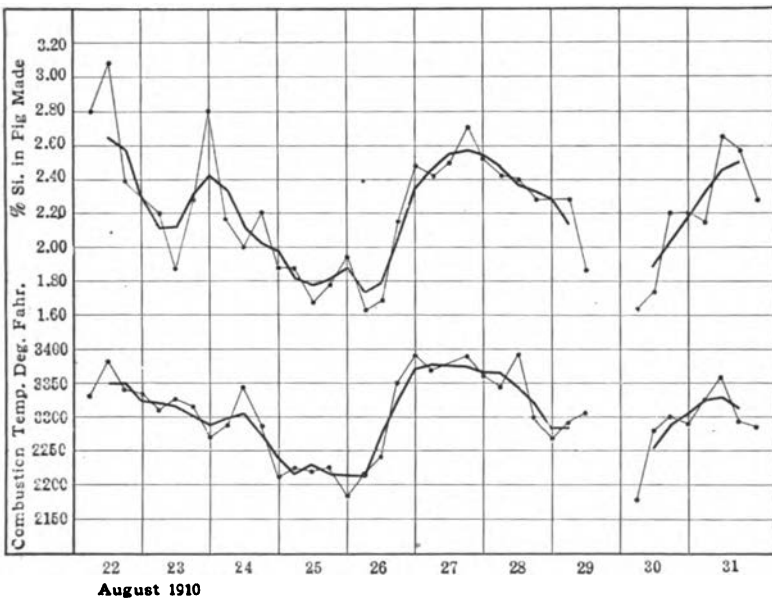

that slag temperature as it rises or falls is accompanied by variations in the silicon content which bear a fixed relationship.

For a period of almost a month, I followed the operation of a furnace from which we obtained, hourly, moisture readings of the gases of the air blown in. We had a continuous record of hot-blast temperatures and got from the laboratory the analysis of every cast of iron made. From these data the figures were averaged over the period between casts. For instance, we would find an average hot-blast temperature for the 6 hr. preceding the cast, which would be, we will say, 639° F. (338° C.). We found a certain amount of average moisture content in the air during that time, say, 6.9 gr. per cu. ft. From data worked out, having those two figures, we can determine the theoretical combustion temperature of

coke burned under those conditions, which is found to be 3380° F. (1860° C.).

If the theoretical combustion temperature for these periods and the silicon content of the iron for each of these casts are plotted, there is found to be a marked similarity between the variations in the curves for the silicon content, and for the theoretical combustion temperature, showing, it seems to me, that there is a relationship between combustion and silicon content. The accompanying chart will illustrate the above contentions.

I will say that for periods of 10 days, at least, we found combustion temperatures almost identical, in their variations up and down, with the percentage of silicon found in the pig iron; and in this particular furnace under the particular conditions which they were operating, with the same burden running along, we found in general a change of 0.1 per cent. of silicon in the pig iron was caused by a difference of 17.5° in the actual theoretical combustion temperature, which might be caused by either a change of 20° F. in the hot-blast temperature or 0.7 gr. in moisture per cubic foot of air blown. These figures are not to be taken as general for all blast-furnace work but for the particular furnace we were observing with the burden that it was carrying.

P. H. ROYSTER.—I agree with Mr. Linville that the moisture in the blast has an important effect on furnace operation. The average furnace operator does not think so, however, and hence makes no systematic attempt to measure the humidity of the engine-room air. For this reason the authors were unable to obtain records of the moisture in the blast.

Mr. Feild suggests that a furnace be run in such a manner that all of the operating factors remain constant, except the one factor which is under investigation. This is an excellent suggestion. It is impracticable in any ordinary plant, where two or three operating quantities remain constant over any considerable period of time. But it cannot be summarily dismissed as an impossible one. The scheme is a promising one; a few weeks of such operation would, for investigative purposes, be worth a year's operation under ordinary conditions.

C. P. LINVILLE.—I admit that all of the pyrometrical work I have done on blast-furnace slag temperatures is subject to considerable correction. The work I did was on temperatures of pig iron and slag as running from a furnace taken by a pyrometer with no corrections made. I did not consider accuracy with regard to temperatures and variables necessary but differences from time to time. Nothing further has been done along the line of actually determining temperatures.

I felt that we had a certain amount of evidence at that time which bore out the perfectly reasonable assumption that the actual slag tempera-

tures and the actual iron temperatures were direct functions of the theoretical combustion temperatures and that, perhaps on account of the difficulty in reading actual temperatures, results could be correlated a great deal better on the basis of theoretical temperature, which might be several degrees higher than observed temperature would be.

With regard to the influence of moisture, a great many blast furnaces take their air supply from points that have considerably higher moisture and much more variable moisture content than the local weather bureau would show. Just to show the variation, the moisture at 7.00 a.m. on this particular date, in the air being blown into a furnace was 11.1 gr. per cu. ft. That is for the average 6-hr. period ending at 7.00 a.m. In the average 6-hr. period, ending at 1.00 p.m., the moisture had fallen to 7.8 gr. We went from a very high humidity to a relatively low rate, so that local weather reports taken from a point some distance away from the furnaces have very little relationship between the actual figures that you would get if you were close to the furnace.

P. H. ROYSTER AND T. L. JOSEPH (author's reply to discussion\*).—Mr. Linville<sup>4</sup> has published a record of the temperature of the slag from a 300-ton furnace as measured by him with a Fery radiation pyrometer in 1909. On p. 276 he has shown graphically the slag temperature by 6-hr. periods from 2.00 A. M. Feb. 13 to 8.00 P. M. Feb. 15. The silicon in the metal varied from 2.08 to 1.02 per cent. We have grouped his casts into two groups, high-silicon metal and low-silicon metal, as follows: High silicon, 2 A. M., 8 A. M., 2 P. M., Feb. 13; 8 A. M., 2 P. M., 8 P. M., Feb. 15; Low silicon, 8 P. M., Feb. 13 to 2 A. M. Feb. 15.

In addition to the values of slag temperature and of silicon content in the metal, he gives figures for the "theoretical combustion of carbon," to which he seems to attach importance; we do not understand how he calculates this temperature, nor what it means when he has calculated it, but we have included these values in the group averages to show that they do not explain the changes in the silicon content of the metal. All of his slag temperatures have been converted into degrees Centigrade, and have been raised 60° C.—the emissivity correction we have used in our own paper. Mr. Linville seems to think that there is some disagreement between his observations and ours. For comparison, therefore, we give below our twenty furnaces grouped in the same manner in which we have grouped his casts; namely, the ten furnaces showing the higher silicon and the ten furnaces showing the lower silicon.

The slag temperature is not dependent on the silicon in the metal based on either Mr. Linville's or our own data. Further, there is no relation between silicons in Mr. Linville's casts and his theoretical

\* Received Feb. 6, 1920.

<sup>4</sup> *Trans.* (1910) 41, 268-279.

|   | Linville                   |                           | Royster and Joseph         |                           |
|---|----------------------------|---------------------------|----------------------------|---------------------------|
|   | High Silicon,<br>Per Cent. | Low Silicon,<br>Per Cent. | High Silicon,<br>Per Cent. | Low Silicon,<br>Per cent. |
| Silicon in metal . . . . .                                  | 1.72                       | 1.18                      | 1.72                       | 1.12                      |
| Observed slag temperature, de-<br>grees C. . . . .          | 1499                       | 1501                      | 1506                       | 1490                      |
| Theoretical combustion tem-<br>perature, degrees C. . . . . | 1991                       | 1988                      |                            |                           |

combustion temperature of carbon. He refers to some work he did "about 10 years ago," which seems to refer to the paper of 1909 we have quoted. He states, however, that his observations covered the period of "almost a month," which indicates that he has two sets of observations only one of which has been published. He now presents a curve showing the results of the operation of a furnace for 10 days in August, 1910. Presumably this is 10 of the 30 days he refers to. We have read off from his curve 37 years of values for "theoretical combustion temperature" and observed silicon content in the metal. There is definite evidence of a relationship between these two quantities which may be expressed by the equation

$$S_i = 0.009(T - 3000) - 0.50 \tag{4}$$

Where  $S_i$  = silicon content of metal, in per cent.;

$T$  = theoretical combustion temperature, in degrees F.

The average difference between the observed silicon and the silicon calculated from equation 4 is 0.32 per cent. silicon, the maximum variation being 0.82 per cent.

We may summarize the evidence offered by Mr. Linville as follows: Mr. Linville has shown that the silicon in the metal was not dependent on the theoretical combustion temperature in the case of a furnace in February, 1909. He has shown that the silicon in the metal was dependent on the theoretical combustion temperature in the case of the same (or another?) furnace in August, 1910.

It would be difficult for us to explain why Mr. Linville's data do not agree, as he gives little information about the other conditions of furnace. We are not even going to try to explain it, because we are not greatly interested in any theoretical combustion temperature. Apparently Mr. Linville has 20 more days' worth of data which he has not published. If these data were available we might be able to draw several more conclusions, all different and all equally good.

We have felt in the course of observing temperatures at furnaces,

in writing about them, and in reading what others have written that it is possible to take a list of observed temperatures too much for granted. Observed temperatures and the conclusions derived from them should not be accepted as correct, ignoring experimental error, nor should they be dismissed as incorrect because of experimental error unless the correct attitude is really known. In our present paper, we have printed three average temperatures for each of twenty furnaces and none of these temperatures on their face show any justification for themselves. The metal temperatures are too nearly constant and the tuyere temperatures are not constant enough. Our observed readings do not bear out what Mr. Linville calls the "perfectly reasonable assumption" that the slag and the metal temperatures are a function of the combustion temperatures. Neither do they bear out the assumption Mr. Feild has endeavored to make, that the slag temperature and the metal temperature are identical.

A little elementary physics will show that the temperature of the slag cannot be the same as the temperature of the metal. Part of the slag is formed from the ore gangue and the flux; this part of the slag falls into the hearth with the metal. If there were no ash in the coke, the slag and the metal would come from the furnace at the same temperature. The coke ash cannot fall into the hearth, however, until the carbon in the coke is burned at the tuyeres. When the coke ash does fall into the hearth, it is at the temperature of the tuyeres. Since the tuyere temperature is usually 350° C. higher than the metal temperature, the coke ash will heat the slag above the metal temperature. It is a simple matter to calculate how much this temperature will be

- If  $M$  = total slag per ton of metal;  
 $A$  = coke ash per ton of metal;  
 $T_1$  = temperature of coke in combustion zone—tuyere temperature;  
 $T_2$  = temperature at which gangue, flux, and metal fall into hearth—metal temperature;  
 $T_3$  = temperature resulting from mixture—slag temperature;  
 $S_1$  = specific heat of ash;  
 $S_2$  = specific heat of gangue plus flux;

Then

$$T_3 = T_2 + \frac{S_1 A}{S_2 M} (T_1 - T_2) K$$

where  $K$ , taken for simplicity to be a constant, is the slag's drop in temperature due to the heat loss to its surroundings. The difficulty in applying this equation lies in the uncertainty as to just how much coke ash is charged per ton of metal, this uncertainty coming from the failure of coke analyses to more than hint at the actual ash and from the pre-



vailing habit of charging coke without weighing it. Equation 1 in the paper, however, shows the relation between the silicon in the metal made and the coke ash and can be used to calculate the coke ash more closely than we can guess at this figure from the furnace records. The accompanying table shows the slag temperatures calculated from the equation here given, using the ash as calculated from equation 1.

| Furnace Number | Ash from Records | Ash from Equation (1) | Slag Temperature Calculated from Equations, Degrees C. | Observed Slag Temperature, Degrees C. | Differences Calculated and Observed, Degrees C. |
|----------------|------------------|-----------------------|--|---------------------------------------|---|
| 7              | 12.0             | 12.6                  | 1467   | 1473                                  | 6   |
| 8              | 12.0             | 11.2                  | 1437   | 1451                                  | 14  |
| 9              | 12.0             | 13.4                  | 1448   | 1437                                  | 11  |
| 10             | 12.0             | 11.1                  | 1495   | 1449                                  | 44  |
| 11             | 11.9             | 10.6                  | 1553   | 1469                                  | 16  |
| 12             | 11.9             | 12.9                  | 1491   | 1493                                  | 2   |
| 13             | 10.7             | 11.2                  | 1499   | 1511                                  | 12  |
| 14             | 10.7             | 10.2                  | 1476   | 1481                                  | 5   |
| 15             | 11.0             | 11.7                  | 1516   | 1514                                  | 2   |
| 16             | 11.0             | 10.0                  | 1523   | 1528                                  | 5   |
| 17             | 11.2             | 10.6                  | 1553   | 1543                                  | 10  |
| 18             | 11.2             | 10.0                  | 1537   | 1525                                  | 12  |
| 19             | 13.3             | 14.2                  | 1522   | 1499                                  | 23  |
| 20             | 13.3             | 12.8                  | 1500   | 1501                                  | 1   |

The average difference between the calculated and the observed slag temperature is 12°. The maximum error occurs in the case of furnace 10 for which furnace the observed slag temperature, 1449°, is lower than the observed metal temperature, 1456°. This points to an error in observation or to an irregular furnace. If this furnace be omitted from the list the average difference between the calculated and observed slag temperatures is only 10° C.

The significance of this calculation is important. It ties the three kinds of temperatures together. The actual slag temperature being a result of mixing, on an average, 2 lb. of coke ash at 1700° C. with 8 lb. of gangue plus flux at 1450° must lie 20 per cent. of the distance between 1450° and 1700°; *i.e.*, 1500°. The fact that the law of mixture holds with an accuracy of 10° is surprising. Leaving out the inaccuracy of the furnace records, we have left only an average error of 10° to be split between the slag, metal, and tuyere temperature readings. An error of 10° in tuyere temperature will cause an error of but 2° in slag temperature. The probable division of error would be 2° to the metal, 5° to the slag, and 15° to the tuyeres.

## Pyrometry and Steel Manufacture

BY A. H. MILLER, PHILADELPHIA, PA.

(Chicago Meeting, September, 1919)

TEMPERATURE considerations are of prime importance in the manufacture of steel products—from the time the metal is produced in the melting furnace, where the chemical reactions have a direct dependence on the temperatures of the bath, to the final machining of work on which the expansion due to the rise in temperature of the forgings during machining must be allowed for. Methods employed and difficulties encountered in some of the more important steps are here outlined. These methods are the result of years of experience, with many methods of temperature determination, and have been successful in routine works practice in the manufacture of high-quality steels.

In the operations of melting, forging, and heat treatment, if the product is to be of the best quality each operation must be carefully followed through. A high-quality product cannot be obtained even with the best heat treatment if the steel is poorly melted, and, conversely, the best steel ever made may be spoiled by inefficient heat treatment. To perform the best work in any of these operations, temperatures must be accurately regulated.

### MELTING TEMPERATURES

In the regulation of steel melting temperatures, open-hearth furnaces will be taken as presenting typical difficulties in temperature determination. If accurate methods of temperature determination can be evolved for use in the open-hearth furnace, the same methods will be as successful in the crucible or electric furnace process. Possibilities as to methods are: by means of optical pyrometers, by means of thermocouples, and by means of arbitrary standards which may possibly employ either of the other two methods as an auxiliary.

*Optical Pyrometer.*—In regard to optical-pyrometer determinations, the difficulties are the lack of black-body conditions in the furnace and the fact that it is only with great difficulty that the steel in the bath may be observed.

Lack of black-body conditions is responsible for considerable inaccuracy in taking measurements, although this source of error may not be great enough to condemn the method. The fact that the steel itself cannot be observed is, however, of prime importance. Such data as have

been obtained indicate that the slag covering of the bath may differ in temperature from the steel by as much as 200° F. (94° C.) and that the walls or roof of the furnace may show even a greater variation. Temperature determinations, by means of the optical pyrometer, may be made on small samples of the steel lifted from the furnace and poured with the optical pyrometer sighted on the stream. Having measured the elapsed time between taking metal from the bath and sighting the optical pyrometer, the temperature of the bath may be deduced by extrapolation. A series of such measurements should be taken to arrive at an approximation of the temperature of the bath. Another method of obtaining similar measurements is to lift a spoon of metal from the bath and pour it immediately into a small test mold, readings being taken on the surface of the metal in this test mold at definite intervals of time until the surface of the metal freezes. Having taken time intervals with a stop watch simultaneously with the optical-pyrometer readings a curve can be drawn which, extrapolated back to the time when the metal was removed from the bath, will give an approximation of the bath temperature. It is probable that these two methods arrive at as close an approximation to an accurate bath temperature as we may at present obtain.

An effort has been made to obtain true bath temperatures by inserting in the bath an iron tube, well protected by fireclay sleeves, and having a thin wall graphite tip. After this tube has remained in the bath for a short time, the interior surfaces of the graphite tube reach the temperature of the bath, which temperature may be read through the hollow tube by means of an optical pyrometer. This method is mechanically clumsy and is attended by considerable discomfort to the operator because he is necessarily in close proximity to the furnace while taking readings. It might become successful but for the fact that it has been impossible to obtain refractories that will withstand the temperature involved and will give off no fumes at this temperature. Such fumes cause variable pyrometer readings that cannot be corrected for. In using the optical pyrometer for pouring temperatures, inaccuracies arise because of difficulty in being sure whether the point sighted on is steel or oxide. Possible inaccuracies in the emissivity factors of steel, slag, and oxide are also sources of error.

*Thermocouple.*—The use of the thermocouple in determining open-hearth furnace temperatures is attended by the difficulty of inserting the thermocouple to the point at which the temperature is desired. The platinum-platinum-rhodium couple seems to be the best of any in common use but if this couple is not thoroughly protected from furnace gases its calibration will quickly change. It is probable that, even with perfect protection, the calibration will change a prohibitive amount at the high temperatures used. The best use for the thermocouple seems to be the

secondary one—of obtaining temperatures elsewhere than in the bath itself, and deducing temperatures of the bath from these. The method of placing the thermocouple in the slag pocket and at various points in the checkers and at the base of the stack has been tried, but because of variations in the furnace operation it is not believed that bath temperatures can be accurately deduced from data at these points, although useful knowledge as to the furnace working may be obtained.

*Use of Arbitrary Standards.*—The use of arbitrary standards has been widely employed. Metal may be poured from a test spoon into certain standard molds and the temperature of the bath deduced from observing this metal. This may be done by measuring the rise of temperature of a protected thermocouple inserted in the molten metal, by sighting an optical pyrometer on the surface of the metal in the test ingot or on the stream from the spoon while pouring, by measuring the length of time required for the surface of the metal in the test ingot to freeze, etc. All of these methods present numerous inaccuracies, and it is doubtful whether, in the present state of pyrometry, there is a method that can equal the accuracy with which an experienced melter can estimate the bath temperatures. It has been found that such a melter can estimate temperature changes to within an accuracy of 10° to 20° F. It is true that this estimation of temperature differences is far from being the same thing as the estimation of temperature, as the results cannot be recorded for reference nor can they be transmitted from one plant to another or even from one man to another. It is also true that the "condition" of an open-hearth bath depends on other things than temperature; such things as the state of the slag, the amount and quality of the additions, and the time factor, which is of quite as great importance as the temperature.

It is fortunate that in the melting and pouring of open-hearth steel certain natural phenomena give temperatures with great accuracy, that are a very close approximation to the desired temperatures. During the first part of the melting, while the first elimination of impurities is in progress, it is well to have the temperature as high as possible, with safety to the furnace. The melting point of the firebrick employed in the furnace roof is therefore a very close measure of the temperature to be attained. A skilled operator can, by observation, determine the point where the firebrick will glaze slightly but will not actually melt, and will run his furnace to this heat. In teeming a heat, on the other hand, correct temperatures of pouring may be accurately regulated by the appearance of the film or crust that forms on the surface of the metal rising in its molds. The appearance of this film is quite characteristic and, with practice, the temperature, or rather, the fact that the metal is at, above, or below the correct temperature, may be very accurately stated. It may also be regulated at this point, to a certain extent, by varying the rapidity

of pouring, according to the appearance of the metal rising in the mold. By careful observation of such natural phenomena, temperature differences may be estimated to within  $10^{\circ}$  to  $20^{\circ}$  F.

*Recapitulation.*—During the melting, the temperature (or rather, the correct temperature) can be estimated as closely as it can be read by any pyrometric methods now in use. The best methods of temperature determination are by means of the optical pyrometer or a thermocouple at some place other than in the bath. During the pouring, the correct temperature can be quite accurately estimated, but for record, optical pyrometer readings are of value.

### FORGING TEMPERATURES

In the determination of forging temperatures, both optical pyrometers or thermocouples are used. If the thermocouple is used, either platinum-rhodium or a nickel-chrome alloy couple is valuable. Because of the difficulty in protecting platinum-rhodium couples, especially in comparatively large work where the thermocouple must be long, the nickel-chrome couple seems to be preferable. It is quite difficult to regulate accurately the temperature of the pieces to be forged, because the hot gases and flame in the furnace affect the couple much more rapidly than they do the piece. For reasons of economy and because of the size of ingots in heavy work, this difference is of much greater importance than it is in heat-treatment work. Iron-constantan couples have been successfully used, but the life of this couple at forging temperatures is very short, and the accuracy of the couple is lower than at temperatures to which it is better fitted.

The optical pyrometer seems to be the best type for measuring forging temperatures. With some of the later improved types, temperatures can be determined with a very fair degree of accuracy (we believe to within  $25^{\circ}$  F.) in ordinary works practice. To reach this accuracy, the operator must have had a certain amount of experience (2 wk. is ample for a man of average intelligence) and must sight his instrument on parts of the forging that will give an approach to black-body conditions. He must avoid the influences that will cause inaccuracies in his readings; such influences, for instance, as a flame playing so that it will be reflected directly from the piece to his instrument or the presence of smoke in the furnace. In a good forge furnace, this is not difficult to do.

The proper forging temperatures of various grades of steel differ quite widely. A skilled heater can, by observation, regulate his forging temperatures fairly well; he cannot, however, reach the uniformity and accuracy that may be attained by the use of the optical pyrometer. The difficulties involved in using such a pyrometer in forging work are the difficulty in training the operator to sight his instrument properly

and the mechanical difficulties in the construction of the instrument itself. These mechanical difficulties are caused by the necessarily rough usage that obtains in taking these temperatures, together with the necessarily smoky and dirty atmosphere surrounding a forge and the high temperatures to which the instruments are exposed during use (by exposure to radiation from open furnace doors, etc.). Numerous mechanical repairs are necessary to keep the instrument in a good working order. To sum up, the optical pyrometer stands in a class by itself for the regulation of forging temperatures.

### HEAT TREATMENT

The temperatures involved in the heat treatment of steel objects must be very accurately determined and uniformly followed. This temperature is within the range that is difficult to estimate by the eye and at the same time it must be most accurately followed. Most of the higher grades of steel require treatments that involve a quench; most of the alloy steels require a preliminary treatment before the final quench is given and also require a drawing treatment after the quench. With the preliminary treatment, which is ordinarily at a comparatively high temperature (in the neighborhood of 1550° to 1650° F.—843° to 898° C.) the limits of accuracy are not so close as they must be in the final quench, which, for the purpose of obtaining the best possible grain refinement, must be above the critical temperature but as close to it as is possible. The temperature of the draw, also, must be quite accurately approximated, especially if the results desired are to obtain the maximum degree of softness. Optical pyrometers have been used in the determination of heat-treatment temperatures, but with mediocre success. The general tendency has been to rely entirely on thermocouples for this work, at least for temperatures above 900° F. (482° C.). For lower temperatures, if the pieces are small enough to be treated in a bath of oil or melted salts, a direct reading gas or vapor expansion thermometer is simple, accurate, and gives but little trouble.

*Recapitulation.*—It seems that the estimation of temperature is entirely inadequate for an efficient heat treatment, and that the best measurement methods involve the use of thermocouples, except for low temperatures, attained in a bath, in which case gas or vapor expansion instruments are valuable.

### CHOICE OF INSTRUMENTS

*Optical Pyrometers.*—The true optical pyrometer is better for works use than the radiation pyrometer, because imperfection of black-body condition or smoky conditions affect its readings less. The Morse or

Wanner types of optical pyrometers are most reliable, and particular care must be exercised to select an instrument of the simplest and most rugged construction possible.

*Thermocouples.*—A choice must be made between various types of thermocouples and various types of instruments for measuring the electromotive force generated by those couples. In choosing a couple, it is necessary to consider the accuracy of the couple, the constancy, the life, and the cost. Some years ago, platinum-platinum-rhodium couples were used almost exclusively. It is well known that the calibration of the platinum-platinum-rhodium couple changes quite rapidly when the couple is subjected to the influence of furnace gases, but it is difficult to protect a platinum couple from this influence in works practice and it is practically impossible to do so when the thermocouple must be over 5 ft. in length. When platinum couples are used in works practice, an effort is made to protect them by either porcelain or silica containing tubes.

In steel works practice, where the work is generally large, almost all the couples are at least 4 ft. (1.2 m.) long and the majority are from 5 to 7 ft., in some they are as long as 17 ft. The practice with platinum-platinum-rhodium couples therefore involves the recalibration of the couple after each failure of the silica or porcelain tube; and couples over 5 ft. long must be recalibrated after every heat. Although this recalibration becomes a quite simple matter, the work is considerable and the contamination of the couples and consequent breakage makes their operation very expensive. The calibration is performed by taking a check temperature at the gold melting point, using a small electric furnace and the wire method.

With the advent of base-metal couples, of which the iron-constantan couple or the nickel-chrome type seem to be the most popular, the use of long platinum couples is entirely eliminated. In using base-metal couples, however, certain precautions must be taken. All couples, and particularly base-metal couples, are subject to errors due to parasite currents induced by heterogeneity in the wire of which the couple is made. This lack of uniformity is almost invariably set up at a point between the hot and cold junctions of the couple somewhere in the furnace wall, due to the conditions of strain set up at this point. Once established this condition is almost impossible to eliminate. However, while these parasite currents exist in practically all couples that have seen long service, the error involved is small enough to be negligible if the position of this strained portion is unchanged or if it is continually advanced from a lower to a higher temperature. In practice, this means that the accuracy of the couple is unchanged as long as the couple remains immersed to the same depth in its furnace, or as long as it is advanced deeper and deeper into its furnace. Errors, however, are often caused if the couple is

partly withdrawn from its furnace. Because of this fact, if couples are removed from their working position and checked in a laboratory, the checking often shows an error whereas the couple in its working position was actually giving accurate readings. If careful attention is given to these provisions and to the electrical insulation of the couple, an iron-constantan couple will give constant readings to the approximation of 10° F. until it is completely worn out by oxidation or other causes. In the platinum-platinum-rhodium couple, the condition of the metal that produces parasite currents may be destroyed by a careful annealing of the couple. This anneal may be carried on by passing through the wire an electric current sufficient to heat the couple to a point well above its normal use. Parasites set up in the heavier base-metal couples are, however, almost impossible to eliminate. An iron-constantan couple showing such parasites has been heated to successive temperatures of 2000°, 1900°, 1800°, 1700°, etc., down to 500° F. (1093 to 260° C.), each of these temperatures having been held for approximately 1 hr. and each temperature followed both by a quench and a slow cool, without entirely eliminating the inaccuracy.

For any approach to accuracy on the part of any type of thermocouple, cold-junction temperatures must be allowed for and corrected, or controlled. Control may be by means of an ice bath or other method of keeping the cold junction at a uniform temperature. One of the more simple and widely used methods is to place the cold junction underground to a depth at which the temperature is assumed to be uniform. This method is quite desirable, but for the highest degree of accuracy is inadequate. Temperatures even 5 ft. (1.5 m.) underground may vary considerably with the season of the year and with the previous working of the furnace. An excellent method of taking care of this cold-junction correction is to employ lead wires of the same composition as the couple wires, which virtually lengthens the couple to the combined length of couple and leads, bringing the resulting cold junction to the measuring instrument.

The measuring instrument is likely to be at a point where temperatures are more nearly uniform and where the cold junction can be more readily measured and cared for. There is the added advantage that, where a number of couples are being read on one instrument, the correction for these couples will be identical. A number of measuring instruments at present on the market take care of this correction, either automatically or by means of a simple adjustment on the instrument, with highly satisfactory results.

In the selection of the measuring instrument, we have three types of instruments to consider: the galvanometer type, the potentiometer type, and a type combining, to a certain extent, the theory of both of these. The galvanometer type is much the simplest and is less liable to



personal error than either of the others because no adjustments are required. It is simply necessary to read the temperature directly from the face of a dial. However, there are defects in the galvanometer method that are inherent and can never be eliminated, even though they may be reduced to amounts said to be negligible. The galvanometer measures the current produced in the circuit of which the couple is a part, not the electromotive force generated by the couple; because of this, any variation in resistance of the circuit must produce a variation in the current and, consequently, in the reading of the galvanometer. There must be a change in the total resistances of the circuit with any change in the resistance of the couple itself, due either to wasting away of the wires by oxidation or to temperature changes in the couple, and there must be a change in the total resistance of the circuit due to any temperature-resistance change in the lead wires. There is also a change due to variation in the resistance of the instrument itself with temperature change, because in all high-class galvanometers, the electrical resistance is in two parts, one of which has a high-temperature coefficient and the other a temperature coefficient that approaches zero. In a high-resistance galvanometer, the low-temperature coefficient resistance should be great compared with the total resistance. With the use of such a high-resistance galvanometer, errors due to resistance changes in the circuit are reduced to a minimum. Because of these errors, low-resistance galvanometers for temperature work are not extensively used where accurate work is desired. The modern galvanometer, which is jewel-pivoted in almost all cases, is also subject to errors due to friction of the galvanometer bearings and to changes of calibration of the actual instrument itself, due, for instance, to weakening of the controlling magnetic system.

The potentiometer, in which zero current passes through the couple circuit when readings are taken, eliminates all errors due to variation of resistance in the line, and measures the electromotive force direct. Practically, the potentiometer is not so simple an instrument as the galvanometer and requires more attention to keep it in efficient working order. With very few exceptions, the disorders of potentiometers that cause errors in readings are such that the observer almost invariably sees the errors when they occur and can have his instrument repaired, whereas this condition does not obtain in use of the galvanometer.

#### RECAPITULATON

The determination of temperatures in open-hearth furnace practice is desirable. At the present state of the art it is doubtful whether such temperature determinations as can be made are of actual assistance to an experienced melter in producing high-class steel. The best method of

bath-temperature determination seems to be that of sighting an optical pyrometer either on the surface of a spoonful of metal drawn from the furnace or a stream poured from a spoon. The elapsed time between the drawing of this sample from the bath and the reading of the temperature should be noted and the temperature of the bath deduced from the temperature of the sample and this time.

The determination of temperatures in forging practice is also desirable. Present methods give results greatly superior to the results obtained by estimation by the most skilled forgerman and are of great assistance in forging work. The best method is by sighting the optical pyrometer directly on the article to be forged while it is in its heating furnace.

The determination of temperatures in heat-treatment practice is absolutely essential. No amount of experience and care on the part of an operator will approach the results of modern temperature determinations, and, to obtain uniformly the best results, temperature control must be close. The best method of making such temperature determinations seems to be by the use of a thermocouple of the iron-constantan type, using lead wires of the same composition as the thermocouple, and measuring the electromotive force generated by that thermocouple by means of potentiometers.

#### CALIBRATION AND CHECKING

All temperature-measuring apparatus must be frequently checked for accuracy in works practice. In a large installation, it is well to have a primary temperature standard that is used only under the best laboratory conditions to check one or more secondary standards. This primary standard may consist of a platinum-platinum-rhodium thermocouple with an ice-bath regulation of the cold junction, the electromotive force being measured by an accurate potentiometer. This primary standard should have its calibration made by reference to well-determined fixed points; the melting point of gold and the freezing point of lead are convenient and well-determined points. The secondary standards may be either platinum-platinum-rhodium or base-metal thermocouples and may be carried from point to point of the installation to check the actual working couples under working conditions.

Optical pyrometers should be checked from time to time using a standard couple in (preferably) an electric furnace in which black-body conditions may be made nearly perfect.

If base-metal working thermocouples are purchased with a calibration from the manufacturer, it is well to check this calibration to see that it corresponds to the works standard. If the base-metal couples are purchased (or manufactured) as wire, and are to be calibrated, the following method of procedure is simple and accurate. A sample should be cut from each end of each coil of wire as received, one of these samples selected

at random, and each of the other samples of similar wire joined in turn to it and the electromotive force generated at approximately  $1600^{\circ}$  noted. This electromotive force will be zero if the wire is uniform. Having checked the wire for uniformity, several sample thermocouples should be made up and carefully calibrated, using one of the secondary standards in this calibration; a calibration curve may be drawn from the data thus obtained. One or more of these calibrated base-metal couples, properly protected, should be inserted in a pot of molten lead and all sample couples made from the coils to be calibrated inserted in the same pot and checked direct against the calibrated couples; it will be found that certain of the coils vary from the calibration curve already made. An arbitrary allowable variation from this curve may be selected, and all samples that vary from the standard by more than this arbitrary amount discarded. In making such a calibration for a lot of base-metal couples, it is well to have this lot as large as possible, as it is an extremely difficult matter to reproduce.

The instruments used in determining the electromotive force of the working thermocouples should be frequently checked, even though they may be well cared for and of the most accurate type, not only because even the best instruments are likely to go wrong but because of the moral effect such checking has on the workmen. This frequent checking of instrument and couples may seem to be troublesome and in some cases superfluous. In a large installation it will, however, pay well to have one or more men whose sole duty it is to perform such checks, as the accuracy of the resulting work and the confidence inspired by such careful checking will repay all the effort involved.

## DISCUSSION

RICHARD P. BROWN, Philadelphia, Pa.—Both the thermoelectric and the optical pyrometer have their field. With the optical pyrometer you can secure an indication of the temperature of the metal; with a thermoelectric pyrometer installed, for instance, in the slag pocket, where the temperature indicates about  $2000^{\circ}$  F. ( $1100^{\circ}$  C.) you can secure a record of the temperature which cannot be obtained with an optical pyrometer.

I know of an instance, in Ohio, where the reversals were not made for about 2 hr. during the night because the furnace man fell asleep. Even if an optical pyrometer was used on that furnace and the temperature was up to the required heat, the superintendent on the next day would not have known, possibly, that the furnace was not reversed properly and would have wondered what was wrong. In other words, while the optical pyrometer can be used to good advantage, at the same time a recording pyrometer in a slag pocket is a continuous check on the temperatures

maintained by the furnace man. It might be said that the same result would be secured by an instrument which records the time of operation but, unfortunately, instruments of this kind are too often tampered with. But it is hard to make a recording pyrometer record anything except the actual conditions. There is a field for both instruments.

W. H. BRISTOL, Waterbury, Conn.—Why cannot a thermoelectric couple recorder be tampered with just as easily as a valve?

R. P. BROWN.—Let us assume that a workman wants to take a nap; what is going to happen? The temperature is going to fall off. If the temperature is falling off, it is rather difficult to pull out the thermocouple and make the temperature read higher. It is going to read lower. The truth of the matter is that the average workman does not feel competent to tamper with a recording pyrometer.

### Electric, Open-hearth, and Bessemer Steel Temperatures

BY F. E. BASH,\* CH. E., PHILADELPHIA, PA.

(Chicago Meeting, September, 1919)

WHENEVER electric and open-hearth steel men discuss the relative advantages of their respective methods, the question of temperature is always discussed, so that this paper is written in the hope that definite

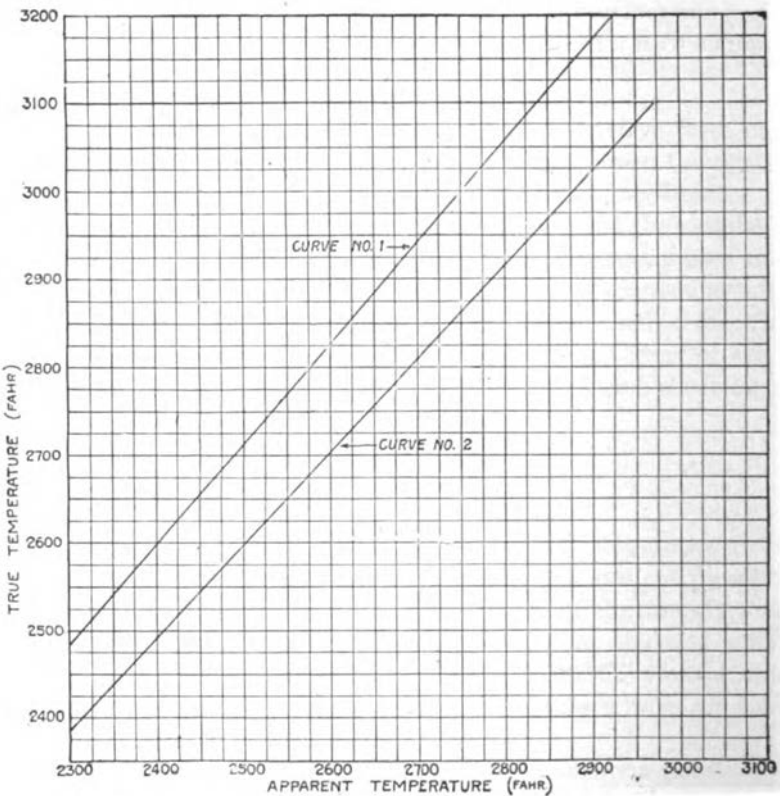

FIG. 1.—EMISSIVITY CORRECTIONS FOR STEEL AND SLAG.  
Curve 1.—Steel. Curve 2.—Slag.

data may settle some of the questions and encourage further investigations along these lines. The writer has had the opportunity of taking the tapping temperatures of steel from electric furnaces of different sizes

\* Research Engineer, Leeds & Northrup Co.

in various plants and from a number of open hearths handling the same kind of steel. All temperature measurements were made with the same disappearing-filament type optical pyrometer and the corrections for emissivity applied were those worked out by Burgess,<sup>1</sup> which are 0.40 for steel streams and 0.65 for slag. The correction is applied by calculating the curve giving the relation between the true and apparent temperature in the following formula:

$$\text{Log } E = \frac{C_2 \log \epsilon \left( \frac{1}{T_2} - \frac{1}{T_1} \right)}{\lambda}$$

in which  $E$  = emissivity;  $C_2 = 14,500$ ;  $\epsilon$  = base of Napierien logarithms;  $\lambda$  = wave-length of light used =  $0.65\mu$ ;  $T_2$  = true temperature, in degrees absolute;  $T_1$  = apparent temperature, in degrees absolute. The curve showing the relation between true and apparent temperature for steel and slag are given in Fig. 1.

For the purpose of comparison of open-hearth and electric furnaces, there are given in Table 1 the tapping temperatures of two 25-ton Heroult electric furnaces and one 6-ton with one 50-ton acid, one 40-ton basic, and one 65-ton acid open-hearth furnace, all making nickel ordnance steel for guns. The two 25-ton Heroult electric furnaces were finishing steel refined by the triplex process and the 6-ton Heroult finished steel that was partly refined in an open hearth. In this table, the tapping temperature and the temperature of the steel stream into the first ingot mold are given together with the mean of each column. The values for each plant are the average for a number of heats.

TABLE 1.—*Tapping Temperatures of Steel*

| Steel Co.                      | Tapping Temperature, Degrees F. | First Ingot, Degrees F. | Type of Furnace            |
|--------------------------------|---------------------------------|-------------------------|----------------------------|
| A.....                         | 2867                            | 2744                    | 25-ton Heroult electric.   |
| B.....                         | 2821                            | 2745                    | 6-ton Heroult electric.    |
| B.....                         | 2821                            | 2721                    | 6-ton Heroult electric.    |
| C.....                         | 2842                            | 2768                    | 50-ton open hearth, acid.  |
| D.....                         | 2877                            | 2753                    | 40-ton open hearth, basic. |
| E.....                         | 2895                            | 2794                    | 65-ton open hearth, acid.  |
| Mean.....                      | 2854                            | 2754                    |                            |
| Mean for electric furnaces.... | 2836                            | 2737                    |                            |
| Mean for open-hearth furnaces  | 2871                            | 2772                    |                            |

The table shows how closely the temperatures agree from plant to plant and in the different types of furnaces. The greatest variation in

<sup>1</sup> Temperature Measurements in Bessemer and Open-hearth Practice. U. S. Bureau of Standards *Tech. Paper* 91 (1917).

580 ELECTRIC, OPEN-HEARTH, AND BESSEMER STEEL TEMPERATURES

tapping temperatures, between *B* and *C*, is only 74° F. (24° C.) while the average for all the electric furnaces is 35° F. lower than for the open-hearths, although it is generally thought that open-hearth steel is tapped colder than electric.

The drop in temperature from the tap to the first ingot depends on the length of time the steel is held in the ladle, the size of nozzle, size and preliminary temperature of the ladle, and various other factors. It is interesting to note, however, that the mean drop in temperature of the steel from tapping to first ingot for both the electric and the open-hearth furnace is 100° F.

In Table 2 is given a tabulation of temperature data taken on two electric furnaces making nickel ordnance steel. At the time these temperatures were taken, the ingots were box poured so that temperature observations were made on the stream above and below the box on the first ingot and below the box on all subsequent ingots. Since there was no satisfactory method of taking temperature of the steel in the furnace, a chill test was made by taking out a small spoon of steel and noting the time required for a crust to form over the surface of the metal therein. These time values are also given.

TABLE 2.—*Summary of Temperatures for Nickel Gun Steel*

| Heat No.  | First Ingot                 |                      |                       | Second Ingot, Degrees F. | Third Ingot, Degrees F. | Chill Test, Seconds | Time Held in Ladle, Minutes |
|-----------|-----------------------------|----------------------|-----------------------|--------------------------|-------------------------|---------------------|-----------------------------|
|           | Tap Temperature, Degrees F. | Over Box, Degrees F. | Under Box, Degrees F. |                          |                         |                     |                             |
| 3×707     | 2895                        | 2793                 | 2737                  | 2722                     | 2705                    |                     | 8                           |
| 3×710     | 2880                        | 2842                 | 2790                  | 2797                     | 2770                    | 26                  | 5½                          |
| 3×711     | 2850                        | 2761                 | 2730                  | 2747                     | 2761                    | 37                  | 5                           |
| 3×715     | 2917                        | 2843                 | 2768                  |                          |                         | 40                  | 8                           |
| 3×719     | 2830                        | 2805                 | 2737                  |                          |                         | 31                  | 6                           |
| 3×723     | 2805                        | 2745                 | 2720                  | 2680                     |                         | 35                  | 5½                          |
| 4×651     | 2872                        |                      | 2761                  | 2752                     | 2728                    | 38                  | 7                           |
| 4×659     | 2865                        |                      | 2797                  | 2745                     | 2761                    | 33                  | 8                           |
| 4×666     | 2872                        | 2813                 | 2768                  | 2730                     |                         | 27                  | 5                           |
| 3×727     | 2835                        | 2775                 | 2705                  | 2680                     | 2697                    | ?                   | 7                           |
| 2×3146    | 2910                        |                      | 2730                  | 2730                     | 2730                    |                     |                             |
| Mean..... | 2867                        | 2797                 | 2744                  | 2732                     | 2736                    | 33.5                | 6.5                         |

It will be noted that the tapping temperatures vary from 2805° to 2917° F. (1540 to 1603° C.) but that most of them are within + or - 30° F. of the mean. It will also be noted that the temperature of the steel stream into the second ingot mold is a little higher, on an average, than that into the first ingot mold. The reason for this is obvious as the metal lying

next to the bottom of the ladle is colder than the main mass of the molten steel. Similar variations will be noted in taking measurements on the tapping stream from a furnace, as the metal in different parts of the hearth often varies 25° to 30° F. in temperature.

In an effort to find the relation between the tapping temperature of the steel and the time of the chill test, the respective values were plotted on a curve sheet with the result shown in Fig. 2. The curve is anything but a smooth one and shows how unreliable the chill-test method of judging temperatures is. In spite of all care in attempting to draw out the spoon in the same manner each time, the atmospheric conditions, room temperature, and other variables have an influence on the time required for the crust to form.

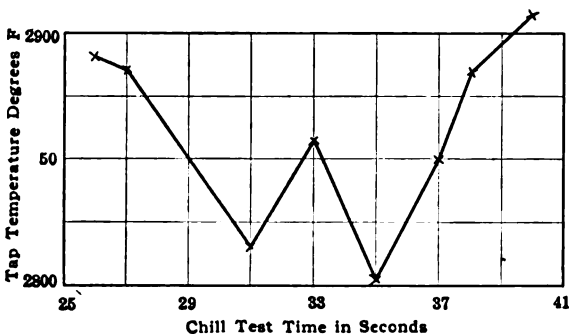

FIG. 2.

In Table 3 are given some temperatures taken on manganese and manganese helmet steel. The observations in this case were difficult to make for the reason that heavy clouds of smoke were given off from the manganese so that the readings had to be made from the windward side and a moment chosen for making the reading when the stream was unobscured. The manganese was melted in a 15-ton Heroult furnace and tapped into a ladle which was then transferred to the open-hearth plant where the manganese was poured into the steel ladle at the time that the steel was tapped..

TABLE 3

| Time, P. M. | Temperature, Degrees F. | Remarks                                    |
|-------------|-------------------------|--|
| 6:04        | 2790                    | Tap manganese from 15-ton Heroult furnace. |
| 6:30        | 2822                    | Tap open-hearth furnace.                   |
| 6:32        | 2849                    | Pour manganese in steel ladle.             |
| 6:34        | 2840                    | Tap open-hearth furnace.                   |
| 6:44        | 2605                    | First ingot manganese steel.               |
| 6:45        | 2605                    | Second ingot manganese steel.              |
| 6:47        | 2647                    | Third ingot manganese steel.               |



582 ELECTRIC, OPEN-HEARTH, AND BESSEMER STEEL TEMPERATURES

An opportunity was presented to take temperatures on steel made by the triplex process, so at the same time blast-furnace tapping temperatures were taken and a record made from the blast furnace to the steel ingot. The practice was to take the molten pig iron to a mixer from which it went to a Bessemer converter, thence to an open-hearth furnace, and finally to an electric furnace for finishing. The mean of readings taken on each operation are set down in Table 4. The value for the Bessemer tap is the mean for ten heats and that for the electric furnace is for eleven heats.

TABLE 4.—*Mean Temperatures from Blast Furnace to Finished Steel*

|    | Temperature, Degrees F.             | Remarks   |
|----|-------------------------------------|---|
| 1  | 2625                                | Mean of metal streams into ladles from blast furnace.   |
| 2  | 2485                                | Mixer metal charged into Bessemer.  |
| 3  | 2909                                | Bessemer tap.   |
| 4  | 2797                                | Charge Bessemer steel to open-hearth furnace.   |
| 5  | 2902                                | Tap open-hearth furnace.  |
| 6  | 2872                                | Charge electric furnace.  |
| 7  | 2867                                | Mean electric-furnace tap.  |
| 8  | 2797                                | First ingot pour above box.   |
| 9  | 2744                                | First ingot pour under box.   |
| 10 | 2732                                | Second ingot pour under box.  |
| 11 | 2736                                | Third ingot pour under box.   |
|    | Temperature Differences, Degrees F. |   |
| 1  | 100                                 | Temperature drop from Bessemer tap to open-hearth charge.   |
| 2  | 25                                  | Temperature drop from open-hearth tap to electric-furnace charge.   |
| 3  | 70                                  | Temperature drop from tap of electric furnace to stream from ladle for first ingot for average of $6\frac{1}{2}$ min. in ladle. |
| 4  | 55                                  | Temperature drop through box.   |

In Fig. 3, the data in this table are presented graphically. The great increase in temperature in the Bessemer converter and other temperature relations are distinctly brought out.

In Table 5 are given data on tapping and tceeming for three open-hearth furnaces in different plants making nickel ordnance steel and one making shell steel. Six 26-in. octagon ingots were poured with large end up, each ingot was individually bottom poured from the 40-ton basic open-hearth furnace. One 63-in., 85-ton octagon ingot was poured and a number of 23-in. octagons were poured from two 65-ton open-hearth furnaces that were tapped simultaneously and poured consecutively.

Beside the temperature measurements on nickel ordnance steel, a number of readings were made on different types of steel in two 10-ton Ludlum electric furnaces. These were taken through the courtesy of Mr. P. A. E. Armstrong, vice-president of the Ludlum Steel Co. The practice was to refine with two or three slags so that it was possible to take readings on the oxidized surface of the molten steel during the skimming and also to get readings on thin slag patches floating on the metal. It was found that readings on the slag patches corrected for an emissivity of 0.65 almost exactly agreed with uncorrected readings on the iron oxide adjacent. In other words, if the radiation from the oxide in the

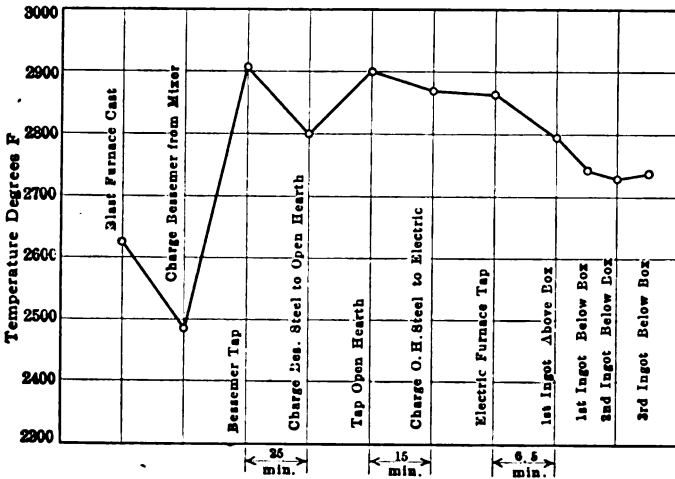

FIG. 3.—TEMPERATURES IN TRIPLEX PROCESS.

furnace with the arc off and the door open is that of a black body, then the emissivity of slag is approximately 0.65, as stated by Burgess. In Table 6 are given a number of readings on different skims made in this manner. It will be noted that the mean values for the two columns agree exactly with each other. If the emissivity of slag is 0.65, then the iron oxide under the above conditions must give black-body radiation for red light.

In Table 7 is given a summary of data taken on tapping and teeming a number of heats. The steel was tapped or poured from the furnace into two ladles and then very quickly teemed into ingot molds.

In order to make sure of the steel temperature in the furnace, a Dixon graphite tube 4 ft. (1.2 m.) long by 4 in. (10 cm.) outside diameter, with a closed end, was pushed into the steel and held there until the end had come to temperature, at which time a reading was made with the optical pyrometer sighted down the axis on the inside of the closed end, which

584 ELECTRIC, OPEN-HEARTH, AND BESSEMER STEEL TEMPERATURES

TABLE 5.—*Open-hearth Steel Temperatures on Nickel Ordnance Steel*

| Time                                    | Temperature, Degrees F. | Remarks   |
|---|-------------------------|---|
| <b>50-ton Acid Open-hearth Furnace</b>  |                         |   |
| 11:55                                   | 2842                    | Tap steel.<br>Held 10 min. in ladle.              |
| 12:12                                   | 2768                    | Four ingots bottom poured in sets of two.         |
| 12:19                                   | 2768                    | Pour first two ingots.<br>Four second two ingots. |
| <b>40-ton Basic Open-hearth Furnace</b> |                         |   |
| 4:10                                    | 2877                    | Tap steel.  |
| 4:21                                    | 2713                    | First ingot.                                      |
| 4:22                                    | 2722                    | Tong hold.  |
|   | 2753                    | Second ingot.                                     |
|   | 2722                    | Second ingot.                                     |
|   | 2722                    | Third ingot.                                      |
|   | 2705                    | Third ingot.                                      |
|   | 2713                    | Fourth ingot.                                     |
| <b>65-ton Acid Open-hearth Furnace</b>  |                         |   |
| 8:33                                    | 2895                    | Tap one furnace. Other tap not recorded.          |
| 8:43                                    | 2835                    | Stream from ladle to runner.                      |
| 8:44                                    | 2843                    | Stream from ladle to runner.                      |
| 8:47                                    | 2768                    | Stream into headbox.                              |
| 8:47½                                   | 2737                    | Stream into headbox.                              |
| 8:48                                    | 2688                    | Stream from headbox.                              |
| 8:51                                    | 2761                    | Stream into headbox.                              |
| 8:56                                    | 2761                    | Stream into headbox.                              |
| <b>Second Ladle</b>                     |                         |   |
| 9:00                                    | 2753                    | Stream into headbox.                              |
| 9:01                                    | 2761                    | Stream into headbox.                              |
| 9:04                                    | 2761                    | Stream into headbox.                              |
| 9:06                                    | 2745                    | Stream into headbox.                              |
| 9:09                                    | 2737                    | Stream into headbox.                              |
| 9:12                                    | 2768                    | Stream into headbox.                              |
| 9:20                                    | 2745                    | Stream for four 23-in. octagons.                  |
| 9:21                                    | 2620                    | Steel rising in mold one-third full. Light smoke. |
| 9:22                                    | 2782                    | Stream to group of 23-in. octagons.               |
| 9:25                                    | 2813                    | Stream to group of 23-in. octagons.               |
| 9:29                                    | 2828                    | Stream to group of 23-in. octagons.               |
| 9:30                                    | 2745                    | Stream to group, dark streak, good.               |

*Table 5.—Open-hearth Steel Temperatures on Nickel Ordnance Steel  
 (Continued)*

| Time  | Temperature, Degrees F. | Remarks                                       |
|---|-------------------------|---|
| <b>65-ton Acid Open-hearth Furnace,<br/>Nickel-chromium Steel</b> |                         |   |
| 1:37  | 2879                    | Tap steel.                                    |
|   | 2895                    | Tap steel.                                    |
|   | 2910                    | Tap steel.                                    |
| Teem  |                         |   |
| 1:44  | 2835                    | First group (8 tons to a group, four ingots). |
| 1:45  | 2828                    | First group.                                  |
| 1:49  | 2835                    | Second group.                                 |
| 1:55  | 2790                    | Fifth group.                                  |
| 2:01  | 2775                    | Sixth group.                                  |
| 2:03  | 2753                    | Seventh group.                                |

NOTE.—Acid furnace on shells, 3-in. nozzle; carbon, 0.60; chromium, 2.25; nickel 3.5.

**TABLE 6.—Summary of Data on Slag Skimming**

| Optical Reading on Slag Patch Corrected,* Degrees F. | Optical Reading on Iron Oxide, Degrees F. | Remarks                |
|--|---|------------------------|
| 2611   | 2618                                      | H. S.                  |
| 2621   | 2629                                      | XIC.                   |
| 2611   | 2618                                      | C. S.                  |
| 2718   | 2709                                      | C. S.—refractory slag. |
| 2628   | 2618                                      | C. S.                  |
| 2532   | 2562                                      | C. S.—cold.            |
| 2728   | 2694                                      | C. S.—same heated.     |
| Mean   | 2636                                      |                        |

\* Burgess' value of 0.65 for emissivity of slag used.

was in the steel. Under these conditions, the reading in the tube should give the true temperature of the steel. One such reading was taken just before a tap and is recorded in the table. It is only 17° F. below the temperature read on the steel stream, which is a very good agreement. Readings made on the slag surface in the furnace before the tap do not agree so well with readings on the stream, as is also shown.

Further readings in a graphite tube were made at another time. The arc had been off for about 10 min. and the door was opened just

586 ELECTRIC, OPEN-HEARTH, AND BESSEMER STEEL TEMPERATURES

TABLE 7.—Summary of Ludlum Temperature Data

|               | Temperature in Furnace, Degrees F. | Reading on Steel Tapping Corrected, Degrees F. | Reading on Slag Tapping Corrected, Degrees F. | First Ingot, Degrees F. | Last Ingot, Degrees F. | Remarks           |
|---------------|------------------------------------|--|---|-------------------------|------------------------|-------------------|
| Arc off, slag | 2815                               | 2797   | 2792  | 2746                    | 2640                   | First ladle—C.S.  |
|               |                                    |  |   | 2770                    | 2746                   | 2625              |
| Arc off, slag | 2789                               | 2737   |   | 2700                    | 2625                   | First ladle—XIC.  |
|               |                                    | 2686   | 2652  | 2670                    | 2597                   | Second ladle—XIC. |
| Tube          | 2673                               | 2730   | 2711  | 2653                    | 2580                   | First ladle—C.S.  |
|               |                                    | 2686   | 2675  | 2617                    | 2550                   | Second ladle—C.S. |
| Arc (slag) on | 2946                               | 2690   |   | 2650                    |                        | First ladle—C.S.  |
|               |                                    | 2633   | 2646  |                         |                        | Second ladle—C.S. |
|               |                                    | 2716   |   | 2677                    | 2597                   | First ladle—XIC.  |
|               |                                    | 2677   |   | 2637                    | 2620                   | Second ladle—XIC. |
|               |                                    | 2790   | 2751  | 2723                    | 2662                   | First ladle—H.S.  |
| Arc (slag) on | 2946                               | 2759   |   | 2651                    | 2661                   | Second ladle—H.S. |
|               |                                    | 2745   |   | 2732                    | 2699                   | First ladle—XIC.  |
|               |                                    | 2717   |   | 2692                    | 2611                   | Second ladle—XIC. |

DEGREES F.

1. Mean drop from tapping temperature to first ingot (max. 108°, min. 13°) . . . . . 36
2. Mean drop from first to last ingot, for 5-ton ladle . . . . . 62
3. Mean temperature for first ladle tap . . . . . 2743
4. Mean temperature for second ladle tap . . . . . 2704
5. Mean difference between first and second ladles . . . . . 39

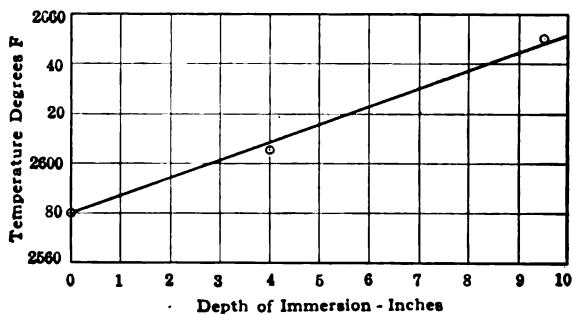

FIG. 4.

sufficiently to allow the tube to be inserted. A reading was made on the thin slag surface beside the tube and then in the tube at two different depths which were calculated from measurements of depth of immersion of the tube. The readings are given in Table 8 and are plotted in Fig. 4; they show the temperature gradient of the steel bath from the surface to a 9-in. (23 cm.) depth. The top was cooler due to the fact that the arc had been off for a few minutes. This also seems to show

that a reading made on a thin slag surface in a furnace that is enclosed, with the arc off, gives true temperatures.

TABLE 8

| Temperature Read, Degrees F. | Remarks                            |
|------------------------------|------------------------------------|
| 2580                         | On slag surface, arc off 10 min.*  |
| 2606                         | In closed-end tube, immersed 4 in. |
| 2650                         | In closed-end tube, immersed 4 in. |
| 2629                         | Slag surface, arc off.†            |
| 2618                         | Tube in slag.                      |

\* Slag was approximately ¼ in. thick.

† Reading made at a later date than one above.

TABLE 9.—Carbon Steel for Castings

| Time from Start of Tap |         | Temperature, Degrees F. | Remarks                               |
|------------------------|---------|-------------------------|---------------------------------------|
| Minutes                | Seconds |                         |                                       |
|                        | 17      | 2960                    | On slag tapping.                      |
|                        | 28      | 2920                    | On slag tapping.                      |
|                        | 46      | 2982                    | On slag tapping.                      |
|                        | 64      | 2952                    | On slag finish tapping.               |
| 2                      | 30      | ....                    | Started to skim.                      |
| 3                      | 45      | ....                    | Finished skimming.                    |
| 4                      | 45      | ....                    | Finished weighing.                    |
| 5                      | 22      | 2887                    | First shank.                          |
| 7                      | 30      | 2865                    | Second shank.                         |
| 8                      | 20      | 2821                    | Pouring second shank into small mold. |
| 9                      | 13      | 2835                    | Third shank.                          |
| 9                      | 53      | 2797                    | Pouring third shank into mold.        |
| 10                     | 9       | 2797                    | Pouring third shank into mold.        |
| 10                     | 46      | 2828                    | Fourth shank.                         |
| 11                     | 5       | 2782                    | Pouring fourth shank into mold.       |
| 11                     | 43      | 2775                    | Pouring fourth shank into mold.       |
| 12                     | 10      | 2835                    | Fifth shank.                          |
| 12                     | 35      | 2761                    | Pouring fifth shank.                  |
| 13                     | 59      | 2775                    | Pouring from ladle into first mold.   |
| 14                     | 41      | 2730                    | Pouring from ladle into second mold.  |
| 15                     | 15      | 2688                    | Third mold, small stream.             |
| 16                     | 3       | 2782                    | Fourth mold, large stream.            |
| 16                     | 21      | 2768                    | Fourth mold.                          |
| 16                     | 41      | 2761                    | Fourth mold.                          |
| 16                     | 52      | 2753                    | Fourth mold.                          |
| 17                     | 12      | 2761                    | Fourth mold, oxidized stream.         |
| 18                     | 19      | 2753                    | Fifth mold.                           |
| 20                     | 3       | 2797                    | Sixth mold, oxidized stream.          |
| 21                     | 2       | 2745                    | Seventh mold.                         |

At this point the writer wishes to state that the steel poured from these electric furnaces was the coldest of any he has had occasion to take

588 ELECTRIC, OPEN-HEARTH, AND BESSEMER STEEL TEMPERATURES

temperatures on, either open-hearth or electric, and further contradicts any supposition that electric steel is hotter than open-hearth, at least when it is tapped, although it may be hotter during the refining period.

In Tables 9 and 10, temperatures are given for tapping and teeming a 3-ton basic Heroult furnace. The steel was used for castings and for that reason had to be hotter than steel for large ingots. The temperatures given in Table 10 for tapping manganese steel are the hottest of any electric steel the writer has had occasion to take measurements on. However, it is no hotter than open-hearth steel for castings or Bessemer steel for the same purpose, as may be seen by examination of Table 11.

In Tables 9 and 10 it will be noted that there is some fluctuation in the teeming temperatures. This is due to the fact that the steel was poured over the tip of the ladle and was sometimes large and sometimes small. The small stream cooled much more rapidly and as a consequence a lower temperature was read.

TABLE 10.—*Manganese Steel for Castings*

| Time from Start of Tap |         | Temperature,<br>Degrees F. | Remarks       |
|------------------------|---------|----------------------------|---------------|
| Minutes                | Seconds |                            |               |
|                        | 15      | 3053                       | Steel stream. |
|                        | 34      | 3025                       | Steel stream. |
|                        | 52      | 3025                       | Steel stream. |
| 1                      | 14      | 3037                       | Steel stream. |
| 1                      | 38      | 3025                       | Steel stream. |

TABLE 11.—*Temperature Observations on 3-ton Acid Bessemer Converter*

| Time                     |         | Temperature,<br>Degrees F. | Remarks                      |
|--------------------------|---------|----------------------------|------------------------------|
| Minutes                  | Seconds |                            |                              |
| 2:07                     |         | 2433                       | Charging Bessemer on stream. |
| Time after Start of Blow |         | Temperature,<br>Degrees F. | Remarks                      |
| Minutes                  | Seconds |                            |                              |
| 2                        | 50      | 2574                       | Flame from Bessemer.         |
| 3                        | 10      | 2632                       | Flame from Bessemer.         |
| 3                        | 37      | 2722                       | Flame from Bessemer.         |
| 4                        | 10      | 2824                       | Flame from Bessemer.         |
| 5                        | 12      | 2860                       | Flame from Bessemer.         |
| 6                        | 43      | 2747                       | Flame from Bessemer.         |
| 7                        | 18      | 2752                       | Flame from Bessemer.         |
| 8                        | 0       | 2527                       | Ferromanganese into ladle.   |
| 9                        | 32      | 3060                       | Tap Bessemer.                |
| 11                       | 53      |                            | Finish tap.                  |

As a matter of curiosity, a set of readings with the optical pyrometer on the flame from a 3-ton acid Bessemer converter was taken. The hottest portion of the flame was selected for the balance for each reading and the time noted with a stop watch. The temperatures found have no particular value, as the temperature of a flame as determined with an optical pyrometer depends on its thickness. It is interesting to note however, how the temperature values increase to a maximum and then decrease. The readings are given in Table 11.

In conclusion the writer hopes that the data presented in this paper will be of some value in starting further investigations along the lines of control of molten steel temperatures and the effects of pouring temperatures on quality of steel.

The writer also wishes to thank Mr. G. H. English, formerly Lieutenant of the Ordnance Reserve Corps, for the opportunity to take temperatures on ordnance steel; Mr. A. H. Miller, of the Midvale Steel Co., for access to steel furnaces on many occasions; and Mr. Knox Taylor, president of the Taylor Wharton Iron & Steel Co., for the privilege of making tests at his plant.

#### DISCUSSION

E. S. TAYLORSON,\* Pittsburgh, Pa.—What has just been said brings out one of the disadvantages of the optical pyrometer. It requires two operators to get satisfactory readings. The method may be simplified by using a sensitive recording ammeter. The operator can observe the temperature and as soon as the color match is perfect a key on the telescope can be made to record the temperature and the time as well. This would be well worth investigating, especially in the case of open-hearth practice where the time element must considerably affect the results obtained.

---

\* Research Laboratory, Amer. Sheet & Tin Plate Co.



## Some Thermal Relations in the Treatment of Steel

BY CHARLES F. BRUSH, PH. D., SC. D., LL. D., CLEVELAND, OHIO

(Chicago Meeting, September, 1919)

THE general subject of accurate pyrometry, its great development in recent years, and the importance of its application in arts and manufactures is so ably treated in other papers that this paper will be confined to a résumé of some research work on certain temperature effects in carbon and other steels, some of which appear to be new. The results of these researches are embodied in several papers presented to various scientific societies during the last few years, most of them under the general title of Spontaneous Generation of Heat in Recently Hardened Steel.<sup>1</sup>

Several years ago, when studying the behavior, under certain conditions, of specimens of hardened tool steel, I observed that they all spontaneously generated a small quantity of heat, the rate of generation diminishing from day to day for several weeks before generation became imperceptible in the sensitive calorimeter used. In each case the steel had been hardened only a few days prior to its use. It seemed highly probable that the generation of heat was associated with some sort of "seasoning" or incipient annealing process, perhaps accompanied by slight changes of volume, and that it would be most rapid immediately after hardening. I subsequently investigated this curious phenomenon more fully.

Twelve  $\frac{1}{2}$ -in. round bars of tool steel, 5 in. long and with machined surfaces, were hardened by heating to high cherry red in a reducing atmosphere of a gas furnace and quenched in cold water. The bars then had a thin strongly adhering coating of black oxide. They were next stirred in a large quantity of water at room temperature, to acquire that temperature, wiped dry, and oiled with heavy, neutral mineral oil to prevent generation of heat by further surface oxidation, wiped free of excess of oil and placed in a Dewar jar in the calorimeter. A quantity

---

<sup>1</sup> *Proc. Am. Phil. Soc.* (May-July, 1915) 54.

*Phys. Rev.* [2] (1917) 9.

*Proc. Am. Phil. Soc.* (1917) 56.

*Proc. Royal Soc. Lond.* (1917) A93; joint paper with Sir Robert A. Hadfield.

*Proc. Royal Soc. Lond.* (1918) A95; joint paper with Sir Robert A. Hadfield and S. A. Main.

*Proc. Am. Phil. Soc.* (1918) 57.

of water, also at room temperature, just sufficient to equal the steel bars in thermal capacity had already been placed in another Dewar jar in the calorimeter. The testing device was assembled as quickly as possible, and galvanometer readings commenced within 45 min. of the time of hardening the steel. The upper curve in Fig. 1 shows the progress of heat generation in the steel bars during the first 150 hr. after hardening. A very slow generation of heat was still easily observable at the end of a month.

The temperature of the steel bars was rising rapidly when the galvanometer readings commenced and reached a point (nearly 3° C. at the summit of the curve) where the gain and loss of heat balanced each other in about 8 hr. The normal cooling curve was obtained 5 or 6 wk. after the other, and when the generation of heat had very nearly ceased. For

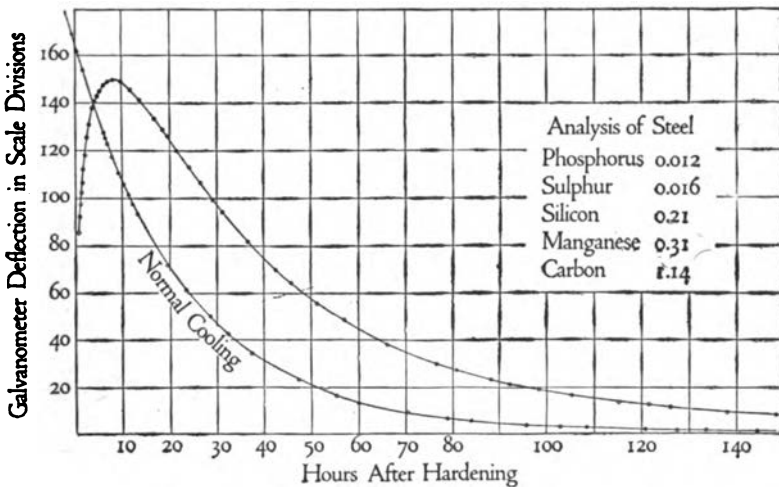

FIG. 1.—CURVES FOR TOOL STEEL.

this purpose the steel bars were removed from the copper cylinder, warmed a few degrees, and replaced; then galvanometer readings were made from time to time as before. This curve is plotted in a location convenient for visual comparison with the heating curve, but might just as well be plotted to the right of it.

From the two observed curves, I have computed a third curve (not shown) which represents the progressive rise in temperature that would have occurred if the thermal insulation of the steel had been perfect, so as to prevent any loss of heat. The curve is strikingly similar in character to the shrinkage curve shown in Fig. 3, and indicates a close association of heat generation and shrinking, to which I shall refer again. The total rise in temperature indicated (about 5° C.) is of little quantitative importance because it is highly probable that it would have been different if

## 592 SOME THERMAL RELATIONS IN THE TREATMENT OF STEEL

the steel had been hardened at a different temperature, or more uniformly hardened throughout each bar, or had a different carbon content. Yet it is interesting to note that the observed quantity of heat spontaneously generated in the steel, measured by its rise in temperature multiplied by its thermal capacity, indicates internal work of some sort sufficient to lift the steel bodily about 800 ft. against the force of gravity.

The same number of bars of high-speed tungsten steel of the same dimensions were water-hardened at white heat, not far below the fusing point, brought to room temperature, oiled, and placed in the copper cylinders, as in the former case, and galvanometer readings were commenced 1 hr. after hardening. Fig. 2 shows the curve of heat generation in the high-speed steel, and the curve of normal cooling located with respect thereto as in Fig. 1. The cooling curve here shown is the lower

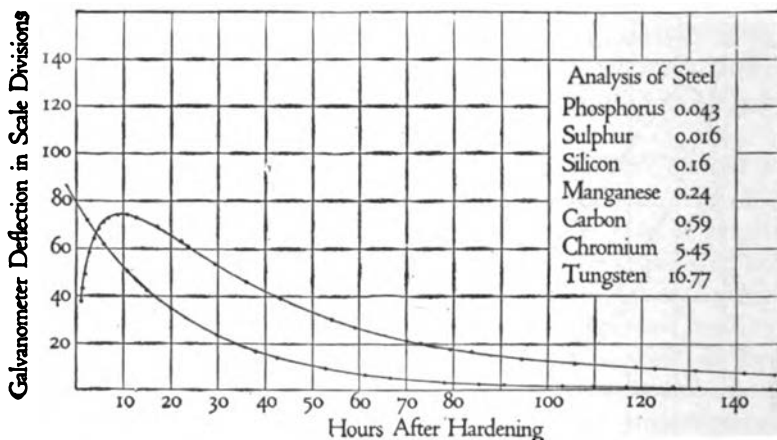

FIG. 2.—CURVES FOR HIGH-SPEED STEEL.

part of that used in Fig. 1. It is permissible to use the same cooling curve for both kinds of steel because the thermal capacity of the two lots was very nearly the same. It is seen that heat generation in the tungsten steel is the same in character as in the carbon steel of Fig. 2, though much less in amount and somewhat more persistent.

### SHRINKAGE OF CARBON STEEL WHEN ANNEALED

Many workers in steel are aware that the metal expands a little when hardened and shrinks when annealed. Having no more of the carbon steel used in the first experiment, I procured another  $\frac{1}{2}$ -in. round bar of the same brand, though slightly different in composition, as the analyses show. With a piece of this bar  $2\frac{1}{2}$  in. long I made a careful determination of its specific gravity under the conditions and with the results here shown.

| SPECIFIC GRAVITY               |        | ANALYSIS OF STEEL, PER CENT. |       |
|--------------------------------|--------|------------------------------|-------|
| Commercial condition.....      | 7.8507 | Phosphorus.....              | 0.015 |
| After hardening.....           | 7.8127 | Sulfur.....                  | 0.021 |
| After tempering to light blue. | 7.8350 | Silicon.....                 | 0.16  |
| After annealing.....           | 7.8529 | Manganese.....               | 0.33  |
|                                |        | Carbon.....                  | 1.07  |

The difference in density and volume between the hardened and annealed conditions is fully  $\frac{1}{2}$  per cent., which is more than I expected to find; and nearly one-half of the total shrinkage was brought about by the very moderate heating necessary for tempering to light blue. The annealing was very thorough, and, as the figures show, was more complete than in the annealed commercial condition. The shrinkage incident to tempering was large enough to encourage the hope that if any spontaneous shrinking, at room temperature, occurs during the generation of heat that follows hardening, it might be detected and measured. Apparatus was

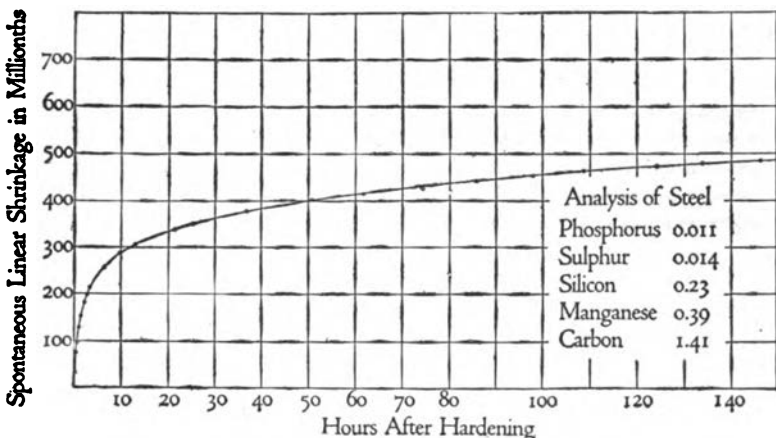

FIG. 3.—SHRINKAGE OF HARDENED STEEL BAR.

designed with which rods 3 ft. long and 1 mm. in diameter were tested. After some preliminary experiments, to get acquainted with the apparatus, a fresh rod was hardened by placing it horizontally in a wooden rack just above a trough of water at room temperature, quickly heating it to bright redness by passing suitable electric current through it, and plunging it in the water beneath, the act of lowering the rod serving to break the electric circuit. The rod was kept straight while hot by means of a weak spiral spring, which took up the expansion. Preliminary experiments had shown that a rod could be hardened in this way without warping. The hardened rod, already at room temperature, was quickly wiped dry and put in place beside the comparison rod. A fine horizontal scratch was immediately drawn across the polished fronts of the bars by means of a straightedge and sharp needle point lightly applied. A microscope, magnifying about 200 diameters and very solidly mounted,

was brought into position and focused on the horizontal scratch, which of course consisted of an independent scratch on each bar, the two halves being initially in perfect register. Shrinkage of the hardened rod was detected within 2 min. after scratching the brass bars, and was easily observable at the end of 2 weeks. Fig. 3 shows the progress of shrinking during the first 150 hr. The curve reached the 500 line a day or two later. The hardened length of the rod was assumed to be 35 in., so that its actual shrinkage at the 500 line of the curve was 0.0175 in.

The rod was next scoured clean and tempered to light straw color by electric warming, then to light blue color, and its total shrinkage measured after each operation. Finally, it was thoroughly annealed by bedding in mineral wool, heating to low redness  $\frac{1}{2}$  hr., and gradually reducing the heating current to nothing in the course of 2 or 3 hr., after which the shrinkage was again measured. The rod shrank considerably in each operation, as indicated in Table 1, in which the annealed length is taken as unity or 100 per cent.

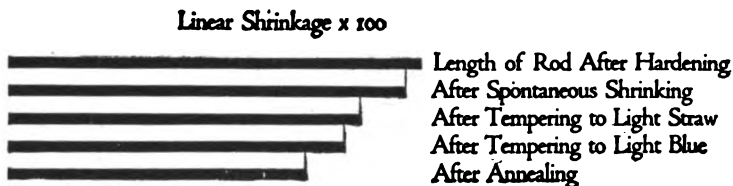

FIG. 4.—SHRINKAGE OF STEEL BAR DUE TO HEAT TREATMENT.

TABLE 1

|                                     | PER CENT. |
|-------------------------------------|-----------|
| Length of rod after hardening.....  | 100.383   |
| After spontaneous shrinking.....    | 100.332   |
| After tempering to light straw..... | 100.182   |
| After tempering to light blue.....  | 100.131   |
| After annealing.....                | 100.000   |

Of course the shrinkage in volume must have been very nearly three times the linear shrinkage, or considerably more than 1 per cent. from the hardened to the annealed condition, which is more than double that observed in the bar steel used in the first experiment. Doubtless this was due to the higher carbon content of the small rod and more uniform hardening, owing to its small size. It is highly probable also that more heat was generated per unit of mass. In Fig. 4 the stages of shrinking of the small rod are shown by magnifying a hundred-fold the observed quantities in Table 1.

I have already pointed out the close similarity in character of the spontaneous-shrinkage curve, Fig. 3, and the computed curve of total heat generation; there seems little room for doubt that the two phenomena are quantitatively related. It is equally clear that spontaneous shrinking is only incident to, and is not the prime cause of the generation

of heat, because the internal work represented by the heat generated is very many times more than sufficient to effect, by compression, the reduction in volume that probably occurred while the  $\frac{1}{2}$ -in. bars were generating heat. Sir Robert A. Hadfield, in the second joint paper referred to, treats the data mathematically and reaches the same conclusion. More recent experiments, some of which show no shrinking during the generation of heat, further confirm it.

An attempt was made to measure Young's modulus of elasticity in the small rod both in the hardened condition (after spontaneous shrinking) and after annealing, by hanging various weights to them and measuring, with the microscope, the distortions produced, always far within the elastic limit. But I was unable to obtain reliable results because of an interesting fact that was brought to light: In the annealed condition, the steel exhibited a small amount of viscosity or internal friction which somewhat delayed full distortion and subsequent restitution; but in the hardened condition the viscosity was many times greater. This is a further illustration of the instability of the hardened steel.

I am led to regard the hardened steel as being in a condition of very great molecular strain somewhat unstable, especially at first. Spontaneous relief of a small portion of the strain causes generation of heat until stability at room temperature is reached. Any considerable rise of temperature, as in tempering, permits further spontaneous relief of strain, or molecular rearrangement, and is doubtless accompanied by more generation of heat, and so on until the annealing temperature is reached. It is obvious that the process of tempering or annealing steel is exothermic and, conversely, that hardening is endothermic.

#### NICKEL-CHROMIUM STEEL

Subsequently, Sir Robert Hadfield sent me two specimens of nickel-chromium steel for further tests. Each specimen consisted of twelve  $\frac{1}{2}$ -in. round bars 5 in. long, with machined surfaces, so that the results obtained would be quantitatively comparable with those of the other kinds of steel previously examined. Specimen A was gradually heated in a gas furnace, with reducing atmosphere, while its magnetic behavior was observed from time to time. For this purpose the bundle of bars was surrounded by a single turn of asbestos-insulated platinum wire, the ends of which were connected with a ballistic galvanometer having the usual mirror and scale. The furnace was surrounded by a large coil of heavy copper wire through which a direct electric current could be established and broken at will by means of a switch and storage battery. Before the steel bars were placed within the platinum loop inside the furnace, closure of the outer copper coil circuit caused a brief electric pulse in the loop and a "kick" in the galvanometer, giving a definite minimum deflection easily observed with considerable precision. With

## 596 SOME THERMAL RELATIONS IN THE TREATMENT OF STEEL

the steel bars inside the platinum loop the galvanometer deflection was, of course, many times greater until, with rising temperature, the decalescent point was approached; then the deflection fell rapidly to the minimum value as above, or very near it. This simple induction apparatus was found entirely reliable and satisfactory.

Susceptibility remained substantially constant until several minutes after cherry-red heat was reached, then fell rapidly to nothing. This was taken to indicate complete decalescence, and the proper temperature for hardening. The furnace was immediately opened and the twelve bars quenched separately in water and crushed ice, then stirred in much water at room temperature, wiped dry, oiled, and placed in the calorimeter used in the earlier experiments.

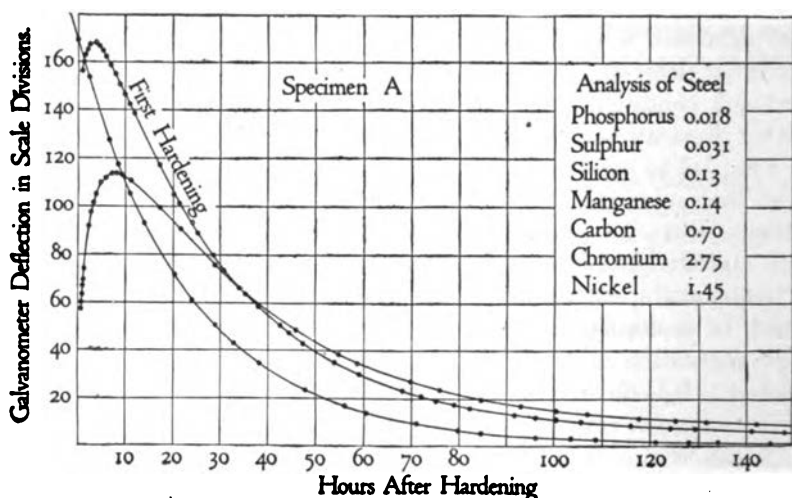

FIG. 5.—GENERATION OF HEAT BY NICKEL-CHROMIUM STEEL AFTER HARDENING.

Fig. 5 shows the progress of heat generation following this first hardening of specimen A of the Hadfield nickel-chromium steel. Rapid generation of heat is indicated, in the early stages, especially during the first hour, and maximum temperature, the point at which gain of heat was balanced by normal cooling, was reached in about  $3\frac{1}{2}$  hr. Obviously the rate of generation had diminished very much by that time and was falling fast, though it still retained considerable value at the end of 150 hr. In general, the curve of first hardening indicates that the rate of heat generation diminished steadily from the moment of quenching the hot steel. Hadfield's analysis of this steel shows chromium 2.02 per cent., nickel 1.98 per cent.

After a week of cooling, the bars were again placed in the furnace and heated to a temperature considerably higher than before by continuing the heating 15 min. after complete loss of magnetic susceptibility.

They were then quenched and treated as formerly. The other curve of Fig. 5 shows the effect of the higher quenching temperature. The total amount of heat generated was not greatly different in the two cases.

Specimen *B* of the Hadfield steel was treated at first precisely like specimen *A*; but in the second hardening was not heated quite so far above the temperature of decaescence. Fig. 6 shows the progress of heat generation. The total amount of heat generated was much greater after the second hardening than after the first, in which respect this specimen differs greatly from the other. Probably this was due to the different carbon, chromium, and nickel content as shown in the analyses of the two specimens. Hadfield's analysis of specimen *B* shows chromium 2.51, nickel 2.81.

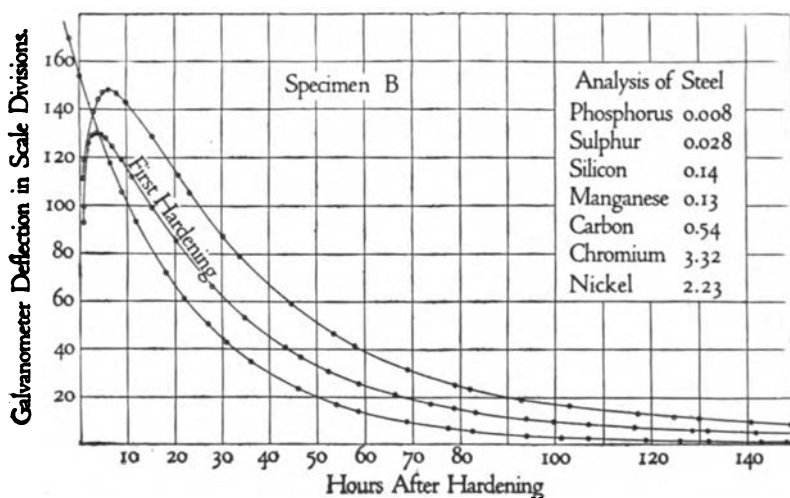

FIG. 6.—GENERATION OF HEAT BY NICKEL-CHROMIUM STEEL AFTER HARDENING.

The effect on specimen *B* of a moderate increase in quenching temperature was so great that it was thought worth while to quench it a third time, at a temperature somewhat lower than in the first hardening, so the temperature of complete recalescence was chosen. While the quenching temperature of first hardening was just above the critical temperature of decaescence, that of the third hardening would lie just below the critical temperature of recalescence. Specimen *B* was, therefore, again slowly heated in the gas furnace until complete loss of magnetic susceptibility was reached; then the supply of gas and air was so far reduced that the furnace very gradually cooled. In about 20 min. the steel commenced to regain its magnetic susceptibility, and a few minutes later had completely regained it. The bars were immediately quenched and treated as formerly.

I had expected to find that the spontaneous generation of heat would



598 SOME THERMAL RELATIONS IN THE TREATMENT OF STEEL

be greatly modified, or possibly eliminated by thus quenching the steel below the critical temperature, because true hardening could not have taken place. But it was not so. On the contrary, about three-fourths as much heat was generated as followed the first hardening, and its curve (not plotted) was parallel throughout with that of the first hardening.

It has been suggested that some, at least, of the spontaneously generated heat found in all my experiments may have been due to chemical action. To meet this criticism I again slowly heated specimen *B* until it began to lose its magnetic susceptibility. This was above the temperature of the previous quenching, and presumably obliterated its effects; it also destroyed the oil, and oily compounds if any, of the previous operation. Then the furnace was closed and, with its contents, allowed to cool 4 hr. The steel bars were then removed from the furnace, still too hot to handle, allowed to air-cool  $\frac{1}{2}$  hr. longer, stirred in much water at room temperature, wiped dry, oiled, and placed in the calorimeter as before. The slow leakage of air into the hot furnace after closing had provided the steel bars with a thin coating of black oxide having the same appearance as that which followed the previous quenchings. The aim of all this procedure was to reproduce as faithfully as possible all the conditions that obtained in previous experiments except quenching.

In all former experiments the temperature of the steel had risen considerably during the assembling of the apparatus immediately following the oiling of the bars, as shown by the curve sheets. But in this case the first galvanometer readings were slightly minus, showing that the steel was about  $\frac{1}{50}^{\circ}$  colder than the balancing water in the other Dewar jar; several days passed before approximate equality of temperature was reached. Hence we may safely say that not the slightest trace of heat was generated in the steel, and that the heat generation observed in former experiments was surely due to the quenching, which arrested transformation.

TABLE 2

| Length of Test Bar               | Specimen A              |                          | Specimen B              |                          |
|----------------------------------|-------------------------|--------------------------|-------------------------|--------------------------|
|                                  | First Hardening, Inches | Second Hardening, Inches | First Hardening, Inches | Second Hardening, Inches |
| After hardening.....             | 5.0274                  | 5.0354                   | 5.0180                  | 5.0151                   |
| After spontaneous shrinking....  | 5.0274                  | 5.0342                   | 5.0180                  | 5.0143                   |
| After tempering to light straw.. | 5.0263                  | 5.0293                   | 5.0172                  | 5.0093                   |
| After tempering to light blue... | 5.0255                  | 5.0293                   | 5.0161                  | 5.0091                   |
| After annealing.....             | 5.0222                  | 5.0250                   | 5.0139                  | 5.0063                   |

Before commencing the experiments, a test bar of each lot was prepared by machining its ends slightly convex and polishing, so as to permit of accurate length-measurements by means of a micrometer caliper easily manipulated to constant end-pressure and easily read to 0.00005 in. The test bars were mechanically held always in the same position between the caliper jaws. Measurements of the test bars were made after various treatments, and the results are shown in Table 2. The error of measurement does not exceed one unit in the last decimal. In neither case was there any spontaneous shrinking after the first hardening, thus demonstrating that the heat generation which then occurred was not due to shrinking.

In both specimens total shrinkage was about twice as great after the second hardening as after the first but was divided between the several treatments quite differently. Comparing the second hardening shrinkages with the first: Considerable occurred spontaneously (none in first); about five times as much followed tempering to light straw, and little or none followed the second tempering, to light blue, though this caused considerable shrinking in both cases of first hardening.

In connection with the first tempering, to light straw color, in both cases of second hardening, an interesting phenomenon was observed: In all cases of tempering to color, the bar was sandpapered bright, very slowly and uniformly heated until the desired color appeared, and then quenched in water at room temperature to arrest progress of tempering; but the bars continued to shrink for several hours. The final, stable measurements are given in the tables. Why no further shrinking occurred when the bars were tempered to light blue is not entirely clear.

The anomalous behavior of specimen *B* of the Hadfield nickel-chromium steel after its third quenching prompted further investigation. In conducting these later experiments an electric furnace was employed for heating, instead of the less convenient gas furnace and the latest form of scleroscope for testing hardness was installed; also, a most modern industrial thermoelectric pyrometer. The latter was used as it came from the maker, without further calibration; hence the temperatures recorded may be several degrees in error, though they are thought to be relatively consistent.

In the annealed condition specimen *B* was found to have a scleroscope hardness of 31. Each scleroscope hardness cited in this paper is the mean of at least ten consistent measurements, each measurement made on a fresh spot of surface carefully made smooth and flat.

In order to ascertain the critical temperatures of decalescence and recalescence of specimen *B*, three of the twelve bars were very gradually heated until almost complete loss of magnetic susceptibility was reached. This occurred rather abruptly at about 777° C. One of the bars was quenched at this temperature, and its scleroscope hardness was found

### 600 SOME THERMAL RELATIONS IN THE TREATMENT OF STEEL

to be 74, which may be taken as the hardness of specimen *B* after the first quenching.

The remaining two bars were allowed to cool very slowly in the furnace until complete recovery of magnetic susceptibility took place at about 660°; recovery was abrupt in temperature. One of these bars was quenched at this temperature, and its hardness was found to be only 37, which is not much above the annealed hardness. This seems conclusive evidence that true hardening did not take place in specimen *B* on its third quenching although good spontaneous generation of heat followed the quenching.

The three bars were again heated to complete decalescence and annealed in the furnace so as to leave all twelve bars of specimen *B* in an annealed condition.

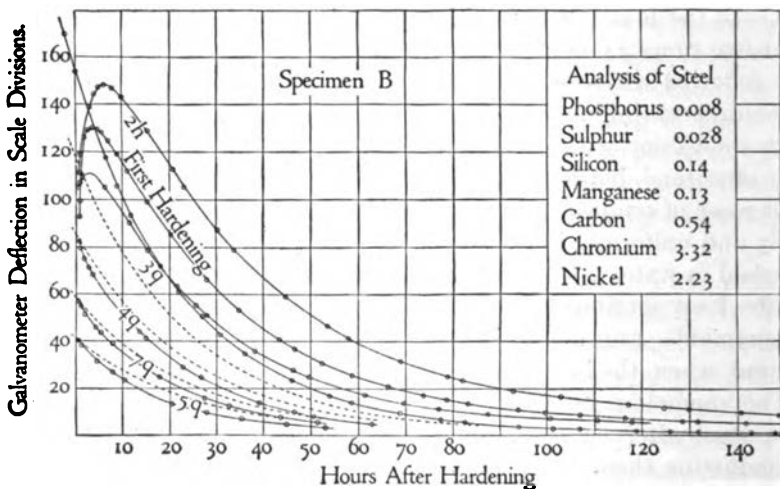

FIG. 7.—EXTENDED CURVE SHEET OF SPECIMEN B.

Fig. 7 is the extended curve sheet of specimen *B*. The curve of first hardening shows the spontaneous generation of heat that followed the first quenching at about 777°, the curve of second hardening, indicated by 2*h*, shows considerably greater generation of heat. Quenching temperature and hardness were not observed; but it is known that the quenching temperature was much higher than 777°. The third curve, showing spontaneous generation of heat, is indicated by 3*q*, meaning third quenching (not hardening). To make it clear that heat was generated in this case the curve of normal cooling is dotted for easy comparison. The quenching temperature in this case must have been slightly below 660° and hardness only about 37.

Specimen *B*, left in the annealed condition at the close of former experiments, with a hardness of 31, was next gradually heated to 554°,

allowed to cool slowly to  $532^{\circ}$  and quenched. It was then purposely brought to a temperature slightly above room temperature and placed in the calorimeter. The progress of cooling is plotted in the curve  $4q$  (fourth quenching). For easy comparison the normal cooling curve is drawn as a dotted line through the first station of the  $4q$  curve. Beyond this point the  $4q$  curve lies everywhere below the normal cooling curve, showing conclusively that the steel cooled abnormally fast. In other words, there was spontaneous disappearance or absorption of heat in the steel, most notable during the first few hours after quenching. Hardness was 35.5.

The steel was next heated to  $562^{\circ}$  and quenched. The result of this treatment is shown in the curve  $5q$ , with its own dotted normal cooling curve. Absorption of heat is again indicated, even greater than in  $4q$  but somewhat differently distributed. Hardness was now 34.5. Again the steel was heated, this time to  $594^{\circ}$ , and quenched. Again there was marked absorption of heat. The curve was almost identical with  $4q$ , and is not plotted, to avoid confusion of lines. Hardness was again 34.5.

The seventh heating was carried to  $667^{\circ}$  for quenching. This was a much larger temperature advance than in either of the preceding experiments, and was above the temperature of the third quenching, which was followed by very considerable generation of heat. But now there was very considerable absorption of heat, as shown in curve  $7q$ . Hardness was now 34.

It should be noted that the quenchings that were followed by absorption of heat were made at rising temperatures which had not been exceeded (except slightly in the case of  $4q$ ) since the steel was annealed. But in the case of the third quenching the quenching temperature was a falling one, reached by cooling from the much higher temperature of decalescence. I can think of no other cause than this for the radically different results of the third and seventh quenchings, which were made at substantially the same temperature. The temperature difference between complete loss and complete recovery of magnetic susceptibility  $117^{\circ}$  was unusually large; but while this temperature drop brought about almost annealed softness, and full restoration of magnetic qualities, it did not very greatly affect that quality of the steel which is responsible for the spontaneous generation of heat. Seemingly, one or more of the several unstable compounds or mixtures of the constituents of the steel formed at the upper critical temperature did not have time to wholly revert to normal annealed condition while the metal was cooling to and passing through recalescence. The time of this cooling was about  $\frac{1}{2}$  hr.

To confirm the curious result of the third quenching, that is, generation of heat without hardening, the bars were quenched the eighth time as follows: Slowly heated (nearly 2 hr.) to  $819^{\circ}$ , slowly cooled

(nearly 1 hr.) to 680° and quenched. During the heating complete loss of magnetic susceptibility occurred at 779°, which was an excellent confirmation of the former finding (777°). But in cooling, full recovery of magnetic susceptibility came at 680°, which is 20° higher than before. The five intermediate treatments may, perhaps, account for this. And

TABLE 3.—*Résumé of Specimen B*

Temperature of complete loss of magnetic susceptibility, 777° C.  
 Temperature of complete recovery of magnetic susceptibility, 660° to 680° C.

|                    | Quenching Temperature Degrees C. | Hardness | Remarks                        |
|--------------------|----------------------------------|----------|--------------------------------|
| First hardening... | About 777                        | 74*      | Good generation of heat        |
| Second hardening.. | Much higher temp.                | ..       | Much larger generation of heat |
| Third quenching..  | About 780-660                    | 37*      | Fairly good generation of heat |
| Annealing.....     |                                  | 31       |                                |
| Fourth quenching.. | 554-532                          | 35.5     | Good absorption of heat        |
| Fifth quenching..  | 562                              | 34.5     | Good absorption of heat        |
| Sixth quenching..  | 594                              | 34.5     | Good absorption of heat        |
| Seventh quenching  | 667                              | 34       | Good absorption of heat        |
| Eighth quenching.. | 819-680                          | 47       | Good generation of heat        |

\* Result obtained from a separate experiment.

this higher quenching temperature may account for the somewhat greater hardness produced, which was later found to be 47, as against 37 for the third quenching (74 for true hardening above decalescent temperature):

Following the eighth quenching there was good generation of heat, better than after third quenching, but differently distributed in time—not so rapid at first, but much better sustained. This appears to confirm the third experiment.

Absorption was rapid during the first few hours, and nearly (not quite) ceased at the end of 50 or 60 hr.; while generation was well marked up to 150 hr. In earlier experiments generation of heat was easily detected at the end of a month.

### CARBON STEEL

As it seemed desirable to learn whether plain carbon steel would show, like the nickel-chromium steel, generation of heat without hardening, or absorption of heat when quenched at rising temperatures below the lower critical temperature, after annealing, the following experiments were made with the carbon steel used for the first experiment. The normal cooling curve and upper curve of heat generation shown in Fig. 8 are taken from Fig. 1.

The steel was quenched at very high temperature, temperature and hardness were not then observed, but recently the scleroscope hardness was

observed, 79. In the second hardening the steel was quenched at 802°, considerably above decalescence, but much lower than in first hardening. Complete loss of magnetic susceptibility occurred at 765°. Hardness was now 73. For the third quenching the steel was heated to 815°,

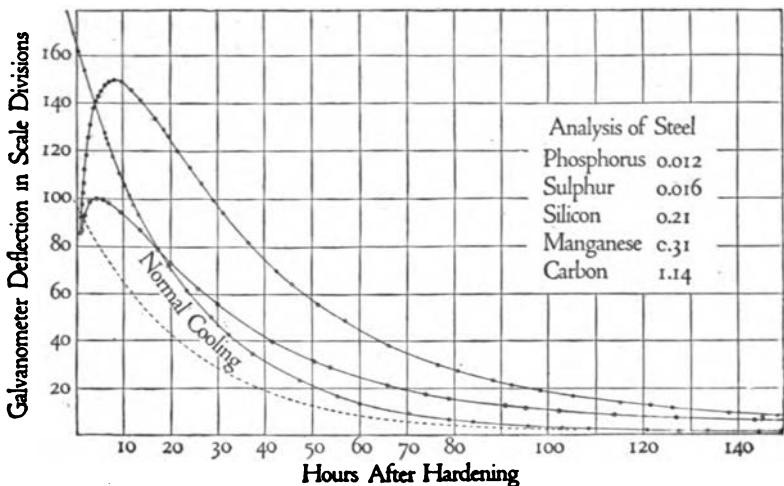

FIG. 8.—GENERATION OF HEAT AFTER HARDENING CARBON STEEL.

somewhat above preceding quenching temperature, allowed to cool slowly to 720° and quenched. This was a little below the temperature of complete recovery of magnetic susceptibility, which had occurred at 729°. Hardness was now only 28.5, and there was no generation of heat.

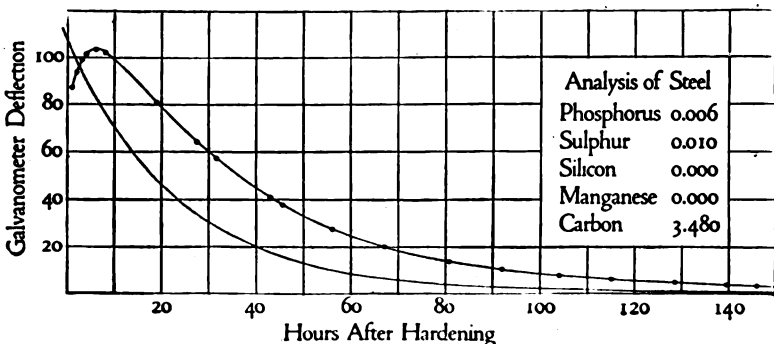

FIG. 9.—GENERATION OF HEAT AFTER HARDENING HIGH-CARBON STEEL.

The nickel-chromium steel had shown good generation of heat under similar circumstances. It was annealed by heating to 822°, to obliterate previous quenching effects, and cooled slowly in the furnace. Hardness was now 25.5. For the fourth quenching it was heated slowly from the annealed condition to 633° and quenched. Hardness was again 28.5,

## 604 SOME THERMAL RELATIONS IN THE TREATMENT OF STEEL

and there was no trace of absorption of heat. The nickel-chromium steel has shown good absorption of heat under similar circumstances. For the fifth quenching, it was heated slowly to 732°, just above the temperature of complete recovery of magnetic susceptibility, and quenched. No generation or absorption of heat, nor change in hardness (28.5).

For a general check on the performance of the apparatus, twelve ½-in. round bars of Swedish charcoal iron, of the aggregate weight of the steel usually employed, were slowly heated to 960° and quenched. Complete loss of magnetic susceptibility had occurred at 801°. The bars were warmed about 3° just before being placed in the calorimeter. There was no trace of heat generation following the quenching. Indeed, the curve of cooling followed the normal cooling curve with such fidelity that nowhere did they differ as much as the width of the curve line. This was very gratifying in view of the fact that observations for the normal cooling curve were made more than 2 years prior, and checked only once since that time. Hardness was 18.5.

### MANGANESE STEEL

Sir Robert Hadfield long ago suggested that interesting results might follow similar experiments with manganese alloy steel, so 19 numbered bars, each 6 in. long and ½ in. in diameter, were cut from the same long bar and ground to size after treatment. They contained: carbon, 1.18 per cent.; silicon, 0.14 per cent.; manganese, 12.29 per cent.

Bars 1 to 6, as forged, were non-magnetic. Bars 7 to 12, toughened by water-quenching at 995°C., were non-magnetic. Bars 13 to 18, toughened as above, then reheated to 500° and kept at that temperature 63 hr., were magnetic. Bar 19, treated like 13 to 18, then reheated to 995° and water-quenched, was non-magnetic. The scleroscope hardness of bar 1, as forged, was 37.3; bar 7, toughened, was 28.5; bar 15, toughened and reheated, was 51.6; bar 19, toughened, reheated, and retoughened, was 39.

Bar 13 was subsequently heated to 1074° and cooled (annealed) in the furnace. Its hardness, which presumably had been about 51.6 like its companion No. 15, was then 28.8, and it was non-magnetic; seeming to show that quenching at high temperature, and annealing from a still higher temperature, gives the same hardness and non-magnetic condition whatever the previous treatment may have been. The hardness of bar 19 seems to contradict this conclusion, in respect of hardness, but it was quenched at a very considerably lower temperature.

In the following experiments ten of the 6-in. bars were used, so as to approximately equal in weight the twelve 5-in. bars of other steel employed in former experiments.

*First Quenching.*—Bars 1 to 5 and 7 to 11 were heated in an electric muffle furnace to 1013° C. and quenched in water; this treatment was

followed by no appreciable generation or absorption of heat when tested in the calorimeter. Hardness was now: bar 1, 30; bar 7, 28.3, showing that the first and the second lot were brought to substantially the same toughened condition.

*Second Quenching.*—The ten bars were again heated to 1013°, allowed to cool in the furnace to 800° and quenched; again there followed no appreciable generation or absorption of heat. Hardness was now; bar 1, 27.6; bar 7, 26.3.

*Third Quenching.*—The bars were heated to 818°, allowed to cool in the furnace to 607°, and quenched; there was no subsequent generation or absorption of heat. Hardness was, bar 1, 26.3; bar 7, 26.6.

The ten bars were next heated slowly to 645° and allowed to cool slowly in the furnace to room temperature. The hardness was, bar 1, 26.5; bar 7, 25.9. All the bars were now very moderately magnetic, though in their softest condition.

The foregoing quenching temperatures were falling ones. The following quenching temperature was a rising one, from the annealed condition last described.

*Fourth Quenching.*—The bars were heated slowly to 615° and quenched. The hardness was now, bar 1, 38; bar 7, 30.3. Notwithstanding this considerable increase of hardness, there followed no appreciable generation or absorption of heat. The bars remained very moderately magnetic.

The results of the foregoing experiments make it highly probable that no spontaneous generation or absorption of heat can be brought about by quenching this manganese steel at any temperature, rising or falling, while in its normal, useful non-magnetic condition. But it was thought worth while to make further experiments with the steel in its magnetic condition and, incidentally, to study the development of this magnetic condition during the prolonged moderate heating necessary to bring it about.

The apparatus employed in the following study consists, in part, of a vertical cylindrical electric furnace heated by small spirals of "nichrome" wire carrying alternating current regulated by a rheostat. The heating spirals are so disposed as not to produce any magnetic field inside or outside the furnace. Instead of the usual sheet-iron casing, this furnace is cased with sheet brass slotted longitudinally to prevent induction currents in it when the external magnetizing solenoid is excited. The furnace is surrounded by a solenoid 16 in. inside, and 20 in. outside diameter, and 4 in. long (high), consisting of 860 turns of No. 12 insulated copper wire wound in two equal coils adapted to be placed in series or parallel relation by means of a suitable switch. The axes of the furnace and solenoid are coincident. The solenoid is excited by current from a 65-volt storage battery, controlled by a rheostat, and the circuit



606 SOME THERMAL RELATIONS IN THE TREATMENT OF STEEL

is closed and opened by a switch which breaks simultaneously at three points in series, so as to avoid the destructive arc that would occur at a single break. An ammeter and reversing switch are included in the line.

A single turn of asbestos-insulated platinum wire is located in the furnace, and the ends of this loop are connected by a twisted cable with a ballistic mirror-galvanometer of 600 ohms' resistance.

When the solenoid circuit is closed, a brief electric current is induced in the platinum loop in the furnace and causes a minimum swing of the galvanometer scale easily read with considerable precision.

When a bundle of ordinary steel or iron bars is placed within the platinum loop the galvanometer deflection is, of course, many times greater, and is fairly proportional to their magnetic susceptibility, after deducting the minimum deflection due to the platinum loop alone, and when the excitation of the solenoid is not too small or too great. In the following experiments with the manganese steel, 9 amp. was found to be a suitable exciting current with the solenoid coils in series. Small variations of exciting current were reduced to this value in computing results. Residual magnetism was measured by the usual method of reversals, and allowed for.

In the following experiments galvanometer deflection, less that amount due to the platinum loop alone, are taken as the measure of magnetic susceptibility, and the susceptibility of the Swedish iron is used as a standard and assigned a value of 100. All other values are reduced to and expressed in terms of this standard. As a preparatory measure, the ten bars of manganese steel were brought to their softest and toughest condition by quenching at 1000°. The hardness was, bar 1, 26.7; bar 7, 25.8. All the bars were quite free from any trace of magnetism.

The bars were placed within the platinum loop in the electric furnace and heated 170 hr. to a temperature fluctuating between 505° and 525°. The growth of magnetic susceptibility is plotted in the curve shown in Fig. 10. There is no doubt that the curve would have been smoother if the temperature had remained constant. It was intended to use about 515° temperature, which was maintained during the first few hours. Subsequent fluctuations were due to variations of voltage in the alternating heating current. The higher temperatures usually occurred in the latter part of the night, and were always accompanied by more than average rise of susceptibility. But the large depression in the central part of the curve is thought to be due to some obscure cause, and not to temperature variation. The entire absence of growth of susceptibility during the last 50 hr. or more prompted the belief that the steel had reached a stable condition at the temperature of treatment, and led to the discontinuance of this experiment. Permanent magnetism, which had been considerable while susceptibility was rising, fell off very much during the last 2 or 3 days.

*Fifth Quenching.*—At the end of 170 hr. the bars were quenched, after which they exhibited moderate, but typical and unequivocal generation of heat. The hardness was, bar 1, 48.1; bar 7, 47.2. This great increase of hardness, brought about by the long heating, doubtless accounts for the spontaneous generation of heat observed.

During the long heating the bars acquired a rather thick coating of black oxide, which peeled off almost completely in quenching, leaving a clean metal surface. The oxide was strongly magnetic; but its weight was so small, compared with the total weight of the bars, that it could not have affected, materially, the foregoing magnetic observations.

The bars were heated to a higher temperature than before, fluctuating between 590° and 598°, for the first 90 hr., or from 170 to 260 hr., reckoned from beginning of treatment. The results are plotted in the first curve

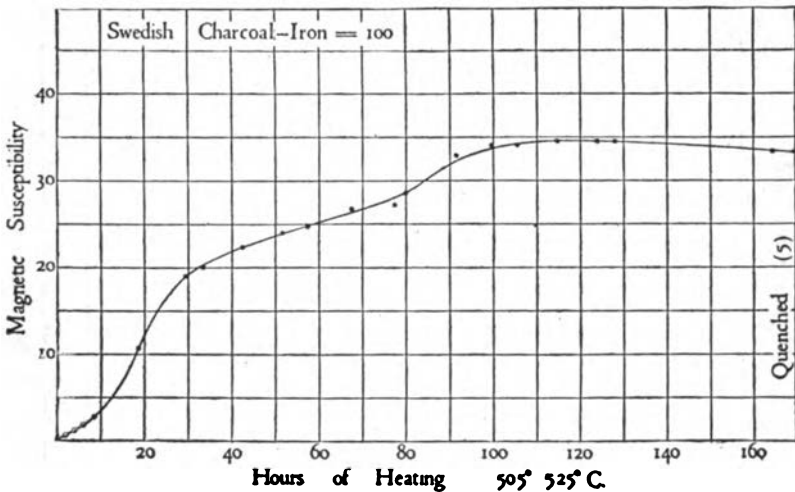

FIG. 10.—GROWTH OF MAGNETIC SUSCEPTIBILITY.

of Fig. 11. It is seen that magnetic susceptibility started at a very considerably higher value than it had at the end of the previous treatment. The reason of this increase during the intervening few days, without heating, is not clear. It may have occurred at the moment of quenching; or, more likely, during the period of spontaneous heat generation which followed the quenching.

The curve shows a very regular, but steadily diminishing, growth of susceptibility at this higher temperature, until it reaches nearly double the value it had at the end of the previous treatment.

When the temperature was next quickly lowered to its former value and then continued to the end of the experiment, 175 hr. (340 hr. total), there was at first a sudden rise of susceptibility, followed by steady growth as before.

*Sixth Quenching.*—At the end of 344 hr., total, of treatment, the bars were again quenched; this was followed by very little, if any, spon-

taneous generation of heat. The hardness was, bar 1, 37.4; bar 7, 36.2. This shows considerable softening since the last quenching, notwithstanding the large increase of magnetic susceptibility. The softening may account for the absence of heat generation after the quenching. The magnetic susceptibility of the cold quenched bars was almost the same (slightly lower) as before quenching.

The ten bars were again heated, slowly this time, to 590° and held nearly at that temperature until the 381 hr. of total treatment, as shown in Fig. 12. Susceptibility rose slightly, reaching its highest value, 68.5. As this is comparable with the susceptibility of ordinary steel, the manganese had apparently almost completely lost its influence.

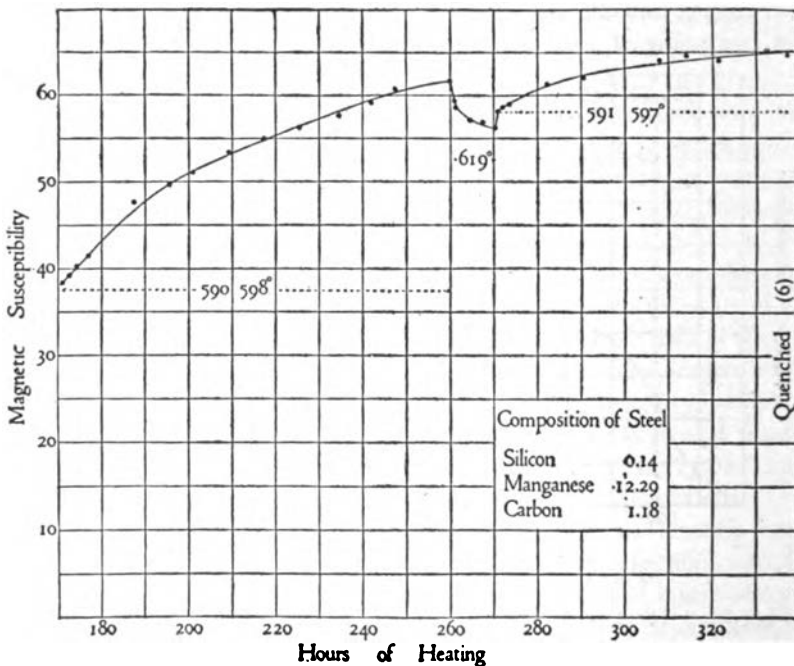

FIG. 11.

At this stage it was thought that decalescence might possibly be brought about by cautiously raising the temperature. The effect of doing so is shown in the great and nearly vertical drop in the susceptibility curve. The stations in this part of the curve represent observations at 1/2-hr. intervals, indicating 2 hr. for the total drop, with the temperature steadily rising to the maximum of 692°. It seemed clear that decalescence was not taking place, because loss of susceptibility was far too slow in time and the maximum temperature reached was not sufficiently high. Probably the manganese was simply resuming its sway.

The temperature was next rapidly lowered to 605°-590°, bringing on a rapid recovery of magnetic susceptibility, amounting to 30 points in

21 hr. as shown. Again the temperature was raised, but much more rapidly than before, resulting in a much steeper drop in the curve, the observation stations shown representing only five-minute intervals.

*Seventh Quenching.*—At the end of the curve shown in Fig. 12 the steel bars were quenched at 687°. Subsequently there was no trace of generation or absorption of heat; hence it is virtually certain there had been no decalescence. The hardness was, bar 1, 42; bar 7, 41.8.

Sir Robert Hadfield long ago assured me that the study of manganese steel is full of surprises for the investigator. I have experienced some of them, and hesitate to draw conclusions from the results of the experiments last described. That the manganese should completely

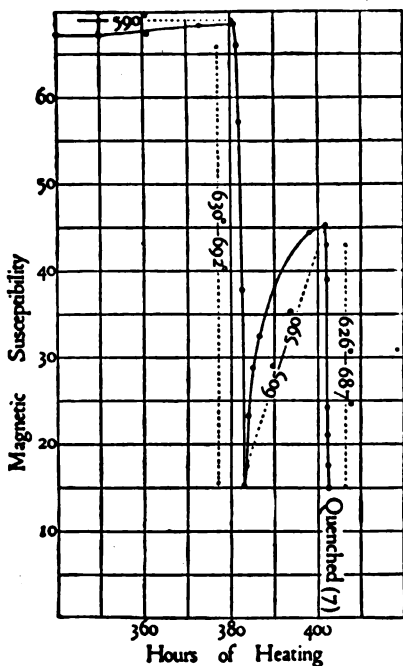

FIG. 12.

obliterate the magnetic quality of seven times its weight of iron is most remarkable; and the very gradual lifting of this inhibition at moderate temperatures, and the comparatively sudden reversion when a certain critical temperature (about 600°) is exceeded, afford an inviting field for research. It seems likely that the carbon present plays an important role in this peculiar alloy, or probably mixture of alloys of composition varying with temperature.

All interested in this subject should read the extended researches of Sir R. A. Hadfield and Prof. B. Hopkinson on the magnetic and mechanical properties of manganese steel.<sup>2</sup>

<sup>2</sup> *Jnl. Iron and Steel Inst.* (1914) 50, 476.

## Pyrometry in the Tool-manufacturing Industry

BY J. V. EMMONS,\* CLEVELAND, OHIO

(Chicago Meeting, September, 1919)

THE processes of hardening and tempering steel tools within the past 15 or 20 years have been so developed that the forward strides of the industry can scarcely be followed by the average observer. No small part of the credit for this phenomenal advancement is due to the improved methods of measuring the high temperatures necessary. Pyrometry has made possible the discovery and use of the many special alloy steels, the wonderful properties of which are revolutionizing the industrial world. So sensitive are these steels to changes of temperature that often a variation of only 10° F. at a critical point of the heat treatment will cause the failure of the tool. In the tool-manufacturing industry today, accurate control of the many heating operations is imperative.

The principal processes in the manufacture of tools that require accurate high-temperature measurements are annealing, carburizing, hardening, tempering, and laboratory research. Several other operations, such as forging and straightening, use rougher and correspondingly less accurate methods. These operations are usually performed in the following approximate ranges of temperature:

|                       | DEGREES F.   |                         | DEGREES F.   |
|-----------------------|--------------|-------------------------|--------------|
| Annealing . . . . .   | 1000 to 1700 | Tempering . . . . .     | 200 to 1200  |
| Carburizing . . . . . | 1400 to 1900 | Forging . . . . .       | 1400 to 1800 |
| Hardening . . . . .   | 1400 to 2500 | Straightening . . . . . | 300 to 1300  |

Laboratory research covers the entire range.

Annealing and carburizing are usually done in muffle or semi-muffle furnaces, heated with coal, coke, oil, gas, or electricity. Many of them are of large size, holding several tons of steel at one charge. Both indicating and recording pyrometers are used. The recording instruments are generally of the thermoelectric type, while for the indicating, both optical and thermoelectric are used.

Hardening furnaces are of many types and sizes and use all the common sources of heat. The best known are muffles and semi-muffles fired] with oil or gas, electric muffles, lead and salt baths heated by oil or gas, and electrically heated salt baths. The pyrometers used are

\* Metallurgist, Cleveland Twist Drill Co.

largely indicating, although in a few cases recording instruments have been installed. For the indicating instruments, both thermocouples and optical pyrometers are used. For the high range of temperatures used in hardening high-speed steel, the optical pyrometers are much to be preferred.

Tempering furnaces are usually muffles, oil baths, or salt baths and are heated by gas, oil, or electricity. Temperatures up to 600° F. (316° C.) are preferably measured by a mercury thermometer. From 600° to 1200° F. (316° to 648° C.), a thermocouple or resistance thermometer is used.

In heating steel for forging, gas or oil fired furnaces are used, the temperatures being determined by the eye, with occasional checking up by means of optical pyrometers.

For straightening, open gas flames are used and the temperatures roughly determined by visual examination of the temper colors and the first appearance of redness.

In the laboratory, it is necessary to have accurate instruments and standards for checking up all of the types of pyrometers in use in the factory at frequent intervals. Rare-metal thermocouples and the new Leeds & Northrup portable optical pyrometers are particularly useful for this purpose. The laboratory also requires pyrometers, which may be used for experimental or research work over the entire range of temperatures. Thermoelectric pyrometers of both rare and base-metal types and several types of optical instruments are used.

The Morse thermogage has been found particularly adaptable for tool-manufacturing purposes requiring an indicating instrument only. It consists of an electric lamp with a hairpin filament so placed in a telescope or tube that the brightness of the filament may be compared with the brightness of the heated object, the temperature of which is to be measured. As the incandescence of a heated object increases quite rapidly with any increase of temperature above 1200° F. (648° C.) this forms a very sensitive indication of the temperature. The current for the lamp must be of very constant voltage and is usually furnished by storage batteries. The temperature of the filament in the lamp is controlled by means of a rheostat and the current flowing through the lamp is read upon an ammeter graduated to 10 milliamperes. As with the voltage constant the temperature of the filament is in proportion to the current flowing through it, the ammeter may be calibrated in terms of degrees of temperature.

The low limit of temperature for which this instrument may be used is at the point where a faint red incandescence begins, or at about 1100° to 1200° F. (593° to 648° C.). The high range of the instrument is almost unlimited as far as practical operation is concerned. For high temperatures where the brightness of the heated body causes discomfort to the eye, a calibrated absorption screen is inserted between the filament and

the heated object to reduce the amount of light entering the eye. For cases when the color of the light emitted by the filament is different from the color of the light from the heated body, a monochromatic screen, usually red, may be inserted between the filament and the eye to assist in the comparison of the brightness of the two incandescent objects. For factory use at temperatures below 2000° F. (1093° C.), when it is possible to maintain black-body conditions, it has been found most satisfactory to use a lamp with a large carbon filament and a telescope tube without lenses or absorption screens. In cases where the furnace conditions make it possible, the telescope tube is permanently mounted as close to the heated body as possible and in position for the most convenient observation by the operator. The rheostat and ammeter are placed in a position removed somewhat from the heat of the furnace, yet readily accessible to the operator. This form of permanent installation is particularly useful for lead and salt baths.

There are many cases, particularly in the hardening operation, when it is desired to hold a furnace, such as a lead or salt bath, at a constant temperature while a large number of tools are given a uniform treatment. For this work, the Morse thermogage has been found particularly suitable. For this purpose the ammeter is set at the required temperature after which the operator has only to look through his telescope tube occasionally to observe the condition of the heat in his furnace. It is instantly apparent whether his temperature is high, low, or correct. The fact that the reading of the temperature is almost instantaneous is one of the great advantages of this instrument over the thermocouple. The only lag present is the time required for the lamp filament to respond to different current changes, which is from 1 to 2 sec. at the most. In hardening delicate tools, the operations must be carried out with such exactness and rapidity that the lag in the operation of a thermocouple becomes a serious handicap. Where a number of furnaces are used, all requiring only the occasional use of a pyrometer, the wires from the current supply may be carried to each furnace and a single instrument arranged to plug in whenever and wherever required.

With experienced observers and ideal conditions, it has been found possible to obtain an accuracy of 5° F., plus or minus, for the range of temperatures from 1200° to 1700° F. and an accuracy of 10° F., plus or minus, within the range 1700° to 2500° F. Under commercial conditions and with average observers, an accuracy of 10° F., plus or minus, can be obtained for the lower range of temperatures and 15° F., plus or minus, for the upper range above mentioned.

The calibration of the lamps is tested at regular intervals by comparison with a test lamp that has been calibrated by the Bureau of Standards. A Leeds & Northrup portable optical pyrometer and a Le Chatelier rare-metal thermocouple are also used for comparison. The

majority of the lamps are found to hold their calibration very well while a few have been in daily service for from 5 to 10 years without any appreciable change in calibration.

The upkeep of the Morse thermogage is very small, consisting mostly of the necessary attention to the storage batteries and occasional replacing of lamps burned out or accidentally broken. The ammeter and rheostat rarely need attention.

A short period of training is necessary to accustom a new operator to the use of the instrument, but this is seldom longer than a few days. A few men have been found that through some defect of eyesight seem unable to use it accurately; these are very rare. A man of average intelligence will learn the principles of the operation with a very few explanations and many become expert in its use in 1 day's time.

The limitations of the Morse thermogage may be summarized as follows: It is inoperative below 1200° F. It is suitable for an indicating pyrometer only. It is portable only to the extent to which connections may be carried from a storage battery. It is necessary to provide black-body conditions for accurate work. A certain amount of training is necessary for the most accurate use. It will read the temperature of the surface of an object only and cannot be used except for such localities as can be made visible to the eye.

The advantages of the thermogage are: Its accuracy, which is approached by few other instruments under commercial conditions. The rapidity with which readings may be taken, the time required being a few seconds only; for instance, the temperature of forgings can be taken while they are being worked under the hammer. The absence of lag, the temperature indicated being the temperature existing at that instant and not the temperature present several minutes previously, as with the average thermoelectric pyrometer. No parts of the pyrometer are exposed to the heat of the furnace or heated object, the temperature of which is being measured. The high range of temperatures for which it is available, there being no high limit to its use in commercial practice. The simplicity and ease of operation; there are few parts to get out of order and these being easily protected, the lamp may be safely used by unskilled labor. The general reliability of the instrument; the occurrence of difficulties and troubles is infrequent. The low expense of upkeep, repairs and replacements being necessary only at rare intervals.

With regard to the entire pyrometer situation in tool manufacturing, it may be said that the price of success is eternal vigilance. Small defects and changes of calibration must be discovered immediately and corrected before they result in large errors or serious loss may result. A regular system of inspection and testing will be found the best safeguard against unsatisfactory service from all types and makes of pyrometers.



## Forging Temperatures and Rate of Heating and Cooling of Large Ingots

BY F. E. BASH,\* CH. E., PHILADELPHIA, PA.

(Chicago Meeting, September, 1919)

IN recent years, there have been a number of experiments conducted to determine the rates of heating and cooling of various sizes and shapes of steel ingots. Up to date, however, most of the published data have dealt with small sized ingots, the largest being an 18-in. (46 cm.) cube, the data on which were presented before the Iron and Steel Institute in May, 1918, by E. F. Law. It is due to this lack of information on the rate at which large ingots absorb heat and come to temperature that the heating practice varies so widely in different plants. One of the questions over which there is much debate is the proper rate of heating of large ingots for forging and the time actually required for the center of a mass of steel to come to forging temperature.

As a continuation of experiments described by M. E. Leeds<sup>1</sup> and at the request of Mr. G. R. Norton of the Sizer Forge Co. and Mr. R. C. Drinker of the Emergency Fleet Corpn., the test described in this paper was carried out on a 24-in. (61 cm.) round ingot and the rate of heating and cooling determined under regular production conditions. The ingot had been partly forged at one end but, on developing a flaw, had been scrapped so that it was available for test. The size and shape of the ingot and its position in the furnace are shown in Fig. 1.

### EXPERIMENTAL INGOT

This ingot was prepared as follows: The end of the 24-in. section that was the top end when it was cast was sawed off in order to remove the part in which there was segregation, as it was not possible to drill this end because of its hardness. Seven holes  $\frac{3}{4}$  in. (1.9 cm.) in diameter and 18 in. (46 cm.) deep were then drilled in the end of the ingot, as shown in the drawing, one hole  $\frac{1}{2}$  in. (1.27 cm.) from the top surface, one  $\frac{1}{2}$  in. from the bottom, one in the center, and two evenly spaced between the center and the top and the center and the bottom. The holes were drilled 18 in. deep in order to have them farther from the

---

\* Research Engineer, Leeds & Northrup Co.

<sup>1</sup> Some Neglected Phenomena in Heat Treatment of Steel. *Proc. Am. Soc. Test. Mat.* (1915) 15.

end than the radial distance from the center in order to lessen the effect due to the heat penetrating from the end.

To take temperatures along the length of the surface of the ingot, a 2-in. (5 cm.) iron conduit pipe was half flattened under a press, and the end pinched shut and welded tight. The pipe was then spot welded to the ingot directly above the line of holes in the end, as shown, thus making it possible to push thermocouples of different lengths down the pipe so as to take temperatures as near as possible to the surface of the ingot. As a check on the gas temperatures near the ingot, two nichrome

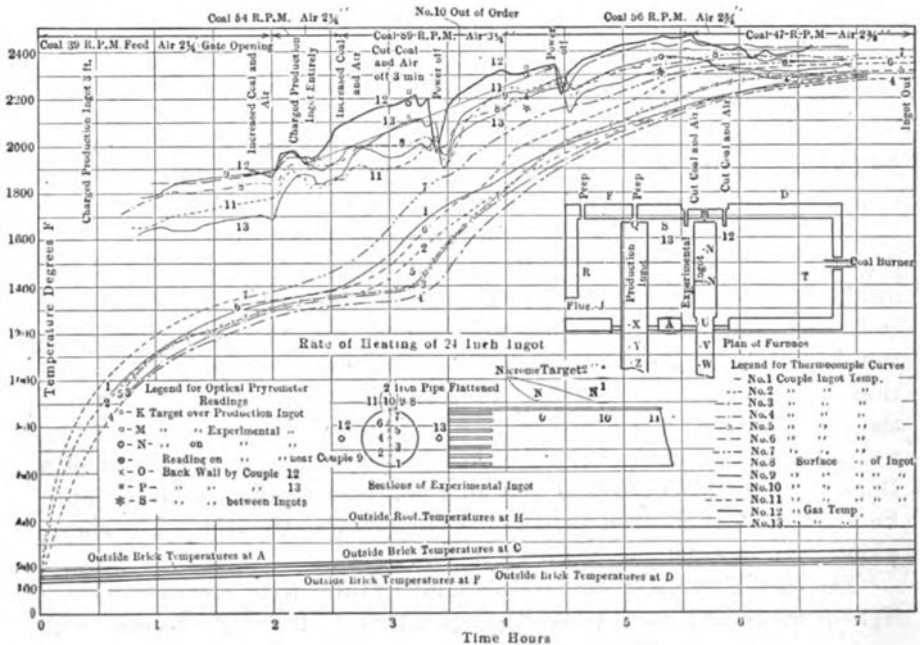

FIG. 1.

targets 2 by 2 by  $\frac{1}{32}$  in. were welded to  $\frac{1}{2}$ -in. iron rods 4 ft. long and spotted to the ingot in the positions shown.

### FURNACE

The furnace was of the two-door type and had a vertical slot 4 in. (10 cm.) wide and 30 in. (76 cm.) long in the back directly opposite the experimental ingot, through which slot the thermocouples could be pushed into the ingot. On both sides of the slot and 21 in. (53 cm.) from its center were mudded in two usalite porcelain protecting tubes for platinum platinum-rhodium thermocouples, which were to record gas temperatures. One-inch steel rods, with nichrome targets 2 in. square and  $\frac{1}{32}$  in. thick welded on the end, were suspended from the

roof of the furnace, one directly over the experimental ingot and 2 ft. above it, one over the production ingot, and one opposite the center of the flue. Peep holes were arranged in the walls opposite these targets so that optical pyrometer readings could be made at intervals as a check on gas temperatures.

In order to calculate the heat losses from the furnace, mercury thermometers were suspended around the outside of the walls at intervals and the bulbs packed against the brick with asbestos wool. To take the temperature of the outside of the roof, a thermocouple of No. 16 B. & S. gage iron and constantan was prepared and the hot junction buried in the layer of dust on the top of the furnace.

#### THERMOCOUPLES AND APPARATUS

To take the ingot temperatures, thermocouples were prepared as follows: A length of No 14 B. & S. gage chromel wire was welded to an iron plug  $\frac{3}{8}$  in. (9.5 mm.) in diameter and approximately 1 in. (2.5 cm.) long. The wire was then threaded through porcelain insulators and drawn through a length of  $\frac{5}{8}$  in. (1.5 cm.) seamless steel tubing,  $\frac{3}{8}$  in. inside diameter, until the plug was flush with the end of the tube. The steel tube and plug were then welded over smooth. The leads from the cold ends of the thermocouples to the Leeds & Northrup potentiometer recorder were of No. 16 constantan and chromel, bringing the cold junction to the recorder. A calibration curve of millivolts vs. temperature was made for the chromel-steel couples with the aid of a Bureau of Standards checked platinum-platinum-rhodium thermocouple. Each couple was checked against this curve before the test. The curve, which is an unusual one, is shown in Fig. 2.

The eleven chromel steel couple temperatures were recorded by one eight-point recorder and three single-point curve-drawing recorders with a range of 0-16 millivolts. The gas temperatures were recorded by two curve-drawing recorders for platinum thermocouples. The roof temperatures were taken with a potentiometer indicator and readings on targets and inner wall and ingot surface temperatures were taken with a Leeds & Northrup optical pyrometer, which is the disappearing filament type.

#### TEST

It is the practice of the Sizer Forge Co. to run the forging furnaces, which are fired with powdered coal, all week and to shut down over Sunday. On Sunday night, the furnaces are lighted and are ready to charge on Monday morning. The test was ready to run by Monday morning so the furnace was lighted Sunday night. The pulverized coal is fed into the furnace by a screw operated by an electric motor, the

speed of which may be varied by means of a field rheostat. To increase the air, a gate could be raised in the air pipe. This gate was roughly calibrated so that the heater knew approximately where to set his gate opening for a certain coal feed.

The experimental ingot was charged at 10:30 A. M. and the door was open  $\frac{1}{2}$  hr. during the charging. The couples were inserted in the ingot and a 1-in. (2.5 cm.) conduit pipe 18 in. (46 cm.) long was slipped over

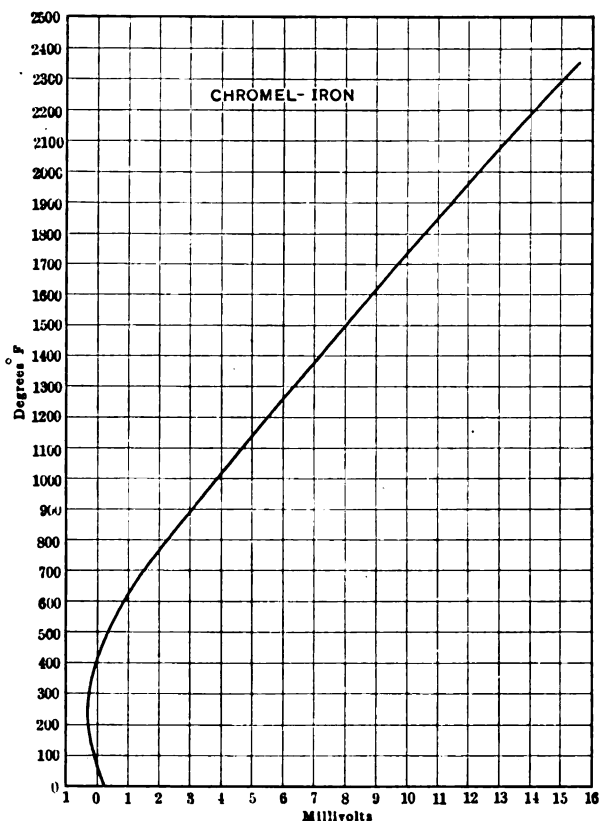

FIG. 2.—CHROMEL-IRON THERMOCOUPLE CALIBRATION.

each couple up to the end of the ingot. The space between the couples was filled with bricks and clay to separate them. The 1-in. sleeves used to protect the couples from the corrosion of the furnace gases furnished an opening through which the couples could be withdrawn at the close of the test. The production ingot was charged 3 ft. (0.9 m.) at 11 A. M., but as they were not able to procure a weight to balance it, it was not completely charged until 12.45. In the time intervening, the door was closed

down to the ingot but the open spaces at the sides of the ingot were not bricked up. The furnace was started at a coal feed of 39 r.p.m. and a gate opening of  $2\frac{1}{4}$  in. (5.6 cm.). Afterward, these were increased to 54 r.p.m. and  $2\frac{3}{4}$  in. and later to 69 r.p.m. and  $3\frac{1}{4}$  in.; this maximum feed was later reduced.

The coal leaves a fine ash that settles all over the interior of the furnace and, where it comes in contact with iron oxide, slags with it. The ash settles on an ingot and may appear a good deal brighter than the ingot itself and may actually be hotter. This is shown by a reading of  $2202^{\circ}$  F. ( $1207^{\circ}$  C.) on the end of the production ingot with the ash on and  $2061^{\circ}$  F. ( $1128^{\circ}$  C.) on the surface after the ash was scraped off. This fact may cause a heater to overestimate the temperature. When the ingot was charged this fine ash had settled all over the iron rods suspended from the roof and made them appear  $\frac{1}{2}$  in. larger in diameter than they really were; also the two nichrome targets suspended over the ingots had burned off while the target at the entrance to the flue was partly burned. Readings with the optical pyrometer made on the suspension rods on the side in the shadow from the flame, with the ash clinging to them and with the ash scraped off, agreed to  $5^{\circ}$  F. ( $2.7^{\circ}$  C.). Readings on the side toward the flame were considerably higher due to reflections.

The flame was a pulsating one and reached beyond the experimental ingot so that, on making a reading with the optical pyrometer, the filament appeared alternately light and dark. The readings taken, which appear in the log, show the effect of the flame on the temperature read, this flame effect amounted to from  $12^{\circ}$  to  $22^{\circ}$  F. ( $6.6^{\circ}$  to  $12.2^{\circ}$  C.). A balance was made with the optical pyrometer on one of the rods through the fine ash haze in the furnace and then the coal and air were cut off and another reading made directly afterward; this agreed exactly with the first reading. For that reason we can say that there is no noticeable error due to the ash when making a reading through it with the optical pyrometer. The log of the test and data taken in addition to the ingot temperatures are given in the following tables.

According to the curve shown in Fig. 1, after 7 hr. heating the ingot had reached a temperature of  $2370^{\circ}$  F. ( $1299^{\circ}$  C.) at the surface and  $2287^{\circ}$  F. ( $1253^{\circ}$  C.) at the center; this was considered a good forging temperature. The cooling curve shows that if forging were started 15 min. after the ingot was pulled from the furnace the outside temperature would be  $2125^{\circ}$  F. ( $1163^{\circ}$  C.) and the center would be  $2280^{\circ}$  F. ( $1249^{\circ}$  C.); the temperature 5 in. (12.7 cm.) from the surface would be  $2260^{\circ}$  F. ( $1238^{\circ}$  C.). As the outside temperature drops so rapidly and the center so slowly, there can be a temperature difference of  $150^{\circ}$  F. ( $83^{\circ}$  C.) between the two in the furnace and by the time it is ready to forge or shortly after starting, the center will be the hottest part of the ingot.

TABLE 1.—*Log of Test*

| Time  | Temperature, Degrees F. | Remarks   |
|-------|-------------------------|---|
| A. M. |                         |   |
| 8:45  | 2070                    | O. P.* Reading in porcelain tube, gas temperature.                          |
| 10:30 |                         | Charged experimental ingot.   |
| 11:00 |                         | Charged production ingot (3 ft.), not bricked up.                           |
| 11:15 | 1845                    | O. P. on N <sup>1</sup> , dark.   |
| 11:15 | 1857                    | O. P. on N <sup>1</sup> , bright; flame effect, 12° F.                      |
| 11:25 | 1881                    | O. P. on M, (rod), dark.  |
| 11:25 | 1903                    | O. P. on M, (rod), bright; flame effect, 22° F.                             |
| P. M  |                         |   |
| 12:30 |                         | Changed coal feed to 54 r.p.m.<br>Changed gate opening to 2¾ in.            |
|       | 2044                    | O. P. on N <sup>1</sup> , light.  |
|       | 2020                    | O. P. on N <sup>1</sup> , dark.   |
|       | 2005                    | O. P. on M, dark.   |
| 12:45 |                         | Pushed production ingot clear in, and bricked up.                           |
| 1:05  |                         | Changed coal to 69 r.p.m.<br>Changed air to 3½ in.                          |
| 1:50  |                         | Coal and air off for 2 min.   |
| 1:57  | 2191                    | O. P. on N just before power off.   |
| 1:58  |                         | Power off.  |
| 2:01  |                         | Power on.   |
| 2:02  | 2080                    | O. P. on N just after power on.   |
| 3:06  |                         | Power off.  |
| 3:08  |                         | Power on.   |
| 3:50  | 2202                    | O. P. on loose ash on end of production ingot.                              |
| 3:51  | 2061                    | O. P. on end production ingot, clean.                                       |
| 4:03  |                         | Coal to 56 r.p.m., air to 2¾ in.  |
| 4:22  |                         | Coal to 47 r.p.m., air to 2½ in.  |
| 5:30  |                         | Water flowing through door 10½ lb. in 20 sec., heated<br>from 25° to 55° C. |
| 6:05  |                         | Ingot taken out.  |

\* Optical pyrometer.

TABLE 2.—*Optical Pyrometer Readings, in Degrees F.*

| Time, Hours | Target Center Flue J | Center End Prod. Ingot Q | Target Over Prod. Ingot R | Target Over Exp. Ingot M | Target on Exp. Ingot Front N <sup>1</sup> | Target on Exp. Ingot Back N | Back Wall by Couple No. 12 O | Back Wall by Couple No. 13 P | End Wall near Flue R | Back Wall Center S | Floor Combustion Chamber T |
|-------------|----------------------|--------------------------|---------------------------|--------------------------|---|-----------------------------|------------------------------|------------------------------|----------------------|--------------------|----------------------------|
| 3:17        | 1993                 | 1773                     | 2120                      | 2229                     | ...                                       | 2191                        |                              |                              |                      |                    |                            |
| 4:17        | 2075                 | 1965                     | 2209                      | 2328                     | 2305                                      | 2305                        | 2277                         | 2241                         | 2124                 | 2196               | 2343                       |
|             |                      |                          | Front wall                | On ingot                 |   |                             |                              |                              |                      |                    |                            |
| 5:34        | 2107                 | 2061                     | 2233                      | 2378                     | ....                                      | ....                        | 2449                         | 2385                         | 2178                 | 2325               | 2473                       |
| 6:34        | 2140                 | 2164                     | 2265                      | 2350                     | ....                                      | ....                        | 2346                         | 2309                         | 2174                 | 2265               | 2370                       |

TABLE 3.—*Outside Brick Temperatures, in Degrees F.*

| Time, Hours from Start | Between Doors A | End Wall C | Back Wall Combustion Chamber D | Back Wall near End F | Top over Combustion Chamber G | Top over Exp. Ingot H | Top over Prod. Ingot S |
|------------------------|-----------------|------------|--------------------------------|----------------------|-------------------------------|-----------------------|------------------------|
| 2.50                   | 211             | 222        | 192                            | 177                  |                               |                       |                        |
| 3.00                   | ...             | ...        | ...                            | ...                  | 360                           |                       |                        |
| 3.17                   | ...             | ...        | ...                            | ...                  | ...                           | 379                   |                        |
| 3.50                   | 234             | 236        | 204                            | 190                  |                               |                       |                        |
| 4.17                   | ...             | ...        | ...                            | ...                  | ...                           | 366                   | 350                    |
| 4.50                   | 244             | 246        | 213                            | 196                  |                               |                       |                        |
| 5.34                   | ...             | ...        | ...                            | ...                  | ...                           | 360                   |                        |
| 5.50                   | 257             | 255        | 220                            | 206                  |                               |                       |                        |
| 6.34                   | ...             | ...        | ...                            | ...                  | ...                           | 373                   |                        |
| 6.75                   | 270             | 265        | 220                            | 212                  |                               |                       |                        |

TABLE 4.—*Outside Ingot Temperatures, in Degrees F.*

| Time, Hours from Start | Top Exp. Ingot 1 Ft. from Door U | Top Exp. Ingot 2 Ft. from Door V | Top Exp. Ingot 3 Ft. from Door W | Top Prod. Ingot 1 Ft. from Door X | Top Prod. Ingot 2 Ft. from Door Y | Top Prod. Ingot 3 Ft. from Door Z |
|------------------------|----------------------------------|----------------------------------|----------------------------------|-----------------------------------|-----------------------------------|-----------------------------------|
| 3:83                   | 249                              | 157                              | 123                              |                                   |                                   |                                   |
| 5:50                   | ...                              | ...                              | ...                              | 227                               | 143                               | 117                               |
| 6:25                   | 338                              | 191                              | 142                              |                                   |                                   |                                   |

COAL RECORD

|  |         |
|--|---------|
| 10:30-12:30: 39 r.p.m. = 9.7 lb. per min., 120 min. at 9.7 lb. per min.... = 1164  | POUNDS  |
| 12:30-1:05: 54 r.p.m. = 14.4 lb. per min., 35 min. at 14.4 lb. per min..... = 504  |         |
| 1:05-4:03: 69 r.p.m. = 21.53 lb. per min., 178 min. (shutdowns at 1:58-2:11 and 3:06-3:08, 15 min.), 163 min. at 21.53 lb. per min. .... = 3509.39 |         |
| 4:03-4:22: 56 r.p.m. = 15.1 lb. per min., 19 min. at 15.1 lb. per min. .... = 286.9  |         |
| 4:22-6:05: 47 r.p.m. = 12.1 lb. per min., 103 min. at 12.1 lb. per min. .... = 1246.3  |         |
| Total coal.....  | 6710.59 |

The heating curves of the ingot from the room temperature to, approximately, 950° F. (510° C.) are estimated and dotted in. In the case of couples No. 1 and 7 it is possible that the temperature came up more rapidly than shown. The time after charging the ingot to the beginning of the record was taken up in inserting the couples and bricking up the slot through which they were inserted.

The platinum platinum-rhodium thermocouples with the usalite protecting tubes registered gas temperatures very accurately and did not seem to be affected by the proximity of the ingot. This is shown by the readings with the optical pyrometer on the suspended targets. The

heating curves show that optical readings on the target above the experimental ingot show gas temperatures about 20° F. higher than that recorded by the thermocouple at the side of the ingot next to the flame, and that readings on the target spotted to the ingot are about 20° F. lower than the thermocouple. This is good proof that the thermocouple indicates the gas temperature as it is the mean of the two. Optical pyrometer readings on the target suspended over the 26-in. production ingot check very closely with the temperatures recorded by the platinum

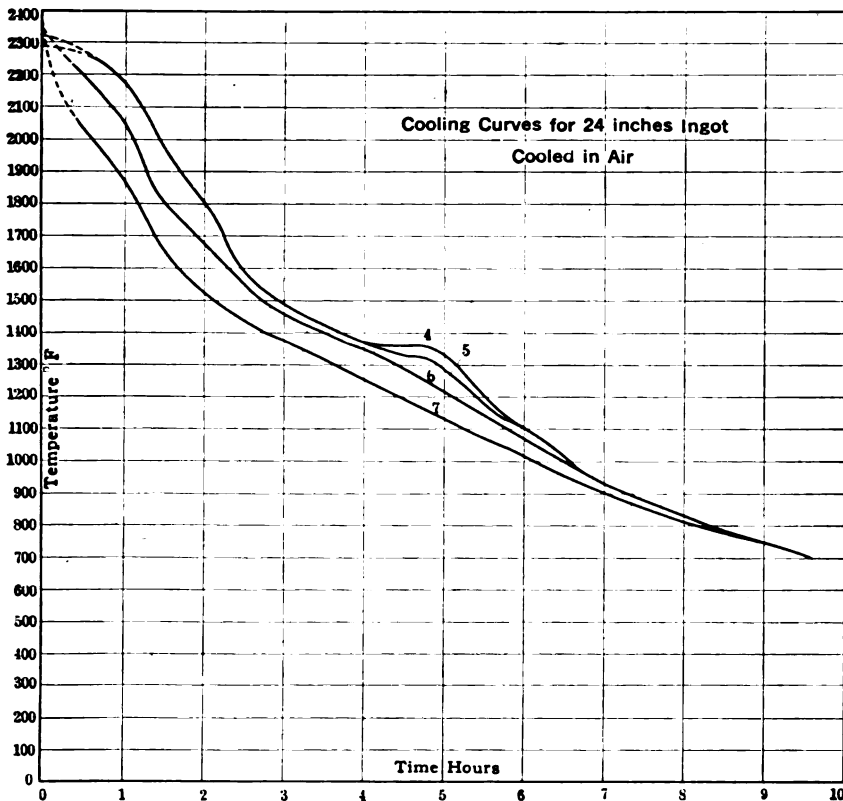

FIG. 3.—COOLING CURVES.

thermocouple at the side of the experimental ingot away from the flame, which is reasonable to believe. Optical readings made on the top of the experimental ingot near the end of couple No. 9 check very closely to the temperature recorded by the couple; this indicates that the optical pyrometer reads the true surface temperature of the ingot.

Two optical readings made on the front wall after the rod suspended from the roof had burned out do not show any relation to the ingot temperature, but readings made on the back wall between the two ingots



and near couple No. 13 check the couple readings fairly closely, the greatest difference being 20° F. Readings on the back wall, on the flame side of the experimental ingot, agree with the gas temperature as shown by thermocouple No. 12 to 40° F. It would seem from this that a reading with the optical pyrometer on the back wall at the height of the ingot from the floor will give the gas temperature at that point to within 30° to 40° F.

With the exception of the time at which the ingot was going through the critical period, the temperatures along the surface of the ingot always fell between the temperatures of the gases on both sides. The point nearest the door, naturally, was the coolest, the points about the middle of the furnace were the hottest, and the point nearest the back wall was somewhat cooler than the center of the furnace. The drop in the temperature of the gases from one side of the ingot to the other averages about 125° F.; this represents the heat lost by the gas and absorbed by the ingot. The temperature drop of the gas from the combustion chamber to the flue averaged from 230° to 266° F.; the heat in the flue gases was used to evaporate water in waste heat boilers and so was conserved. The temperature gradient along the ingot from the portion just outside the door to the inside is very great, as is shown in Table 4. The stresses set up at this section must be very large and injurious.

The coal used amounted to 6710 lb. (3043 kg.). This was calculated from the revolutions of the screw feed which had previously been calibrated. Taking the weight of the experimental ingot heated as 13,083 lb. (5934 kg.) and the production ingot as 18,050 lb. (8187 kg.), which we will estimate was 0.8 heated, the total weight of steel this amount of coal will heat when fired in this manner would be 27,533 lb. (1262 kg.), or the rate of using coal will be 0.244 lb. (0.110 kg.) of coal per pound of steel. The rate was really less than this as the ingot was hot in 6½ hr. and the coal is calculated to 7½ hr. To heat a 24-in. (61-cm.) ingot in 7 hr., in this type and size of furnace with this kind of fuel, means that the coal should be fired at the rate of 16 lb. (7.25 kg.) per min. To bring it to temperature in a longer time, the coal must be fed more slowly and more coal will be needed; how much more will depend on the radiation losses. The heating value of the coal used was 13,000 B.t.u. per lb. so that the heat developed was 87,230,000 B.t.u. The heat absorbed by the steel was approximately 7,270,000 B.t.u., the percentage of the total heat absorbed by the steel being 8.32 per cent.

When the ingot was pulled from the furnace and laid on the ground, four couples were replaced in the ingot and the cooling curve taken. The center of the ingot showed the passage through the critical point more markedly than any other point, as was also the case in heating. The recalescence and decalescence points were at practically the same temperature. After the ingot had cooled to 750° F. (399° C.) all the points

in it from  $\frac{1}{2}$  in. (1.27 cm.) under the surface to the center cooled together and were all at the same temperature as they cooled.

### FORGING TEMPERATURES

In Table 5 are given the temperatures read on three four-door furnaces at the Sizer Forge Co., with the Leeds & Northrup optical pyrometer. The furnaces were lettered *J*, *K*, and *L*, and were so arranged that the flames were from left to right on *L*, right to left on *K*, and left to right on *J*. *J* had a bridge-wall in the combustion chamber, but *K* and *L* had none. The doors were numbered consecutively, beginning with the one next to the burner.

TABLE 5.—*Temperatures on Forging Furnaces*

| TIME  | TEMPERATURE,<br>DEGREES F. | REMARKS  |
|-------|----------------------------|--|
| 11:55 | 1525                       | Finished forging 26 in. ingot to 13 in., surface reading.    |
| 12:08 | 2477                       | On surface No. 1 K, roll ingot.                              |
| 12:10 | 2511                       | Back wall right of ingot No. 1 K, flame right to left.       |
| 12:11 | 2350                       | Back wall left of ingot No. 2 K, flame right to left.        |
| 12:12 | 2221                       | Back wall right of ingot No. 3 K, flame right to left.       |
| 12:12 |                            | Pull ingot from No. 2 L.                                     |
| 12:13 | 2169                       | Back wall right of ingot No. 4 K.                            |
| 12:14 |                            | Charge above ingot in No. 1 L.                               |
| 12:17 | 2245                       | Back wall No. 2 L, door open from 12:12.                     |
| 12:19 |                            | Charge cold ingot in No. 2 L.                                |
| 12:22 |                            | Coal off of K furnace, air about $1\frac{1}{2}$ in. opening. |
| 12:35 |                            | Bricking up Nos. 1 and 2 L, coal off and air on.             |
| 12:32 | 2505                       | Floor of combustion chamber of K furnace, coal on            |
| 12:34 | 2508                       | Wall of combustion chamber of K,                             |
| 12:36 | 2529                       | Right of No. 1 K, wall; flame right to left.                 |
| 12:36 | 2392                       | Left of No. 1 K, wall; flame right to left.                  |
| 12:37 | 2392                       | Right of No. 2 K, wall; flame right to left.                 |
|       | 2346                       | Left of No. 2 K, wall; flame right to left.                  |
| 12:38 | 2346                       | Right of No. 3 K, wall; flame right to left.                 |
|       | 2289                       | Left of No. 3 K, wall; flame right to left.                  |
| 12:39 | 2289                       | Right of No. 4 K, wall; flame right to left.                 |
|       | 2265                       | Left of No. 4 K, wall; flame right to left.                  |
| 1:09  | 2403                       | Ready to pull 26 in. ingot in No. 1 K.                       |
| 1:10  | 2580                       | Right N . 1 K, wall.   |
|       | 2343                       | Scale on ingot 30 sec. after being drawn from furnace.       |
|       | 2111                       | Scale in groove under press.                                 |
| 1:12  | 2140                       | Clean spot.  |
| 1:16  | 2015                       | Clean spot.  |
| 1:19  | 1851                       | Groove.  |
| 1:20  | 1919                       | Second groove, clean.  |
| 1:22  | 1886                       | Third groove, clean.   |
| 1:24  | 1990                       | Deep groove under cutter, clean; approximately 6 in. deep.   |
| 1:26  | 2015                       | Deep groove under cutter, clean; approximately 6 in. deep.   |
| 1:32  | 1930                       | Groove, light scale.   |
| 1:41  | 1685                       | Small groove.  |
| 1:44  | 1706                       | Deep groove.   |
| 1:50  | 1741                       | Deep groove near end.  |

TABLE 5.—*Temperatures on Forging Furnaces—(Continued)*

| TIME             | TEMPERATURE,<br>DEGREES F. | REMARKS  |
|------------------|----------------------------|--|
| 1:50             | 1767                       | Deep groove third from end.                      |
| 1:56             | 1663                       | Corner.  |
| 2:00             | 1373                       | Outside 24 in. section.                          |
|                  | 1576                       | Corner.  |
| 2:08             | 1315                       | Finish 24 in. section.                           |
|                  | 1576                       | Finish 13½ in.                                   |
| 2:14             | 1407                       | Finish 24 in.                                    |
|                  | 1407                       | Finish 13½ in.                                   |
| 2:22             |                            | Stop working.                                    |
| 1:58             | 2460                       | Right No. 2 K, No. 1 empty, flame right to left. |
| 2:03             | 2423                       | Left of No. 2 K, flame right to left.            |
| 2:26             | 2385                       | Left of No. 1 L; flame left to right.            |
|                  | 2285                       | Right of No. 1 L.                                |
|                  | 2233                       | Right of No. 2 L.                                |
|                  |                            | No. 3 empty.                                     |
|                  | 2233                       | Left of No. 4 L.                                 |
| 2:30             | 2221                       | Right of No. 4 L.                                |
| 2:32             | 2442                       | Combustion chamber of K.                         |
| <i>J Furnace</i> |                            |  |
| 3:56             | 2403                       | Bridge-wall; flame left to right.                |
|                  | 2321                       | No. 2 J left.                                    |
|                  | 2249                       | No. 2 J right.                                   |
|                  | 2124                       | No. 3 J right.                                   |
|                  |                            | No. 1 J and No. 4 J empty.                       |
|                  | 2148                       | No. 4 J, back wall.                              |
| <i>L Furnace</i> |                            |  |
| 4:00             | 1863                       | Left of No. 4 L, flame left to right.            |
|                  | 1913                       | Right of No. 4 L.                                |
|                  | 2039                       | Right of No. 3 L.                                |
|                  | 2148                       | Right of No. 2 L.                                |
|                  | 2128                       | Right of No. 1 L.                                |
| 4:05             | 2221                       | Combustion chamber, wall.                        |

The drop in temperature from one end to the other of the four-door furnaces on which readings were taken range from 164° to 308° F., depending on the length of time the ingots have been in, how fast the coal is being fired, and the type of furnace.

### CONCLUSIONS

It is possible to heat a 24-in. ingot from room temperature to forging temperature in 7 hr. but the question is raised whether this fast rate is not injurious to the steel, especially while the steel is still comparatively cold, large stresses being set up which may cause internal fissures. The rate at which an ingot can be heated without injury depends on the kind of steel, chrome steel being very tender while low-carbon steel will stand more abuse. Opinions differ on the length of time necessary to bring this size of ingot to temperature, but the best practice appears to indicate slower heating up to the critical temperature. The question is a difficult one to settle, however, as it depends on a number of variables.

It is difficult, if not impossible, to calculate the stresses set up at any

one point in an ingot, due to unequal expansion, and in that way determine what the maximum allowable difference in temperature between the outside and the center will be. If this could be done, it would be a simple matter to prescribe the rate of heating that any size ingot should have. The main source of information is the experience of steel men through years of practice on forging large ingots.

The results of the test show that an optical pyrometer can be used to determine when an ingot is ready to forge. To make sure that there is no error due to loose scale or ash, it is well to push a bar in the furnace and clean the spot on which the pyrometer is to be sighted. This being done, if the surface temperature is 100° F. higher than the temperature at which it is desired to forge, the ingot is ready to pull out. For instance, if the forging temperature is 2250° F. (1232° C.), should the optical pyrometer read 2350° F. (1287° C.), the ingot is ready to forge. The outside temperature of the ingot will drop very rapidly in the air and leave the center the hottest portion; for a 24-in. ingot, the difference between the outside and center is about 100° F.

The optical pyrometer can be used to determine gas temperatures approximately by sighting on the bricks of the back wall or by sighting on a target or in a tube. Usalite porcelain stands the forging-furnace temperature very well and quickly changes temperature with the gases, as will a target of thin metal. The target, however, does not stand the corrosive action of the gases for any length of time, a nichrome target lasting to a temperature between 2200° F. (1204° C.) and 2300° F. (1260° C.). The error due to making a reading through a light flame is approximately 20° F. Readings through light ash from a powdered-coal flame, with an optical pyrometer, do not appreciably affect the temperature read.

A couple on the surface of a large ingot may indicate a temperature approximately that of the gas and much above that of a point in the steel  $\frac{1}{2}$  in. under the surface.

The temperature gradient along the ingot from the door to a short distance inside the door is very large and must create serious stresses at that point.

From the rate of cooling of the 24-in. ingot, it appears that it can be worked for 2 hr. without working it too cold. This may not actually be the case as the thick scale drops off and the piece is worked down to smaller dimensions where it will cool more rapidly. On the other hand, working heats the piece and will tend to counterbalance more rapid cooling.

The amount of coal used in this test was approximately 0.25 lb. per pound of steel. The average amount of coal used for production work at this plant was 1 lb. per pound of steel. This shows that the furnaces can be fired much more efficiently.

In conclusion the writer wishes to thank Mr. G. R. Norton and Mr. R. C. Drinker for their hearty coöperation and interest in this investigation.

DISCUSSION

LAWFORD H. FRY, Burnham, Pa. (written discussion\*).—As a supplement to the information given by Mr. Bash, a diagram is submitted showing the results of a somewhat similar experiment carried out at the ordnance plant of the Standard Steel Works Co. In this case the ingot to be heated was a nickel-steel octagon ingot, weighing 14,700 lb. (6667 kg.). This ingot was to be forged into two 255-mm. howitzer jackets. A hole was bored half way of the length of the ingot, extending into the longitudinal axis, and a base-metal thermocouple inserted in this hole.

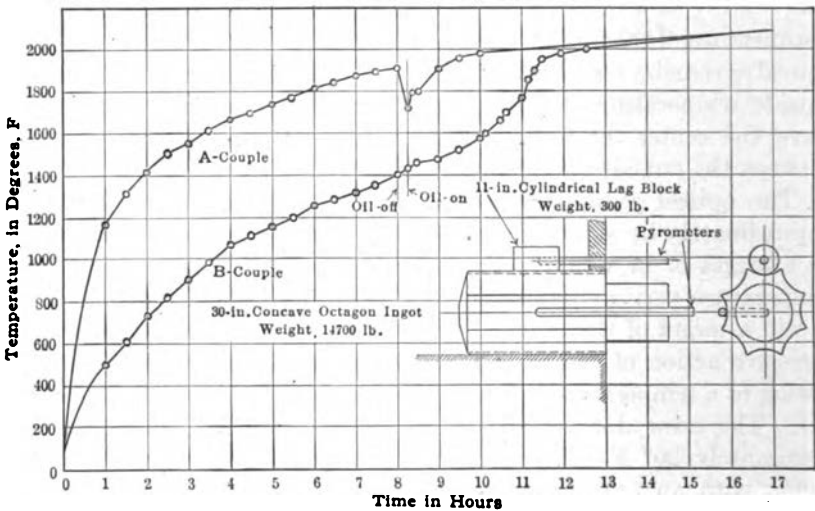

FIG. 4.—HEATING EXPERIMENT WITH 30-IN. CONCAVE OCTAGON INGOT N-85-B IN FORGE SHOP FURNACE.

In order to obtain the temperature of the exterior of the ingot, a similar couple was placed in the hole in a cylindrical lag block, 11 in. (28 cm.) in diameter, weighing 300 lb. This couple is the A-couple in the diagram, the couple in the ingot being the B-couple. The exterior or A-couple reached 2000°, which was the maximum temperature registered by the pyrometer in 10 hr., while the couple at the center of the ingot took approximately 2½ hr. longer to come to this temperature. The exterior temperature, measured by an optical pyrometer, was approximately 2100° at the end of 17 hr. The experiment was carried out in connection with the discussion of the proper time for heating large ingots for gun forgings and the results were presented to the Gun-Howitzer Club in September, 1918.

\* Received Sept. 30, 1919.

## Temperatures of Incandescent-lamp Filaments

BY BENJ. E. SHACKELFORD,\* PH. D., BLOOMFIELD, N. J.

(Chicago Meeting, September, 1919)

THE present paper is concerned with typical temperature values experienced in lamp-filament measurements as made on regular factory and engineering products. It deals with the relations existing between temperature, efficiency, lamp size, and life of incandescent lamps, in so far as they affect the rating of the product and its use by the individual consumer.

The temperatures measured lie in that range covered only by the general method of radiation pyrometry, as opposed to direct methods used under contact conditions. The range of temperatures ordinarily experienced extends from about 2125° K., for the now almost extinct carbon-filament lamp, to 3200° K. for the comparatively new tungsten-filament motion-picture lamp. Most of the more common sizes of tungsten lamps have temperatures ranging from 2500° to 3000° K. Because of the high temperatures involved and the relatively small area of the sources used, we are practically restricted to two methods of measurement, both of which depend on the light radiated from the filament. The first and more usual method is that of the Morse pyrometer, dependent on the variation in temperature of the amount of light of a given color range yielded by the filament. In this case, the measured temperature is that of a small part of the incandescent body, that is, the part which is focused on the comparison filament. The second method, known usually in this country as that of "color match" and in England as "color-identity" is based on the color of the total light yielded by the filament, the comparison being facilitated by the use of an ordinary photometer head.

A more definite idea of the temperatures involved in the case of filaments of various vacuum and gas-filled lamps is given by Fig. 1. The size of the lamp, in watts, is plotted along the horizontal axis and the temperature of the filament is plotted along the vertical axis. The lamps concerned are regular product, rated for 1000 hr. life. The temperature values for the old 16-candlepower carbon lamp and the new motion-picture lamp are shown by the cross and circle respectively. The life of the latter lamp is 100 hr. Lamps for ordinary lighting service yield, on the average, 1000 hr. of useful life; that is, they continue

\* Physicist, Westinghouse Lamp Works.

to give at least 80 per cent. of their original light for that length of time. A vacuum lamp usually fails from blackening, that is, from the deposit of the tungsten on the bulb surface. Since the smaller filaments are more affected by the loss of material than are the larger ones, it is neces-

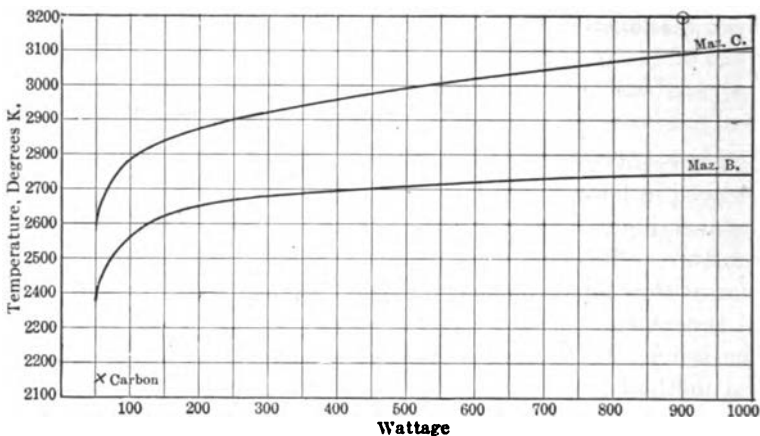

FIG. 1.—TEMPERATURE VS. WATTAGE FOR 1000 HR. LIFE.

sary to run the former somewhat cooler than the latter, in order that they may not fail before they reach the required hours.

In the case of gas-filled lamps, conditions are somewhat more acute. The presence of the gas lowers the vaporization, and carries the de-

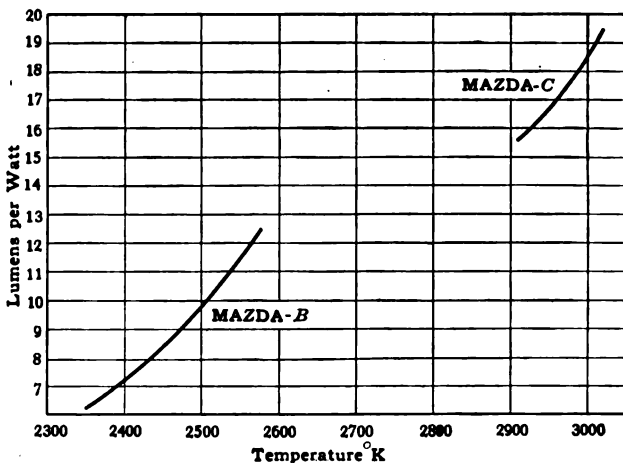

FIG. 2.—TEMPERATURE VS. EFFICIENCY, 100-WATT MAZDA B, 500-WATT MAZDA C (ARGON).

posited tungsten into a part of the bulb where it is relatively unobjectionable. Therefore, the filaments of most lamps are operated at such a temperature that they will have a burnout life of 1000 hr. Since

these lamps, therefore, are operated at a higher temperature than the vacuum lamps, any loss of material becomes more effective in hastening burnout. The small filaments are less able to stand this effect than they were in the vacuum lamps, and consequently the curve is steeper.

With a given lamp, the higher the temperature of the filament, the higher is the efficiency of the lamp. This, of course, is due largely to the fact that as the temperature is raised a larger part of radiated energy comes within the visible spectrum. Fig. 2 shows the relation between the temperature and efficiency, in lumens per watt, for one size of vacuum and one size of gas-filled lamp. Where, as here, we are considering the efficiency of the lamp as a whole, this curve will shift somewhat in going from one lamp size to another. In the gas-filled lamps there is also a shift from lamp to lamp, due largely to the dependency of the cooling

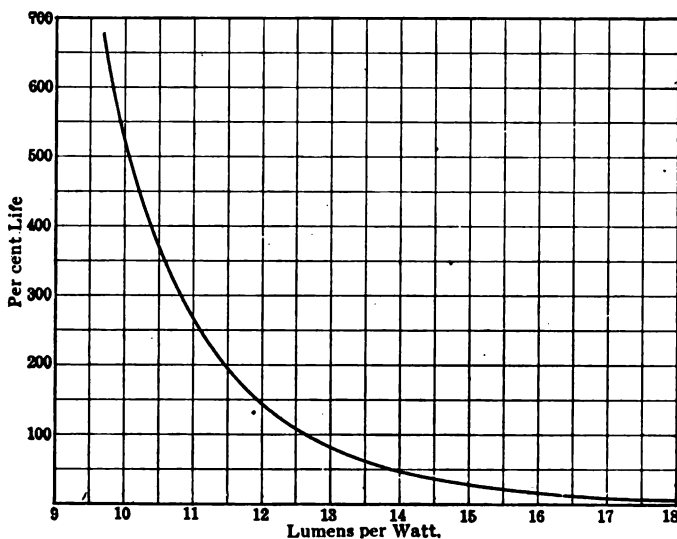

FIG. 3.—VARIATION OF LIFE WITH EFFICIENCY.

effect of the gas on the pressure of the gas and the concentration of the filament. This relation between the efficiency and temperature gives another method of measuring temperature, which is very useful to the lamp manufacturer.

Since with increased temperature comes increased efficiency, the obvious tendency is to raise the temperature of the filament to the highest point consistent with proper life. Fig. 3 shows the relation between efficiency and life for ordinary sizes of vacuum lamps. The actual operating temperature is governed by a proper balancing of the two relationships, the increase of efficiency and the shortening of life with increasing filament temperature.

Another important practical fact is that as the size of the lamp



is increased, the temperature necessary for a given efficiency is lessened. An instance of this is shown in Fig. 4. Particularly in the case of gas-filled lamps it is noticed that for the low wattages, the temperature necessary for this given efficiency is very much higher than in the case of the higher wattages. This is due to the fact that the relative energy loss due to gas cooling is much greater with small filaments than with large. Practically this means that there is a size below which the gas-filled lamp is less efficient than the vacuum lamp. This is shown explicitly in Fig. 5, where the ordinary efficiencies of the various wattage lamps are indicated. It will be noticed that in the case of the gas-filled lamps particularly, the larger sizes are more efficient. For this reason,

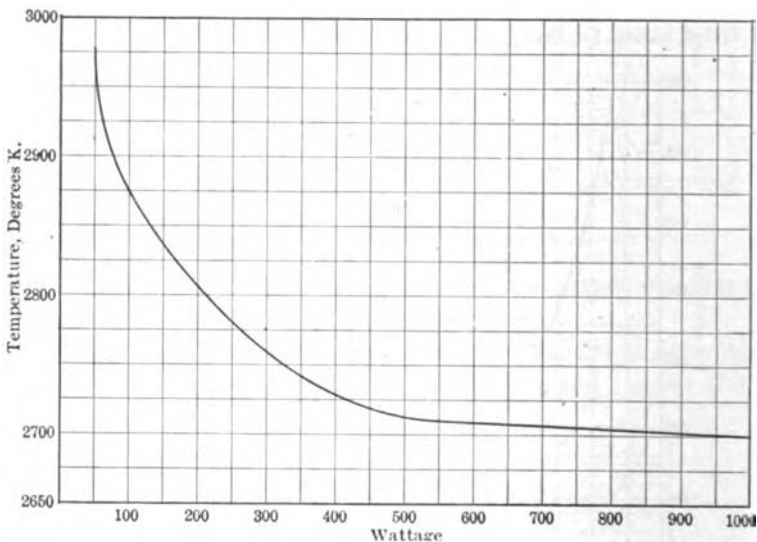

FIG. 4.—VARIATION OF TEMPERATURE WITH LAMP SIZE.

among others, large lamps are much more economical, for the same amount of light, than are small ones.

The 100-watt vacuum lamps operate at a temperature of  $2500^{\circ}$  K. when set up at an efficiency of 10 lumens per watt, or 1 watt per horizontal candle. A nitrogen-filled lamp at the same efficiency will operate at a temperature of  $2900^{\circ}$  K., and yet will have a somewhat longer life than the vacuum lamp. When the nitrogen is replaced by argon, the temperature at the same efficiency is only  $2800^{\circ}$  K. and the life is much better than in either of the other two cases—because of the lower thermal conductivity of argon. This gas, however, is much more expensive than nitrogen and the lamp manufacturers expend annually hundreds of thousands of dollars additional for the more useful gas. This expenditure results in a saving to the consumer of about twice the above mentioned amount.

The lead-in wires and supports naturally cool the filament a great deal and lessen the efficiency of a lamp. The distribution of temperature along a filament is shown in Fig. 6. These measurements were

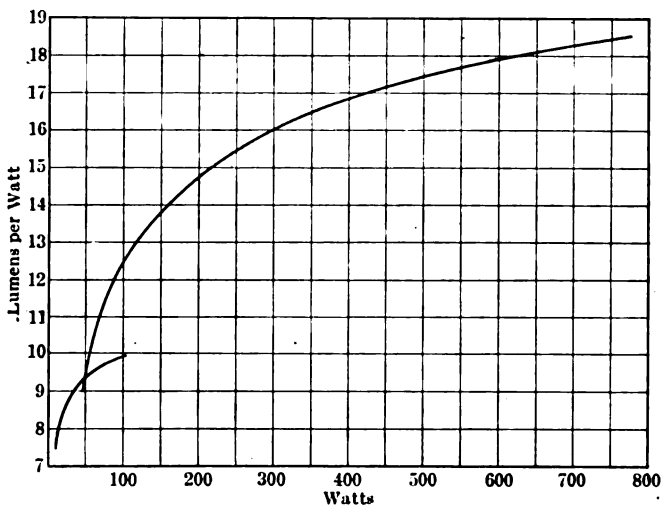

FIG. 5.—VARIATION OF EFFICIENCY WITH LAMP SIZE, 1000-HR. LIFE.

made on the comparatively short coils of street series lamps and show the different amount of cooling, due to varying amounts of contact by the support wires.

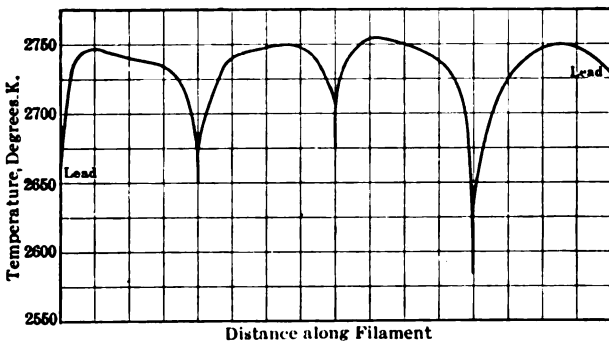

FIG. 6.—6.6 AMP. STREET SERIES LAMP, FOUR SECTIONS.

Incandescent-lamp filaments offer, not only some of the most interesting fields for optical pyrometry investigation of various types, but also they offer one of the most available and satisfactory groups of sources for such investigations. In other words, they offer both the problem and the means of solution.

## Temperature Measurements of Incandescent Gas Mantles

BY HERBERT E. IVES, PH. D., PHILADELPHIA, PA.

(Chicago Meeting, September, 1919)

THE incandescent gas mantle is of considerable interest from the standpoint of temperature measurement because it presents a series of apparent contradictions to the established laws of radiation on which are based some of our best methods of temperature determination. One of these contradictions is that the mantle of least brightness (of the commercial thoria-ceria group) is the one having the highest temperature; this, though explicable without any violation of radiation laws, was long a stumbling block to the understanding of the performance of the mantle. Another anomaly is that the energy radiated by the mantle decreases with the rise of temperature, thus apparently invalidating total radiation methods of pyrometry, based on the fourth-power law. The discussion of methods of measuring mantle temperature which follows is largely taken from an extensive study of the physics of the Welsbach mantle.<sup>1</sup>

The incandescent gas mantle consists of a skeleton of refractory oxide of very light weight and open structure, formed by the ignition of a cotton or silk "stocking" previously thoroughly impregnated with salts of certain rare earths. The mantle of commerce is a mixture of approximately 99 parts of thorium oxide with 1 part of cerium oxide. This mixture, discovered largely by accident, gives luminous radiation many times greater than that from either of the constituents taken alone. It is customary to speak of the thoria as the "base" and the ceria as the "colorant," and the commercial mantle represents one of a family in which an oxide of low emissive power is employed as a base, which will assume a high temperature, while a small amount of some other oxide of high visible emissive power is added, which will reduce the temperature of the mantle but little. This is, in general, the most efficient way, from the standpoint of visible emission, to utilize a substance of high emissive power in the visible spectrum. But it is not necessary that two substances should be employed to produce a radiator of high visible and low general emission. Some substances, of which lanthana is the best example, possess these characteristics naturally; it merely happens that the Welsbach mixture is as yet the most efficient radiator of this type known.

---

<sup>1</sup> Ives, Kingsbury and Karrer: A Physical Study of the Welsbach Mantle. *Jnl. Frank. Inst.* (Oct. and Nov., 1918) 186, 401, 585.

The methods of temperature measurement studied in the investigation above referred to were three: optical, total radiation, and by thermocouples. They will be taken up here in that order, which is their order of utility, from least to greatest.

### OPTICAL PYROMETRY APPLIED TO MANTLES

The optical method of measuring temperature was employed by Rubens in his study of the mantle. He used it, however, in a manner that could lead to correct results only with a completely opaque, completely absorbing body, which the mantle is far from being. Rubens' results were, however, substantially correct because he confined his observations to mantles rich in ceria and to the blue end of the spectrum, where the absorption band due to ceria is of high saturation. With mantles of low visible emissive power this method would have been inapplicable.

The optical method consists, in general, in measuring the black-body temperature by the usual method of equality of brightness used in the Holborn-Kurlbaum and Henning pyrometers, and then deriving the true temperature from a knowledge of the optical properties of the radiator.

- If  $r_\lambda$  = reflecting power of body at wave-length  $\lambda$ ;
- $J_\lambda$  = radiant emission of black body at same temperature;
- $E_\lambda$  = radiant emission;
- $t_\lambda$  = transmitting power;

from Kirchoff's law;

$$E_\lambda = J_\lambda (1 - r_\lambda - t_\lambda)$$

providing the surface under study is continuous. If it is discontinuous (as a grid of fine fibers would be), if  $s$  represents the fractional part of the area occupied by the solid material,

$$E_\lambda = J_\lambda s (1 - r_\lambda - t_\lambda)$$

Using Wien's law, this gives for the true temperature  $T$ , in terms of the apparent or black-body temperature  $T_a$ .

$$\frac{1}{T} - \frac{1}{T_a} = \frac{\lambda}{c_2} \log s (1 - r_\lambda - t_\lambda)$$

In this formula, the constants  $s$ ,  $r$ , and  $t$  refer to the properties of the hot body, which are usually different from those of the cold.

It is obvious that accurate temperature determinations by this method would demand very elaborate measurements to establish the

### 634 TEMPERATURE MEASUREMENTS OF INCANDESCENT GAS MANTLES

hot porosity, reflecting, and transmitting powers. In the case of the mantle, such measurements are practically out of the question. The best condition for applying the method holds at the edge of the mantle, where it appears continuous by projection, so that  $s$  approximates unity. Also, by working near the edge of the mantle  $r$  reaches its nearest approximation to the reflecting power of a thick opaque layer of the mantle oxide in powdered form. The latter is capable of accurate measurement in the cold condition, and it is not difficult to obtain the ratio of hot to cold reflecting power by measuring the brightness of the image of an arc crater focussed on the hot and cold mantle.

The possibility thus exists of obtaining accurate results from the edge of the mantle, if we can safely assume  $t = 0$  and  $r =$  reflecting power of a solid layer. We may so assume in the case of strongly absorbing substances, but experiments with various mixtures of thoria and ceria show that these assumptions hold only for mantles rich in ceria, and are quite unwarranted with mantles in general. This point was tested in several ways, one of which was by making up mantles with continuous patches formed by sewing small rectangles of filter paper on the mantle fabric. Certain of these were selected which, when viewed normally, copied the behavior of the edge of the ordinary mantle structure. These patches were found, on measurement, in the case of pure thoria to have a reflecting power of only 0.55, while the solid layer has a reflecting power of 0.85. Moreover, upon examining the brightness of the patch when illuminated, it was found that the unilluminated side was over half as bright as the illuminated, showing that a very large part of the incident light is transmitted, even by the edge of the mantle.

It therefore appears, as is borne out by our complete data, that the optical method, which should give accurate results for opaque layers of radiating material, is not applicable to mantles in general. In the regular 99-per cent. thoria, 1-per cent. ceria mantle, the black-body temperature differs by an amount less than the errors of measurement from the temperature as derived from the introduction of the hot reflecting power, assuming the transmission zero, as long as the measurements are made in the extreme blue. Therefore no test of the method is afforded by such measurements. In the case of the pure-thoria mantle, however, the nearest approach to the true temperature (as obtained by graduated thermocouples) that the complete optical method gives, even if  $r$  and  $t$  are assumed to amount together to the reflecting power of an opaque layer, namely, 85 per cent., falls short by as much as 100°. This failure is, in part, due to the error in the value of  $r$  and  $t$  assumed for the cold mantle and, in part, perhaps to an actual increase of transparency with increase in temperature. In any event, it illustrates clearly the inapplicability of the method.

MANTLE PYROMETRY BY TOTAL RADIATION

Measurements of the total radiation from all the mantles studied were carried through, by means of a surface thermopile. It was early found that when the temperatures measured by graduated thermocouples were assumed as the correct ones, the radiation for constant gas consumption was not constant, but decreased with increasing mantle temperature. Thus a black-bulb thermometer placed so as to be heated by the radiation from mantles of various compositions would exhibit the apparent anomaly of showing the greatest temperature rise for the mantle of lowest temperature. In the thoria-ceria series, the black-bulb thermometer, or any total radiation pyrometer, would show the highest reading for the mantle of pure ceria, and steadily decreasing readings until pure

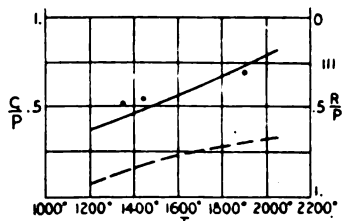

FIG. 1.—CONVECTION LOSSES AS CALCULATED FROM SPECIFIC HEAT OF PRODUCTS: C, CONVECTED ENERGY; P, APPLIED ENERGY; R, RADIATED ENERGY. FULL LINE IS COMBUSTION IN AIR. BROKEN LINE IS COMBUSTION IN OXYGEN.

thoria was reached, with no reflection whatever of the enormous luminous maximum at the 99-per cent. thoria point. A relationship of this sort, besides demanding explanation, offers a possible method of temperature measurement.

The explanation lies in this fact: that, for a given constant consumption of gas (rate of supply of energy), the portion of the total power dissipated by convection and conduction is greater the higher the temperature. Consequently the rest of the applied energy, which can escape only as radiation, must be smaller the higher the temperature. The convection losses (beside which the conduction losses are small) may be calculated with considerable accuracy, by making a heat balance for the mantle and burner. If it is assumed that the products of combustion leave the mantle at the temperature of the latter, we can, by knowing the specific heats of these products and their amount, calculate the amount of energy carried away by them. The difference between this and the energy input will be the radiation.

The result of carrying through these calculations for a mantle of several different temperatures is shown in Fig. 1. A gas of 630 B.t.u. per cu. ft. was assumed, and the specific heats of the products of combustion in B.t.u. per cu. ft. of gas consumed per degree centigrade at various

## 636 TEMPERATURE MEASUREMENTS OF INCANDESCENT GAS MANTLES

temperatures were plotted from standard tables. The calculation then consisted in comparing this specific heat with the initial. It appears from the figure that the convection loss rises, in a nearly linear manner, from 45 per cent. for a mantle at 1350° K. to 75 per cent. for a mantle at 1900°. The radiation must correspondingly decrease.

Fig. 2 exhibits the relation actually found, between temperature  $T$  (centigrade absolute) and the radiation  $R$ , in arbitrary units, for a set of mantles composed of various refractory oxides. It is clear that the general linear relationship holds, but, at the same time, that total radiation methods give only a comparatively rough measure of temperature.

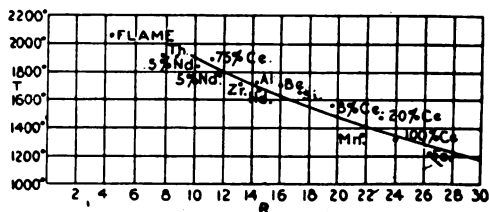

FIG. 2.—EXPERIMENTALLY FOUND RELATION BETWEEN TEMPERATURE AND RADIANCE.  $R$ , RADIANCE IN ARBITRARY UNITS;  $T$ , TEMPERATURE.

It is obvious that the relationship established between temperature and total radiation for the mantle is entirely conditioned by the escape of energy by convection. Where the heating is done in vacuo, as by cathode discharge, no such relation holds. It is to this fact indeed that the enormously greater brilliancy of thoria over ceria, when heated in the cathode stream, is due.

### MANTLE PYROMETRY BY THERMOCOUPLES

Quite the most satisfactory method of mantle temperature measurement, on the whole, is that which utilizes a series of thermocouples of graduated size, first utilized by Nichols for flames, and later by White and Travers for the incandescent mantle. The theory in its simplest form is that, while a single thermocouple will not give correct readings, due to the heat it radiates and conducts away, this error is less the smaller the couple. So by using a series of decreasing size, the value that would be given by a couple of zero mass may be fixed by extrapolation.

The temperatures of the ordinary mantles and the Bunsen flame are fortunately within the range of the platinum-platinum-rhodium couple. We have used successfully a series of diameters 0.35, 0.25, 0.15, and 0.05 mm., secured from Engelhardt and calibrated by the Bureau of Standards. Certain precautions were observed in their use, some obvious and some learned by experience. As great a length as possible of the couple should lie against the mantle. The bead should be as nearly as possible

of the same diameter as the wires it connects. After continued use, the couples may give inconsistent results, perhaps due to contamination; when this condition is evident, the beads may be cut off and new ones fused.

It is ordinarily assumed that the points given by such a series of thermocouples lie on a straight line. Our results on the couples described indicate consistently that these points lie on a curve. Some representative results are shown in Fig. 3 for mantles of different com-

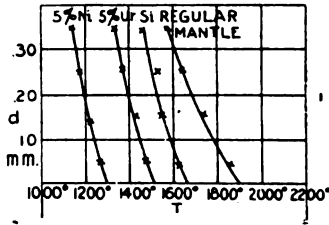

FIG. 3.—MEASUREMENT OF MANTLE TEMPERATURE BY THERMOCOUPLES OF GRADUATED DIAMETER.  $d$ , THERMOCOUPLE DIAMETER;  $T$ , TEMPERATURE.

positions and temperatures. The curvature is well shown, and it appears as well that with the lower-temperature mantles the curve is more nearly perpendicular to the temperature axis, that is, that the couples differ less in their readings.

The accuracy attainable by the thermocouple method, while far greater than that given by the preceding methods, is not comparable with what thermocouples will do under less trying conditions. A good set of readings, using the potentiometer, will usually fix the temperature of the mantle within  $20^{\circ}$  to  $30^{\circ}$ , but great care must be taken to place the bead upon exactly the same point in the mantle with each couple.



### Application of Pyrometry to Problems of Lamp Design and Performance

BY I. H. VAN HORN,\* B. S., CLEVELAND, OHIO

(Chicago Meeting, September, 1919)

In the development of the incandescent electric lamp, one aim of the investigators has been to establish the fundamentals of lamp design, so that the performance of any new lamp may be accurately predicted. The study of the temperature relations in lamps has done much toward establishing these fundamentals. Fig. 1 gives the typical

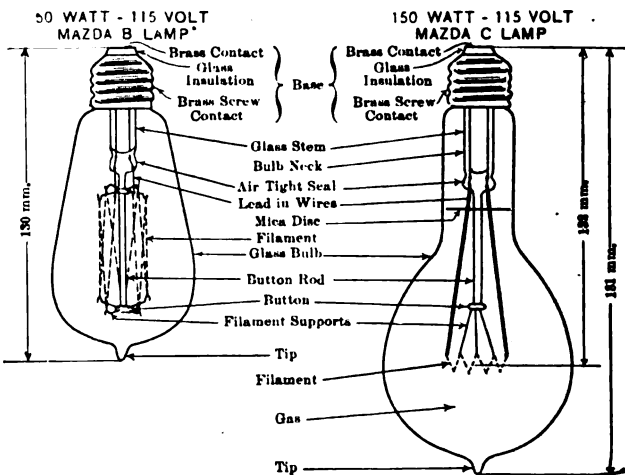

FIG. 1.—ARRANGEMENT OF PARTS IN MAZDA B AND MAZDA C LAMPS.

arrangement of the lamp parts in both the Mazda B (vacuum) and Mazda C (gas-filled) lamps. The outstanding differences are the filament form and the bulb shape.

The ideal lamp is one in which the filament operates at a uniform temperature throughout its length. In practice, it is necessary to disturb this uniformity by the introduction of supports and terminals. The amount of cooling at the supports and terminals affects the over-all efficiency of the filament as a light producer. The life of the lamp is ordinarily proportional to the maximum and not to the average filament temperature. The Holborn-Kurlbaum type of optical pyrometer has

\* Physicist, National Lamp Works, General Elec. Co.

been used for determining the temperature gradients in lamp filaments.<sup>1</sup> The cooling effects of supports and terminals have been evaluated.<sup>2</sup>

Fig. 2 illustrates the cooling effect of supports in a vacuum lamp. The terminals *a* and *b* are 16-mil copper; the supports *c*, *d*, and *e* are 10-, 20-, and 40-mil copper, and the supports *f*, *g*, *h*, and *i* are 2-, 4-, 8-, and 16-mil molybdenum. The length of filament cooled depends on the size and material of the supports and terminals, the size and material of the filament,<sup>3</sup> and the maximum filament temperature. The cooling of the filament at terminals and supports is a very important factor in the designing of low-voltage lamps. The filament used in the ordinary pocket flashlight lamp is about 3 mm. long and the effect of end cooling extends over its whole length. In lamps of this type the average filament temperature is much lower than the maximum.

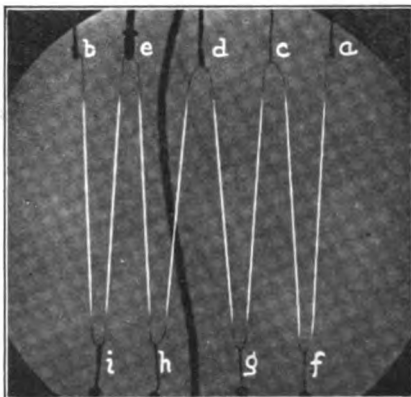

FIG. 2.—SPECIAL VACUUM LAMP WITH SUPPORTS OF DIFFERENT MATERIALS AND SIZES

The control of temperature distribution in the vacuum lamp is much simpler than in the gas-filled lamp. In the gas-filled lamp the filament is cooled, not only by the conduction of the supports and terminals but also by gas conduction and convection.<sup>4</sup> The arrangement of the filament therefore becomes of prime importance in obtaining the most uniform filament temperature as well as the lowest maximum temperature for a given efficiency of light production. Fig. 3 is a photograph of a 100-watt Mazda B construction lamp filled with gas. The lamp was burning tip down when photographed. The upper portion of the filament is operating at a much higher temperature than the lower. This shows the necessity for a different mount design for the gas-filled lamp.

<sup>1</sup> Hyde, Cady and Worthing: *Trans. Ill. Eng. Soc.* (1911) **6**, 238.

<sup>2</sup> Amrine: *Trans. Ill. Eng. Soc.* (1913) **8**, 385. Worthing: *Phys. Rev.* [2] (1914) **4**, 524.

<sup>3</sup> Worthing: *Phys. Rev.* [2] (1914) **4**, 535. <sup>4</sup> Langmuir: *Phys. Rev.* (1912) **34**, 401.

It is advantageous to coil the filament wire in the form of a helix in order to reduce the energy loss due to the gas and to give a more uniform filament temperature. The curves of Fig. 4 show a much lower gas loss for the coil filament than for a straight filament of the same diameter.

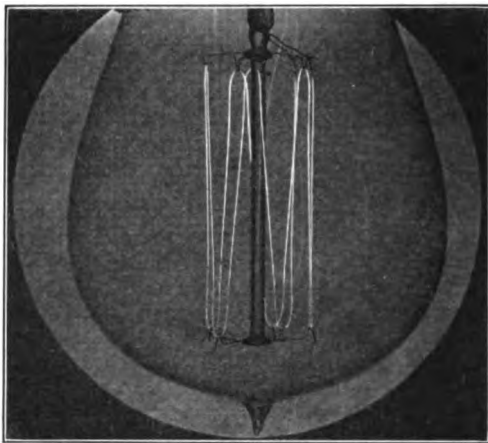

FIG. 3.—100-WATT MAZDA B CONSTRUCTION LAMP WHICH HAS BEEN GAS-FILLED.

The gas loss may also be different for variations in the pitch and mandrel of filament coiling.

The optical pyrometer has been of great assistance in studying these effects. The temperature at any point on the filament can be measured quickly and accurately and different observers find no difficulty in ob-

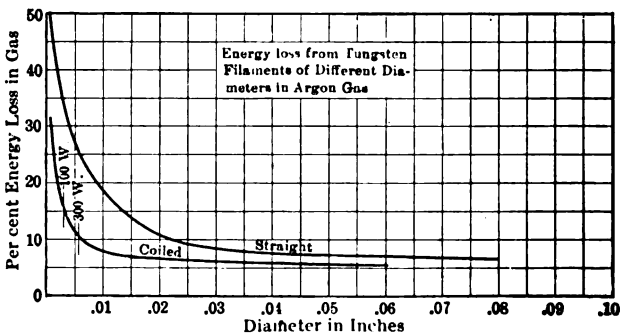

FIG. 4.—PER CENT. GAS LOSS FOR STRAIGHT AND COILED FILAMENTS IN GAS.

taining results that agree closely when they use the same temperature scale as a basis for calibration. The errors and limitations in optical pyrometry have been thoroughly studied and discussed by various research laboratories<sup>5</sup> in connection with high-temperature investigations.

<sup>5</sup> Worthing and Forsythe: *Phys. Rev.* [2] (1914) 4, 163.

The determination of the average filament temperature by the optical pyrometer method is rather tedious since it requires a large number of observations. An optical pyrometer apparatus has been developed in

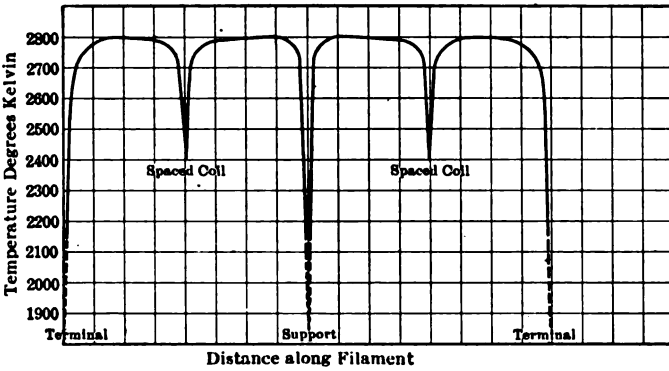

FIG. 5.—TEMPERATURE DISTRIBUTION IN A MAZDA C LAMP.

the laboratory with which the author is connected, which facilitates the measurements on a lamp filament. The motion of the lamp carriage is controlled by the observer as he watches the image of the filament through

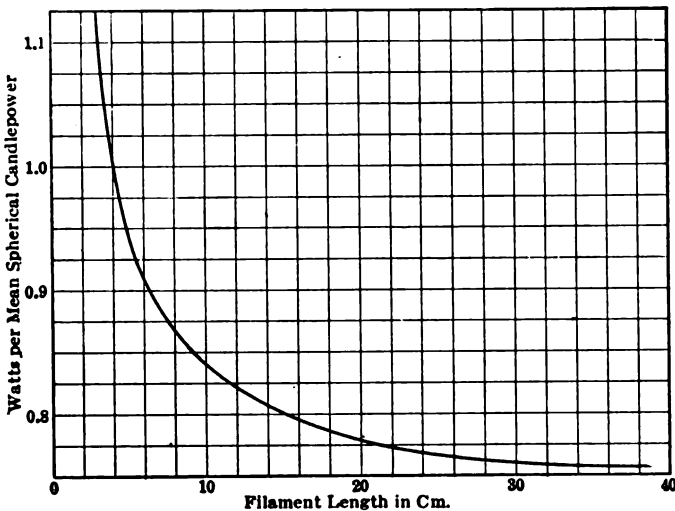

FIG. 6.—EFFICIENCY FOR DIFFERENT FILAMENT LENGTHS IN A MAZDA C STREET SERIES LAMP.

the telescope. He can move it up or down, to the right or left, and forward and backward, and can rotate it.

Fig. 5 shows the temperature distribution curve for a common form of Mazda C lamp. The filament coil was arranged in the form of a *W*

with the support at the upper central point of the *W*. The temperature distribution in a coil mounted vertically is less uniform than in a coil mounted horizontally. The maximum temperature in the vertical coil is usually toward the upper end. The gas loss is slightly greater for the horizontal coil. The curve in Fig. 6 shows the relation between efficiency and filament length for the same maximum filament temperature. This serves to emphasize the fact that the watts per mean spherical candlepower does not necessarily indicate the temperature of the filament. However, for lamps of the same wattage and design, the watts per mean spherical candlepower may be taken as proportional to the average filament temperature.

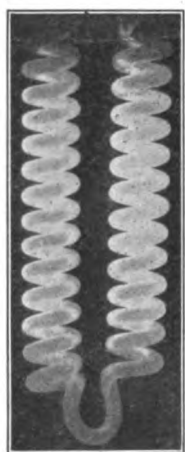

FIG. 7.—LIGHTED COIL FILAMENT.

One of the very simple methods of determining the average filament temperature is the use of the filament as a resistance element of a resistance pyrometer. The ratio of the resistance at high temperature to the resistance at room temperature gives a measure of the absolute temperature for a given quality of filament wire.<sup>6</sup> This method has the disadvantage that it is not independent of the wire quality nor is it quite as sensitive as some other methods.

The average filament temperature may also be measured by the color-match<sup>7</sup> photometer method. The ordinary Lummer-Brodhun photometer sight-box is suitable for this work. The lamp of unknown filament temperature is placed in the test socket of the photometer and the comparison lamp voltage is varied until there is no apparent difference in the color of the two fields. Temperature measurements made by the color-match method are reliable only

when the character of the filament radiation is known to agree with that for which the calibration is made. The radiation from a straight filament or from the outside of a coiled filament has been found to be of a different quality than the radiation from the inside of a coiled filament. The light from the inside is redder<sup>8</sup> than that from the outside.

The temperature of a coiled filament may be measured with an optical pyrometer by sighting upon the outside of the helix, since the quality of the radiation from the outside is unaffected by coiling. Fig. 7 shows a lighted coil filament and shows the difference in brightness on the inside and the outside of the helix.

<sup>6</sup> Langmuir: *Phys. Rev.* [2] (1916) 7, 306.

<sup>7</sup> Hyde, Cady and Forsythe: *Phys. Rev.* [2] (1917) 10, 395.

<sup>8</sup> Langmuir: *Op. cit.*, 152.

Coblentz: U. S. Bureau of Standards *Bull.* 14 (1918) 115.

The maintenance of a vacuum-tight seal is essential to the successful operation of all incandescent electric lamps. The stem seal is therefore one of the vital points of the lamp. While glass is a very good electrical insulator at room temperatures, it becomes somewhat conducting at

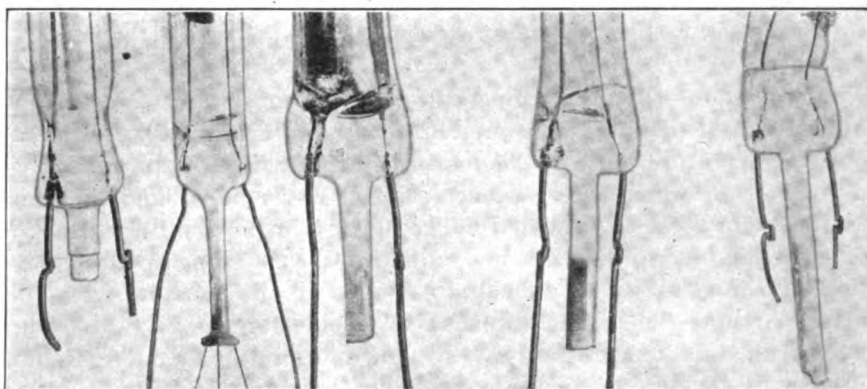

FIG. 8.—GLASS STEMS FROM MAZDA C LAMPS CRACKED AS A RESULT OF ELECTROLYSIS.

the temperature attained in incandescent lamps. The lamp design must be such that the stem temperature will be safe from the standpoint of electrolysis of the stem. The stem temperature may be measured

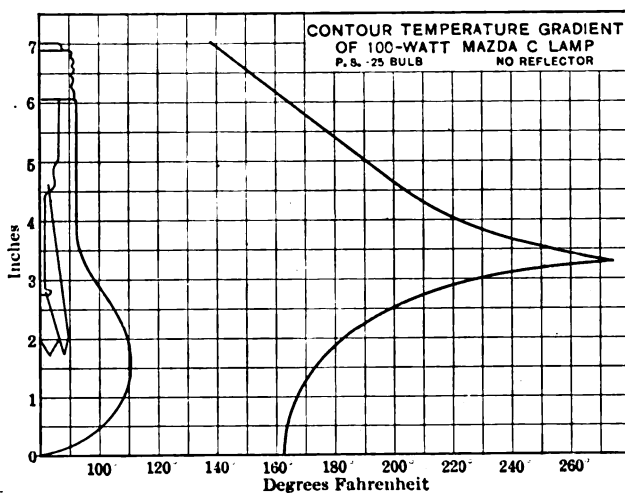

FIG. 9.—BULB TEMPERATURE DISTRIBUTION IN A MAZDA C LAMP.

by inserting a small thermocouple in the stem press when making the stem. Fig. 8 shows the results of stem electrolysis; the glass has cracked along the weld seal wires.

In the gas-filled lamp the stem temperature is affected by the bulb

shape and size, the distance of the stem seal from the filament, the wattage of the lamp, the deflectors used, and the condition of operation, whether in enclosed or open lighting fixtures, and whether with base up or down, or horizontal, or at an angle. It is therefore necessary to make stem-temperature measurements under conditions equivalent to those met with in the most severe service for which the lamp is designed.

Fig. 9 shows the bulb temperature distribution in a certain type of Mazda C lamp operated base uppermost with no enclosing fixture. The bulb temperature may be conveniently measured with the resistance pyrometer in which the resistance element is wound around the bulb at the point to be investigated. The upper limit for bulb temperature of good lamp performance is not ordinarily the softening or devitrification of the glass. It is difficult to remove all the moisture from the glass parts at the time of exhaust. The moisture may be given up later, if the bulb temperature is very high, and result in an inferior lamp. Change in the bulb size or shape may give a more favorable temperature distribution.

Temperature measurements have played an important part in fixing the present designs of the Mazda lamp. Some of the methods found useful in studying the temperature relations have been discussed and some of the results indicated.

## DISCUSSION

A. G. WORTHING, Nela Park, Cleveland, O.—There is a very definite relation that is helpful in the measurement of tungsten-filament temperatures by means of a resistance. Plotting the log of the resistance against the log of the temperature, for the range from 1300° to 3200° K., gives a straight-line relation. A great many points taken in a careful test lie very close indeed to the straight line. This is different from the relation Mr. Northrup found for tin.

## Temperature of a Burning Cigar

BY T. S. SLIGH, JR.,\* M. S., AND HENRY R. KRAYBILL,† PH. D., WASHINGTON, D. C.

(Chicago Meeting, September, 1919)

OF all the qualities that are essential in a good cigar tobacco none is quite so important as the burn. This term is general and includes many points, the most important of which are evenness of burn, color of ash, firmness and coherence of ash, and fire-holding capacity. The fire-holding capacity refers to the length of time the leaf or cigar will continue to glow after ignition.

Chlorides tend to prevent complete combustion and products are formed thereby that are injurious to the flavor and aroma. On the other hand, the carbonates of the alkalis, particularly of potassium, aid the combustion and increase the fire-holding capacity. Barth<sup>1</sup> thought that the harmful effect of the chlorides was due to their fusing and coating the tobacco, thereby preventing complete combustion. Schlosing,<sup>2</sup> Nessler,<sup>3</sup> and Garner,<sup>4</sup> suggested widely different theories to account for the favorable action of potassium salts. In order to study carefully the action of the various salts upon the course of combustion of the cigar a knowledge of the temperature of the burning cigar is necessary. Lehmann,<sup>5</sup> who seems to be the only investigator who has made any attempt to determine the temperature of a burning cigar, gives 480° C. as the maximum temperature which he recorded. It is evident, however, that his measurements were in error, probably on account of the method and apparatus used, since the lowest visible red corresponds to a temperature of about 575° C.

The object of the present investigation<sup>6</sup> was to develop a method of

---

\* Assistant Physicist, U. S. Bureau of Standards.

† Assistant Physiologist, Bureau of Plant Industry, U. S. Dept. of Agriculture.

<sup>1</sup> Max Barth: Untersuchungen von im Elsass gesogenen Tabaken und einigen Beziehungen zwischen der Qualität des Tabaks und seiner Zusammensetzung. *Landw. Ver. Stat.* (1891) **39**, 81-104.

<sup>2</sup> Th. Schlosing: Über die Verbrennlichkeit des Tabaks. *Landw. Ver. Stat.* (1891) **9**, 98.

<sup>3</sup> J. Nessler: Dungungsversuche zu Tabak. *Landw. Ver. Stat.* (1881) **29**, 309-312.

<sup>4</sup> W. W. Garner: Relation of the Composition of the Leaf to the Burning Qualities of Tobacco. *Bull.* 105, Bureau of Plant Industry, U. S. Dept. of Agriculture.

<sup>5</sup> K. B. Lehmann: Chemische und Toxikologische Studien über Tabak, etc. *Archives für Hygiene* (1908-09) **68**, 319.

<sup>6</sup> The work presented in this paper was performed in 1916. Determinations upon cigars of varying ash and moisture content were planned with a view to ascertaining the effect of these factors upon the temperature attained but up to the present time it has not been found feasible to carry out this program.



determining the maximum temperature within the burning cigar which would eliminate the theoretical objections to the methods employed previously (*i.e.*, a possibility of low readings due to heat conduction along the thermocouple wires and to a leakage of cold air into the junction) and to determine approximately the maximum temperature attained in cigars smoked under ordinary conditions or as near to such as the method of taking readings would permit.

The thermocouples were composed of the following wire: platinum 0.01 cm. and 0.015 cm. in diameter and platinum 10 per cent. rhodium of the same diameters supplied by J. Bishop Platinum Works. The potentiometric method of measurement was used. The set up was as shown in Fig. 1; a diagram of the electrical connections is given in Fig. 2.

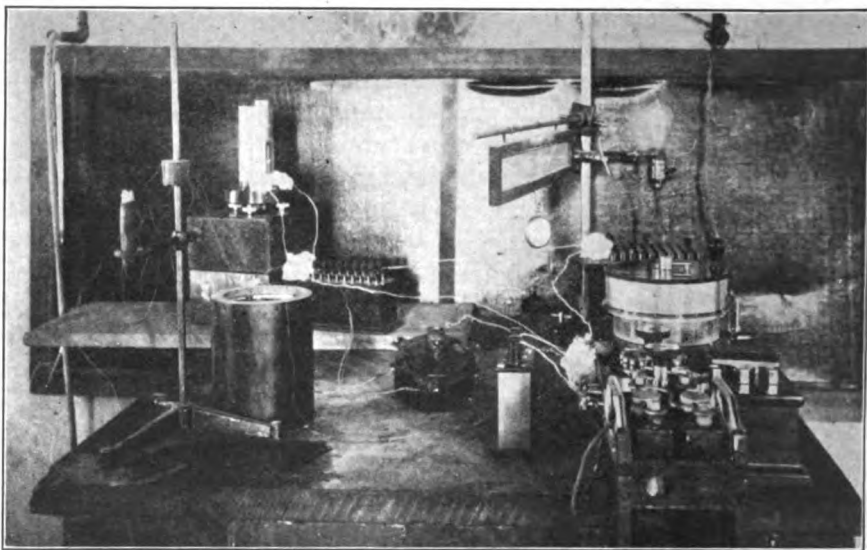

FIG. 1.—APPARATUS USED TO OBTAIN TEMPERATURE OF BURNING CIGAR.

In order to eliminate conduction and leakage, it was decided that only couples composed of very small wires should be used, so the platinum-rhodium couple was chosen as offering greater reliability and less chance of trouble due to brittleness of the wire in the smaller sizes.

A small glass capillary tube drawn down to a point was thrust through the cigar at a point about 2.5 cm. from the tip of the cigar as shown in Fig. 3. One of the wires of the couple was then passed into this tube and so through the cigar, the tube drawn through the cigar and removed from the wire, and this wire joined to the other wire of the couple by arc welding. The junction having been made, it was trimmed down and pulled back to the longitudinal axis of the cigar and the small holes around the wire plugged with paper pulp. In this way the junction was located in the region of highest temperature, the filler of the cigar

was disturbed to only a very small extent and good insulation between the wires was secured without the necessity of introducing additional heat-absorbing material into the cigar. The smaller couple *No. 1* was

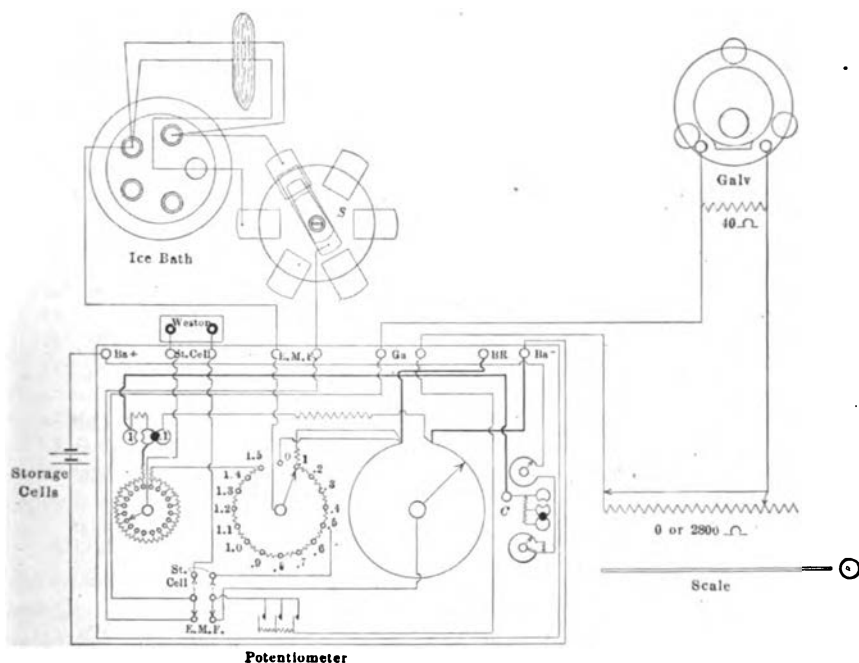

FIG. 2.—ELECTRICAL CONNECTIONS OF APPARATUS.

located about 2.5 cm. from the tip with the larger couple *No. 2* about 2 cm. farther back.

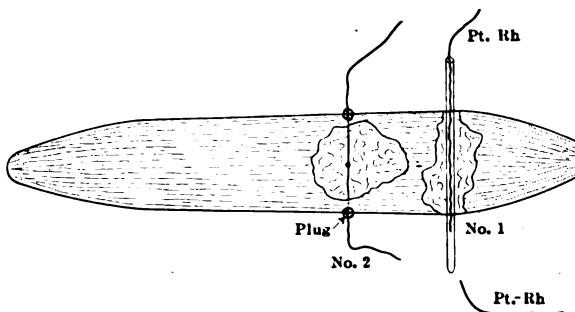

FIG. 3.—PLACING JUNCTIONS IN CIGAR.

The apparatus was adjusted and the cigar lighted. As soon as a temperature near 300° C. was indicated, readings were taken of the highest temperature reached during the puff, and of the temperature in the coal or cigar about 30 sec. after the puff. These latter readings were taken to determine whether the point of highest temperature had

been reached as indicated by a rising or falling temperature. The time interval between puffs was  $1\frac{1}{2}$  min. and the duration of the puff was from 5 to 8 sec. An attempt was made to keep the draft and, consequently, the rate of combustion, normal. When the temperature indications began to decrease on successive puffs, the other junction was switched into the circuit and a similar set of readings taken; see Table 1. The couples, as taken from the ash, were usually checked standardized with boiling sulfur as a reference point.

TABLE 1.—Data from Single Cigar

| No. | Temperature, Degrees C. |                  |              |                  |
|-----|-------------------------|------------------|--------------|------------------|
|     | Couple No. 1            |                  | Couple No. 2 |                  |
|     | Puff                    | After            | Puff         | After            |
| 1   | 708                     |                  | 472          |                  |
| 2   |                         | 415              |              | 426 <sup>a</sup> |
| 3   | 853                     |                  | 594          |                  |
| 4   |                         | 532              |              | 536 <sup>c</sup> |
| 5   | 878                     |                  | 730          |                  |
| 6   |                         | 620 <sup>a</sup> |              | 634 <sup>c</sup> |
| 7   | 832                     |                  | 793          |                  |
| 8   |                         | 693 <sup>a</sup> |              | 708 <sup>a</sup> |
| 9   | 859                     |                  | 829          |                  |
| 10  |                         | 753 <sup>a</sup> |              | 738              |
| 11  | 892                     |                  | 904          |                  |
| 12  |                         | 803 <sup>a</sup> |              | 772 <sup>b</sup> |
| 13  | 817                     |                  | 910          |                  |
| 14  |                         | 769              |              | 707 <sup>d</sup> |
| 15  | 797                     |                  |              |                  |
| 16  |                         | 609              |              |                  |

<sup>a</sup> Holds this temperature.    <sup>b</sup> Cools.    <sup>c</sup> Rising.    <sup>d</sup> Couple dropped out of cigar.

Readings as indicated were taken upon a number of different cigars designated by letter. Table 1 is typical of the data obtained on each cigar. Table 2 is a résumé of maximum temperatures obtained during the puff and in the coal. Complete data for each cigar, standardization and check points for thermocouples, etc., are omitted as unnecessary detail.

It is noted, upon comparing the readings taken on different cigars, that the maximum temperatures vary considerably from one cigar to the next. This probably can be accounted for by a variation in the moisture present and a variation in the compactness of the cigar, which would influence both the rate of combustion by limiting the draft and the availability, or rather the suitable arrangement, of the material present for free combustion. Another source of uncertainty is the possible presence of voids in the cigar at or near the junction. Again, since puffing is not

continuous it might well be that in some cases the junction is not located just at the point of highest temperature during a puff; this would explain the small differences existing between the readings indicated by couple No. 1 and couple No. 2 in the same cigar, see Table 2.

TABLE 2.—*Maximum Temperatures in Cigars*

| Cigar | During Puff, <sup>a</sup> Degrees C. |              | In Coal, <sup>b</sup> Degrees C. |              |
|-------|--------------------------------------|--------------|----------------------------------|--------------|
|       | Couple No. 1                         | Couple No. 2 | Couple No. 1                     | Couple No. 2 |
| I     | 835                                  | 839          |                                  | 658          |
| J     | 865                                  | 842          | 717                              | 668          |
| K     | 886                                  | 887          | 584                              | 629          |
| L     | 925                                  | 813          | 670                              | 657          |
| M     | 807                                  | 825          | 803                              | 708          |
| N     | 837                                  | 802          |                                  |              |
| O     | 892                                  | 910          |                                  |              |

<sup>a</sup> Corresponding readings in the same cigar with different couples.

<sup>b</sup> Readings taken at random where temperature in coal was stationary or approximately so. These readings were not taken consistently as their value was not fully appreciated at time tests were run.

A comparison of the maximum temperatures, as indicated in Table 2, shows that the readings with the two couples in the same cigar vary much less than the readings of any two cigars that might be compared. This indicates that the moisture content, chemical composition, and physical condition of the cigar may influence the maximum temperatures attained.

The platinum-rhodium couples were selected of different sizes of wire in order that any great lowering of temperature due to conduction along the wires might show up as a consistently low reading of the larger couple. As the indicated maximum is greater first in one couple and then in the other, it is only reasonable to assume that the conduction effect in these small couples is negligible. Finally, though it may seem that the temperatures shown in Table 2 are rather high, a comparison of the color brightness of the tip of a lighted cigar with the color of the walls of a furnace known to be at some temperature near 900° C. will go far toward removing any doubt one may have as to the possibility of the existence of such temperatures in the cigar.

#### SUMMARY

1. A method of determining the temperature of the burning cigar which seems to give satisfactory results is described.

2. The maximum temperature recorded is 925° C., if we may disregard the reading of 950° C. as doubtful because the readings taken before and after the puff in that case indicate a much lower maximum, because a decided and well-supported maximum occurs later on and because the readings taken with couple No. 2 in the same cigar gave a very much

lower maximum temperature. The maximum temperatures recorded were as follows:

|              | Couple No. 1,<br>Degrees C. | Couple No. 2,<br>Degrees C. |            | Couple No. 1,<br>Degrees C. | Couple No. 2,<br>Degrees C. |
|--------------|-----------------------------|-----------------------------|------------|-----------------------------|-----------------------------|
| Cigar I..... | 835                         | 839                         | Cigar M... | 807                         | 825                         |
| Cigar J..... | 865                         | 842                         | Cigar N... | 837                         | 802                         |
| Cigar K..... | 886                         | 887                         | Cigar O... | 892                         | 910                         |
| Cigar L..... | 925                         | 813                         |            |                             |                             |

3. The highest stationary temperature recorded in the coal was 803° C. The average temperature will, of course, depend on the zone over which the average is taken. The maximum stationary temperatures in the coal were as follows:

|              | Couple No. 1,<br>Degrees C. | Couple No. 2,<br>Degrees C. |             | Couple No. 1,<br>Degrees C. | Couple No. 2,<br>Degrees C. |
|--------------|-----------------------------|-----------------------------|-------------|-----------------------------|-----------------------------|
| Cigar I..... |                             | 658                         | Cigar L.... | 670                         | 657                         |
| Cigar J..... | 717                         | 668                         | Cigar M.... | 803                         | 708                         |
| Cigar K..... | 584                         | 629                         |             |                             |                             |

4. The temperature gradient becomes very steep as the coal approaches the junction, that is, the temperature a few millimeters ahead of the coal is comparatively low.

5. The data obtained indicate that such factors as moisture content, chemical composition, and compactness of the cigar affect the maximum temperature attained during the combustion.

Acknowledgments are due to the Department of Physics of the Pennsylvania State College for the use of its laboratories and apparatus in this work.

### DISCUSSION

W. P. WHITE,\* Washington, D. C. (written discussion †).—The authors seem to have proved that for a phenomenon as irregular as the one they were investigating there was no perceptible conduction effect in the platinum wire. It should be mentioned, however, that the conduction of heat to and from small wires is not proportional to their surface and might give unexpected values, varying largely with the medium in which the wire was situated. Attempts to eliminate a conduction effect in the wire by extrapolating the curve obtained by using different sizes have in some cases given incorrect results, so that the authors' result should be applied with great care as a guide in other cases. The difference in size of wire employed by them is really rather small. If the desire had been to find out how great the effect was instead of merely to demonstrate its absence, a greater difference of diameter would, of course, have been selected.

\* Physicist, Geophysical Laboratory.

† Received Sept. 25, 1919.

The sharp gradient immediately in front of the burning portion of the cigar is quite surprising at first sight. The weight of air coming from a flame is considerably greater than the weight of material burned, and it would be thought that this stream of heated air would heat very considerably the material not yet reached by the zone of combustion. Possibly the heat is exhausted in evaporating moisture from the material. In that case the cigar is really a sort of regenerative furnace, except that it is not air but the material which is preheated, and the preheating produces dryness rather than increase of temperature. Whether or not this is the case would be shown by finding how hot a thoroughly dry cigar would get.

T. S. SLIGH (author's reply to discussion\*).—The authors attempted only to obtain some measurements of temperature attained in cigars selected at random and since these individual temperatures would necessarily vary considerably among themselves the method was not subjected to a rigid examination as to the attainable accuracy.

The authors were aware that attempts to determine flame temperature by extrapolation of the readings of couples of varying diameters had led to inconsistent results. It should be noted, however, that in the present work the couple is in contact with a considerable mass of burning material for about 50 to 70 diameters of the wire on each side of the junction, thus supplying the larger part of the heat conducted away by the leads from a portion of the coal more or less remote from the junction; the section of the couple in the cigar is swept by a stream of hot gases and the junction is completely shielded from radiation losses. We may calculate, using experimentally determined emission constants, that the heat loss from the leads is about 0.01 cal. per sec. and 0.03 cal. per sec. from the smaller and larger couple, respectively. We have no data on the degree of thermal contact secured between the couples and the burning cigar, but if we assume the same degree of contact for each couple, in view of the fact that heat transfer between small wires and a gas is practically independent of the diameters of the wires, we find that the lowering of the temperature of the larger couple should be approximately three times that of the smaller couple. If, on the other hand, we assume solid contact between the couple and the coal, the heat transfer would be proportional to the surface areas of the wires and we find that the lowering of temperature of the larger couple is twice that of the smaller couple. If this lowering of temperature were appreciable one would expect to note its effects on the temperatures indicated by the two sizes of couples employed.

The authors agree with Doctor White in his explanation of the cause of the sharp gradient ahead of the coal. An examination of a section of a partly burned cigar shows that the tobacco is dried out for only a short distance ahead of the coal.

---

\* Received Jan. 20, 1920.

## Application of Pyrometry to the Manufacture of Gas-mask Carbon

BY KIRTLAND MARSH,\* B. S., NEW KENSINGTON, PA.

(Chicago Meeting, September, 1919)

THE manufacture of gas masks by the Chemical Warfare Service, U. S. A., required preparation of the carbon used in the canisters. The largest plant for the production of this carbon was situated at the works of the Astoria Light, Heat and Power Co., at Astoria, N. Y.; this paper will deal<sup>1</sup> with the pyrometry equipment at that plant.

Commercial charcoal was found unsuitable for use in gas masks because of its low power of absorption and its poor resistance to abrasion. The best raw material for the production of carbon was found to be coconut shells, but any kind of nut shells or fruit pits were used when sufficient quantities of coconut shells could not be obtained. The shells were first carbonized in retorts, the carbon was then crushed and screened between 8 and 16 mesh, and finally submitted to a special heat-treatment in air; steam treatment was later substituted for treatment in air. The production of gas-mask carbon on a commercial scale was begun at Astoria about Aug. 1, 1917.

Temperature control was essential during the initial carbonization of the shells, as well as during the air or steam treatment, and pyrometers were installed for this purpose. The installation and maintenance of all pyrometry equipment was done by the pyrometry department, consisting of an officer in charge, an assistant, and two men. A special pyrometry laboratory was maintained in which all repairs were made.

### TEMPERATURE CONTROL IN THE RETORTS

The initial carbonization of the raw material was accomplished in horizontal retorts, formerly used for the production of coal gas. These retorts, of semi-elliptical cross-section, were 20 ft. (6 m.) long, 2 ft. (60 cm.) wide and 18 in. (46 cm.) high; they were arranged in banks of two rows of four retorts each, one above the other; four banks constituted a bench. Every retort had a door at each end, opening to the full size of the cross-section of the retort, which was clamped shut except during

---

\* Pyrometric Engineer, Aluminum Co. of America; formerly officer in charge, Pyrometry Department, Astoria Detachment, Chemical Warfare Service, U. S. A.

<sup>1</sup>For further details as to the manufacturing process, see Contributions from the Chemical Warfare Service. *Ind. and Eng. Chem.*, 1919.

charging, drawing, or raking the charge. The retorts were heated to about  $900^{\circ}\text{C}$ . by hot gases coming from coke fires at each end of the bank and passing through flues around the retorts. The retort was charged by buckets about 10 ft. (3 m.) long on the traveling boom of a charging machine, one at each end of the retorts. The charge was pushed out by a semi-elliptical plate, a little smaller than the cross-section of the retort, on the end of the traveling boom of a drawing machine which traveled on tracks at one end of the retorts. The plate was pushed through the retort from end to end, forcing the carbon out into a chute leading to small hopper cars (Fig. 1).

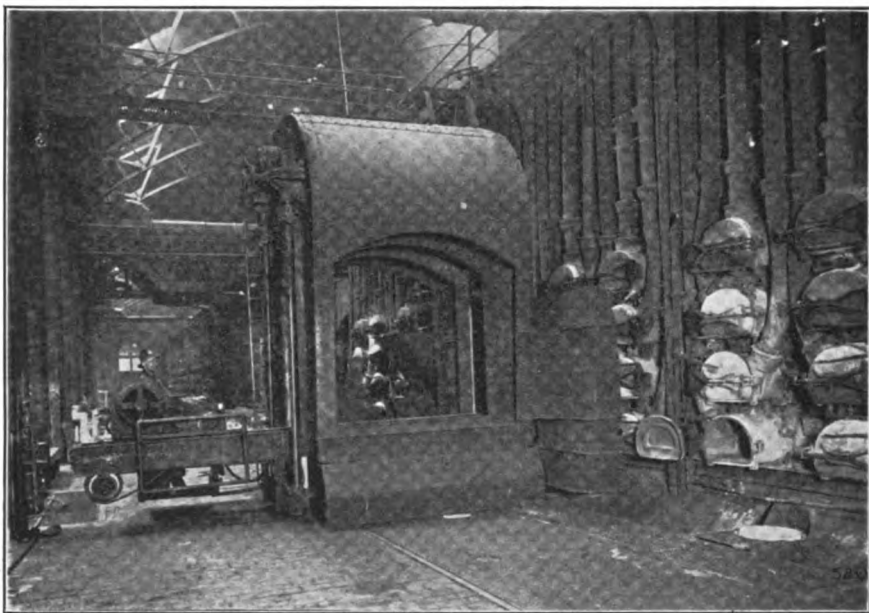

FIG. 1.—RETORTS, SHOWING A RETORT BEING DRAWN BY THE DISCHARGING MACHINE.

This method of charging and drawing obviously prohibited the installation of any permanent thermocouple in the retorts. Thermocouples which could be removed during the charging and drawing might have been used, but the life of a base-metal couple, even in a protecting sheath, would have been short, and a couple long enough to reach to the middle of the retort would have been awkward to handle; the expense, also, of maintaining a thermocouple for each retort would have been excessive. Furthermore, it was necessary to measure the temperature in the flues, and for that purpose a base-metal couple could not have been used, the temperature being about  $1200^{\circ}\text{C}$ . The choice thus lay between optical or radiation pyrometers; a Leeds & Northrup optical pyrometer was tested and found to give very satisfactory results.



Readings of the temperatures in the retorts and flues were taken every two hours. More frequent readings were unnecessary because closer temperature control was not needed, in fact was almost impossible, because of the slow change in retort temperature after manipulation of the fires.

#### TEMPERATURE CONTROL IN THE AIR-TREATERS

The air-treater consisted of a set of five iron tubes, set one above the other, at a slope of about  $3^\circ$ , in a combustion chamber; each tube was 12 ft. (3.6 m.) long and 12 in. (30 cm.) inside diameter. A 10-in. (25-cm.) screw conveyor running the entire length of the tube, tangent to the bottom, conveyed the carbon through the tube. The carbon was fed into the back end of the upper tube, traveled through it and dropped into the next tube, and so on until it was discharged into drums at the end of the fifth tube. The discharge end of the air-treaters is shown in Fig. 2. Each combustion chamber contained two sets of tubes, heated by a gas burner at the bottom of the chamber, to a temperature of about  $400^\circ\text{C}$ .

The level of the material in the tube was about 4 in. (10 cm.) from the bottom, while the free space at the top of the tube was 2 in. In the center of this free space was placed a  $\frac{1}{2}$ -in. (12.7-mm.) wrought-iron pipe 12 ft. long, anchored at each end in the head of the tube; this pipe constituted the pyrometer tube.

When these air-treaters were first built there was only a single combustion chamber with two sets of tubes. The temperatures were measured by inserting a Price, sheathed-wire, iron-constantan thermocouple in the pyrometer tube and allowing it to remain until temperature equilibrium was established; the temperature was then read from a Price indicating pyrometer and the couple moved to the next tube.

Later, stationary thermocouples, 6 ft. (1.8 m.) long, made of No. 16 iron and constantan wires, insulated with porcelain beads, were inserted in each pyrometer tube. Similar couples in similar pyrometer tubes were placed in the combustion chambers, between the two sets of reaction tubes, at four levels. The iron and the constantan lead wires from the thermocouples were run in a conduit to a common junction box, where they were soldered to the copper leads connected to Wilson-Maeulen, two-pole, rotary selector switches mounted on the box. Fig. 2 shows the ends of the pyrometer tubes projecting from the heads of the reaction tubes, and the conduit running to the common junction box. In Fig. 3 can be seen the lead wires, the common junction box, and the selector switches. These switches were all connected to a Leeds & Northrup indicating potentiometer set in the top of the junction box.

As the lead wires were of iron and constantan, the cold junctions of the thermocouples were actually at the end of the lead wires in

the common junction box. The first potentiometer used was equipped with a hand-operated, cold-junction compensator, making it necessary to determine the temperature in the common cold-junction box with a thermometer and make the necessary adjustment on the potentiometer, but as the temperature in the junction box changed very little from hour to hour, the adjustment was relatively simple. Later a Leeds & Northrup potentiometer was used which was equipped with an automatic cold-junction compensating coil, which was placed with the cold junctions in the junction box.

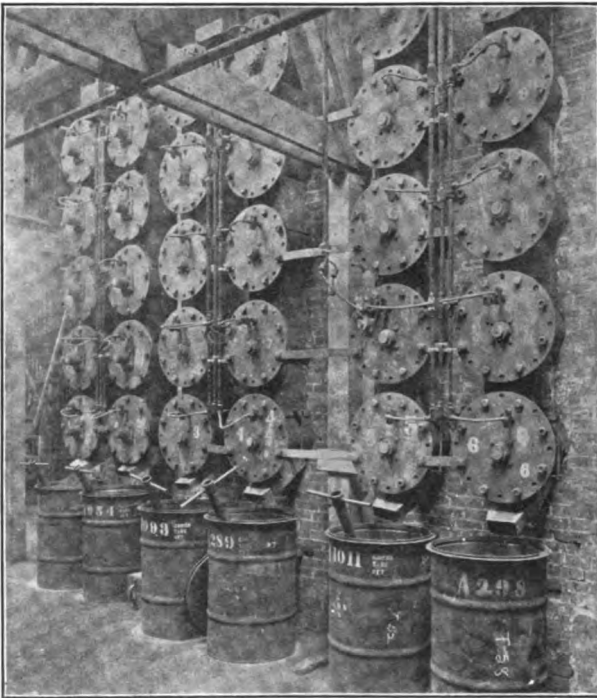

FIG. 2.—DISCHARGE END OF AIR-TREATERS, SHOWING ENDS OF PYROMETER TUBES AND CONDUIT FOR THE LEAD WIRES.

At first, readings were taken on all the couples in the tubes and combustion chambers every half hour, but it was soon found that the quality of the material bore a close relation to the temperature in the fourth tube, which was the hottest, and as there was no means for regulating the temperature of each tube individually it became a matter of regulating the burners to give the proper temperature in the fourth tube. As there was a fairly constant relation between the temperature of the fourth tube and the other tubes in the same set, it was necessary to take readings only on the fourth or control tube. Similarly, the reading of tem-

peratures in the combustion chambers was reduced to one couple in each chamber; occasionally readings on all the couples would be made to see that the relation had not changed. The temperature in the control tube was maintained at about 400° C.

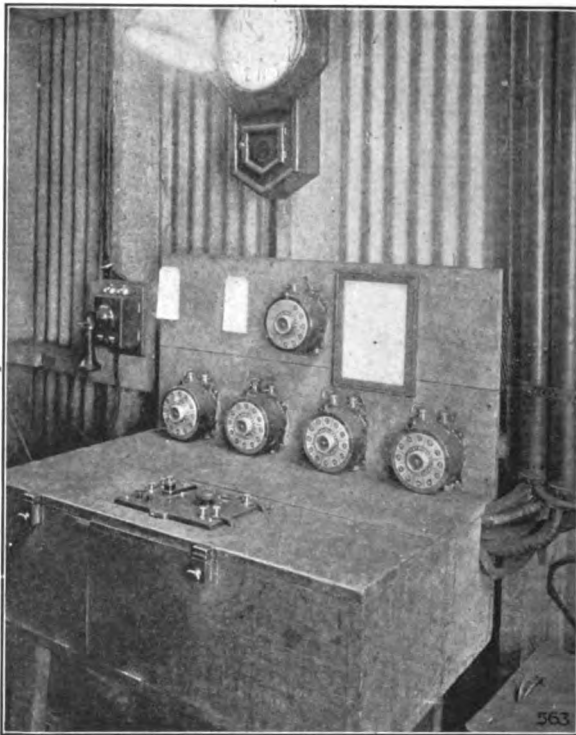

FIG. 3.—PYROMETER FOR AIR-TREATERS, SHOWING COMMON COLD-JUNCTION BOX, WILSON-MAEULEN SWITCHES, AND LEEDS & NORTHRUP POTENTIOMETER.

#### TEMPERATURE CONTROL IN THE STEAM-TREATERS

Research developed a method of treating the carbon from the retorts with steam, which produced a material of much better quality than was obtained from the air-treaters. Furnaces for treating carbon with steam were designed, and the first battery of 10 furnaces was put into operation at Astoria early in March, 1918.

The furnace consisted of a vertical, gas-fired combustion chamber, 7 ft. (2.1 m.) high and 27 in. (68 cm.) inside diameter, surrounding a nichrome reaction tube having  $\frac{3}{4}$ -in. (19-mm.) walls and an inside diameter of 7 in. (17.8 cm.). Coal gas mixed with air in Premix burners was used as fuel. Inside the nichrome reaction tube was a 2-in. (5-cm.) nichrome pipe extending the entire height of the furnace, and per-

forated all around for 8 in. (20 cm.), at about the level of the center of the combustion chamber, with  $\frac{1}{4}$ -in. (6-mm.) holes. This nichrome pipe was essentially a steam jet; at first, steam was admitted at the top, but later at the bottom.

A charging valve at the top of the furnace admitted the carbon between the reaction tube and the steam jet, which space was kept filled, and a similar valve at the bottom served to discharge the carbon. Between the bottom of the reaction tube and the discharge valve a rotating spider valve maintained the flow of carbon through the tube at a constant rate.

Research had shown that the best quality of carbon was produced when it was treated with steam at a temperature of 950° C. To obtain this temperature in the mass of charcoal at the level of the steam orifice, and at a point midway between the steam pipe and the wall of the reaction tube, it was necessary to maintain a temperature of about 1150° C. in the combustion chamber at a level about 27 in. (68 cm.) above the gas burner.

At Nela Park, Cleveland, Ohio, where the original designing and testing of these steam-treaters was done, the temperature of the material was measured by a Price sheathed-wire, iron-constantan thermocouple, connected to a Price indicator. The thermocouple was introduced into the material through a horizontal open-end, nichrome pyrometer tube screwed into the wall of the reaction tube. The pyrometer tube had about 1 in. (25 mm.) inside diameter and was surrounded by an open-end iron tube, of 3-in. diameter, which extended from the reaction tube to the outside of the furnace; this provided an air space around the pyrometer tube where it passed through the combustion chamber and kept it cooler, thereby adding to the life of the thermocouple. As the pyrometer tube was open at the inner end, a packing gland was required around the thermocouple, where it protruded from the outer end of the pyrometer tube, to prevent the pressure within the reaction tube from blowing the carbon out through the pyrometer tube. The hot junction of the thermocouple was in direct contact with the carbon and the steam which, at this temperature, would be decomposed into oxygen and hydrogen. Under these conditions, the life of a thermocouple was about four days. To replace a thermocouple it was necessary to shut off the steam to prevent the carbon from blowing out through the pyrometer tube when the old thermocouple was removed; even with the steam shut down, some carbon followed the thermocouple into the pyrometer tube and rendered the insertion of another thermocouple very difficult.

When a production unit of ten of these furnaces, to be erected at Astoria, was being designed, it was decided that a pyrometer tube closed at its inner end would be best. The danger of burning out the reaction tube, if the flow of steam was interrupted for any length of time, often made

it necessary to shut off the gas when a base-metal couple in an open-end pyrometer tube was being changed. The short life of a base-metal couple at the temperature encountered in the combustion chamber through which it passed promised to be a source of great expense. A base-metal couple of other materials than iron and constantan, such as nickel and nichrome, would probably have given good service even at these temperatures if used intermittently, but for continuous use even such couples would undoubtedly require frequent changing. For these reasons it was decided to use a thermocouple of platinum and platinum plus 10

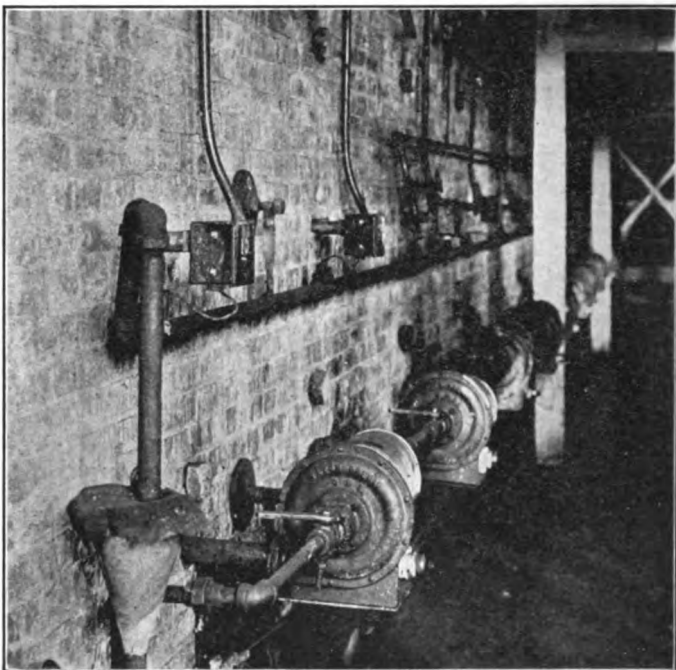

FIG. 4.—STEAM-TREATERS, SHOWING PREMIX BURNERS, PYROMETER TUBES, CONNECTION BOXES, COMPENSATING COUPLES, AND COLD-JUNCTION WELLS. TYPICAL OF FIRST FORTY STEAM-TREATERS ERECTED.

per cent. rhodium, protected by a glazed, ceramic, pyrometer tube inside of a closed-end nichrome tube screwed into the wall of the reaction chamber. The nichrome pyrometer tube was turned down to a wall thickness of about  $\frac{1}{8}$ -in. (3 mm.) and was so placed in the furnace that the hot junction of the platinum thermocouple would be midway between the steam jet and the reaction tube.

On the outer end of the pyrometer tube was attached a stamped-steel zone box, 4 by 4 by 3 in. (10 by 10 by 7.6 cm.) provided with a hinged cover and a lock. On the inside of the zone box was a small asbestos block on which were mounted three binding posts. The cold ends

of the thermocouple, the ends of an auxiliary couple, and the lead wires to the measuring instrument were connected to these three binding posts in such a way that the platinum thermocouple, the auxiliary couple, and the lead wires were in series. The auxiliary couple was made of Wilson-Maeulen compensating wire, which, within the limits of temperature encountered at the cold junction of a thermocouple, has the same thermo-electric characteristics as the platinum thermocouple. By using this auxiliary couple, the cold junction of the platinum thermocouple was removed from a position of varying temperature, at the end of the pyrometer tube, to one of constant temperature in a well in a pipe through which tap water was circulating, the soldered ends of the auxiliary couple being buried in this well. The general arrangement of Pre-

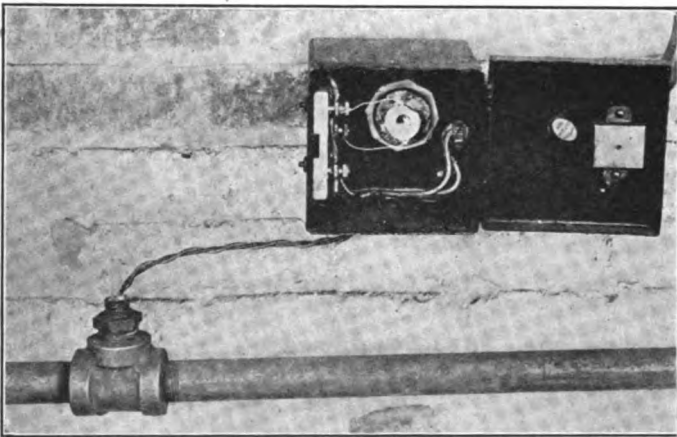

FIG. 5.—THERMOCOUPLE CONNECTION BOX ON STEAM-TREATERS, SHOWING DETAILS OF CONNECTION BOX, NICHROME PYROMETER TUBE, IMPERVITE PYROMETER TUBE, PLATINUM THERMOCOUPLE, BINDING POSTS, COMPENSATING COUPLE, AND COLD-JUNCTION WELL.

mix burners, zone box, and cold-junction wells can be seen in Fig. 4, and the details of the zone box, auxiliary couple, and cold-junction well in Fig. 5. In each cold-junction well, with the junction of the auxiliary couple, was placed a small glass tube into which a thermometer could be put; this tube and the auxiliary couple were sealed in the well with paraffin. It was found that with a moderate flow of water through the wells, the cold-junction temperature varied only  $1^{\circ}$  or  $2^{\circ}$  F. from day to day.

The lead wires from the zone box to the instrument were of copper and were run in conduit to a switch box located in front of the measuring instrument which, in this case, was a Leeds & Northrup recording potentiometer. In the switch box was a push-button switch for each thermocouple, so arranged that the thermocouple was normally connected to the recorder, but upon the depression of the button the thermocouple would

be disconnected from the recorder and connected to an indicator. This was to permit checking of the recorder against an indicator or reading of the furnace temperature at any time the recorder was not in operation.

The recorder was placed in the furnace room so that the operators could follow the temperature record and adjust the burners accordingly. It rested on a stand attached to a turntable made of two 4-in. pipe flanges connected by a 6-in. nipple, the bottom flange being bolted down to a solid brick pier. The recorders were enclosed in a wooden cabinet supported independently of the recorders and their supports. The outside of this case was flush with the wall of the furnace room and was provided with a window, while the side within the office had a door through which the

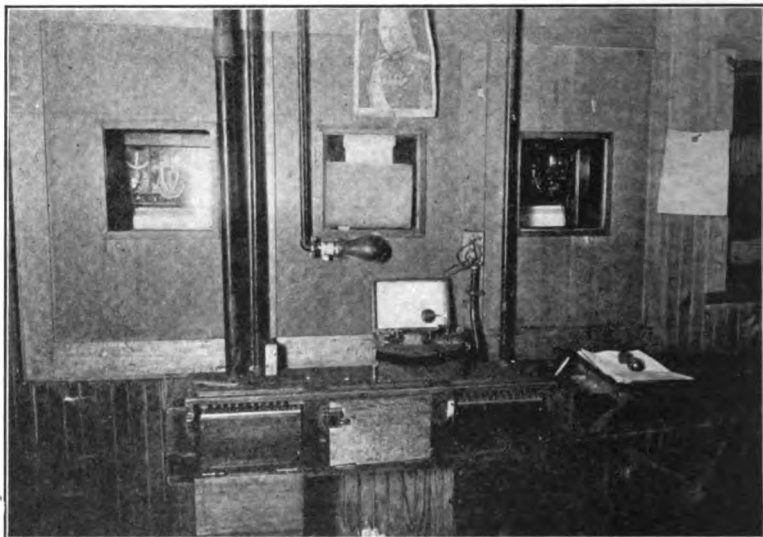

FIG. 6.—RECORDING PYROMETER AS SEEN FROM FURNACE ROOM, SHOWING LEEDS & NORTHRUP RECORDING POTENTIOMETER IN THE CASE, AND PUSH-BUTTON SWITCHES AND INDICATING POTENTIOMETER BELOW.

recorder could be cleaned; thus the instrument was protected from the carbon-laden atmosphere of the furnace room while it was being cleaned or adjusted. The exterior of the case, the push-button switches, and the indicating potentiometer for checking the recorder are shown in Fig. 6. There was one recorder for each battery of 10 furnaces and the temperature of each furnace was recorded every 10 minutes.

In two furnaces, Price sheathed-wire thermocouples were placed diagonally opposite the platinum couple, and at the same level, to compare the indications by the two systems. At times the two couples agreed fairly well, but at other times wide variations were observed. Wide and sudden fluctuations of temperature were occasionally indicated by both thermocouples; at one time the temperature, which had been steady

for some time, was observed suddenly to rise  $100^{\circ}$  C., and even more suddenly drop  $200^{\circ}$ , after which it slowly rose to normal. This was caused by the formation of a gas pocket around the pyrometer tube, followed by an increase of temperature within the pocket, due to the absence of carbon to absorb the heat. When the pocket broke, a mass of cooler carbon filled the space, and slowly assumed the normal temperature at that level. It was thus seen that accurate temperature control, which was necessary because the nichrome tube was being used at a temperature very near its softening point, could not be maintained.

A test to determine the horizontal temperature gradient between the wall of the reaction tube and the steam jet, at the level of the pyrometer tube, showed a difference in temperature varying from  $150^{\circ}$  to  $200^{\circ}$  C., the distance between these two points being about  $2\frac{1}{8}$  in. (54 mm.). This showed why the platinum and the base-metal couples in the same furnace had not agreed more closely; under the conditions noted above, the possible error in measuring temperatures could not safely be estimated at less than plus or minus  $50^{\circ}$  C.

After the above tests had been made, the idea of measuring temperature within the reaction tube was abandoned. The thermocouples were removed from the reaction tube and placed in closed-end nichrome pyrometer tubes in the combustion chamber, at the same level as before; the end of the tube was  $\frac{3}{4}$  in. (19 mm.) from the reaction tube, which point was found to be the hottest at that level. To determine whether the pyrometers were at the best level in the combustion chamber, similar thermocouples in protection tubes were placed at two levels above and at one level below the regular thermocouple. These three extra couples were connected to the recorder for about 12 hr. Examination of the records showed that the nearer the couple was to the burner, the wider were the temperature fluctuations. The records showed little difference in sensitivity to temperature changes, *i.e.*, a change indicated by the couple lowest in the furnace would be indicated at the same time by the couple at the highest level. The selection of the best level thus became a compromise, for the lower the couple was placed the higher was the temperature to which the nichrome pyrometer tube was subjected, and the higher the couple the less marked were the changes in temperature. It was decided that the level at which the couples were already installed was as satisfactory as any.

This method of temperature control, *i.e.*, a platinum thermocouple in the combustion chamber, was adopted for four batteries of 10 furnaces. Sixty more of these furnaces were built in batteries of 10 furnaces each, but as Leeds & Northrup recording potentiometers could not be delivered until long after the furnaces were scheduled to be put in operation, another system, known as central-station temperature and signal control, was installed.



The thermocouples, protection tubes, zone boxes, and cold-junction compensating couples were installed as on the original 40 furnaces. The leads from the 10 thermocouples in each battery were connected to a cable through copper strips mounted in a terminal box on the end of the battery, the cable connecting with a central switchboard in the administration office. The switchboard, with a capacity for 24 thermocouples, consisted of a horizontal and a vertical section. The cables connected to the thermocouples on two batteries were fanned out to double-pole switches mounted on the horizontal section of the switchboard; these switches were connected to a Leeds & Northrup indicating potentiometer, equipped with a hand-operated cold-junction compensator. On the vertical section

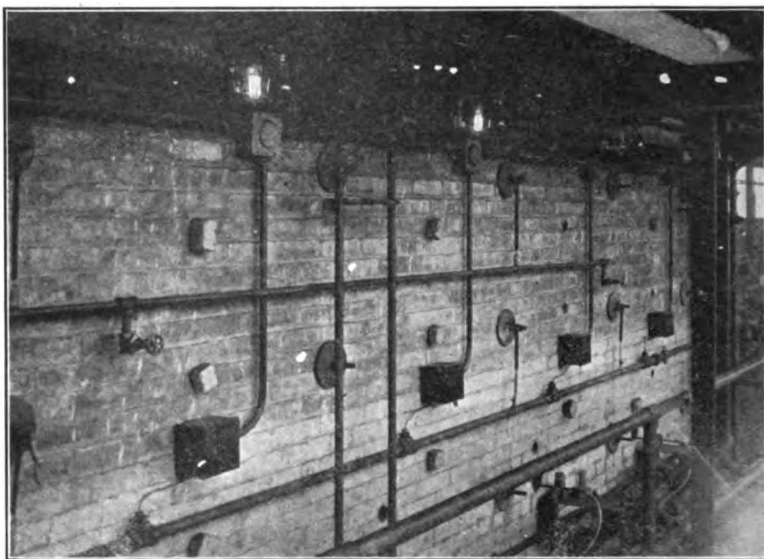

FIG. 7.—STEAM-TREATERS, SHOWING THERMOCOUPLE CONNECTION BOXES, COLD-JUNCTION WELLS, AND SIGNAL LIGHTS. ARRANGED FOR CENTRAL-STATION CONTROL. TYPICAL OF LAST SIXTY STEAM-TREATERS ERECTED.

of the switchboard were 24 sets of three signal-lamp switches, each having a small telephone pilot lamp over it. The signal-lamp switches and pilot lamps of each set were in series with three signal lamps mounted over the burner of each furnace. A cable connected the signal switches and pilot lamps on the switchboard to a terminal box on the end of each battery, from which circuits were run to the three signal lamps on each furnace, seen at the top of Fig. 7. The signal lamps on the furnace were red, white, and green, respectively, and the switchboard pilot lamp in series with each of them was the same color.

The temperature of each of the 20 furnaces connected to one switch-

board was read every 10 min. and recorded every 20 min. by an operator, who set the colored signals according to the following schedule:

|                      |                      |
|----------------------|----------------------|
| 1183° or higher..... | white, red and green |
| 1166° to 1183°.....  | red                  |
| 1158° to 1166°.....  | red and white        |
| 1142° to 1158°.....  | white                |
| 1134° to 1142°.....  | white and green      |
| Below 1134°.....     | green                |

By watching the colored signals over each furnace, the operator could adjust his burners; the officer in charge also could tell at a glance the temperature of each furnace. As the pilot lamps on the switchboard were in series with the signal lamps on the furnaces, neither lamp could burn out without being observed at once. Beside each switchboard was a telautograph instrument through which information or instructions could be transmitted in writing from the switchboard operator to the burner operator, or vice versa. In case of damage to the switchboard, it was possible to read the temperature of the furnaces by connecting a potentiometer to the leads from each thermocouple at the terminal box on the end of the battery. The success of this installation was never demonstrated because the furnaces were operated for only a short time after the signing of the armistice.

#### TEMPERATURE CONTROL IN TECHNICAL DEVELOPMENT LABORATORY

In the technical development laboratory were full-size steam-treaters for experimental purposes, small electric-furnace steam-treaters, several sizes of experimental retorts, and other miscellaneous furnaces for research work. In most of these furnaces, control was maintained by measurements of temperature in the combustion chamber, by platinum couples connected to a Leeds & Northrup indicating potentiometer through selector switches.

For measuring temperature in the mass of material in a steam-treater, retort, or other furnace, Wilson-Maeulen sheathed-wire iron-constantan thermocouples (known by the trade name "Pyod") were used, in connection with a Wilson-Maeulen or a Price indicating pyrometer (millivoltmeter), or a Leeds & Northrup potentiometer. In the case of permanent installations, iron and constantan lead wires transferred the cold junction of the thermocouple to a water-cooled well similar to those used for the platinum couples. For temporary installations, as in short tests of temperature gradient, the compensating lead wires were connected directly to the binding posts of the instrument, at which point the cold-junction temperature was read with a mercury thermometer.

These pyrods were used in direct contact with carbon at temperatures as high as 950° C., and although the life of the couples was short, they gave very satisfactory results and maintained their calibration closely until burned out; this fact was established by repeated recalibration. On several occasions these couples satisfactorily measured the temperature of a mass of carbon as high as 1200° C.

#### TYPES OF PYROMETER TUBES EMPLOYED

For the primary protection tubes of platinum thermocouples, alundum, impervite, and usalite were all used; the choice depended principally on the deliveries that could be obtained and on the dimensions of the available tubes, for all three materials gave good service. For the secondary protection tubes, nichrome was most frequently used, but some alundum and some impervite tubes were employed. In the first steam-treater installation, in which the secondary protection tube was screwed into the reaction tube, nichrome was used from necessity. After measurements of combustion-chamber temperature were adopted for control, nichrome protection tubes were still employed because they were not fragile, but some alundum and some impervite tubes were tested and were found to protect the primary protection tube and the platinum thermocouple better than the nichrome tube. A primary tube protected by an alundum or impervite secondary tube, in use for two months, remained in better condition than one protected by a nichrome tube, used for the same length of time. It is probable that when it became necessary to replace the nichrome protection tubes, alundum or impervite would have been selected. Tubes of these materials were never known to soften at the temperatures encountered in the furnaces, as the nichrome tubes sometimes did.

#### CHECKING, CALIBRATION, AND MAINTENANCE OF PYROMETERS

##### *Thermoelectric Pyrometers*

Recording pyrometers were inspected and checked against an indicating potentiometer once or twice a day. All platinum thermocouples, ceramic protection tubes, and pyrometer connections were inspected daily. All base-metal couples, their connections, and the indicators and switches in circuit with them, were inspected daily. Optical pyrometers were inspected two or three times a week; more frequent inspection was unnecessary because when anything was out of order in these instruments, it was immediately apparent.

The iron-constantan thermocouples in the air-treaters were checked by recalibration in an electric furnace in the laboratory or, in place, by

a standard base-metal thermocouple inserted in the same furnace tube and to the same depth as the couple to be calibrated. Readings of the temperature indicated by the standard couple on a laboratory potentiometer were compared with the readings on the plant instrument of the temperature indicated by the couple being checked.

The platinum thermocouples used in the steam-treaters were removed from the furnaces periodically and taken to the laboratory for checking. The thermocouple, stripped of its porcelain two-bore insulation, was first annealed at a temperature of about 1400° C. for 10 min. by passing electric current through it. The couple was then tested for homogeneity by exploring the platinum and the platinum-rhodium elements with uncontaminated wires of the same materials. In this operation one element of the thermocouple and a pure wire of the same material were connected to a galvanometer, and the two wires were brought into contact in the oxidizing flame of a Bunsen burner; any inhomogeneity was indicated by a deflection of the galvanometer. After the entire length of one element of the couple had been tested in this manner the other element was tested in the same way. Any inhomogeneous spots in the thermocouple, located by this test for homogeneity, were removed by further annealing; or if, after reannealing for 30 to 40 min., the spots were not rendered homogeneous the affected section of the couple was cut out and the two ends welded together in an oxy-gas flame. In only a very few cases was it necessary to cut out any part of the couples. When it was ascertained that the elements of the couple were in good condition, it was threaded in four-bore insulation, together with a standard platinum couple, and placed in a pyrometer tube suspended in a vertical, electric, checking furnace. The cold ends of both couples were immersed in mercury wells in a cold-junction box, with a thermometer. Copper leads connected the mercury wells with a Leeds & Northrup indicating potentiometer, through a Wilson-Maeulen selector switch. Readings at equal intervals of time, generally every 30 sec., were taken alternately on the standard couple and on the couple being checked until a constant difference between the readings of the two couples was obtained. From the time-temperature curves plotted from these readings the actual difference in the indications of the two couples could be determined. This method of taking readings at equal intervals of time eliminated the necessity of waiting for an absolutely constant temperature in the furnace, although the more nearly constant the temperature the better the results. A steady rising or falling temperature is more satisfactory than a fluctuating temperature.

So long as the couples remained in good condition and showed no indications of inhomogeneity, the above method of calibration was satisfactory, but as the couples deteriorated and the calibration changed it was planned to calibrate them under working conditions. For this pur-

pose, alundum secondary and primary protection tubes were mounted in one of the steam-treaters, at the same level and inserted to the same depth as the regular control couple. The standard couple and the couple to be calibrated would then be inserted in the tube, and readings would be taken as just described. In this method of calibration, the effects of any deterioration in the couple would be the same as when the couple was in use, because the temperature gradient along the calibrating tube was the same. The need of such a method of calibration had not been felt up to the time that the furnaces were shut down on Dec. 31, 1918.

Of 98 platinum thermocouples installed, only three were destroyed in use. The readings from these three couples indicated that something was wrong, and upon investigation it was found that for a distance of 10 in. (25 cm.) from the hot end both elements of the couple were crystallized to such an extent that they crumbled when handled. A superficial examination of the alundum protection tube disclosed nothing unusual, and the cause of crystallization was never ascertained. This occurred about three weeks after they were put in service.

A complete record of each platinum thermocouple was kept on a card showing the date of purchase, order number, from whom purchased, original weight and length of each element, original weight of the couple, and the original calibration readings. Every time its couple was calibrated, a record was made of the date, weight of the couple, length of the elements, condition when removed, calibration data, and notes on any alterations. The following data are quoted from a report submitted by P. H. Walker, assistant to the officer in charge of the pyrometry department, after all the furnaces were shut down and the couples assembled in the laboratory.

|  | GRAMS    |
|--|----------|
| Total stock received.....                  | 830.1134 |
| Platinum and platinum-rhodium inventoried: |          |
| Thermocouples.....                         | 806.6714 |
| Scraps.....                                | 11.7981  |
| Unused platinum wire.....                  | 3.1080   |
| Unused platinum-rhodium wire.....          | 5.1400   |
| Total accounted for.....                   | 826.7175 |
| Loss in use.....                           | 3.3959   |

The average length of time that these couples were in use was probably about six months, which places the platinum loss at about 0.82 per cent. per year.

### *Optical Pyrometers*

Optical pyrometers were checked in the laboratory, sometimes by comparison with one another, but generally by observations on a heated

body, in an electric furnace, the temperature of which was measured by means of a platinum thermocouple.

When comparing one optical pyrometer with another, the milliammeters were first tested by connecting them in series and observing whether both indicated the same current; it was found that these instruments retained their calibration very well. The two telescopes were then mounted horizontally on a rack so arranged that after one telescope had been sighted on the object the second telescope could be sighted on the same object by moving the rack through a small horizontal angle. By making observations with alternate instruments at equal intervals of time, readings could be obtained for time-temperature curves, from which the relation of the two instruments could be determined.

A precise calibration could be made by measuring the temperature of the object sighted upon, with a platinum thermocouple connected to a potentiometer. In this operation, care should be taken to secure as nearly black-body conditions as possible or conditions similar to those under which the instrument is regularly employed.

#### DISCUSSION

R. W. NEWCOMB, New York, N. Y. (written discussion\*).—This paper is particularly interesting to me, because it gives data on a much mooted question, viz., the serviceability of Le Chatelier (platinum-platinum-rhodium) thermocouples under severe industrial conditions. It has always been supposed that platinum-platinum-rhodium thermocouples, used at high temperatures under strong reducing conditions, would not give long service and were subject to rapid volatilization. The fact, however, that the carefully kept records indicate that a little more than 3 gm. out of more than 830 gm. was lost over this considerable period, shows what kind of service can be obtained from platinum-platinum-rhodium thermocouples, when properly installed, and well cared for.

While the writer has no actual figures on the loss of weight, etc. of platinum-platinum-rhodium thermocouples under service, he was told, by the man in charge of pyrometers at a large industrial plant in which over 400 platinum-platinum-rhodium thermocouples were installed in furnaces doing various kinds of heat-treating work, that the average maintenance cost, for materials alone, including platinum-platinum-rhodium wires and protecting tubes, was 27 c. per furnace, per month.

CARLETON W. HUBBARD, Greenwich, Conn. (written discussion)†.—It has been my experience that there is a considerable difference in the serviceability and accuracy of platinum thermocouples. I believe it is

\* Received Oct. 15, 1919.

† Received Oct. 21, 1919.

said that this serviceability depends on several factors aside from the matter of the protection of the thermoelement wires. In view of the unusually good results described in the paper, from the use of thermocouples under conditions that can be considered as severe, it would be of value if the author could identify the manufacturer supplying the thermocouples he used while collecting his data.

KIRTLAND MARSH (author's reply to discussion\*).—All the platinum-platinum plus 10 per cent. rhodium thermocouples used at the Astoria Detachment C. W. S., U. S. A., were purchased from Charles Engelhard in the form of wire 0.5 mm. in diameter, at different times from Nov 5, 1917, to Aug. 13, 1918. After the wire was received at the laboratory, it was cut into the required lengths and the different elements were welded in an oxy-gas flame. After the thermocouples were made up, they were annealed and calibrated by comparison with a standard to see that they agreed with the standard. All the platinum-rhodium thermocouples made up at this laboratory from the Engelhard wire agreed with the standard within plus or minus 3° C. at 1000° C.

---

\* Received Dec. 26, 1919.

## Teaching Pyrometry in Our Technical Schools

BY GEORGE V. WENDELL,\* PH. D., NEW YORK, N. Y.

(Chicago Meeting, September, 1919)

THE fact that a symposium on pyrometry is being held under the auspices of the American Institute of Mining and Metallurgical Engineers may very properly be taken as a recognition of the importance of temperature measurements and control in production and in the industries, and of the need for instruction in pyrometry in our schools of engineering. Though there may be general agreement as to the need of some instruction along this line, there will undoubtedly be divergence of opinion as to the amount of time that can be allowed to such instruction, as well as to its character. Those who have given little attention to the complexity of high-temperature measurements will be apt to think that a few simple experiments are all that is required. They fail to distinguish between the artisan, who merely has to learn how to use any piece of apparatus that is installed, and the technically trained man, who must be prepared to assume the responsibility for the supervision and maintenance of the pyrometric equipment, for the calibration of the instruments, and for the solution of any temperature problems that arise.

In approaching this subject two questions present themselves: What should be the character of the instruction in pyrometry in an engineering school, and what can be expected of the students who have had this instruction? In brief, it may be said that the aims of a course in pyrometry should be to give: (1) A thorough grounding in the fundamental principles of thermoelectric, resistance, radiation, and optical pyrometry, and of liquid and gas thermometry; (2) practical instruction in the calibration of pyrometers; (3) acquaintance with the errors that are likely to arise and the precautions that must be observed in practice; (4) information regarding the limitations of the various classes of instruments, their relative reliability, and the accuracy attainable with them at different temperatures; (5) acquaintance with the commercial instruments on the market, their construction and relative merits; (6) a knowledge of the chief sources of information relating to the measurement of high and low temperatures. To sum up, the aim should be to turn out resourceful young men familiar with the leading instruments on the market, capable of handling them with skill and qualified to meet, with intelligence and confidence, any emergency that may arise in the measurement and control of temperatures. This can be realized only by

\* Professor of Physics, Columbia University.



laying an adequate theoretical foundation and by insisting on the "why" for everything done in the laboratory.

An examination of the textbooks on pyrometry and of the scientific papers and pamphlets relating to temperature measurements indicates very clearly that any instruction in this subject should be given by men possessing a thorough knowledge of physics. It would, therefore, seem natural and proper to develop a laboratory for instruction in the measurement of temperature and for standardization of pyrometers under the jurisdiction of the department of physics rather than under one of the engineering departments. Such a laboratory should be expected to turn out students thoroughly trained in the methods and principles of pyrometry, and capable without further instruction of using pyrometers effectively. It should, however, leave strictly technical matters, such as the heat treatment of metals, to the proper engineering laboratories.

Besides its first purpose of serving as a laboratory for the instruction of students in the underlying principles of temperature measurements, this laboratory should be provided with standardized instruments covering the range of temperature  $-200^{\circ}$  C. to the highest, so that all departments can find here opportunity for the calibration and checking of various types of pyrometers. In addition, provision should be made to assist, by means of advice, those in the university engaged in researches involving the measurement of temperatures. In other words, this laboratory should serve as a general clearing house for all questions relating to temperature measurements.

#### PREPARATION FOR ADMISSION

Admission to the course in pyrometry must presuppose a satisfactory completion of at least an excellent college course in general and experimental physics. Evidently the character of instruction in pyrometry and the results that can be obtained will depend on the thoroughness of the student's previous training.

#### ALLOTMENT OF TIME

The amount of time required for the course and its subdivision will necessarily depend on the character of the preparation prescribed for admission. If the students have already received a thorough grounding in the principles of heat, including a discussion of temperature scales and gas thermometry, in the laws of radiation of the black body and in electricity, there will be less need for formal lectures, and the hours assigned to the course can be devoted to laboratory work with provision for conferences or quizzes. Without adequate preparation, however, provision must be made for lectures on the theory and on the physical principles underlying temperature measurements, in order that the laboratory work may be performed with intelligence and effectiveness.

Assuming a satisfactory preparation, the course should extend through

at least one term (half the college year) and consist of a weekly laboratory period of not less than three consecutive hours and preferably four, with a weekly conference hour assigned for informal discussions, for the cross-examination of the students, and as an opportunity for talks by specialists invited from outside the university. More time may be advantageously allowed the course, but it is doubtful whether this will prove feasible owing to the congested nature of the curricula of our engineering schools. In any case, opportunity for additional work should be given to any students who desire it and have available time.

Besides the assignment of a definite number of hours weekly for laboratory and conference work, provision must be made in the curriculum for at least 6 hours weekly for home preparation if the instruction is to be made effective. This time is needed to complete the assigned reading of textbook matter, of the scientific papers, and of manufacturers' catalogs relating to the experiments to be performed, and for the preparation of a satisfactory report on the test made in the laboratory. Should the school curriculum be too full to permit this home work, the course on pyrometry should extend over a period of 1 year in order that the necessary reading and preparation of reports may be done in a regular laboratory period without causing a reduction in the actual amount of the experimental work originally proposed.

#### TEXTBOOKS AND REFERENCE MATERIAL

Each student should own, in addition to a textbook on pyrometry and any special notes that may be provided by the department, certain circulars of the Bureau of Standards and the catalogs of the leading makers of pyrometric apparatus. In the laboratory there should always be kept for ready reference complete files of all textbooks, catalogs, circulars, and scientific papers that may have a bearing on the subject-matter taught. Among textbooks may be suggested: Burgess, "Measurements of High Temperature;" Griffiths, "Methods of Measuring Temperature;" Ferry, "Practical Pyrometry;" Darling, "Pyrometry." One cannot afford to be without the reprints of two articles by Foote, Harrison and Fairchild, entitled, "Standardization of Rare-metal Thermocouples" and "Standardization of Base-metal Thermocouples" which appeared in the issues of *Metallurgical and Chemical Engineering of* Apr. 1 and 15, 1918.

Experience has shown conclusively that in such a specialized laboratory publications and pamphlets of the Bureau of Standards like the following are indispensable and should be in the possession of the students: *Circular 7*, "Pyrometer Testing and Heat Measurements"; *Circular 8*, "Testing of Thermometers;" *Circular 35*, "Melting Points of Chemical Elements and other Standard Temperatures;" *Circular 66*, "Standard Samples for Thermometric Fixed Points;" *Scientific Paper 250*, "Characteristics of Radiation Pyrometers;" *Scientific Paper 11*, "Optical Pyrome-

try;" *Scientific Paper* 202, "Note on Cold-junction Corrections for Thermocouples;" *Scientific Paper* 124, "Platinum-resistance Thermometry at High Temperatures."

For additional publications of the Bureau of Standards see *Circular* 24, issued Apr. 14, 1919.

In addition, valuable contributions have been made from the Geophysical Laboratory, the Nela Research Laboratory, and other sources. Besides, there is much excellent matter in many catalogs and bulletins issued by instrument makers, which they willingly distribute to students at the request of a school. These publications arouse the interest of the students in temperature measurements and methods of temperature control and afford them some familiarity with the types of apparatus and instruments in actual use and are frequently of real service in connection with the actual experimental work in the laboratory.

#### SUBJECT MATTER TO BE TREATED

In such a short article as this it is possible to give only a brief outline of the physical principles that must be included.

In the first place, the conception of the thermodynamic scale of temperature, the gas scale, the international hydrogen scale, black-body temperatures, and the practical realization of these scales should be presented and an effort should be made to acquaint the students with the accuracy and reproducibility of known freezing and boiling points and the accuracy attainable in the measurement of high and low temperatures.

In thermoelectric pyrometry, starting with a knowledge of thermoelectricity, a study should be made of rare- and base-metal couples. This should include such questions as: the annealing of rare-metal couples, welding of hot-junctions and making of cold-junctions, choice of metals for couples, discussion of formulas for the representation of the temperature-electromotive force relationship of couples, cold-junction corrections, interchangeability of base-metal couples, relative advantages of indicators versus service potentiometer or deflection potentiometer, high- versus low-resistance indicators, effects of depth of immersion, protecting tubes, the selection of couples, and some mention of recording thermoelectric pyrometers.

In resistance pyrometry, the relation of resistance to temperature should be taken up, followed by a discussion of Callendar's work on the resistance of platinum and of his formula giving the relation between the true temperature and the platinum temperature and the range for which this relationship holds; the construction of platinum thermometers, their calibration and use in connection with the Wheatstone bridge; the calibration and use of platinum and nickel thermometers with direct-reading instruments; range of the nickel thermometer; precision of re-

sistance thermometers and their availability; and something on recording resistance pyrometers.

As a basis for intelligent experimental work with radiation and optical pyrometers, considerable attention must be paid to the laws of radiation and of their bearing on the construction, theory, and use of such radiation pyrometers as the Féry (Taylor Instrument Co., or Cambridge Scientific Co.), Thwing and Brown, and of such optical pyrometers as the Wanner or Scimatco and the Leeds & Northrup. The discussion of radiation pyrometers should deal with the Stefan-Boltzmann "fourth power" law for the total radiation of a black-body radiator, with the question of the experimental realization of black-body conditions, with the conception of black-body temperature, and with the total radiation from oxide and metallic surfaces in its bearing upon the temperature of such bodies when measured with a radiation pyrometer calibrated to read black-body temperatures. Likewise, the laws of Wien and of Planck on the distribution of energy in the spectrum of a "full or black-body radiator" in their bearing on the measurement of temperature by optical pyrometers must be treated and attention given to the emissivity of metals and oxides as they influence the "apparent temperatures," as found by a calibrated optical pyrometer. Also, the distinction between brightness temperature and color temperature should not be overlooked. The construction, theory, calibration, range, and limitations of the various types of optical instruments and the precautions to be observed in their use should receive attention, particularly in connection with the laboratory tests.

If the time permits, a general study of liquid and gas thermometers, especially of the high-temperature mercury thermometer, can be made to advantage. Such a study would naturally include the discussion of the errors and limitations of this class of thermometers, their calibration and advantages. Any experimental procedure should follow the general plan outlined in the Bureau of Standards *Circular* 8 and Dickinson's paper on Heat Treatment of High Temperature Mercurial Thermometers, Reprint No. 32 of the Bureau of Standards.

Should this theoretical material be presented by lectures? Preferably not. What is desired is to teach the students how to get at the truth and how to handle the information when found. They will achieve this ability most quickly if they are required to work up the material by themselves. This method leads to independence of thought and confidence in one's self, valuable traits that should be encouraged. Naturally the guidance of the instructor will be needed, but this can be given effectively at the weekly conference, during the laboratory tests when the theoretical points arise, and by personal interviews. Informal discussion of theoretical and practical matters by students and instructors is bound to arouse keen interest and enthusiasm.

### SUGGESTIONS RELATIVE TO CONDUCT OF LABORATORY

In conducting a laboratory of pyrometry, it should be constantly borne in mind that the success of the instruction will in a large degree be measured by the skill and resourcefulness shown in the solution of unexpected and puzzling temperature problems arising in later professional work. Consequently, throughout the course emphasis should be laid on the fact that laboratory conditions are not industrial conditions, that the methods of the laboratory often cannot be followed in the works and that common sense must always be exercised in applying to industrial conditions the knowledge acquired in the laboratory. To this end a few suggestions may be offered:

The apparatus for any experiment or test should not be set up ready for mere "press the button" or "turn the crank" observations. On the contrary, the students should be required to assemble and adjust all apparatus that is needed in any test or calibration. An effort should be made to require in the experimental work speed as well as quality, in order that there may always be present in the mind of the student the importance of the "time factor" in any undertaking. The report of tests should include original data, calculations, plots, a brief discussion of the experimental test, and a summary of conclusions.

There should be prepared a set of questions for distribution among the students. These questions should be chosen: (1) to emphasize vital points that arise in industrial measurements of temperatures but which do not come up in the university laboratory and are, therefore, often overlooked by even the keenest students, and (2) to test the student's ability to use the information that has been given him in the course. They should also bring out common errors made by users of pyrometric apparatus, who often express dissatisfaction with an installation when the real trouble lies in their incorrect use of such apparatus.

A few examples may suffice as illustrations:

1. Should a single thermocouple installed in a furnace be relied upon for the control of the furnace? Does such a couple measure the actual temperature of the furnace and of a charge in the furnace?

This question should be used to emphasize the important but frequently overlooked fact that the pyrometer tells only the temperature of the hot end of the thermocouple and, when in a furnace, may fail for various reasons to indicate the temperature of the charge in the furnace.

2. Will the correct temperature of a mass of molten metal be obtained if a 4-ft. base-metal couple, made of wires of large cross-section and in a suitable protecting tube, is thrust into the metal to a depth of only 3 or 4 in.?

3. Give a diagram of the connections by which a single indicator may be used for reading temperatures given by three separate thermocouples.

4. Will the temperature of a flue gas be correctly measured by a

thermometer or pyrometer if the instrument is exposed to the direct radiation of hot material?

5. Can the true temperature of hot gases be obtained by the use of a base-metal couple made of wires of large diameter?

6. In measuring the temperature of the wall of a furnace that is full of cooler gases and fumes, would there be any advantage in selecting an optical pyrometer such as the Leeds & Northrup or the Wanner, in preference to a radiation pyrometer of the Féry or Thwing type?

7. State what type of instrument you would select to measure temperature over the following ranges with the degree of accuracy that can be expected:

— 100° to 0° C.; 100° to 500° C.; 500° to 1200° C.; 1200° to 2400° C.

8. With a Leeds & Northrup resistance indicator, can any platinum resistance thermometer be substituted for the one furnished with the instrument without altering the calibration?

In the compilation of such a set of questions it is advisable to obtain suggestions from professional men who have had experience in the actual use and installation of pyrometers.

#### TYPICAL EXPERIMENTS

Since it is in the laboratory that the student becomes acquainted with the actual apparatus and with experimental methods, it is very important that a wise selection of experiments be planned. In this connection it may be advisable to offer a word of caution with reference to the use of automatic instruments, such as thermoelectric or resistance recorders, for instruction purposes. While it is desirable that the students should handle such instruments and be familiar with their construction, operation and adjustment, it should not be at the sacrifice of more fundamental matters, for a competent student of pyrometry can master the chief features of these instruments quickly. As an illustration, take the case of the determination of the transformation points of a specimen of steel. It may be much more instructive for the student to obtain the data for the plotting of the desired transformation point curve by two galvanometers rather than by means of the Leeds & Northrup Transformation Point Indicator, which registers automatically such curves.

The following experiments are offered as a suggestion of the type of experiment that seems adapted to give a sound training in the theoretical and experimental basis of temperature measurements and in approved methods of calibration, while serving at the same time to familiarize the students with the pyrometers on the market and the precautions required in their use.

**EXPERIMENT 1.**—*Precision Calibration of Rare-metal Thermocouples.*—To calibrate a platinum-rhodium couple for the range 300° to 1100° C. by measuring, with a precision potentiometer, the electromotive force at the freezing point of zinc, antimony, and copper when the cold junctions

are at  $0^{\circ}\text{C}$ ., and to determine the constants in the thermoelectric formulas of Holman and of Holborn and Day connecting the temperature and electromotive force for interpolation from  $300^{\circ}$  to  $1200^{\circ}\text{C}$ . The carrying out of the experimental work will involve such matters as the setting up and adjustment of the precision potentiometers, the test for any thermoelectromotive forces in the potentiometer when all junctions of the rare-metal couple are at  $0^{\circ}\text{C}$ ., and the experimental determination of typical freezing-point curves of the metals zinc, antimony, and copper. Other important points that can be brought out through such a fundamental experiment will occur to the reader.

**EXPERIMENT 2.**—*Comparison Method of Calibration of Thermocouples.* This experiment should serve to bring out the correct procedure to be followed in the comparison method of calibrating thermocouples and the precautions to be observed. If the calibration is of base-metal couples against a standard rare-metal couple, the furnace method may be used or the molten-metal bath. (See Foote, Harrison and Fairchild, *Metallurgical & Chemical Engineering*, April, 1918.) A critical study of methods for making cold-junction corrections may be included to advantage.

**EXPERIMENT 3.**—*A Study of Indicators.*—This exercise should be planned to give a fairly comprehensive insight into the theory, construction, operation, and limitations of millivoltmeter indicators and of service potentiometers. It should include the effect of any appreciable change in the resistance of the circuit due to faulty contacts, change in lead resistance and change in resistance of the couple on the millivolt temperature indications of high- and low-resistance millivoltmeter indicators and on the service potentiometer. Likewise, such questions as the possibility of the interchangeability of couples with any given indicator, the effect of size of thermocouple wires and depth of immersion may be brought out.

**EXPERIMENT 4.**—*Electrical Resistance Thermometers.*—This exercise may be devoted to a fairly comprehensive study of the theory of the resistance thermometer, its precision and limitations. It should naturally include such matters as: (1) the calibration of a platinum bulb for the range  $-40^{\circ}$  to  $1100^{\circ}\text{C}$ . by use of the melting point of ice and the boiling points of steam and sulfur and the reduction of platinum temperatures to true temperatures by the Callendar formula; and (2) the measurement of temperatures with commercial types of direct-reading indicators designed for use with platinum and nickel thermometers, and the test of their calibration. Other points that could be brought out are the three versus four compensation leads, the interchangeability of resistance bulbs with a given indicator, and the availability of resistance thermometers versus the thermoelectric pyrometers for industrial work.

**EXPERIMENT 5.**—*Radiation Pyrometers.*—The following suggestions may be offered as possible objects of such an experiment: (1) To familiarize the student with the construction and technique of such instruments

as the Féry, Thwing, and Brown. (2) To emphasize certain theoretical considerations involved in the construction and use of these instruments. (3) To compare the readings of these instruments with each other and with the temperature given by a calibrated platinum-rhodium couple using as the radiating source a furnace possessing closely black-body conditions.

**EXPERIMENT 6.—Optical Pyrometers.**—This experiment should include at least these two objects: (1) To bring out the fundamental laws of radiation on which optical pyrometry is based and to emphasize the relative advantages of optical versus radiation pyrometers. (2) To acquaint the students with the construction, theory, operation, calibration, errors, range and limitations of the Leeds & Northrup or Holborn-Kurlbaum and the Wanner or Scimatco types of instruments.

The foregoing experiments are offered merely as suggestions and should be modified to meet the needs and ideals of the individual laboratories. They are not intended to be specific or complete. Many other experiments are possible, such as the study of Seger cones, the specific heat pyrometer, high-temperature mercury thermometer, the location of transformation points, etc. Also no mention has been made of the length of the exercises, whether they should cover one, two, or more laboratory periods. These are matters for individual solution.

As an important feature of the instruction is to develop initiative and independence of thought, it is advisable to give the student a few experimental problems for which he is required to plan the procedure. For example, the student might be furnished with a precision potentiometer assumed to read correctly or for which there is a calibration curve, a Weston standard cell, sensitive galvanometer, storage battery, and rheostat and then be asked to calibrate a service potentiometer and a pyrovolter, submitting his plan to the instructor for criticism and approval before beginning the calibration.

#### CONCLUSIONS

Mere acquaintance with constructional details of pyrometers and their operation is readily acquired. Such information is, however, not sufficient for the intelligent application of pyrometers to the scientific and industrial measurement of temperature. What a course in pyrometry must do is to lay such a sound foundation that any subsequent heat problems can be attacked with confidence and good judgment. It should also make impossible ridiculous claims of accuracy that are patently unwarranted.

As to the attitude of the student body toward such a course, there can be no question. The nature of the experimental work and its practical bearing offer a strong appeal to engineering students and to those in pure science. The main difficulty is likely to be that the students will become absorbed in the course to the detriment of some of their other university studies.



## Teaching Pyrometry in Technical Schools

BY C. E. MENDENHALL,\* PH. D., MADISON, WIS.

(Chicago Meeting, September, 1919)

FOR the purpose in hand, pyrometry may be taken to include all temperature measurements from, say, 200° C. to the highest attainable, especially when considered from the technical or applied side. It will be convenient first to consider the entire content of a course of study grouped under the headings of the various methods of measurement, which are quite distinct in principle and involve different equipment. Brief suggestions will be given under each heading, and the summary will be followed by comments on the purpose of such a course and methods of conducting it.

1. Expansion and pressure methods: mercury thermometers (glass and quartz), liquid, gas, and vapor-pressure thermometers, especially recording instruments. Especial attention should be given to the limitations of these methods, which, particularly in high-temperature mercury thermometry, are often overlooked. Range approximately to 700° C.

2. Resistance thermometers: both bridge and potentiometer methods, of indicating and recording. Calibration; lead compensation; design of thermometers for special purposes. Range to 1200° C.

3. Thermoelectric pyrometers: potentiometer and deflection methods indicating and recording. Calibration, leakage errors, contamination errors, base and noble couples. Range to 1500° C.

4. Total radiation methods: thermoelectric, resistance, and expansion indicators, mirror and lens collectors, calibration, permanence of characteristics, absorption errors. Range, to highest attainable temperatures. Methods of producing perfect radiators—true, and virtual or “black body” temperatures.

5. Partial radiation methods: absorption and spectroscopic methods of getting partial radiation, various comparison sources, polarization, electric, sector, and absorption methods of controlling intensity (Morse, Lummer, and Wanner types). Calibration, permanence of calibration, absorption errors. Methods of producing perfect radiators—improvised methods; true, and virtual or black-body temperatures.

It is not necessary to go into the detailed working out of a course to cover the ground outlined, but certain general questions present them-

---

\* Chairman of Section on Mathematics and Physics of the National Research Council.

selves and must be answered. For example, should the course be planned as one strictly dealing with high-temperature measurement, or should it deal more broadly with the measurement and production of high temperatures? The latter arrangement adds to the interest of the course, and the combination is quite logical. If this choice is made, we can proceed to consider the distribution of time. The total time may be taken at from twelve to eighteen periods of 3 or 4 hr. each, and the content must be varied somewhat to suit the time available and the special conditions.

During the first half of the course, attention should be concentrated rather on the methods of measurement, the simplest and most reliable means being provided for giving steady temperatures just sufficiently high for the purpose, as uncertainties are apt to increase greatly at higher ranges. For certain parts of the work, these devices can be of low thermal capacity (such as heated strips, lamps, etc.) that will reach a steady state very quickly, so that no time will be lost in waiting for things to "settle down." In other cases, it will be necessary to use furnaces or boiling tubes, and arrangements should be made so that these can be started before the regular laboratory period. With proper care, it will be possible during this part of the course to do effective work in the laboratory during 2 or 3 hr. of the total period; the remaining time should be devoted to classroom discussions on topics such as these: Fundamental ideas of temperature and the temperature scale, standard fixed points, theory of bridge and potentiometer measurements, laws of radiation, perfect and ordinary radiators, ideas of thermal conductivity and thermal capacity applied to furnace construction.

The latter half of the course may be devoted to the application of the methods, the technique of which has been briefly studied, and to the measurement of temperatures under conditions closely approximating those actually found in practice. More attention should also be paid to the methods used in the production and maintenance of high temperatures, and the range of temperatures used should be extended. The exact content of this part of the course can be greatly varied, depending on the equipment available, but the various furnaces should follow standard practice, on a reduced scale, and, if possible, should be designed to bring out the different limitations and advantages of the several methods of measurement. Interest would be increased if the temperatures measured were those concerned with or controlling important high-temperature phenomena; that is, melting points (for standardization), recalescence points, reactions, crystalline transformation, increase of conductivity in substances normally insulators, etc. The reason for dividing the work rather sharply into two parts, as has been suggested, is obvious.

The difficulties involved in the mere production and control of high temperatures are in themselves considerable, and increase rapidly at the higher ranges. If the student is confronted at the same time by these

difficulties and those inherent in the various methods of measurement, the result is sure to be confusion and discouragement. A large part of this can be avoided by the scheme proposed.

Another general question that arises is, should the apparatus be so designed and arranged as to be "fool-proof" or "fool-killing"? The difference is clear. According to the first, every effort would be made by choice of equipment, arrangement, and instructions to insure that all the experiments proceed smoothly and without interruption or mishap, very little of the assembly of apparatus being left to the student, who is not made to feel much responsibility for its successful operation. In this case the thoughtful student will get an excellent idea of the maximum possible accuracy of the methods used, while the poor student will get an entirely erroneous idea of the ease with which the work may be done, and neither will appreciate fully the effort and thought expended on the design and arrangement, in order to produce the result. By the second method, in which the equipment is intentionally chosen in more disconnected elements which must be assembled or connected up by the student, and in which the "eternal cussedness of inanimate things" is allowed to display itself in more normal fashion, the thoughtful student will get more insight into the difficulties of the situation and be stimulated to overcome them by his own initiative, but the poor student will be well-nigh hopelessly muddled and discouraged and ultimately dropped. Which of these is chosen must depend on circumstances, on the relative importance attached to numbers as compared to quality of students, and on the extent of equipment available. In most cases a compromise is necessary and probably desirable.

Finally comes the question as to where the course should be given; that is, in what department. The situation demands a combination to insure the best results. On the one hand is needed that interest in precision, in method, and in working out new methods, which is more apt to be found in departments of physics; on the other hand, it is essential to have an immediate contact with real problems and real conditions, such as would exist in departments of metallurgy, electrochemistry, or similar engineering groups. If the course could be given by a combination of a physics and an engineering department, not only would the proper balance of the course be maintained, but an important step taken to insure that close coöperation of departments of pure and applied science which everyone believes to be most stimulating and wholesome for both. Unfortunately, such coöperation in course giving, while possible at smaller institutions, becomes very difficult at the larger and more elaborately organized universities, where the dividing line between departments and between groups of departments unfortunately tends to become more marked. Though this situation frequently involves high-temperature phenomena, they are not measurable by our methods and therefore do not concern us.

## Teaching Pyrometry

BY O. L. KOWALKE,\* MADISON, WIS.

(Chicago Meeting, September, 1919)

THE measurement and control of temperatures have assumed positions of great importance in many industries. The manufacturers of by-product coke and carbureted water gas find that proper temperature control helps to produce a better product and economizes in the use of raw materials. In the manufacture of glass, enameled ware, brass, and high-temperature refractories, temperature control is now regarded as being coördinate in importance with the control of materials used. To control such processes as malleablizing cast iron, and hardening, tempering, and annealing of steel in a manner to meet exacting market requirements has, within recent years, involved the installation of large and expensive pyrometer equipments. In many of these installations, it was necessary not merely to measure but also to record the temperatures over a period of time and thus obtain a record of the entire heat treatment and an effective check on the workmen in charge.

In view of the importance of temperature measurement and control in such a wide variety of industries and the necessity for proper supervision of the installation and operation of the outfits, the following questions may be pertinent: What instruction is offered by the engineering colleges and what departments in the colleges are responsible therefor?

The latest available catalogs of ten prominent engineering colleges east of the Mississippi River showed courses in high-temperature measurements given by the departments of physics. These courses, in general, were described as comprising classroom and laboratory instruction in the theory of high-temperature measurements, together with exercises in the calibration of the various devices used. In some cases it was stated that consideration would be given, in the courses, to the practical applications in the industries. In only one college was the course required of all engineering students; in most colleges it was optional; in a few colleges, it was required only of certain groups. In colleges offering a course in metallurgical engineering, instruction in pyrometry was always given in connection with metallurgical laboratory work. The students in ceramic, chemical, and metallurgical engineering in three colleges were given somewhat formal instruction in pyrometry by their respective faculties. It did not appear that mechanical or electrical engineering students in any of

---

\* Professor of Chemical Engineering, University of Wisconsin.

the colleges, except one, were scheduled for instruction in pyrometry, although such students, after graduation, are frequently engaged in work requiring heat treatment of metal or temperature control.

Is a special course in pyrometry in the curricula for ceramic, chemical, mechanical, and metallurgical engineers justifiable? This may be a debatable question. Local conditions and plan of organization of the college usually govern the feasibility of such a requirement. Considerable time, however, is given to instruction of students in the above courses in the determination of the heating values of coal and gas, the quality of steam, the composition of gases, and the measurement of electrical energy. Is it probable that all these students, after graduation, will make use of the instruction in any of the above determinations more frequently than of a proportionate amount of instruction in pyrometry? The field of usefulness of pyrometers will be extended in keeping with the improvements in the instruments and a realization of the necessity for accurate temperature measurements and control. In view of the present wide application and importance of pyrometry, instruction in it should receive at least the same emphasis in the curricula for ceramic, chemical, and mechanical engineering that it apparently receives in the curriculum for metallurgical engineering in most colleges.

It would be difficult to prescribe the content of a course in pyrometry to meet the conditions in all colleges. Since most engineers will have to do with the measurement and control of temperature in industrial operation, it seems desirable to confine the scope of this discussion to industrial needs. The operation of the law of the survival of the fittest seems to have left the thermocouple, the radiation, and the optical pyrometers in possession of the field of high-temperature operations. Thus, a minimum content of course ought to include instruction in the principles of operation and the calibration and applications of each of these types. Historical matter and development of the fundamental temperature scales need be only briefly considered; but some time can profitably be devoted to the study of the construction of auxiliary equipment, such as furnaces, heat regulating and insulating devices.

The thermocouple is no doubt more widely used than any other device for measuring high temperatures, and it is also much abused. The instruction concerning it might well include: method of making, calibration by determining the electromotive force at the melting points of pure metals, calibration against a standard couple, effect of depth of immersion on resultant electromotive force due to heterogeneity, and protection against contamination. The measurement of the electromotive forces of couples by millivoltmeters and potentiometers may be studied with special reference to low against high resistance millivoltmeters, millivoltmeters against potentiometers with different depths of immersions, and varying temperatures in the lead wires.

Radiation pyrometers of the fixed and movable focus type and optical pyrometers of the Wanner and Morse types should be studied with reference to the principles involved in each, the construction, the methods of calibration, the limitations of each for various kinds of work, and the ease with which they may be manipulated. Special optical pyrometers, involving the matching of colored screens in the instrument against the field of vision, can be given some consideration.

Due to the limited use of resistance thermometers in the measurement of furnace temperatures, less emphasis may well be put on them than on thermocouples. It is worth while to point out the principles involved, the construction of the apparatus, and the methods of calibration. If the time can be spared, actual calibrations from fixed points are greatly worth while.

Since check calibrations on pyrometer installations are always necessary and since the engineer in charge will many times have to do such work with meager equipment, it will be worth the time spent to teach the student how to construct furnaces and heat-regulating devices. It may not be advisable to require the student to construct the furnaces used in the course, but it is desirable, wherever possible, for him to make the repairs.

The interest of the average student is not sustained in a course in pyrometry if it is devoted exclusively to problems in calibration, such problems being long and somewhat tedious. He takes a much greater interest, however, if he is given exercises that bring out the limitations and sources of error in the particular pyrometer employed. Among the problems that have been found stimulating to the student are: the determination of the temperature gradient in various kinds of firebricks; the temperature of decomposition of limestone; comparison of thermocouples with Seger cones, or with "Sentinel pyrometers" frequently used in the heat treatment of steel; and dehydration temperature of clay. The determination of the transformation temperatures in steels of various carbon contents by the differential couple and the simple cooling curve seldom fails to arouse interest; it also ties the principles of metallography and pyrometry together. The measurement of the temperature of molten copper in a ladle, with and without the oxide film, simultaneously with a thermocouple, a radiation pyrometer, and optical pyrometers of the Wanner and Morse types, is an excellent exercise to show the effect of emissivity. Many other problems can be devised; these are suggestions. Such correlation has been found to work well here and in other colleges because it gives an opportunity to link together a number of lines of study through the teaching of pyrometry.



## INDEX

NOTE.—In this Index the names of authors of papers are printed in small capitals, and the titles of papers in italics.

- Absolute temperature, 40.  
Absolute thermodynamic scale, 63.  
Absolute zero, 40.  
    value, 42, 66.  
Absorbing screens for optical pyrometer, 313.  
    effect of temperature change, 316.  
    spectral transmission, 313.  
    total transmission, 313.  
Accuracy of Wien's Equation, 293.  
Accuracy tests with optical pyrometer: different laboratories, 311.  
    experienced observers, 310.  
    inexperienced observers, 309.  
ADAMS, L. H.: *Tables and Curves for Use in Measuring Temperatures with Thermocouples*, 165.  
    *Discussions: on Standard Scale of Temperature*, 59;  
        *on Potentiometers for Thermoelement Work*, 147.  
*Alloys Suitable for Thermocouples and Base-metal Thermoelectric Practice* (LOHR), 181.  
Alundum tubes, 241, 252, 256.  
AMES, J. S.: *Temperature*, 37.  
*Annealing of Glass* (TOOL and VALASEK), 475; *Discussion: (WILLIAMSON)*, 482.  
Annealing of glass, 472.  
    cooling procedure, 480  
    relaxation time, 478.  
    temperature range, 476.  
Apparent temperature, 337.  
    correction to true, 337, 339.  
*Application of Pyrometers to the Ceramic Industry* (GOHEEN), 535.  
*Application of Pyrometry to the Ceramic Industries* (THWING), 516; *Discussion: (OWENS)*, 519; (PURDY), 520.  
*Application of Pyrometry to the Manufacture of Gas-mask Carbon* (MARSH), 652; *Discussion: (NEWCOMB)*, 667; (HUBBARD), 667; (AUTHOR), 668.  
*Application of Pyrometry to Problems of Lamp Design and Performance* (VAN HORN), 638; *Discussion: (WORTHING)*, 644.  
Arsem furnace, 277.  
ASHMAN, A. O.: *Discussions: on High-temperature Thermometers*, 239;  
    *on Pyrometer Porcelains and Refractories*, 253;  
    *on Recent Improvements in Pyrometry*, 204;  
    *on Thermoelectric Pyrometry*, 128.  
*Automatic Compensation for Cold-junction Temperatures of Thermocouple Pyrometers* (WUNSCH), 206; *Discussion: (BRISTOL)*, 212.



- Base-metal thermocouples, 78, 181, 183, 191.  
    calibration data, 170.  
    constancy, 156.  
    electrical resistance, 108.  
    factors affecting usefulness, 154.  
    homogeneity, 156.  
    insulation of wire, 194.  
    resistance to oxidation, 160.
- Bases: optical pyrometry, 70, 325.  
    pyrometer calibration, 325.
- BASH, F. E.: *Electric, Open-hearth and Bessemer Steel Temperatures*, 578.  
    *Forging Temperatures and Rate of Heating and Cooling of Large Ingots*, 614.  
    *Industrial Applications of Disappearing-filament Optical Pyrometer*, 352.  
    *Report of Sub-Committee of Pyrometer Committee*, 32.
- BEHR, L.: *Recording Thermocouple Pyrometers*, 400.
- Bessemer steel furnace temperature, 578.
- Bisque burn, 248.
- Black body: condition, 335, 348.  
    definition, 42, 66, 285, 293, 352, 367, 496.  
    Lummer-Kurlbaum, 56.  
    practical, 293, 324.  
    radiation, 42.  
    wedge method, 385.
- Black-body temperature, 43, 71, 286, 288.  
    brightness temperature, 288, 304.  
    color temperature, 288, 304.
- Blast-furnace work, pyrometry in, 544
- BONN, N. E.: *Reference Standard for Base-metal Thermocouples*, 179.
- Bottle-glass manufacture, pyrometry in, 483.
- Brightness copper surface, 350.
- Brightness temperature, 288, 304.  
    corrected to constant wave-length, 306.  
    true temperature relation, 304.  
    wave-length ascribed to, 304, 389.
- BRISTOL, W. H.: *Discussions: on Recent Improvements in Pyrometry*, 205;  
    *on Automatic Compensation for Cold-junction Temperatures*, 212;  
    *on Pyrometry and Steel Manufacture*, 577.
- BROWN, R. P.: *Recent Improvements in Pyrometry*, 188.  
    *Discussion on Pyrometry and Steel Manufacture*, 576.
- Brown heatmeter, 90, 198.
- BRUSH, C. F.: *Some Thermal Relations in the Treatment of Steel*, 590.
- Bulb temperature, gas-filled lamps, 643.
- Bureau's method of calibrating thermocouples, 147.
- BURGESS, G. K.: *Report of Pyrometer Committee of National Research Council*, 3;  
    *Discussion*, 36.  
    *Discussion on Optical and Radiation Pyrometry*, 350.
- BURGESS, G. K. and Waidner, C. W.: *Metals for Pyrometer Standardization*, 61.
- $c_2$ , value of, 52, 53, 73, 286.
- Calibration: optical pyrometer, 300, 324, 334, 503.  
    thermocouples, 76, 147, 164, 168, 170, 617, 675.
- Carbon steel, 602.
- Carbon vs. tungsten pyrometer filaments, 303.

- Carborundum tubes, 241, 253, 262.  
Carnot's principle, 41, 63.  
Cement kilns, pyrometer in, 522.  
Cement temperature, 365.  
Centigrade thermodynamic scale, 46.  
Centigrade system, 40.  
Ceramic industry, 516, 535.  
Chromel-alumel couples, 76, 182.  
Chromel-iron couple, calibration of, 617.  
CLARK, W. M. and SPENCER, C. D.: *Pyrometer Shortcomings in Glass-house Practice*, 509.  
Clay wares: drying of, 543.  
    pyrometry in manufacture, 513.  
COBLENTZ, W. W.: *Present Status of Radiation Constants*, 72.  
Cold junction: burying of, 113, 204.  
    compensation, 95, 96, 99, 103, 175, 184, 194, 195, 206, 401, 510.  
    correction factors, 96.  
    method using: carbon disks, 208.  
        mercury, 206.  
        potentiometer, 98.  
        resistance coils, 209.  
        shunt, 100, 103.  
        wheatstone bridge, 103, 209.  
    temperature of, 96, 122.  
Color temperature, 288, 304.  
Committee, International, 46, 58.  
Committee, Pyrometer, of National Research Council, names, 3.  
Compensated leads, 97, 205.  
Concept of temperature, 37.  
Constant-pressure gas scale, 65.  
Constant-volume gas scale, 65.  
Contamination of thermocouples, 76.  
Corning red glass, 296, 313.  
Couples: see thermocouples.  
  
DANA, L. I.: *Melting Point of Refractory Materials*, 267; *Discussion*, 283.  
DANA, L. I. and FAIRCHILD, C. O.: *Pyrometry in Rotary Portland Cement Kilns*, 522.  
Deflection potentiometer: method, 90, 148, 301.  
    theory, 91.  
Degree, measure of, 39.  
Depth of immersion: thermocouples, 123.  
    thermometer, 586.  
Diffraction around pyrometer filament, 306.  
    test of, 318.  
Disappearing-filament pyrometer, 291, 319, 324, 352.  
    polarization in, 319.  
Dressler tunnel kiln, 542.  
Drinker method, 7.  
  
Effective wave-length, 54, 297.  
    determination of, 297.  
    variation of, 298.  
Electric charge, unit, Millikan's value, 73.

- Electric furnace: temperature, 578.  
tapping temperature, 579.
- Electric, Open-hearth and Bessemer Steel Temperatures* (BASH), 578; *Discussion:*  
(TAYLORSON), 589.
- Emissive Powers and Temperatures of Non-black Bodies* (WORTHING), 367.
- Emissive powers, 287, 363, 367, 368, 384.  
pseudo, 397.  
spectral, 372, 381.  
total, 371, 373.  
variation of, 393.
- Emissivity: steel, slag, 13, 356.  
temperature correction for, 13.  
tungsten, 390.  
various metals, 337.
- EMMONS, J. V.: *Pyrometry in the Tool-manufacturing Industry*, 610.
- Englehard indicator, 83.
- Errors: line resistance, 82.  
in radiation pyrometry, 347, 377.  
temperature of steel furnaces, 36.
- Expansion pyrometers, 189.
- FAIRCHILD, C. O.: *Discussion on Theory and Accuracy in Optical Pyrometry*, 322.
- FAIRCHILD, C. O. and DANA, L. I.: *Pyrometry in Rotary Portland Cement Kilns*, 522.
- FAIRCHILD, C. O. and FOOTE, P. D.: *Optical and Radiation Pyrometry*, 324.  
*High-temperature Control*, 435.  
*Recording Pyrometry*, 406.
- FAIRCHILD, C. O., FOOTE, P. D. and HARRISON, T. R.: *Thermoelectric Pyrometry*, 74;  
*Discussion*, 134.
- FIELD, A. L.: *Discussions: on Report of Pyrometer Committee*, 36.  
*on Pyrometry in Blast-furnace Work*, 558.
- FENNER, C. N.: *Use of Optical Pyrometers for Control of Optical-glass Furnaces*, 495;  
*Discussion*, 505.
- Fery: optical pyrometer, 326.  
radiation pyrometer, 345, 374.
- Field of view, optical pyrometer, 333, 354.
- Firebrick, 282.
- Fixed points, thermometry, 50, 51, 167.
- Fixed junction correction, 174.
- FOOTE, P. D.: *Discussions: on Standard Scale of Temperature*, 60.  
*on Melting Point of Refractory Materials*, 282;  
*on Optical and Radiation Pyrometry*, 351;  
*on Tin: An Ideal Pyrometric Substance*, 465.
- FOOTE, P. D. and FAIRCHILD, C. O.: *Optical and Radiation Pyrometry*, 324.  
*High-temperature Control*, 435.  
*Recording Pyrometry*, 406.
- Foote & Fisher pyrometer, 331.
- FOOTE, P. D. and HARRISON, T. R.: *Discussion on Self-checking Galvanometer Pyrometer*, 151.
- FOOTE, P. D., HARRISON, T. R. and FAIRCHILD, C. O.: *Thermoelectric Pyrometry*, 74;  
*Discussion*, 134.
- FOOTE, P. D., W AidNER, C. W. and MUELLER, E. F.: *Standard Scale of Temperature*, 46.
- Forging temperatures, 5, 357, 570, 614, 623.

- Forging Temperatures and Rate of Heating and Cooling of Large Ingots* (BASH), 614;  
    *Discussion: (FRY)*, 626.
- Formula for thermocouple, 51.
- FORSYTHE, W. E.: *Theory and Accuracy in Optical Pyrometry with Particular Reference to the Disappearing-filament Type*, 291; *Discussion*, 323.  
    *Discussions: on Potentiometers for Thermolement Work*, 148;  
    *on Pyrometer Protection Tubes*, 257.
- Foster, radiation pyrometer, 344.
- Frazil ice, 462.
- FREEMAN, J. R., Jr. and Scott, H.: *Use of Modified Rosenhain Furnace for Thermal Analysis*, 214.
- FREY, C. P.: *Resistance Thermometry for Industrial Use*, 458.
- FRINK, R. L.: *Pyrometry Applied to Bottle-glass Manufacture*, 483.
- FRY, L. H.: *Discussion on Forging Temperatures of Large Ingots*, 626.
- Fundamental Laws of Pyrometry (Mendenhall)*, 83.
- Furnaces: Arsem, 277.  
    black-body, 293.  
    glass-tank, 483.  
    Heroult, 588.  
    iridium-tube, 53, 277.  
    Owens revolving pot, 488.  
    refractory melting points, 276.  
    Rosenhain, 214.  
    tungsten and molybdenum wound, 279.  
    vacuum, 277.
- Galvanometer: direct reading, 138.  
    high resistance, 80.  
    lack of precision in, 139.  
    mounting of, 113.  
    sensitivity of, 138.  
    swamping resistance, 80.
- Gas loss, straight coiled filament, 640.
- Gas-mask carbon: application of pyrometer in manufacture, 652.  
    air treater, 654.  
    steam treater, 656.  
    thermocouple used, 661.  
    pyrometer tubes for, 664.
- Gas pressure, 64.
- Gas scale, 46, 63.
- Gas thermometers, 189.
- Gas thermometry, limits of, 64.
- Glass: annealing of, 475.  
    cooling procedure, 478.  
    relaxation time, 478.  
    thermocouple installation for annealing kiln, 466.  
    transformation temperature, 478.
- Glass industry, optical pyrometer in, 130, 358, 491, 509.
- Glass pot, measurement of temperature in, 502.
- Glass-tank furnace, 483.
- Glazing of tubes, 248.
- Glost burn, 250.
- GOHEN, J. P.: *Application of Pyrometers to the Ceramic Industry*, 535.

- Gold, melting point, 51, 286.  
Gold-point palladium-point brightness ratio, 52.  
Graphite tip, 16.  
GUILLAUME, C. E.: *Discussion on Standard Scale of Temperature*, 58.
- HARRISON, T. R.: *Discussions: on Potentiometers for Thermoelement Work*, 147;  
*on Thermoelectric Pyrometry*, 136;  
*on Some Factors Affecting Usefulness of Base-metal Thermocouples*, 164.  
HARRISON, T. R. AND FOOTE, P. D.: *Discussion on Self-checking Galvanometer Pyrometer*, 151.  
HARRISON, T. R., FOOTE, P. D. and FAIRCHILD, C. O.: *Thermoelectric Pyrometry*, 74;  
*Discussion*, 134.  
HARRISON & Foote indicator, 84, 141.  
HARVEY, F. A.: *Pyrometer Protection Tubes*, 255; *Discussion*, 257.  
*Discussion on Optical and Radiation Pyrometry*, 351.  
Heat generated after tempering, 590.  
    carbon steel, 602.  
    manganese steel, 604.  
    nickel chromium, 595.  
Heatmeter, Brown, 90.  
Heat treatment, steel, 358.  
*High-temperature Control* (FAIRCHILD and FOOTE), 435; *Discussion: (NEWCOMB)*, 449.  
High-temperature control: automatic alarms, 441.  
    field of, 435.  
    manual alarms, 441.  
High temperature, measurement of, 368.  
*High-temperature Scale and its Application in the Measurement of True, Brightness and Color Temperatures* (HYDE), 285.  
High-temperature scale, 51.  
    reproduction of, 57.  
*High-temperature Thermometers* (WILHELM), 225; *Discussion: (ASHMAN)*, 239;  
    (AUTHOR), 239.  
High-temperature thermometers, testing of, 237.  
High-resistance galvanometers, 80.  
Hot junctions, making, 77.  
*Hot-wire Anemometer with Thermocouple* (TAYLOR), 221.  
HUBBARD, C. W.: *Discussions: on Application of Pyrometry to the Manufacture of Gas-mask Carbon*, 667;  
    *on Pyrometer Porcelains and Refractories*, 254.  
HUTCHINS, O.: *Pyrometer Protection Tubes*, 262.  
HYDE, E. P.: *High-temperature Scale and its Application in Measurement of True, Brightness and Color Temperature*, 285.  
    *Discussion on Standard Scale of Temperature*, 60.  
Hydrogen scale, 41.  
    international, 46.
- Ice, frazil, 462.  
Ice point on Kelvin's scale, 66.  
Incandescent gas mantles, temperature, 632.  
Incandescent lamp filaments, temperature of, 627.  
*Industrial Applications of Disappearing-filament Optical Pyrometer* (BASH), 352.  
Ingots, rate of heating and cooling, 614, 618.  
International hydrogen-scale temperature, 46.

- International temperature scale, 49, 450.  
Iridium tube furnace, 53, 277.  
Iron-constantan in couples, 260.  
Iron oxide, radiation temperature and true temperature relation, 378.  
IVES, H. E.: *Temperature Measurements of Incandescent Gas Mantles*, 632.
- Japan protecting tubes, 256.  
JOSEPH, T. L. and ROYSTER, P. H.: *Pyrometry in Blast-furnace Work*, 544; *Discussion*, 563.  
Joule-Kelvin coefficient, 41.
- Kelvin's temperature scale, 41, 46, 63, 288.  
KEUFFEL, C. W.: *Pyrometry as Applied to Manufacture of Optical Glass*, 506.  
Kirchhoff's black body, 42, 66.  
Kirchhoff's law, 368.  
KOWALKE, O. L.: *Some Factors Affecting the Usefulness of Base-metal Thermocouples*, 154.  
*Teaching Pyrometry*, 681.  
KRAYBILL, H. R. and SLIGH, T. S., Jr.: *Temperature of a Burning Cigar*, 645.
- Laboratory form of pyrometer, 295.  
Lambert's cosine law, 302, 371, 396.  
Lamps: temperature of incandescent filament, 627, 638.  
temperature and efficiency of, 628.  
temperature and size, 630.  
Laws of pyrometry, 63.  
Le Chatelier pyrometer, 292.  
LINCOLN, R. B.: *Protecting Tubes for Thermocouples*, 258.  
LINVILLE, C. P.: *Discussion on Pyrometry in Blast-furnace Work*, 560, 562.  
Liquids in thermometers, 234.  
LITTLETON, J. T., Jr.: *Discussion on Thermoelectric Pyrometry*, 130.  
LOHR, J. M.: *Alloys Suitable for Thermocouples and Base-metal Thermoelectric Practice*, 181.  
Lummer-Kurlbaum black body, 56.
- Manganese steel, magnetic effects of, 604.  
Manufacture of porcelain tubes, 244.  
Marquardt tubes, 255.  
methods of making, 241.  
MARSH, K.: *Application of Pyrometry to the Manufacture of Gas-mask Carbon*, 652; *Discussion*, 668.  
*Melting Point of Refractory Materials* (DANA), 267; *Discussion*: (UNGER), 282; (FOOTE) 282; (PURDY), 283; (AUTHOR), 283.  
Melting points, gold, 51, 286.  
palladium, 52, 54, 55, 286.  
platinum, 56.  
refractory materials, 267.  
tungsten, 57, 392.  
Melting point standardization, 61.  
MENDENHALL, C. E.: *Fundamental Laws of Pyrometry*, 63.  
*Teaching Pyrometry in Technical Schools*, 678.

- Mercurial thermometers, 225.  
  emergent stem error, 229.  
  error in, 232.  
  industrial type, 228.  
  inert gas in, 232.  
  stem correction data, 231.  
  testing of, 237.
- Metals for Pyrometer Standardization* (Waidner and Burgess), 61.
- MILLER, A. H.: *Pyrometry and Steel Manufacture*, 567.
- Millikan's value, unit electric charge, 73.
- Monochromatic screens, 295.  
  Corning red glass, 296.  
  effective wave-length, 297.  
  transmission of, 296.
- Morse thermogage or pyrometer, 611, 627.
- MUELLER, E. F., Waidner, C. W., and Foote, P. D.: *Standard Scale of Temperature*, 46.
- Multiple point recorders, 420.
- NEWCOMB, R. W.: *Pyrometer Porcelains and Refractories*, 251.  
  *Discussions: on Recording Thermocouple Pyrometers*, 405,  
  *on Application of Pyrometry to Manufacture of Gas-mask Carbon*, 667.  
  *on High-temperature Control*, 449;  
  *on Recording Pyrometry*, 433;
- Nickel-chromium steel, 595.
- Nitrogen scale: correction to constant pressure, 66.  
  correction to constant volume, 65.
- Non-black bodies, 304, 367.  
  conditions, 335, 348.  
  temperature of, 304.
- Non-ferrous foundry, pyrometer in, 360.
- NORTHROP, E. F.: *Tin: An Ideal Pyrometric Substance*, 464.  
  *Discussions: on Recent Improvements in Pyrometry*, 205;  
  *on Optical and Radiation Pyrometry*, 349.
- Northrup pyrovolter, 89.
- Open hearth, temperature in, 578.
- Optical and Radiation Pyrometry* (Foote and Fairchild), 324; *Discussion:*  
  (Northrup), 349; (Burgess), 350; (Worthing), 350; (Foote), 351;  
  (Harvey), 351.
- Optical glass, pyrometer in manufacture of, 491, 495, 506, 509.
- Optical pyrometer (see also pyrometers), 677.  
  as photometer, 350.  
  basis of, 70, 325.  
  calibration of, 300, 324, 334, 503.  
  Fery, 366.  
  field of view, 333, 354.  
  theory of, 291.
- OWENS, F. T.: *Discussion on Application of Pyrometry to the Ceramic Industries*, 519.
- OWENS revolving pot, 488.
- Palladium, melting point, 52, 54, 55, 286.
- Peltier effect, 74.

- PENCE, F. K.: *Pyrometry in the Manufacture of Clay Wares*, 513.
- Planck, 69, 285.
- Planck's constant, 53, 73.
- Platinum, melting point, 56.
- Platinum-platinum-rhodium thermocouples: 167, 191, 254, 257, 262.
- Polarization, disappearing-filament pyrometer, 319.
- Porcelain for Pyrometric Purposes* (RIDDLE), 240.
- Porcelain protecting tubes: manufacture of, 244.  
Marquardt; 241, 255.  
primary, 251.  
secondary, 252.
- Porous-plug experiment, 41, 44.
- Portable potentiometer, 88, 142.
- Portable test sets, 82.
- PORTER, H. F.: *Self-checking Galvanometer Pyrometer*, 149; *Discussion*, 153.
- Position rotating sector, 319.
- Potentiometer: deflection, 90, 91, 144, 148, 301.  
double, 145.  
portable, 88, 142.  
precision, 142.  
split circuit, 403.  
standard cells, methods to avoid, 140.  
recording, 404.  
thermocouple work, 137.  
White, 144.  
Wulf, 144.
- Potentiometers for Thermolement Work* (White), 137; *Discussion*: (HARRISON), 147;  
(ADAMS), 147; (FORSYTHE), 148.
- Present Status of Radiation Constants* (COBLENTZ), 72.
- Pressure, gas, 64.
- Protecting tubes: alundum, 256.  
carborundum, 241, 253, 262.  
for thermocouples, 124, 192, 258.  
Japan, 256.  
nichrome, 358.  
pyrometer, 255, 262.  
quartz, 251, 258.  
qualities of, 258.  
rate of heating, 271.  
Silfrax, 256.  
Usalite, 256.  
Worcester, 256.
- Protecting Tubes for Thermocouples* (LINCOLN), 258.
- Pseudo-emissive powers, 397.
- PURDY, R. C.: *Discussions: on Application of Pyrometry to the Ceramic Industries*,  
520;  
*on Melting Point of Refractory Materials*, 282.
- Pyod thermocouple, 78.
- Pyrometer (see also optical pyrometer, radiation pyrometer):  
basis of calibration, 325.  
Committee on, 3, 5.  
disappearing-filament type, 291, 319, 324, 352.  
expansion, 189.



**Pyrometer (continued), Fery: 374.**

- optical, 326.
- radiation, 345.
- filaments: 302.
  - constancy of, 303.
  - diffraction around, 306.
  - test of diffraction around, 318.
  - time of heating, 303.
  - tungsten vs. carbon, 303.
- Foote & Fisher, 331.
- Foster, 344.
- galvanometer, 149.
- improvements, recent, 188.
- in various industries: see pyrometers.
- LeChatelier, 292.
- precautions, working, 292.
- protecting tubes, 255, 262.
- recording, 406.
- samples for standardization of, 62.
- Scimatco, 330
- signaling, 200.
- Wanner, 328.

*Pyrometer Porcelains and Refractories* (NEWCOMB), 251; *Discussion:* (ASHMAN), 253; (HUBBARD), 254.

*Pyrometer Protection Tubes* (HARVEY), 255; *Discussion:* (RIDDLE), 257; (AUTHOR), 257; (FORSYTHE), 257; (SOSMAN), 257.

*Pyrometer Protection Tubes* (HUTCHINS), 262.

*Pyrometer Shortcomings in Glass-house Practice* (CLARK and SPENCER), 509.

Pyrometers in various industries: bottle-glass manufacturing, 482.

- optical, 487.
- radiation, 487.
- thermoelectric, 485.
- blast-furnace work, 544.
- ceramic industry, 516, 535.
- clay ware manufacturing, 513.
- glass manufacturing, 130, 358, 475, 491, 495, 506.
  - results of introduction, 501.
  - shortcomings of pyrometer, 509.
  - thermocouples, 491.
- Portland cement kilns, 522.
  - clinkering zone, 523.
  - errors in, 522.
  - methods, 524.
  - temperature in kilns and stacks, 531.
- steel industry, 555, 567, 578.
  - arbitrary standard, 569.
  - calibration and checking, 575.
  - forging temperature, 570.
  - heat treatment, 358, 571.
  - tapping, 579.
  - thermocouples, 568, 571.
- tool manufacture, 606.

- Pyrometry and Steel Manufacture* (MILLER), 567; *Discussion:* (BROWN), 576; (BRISTOL), 577.
- Pyrometry Applied to Bottle-glass Manufacture* (FRINK), 483.
- Pyrometry as Applied to Manufacture of Optical Glass* (KEUFFEL), 506.
- Pyrometry in Blast-furnace Work* (ROYSTER and JOSEPH), 544; *Discussion:* (FEILD), 558; (LINVILLE), 560, 562; (AUTHORS), 562, 563.
- Pyrometry in the Manufacture of Clay Wares* (PENCE), 513.
- Pyrometry in the Manufacture of Optical Glass* (WALCOTT), 491.
- Pyrometry in Rotary Portland Cement Kilns* (DANA and FAIRCHILD), 522.
- Pyrometry in the Tool-manufacturing Industry* (EMMONS), 610.
- Pyrovoltmeter, 89, 140, 149.
- Quartz, 259.  
    with platinum thermometer, 251, 254.
- Quartz protecting tubes, 251.
- Radiation constants:  $c_1$ , 52, 53, 73, 286.  
    present status of, 72.  
    total radiation, 72.
- Radiant flux, 287.
- Radiation engine, 68.  
    pressure, 67.
- Radiation pyrometer, 324, 374.  
    advantage and disadvantage of, 348.  
    calibration of, 324.  
    errors, 347, 377.  
    Fery, 345.  
    Foster, 344.  
    Thwing, 342.
- Radiation selective, 393.
- Radiation temperature, 43, 289, 374, 379.  
    corrections to, 349.
- Range control board, 95.
- Rare-metal thermocouples, 675.
- Recent Improvements in Pyrometry* (BROWN), 188; *Discussion:* (TILLYER), 203; (ASHMAN), 204; (BRISTOL), 205; (NORTHROP), 205; (ZELENY), 205.
- Recording potentiometers, 404.
- Recording Pyrometry* (FAIRCHILD and FOOTE), 406; *Discussion:* (NEWCOMB), 433.
- Recording thermoelectric pyrometers, 199.
- Recording Thermocouple Pyrometers* (BEHR), 400; *Discussion:* (NEWCOMB), 405.
- Recording thermometers, 233.
- Red glass, Corning, 296.
- Reference Standard for Base-metal Thermocouples* (BONN), 179.
- Refractory tube in steel bath, 6.
- Refractory materials: factors affecting, 269.  
    meaning of melting point, 267, 282.  
    melting points, 267.
- Report of Pyrometer Committee of National Research Council* (BURGESS), 3; *Discussion:* (SCOTT), 34; (FEILD), 36; (BURGESS), 36.
- Reports of subcommittees: pyrometer in open-hearth furnace: First report, 13.  
    second report, 20.  
    third report, 23.  
    on crucible steel, 32.

- Resistance base-metal thermocouples, 108.  
Resistance of indicating instruments, 79.  
Resistance thermometers, 190, 450, 458.  
    accuracy, 459.  
    construction of spirals, 452.  
    industrial uses, 458.  
    limitations, 452.  
    material, 460.  
*Resistance Thermometry* (ROBINSON), 450.  
*Resistance Thermometry for Industrial Use* (FREY), 458; *Discussion:* (ROUSH), 462.  
Resistance to oxidation of thermocouples, 160.  
RIDDLE, F. H.: *Porcelain for Pyrometric Purposes*, 240.  
    *Discussion on Pyrometer Protection Tubes*, 257.  
ROBERTS, H. S. and WILLIAMSON, E. D.: *Thermocouple Installation in Annealing Kilns for Optical Glass*, 466.  
ROBINSON, F. W.: *Resistance Thermometry*, 450.  
ROUSH, G. A.: *Discussion on Resistance Thermometry for Industrial Use*, 462.  
Royal Worcester tubes, 256.  
ROYSTER, P. H.; *Discussion on Pyrometry in Blast-furnace Work*, 562.  
ROYSTER, P. H. and JOSEPH, T. L.: *Pyrometry in Blast-furnace Work*, 544; *Discussion*, 563.  
  
Scimatco pyrometer, 330.  
SCOTT, H.: *Discussion on Report of Pyrometer Committee*, 34.  
SCOTT, H. and FREEMAN, J. R., JR.: *Use of Modified Rosenhain Furnace for Thermal Analysis*, 214.  
Second law of thermodynamics, 64.  
Sector for pyrometry, 303, 313.  
Sector, position of, 319.  
Seebeck effect, 74  
*Self-checking Galvanometer Pyrometer* (PORTER), 149; *Discussion:* (FOOTE and HARRISON), 151; (AUTHOR), 153.  
Seger cones, 517.  
Semi-potentiometer method, 88.  
SHACKELFORD, B. E.: *Temperatures of Incandescent-lamp Filaments*, 627.  
Shore pyroscope, 327.  
Shrinkage: carbon steel, 602.  
    manganese steel, 604.  
    nickel chromium steel, 595.  
    steel, 592.  
Signaling pyrometer, 200.  
Silfrax tubes and sheaths, 256.  
Sillimanite tubes, 243.  
SLIGH, T. S., JR.: *Discussion on Temperature of a Burning Cigar*, 651.  
SLIGH, T. S., JR. and KRAYBILL, H. R.; *Temperature of a Burning Cigar*, 645.  
Slit-width corrections, 56.  
Solar radiation temperature, 379.  
*Some Factors Affecting Usefulness of Base-metal Thermocouples* (KOWALKE), 154;  
    *Discussion:* (HARRISON), 164.  
*Some Thermal Relations in the Treatment of Steel* (BRUSH), 590.  
SOSMAN, R. B.: *Discussion on Pyrometer Protection Tubes*, 257.  
Spectral emissive powers, 372, 381.  
Spectral transmission absorbing screens, 313.

- SPENCER, C. D. and CLARK, W. M.: *Pyrometer Shortcomings in Glass-house Practice*, 509.
- Standard cells, devices to avoid, 140.
- Standard fixed points, 51.
- Standard lamp, calibration of, 302.
- Standard Scale of Temperature* (WAIDNER, MUELLER and FOOTE), 46; *Discussion:* (GUILLAUME), 58; (ADAMS), 59; (HYDE), 60; (FOOTE), 60.
- Steel, thermal relation in treatment, 590.
- Steel manufacture: heat generated after tempering, 590.  
    heat treatment, 358.  
    pyrometer in, 355, 567, 578.
- Stefan-Boltzmann Law, 43, 72, 285, 325, 450, 496.
- Sulfur boiling point, 49, 58.
- Symbols, temperature, 289.
- Symposia, previous, 5.
- Tables and Curves for Use in Measuring Temperatures with Thermocouples* (ADAMS), 165.
- Tapalog, 422.
- TAYLOR, T. S.: *A Hot-wire Anemometer with Thermocouple*, 221.
- TAYLORSON, E. S.: *Discussions: on Thermoelectric Pyrometry*, 133.  
    *on Electric, Open-hearth and Bessemer Steel Temperatures*, 589.
- Teaching pyrometry: reference material, text-book, 671.
- Teaching Pyrometry* (KOWALKE), 681.
- Teaching Pyrometry in Technical Schools* (MENDENHALL), 678.
- Teaching Pyrometry in Our Technical Schools* (WENDELL), 669.
- Teeming temperature, 34, 356.
- Temperature* (AMES), 37.
- Temperature: absolute, 40.  
    annealing, range, 476.  
    apparent, 337.  
    apparent, corrections to true, 337, 339.  
    brightness, 288, 304.  
    color, 288, 304.  
    concept of, 37.  
    condition for discussion, 38.  
    control pyrometers, 201.  
    forging, 353, 570, 614, 623.  
    high-temperature scale, 285.  
    hydrogen scale of, 41, 46.  
    international scale of, 45.  
    Kelvin's scale, 41, 63, 288.  
    measurement of high, 368.  
    radiation, 43, 243, 289.  
    rolling, 570.  
    scales in intervals:  $-40^{\circ}\text{C}$  to  $450^{\circ}\text{C}$ , 48.  
         $450^{\circ}\text{C}$  to  $1100^{\circ}\text{C}$ , 50.  
        above  $1100^{\circ}\text{C}$ , 51.  
    teeming, 34, 356.  
    theory of, 44.  
    true temperature, 304, 337, 385.  
    true temperature, black-body relation, 287.  
    true, brightness, color temperature relation, 289.  
    two bodies at same, 37.

- Temperature and: manganese constant, 555.
  - silicon constant, 546.
  - sulfur constant, 546.
- Temperature of: basic electric furnace, 24, 30.
  - burning cigar, 645.
  - cement, 365.
  - cold end of thermocouple, 184.
  - electric furnace, 578.
  - glass pot, 448, 502, 507.
  - incandescent lamp filament, 627, 638.
  - incandescent gas mantle, 632.
  - manganese steel, 588.
  - nickel ordinance steel, 580.
  - non-black bodies, 304.
  - single molecule, 45.
  - slag pot, 265.
  - steel in open-hearth furnace, 6, 17, 19, 20.
    - method of measuring, 7.
    - Drinker's method, 7, 9.
  - various metals, 364.
- Temperature of a Burning Cigar (SLIGH and KRAYBILL), 645; Discussion: (WHITE), 650; (SLIGH), 651.*
- Temperature Measurements of Incandescent Gas Mantles (IVES), 632.*
- Temperature recorders, 405.
  - Beighlee, 413.
  - Brown, 414.
  - Hoskins, 417.
  - industrial types, 412.
  - Leeds and Northrup, 428.
  - record chart, 408.
  - roll chart, 415.
  - thread, 418.
  - Thwing, 422.
  - Wilson-Maehlen, 423.
- Temperatures of Incandescent-lamp Filaments (SHACKELFORD), 627.*
- Test of pyrometer: different laboratories, 311.
  - experienced observers, 310.
  - inexperienced observers, 309.
- Theory and Accuracy in Optical Pyrometry with Particular Reference to the Disappearing-filament Type (FORSYTHE), 291; Discussion: (FAIRCHILD), 322; (AUTHOR), 323.*
- Thermal equilibrium, 38.
- Thermocouple Installation in Annealing Kilns for Optical Glass (WILLIAMSON and ROBERTS), 466.*
- Thermocouple pyrometers, 400.
- Thermocouples: alloys for, 181.
  - annealing of, 472.
  - base-metal, 78, 181, 183, 191.
  - calibration, 76, 147, 164, 617, 675.
    - tables, 168, 170.
  - calorized iron constant in, 163.
  - care of, 187.
  - choice of wire, 466.

- Thermocouples (continued): constancy, 156.**  
contamination of, 76.  
copper-constantan, 168.  
depth of immersion, 123.  
desirable properties, 74.  
deviation curves, 173.  
fixed junction correction, 174.  
formula for, 51.  
homogeneity of, 156.  
Hoskins couple, 171.  
installations, 112.  
    cold-junction burying, 113, 194, 204.  
    common return, 113.  
    commutating switches, 119.  
    contact resistance, 112.  
    for annealing kilns, 466.  
    indicator, location of, 113.  
    junction box and zone box, 119.  
    primary protection, 251.  
    secondary protection, 251.  
    Wilson-Maeulen zone box, 122.  
    wiring diagram, 114.  
insulation of, 159, 194.  
irreproducibility of couples, correction for: 104.  
    by series resistance, 105.  
    by shunt resistance, 108.  
    by shunt and series resistance, 109.  
life of platinum thermocouples, 255, 257, 262.  
platinum-platinum-rhodium, 167, 191.  
protection of, 77, 113, 255, 259, 263, 361.  
resistance to oxidation, 160, 167, 191.  
resistance of indicating instruments, 79.  
reproducibility of couples, 111.  
tables for calibration, 168, 170.
- Thermodynamic scale, 63.**  
*Thermoelectric Pyrometry* (FOOTE, HARRISON and FAIRCHILD), 74; *Discussion:*  
    (THWING), 128; (ASHMAN), 128; (WILSON), 129; (LITTLETON), 130;  
    (TAYLORSON), 133; (AUTHORS), 134; (WHITE), 135; (HARRISON), 136.
- Thermometers, 39.**  
fixed points, 50, 51, 167.  
gas, 189.  
high-temperature mercurial, 225.  
liquids in, 234.  
pressure, 234.  
    accuracy of, 236.  
    principle of, 235.  
quartz with platinum, 251, 254.  
recording, 233.  
resistance, 190, 250, 258, 489.  
    accuracy of, 459.  
    materials, 460.
- Thermoelectric power, 167.**

- Thermoelectric pyrometer, 74, 181, 190.  
    Brown heatmeter, 90.  
    deflection potentiometer, 90.  
    galvanometer, 79.  
    Harrison-Foote, 84.  
    potentiometer, 88.  
    pyrovolter, 89.  
    recording, 199.  
    semi-potentiometer, 88.
- Thermogage, 613.
- Thermos bottle for cold junction, 185, 205.
- Theory of optical pyrometer, 291.
- Thomson effect, 74.
- THWING, C. B.: *Application of Pyrometry to the Ceramic Industries*, 516.  
    *Discussion on Thermoelectric Pyrometry*, 128.
- Thwing radiation pyrometer, 342.
- TILLYER, E. D.: *Discussion on Recent Improvements in Pyrometry*, 203.
- Tin: *An Ideal Pyrometric Substance* (NORTHRUP), 464; *Discussion: (FOOTE)*, 465.
- TOOL, A. Q. and VALASEK, J.: *Annealing of Glass*, 475.
- Tool manufacture, pyrometer in, 606.
- Total emissive power, 371, 373
- Total radiation constant, 72.
- Transformation point recorders, 430.
- Transformation temperature of glasses, 478.
- Transmission absorbing screens: Corning red glass, 296.  
    constancy of, 296.  
    change in, 299.  
    spectral, 313.  
    total, 314.  
    effect temperature change, 316.
- Tungsten: emissivity of, 390.  
    melting point of, 57, 392.  
    vs. carbon pyrometer filament, 303.
- UNGER, J. S.: *Discussion on Melting Point of Refractory Materials*, 282.
- Unipivotal instruments, 79.
- Usalite tubes, 256.
- Use of Modified Rosenhain Furnace for Thermal Analysis* (SCOTT and FREEMAN), 214.
- Use of Optical Pyrometers for Control of Optical-glass Furnaces* (FENNER,) 495; *Discussion: (AUTHOR)*, 505.
- VALASEK, J. and TOOL, A. Q.: *Annealing of Glass*, 475.
- Value of:  $c_2$ , 52, 53, 73, 286.  
    "e", 73.
- VAN HORN, I. H.: *Application of Pyrometry to Problems of Lamp Design and Performance*, 628.
- W Aidner, C. W. and BURGESS, G. K.: *Metals for Pyrometer Standardization*, 61.
- Waidner, C. W., Mueller, E. F. and Foote, P. D.: *Standard Scale of Temperature*, 46.
- WALCOTT, A. J.: *Pyrometry in the Manufacture of Optical Glass*, 491.
- Wanner pyrometer, 328.
- Wave-length, effective, 54, 297, 304, 389.

- Wedge method for black body, 385.  
Wedgewood pyrometer, 517.  
WENDELL, G. V.: *Teaching Pyrometry in Our Technical Schools*, 669.  
Wheatstone bridge-cold junction compensation, 103.  
WHITE, W. P.: *Potentiometers for Thermolement Work*, 137.  
    *Discussions: on Thermoelectric Pyrometry*, 135.  
    *on Temperature of a Burning Cigar*, 650.  
Wien's law: 44, 68.  
    accuracy of, 293.  
WILHELM, R. M.: *High-temperature Thermometers*, 225; *Discussion*, 239.  
WILLIAMSON, E. D.: *Discussion on Annealing of Glass*, 482.  
WILLIAMSON, E. D. and ROBERTS, H. S.: *Thermocouple Installation in Annealing Kilns for Optical Glass*, 466.  
WILSON, C. H.: *Discussion on Thermoelectric Pyrometry*, 129.  
Window, transmission corrections for, 340.  
WORTHING, A. G.: *Emissive Powers and Temperatures of Non-black Bodies*, 367.  
    *Discussions: on Optical and Radiation Pyrometry*, 350;  
    *on Application of Pyrometry to Problems of Lamp Design and Performance*, 644.  
WUNSCH, F.: *Automatic Compensation for Cold-junction Temperatures of Thermocouple Pyrometers*, 206.  
  
ZELENY, A.: *Discussion on Recent Improvements in Pyrometry*, 205.  
Zero, absolute, 40, 66.  
Zirconium oxide tubes, 250.



# THE BROWN INSTRUMENT CO.

PHILADELPHIA, PA.

NEW YORK      PITTSBURGH      DETROIT      CHICAGO      ST. LOUIS  
DENVER      SAN FRANCISCO      LOS ANGELES      MONTREAL

Manufacturers of Pyrometers, Thermometers, Tachometers, Recording Gauges, Time and Operation Recorders and Other Scientific Instruments

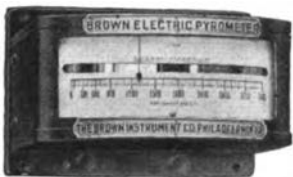

The Brown High Resistance Indicating Pyrometer

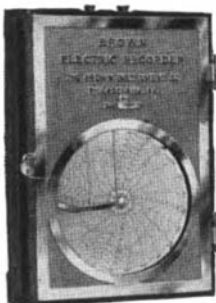

Circular Chart, Brown Recording Pyrometer

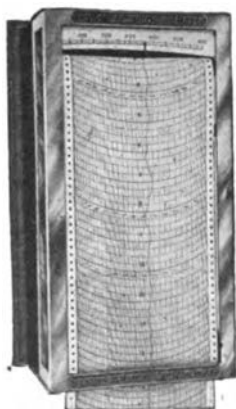

The Brown Single Record Continuous Recording Pyrometer

## BROWN PYROMETERS

The Brown Thermo-Electric Pyrometer is designed for Indicating or Recording temperatures from 300°F. to 3000°F., or equivalent Centigrade. It consists of a millivoltmeter, with scale graduated in Fahrenheit or Centigrade degrees and a Thermo-Couple, suitably protected, inserted in the heat and wired to the instrument. The Thermo-Couple formed of two units of different alloys, joined at the end and inserted in the heat, generates a small current of electricity dependent on the heat, and this is indicated or recorded by the instrument.

For temperatures below 300°F., Brown Resistance Thermometers are recommended. For temperatures above 3000°F. the Brown Radiation Pyrometer is extensively used.

## [BROWN RECORDING PYROMETERS

Make a permanent record of temperatures. Positive in action, sturdy in construction, accurate and with clear readings. The circular type gives a 24-hour record. The continuous types give an unbroken record over a period of approximately two months, and make from 1 to 10 records on one chart.

Brown Pyrometers are also made to regulate or control automatically the temperatures of electric, gas or oil furnaces.



The Brown Precision Portable Potentiometer



The Brown Portable Pyrometer

### BROWN LONG DISTANCE INDICATING AND RECORDING THERMOMETERS

Brown Recording Thermometers have a bulb of copper, usually about 10 inches long, connected by a capillary tube to a helical expansive tube in a recording gauge. The bulb is filled with nitrogen gas under pressure for high ranges to 1000°F. and with alcohol for ranges below 200°F. In accordance with the law of expansion of gases, the gas expands at a uniform ratio with increase in temperatures. This means an evenly divided scale throughout the range of the instrument.

Brown Long Distance Recording Thermometers may have tubing as long as 100 feet if required. This tubing is protected by a flexible bronze armored tubing which can be stepped on without injury and serves as a perfect protection to the inside tube.

Bulbs are supplied to meet every requirement. Also made in continuous recording type.



The Brown Dial Indicating Thermometer



The Brown Long Distance Recording Thermometer

### BROWN RECORDING PRESSURE GAUGES

For recording all ranges of vacuum and pressure from a few ounces of water to 5000 pounds, Brown Recording Pressure Gauges are guaranteed completely as to dependability and accuracy.

Also made in a recording type.

### BROWN TIME AND OPERATION RECORDERS

Extensively used for recording the time of operation of machinery, switches, valves, pumps, and for recording the reversals of glass melting tanks, open hearth furnaces and annealing furnaces, also for recording the time of starting and stopping of paper machines and other devices.

### BROWN TACHOMETERS

Indicating and Recording types for measuring and counting revolutions per minute. The Electric type records machine operations hundreds of feet away. The Mercurial types operate by the unvarying law of centrifugal force.

### OTHER SCIENTIFIC INSTRUMENTS

Resistance Thermometers, Thermometers of the Mercurial type, Draft and Vacuum Gauges are among the other scientific instruments produced in the Brown Laboratory, Wayne Junction, Philadelphia, where visitors are always most welcome.



The Brown Recording Pressure Gauge



The Brown 2" Draft Gauge



Brown Electric Tachometer



The Brown Mercurial Tachometer



The Brown Time and Operation Recorder

# ENGELHARD

The Original

## Ze| Chatelier Pyrometers

### WHY ENGELHARD PYROMETERS Excel in Service:

For twenty-five years we have specialized in Rare Metal Pyrometer equipment. Engelhard Pyrometers have, during all of that time, lead all others in accuracy, constancy, practicability and general dependability. This superiority is due to the great care taken in refining, alloying and manufacturing Engelhard Thermo-elements, the ample factor of safety allowed in the size and length of the Thermo-element wires, the grade and types of protecting tubes used, the accuracy and unusual durability of our indicators and recorders.

We have developed our Imper-vite Pyrometer Tubes to a point where it can be safely said, they have no equal.

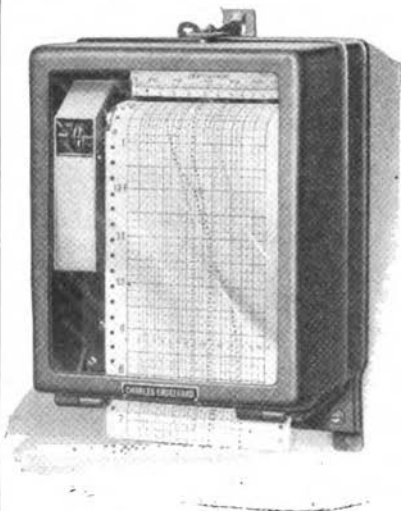

Our New Model Indicators and Recorders represent a great stride forward in the art of instrumentation manufacture, through the elimination of all wear and friction, combined at the same time with greater mechanical strength and stability.

Because we are not dependent on outside sources for any of these, we are in position to supply promptly, and at the lowest possible price, consistent with high quality, Pyrometer equipment designed and constructed for your own individual conditions, thus assuring greatest service and practicability.

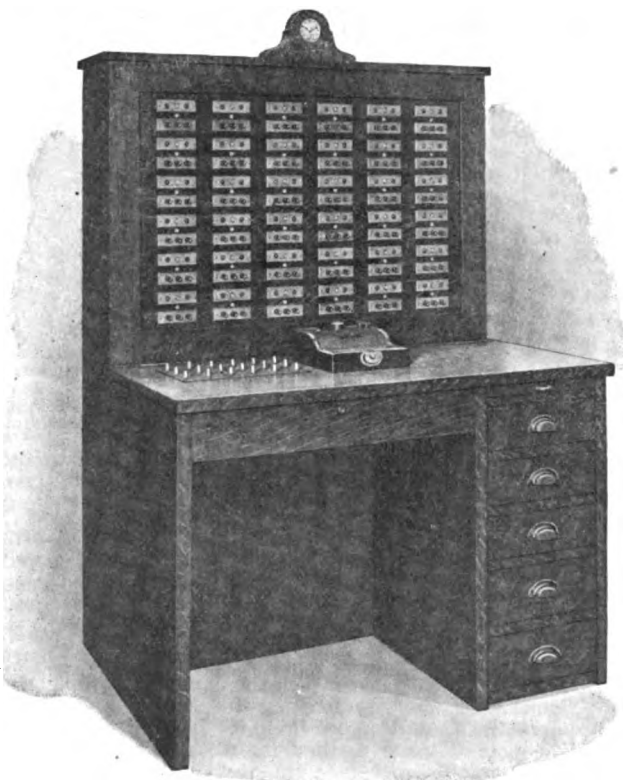

We guarantee interchangeability and calibration of Englehard Pyrometers within  $\frac{1}{4}$  of 1%. As to the service they give, let us refer you to some of those who have used them for upwards of ten years.

The exceptional service given by Englehard Pyrometers, is not alone due to a superiority of the parts entering into them, but in the selection of those parts that will best meet the needs of the user. A Pyrometer installation, be it for one furnace or for many, should be made exactly suitable for the particular conditions under which it is to be used. A Protecting Tube that would be the best for a Cyanide Bath, would not be best for a galvanizing pot; nor would one that should be used in a Brick Kiln be suitable for a High Speed Steel Furnace. We offer the services of our engineers in making the proper selection, in specifying the right instruments, and in designing and laying out complete installations.

Our facilities for supplying complete Pyrometer installations suitable for the individual needs of the user, the individual attention given each problem, as well as the constant service we give to those who install our equipment, taken into consideration with the superiority of Englehard Pyrometers, should influence those who might otherwise be attracted by a lower price, to equip their plant with instruments in which confidence can be placed.

## **CHARLES ENGELHARD**

**30 Church St.**

**Hudson Terminal Building**

**NEW YORK**

## LEEDS & NORTHRUP PYROMETERS

THE POTENTIOMETER SYSTEM OF PYROMETRY uses a balance method, no current flowing through the thermocouple or leads at the moment of measurement, thus eliminating effects of length and leads, thermocouple resistance and galvanometer resistance.

THIS permits the use of base metal thermocouples and of leads of the same materials as the thermocouples, thus bringing the cold junction back to the potentiometer, where its effects are compensated for automatically.

POTENTIOMETER INDICATORS are balanced by hand and Potentiometer Recorders are balanced automatically by external power, the galvanometer acting merely as a current detector. The recorder may be of the single-point curve-drawing type or of the multiple-point printing type for any number of thermocouples up to 16.

THE CURVE-DRAWING RECORDER is frequently used to control signal lamps and an indicator at the furnace, showing when and by how many degrees the temperature has departed from the desired temperature. This instrument is also arranged to regulate the temperature automatically by controlling valves, rheostats, etc.

THE LEEDS & NORTHRUP TRANSFORMATION POINT APPARATUS determines the correct temperatures for working, hardening, quenching, annealing, etc., by locating the transformation or critical point. A differential thermocouple is used for detecting the transformation point, and the potentiometer method for measuring the temperature at which the transformation occurs. The instrument produces a diagram upon which the points are indicated in a pronounced and unmistakable manner.

TEMPERATURES of incandescent or glowing bodies are read with great accuracy by inexperienced operators using the LEEDS & NORTHRUP OPTICAL PYROMETER. The hot body is viewed through a small telescope in which the filament of a small tungsten lamp is seen against a background formed by the hot object. The current through the lamp is regulated until the filament merges with this background, and the temperature is then determined directly from the reading of a millimeter. A large surface to sight upon is not required and distance from the hot object does not matter. The ability to match colors, and color blindness have no effect upon the reading, and different observers agree within 3°C.

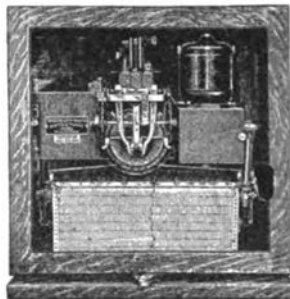

Curve Drawing  
Potentiometer Pyrometer

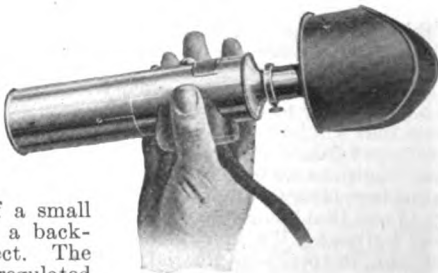

Optical Pyrometer

### THE LEEDS & NORTHRUP COMPANY

Makers of Electric Measuring Instruments, including Indicating and Recording Thermocouple and Resistance Pyrometers, Condensers, Galvanometers, Wheatstone Bridges, Testing Sets, etc.

4920 STENTON AVENUE

PHILADELPHIA, PENN.

## MONOPIVOT Pyrometer Indicator

Scale 7" long

Calibrated for base or rare metal couples or double range for use with both. The monopivot construction permits very high resistance windings without any sacrifice of robustness, giving sensitivity without delicacy.

The fume-proof, dust-proof switch is a modern essential.



## WILSON-MAEULEN COMPANY

381 Concord Ave., New York

Makers of Pyrometers—Specializing on High Grade,  
Precision Apparatus only,

Complete Catalog will be sent on request.

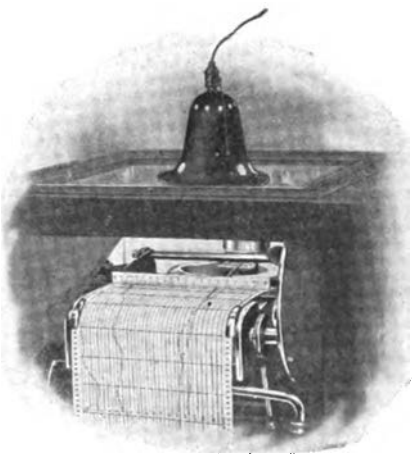

## The TAPALOG

A very high resistance Pyrometer Recorder, with automatic commutator, taking up to six records in six colors on one record sheet. Usable with base or rare metal thermocouples.











