



## Symposium on Atherosclerosis (1954)

Pages  
259

Size  
6 x 9

ISBN  
0309340195

Division of Medical Sciences; National Research Council

 [Find Similar Titles](#)

 [More Information](#)

### Visit the National Academies Press online and register for...

- ✓ Instant access to free PDF downloads of titles from the
  - NATIONAL ACADEMY OF SCIENCES
  - NATIONAL ACADEMY OF ENGINEERING
  - INSTITUTE OF MEDICINE
  - NATIONAL RESEARCH COUNCIL
- ✓ 10% off print titles
- ✓ Custom notification of new releases in your field of interest
- ✓ Special offers and discounts

Distribution, posting, or copying of this PDF is strictly prohibited without written permission of the National Academies Press. Unless otherwise indicated, all materials in this PDF are copyrighted by the National Academy of Sciences.

To request permission to reprint or otherwise distribute portions of this publication contact our Customer Service Department at 800-624-6242.

Copyright © National Academy of Sciences. All rights reserved.

**SYMPOSIUM**  
**ON ATHEROSCLEROSIS**

*held under the auspices of*  
**The Division of Medical Sciences**  
**National Academy of Sciences—National Research Council**

*at the request of*  
**The Human Factors Division**  
**Air Force Directorate of Research and Development**

**22-23 March 1954**

**Publication 338**  
**NATIONAL ACADEMY OF SCIENCES—NATIONAL RESEARCH COUNCIL**  
**2101 Constitution Avenue**  
**Washington 25, D. C.**

**1954**

*Price—\$2.00*

1263  
N.S.  
1154

## SYMPOSIUM ON ATHEROSCLEROSIS

### PARTICIPANTS

DR. IRVINE H. PAGE, *Chairman*  
The Cleveland Clinic  
Cleveland, Ohio

DR. JOSEPH T. ANDERSON  
University of Minnesota  
School of Public Health

DR. ANCEL KEYS\*  
University of Minnesota  
School of Public Health

DR. CHRISTIAN B. ANFINSEN, JR.  
National Institutes of Health  
Bethesda, Maryland

DR. ALBERT I. LANSING  
Washington University  
School of Medicine

LT. WILLIAM H. BATCHELOR, (MC) USNR  
Naval Medical Research Institute  
Bethesda, Maryland

DR. ALBERT L. LEHNINGER  
Johns Hopkins University  
School of Medicine

DR. MICHAEL E. DEBAKEY  
Baylor University  
College of Medicine

DR. GEORGE V. MANN  
Harvard University  
School of Public Health

DR. G. LYMAN DUFF  
McGill University

DR. GEORGES M. C. MASSON  
The Cleveland Clinic  
Cleveland, Ohio

DR. HOWARD A. EDER  
National Institutes of Health  
Bethesda, Maryland

DR. JAMES C. PATERSON  
University of Western Ontario  
Faculty of Medicine

DR. BENTLEY GLASS  
Johns Hopkins University

DR. RUTH PICK  
Michael Reese Hospital  
Chicago, Illinois

DR. R. GORDON GOULD  
Los Alamos Scientific Laboratory  
Los Alamos, New Mexico

DR. FRANCIS O. SCHMITT  
Massachusetts Institute of Technology

DR. JEROME GROSS  
Massachusetts General Hospital  
Boston, Massachusetts;  
Massachusetts Institute of Technology

DR. FREDERICK J. STARE  
Harvard University  
School of Public Health

DR. GEORGE M. HASS\*  
Presbyterian Hospital  
Chicago, Illinois

DR. DOUGLAS M. SURGENOR  
Harvard Medical School

DR. LOUIS N. KATZ  
Michael Reese Hospital  
Chicago, Illinois

DR. C. BRUCE TAYLOR  
Presbyterian Hospital  
Chicago, Illinois

DR. AARON KELLNER  
New York Hospital  
New York, New York

DR. LEVIN L. WATERS  
Yale University  
School of Medicine

DR. M. C. WINTERITZ  
Washington, D. C.

---

\* Papers presented *in absentia*.

**SUBCOMMITTEE ON THE CARDIOVASCULAR SYSTEM**

**DR. FIORINDO A. SIMEONE**

City Hospital  
Cleveland, Ohio

**U. S. ARMY**

**DR. DONALD E. GREGG**

Army Medical Service Graduate School  
Washington, D. C.

**LT. COL. TYRON E. HUBER, (MC) USA**

Research and Development Division  
Office of the Surgeon General

**U. S. NAVY**

**DR. DIETRICH BEISCHER**

School of Aviation Medicine  
Pensacola, Florida

**LT. (J.G.) D. R. KOTH, (MC) USNR**

Naval Medical Research Institute  
Bethesda, Maryland

**CAPT. E. H. DICKINSON, (MC) USN**

Professional Division  
Bureau of Medicine and Surgery

**DR. GILLES MARCEAU**

Naval Medical Research Institute  
Bethesda, Maryland

**DR. HOWARD T. KARSNER**

Medical Research Advisor  
to the Surgeon General

**LT. W. H. SEWELL, (MC) USNR**

Naval Medical Research Institute  
Bethesda, Maryland

**LT. ROBERT G. KINDRED, (MC) USNR**

National Naval Medical Center  
Bethesda, Maryland

**CAPT. J. H. WARD, JR., (MC) USN**

Professional Division  
Bureau of Medicine and Surgery

**CAPT. O. D. YARBROUGH, (MC) USN**

Research Division  
Bureau of Medicine and Surgery

**U. S. AIR FORCE**

**COL. A. P. GAGGE, USAF (MC)**

Human Factors Division  
Directorate of Research and Development

**MAJ. W. C. MARETT, JR., USAF (MC)**

Aviation Medicine Division  
Office of the Surgeon General

**COL. WILLIAM R. HAAS, USAF (MC)**

Consultant in Internal Medicine  
Office of the Surgeon General

**LT. COL. L. J. MILCH, USAF (MC)**

School of Aviation Medicine  
Randolph AFB, Texas

**MAJ. LEWIS E. JONES, USAF (MC)**

Aviation Medicine Division  
Office of the Surgeon General

**LT. COL. JACK C. SHRADER, USAF (MC)**

School of Aviation Medicine  
Randolph AFB, Texas

**DR. ALFRED H. LAWTON**

Medical Research Advisor  
Directorate of Research and Development

**DR. PAUL K. SMITH**

Pharmacologist Consultant  
Directorate of Research and Development

**LT. COL. F. M. TOWNSEND, USAF (MC)**

Consultant in Pathology  
Office of the Surgeon General

**U. S. PUBLIC HEALTH SERVICE**

**DR. J. FRANKLIN YEAGER**  
National Institutes of Health  
Bethesda, Maryland

**VETERANS ADMINISTRATION**

**DR. THEODORE S. MOISE**  
Research and Education Service

**AMERICAN HEART ASSOCIATION**

**DR. E. COWLES ANDREUS**  
Baltimore, Maryland

**DIVISION OF MEDICAL SCIENCES, NATIONAL RESEARCH COUNCIL**

**DR. R. KEITH CANNAN**  
Chairman

**DR. PHILIP S. OWEN**  
Executive Officer

**DR. THOMAS A. BRADLEY**

**MR. HERBERT N. GARDNER**

**DR. JONATHAN O. COLE**

**DR. MARY R. OLDT**

**CAPT. ARTHUR C. FOX, USAF (MC)**

**DR. MARGARET H. SLOAN**

**DR. LEON H. WARREN**

## CONTENTS

Opening Remarks.....	1
Introduction—Irvine H. Page, Chairman.....	3

### *Part I*

Anatomical and Biochemical Aspects of Heredity in Reference to Atherosclerosis—Bentley Glass.....	7
Discussion.....	12
The Blood Supply of the Vessel Wall—M. C. Winternitz.....	14
Discussion.....	23
Observations on Vascular Structure in Relation to Human and Experimental Arteriosclerosis—George M. Hass.....	24
(Presented by C. Bruce Taylor)	
Discussion.....	31
Functional Anatomy of the Blood Vessel Wall; Adaptive Changes—G. Lyman Duff.....	33
Discussion.....	40
The Lipid and Protein Content of Tissue Fluid in Normal and Hyperlipemic Rabbits—Aaron Kellner.....	42
Discussion.....	48
Experimental Studies on Arteriosclerosis—A. I. Lansing.....	50
Discussion.....	60
Summary of Part I—Bentley Glass.....	61

### *Part II*

The Reaction of the Arterial Wall to Intramural Haemorrhage—J. C. Paterson.....	65
Discussion.....	72
The Reaction of Arteries to Injury by Physical Agents. With a Discussion of Factors Influencing Arterial Repair—C. Bruce Taylor.....	74
Discussion.....	89
The Reaction of the Artery Wall to Injury by Chemicals or Infection—Levin L. Waters.....	91
Discussion.....	97
Metabolic Factors in Vascular Disease—G. M. C. Masson.....	99
Discussion.....	102
Regeneration of the Elements of the Vessel Wall—Michael E. DeBakey, Oscar Creech, Jr., and Béla Halpert.....	103
Discussion.....	110
The Reaction of the Artery Wall to Hypertension and to Hypervolemia—Levin L. Waters.....	112
Discussion.....	119
Summary of Part II—G. Lyman Duff.....	121

# SYMPOSIUM ON ATHEROSCLEROSIS

## OPENING REMARKS

*Dr. Page*, Chairman, called the meeting to order and invited the Chairman of the Division of Medical Sciences, National Research Council, to explain the origin and objectives of the Symposium.

*Dr. Cannan* reported that the concept of this meeting had grown out of discussions with *Dr. Lawton* concerning the problem of cardiovascular disease as a factor limiting the length of service of flying personnel. The Air Force was anxious to obtain better diagnostic and predictive criteria which might be employed for purposes of selection, assignment, and retention. *Dr. Lawton*, in a letter dated 27 October 1952, had broached the idea of a conference on lipoproteins as related to atherosclerosis and aging to explore the possibilities of developing such criteria and to stimulate progress in this field. The Subcommittee on Cardiovascular Diseases, to which this proposal was referred, felt that the time was ripe for a broad survey of etiological factors. This suggestion was enthusiastically received, and during the past year three steering committee meetings and an orientation session had been held to develop the present program.

*Dr. Cannan* urged the participants to keep the pragmatic interests of the Air Force in mind as they probed the fundamental aspects of current research. He pointed out that efforts had been made to include all of the disciplines that might contribute to the problem, so that areas of neglect and new techniques of promise might be brought into the open.

*Dr. Page* thanked *Dr. Cannan*, and asked *Dr. Lawton* to speak on behalf of the Air Force.

*Dr. Lawton* pointed out that while atherosclerosis and aging were matters of vital concern to the other services and in civilian life as well, the stresses involved in flying modern combat aircraft brought them into prominence at a much earlier stage of life. For this reason the Air Force had supported a considerable amount of research on these problems, both in its own laboratories and through extramural contracts; they were anxious, however, to survey the status of current knowledge on a broader scale, both for signposts to guide their own program and for clues to any practical applications which might be in prospect.

He expressed his personal appreciation and that of the Air Force for the cooperation of the Division and of the participants in developing this Symposium.





## INTRODUCTION

IRVINE H. PAGE

The major problem of the Air Force Human Factors Division is the human capacity to respond to stress, fatigue, and aging. Hence Dr. Lawton's decision that atherosclerosis was a relevant and important topic. Aging and atherosclerosis are chronologically associated. It is now established that the association, while real, is not one of cause and effect. Nonetheless, the relationship is close enough to justify consideration of arterial disease as part of the mission of the Human Factors Division.

The interest of the Air Force was communicated to Drs. Winternitz and Cannan with the suggestion that a symposium on lipoproteins be held. Characteristically, these advisers were impelled to take a broader look at the field. Neither likes to look at sectors; both prefer to view horizons. They were aided in the organization of a symposium along broader planes of reference by Drs. Frank Schmitt, Robert Levy, James Shannon, Levin Waters, Michael DeBakey and Leon Warren.

As finally constituted, the symposium extends well beyond the lipoproteins and even considers processes other than atherogenesis. However, it is not intended to cover all the fields brought up for discussion. Rather, the aim is to stimulate the use of disciplines and techniques which may hold the final clues to the problem of atherogenesis, by those engaged in or entering on this field. Certainly, to resolve the issue will involve an unusual breadth of perspective and a high intuitiveness. As a result, the symposium plans its appeal to all serious investigators in the most diverse areas, both geographically and intellectually.

The papers to be presented, or informative abstracts thereof, have been circulated before the meeting, so that many of you will have the major participants "over the barrel" at the start. You are invited to exploit this advantage. The program is otherwise spontaneous and, to coin a phrase, unrehearsed. Drs. Anfinson, Duff, Glass, Gould, and Schmitt have been asked to pick up the pieces of each of the five sessions and string them together for your intellectual ease. So much for organization. We have aimed, perhaps at some risk, to stray from the beaten paths. Whether or not this is wisely done is for you to judge.

Most of us will agree on certain basic ideas. For example, we do not consider atherosclerosis a product of aging as such. We believe it to be a process conditioned by metabolic factors, local and systemic. Among those which involve the whole body, heredity and its metabolic concomitants, as well as diet, seem to be important. At least, data are available which indicate that the process can be familial and that excess calories have their effect. The specificity of excess lipid calories is still in question.

Local metabolic factors are of unquestioned importance. Thus, we could agree that experimental counterparts, more or less similar to human atherosclerosis, have been produced in some animals; we would also recognize that other species, or sometimes individuals in a susceptible species, are resistant to experimental atherogenesis. This disparity between species may prevail even when the broad patterns of metabolic abnormality seem to have been equally distorted. Hence the need for supposing that there must be important local metabolic factors which determine the incidence of the process.

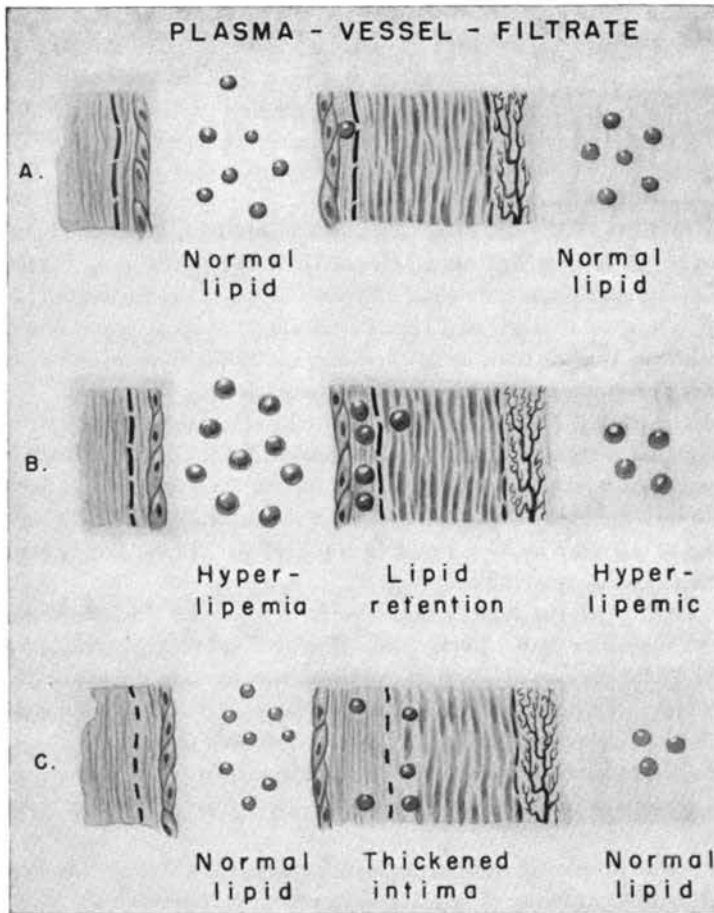

FIG. 1.—Schematic representation of filtration theory of atherogenesis. (A) Normal plasma lipids with normal arterial wall. The passage of lipoproteins through the internal elastic membrane is depicted, and their appearance in the lymph and adventitial blood. (B) Hyperlipemic plasma with greater lipid retention in normal arterial wall. (C) Normal plasma lipids passing through an arterial wall with thickened intima and fragmented internal elastic lamina.

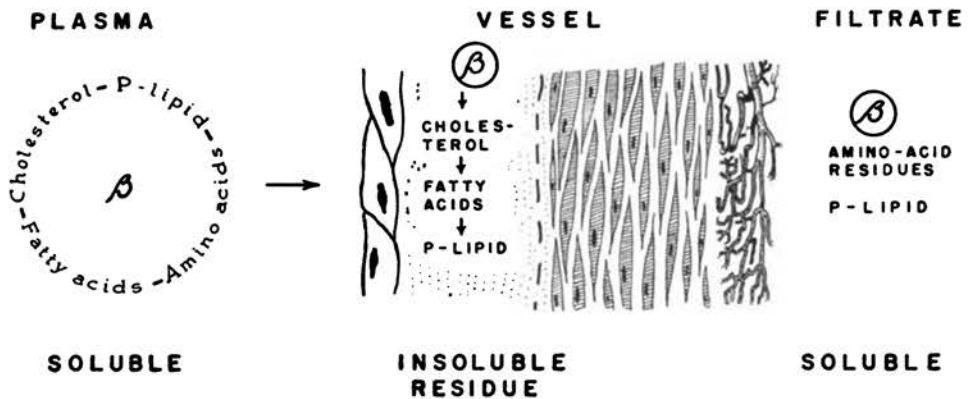

FIG. 2.—Diagram of the special role which may be attributed to the beta lipoproteins because of their relative instability as compared with alpha lipoproteins.

In addition, it is agreed that hypertension accelerates atherogenesis, presumably by its local effects. Hypervolemia and other discrete abnormalities of the circulation may participate as well.

No one of us would deny—of course, someone may—that the lipids have something to do with the case. Among these, attention has been focused on cholesterol and its esters, although the participation of neutral fats and phospholipids is still to be evaluated. In any case, the lipids are involved, although we would not have to agree that their participation is primary or that atherosclerosis is a reflection of disordered lipid metabolism. Even if we suppose that the lipoproteins are primary agents in atherogenesis, it still is possible that failure to provide the essential peptide moiety of the lipoproteins is of equal significance.

Thus, we are metabolically broadly based in perspective. Indeed, the base may be too broad and perhaps too uncertain to give a definite metabolic point of view.

Everyone is entitled to a point of view, and it is a chairman's privilege to present his first and without too much regard for the evidence. As I see it, the hypothesis I will propose has the merit of knitting together some disparate facts and of comprehending most of those presently available.

*Filtration Concept of Atherosclerosis.* The axiomatic part of the concept is that atherogenesis is due to accumulation of substances filtered by the lateral pressures from plasma through the intima. Some of these substances pass on harmlessly. Others stay behind. Depending on the nature of the substances remaining and the responsiveness of the tissues to them, a reaction may be set up.

In this view, atherogenesis depends upon the following factors:

- (1) The anatomy, biochemistry, and physiology of the vessel wall, all of which are hereditarily conditioned.
- (2) The composition of plasma filtrate.
- (3) The height of the lateral pressure and the amount filtered.
- (4) The metabolic capacity of the vessel wall.
- (5) The responsiveness of intimal tissues to filtered products and their metabolites.
- (6) Changes in the ability of the vessel wall to transport filtered substances; such might result from age, hypertensive diseases, and metabolic disorders.

I suspect that you may agree in part with this concept, if not in detail. We are now about to run out of things on which we can agree.

But we can still cheerfully subscribe to the view that this problem is a wide one. Not very many years ago hardly anyone gave it a thought, largely because aging and atherosclerosis were identified and considered equally inevitable. Just 25 years back cholesterol was an inert substance present in wool fat, good for the hair and hands and otherwise of no practical interest. And the clinicians were just as inattentive to the topic as the investigators.

You are well acquainted with the advances which have since occurred in the chemistry of the steroids and the central place of cholesterol in the scheme of things or, if not, aware that they have transpired. But it is only in the last eight years that the intellectual climate of atherogenesis has changed. The problem has only just been defined. It would be premature to suppose that we have the answer. Of such stuff dreams are made. Still, here in an atmosphere less esoteric than the analyst's couch, we invite you to tell and interpret your dreams before a larger audience.

And, as Chairman, I invite you to this task.



## PART I

---

### ANATOMICAL AND BIOCHEMICAL ASPECTS OF HEREDITY IN REFERENCE TO ATHEROSCLEROSIS

BENTLEY GLASS

If we are to apply a genetic approach to the anatomical and biochemical features associated with atherosclerosis, a field where much is yet obscure, it will be well first to consider briefly the nature of the genetic basis of a few rather better understood pathological conditions. Let us immediately exorcise the evil spirit that suggests that hereditary and environmental etiological factors cannot coexist—that if a condition is hereditary it cannot be produced, or even modified, by an infectious or dietary agent; and conversely, that if a condition is clearly due to an infectious agent or to a dietary deficiency, it cannot at the same time be conditioned by the genes. Let us instead remember the two genetic strains of rabbits that differ, when kept on a diet rich in xanthophyll, in the color of their fat, the one producing yellow, the other only white fat. For, when shifted to a diet lacking xanthophyll, both strains produce only white fat. The difference between strains seen on the full diet is hereditary; but within one of the two strains, the difference in fat color is clearly of dietary origin. Let us also recall the instance of tuberculosis, which is well known to be due to an infectious organism. Yet equally clearly Kallman and Reisner<sup>5</sup>, in their remarkable studies of twins, showed that tuberculosis mortality and morbidity vary with degree of genetic relationship. Both of these examples instruct us that the genes, acting as they must within a certain developmental and environmental framework, rarely produce absolute effects, but instead determine an individual's capacities, the nature of his reaction under specified conditions.

A second most important principle to fix in mind is the very common ramification of the effects of a single genetic change. Often the effects are so apparently unrelated as to have no conceivable connection with one another. Yet, if a single gene can be shown to produce these several effects, they must in some way be interrelated. Many, if not most, genes, produce their initial effects during embryonic life, and there is plenty of opportunity for a primary effect to produce secondary effects, and these in turn tertiary and still further orders of effects. For example, figure 1 shows some of the ramifying effects of the Pelger anomaly, which is a human pathological condition exactly duplicated in the rabbit.<sup>6,7</sup> In man as in rabbit, it is also inherited in an identical way, although in the rabbit the homozygous Pelger condition is known, whereas in the human species the condition is so rare that individuals carrying a double dose of the gene have so far not been found. The Pelger gene in single dose causes the nuclei of the granular leukocytes to remain simply bilobed, instead of becoming trilobed or polymorphonuclear in the characteristic way. In double dose, in the rabbit, it results in a simply spherical nucleus in these cells, which appear to be the only blood cells affected. However, the homozygous condition is further characterized in the rabbit by skeletal defects that start to appear in early embryonic life, lead to chondrodystrophy, and as the figure shows, terminate frequently by one or another route in early death. Here genetic knowledge points to a

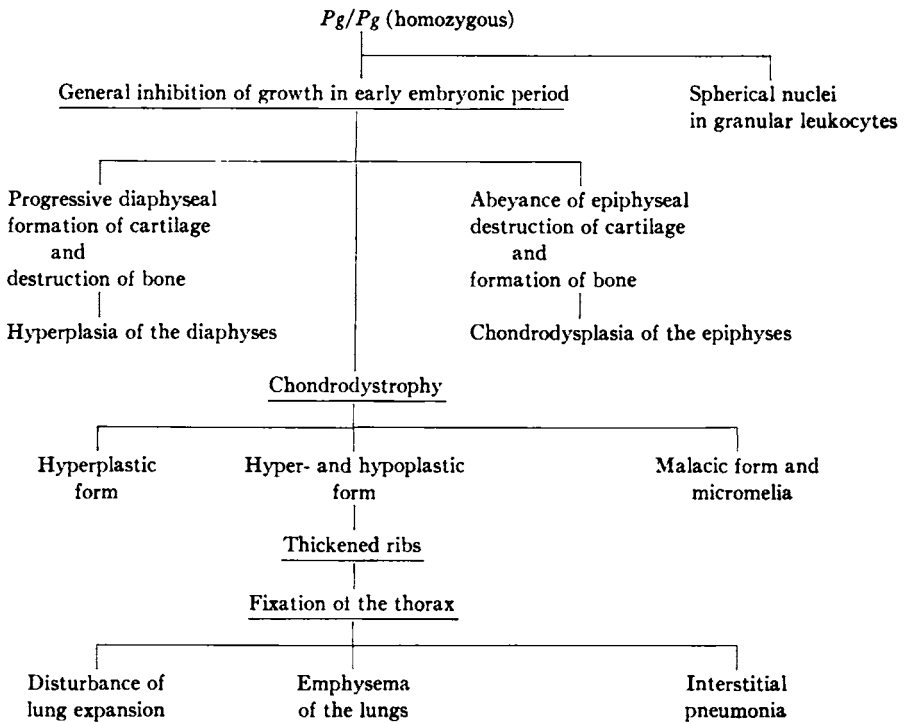

FIG. 1.—Effects of homozygous Pelger anomaly in the rabbit.

problem still to be solved by the anatomist and histologist: what is the unknown connection between the shape of the nuclei of the granular leukocytes and the development of the skeleton? A similar example is afforded by the interesting anomaly known as phenylpyruvic oligophrenia (also called phenylketonuria), which will be discussed more fully in a moment. In this condition the normal oxidative breakdown of phenylalanine by way of tyrosine is blocked, and phenylpyruvic acid is excreted in the urine. What is the connection between this seemingly harmless metabolic product and the low-grade imbecility or idiocy that is invariably associated with it?

A third important aspect of this relationship between gene and character offers another experimental toehold. This lies in the fact that many conditions, which appear from an anatomical, clinical, or physiological viewpoint to be identical, may by genetic studies be shown to differ. As the widely known studies in biochemical genetics made in the past 15 years have indicated, most, if not all, single gene differences between the normal and a mutant type block or alter single biochemical steps in the metabolic pattern. This may be illustrated effectively by a chart (fig. 2) showing the pattern of phenylalanine and tyrosine breakdown in man. Note that the simple Mendelian recessive already mentioned (phenylketonuria) blocks one particular step; recessive alcaptonuria, in which the urine turns black upon exposure to air, is produced by a second genetic block; and albinism, also generally recessive, blocks a specific third step. Even a fourth specific block in this relatively circumscribed biochemical area is known, as indicated; but it has only been reported in a single individual so that the inheritance of the condi-

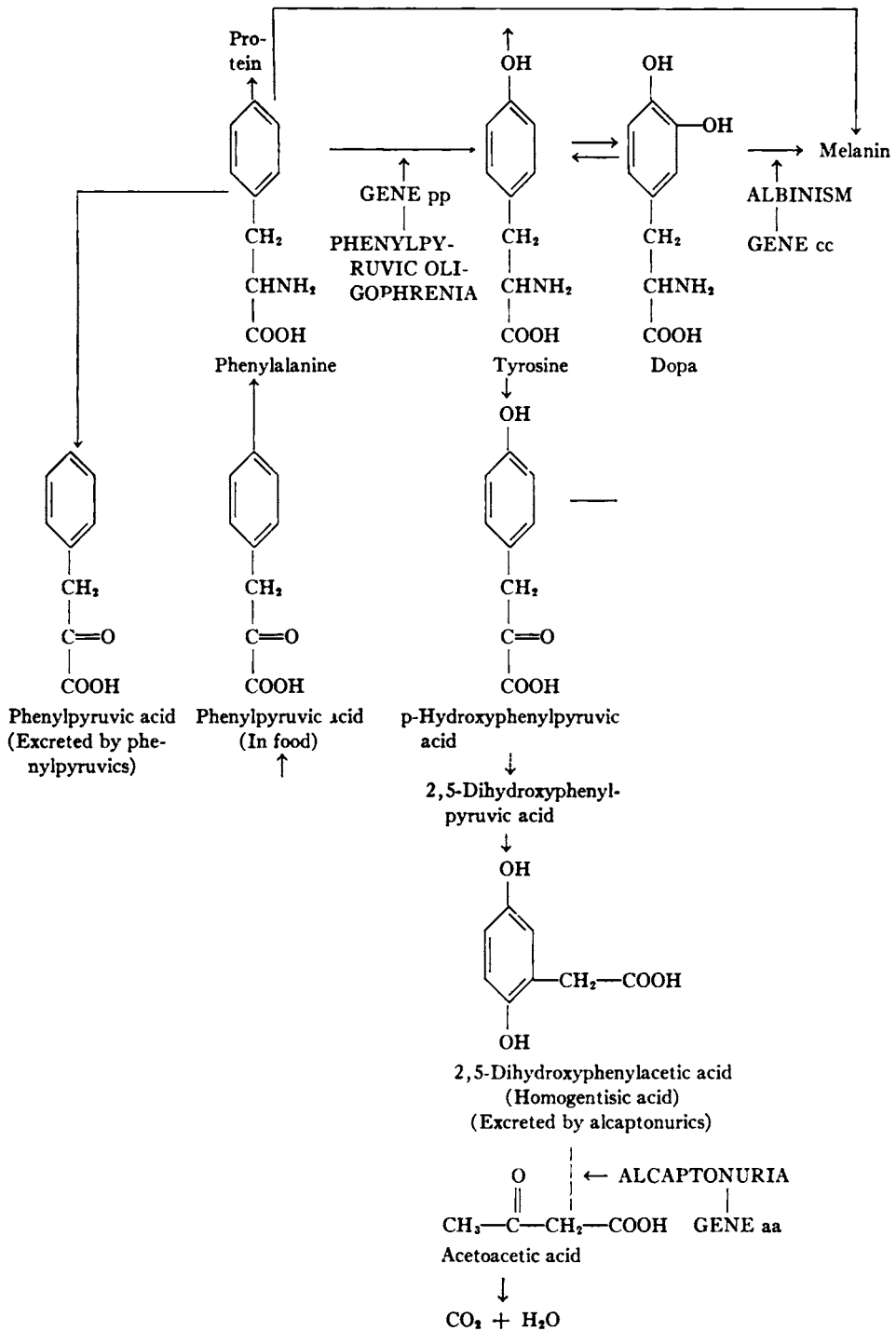

FIG. 2.—Scheme of phenylalanine-tyrosine metabolism in man. The conversion of phenylalanine to tyrosine is assumed to be blocked in persons homozygous for the gene for phenylpyruvic oligophrenia. (Modified, after Beadle.)

tion is not certain. In at least one of these hereditary conditions, phenylketonuria,<sup>4</sup> and perhaps in alcaptonuria also, it has been shown that the genetic block is due to the failure of the individual to produce the specific enzyme required for the conversion. Such may often be the nature of the block; yet studies in other organisms show that the specific enzyme involved may indeed be present in certain genetically blocked mutant types, but that it has been altered so that the rate of the reaction is changed. Or the normal enzyme may be present but, conceivably, a specific coenzyme may be missing locally. At any rate, mutation can change the site of action, that is to say, the tissue specificity, of the enzymatic conversion of substrate into product.

Now apart from the intimate relation of genetics to biochemistry here indicated, another instructive point is to be seen if we consider albinism somewhat further. Albinism is of several different genetic types. There is a dominant albinism, and there are albinisms with only partial extension over the body. This genetic diversity, even when the phenotype varies no whit, implies the existence of a different biochemical basis at the primary level where gene controls enzyme. This is well illustrated in some recent work of Harris and Warren<sup>3</sup> on cystinuria with stone formation, long supposed to be a single clinical and genetic entity. In the population at large the amounts of cystine excreted in the urine form a normal distribution, whereas in the selected cystinurics and their relatives Harris found a bimodal type of distribution. Further analysis revealed two types of families with cystinurics. In one sort the relatives fall into the normal distribution for the general population. In the other they form an intermediate group with a mode between that of the cystinurics and the average for the general population. In the first case, the gene responsible for cystinuria appears to be a simple recessive, whereas in the second case heterozygous individuals are distinct from both normals and cystinurics. Two genes must be involved, one completely recessive, the other intermediate. It is not known at present whether these are alleles or differ in chromosome location. From what we do know of inherited characters in other species, it seems very likely that many genes may produce the same end effect, and perhaps also in this case distinct genes are to be expected. The value of learning this lies in the indication that the metabolic path is probably blocked at different points in the different genetic cases; and biochemical investigation can distinguish them and enable us to learn more about the several steps in the production of the clinical condition. It should not need to be pointed out that this may in turn greatly enhance the accuracy of diagnosis and the power of therapy.

Turning now to the specific applications of these concepts and principles to atherosclerosis, we may note first of all that deposition of lipids in the aorta and coronary vessels is part of a broader phenomenon, the deposition of lipids in many sites, and especially, besides the blood vessels, in liver and skin. Xanthomatosis or xanthelasma are often associated with coronary disease and atherosclerosis, and xanthoma tuberosum, xanthomatosis, etc., have often been described as hereditary. Adlersberg, Parets, and Boas<sup>1</sup> have demonstrated that hypercholesterolemia is more of a key factor than the actual deposit of lipid or cholesterol plaques in the skin and eyelids (xanthoma and xanthelasma, respectively). In the entire families of 35 persons with xanthomatosis (201 persons), hypercholesterolemia was present in 60%, coronary atherosclerosis in 40%, xanthelasma and corneal arcus in 30% and 18% respectively, and tuberous xanthoma was the least frequent stigma (12.5%). There is now very good evidence, taking idio-



pathic hypercholesterolemia as the basic trait rather than the less frequently manifested stigmata, that it is produced by a single dominant gene. Even with high blood cholesterol as the criterion of the inherited condition, however, there is evidence of a lack of complete penetrance. That is to say, some individuals carrying the dominant gene may fail to reveal a high blood cholesterol level, even as some fail to develop coronary atherosclerosis, still more fail to develop xanthoma, and so on. This provides clear evidence that other factors can alter the manifestation of the main gene's effect. These might be other genes, modifiers, so to speak; or they might be factors external to the genotype altogether, for example, dietary differences. The total picture begins to look like the chart of effects produced by the Pelger gene, and reminds us that in our analysis we may still be far away from the primary action of the dominant gene concerned. The high level of blood cholesterol observed may itself be a secondary or tertiary effect of that primary action.

To follow up this idea, let me recall the finding by Best and his associates that depancreatized dogs do not develop fatty livers if they are fed excess choline. A recent report from the same group<sup>8</sup> carries this analysis considerably farther. In a high percentage of cases rats placed on a choline-deficient diet develop heavy lipid deposits in the coronary arteries and aorta, while controls remain entirely free. Many of the affected rats die of vascular lesions. The previous work of this group has led to knowledge of certain "lipotropic" factors that act like choline in preventing the fatty infiltration of organs. Some, like choline, apparently act as donors of methyl groups. Methionine presumably acts by virtue of its role in the synthesis of choline itself. Other lipotropic agents, such as aminoethanol and triethylcholine, lack labile methyl groups, but act like choline in the synthesis of phospholipids. One may therefore conjecture that the primary disorder of metabolism in "idiopathic hypercholesterolemia" lies not in cholesterol synthesis or breakdown, but perhaps rather in phospholipid synthesis. If there is an inadequate synthesis of phospholipids in the liver, an excessive deposition of fats would probably occur there, and perhaps the formation of cholesterol in abnormal amounts would be a by-product, since there is evidence that fatty acid synthesis and cholesterol synthesis compete for the two-carbon intermediates needed by both. These possibilities not only raise problems for the biochemist to attack, but open numerous paths for the genetic approach. One would like to know whether there is any choline abnormality connected with idiopathic hypercholesterolemia. Do people differ genetically in ability to absorb choline from the diet? or in ability to synthesize it from methionine? Is there any familial concentration of persons with abnormal phospholipid metabolism in the families with idiopathic hypercholesterolemia? and so forth.

One more interesting point derived from the data of Adlersberg *et al.*<sup>2</sup> may be mentioned. This is the very much higher incidence of the gene for disturbed lipid metabolism among Jews (21%) than among non-Jews (9%), in the sample of hospital patients studied. At the same time, the frequency of hypercholesterolemia among the sibs and children of the Jewish probands was no higher than among the non-Jews. The latter fact indicates that "environmental factors such as different occupations, housing and dietary patterns are not of decisive importance in determining the presence or absence of hypercholesterolemia." On the other hand, the ethnic difference in incidence is what we are led to expect by the study of the variations in gene frequencies in different populations

and races, and constitutes further evidence of the importance of the gene in the incidence of atherosclerosis.

It would be a violation of everything in the foregoing to suppose that all atherosclerosis is attributable to this particular gene and this particular sequence of errors in metabolism. Enough has been said, however, to show how the human geneticist looks at this type of problem, and how fruitfully work along genetical, as well as anatomical and biochemical, lines may lead to the eventual understanding of this ever more dominating killer of mankind.

#### REFERENCES

1. Adlersberg, D. A., Parets, A. D., and Boas, E. P.: Genetics of atherosclerosis: Studies of families with xanthoma and unselected patients with coronary artery disease under the age of fifty years, *J. A. M. A.* *141*: 246, 1949.
2. Adlersberg, D., Schaefer, L. E., Drachman, S. R., and Steinberg, A. G.: Genetic studies on idiopathic hypercholesterolemia, *Am. J. Human Genetics* *4*: 253-260, 1952.
3. Harris, H., and Warren, F. L.: Quantitative studies on the urinary cystine in patients with cystine stone formation and in their relatives, *Ann. Eugenics* *18*: 125-171, 1953.
4. Jervis, G. A.: Phenylpyruvic oligophrenia deficiency of phenylalanine-oxidizing system, *Proc. Soc. Exper. Biol. & Med.* *81*: 514-515, 1953.
5. Kallman, F. J., and Reisner, D.: Twin studies on genetic variations in resistance to tuberculosis. *J. Hered.* *34*: 269-276; 293-301, 1943.
6. Nachtshiem, H.: The Pelger-anomaly in man and rabbit. A Mendelian character of the nuclei of the leucocytes. *J. Hered.* *41*: 131-137, 1950.
7. Nachtshiem, H.: Vergleichende Erbpathologie der Blutkrankheiten am Beispiel der Pelger-Anomalie betrachtet, *Arch. d. Julius Klaus- Stifftg. f. Vererbgsforsch.* *25*: 566-585, 1950.
8. Wilgram, G. F., Hartroft, W. S., and Best, C. H.: Abnormal lipid in coronary arteries and aortic sclerosis in young rats fed a choline-deficient diet for periods of two and one-half to four weeks, *Science* *119*: 842-843, 1954.

#### DISCUSSION

*Dr. Page* asked whether there was any current work on the human genetic factors in atherosclerosis.

*Dr. Glass* replied that studies had been made in 1952 by Dr. Adlersberg at Mt. Sinai Hospital on hypercholesterolemia, but that he knew of no current studies on that subject. He mentioned that investigations of hereditary factors in coronary disease and hypertension were being conducted upon medical students at Johns Hopkins University.

*Dr. Katz*, referring to the Adlersberg studies of Jews in New York City, pointed out that the investigations had been carried out on a population that was not typical of American Jewish life.

*Dr. Glass* agreed that the conclusions of Dr. Adlersberg applied only to the group and environment studied, and that similar investigations should be made on more typical groups elsewhere.

*Dr. Winternitz* cautioned against the use of hypercholesterolemia and vascular disease as synonyms. There are other etiological factors.

*Dr. Glass*, in reply to Dr. Paterson's question whether hereditary capillary fragility has been noted, stated that the best known example is dominant telangiectasia, which is manifested by rupture of capillaries in the skin, tongue, and viscera, and is determined by a single dominant gene.

*Dr. Taylor* suggested that cholesterol-resistant rabbits, which formerly were discarded

because of failure to develop hypercholesterolemia under usual experimental regimens, be bred and studied.

*Dr. Lansing* replied that he had such studies in progress and had found the occurrence of resistance to be about one in ten. He expressed the hope that it would prove to be a recessive trait.

*Dr. Stare* commented that sex susceptibility to hypercholesterolemia in rabbits is the reverse of that in man, in that male rabbits are more resistant.

*Dr. Katz* added that certain strains of chickens, notably the Rhode Island Red, are resistant to cholesterol feeding.

*Dr. Kellner* questioned whether rabbits resistant to the elevation of blood cholesterol by cholesterol feeding were thereby also resistant to the development of atherosclerosis. He was of opinion that hypercholesterolemia depends upon absorption from the intestinal tract. When resistant rabbits are fed cholesterol together with a surface-active agent such as Tween-80, which enhances absorption, they develop hypercholesterolemia and atherosclerosis. Although the addition of a surface-active agent to the experimental diet does not entirely eliminate so-called resistance, it reduces it markedly in both male and female rabbits.

*Dr. Glass* emphasized that there may be an hereditary receptivity factor or reaction factor of the tissue; that a genetic difference affecting absorption might be responsible for the incidence of atheroma in a particular strain of rabbit. Even if it were demonstrated that a dominant gene for hypercholesterolemia existed in man, it would not follow that the gene was the sole factor or that it would always produce the same effects under all conditions.

*Dr. Anfinsen* commented that atherosclerosis might be due either to abnormality of the vessel, to changes in the blood, or to both combined. He pointed out that in certain conditions, such as biliary cirrhosis, hypercholesterolemia is not accompanied by atherosclerosis.

## THE BLOOD SUPPLY OF THE VESSEL WALL

M. C. WINTERITZ

It is indeed remarkable that in the year 1954 the title "Blood Supply of the Vessel Wall" should be included in a conference on atherosclerosis. Categorical statements acceptable to present day experts in this specific field surely would be welcomed were they justifiable. This should be possible with the methodologies at hand, many of which have been available for protracted periods. The explanation of the lack may lie in preoccupation with hypotheses of quick promise, and more especially inadequate appreciation of the importance of elemental problems the vessel wall has in common with all biological structures, including the source of its requirements and the elimination of products no longer desirable for its needs. Such knowledge, it seems, would be indispensable for the understanding of the processes of disease of these structures. The presentation that follows is purposed to stimulate attainment of the essential facts.

The blood vessels are included in the earliest medical texts; the Alexandrian School is accredited with the differentiation of arteries and veins, but the real significance of this separation awaited the great discovery of the circulation nearly 2,000 years later by William Harvey,<sup>1</sup> and of the capillary link soon thereafter by Malpighi<sup>2</sup> as he traced the blood flow through the lungs from the right to the left ventricle. Since then, detailed information of the vascular pattern has accumulated more rapidly. For the purposes of this conference and at this time it is only desirable to recall the development of the great capillary plexus in the embryo and its evolution, including both its progression to arteries and veins, their regression to obliteration that may be complete with functional disuse after maturation and, lacking either of these extremes, retention of its undeveloped status as angioblast or thin-walled capillary channels. Species differences are also well known, as are the pattern variants for practically every visceral and somatic unit of the same animal. Investigations designed to elucidate function often have helped with the understanding of structure, and the reverse likewise can be illustrated. Technological procedures<sup>3</sup> like injection of the vessels and increased transparency of the tissues by clearing, in high vogue in the 18th century, facilitated the exploration of vascular distribution. While the maximal advantage of such study may have been derived long ago, the return may not yet be exhausted.

Another approach requires thought. Small and simple forms of life have no such highways and byways as the blood vessels for the exchange of materials essential to growth and maintenance of supporting tissues and their constituents. These forms may well be likened to the intercapillary areas of more complex organisms. Such intercapillary areas vary considerably in size. Cartilage, as is well known, occurs in reasonably large segments devoid of all vessels, including capillaries, within the endochondrial membrane; then there is the lens of the eye, with a function that would be invalidated if it contained capillaries; and again, the entire cortex of the tooth beyond the pulp canal. These are not sequestered structures, they are living, breathing tissues, and perforce must secure the needs for life in ways more compatible with their designed function if less dynamic and further removed from the ultimate vascular source. Some knowledge of these ways

has been available, but a new era dawned as tagging with tracers both of the heavy and fast varieties became more available. It is still young, but it is indeed an era of great promise. Then, too, there is a considerable increment in knowledge concerning the permeability of interstitial tissues and the influence exerted in this direction by agents like the spreading factor,<sup>4</sup> specific compounds generated in the cortex of the adrenal gland,<sup>5</sup> and the control exerted on these by the pituitary.<sup>6</sup> As knowledge grows, it should be possible to ascertain the differentials between these factors associated with the permeability of the interstitial tissues and the extent to which other mechanisms can compensate as capillary blood flow is reduced.

It is unnecessary to emphasize the great lability of the circulatory mechanism. Its responsiveness to stimulation of innumerable varieties is basic to practically every function of the organism, and consists of adaptation of speed and volume of flow through the capillary compatible with the exchange of requirements for the task in hand between the blood and the tissue concerned. The manifestations of response within the modal and accustomed degrees of stimulation are well known but below the threshold of consciousness, as a rule, unless special interest is involved. But they may become very conspicuous when the stimulant becomes an irritant—be this primarily physical or chemical, or derived from a biological source. Under these premises the reaction is termed pathologic—but it is all too obvious that the mechanism is the same, and that the phenomena concerned are only quantitative permutations of those that respond to the more usual, physiologic variety of stimuli. The gross characteristics of this vascular mechanism are easily documented. The cellular elements of the blood, likewise, are limited compared to the well-nigh innumerable constituents of the plasma. These are picked up from a vast number of points of origin and depend for their transport upon the circulation. The specific reason for their passage from the blood stream in response to call, be this usual or unusual in degree or nature, must be ascertained to replace generalizations that are no longer useful, even if time was when their value could not be queried.

Acceptance in principle that manifestations of disease are merely quantitative variants of the phenomena of physiology broadens our approach to consideration of specific morbid change. Any positive point of departure may be a premise of greater promise than could have been anticipated, and some of the many of these converge advantageously on the problem under consideration: the blood supply of the vessel wall in relation to its life and function.

Ramsey's<sup>7</sup> review of the literature in 1936 did not result in her commitment to any one of the three possible sources of nutrition of the vessel wall; the vasa vasorum, the luminal blood, or a hypothetical mural canal system of a different order. On the contrary, she concluded that compromise probably would be essential, as none of the rigid theories would prove to be entirely adequate.

There can be no doubt that the healthy vessel wall is not an exception to other living tissues, and that the same pertinent principles of requirement for supply and waste removal apply here as in other biological systems. The detail of how these needs are met no doubt will be disclosed as available methods are applied. Enthusiasm for such investigation is not yet at hand as effort continues to clarify the relation of cholesterolemia to diet.<sup>8</sup> This subject has become less pressing with the knowledge that such lipid is actively synthesized within the organism,<sup>8</sup> and now plausible variants, coupling molecular size and shape with penetrability of the lipid complex, are favorite points of de-

parture for investigators.<sup>9</sup> To oppose such hypotheses, sustained as they have been by comparative studies that disclose lesions of great similarity to some of those of human arterial disease in a few species of animals, under appropriate conditions, has not been a popular procedure. Nor has it been easy for the general pathologist to accept a theory of pathogenesis for vascular disease so far removed from the biological philosophy of approach that has proven to be fundamental for the better understanding of the morbid manifestations of many other organ systems.

It would, however, be wrong indeed to leave the impression that there is no unanimity of opinion concerning any phase of the problem of blood supply to the vessel wall. Bremer's<sup>10, 11</sup> comparative anatomical studies, including those of the developing human embryo, disclose vascular patterns entirely compatible with those accepted for the distribution of the vasa vasorum of larger mammals. These are easily demonstrated;

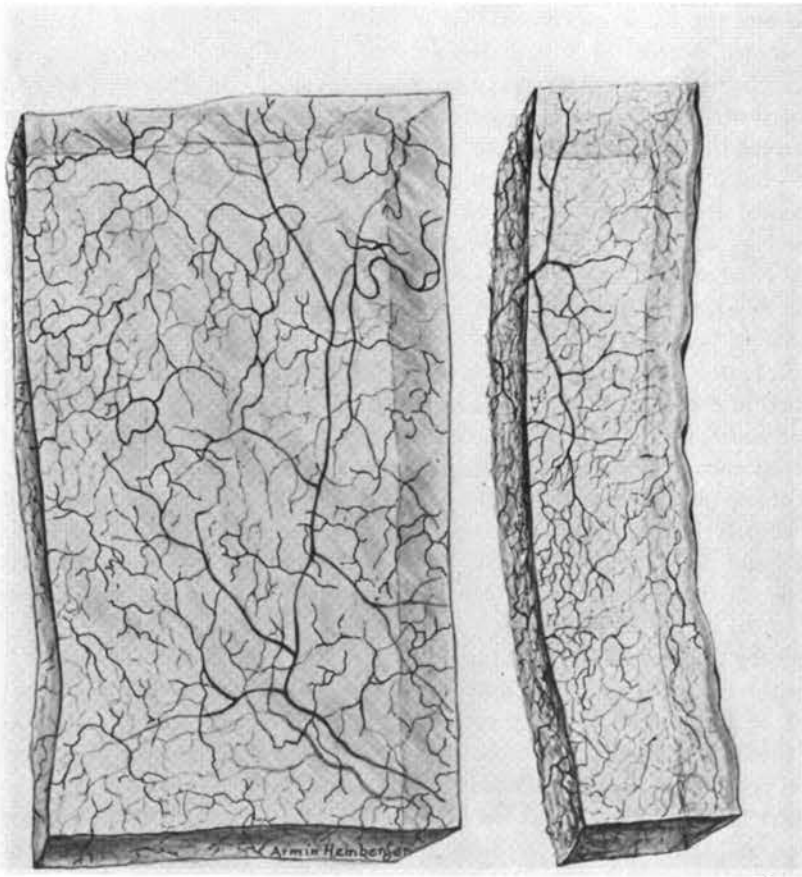

FIG. 1.—Vena cava (man) injected and cleared by the Spalteholz method. At left: view from intimal surface. At right: transverse section, the intimal surface being on the right. Extensive vascular network is demonstrated. (Courtesy Charles C Thomas.<sup>12</sup>)

they consist of

- (1) the well-known group concentrated in the adventitia and penetrating from there to join
- (2) those arising from the lumen, either
  - a. at the mouths of branches, or
  - b. independently.

The extent of this intramural plexus of vessels is indeed impressive for the beef, the horse, the sheep, etc. In man and in smaller mammals it certainly is far less conspicuous. Sappey<sup>12</sup> was convinced that this is due to difficulty of demonstration and not to absence. This is sustained by study of the diseased vessel wall of man, where the pattern is again present, often conspicuously.<sup>13</sup>

Interesting as is the conviction of a distinguished anatomist, further evidence must be sought. Diminution of mass of vessel wall in man and more in smaller mammals well may allow a simpler mechanism of exchange than that which is so characteristic of larger species. Several facts demand further scrutiny before acceptance of such conclusion.

In the first instance, a similar and extensive vascular pattern is readily demonstrated in the much less massive human vein wall by clearing after injection under pressure of a colored solution into the lumen (fig. 1). The injection may be toward the capillary bed, against blood flow, in a viscus, or in a segment a few centimeters in length and tightly closed at both ends. It has been suggested that the contractibility of the vein wall is limited and consequently cannot compress the intramural vasa or offer resistance to the injection of a dye adequate to prevent filling, as may be the situation in the more powerfully contractile artery. This same reasoning may be called upon to explain the greater ease of injection of vasa of the human pulmonary arterial system as compared with the systemic counterparts.

The pathway from lumen of vein to wall can readily be demonstrated to communicate with the neighboring artery and to provide the channel for the extension of infection

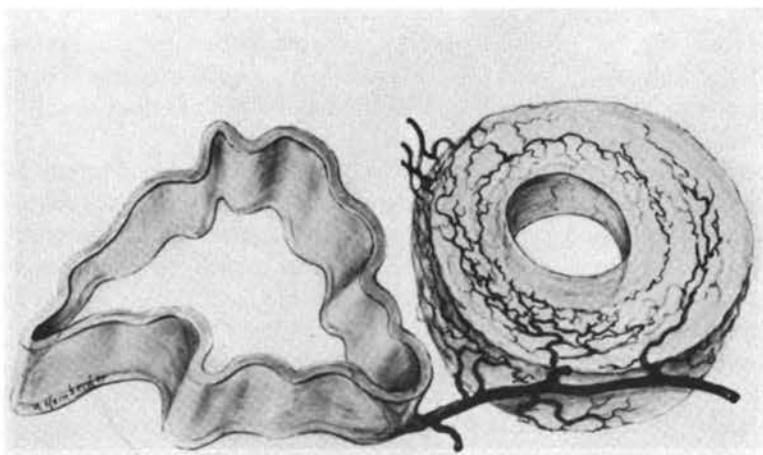

FIG. 2.—Femoral vessels (normal) of a goat injected with India ink by way of a vein. A retrograde injection of the vasa vasorum of the artery has occurred by way of a small tributary of the vein. (Courtesy American Journal of Pathology.<sup>14</sup>)

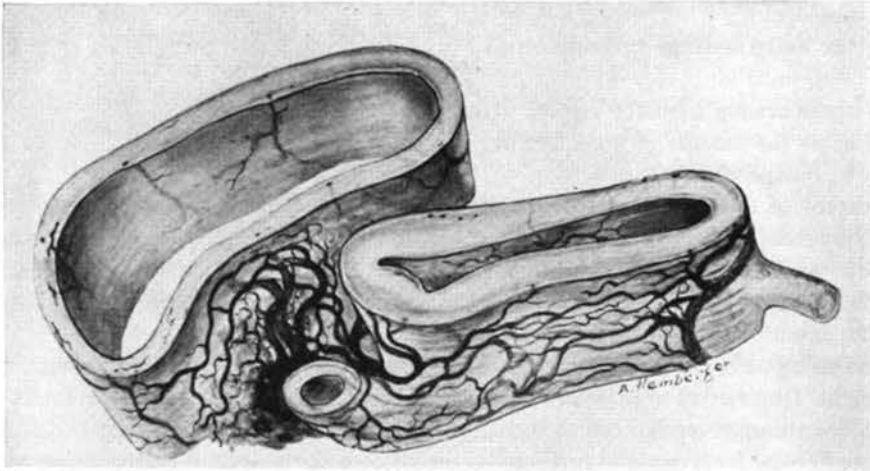

FIG. 3.—Block of human femoral vessels injected through the left femoral vein and cleared. There is an extensive injection of the vasa vasorum of both vessels. (Courtesy: American Journal of Pathology.<sup>14</sup>)

both of the acute inflammatory and chronic varieties, when microorganisms of appropriate types and virulence are introduced into the system. All of these details, including the communications between the lumen of the vein and its wall by way of the vasa vasorum to and through the three coats of the neighboring artery even to its lumen, become evident both by injection and by the spread of infection in the goat<sup>14</sup> (fig. 2).

For man very similar if slightly less extensive communications between vein and neighboring artery are readily shown by injection (fig. 3) and also by careful histological study, in the vicinity of chronic arterial wall processes with and without complicating thrombus. Such findings should not be surprising when the frequency of simultaneous arterial and venous involvement in thromboangiitis obliterans is kept in mind. The veins unfortunately, but easily explainably, are among the largely neglected tissues of study so far as both their gross and histological pathology is concerned. It may well be that such investigation would help understanding of arterial disease and even of its pathogenesis.

It is possible surely to sharpen focus on the problems of this blood supply to the vessel wall. There is no doubt concerning the extensive circulation within the adventitial coat, including both arterial and venous varieties, for all mammals. This is generally agreed to extend through the outer third of the media, even though discrepancies are large in opinion concerning their further penetration. For the beef, the horse, and comparably sized mammals, as has been said, there is no question.

The ramifications of the adventitial vasa within the media anastomose freely with complementary vessels arising at the mouths of larger branches and also independently from the lumen of the mother artery (fig. 4). These three varieties of vasa, so far as point of origin is concerned, anastomose freely to form a considerable network; and, as will be indicated, this becomes greatly exaggerated under certain circumstances in man, including age and more especially arterial wall thickening and luminal narrowing (figs. 5, 6, 7, 8). It must be conceded for the present, however, that the arterioles contributing



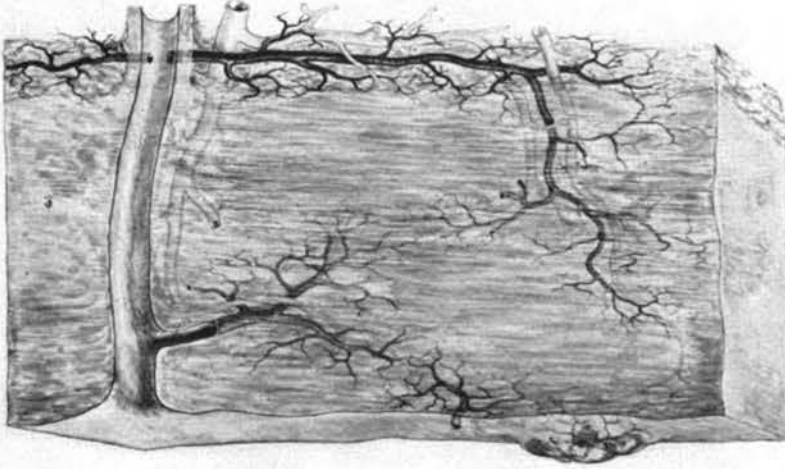

FIG. 4.—Diagram of vasa vasorum circulation in aorta.

to the mural plexus and arising from the lumen of the mother vessel are rarely found in man when there is no other local expression of vascular adjustment, and that they are not reported as occurring in mammals of smaller size. This may be interpreted as an accomplishment to be attained; or perhaps, with an arterial wall of limited size, some

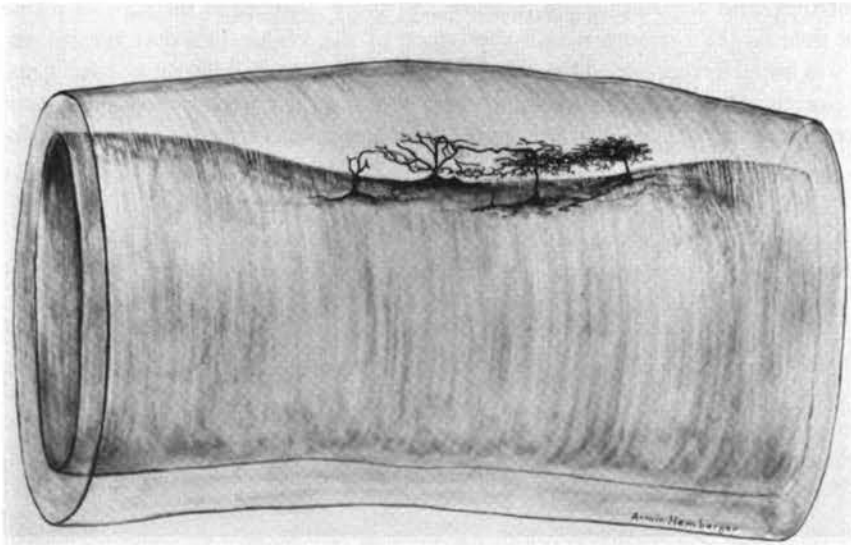

FIG. 5.—Coronary artery, injected and cleared, with adventitia removed. Vasa vasorum arising from intima and forming tree-like patterns. (Courtesy Charles C Thomas.<sup>13</sup>)

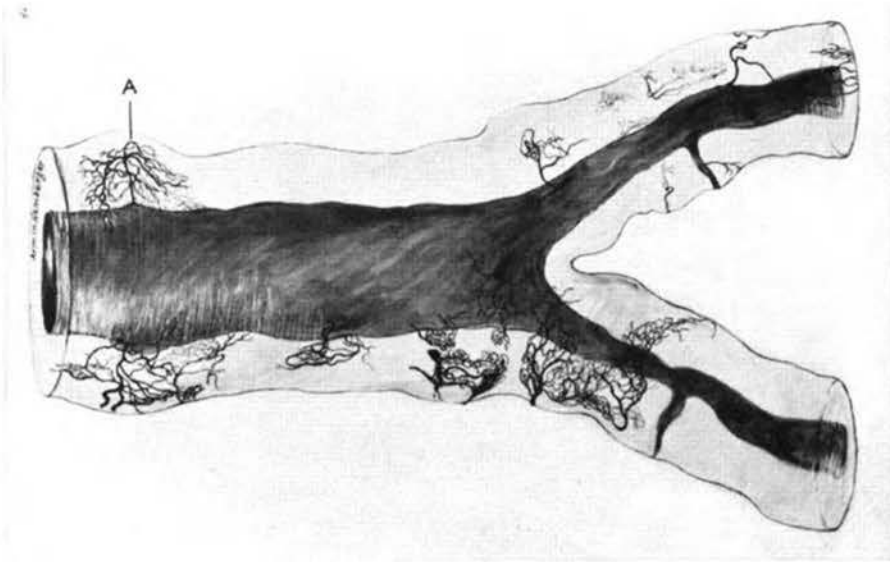

FIG. 6.—Drawing showing various modes of origin of vasa vasorum. Note “weeping willow tree” pattern at (A). (Courtesy Charles C Thomas.<sup>13</sup>)

more simple mechanism suffices for the accession of requirements and the elimination of waste by the intima and the inner half or two-thirds of the media.

Considerations opposing such a conclusion and worthy of review are available. The tensile strength of the vessel wall is determined largely by the tough, inelastic adventitia as compared with the both more delicate and more distensible media and intima. It follows then as the pressure within the lumen of the vessel rises that the intima and media will become compressed between this force and the retaining outer coat. Capillary blood flow then would be impeded and stopped, intermittently at least. This may well have recognizable effects. The question arises whether it is expressed in the medial ne-

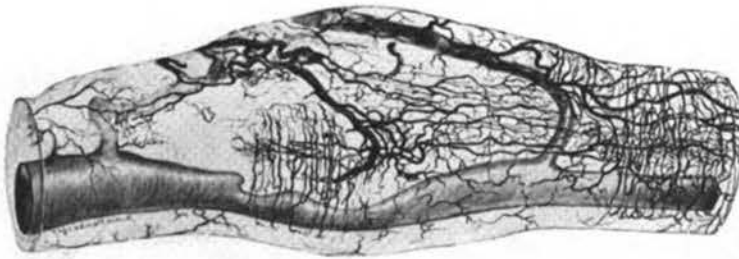

FIG. 7.—Branch of renal artery, injected and cleared, showing greatly narrowed lumen and numerous vasa vasorum forming collateral channels in the wall. (Courtesy Charles C Thomas.<sup>13</sup>)



FIG 8.—Portion of anterior tibial artery, injected and cleared, with adventitia removed. Numerous calcified plaques and an extraordinarily intricate vascular pattern were seen. Note the circular arrangement of some of the medial vessels. The lumen is occluded in three places and is connected with the general circulation by branches. (Courtesy Charles C Thomas.<sup>15</sup>)

crosses associated with protracted hypertension after intravenous adrenalin administration<sup>15</sup> in the dog; and further, whether it is the mechanism causatively associated with necrosis and other acute lesions of the media now recognized as occurring with considerable frequency in man. That the recognition should have been slow is not astounding when the rate of evolution of knowledge is recalled concerning the usually far more extensive lesions of syphilis.

These medial lesions, including cystic and mucoid change, necroses with and without hemorrhage, and also the scars of replacement may well be an expression of hypertension. This does not exclude other etiologic possibilities, among them infections like typhoid and typhus fever, tuberculosis, etc., tissue constituents of complex nature,<sup>16</sup> and much simpler compounds of which allylamine<sup>17</sup> is a striking representative.

The medial focal necroses have gained added significance with the recognition that they are not infrequently the sites of hemorrhages.<sup>18</sup> They may be quite small and inconspicuous, or sufficiently extensive to be called dissecting aneurysms. The story of this interesting process is now quite clear.

The causative factor is not emphasized, and may well be any one of several, as indicated above. But medial necrosis probably is the initial lesion, followed by hemorrhage, as Tyson pointed out in 1931.<sup>19</sup> The blood must come from intramural, indeed from intramedial, vessels and the question whether these vessels are a part of the normal system or augmented in response to an underlying process hardly represents an issue.<sup>20</sup> These hemorrhages, as is well known, dissect the coats of the vessel, sometimes over a very large area; they may rupture through the intimal coat and, indeed, through the much more difficultly torn adventitia. On the other hand they may be retained within the vessel wall itself. This no doubt has been a major reason for abandoning the older theory of their origin from an intimal tear that allowed dissection of the wall by luminal blood.

Extensive intramural hemorrhage in smaller arteries without rupture into the lumen or through the outer wall tends to compress, and actually may obliterate, the lumen of the artery. This still is a rare finding, as shown by a recent report in the literature.<sup>21</sup>

There is little evidence of any tendency to relate these several types of large hemorrhage in the artery wall with the smaller varieties now well known to be associated with experimental arterial disease and also to be frequent in the human artery wall. The difficulty of their identification is readily understood, as the opacity of the intimal surface is adequate to obscure colored materials proportionately to their depth of location beneath the surface. The more arduous and careful technical approach of cross-section,

however, is satisfactory and even more so is clearing of the vessel wall, after injection of the vasa and removal of the adventitia under the dissecting scope.<sup>13</sup>

This is Dr. Paterson's field, which must not be infringed upon. Perhaps inquiry of the fate of such blood inspissated in the wall of the vessel is permissible. For it will be recalled that such extravascular accumulation as occurs in a hemangioma or in a thyroid adenoma results in an appearance easily confused histologically with the lesion characteristic of the subject of this conference—atherosclerosis. It would be interesting if, as has been suggested,<sup>22</sup> the spilled blood could contribute not only iron but lipid in mass, free and phagocytized, and also in crystalline form, to the accumulation that characterizes this type of vascular disease.

#### REFERENCES

1. Harvey, William: *Exercitatio Anatomico de Motu Cordis et Sanguinis in Animalibus*, etc., Frankfurt, Wilhelm Fitzer, 1628.
2. Malpighi, Marcello: (Letters to Borelli, 1661.) Cited by W. G. MacCallum, "Marcello Malpighi, 1628-1694," *Bull. Johns Hopkins Hosp.* 16: 275, 1905.
3. Singer, C., (ed.): *Studies in the History and Method of Science*, Oxford, 1921.
4. Duran-Reynals, F.: *Tissue Permeability and the Spreading Factors in Infection*, *Bact. Rev.* 6: 187, 1942.
5. Rich, A. R., Berthrong, M., and Bennett, I. L., Jr.: *The Effect of Cortisone upon the Experimental Cardiovascular and Renal Lesions Produced by Anaphylactic Hypersensitivity*, *Bull. Johns Hopkins Hosp.* 87: 549, 1950.
6. Berthrong, M., Rich, A. R., and Griffith, P. C.: *A Study of the Effect of Adrenocorticotrophic Hormone (ACTH) upon the Experimental Cardiovascular Lesions Produced by Anaphylactic Hypersensitivity*, *Bull. Johns Hopkins Hosp.* 86: 131, 1950.
7. Ramsey, E. M.: *Studies in the Pathology of Vascular Disease. I. Nutrition of the Blood Vessel Wall: Review of the Literature*, *Yale J. Biol. & Med.* 9: 13, 1936.
8. Shoenheimer, R. S.: *The Dynamic State of Body Constituents*, Harvard University Press, Cambridge, Massachusetts, 1942, p. 78.
9. Gofman, J. W., *et al.*: *The Role of Lipids and Lipoproteins in Atherosclerosis*, *Science* 111: 166, 1950.
10. Bremer, J. L.: *The Development of the Aorta and Aortic Arches in Rabbits*, *Am. J. Anat.* 13: 111 1912.
11. Bremer, J. L.: *The Earliest Blood Vessels in Man*, *Am. J. Anat.* 16: 447, 1914.
12. Sappey, P. C.: *Traité d'Anatomie Descriptive*, Paris, 1888, vol. 2, p. 496.
13. Winternitz, M. C., Thomas, R. M., and LeCompte, P. M.: *The Biology of Arteriosclerosis*, Springfield, Illinois, Charles C Thomas, 1938, p. 142.
14. Winternitz, M. C., and LeCompte, P. M.: *Experimental Infectious Angeritis*, *Am. J. Path.* 16: 1, 1940.
15. Waters, L. L., and DeSuto-Nagy, G. I.: *Circulatory Factors in the Pathogenesis of Experimental Arteriolar Necrosis*, *Yale J. Biol. & Med.* 22: 751, 1950.
16. Winternitz, M. C., *et al.*: *Studies on the Relation of the Kidney to Cardiovascular Disease*, *Yale J. Biol. & Med.* 12: 623, 1940.
17. Waters, L. L.: *Changes in the Coronary Arteries of the Dog Following Injections of Allylamine*, *Am. Heart J.* 35: 212, 1948.
18. Winternitz, M. C., and Waters, L. L.: *Lesions of the Larger Vessels Following Renal Artery Constriction*, *Yale J. Biol. & Med.* 12: 451, 1940.
19. Tyson, M. D.: *Dissecting Aneurysms*, *Am. J. Path.* 7: 581, 1931.
20. Gore, I.: *Pathogenesis of Dissecting Aneurysms of the Aorta*, *Arch. Path.* 53: 142, 1952.
21. Sinclair, W., Jr.: *Dissecting Aneurysm of the Middle Cerebral Artery Associated with Migraine Syndrome*, *Am. J. Path.* 29: 1083, 1953.
22. Sarason, E. L.: *The Cellular Reaction to Intraperitoneally Injected Blood*, *Yale J. Biol. & Med.* 12: 269, 1940.

## DISCUSSION

*Dr. Waters* called attention to the absence of blood vessels in teeth, cartilage, and the cornea and lens of the eye as a result of evolutionary adaptation.

*Dr. Winternitz* felt that an explanation of the mode of nutrition of those structures might shed light on that of the blood vessel wall.

He stated that the pressure used in his injection technique was just about as much as the vessels would tolerate; 100, 200, or 300 mm. of mercury. Less pressure was required to inject the venous wall than the arterial. After injecting and clearing, the adventitial tissue was stripped off and the preparation was examined under the microscope.

In reply to questions concerning the presence of lymphatics in the blood vessel wall, he stated that he had not been able to see them in his preparations. He commented that in spite of its red color, blood in the vasa vasorum is hidden by the opacity of the walls unless the vessel is close to the surface.

*Dr. Katz* asked whether *Dr. Winternitz* had found a difference in the vascularity of the vessels in animals of smaller size.

*Dr. Winternitz* agreed that it was a fundamental biological question whether the passage of materials is different through the thin wall of the rat aorta than through that of the goat. He stated, however, that he had not been successful in obtaining adequate injections in the smaller animals and therefore could not answer the question more specifically.

*Dr. Duff* commented that in Buerger's disease the arterial walls are sometimes rendered cavernous by the dilatation, and possibly by increase in the numbers of vasa vasorum, which appear to form a network and to serve as collateral channels to compensate for obliteration of the lumen.

*Dr. Winternitz* agreed that a collateral circulation may develop, and emphasized that there are controlling factors beyond the mere ligation or occlusion of a vessel. He observed that in a given species some individuals develop more extensive collateral circulations, but that the phenomena which determine the rapidity of formation of new capillary channels are unknown.

*Dr. Anfinson* suggested that the blood space in a vessel might be determined by tracer techniques with  $I^{131}$ -tagged albumin under conditions that did not involve higher pressures.

*Dr. Simeone* asked whether the nutrient vessels stem from the lumen of the artery or from ancillary arteries.

*Dr. Winternitz* replied that they are derived from three sources: the adventitia, the lumen at or near the mouth of each branch of the artery itself, or the intima. He emphasized that the vasa vasorum are derivatives of the vessel itself rather than of adjacent vessels.

*Dr. Lansing* commented that *John Kirk*, in studying the metabolism of the arterial wall, had found a low aerobic and anaerobic metabolism of arteries in both the human and the dog, more compatible with that in cartilage and lens than with that in vascular tissue.

# OBSERVATIONS ON VASCULAR STRUCTURE IN RELATION TO HUMAN AND EXPERIMENTAL ARTERIOSCLEROSIS\*

GEORGE M. HASS†

When experimental research has as its principal objective the specific analysis of human disease, it is often difficult to conduct the research continuously with the principal objective in mind. There is a tendency for the objective to undergo a subtle change directed by positive results of the experiment. At times, this change is desirable and the knowledge which accumulates through diversion of interest is very valuable. At other times, the knowledge which accumulates is harmful because it directs the research effort away from the original objective. Therefore, it is useful to keep the problem in mind and to reflect at intervals upon the relations between the experimental trends and the human disease which is being studied by the experimental methods. This is the main purpose of the present article, which is concerned mostly with efforts in this laboratory to reproduce in the experimental animal forms of athero-arteriosclerosis which closely resemble the common forms of the human disease.

## *The General Problem of Human Arteriosclerosis*

Most of us believe that we know what arteriosclerosis is. There can be little conviction in this belief. Arteriosclerosis is not a simple process and not a disease entity. In general, it may be regarded as complex mixture of degenerative and reparative processes which lead to increased rigidity, diminished elasticity, and often decreased caliber of arteries. As a rule, these processes either develop or are accentuated at focal points with a tendency to spread and become confluent. The processes have unpredictable vagaries of distribution. At times, they involve only local vascular segments; at other times, only certain branches of an organ system; and, at still other times, only branches of similar dimensions in several organ systems. Generalized arteriosclerosis, therefore, is a diagnosis which seldom describes the pathologic state. Little parallelism exists in the magnitude or basic character of involvement of different arterial systems and even branches of the same arterial system. In one patient, the processes may be severe only in the aorta. In another, the aorta may be lightly involved, while severe changes are apparent in the coronary arterial system. In still another patient, the cerebral arteries may be severely affected, with only minimal changes in the aorta or coronary arteries. The same observations apply not only to organ systems but also to branches, especially those of similar caliber in different organ arterial systems.

These facts direct attention to the conclusion that, if the exciting factor in the pathogenesis of human arteriosclerosis is a relatively inert chemical compound circulating in the blood plasma, the distribution of the structural effects of the exciting factor is non-uniform and therefore must be controlled by other factors, some of which must be local in nature and variable from place to place in the vascular system. Therefore, we can not neglect a search for local factors in the pathogenesis of arteriosclerosis, however desirable a single systemic explanation might be.

\* These studies were supported by grants from the Otho S. A. Sprague Memorial Institute and a research grant (H-452) from The National Heart Institute of The National Institutes of Health, U.S. Public Health Service.

† In the absence of Dr. Hass, this paper was presented by Dr. C. Bruce Taylor.

*The Definition of Human Intimal Arteriosclerotic Sequences*

Inasmuch as there is no single cause or definitive characteristic of arteriosclerosis, the process has been defined principally by microscopic structural changes. Unfortunately, there is no agreement as to the sequences in the structural changes or as to a common pathogenesis. Structural changes may occur in one part or all parts of the vascular wall. The most easily recognized changes are encountered in the intima. These seldom occur alone, nor can they be regarded as occurring prior to changes of less pronounced structural nature elsewhere in the vascular wall. The most important intimal change is essentially proliferative. This proliferative reaction, if undisturbed by degenerative changes, often results in the construction of a tissue which resembles that of the subjacent vascular wall. Thus, the reaction may be regarded as a reparative process. The orientation of the proliferating fibroblasts, the deposition of collagen between them, the new formation of elastic tissue, and even the differentiation of fibroblasts into smooth muscle cells indicate that local conditions have stimulated the proliferating tissues to build structure which resembles that of the subjacent vascular wall.

It would seem that this biologic reaction is a natural response to circulatory conditions. Seldom, however, does this response proceed to perfect vascular reconstruction. Usually, the reaction is modified so that fibrous elements predominate and undergo degenerative changes of a mucinous or hyalin character. Also, there is often, particularly in proliferating intima of large arteries, an accumulation of lipids, especially cholesterol and its compounds. Coincidentally, many macrophages appear and yellowish fatty plaques are formed. These areas deteriorate and excite inflammatory reactions, usually accompanied by ingrowth of capillaries from the adventitia or vascular lumen. Hemorrhage from the newly developed capillary network is common. This frequently causes acute swelling of the plaque with superficial necrosis and subsequent thrombosis leading to occlusion of the lumen of the vessel. A less significant degenerative change in the hyalinized mucinous collagen of proliferating intima is characterized by calcium deposition. This is usually more conspicuous in the presence of necrosis of atheromatous accumulations. As vascularization of calcified zones proceeds, bone and bone marrow occasionally form.

This description of intimal proliferation and degeneration has been given in what I believe to be the common sequence. Others give different interpretations. Several contend that deposition of cholesterol and other lipids in an otherwise normal intima is the primary stimulus to intimal proliferation. There is merit in this theory, which is currently being thoroughly tested. I

*The Definition of Intimal Arteriosclerotic Sequences in Hypercholesterolemic Rabbits*

The lesions which occur in dietary hypercholesterolemic atherosclerosis in rabbits resemble some intimal atheromatous lesions in man. The lesions in the experimental animal also have features which are not encountered in the human disease. Likewise, the human disease has features which are not encountered in the experimental disease. These similarities and differences are often disregarded, leading to unjustified generalizations about the pathogenesis of human arteriosclerosis.

Apparently, the primary event in the experimental disease is an accumulation of lipids of several types in the intimal and subintimal tissues. This is followed by an accumulation of macrophages which ingest the deposits of lipids and acquire the mi-

microscopic appearance of "foam-cells." Initially, local plaques of "foam-cells" develop and not only encroach upon the lumen of the artery but also spread laterally to form broad confluent lesions. In time, these cells degenerate and release the accumulated lipids, which may persist in globular or crystalline form in a loose, relatively acellular reticular framework. Intimal proliferation with abundant deposition of collagen, formation of elastic tissue, and differentiation of proliferating cells into mature fibrocytes or smooth muscle cells is a negligible aspect of the usual development and involution of these lesions.

In addition to the microscopic differences between intimal lesions of human arteriosclerosis and hypercholesterolemic arteriosclerosis in rabbits, there are conspicuous differences in the anatomical distribution of lesions. The intimal lesions in hypercholesterolemic rabbits, in general, appear first in the proximal aorta and spread distally. As a rule, the only major arterial branches which show severe involvement are the coronary arteries. The more peripheral arteries are rarely affected by the disease. On the other hand, the larger pulmonary arteries are consistently involved. This distribution is wholly different from that regularly encountered in human arteriosclerosis. Nevertheless, it is a very interesting distribution, and an explanation of it might give some insight into reasons for vagaries of distribution of the human disease.

#### *The Definition of Sequences in the Vascular Media in Human Arteriosclerosis*

The media of arteries is nourished primarily by diffusion. As a rule, the media lies between two elastic membranes known as the internal and external elastic membranes. The aortic media is supplied with multiple similar concentric elastic membranes. The internal elastic membrane lies between the intima and the media. It is a sort of blood-media barrier composed primarily of elastic tissue. It probably has something to do with discrimination between materials which normally pass back and forth between the cells of the (avascular) media and the blood stream. In human arteriosclerosis, the internal elastic membrane, especially of peripheral muscular arteries, often undergoes degenerative changes. These changes are multiple, but the principal results are increased rigidity, calcification, and fragmentation of the membrane. As these changes occur, they are often accompanied by structural modifications in the overlying intima and subjacent media. The usual intimal reaction is proliferative and basically fibrocellular in nature. The usual changes in the media are degenerative, with variable degrees of repair of degenerate structure. Whether the changes in the internal elastic membrane are responsible for modifications in the structure of the intima and media is a question of fundamental importance. It seems probable that the loss of chemical and structural integrity of the internal elastic membrane and the subjacent media are significant early events in the development of human arteriosclerosis, especially in medium-sized arteries. At times, these events are the only ones which are recognizable, microscopically.

The extreme state of lipemia and hypercholesterolemia induced in rabbits by dietary methods leads to an accumulation of lipids in many locations other than the intima of arteries. It is easy to demonstrate abnormal amounts of lipids in the media of arteries. These accumulations under ordinary experimental conditions do not seem to disturb the integrity of the media. However, when the accumulation of lipids in intimal atheromatous plaques is attended by degeneration of cell structure of the plaques, the media



is often affected. The first evidence of this adverse effect is a change in the optical properties of the internal elastic membrane. This change is followed by fibrillation and development of structural discontinuities in the internal elastic membrane. As this occurs, lipids permeate the media locally and the smooth muscle cells undergo degenerative changes. These modifications are not ordinarily followed by accumulation of "foam-cells" or significant signs of repair. The observed sequences and the end-result fall far short of reduplicating the customary medial degenerative and reparative changes encountered in human arteriosclerosis.

*The Production in Rabbits of Vascular Disease Resembling Human Arteriosclerosis*

The preceding comments have indicated that dietary hypercholesterolemia alone does not lead to the development of a form of vascular disease generally comparable to the usual forms of human arteriosclerosis. Furthermore, a consideration of the human disease indicates that local conditions and changes in the vascular wall contribute to the development and progression of the arteriosclerotic processes.

With this in mind a study was made of the sequences of degeneration and regeneration of arterial walls in normal rabbits.<sup>1, 2</sup> The walls of arteries were devitalized *in situ* by transmural freezing. The cells of the vascular wall promptly succumbed and disappeared by lysis without exciting an infiltration of inflammatory cells. Anatomical continuity of the residual fibroelastic framework of the frozen vascular segment persisted. Immediately following mural devitalization in continuity, intimal regeneration became apparent. The progressive proliferation and differentiation of intimal cells continued until, under perfect conditions, a new vascular wall was constructed within the degenerate shell of the once-frozen vascular segment. Within the degenerate mural shell, represented mostly by residual fibroelastic medial structure, there was little regenerative activity. Calcium salts accumulated and as a rule were slowly resorbed or converted into bone. The residual collagen became hyalinized and the residual elastic tissue became hyalin, calcified, and fragmented. These processes had many features in common with those found in human arteriosclerosis. The principal difference was the absence of large accumulations of lipids in the degenerate media or proliferated fibroelastic intimal structure of the experimental lesions.

Therefore, the same experiment was done in rabbits made hypercholesterolemic by dietary methods.<sup>3</sup> This experiment showed that the sites of medial degeneration and intimal proliferation became elective sites for atheromatous localization. The lipid localization was more conspicuous in the fibroelastic plaques of regenerated aortic intima than in similar plaques in iliac or renal arteries. Lipid localization in the degenerate media was conspicuous only in extra-aortic arterial walls, more so in renal than iliac arteries. The tendency for atheromatous localization to occur in the proliferating intima of the aorta rather than that of renal and iliac arteries was in keeping with the natural tendency for atheromatous plaques to develop in "normal" aortic intima of hypercholesterolemic rabbits. The tendency for atheromatous localization to occur in the degenerate media of the renal and iliac arteries was in keeping with the natural tendency for medial degeneration to develop in the coronary arteries rather than the aorta in the control hypercholesterolemic rabbits. It seemed that the medial atheromatous localization in muscular arteries was related in some way to the occurrence of imperfections in

the internal elastic membrane of the devitalized arterial wall. Multiple concentric elastic membranes of the aortic wall seemed to act as a barrier to atheromatous localization in the media.

The accumulation of lipids in the lesions was accompanied by inhibition of the processes of repair as well as distortion of the usual regular pattern of structural arrangement, especially of regenerating intima. Furthermore, hyalin and mucinous degeneration of the newly deposited connective tissue stroma frequently occurred in association with atheromatous deposits, especially in the regenerated intima of old animals.

This combination of complex vascular disease involving active medial degeneration, fibroelastic intimal regeneration, and atheromatous localization simulated the varied aspects of human senile athero-arteriosclerosis much more closely than did the simple atheromatous intimal disease of hypercholesterolemic rabbits. The experimental findings therefore indicated that imperfections in the media are important in arteriosclerosis. These imperfections may lead to fibroelastic intimal proliferation, fibrosis of the media, and medial calcification in normocholesterolemic animals. In the presence of an elevated blood cholesterol, the zone of fibroelastic intimal proliferation and the degenerate media of muscular arteries become elective sites for lipid accumulation and stromal degenerative changes without persistent calcification.

The question arises whether primary medial disease in the human initiates a similar sequence of events. The study of miscellaneous diseases of arteries indicates that the reaction of the human vascular wall in the presence of primary medial disease is similar to that of the experimental animal. The well-known results of aortitis and arteritis due to infectious agents, allergic reactions, and other causes support this conclusion. However, the nature of chronic noninflammatory progressive medial disease characterized by atrophy of smooth muscle, interstitial fibrosis, and defections in elastic tissue is still a mystery. We associate these changes with the aging process, which in itself is no explanation. As this process exerts its influence, intimal proliferative reactions accompany it and seem to be secondary to the intramural degenerative changes. Nor can the adventitia be excluded from consideration, because changes in the adventitia may lead to medial and intimal changes. Again, this shows that imperfections in any part of the vascular wall may initiate a progression of one or another of the pathologic sequences of arteriosclerosis.

#### *Etiology of Mural Changes in Human and Experimental Arteriosclerosis*

The previous discussion has been concerned with the sequences in arteriosclerotic processes. It was implied that these sequences may be initiated or aggravated by many causes. Local trauma is at times sufficient to induce local arteriosclerotic changes. Also, it is possible to follow the sequences of arteriosclerosis as a result of inflammation of vascular walls. These inflammatory reactions may have diverse causes such as localization of infectious agents, bacterial toxins, or allergic reactions. Prolonged hypertension contributes to the development of arteriosclerosis. This is apparent in the systemic circulation but is especially impressive when hypertension involves the pulmonary arterial system. There is experimental and other evidence that excesses of certain hormones such as parathormone, adrenalin, and stilbestrol may either cause or accelerate the development of arteriosclerosis. Excesses of vitamins A and D as well as deficiencies of pyridoxine and vitamin E may lead to special forms of arteriosclerosis. Arterioscle-

rotic changes may also follow the use of diets containing an excess of lipids or of cholesterol.

Other direct or contributing causes might be added. The ones mentioned are sufficiently diverse to support the belief that almost anything which is capable of producing degenerative or proliferative changes in arterial walls may cause one or another form of arteriosclerosis. Indeed, a most interesting form of arteriosclerosis follows the reduction of flow of blood as the result of a decrease in peripheral circulatory demand. This is especially conspicuous in uterine arteries during involution of the youthful uterus following a full-term pregnancy.

Despite the proof that there are many potential causes of arteriosclerosis, there are perhaps three factors which deserve special consideration. These factors are first, the aging process; second, hypertension; and third, the lipid composition of the blood plasma.

It is hardly necessary to mention the aging process as a factor in arteriosclerosis. It seems self-evident. Arteriosclerosis in its common form begins in childhood and progresses throughout life, more rapidly in some than others. No one of advanced years escapes the disease. Still, the fundamental changes which are recognized as a part of the aging process are a mystery. Microscopically, these changes are best detected in the intercellular tissues of the body, especially those which are at a considerable distance from a blood supply. This is true of the principal fibroelastic framework of the arterial wall. The maintenance of this framework and the enclosed cells depends upon acquisition of necessary nutrients and elimination of metabolites by diffusion over relatively long distances. It may be that the aging of these supporting tissues limits the process of diffusion. This idea fits the observations better than any other. According to this idea, gradual decay of the media is due to limitation of diffusion caused by changes in the interstitial tissues. The medial degeneration then becomes primary to the proliferative and degenerative sequences characteristic of senile arteriosclerosis. But it is clear that medial degeneration alone does not always lead to these characteristic sequences. Otherwise, certain destructive medial changes such as those occurring in primary vascular amyloidosis should be accompanied by other severe arteriosclerotic changes which, in our experience, do not develop, despite the chronicity and completeness of medial degeneration. Furthermore, there is no entirely consistent correlation between medial degeneration and intimal reactions in any form of human vascular disease. In this connection, it is to be emphasized that age alone, at least in experiments with rabbits, is not a factor of primary importance in the development of the degenerative and regenerative vascular lesions which we have studied.<sup>2, 3</sup>

Profound physical changes, however, invariably occur in aging human arterial walls. The resultant inelastic, rigid, tortuous, and often dilated arteries led many to conclude that one basic effect of the aging process was to reduce the elasticity of elastic tissue. Our studies have shown that the elastic tissue networks of aged vessels when isolated in pure form have the same elasticity as elastic tissue of infantile vessels.<sup>4, 5</sup> Age leads to a reduction in tensile strength due to transverse fractures of elastic networks. It does not affect the property of elasticity, but the discontinuities in aged elastic tissue decrease the effective amount of elastic tissue. This leads to gradual dilatation and elongation of the artery. The progressive accumulation of fibrous tissue then splints the elastic tissue in an overextended state. When this fibrous tissue is extracted by chemical methods, the

elastic tissue retracts and the vessel returns to its normal youthful dimensions.<sup>5</sup> The means by which the aging process leads to discontinuities in elastic tissue is the important problem here.

There is good evidence that hypertension favors the development of arteriosclerosis. As a rule, the higher the diastolic pressure, the more severe the vascular disease, especially in small arteries and arterioles. Some believe that sclerosis of arteries and arterioles precedes hypertension. This opinion is apparently justified in certain cases. It is often difficult to determine cause and effect in other cases, especially when the systemic arterial system is involved. However, the cause-and-effect relationships are clear when pulmonary hypertension in young people with mitral stenosis definitely leads to classical severe pulmonary arteriosclerosis.

The mechanism by which intravascular hypertension causes or accelerates the development of arteriosclerosis is unknown. It seems that the increased tension excites a reaction of the tissues of the vascular wall to undue stresses which it was not initially designed to withstand. This imbalance between structure and stress often arises in consideration of factors, especially local ones, which govern the development of arteriosclerosis. If this imbalance is important, the mechanism by which proliferative and degenerative vascular reactions are mediated by the imbalance is also important. Nothing is known about this, but with hypertension the sequences and character of the reactions in large arteries are essentially the same as those which occur in the absence of hypertension. It should be remembered, however, that hypertension is a relative term. We should not think of hypertension as an arbitrary range of elevated blood pressure. *We should regard hypertension as a range of blood pressure which is elevated with respect to the tolerances of different segments of normal and abnormal vascular walls. The vascular wall and not the mercury manometer is the critical judge of hypertension.*

The idea that the quantity and physical state of plasma lipids are important causes of arteriosclerosis is attracting attention today. Deposits of lipids, rich in cholesterol, appear at about ten years of age in the intima of the human aorta. These fatty plaques may gradually enlarge and coalesce with advancing years or undergo degeneration and resorption. Some believe that the sequences of regenerative and degenerative arteriosclerotic changes are initiated by the effects produced by these lipid deposits in the intima.

The principal argument among pathologists is whether the fatty deposits are primary or secondary events in the development of arteriosclerosis. The discovery that rabbits, maintained on a diet rich in cholesterol, developed severe atherosclerosis gave impetus to the idea that hypercholesterolemia alone was responsible. The development and regression of these plaques was studied in the experimental animal but the full picture of human disease, especially the intimal proliferative and medial degenerative aspects, was not encountered. In order to obtain these effects, it was necessary to produce some experimental imperfection in the arterial wall. Once this was done, the lesions resembled those commonly found in human arteriosclerosis.<sup>3</sup> Localization of lipids at sites of medial injury and intimal proliferation was demonstrated. The findings seemed to favor the concept of a secondary but nevertheless important role for the lipids.

Meanwhile, it was shown that certain protein-lipid complexes could be isolated from animal and human plasma by centrifugation. These fractions had certain sedimentation constants. Then, lipoprotein complexes with characteristic physical properties were found in the plasma of hypercholesterolemic rabbits and humans with severe arterio-

sclerosis. The amount of the lipoprotein which was found was not related quantitatively to the level of the plasma cholesterol. Emphasis was then placed upon the idea that abnormal plasma lipoprotein complexes represented a deviation in metabolism manifested by the production of chemical compounds which circulated in the blood, accumulated in the intima of arteries, and initiated arteriosclerotic sequences. This is a very attractive theory which is yet to be fully judged, as evidence for and against it slowly accumulates. In view of the over-all picture of human and experimental arteriosclerosis, it is doubtful that any single cause or aggravating factor will be sufficient to explain the complexities of the process.

#### CONCLUSIONS

The principal structural changes encountered in the common forms of senile human arteriosclerosis can be reproduced in the experimental animal. The most satisfactory reproduction requires the induction of hypercholesterolemia in animals with defects in the vascular wall that lead to active medial degeneration and intimal proliferation. It may be concluded from the observations that further approach to an understanding of the human disease by use of experimental animals might profitably involve a study of vascular degenerative and reparative sequences in the presence of appropriate dynamic and chemical imbalances between the vascular wall and its immediate environment.

#### REFERENCES

1. Taylor, C. B., Baldwin, D., and Hass, G. M.: Localized Arteriosclerotic Lesions Induced in the Juvenile Rabbit by Freezing, *Arch. Path.* 49: 623-640, 1950.
2. Baldwin, D., Taylor, C. B., and Hass, G. M.: A Comparison of Arteriosclerotic Lesions Produced in Young and Old Rabbits by Freezing the Aorta, *Arch. Path.* 50: 122-131, 1950.
3. Kelly, F. B., Jr., Taylor, C. B., and Hass, G. M.: Experimental Athero-arteriosclerosis. Localization of Lipids in Experimental Arterial Lesions of Rabbits with Hypercholesterolemia, *Arch. Path.* 53: 419-436, 1952.
4. Hass, G. M.: Description of a Method for Isolation of Elastic Tissue, *Arch. Path.* 34: 807-819, 1942.
5. Hass, G. M.: Relation Between Structure of the Ageing Aorta and Properties of Isolated Aortic Elastic Tissue, *Arch. Path.* 35: 19-45, 1943.

#### DISCUSSION

*Dr. Waters* asked what percentage of the lesions progressed to true atheroma formation and degeneration, with inflammation comparable to the late stages of human atherosclerosis.

*Dr. Taylor* replied that in experimental animals followed up to one year there was no breakdown or ulceration.

*Dr. Waters* asked whether many lesions regressed, following deletion of the lipid from the diet, with subsequent scar formation.

*Dr. Taylor* replied that none of the hypercholesterolemic animals had been taken off the experimental diet.

*Dr. Katz* referred to *Dr. Hass'* concept of aging and pointed out that chickens on 2% cholesterol for about two years developed an increased incidence of atherosclerosis up to the end of the second month, but that subsequently the rate leveled off; it began to diminish at about the end of the first year and continued to do so during the second year.

He felt that the factor of elimination of susceptibles should be considered as well as

progressive changes with age, and that the concept should include both local and cholesterolemic factors.

*Dr. Taylor* pointed out that *Dr. Hass* had emphasized the development of breaks in elastic lamellas as being a subtle manifestation of injury whether caused by chemical agents, by bacterial toxins, or by a general process of aging; that it constituted a form of degeneration of the media.

*Dr. Winternitz* recommended adoption of a holistic viewpoint in which age would not be considered apart from the organism as a whole.

## FUNCTIONAL ANATOMY OF THE BLOOD VESSEL WALL; ADAPTIVE CHANGES

G. LYMAN DUFF

Adaptation implies the development of advantageous modifications of structure or function that occur in organisms in response to altered conditions. The idea of usefulness is inherent in the term, but adaptive changes that are initially favourable to survival of the organism may overreach their purpose or create a situation that predisposes to disease. Adaptation may be phylogenetic or ontogenetic. Most of the examples that I shall deal with fall into the latter group, and have been selected because of their relevance in one way or another to arterial disease.

It is a feature of the gross anatomy of arteries, not generally recognized, that at points of bifurcation, just before the division into two branches occurs, the lumen of the parent artery tends to widen materially. It has been pointed out repeatedly that points of arterial bifurcation are especially prone to the development of atherosclerosis, and this has been attributed to extra strain at these points, but the exact mechanism has never been explained. Burton<sup>1</sup> has shown that the tension in the walls of arteries can be calculated as though they were cylinders containing fluid under pressure. The pressure acts equally in all directions on equal areas but the stretching force on the curved walls that would tend to create a longitudinal tear is shown by the application of the law of Laplace to be in direct proportion to the radius of the cylinder. It follows that in a blood vessel of variable calibre filled with blood under constant pressure the tension or stretching force in the wall is greater in the wider parts of the vessel than in the narrower parts. If the wider part of an artery is not equipped with a thicker, stronger wall than the rest, the wide area is bound to stretch and dilate more than the remainder and, incidentally, thus to increase the stretching force that acts upon it. The widening of the lumen that occurs in arteries just proximal to bifurcations is not protected by a corresponding thickening of the media, and hence these widened areas are subject to pulsatile stretching of greater extent than that which occurs just above the widened area or just below the bifurcation. This and other applications of Laplace's law to arteries have been recently elaborated by Willis.<sup>2</sup>

It seems probable that the predilection of arterial bifurcations for the development of atherosclerosis is dependent on the increased stretching forces that act on the walls in such areas, but it is still not clear how these forces are effective. Is the increased pulsatile stretching tantamount to an injury? Or does it encourage the freer infiltration of fluid from the lumen through the wall in these areas? Perhaps compensation for the relative weakness of the wall is attempted by adaptive thickening of the intima in which atherosclerotic changes occur as a secondary phenomenon. These questions merit further investigation.

There are various examples of adaptive thickening of the intima of arteries but they seem to be associated with rather diverse conditions. It has long been recognized that the intimal layer of the coronary arteries is thicker than that of most other vessels of the same size and that areas of irregular thickening are present even in infancy, becoming more prominent with increasing age.<sup>3. 4. 5. 6. 7. 8</sup> The thickness of the intimal coat is re-

garded as a factor predisposing to the development of atherosclerosis in the coronary arteries, as elsewhere. Dock<sup>9</sup> states that a similar structure is found in arteries such as the occipital and penile which must lengthen or shorten with movements of the body or turgescence,<sup>10</sup> and he regards the intimal thickenings of coronary arteries as being adaptive to the changes in distance between fixed points that occur during the cardiac cycle and to which the epicardial branches of the coronary arteries must accommodate themselves.

It is difficult to understand why intimal thickening would be particularly advantageous in these circumstances, and Hall's suggestion<sup>11</sup> that it is due to the relatively high blood pressure in the coronary arteries seems to be more logical. Consistent with this idea are the observations of Zinck<sup>12</sup> and of Lack<sup>13</sup> who found that the intimal thickenings are confined in infancy to points of branching of the coronary arteries, tapering off immediately above and below these levels. It is in these areas, where the arteries widen before branching, that high intra-arterial pressure would be expected first to show its effects, for reasons already pointed out. On the other hand, the finding of lipid deposits in the coronary intimal cushions in newborn infants led Fangman and Hellwig<sup>14</sup> to conclude that they were pathological lesions representing the earliest stages of coronary atherosclerosis. Regardless of interpretation, all of those who have studied the sex incidence of coronary intimal thickenings in infancy<sup>9, 14, 15</sup> support the conclusion that they are of more frequent occurrence and thicker in male than in female infants, as pointed out by Dock<sup>9</sup> who believed that this fact established the basis for the sex difference in the incidence of coronary occlusion in later life. Moreover, it is agreed that the intimal thickenings occur more frequently and earlier in the left coronary artery, particularly in its anterior descending branch, than in the right coronary.<sup>4, 6, 14</sup>

The histological changes that are found in the coronary arteries of infants and young children have been described by a number of investigators without substantial disagreement.<sup>3, 4, 5, 6, 12, 14, 15</sup> The normal parts of the artery show an endothelial lining that lies almost directly on an intact single-layered internal elastic lamina. The first changes consist of splitting of the internal elastic membrane and the intrusion of muscle fibres between the layers to form the so-called musculo-elastic layer. Further fragmentation of the internal elastic layers is followed by the formation of musculo-elastic hyperplastic cushions that push into the intimal layer and distort the smooth outline of the lumen. All semblance of an internal elastic membrane may ultimately disappear. The most superficial parts of the intimal thickenings show an increasing preponderance of fibrillar collagenous connective tissue mixed with delicate elastic fibres forming the so-called elastic-hyperplastic layer. All of these changes may be encountered in newborn infants, but the plaques increase in number and size during infancy and childhood. As age advances the intimal thickenings gradually lose their muscle and elastic fibres and become more densely collagenous, more extensive, and more smoothly concentric in arrangement. Small deposits of lipid material may be present in the intimal plaques even at birth, sudanophilic material being distributed diffusely along the elastic fibres and in the stroma and contained sometimes in large histiocytes.<sup>14</sup> These lipid deposits tend to increase and they become evident in adolescence or early adult life as grossly visible fatty flecks and streaks.

There are other examples of adaptive changes in arteries that affect principally the intimal layer and may lead to obliteration of the lumen, but are adaptations to the di-



minution or cessation of blood flow through the vessel. Such changes are seen in the ductus arteriosus and in the umbilical arteries.

Little has been written in recent years about the process of obliteration of the ductus arteriosus, but Jager and Wollenman<sup>16</sup> have reviewed the literature up to 1942 and have described and illustrated their own observations on 71 specimens. The ductus arteriosus in the human foetus of from 5 cm. to 10 cm. in length has the typical structure of an artery but has less elastic tissue and a looser architecture than either the pulmonary artery or aorta. This continues to be true throughout the remainder of intrauterine life and in postnatal life as well. In the 10-cm. foetus the ductus has a well-defined internal elastic membrane lying just beneath the endothelial lining. The innermost part of the media is composed of muscle fibres which are longitudinally disposed or arranged in long spirals, but the greater part of the thickness of the media is made up of muscle fibres in circumferential arrangement. Delicate wavy elastic fibrils course between the muscle bundles. There is no external elastic lamina and the adventitia, which is poorly demarcated from the media, is made up of collagen with only a few elastic fibrils.

In 23-cm. to 28-cm. foetuses, changes are found in the intimal layer. At various points around the circumference of the vessel, the internal elastic lamina is split into layers or fragmented, and at these points the intima is thickened by mounds of longitudinal muscle fibres mixed with delicate elastic fibrils which seem to spring from the reduplicated internal elastic membrane. These areas of musculo-elastic hyperplasia increase only gradually in size and number up to full term.

After birth the intimal mounds continue to enlarge. They gradually become richer in collagen and frequently show subendothelial caps of loose connective tissue which assist in the obliterative process. Anatomical closure is complete in most instances within the first 3 to 4 weeks of postnatal life. It is usually achieved solely by fusion of the enlarging intimal mounds without thrombosis, but thrombosis does occasionally occur. During and subsequent to the process of obliteration, the intima becomes richer in elastic tissue and the media richer in elastic tissue and collagen. In older age groups, the obliterated ductus is represented by a dense cord of collagen and elastic tissue with only a few remaining muscle fibres. It may be the seat of hyalinization, calcification and even cartilage formation. It is well known that the scar of the obliterated ductus arteriosus at its aortic end is a site of predilection for the development of atherosclerosis.

Adaptive changes in the umbilical arteries are almost identical with those in the ductus arteriosus.<sup>10, 17</sup> Prior to birth, at several points around the circumference of the arteries, there is reduplication of the internal elastic lamina, which may become so fragmented that its identity as a membrane is completely lost. This is associated with musculo-elastic hyperplasia in the intima, which leads to the formation of mounds or ridges containing longitudinally disposed muscle fibres and variable amounts of elastic tissue. Contraction of the vessel after birth produces a lumen of stellate outline and may be followed by marked degenerative changes in the innermost layers of the media including oedematous swelling and loosening of the structure and even necrosis. As in the ductus arteriosus, loose collagenous connective tissue proliferates in the superficial layers of the intimal ridges and leads either to complete anatomical closure or to extreme narrowing of the lumen. Around this tiny lumen, if one persists, new elastic fibres and even muscle fibres are eventually formed to produce a new and much smaller artery which lies entirely within the original lumen of the first.<sup>17</sup>

A very similar succession of events is observed in adult arteries that have lost temporarily or permanently their full functional utility as, for example, the uterine arteries during the postpartum period, the cortical ovarian arteries in postmenopausal women, and the arteries supplying organs removed surgically, if these vessels are not obliterated by thrombosis with subsequent organization.<sup>10, 18</sup> Similar results can also be produced experimentally by great restriction of blood flow through segments of arteries.<sup>10, 18</sup> One has the impression, however, that in adult subjects, while splitting and reduplication of the internal elastic membrane occurs, intimal proliferation is predominantly fibrous. New elastic fibres are not produced in such abundance, and muscle fibres proliferate in the intima much less freely than in the foetus or newborn infant. Moritz<sup>18</sup> suggests that the obliterative changes in the medium and small intrarenal arteries in chronic Bright's disease in otherwise nonarteriosclerotic persons may be adaptive to a reduction of blood flow through the kidneys.

The cerebral arteries, both in their gross and microscopic anatomy, offer extraordinary illustrations of phylogenetic adaptation. There is no better example of a peculiar arrangement of arteries apparently designed to ensure a continuing blood supply to a special organ than that displayed at the base of the brain in the formation of an anastomosing system of vessels fed by four main trunks and intimately connected by the basilar artery and the vessels that form the circle of Willis. However, defects in the circle of Willis are very frequent, consisting most often of the congenital narrowness or absence of one or both of the posterior communicating arteries. Such defects have no great significance so long as the existing arteries maintain their original size of lumen, but Saphir<sup>19</sup> has placed significance upon anomalies of the circle of Willis, when they are associated with atherosclerotic narrowing of the vessels, in relation to cerebral softening or haemorrhage. This view finds support in the observations of Fetterman and Moran<sup>20</sup> who found the incidence of otherwise unexplained softenings of the brain to be much higher in persons with anomalies of the circle of Willis than in those with the normal arrangement of the arteries at the base of the brain.

The histological structure of the cerebral arteries<sup>10, 21, 22</sup> is also peculiar in that almost all of the elastic tissue in the vessel walls is concentrated in an unusually thick internal elastic membrane. The media is somewhat thinner than in other arteries of the same size and contains only a few very delicate elastic fibrils. There is no external elastic lamina. The adventitia is very poorly developed, consisting of a thin layer of loose collagenous tissue with only a few elastic fibres. Even before adult age is reached, the internal elastic membrane begins to show splits here and there and, as age advances, it shows an increasing tendency to become reduplicated, especially at or near points of branching. In other places it remains in a single layer but takes on a straight, stiff, brittle appearance and may present points of rupture in apparently random distribution in the larger arteries at the base of the brain even at a relatively early age. Changes of aging in the media consist of the gradual loss of the few elastic fibres and an increase of collagenous tissue at the expense of the medial muscle fibres. In the small cortical ramifications of the cerebral arteries the muscle becomes completely replaced by collagen.<sup>22</sup>

Benninghoff<sup>10</sup> points out that the structure of the cerebral arteries places the greatest strength in the inner layers. He regards this as an adaptation to the obvious requirement of resisting the blood pressure within the lumen and to the absence of any need for pro-

tection of the cerebral arteries against external stresses because of their relative immobility and shielded position within the cranial cavity.

In most arteries, situations do not spontaneously arise in which it is possible to assess the relative importance of different components of the vessel wall in resisting the distending effect of the blood pressure. The not infrequent occurrence of noninflammatory aneurysms of the cerebral arteries, especially around the circle of Willis, has been attributed by Forbus<sup>23</sup> to the occurrence of congenital defects in the muscle of the media, which are particularly frequent at the acute angles between branching vessels where the aneurysms are most commonly located. This view of the pathogenesis of cerebral aneurysms, which seems to place the main strength of the cerebral arterial walls in the muscle of the media, is challenged by Glynn,<sup>24</sup> who has demonstrated experimentally that the internal elastic membrane alone and without the support of the layers external to it can withstand an intra-arterial pressure far in excess of the highest levels of blood pressure ever recorded clinically. However, Glynn seems to lose sight of the fact that Forbus himself regarded disintegration of the internal elastic lamina covering a gap in the muscle of the media as an essential step in the formation of an aneurysm. Carmichael<sup>25, 26</sup> has demonstrated that the integrity of either the muscular media or the internal elastic membrane is sufficient to prevent the formation of aneurysms, though minute localized distensions may occur in the presence of an intact elastic membrane. He regards developmental deficiency in the muscular media as the essential basic lesion. The additional occurrence of a gap in the internal elastic membrane in the same area due to degenerative changes permits the development of the typical cerebral aneurysm.

The heavy internal elastic membrane of the cerebral arteries has its importance in relation to atherosclerosis as well. So long as the elastic membrane remains intact, atherosclerosis of the cerebral arteries is rather sharply limited to the intimal layer. But breaks in the membrane, while they may occur elsewhere, are especially frequent beneath atherosclerotic lesions in the intima. Initially, there is not so much a general disintegration of the elastica as the occurrence of one or more discrete ruptures. Through such holes the atheromatous contents of the lesion are squeezed out into the media in which an expanding pocket is formed, occupying on occasion almost the whole thickness of the medial coat. This peculiar "hour-glass" lesion I have never seen in other than cerebral arteries and its occurrence there seems to be properly attributable to the unusual thickness and strength of the internal elastic membrane, to its tendency to rupture rather than to disintegrate and to the paucity of elastic tissue in the media. When many points of rupture of the internal elastic membrane are present (and their number and size can only be revealed by serial sections) the media becomes extensively occupied and gradually destroyed by lipid material that spreads freely in all directions and penetrates as far as the adventitia. The apparent ease with which this penetration of the media occurs, once the internal elastic membrane is breached, accounts for the exceptionally prominent yellow appearance of large atherosclerotic lesions of cerebral arteries when they are viewed from their adventitial aspect. All of these degenerative processes reach their most pronounced development in the basilar artery and it is not surprising, therefore, that atherosclerotic aneurysms are most frequent there.

Finally, I propose to describe certain changes that occur in the lining endothelium of human arteries, partly because the observations are new but also because the alterations may well be adaptive.

Histological sections of arteries prepared in the conventional way as cross sections of the vessel walls are extraordinarily ill suited to the study of their lining endothelial membrane. In such sections only the cut edges of the cells composing it are presented for examination and the observations are limited to two dimensions, one of which is the shortest possible. Dr. Lautsch, Dr. McMillan, and I have borrowed a method originally devised by O'Neill for the observation of the lining endothelium of veins and have adapted it to the study of the endothelial membrane and the subendothelial tissue of arteries.<sup>27</sup> By this method large segments of arteries can be mounted with the intimal surface facing upward, under coverslips on glass slides. Large areas of the stained endothelium and intima can thus be examined from the surface under the microscope with any magnification up to the highest. The endothelial cells are outlined by impregnation of their intercellular cement substance with silver. Nuclear stains and other stains (to demonstrate lipids, for example) can be added.

In such preparations the normal endothelial cells are seen as large polygonal cells of extreme thinness that are slightly elongated in the direction of the long axis of the artery. Dr. Elizabeth Lautsch and Dr. Neil Rota, working in my laboratory, have found that the pattern of arrangement of the endothelial cells is very uniform and regular in the arteries of infants, though an occasional binucleate cell may be encountered. However, by the age of 8 years microscopic areas of irregularity in the cell pattern have developed in the lining endothelium of the aorta. Our material up to the present does not include specimens representing the second decade of life, but in the third decade widespread aberrations in the endothelial cell pattern and interesting alterations in individual cells are already well established.

In a female, 23 years of age, the youngest of our adult subjects, the aorta presented many areas of varying size in which the endothelial pattern was markedly disturbed. These areas were larger and more numerous in the thoracic aorta than in its abdominal portion. In such places, groups of endothelial cells had lost their elongated shape and had become more or less symmetrically polygonal in outline by increasing their width rather than losing in length. Not only was the longitudinal orientation lost, but the changes in shape and increase in size of the cells were very irregular and variable from one microscopic field to another. Within these areas certain cells or groups of cells showed greater increase in size than the rest and contained multiple nuclei varying in number from 2 to 15 or more. There was a rough direct correlation between cell size and the number of nuclei. The multiple nuclei tended to be grouped, sometimes in rosette-like arrangement, near the centres of these giant endothelial cells. In these central areas the cells were distinctly thicker than normal. Identical changes, though of lesser degree than in the aorta, were found in the lining endothelium of the coronary arteries, the common carotid arteries, the intracranial portions of the vertebral arteries, the basilar artery, the renal arteries, the common and external iliac arteries, the pulmonary artery, and the inferior vena cava—that is, in all of the vessels that were examined. The changes were most marked in the vessels of largest size and less pronounced in arteries of smaller calibre.

In the older subjects that we have examined, ranging up to 90 years of age, the endothelial alterations became gradually more marked and more extensive up to about age 60, after which little further change was noticeable. Though areas of endothelial alteration sometimes coincided with atherosclerotic lesions in the underlying intima, there was

no constant association between the two. We have no evidence up to the present time to indicate that the endothelial changes have any significance in relation to atherosclerosis.

The large endothelial cells show no sign of degenerative changes. They do not accumulate lipids or other visible intracellular materials. The nuclei, even when multiple, are clearly outlined, with well-preserved chromatin patterns. Mitotic figures are found only occasionally in normal lining endothelial cells, but we have yet to observe a single one in a multinucleated endothelial cell. On the other hand, some of the largest giant cells contain not only one group of nuclei but two or three separate groups placed in such a way as to suggest the fusion of adjacent multinucleated cells.

The more extensive distribution of advanced endothelial alterations in the thoracic aorta as compared with the abdominal aorta, and in large vessels as compared with smaller ones, suggests an adaptation to some factor connected with the size of arteries. Whether the formation of large endothelial cells is a response to the growth or gradual dilatation of arteries with age, whether it is a reaction to pulsatile distension and stretching most marked in the large arteries that are most directly exposed to the systolic thrust of the heart, or whether it is due to some other unsuspected factor, we are unable to say.

## REFERENCES

1. Burton, A. C.: On the physical equilibrium of small blood vessels, *Am. J. Physiol.* 164: 319, 1951.
2. Willis, G. C.: Localizing factors in atherosclerosis, *Canad. M. A. J.* 70: 1, 1954.
3. Wolkoff, K.: Über die histologische Struktur der Coronararterien der Menschenherzens, *Virchows Arch. f. path. Anat.* 241: 42, 1923.
4. Ehrlich, W., de la Chappelle, C. E., and Cohn, A. E.: Anatomical Ontogeny. B. Man. 1. A study of the coronary arteries. *Am. J. Anat.* 49: 241, 1931.
5. Spalteholz, W. and Hochrein, M.: Untersuchungen am Koronarsystem: Die anatomische und funktionelle Beschaffenheit der Koronararterienwand, *Arch. f. exper. Path. u. Pharmakol.* 163: 333, 1932.
6. Gross, L., Epstein, E. Z., and Kugel, M. A.: Histology of the coronary arteries and their branches in the human heart, *Am. J. Path.* 10: 253, 1934.
7. Sappington, S. W., and Cook, H. S.: Radial artery changes in comparison with those of the coronary and other arteries, *Am. J. M. Sc.* 192: 822, 1936.
8. Sappington, S. W., and Horneff, J. A.: Tibial artery changes in comparison with those of the radial and coronary arteries, *Am. J. M. Sc.* 201: 862, 1941.
9. Dock, W.: The predilection of atherosclerosis for the coronary arteries, *J. A. M. A.* 131: 875, 1946.
10. Benninghoff, A.: Blutgefäße und Herz, in von Möllendorff, W.: *Handbuch der mikroskopischen Anatomie des Menschen*. Bd.VI/I. Berlin, Julius Springer, 1930, pp. 76, 97, 102, 120 and 219.
11. Hall, E. M.: The Heart, Chapt. 19 in Anderson, W. A. D.: *Pathology*, 2nd ed., St. Louis, C. V. Mosby 1953, p. 477.
12. Zinck, K. H.: Sondervorrichtungen an Kranzgefäßen und ihre Beziehung zu Coronarinfarkt und miliaren Nekrosen, *Virchows Arch. f. path. Anat.* 305: 288, 1940.
13. Lack, A. R.: The coronary arteries in the newborn and in childhood. Cited by Hall (11).
14. Fangman, R. J. and Hellwig, C. A.: Histology of coronary arteries in newborn infants, *Am. J. Path.* 23: 901, 1947.
15. Minkowski, W. L.: The coronary arteries of infants, *Am. J. M. Sc.* 214: 623, 1947.
16. Jager, B. V., and Wollenman, O. J.: An anatomical study of the closure of the ductus arteriosus, *Am. J. Path.* 18: 595, 1942.
17. Schallock, G.: Über die Entwicklung und das weitere Schicksal der Nabelarterie. Zugleich ein Beitrag zur Gefäßpathologie. *Virchows Arch. f. path. Anat.* 302: 195, 1938.
18. Moritz, A. R.: The pathogenesis of arterial atrophy, *Am. J. Path.* 17: 597, 1941.
19. Saphir, O.: Anomalies of the circle of Willis with resulting encephalomalacia and cerebral haemorrhage, *Am. J. Path.*, 11: 775, 1935.

20. Fetterman, G. H., and Moran, T. J.: Anomalies of the circle of Willis in relation to cerebral softening, *Arch. Path.* 32: 251, 1941.
21. Cobb, S., and Blain, D.: Arteriosclerosis of the brain and spinal cord. Chapt. 14 in Cowdry, E. V.: *Arteriosclerosis. A survey of the problem.* New York, The Macmillan Co., 1933.
22. Baker, A. B.: Structure of the small cerebral arteries and their changes with age, *Am. J. Path.* 13: 453, 1937.
23. Forbus, W. D.: On the origin of miliary aneurysms of the superficial cerebral arteries, *Bull. Johns Hopkins Hosp.*, 47: 239, 1930.
24. Glynn, L. E.: Medial defects in the circle of Willis and their relation to aneurysm formation, *J. Path. & Bact.* 51: 213, 1940.
25. Carmichael, R.: Gross defects in the muscular and elastic coats of the larger cerebral arteries, *J. Path. & Bact.* 57: 345, 1945.
26. Carmichael, R.: The pathogenesis of non-inflammatory cerebral aneurysms, *J. Path. & Bact.* 62: 1, 1950.
27. Lautsch, E. V., McMillan, G. C., and Duff, G. L.: Technics for the study of the normal and atherosclerotic arterial intima, from its endothelial surface, *Laborat. Invest.* 2: 397, 1953.

### DISCUSSION

*Dr. Page* asked whether the break in the internal elastica initiated the proliferation of the intima.

*Dr. Duff* replied that one could say only that the intimal proliferation is associated with breaks in the internal elastic layer. He believed that the cells in the intima are sensitive to a variety of stimuli, including stretching, and that if the elastica interna is broken the mechanical stimulus may be sufficient to cause proliferation.

*Dr. Waters* pointed out that it is often difficult in arteriosclerosis to tell what is proliferated intima and what is scarred media. Determination of the initial site is complicated by the fact that degeneration and disappearance of the internal elastic lamina is followed by condensation and hypertrophy of successive layers of medial elastica, which now assume the appearance of the original limiting membrane of the intima. In other words, what was originally medial tissue now appears well within the limits of the intima.

*Dr. Duff* agreed that in the elastic type of artery, which has multiple elastic lamina, *complete* destruction of the internal elastic membrane would lead to erroneous identification of the next elastic layer as the internal elastic lamina. He pointed out that this difficulty does not arise in the case of arteries of the muscular type, in which the internal elastic membrane stands alone and is not backed up by other layers of elastic tissue in the media. He considered the internal elastic lamina to be more intimately associated from a functional standpoint with the intima than with the media. However, it lends strength to the arterial wall, which is one of the principal functions of the media, and, apparently for that reason, it has generally been described anatomically as part of the media. He felt that the loss of its integrity played an important role in the development of atherosclerosis.

In response to a question by *Dr. Winternitz*, he stated that cross sections of arteries exhibit only the cut edge of the internal elastic membrane. In thin sections cut parallel with the intimal surface the membrane can be viewed as a flat sheet. It is then seen to be composed of a feltwork of fibrils, many of which are disposed in parallel arrangement in the long axis of the artery. At intervals the fibrils separate around small oval apertures which are spaced widely enough that they constitute only a small proportion of the total area. Everywhere there are individual fibrils that separate themselves from either surface of the membrane and arch away from it like the tendrils of a plant. These form a

loose network and either rejoin the membrane again at a little distance or anastomose with a subjacent elastic membrane when one is present. The fenestrations in the internal elastic membrane are smaller than most of the cells that hold the lipids in the intima in atherosclerosis, and the fact that the lipids are largely contained in cells may block the passage of fat from the intima into the media.

*Dr. Winternitz*, in reply to a question concerning the mechanism of nourishment of the intima in the ductus arteriosus, stated that he had injected specimens of that vessel and had demonstrated extensive vascularization by vasa vasorum.

There followed a discussion of whether obliteration of the ductus arteriosus, vascularization of the vessel wall, and the unusual structure of arteries which change in length are adaptive in nature.

*Dr. Duff* pointed out that since the alteration in structure in the form of thickening of the intima in the coronary arteries of infants and young children was initially localized at points of bifurcation, this structural modification was of no advantage in relation to the necessity for the artery to change its length. He felt that a more plausible explanation was that this structural variation was produced by mechanical stress at the bifurcations as manifested by the disintegration of the internal elastic membrane at those sites.

*Dr. Gross* suggested that the elastic lamina might not be the sole factor in checking the transudation of lipids. He pointed out that diffusion through the cornea, which consists of a thick organized layer of collagen and a negligible amount of elastica, depends upon whether the material is hydrophilic or hydrophobic and upon its electrical charge.

He felt that the discontinuities in the elastic lamina might not be unobstructed apertures, but might be filled with materials which could act as barriers.

*Dr. Lansing* commented that the fenestrations of 10 to 40 micra in the elastic lamina were relatively large, but that between these there were extensive areas which were evidently impermeable. He pointed out that in the glomerulus, the absence of the elastica at the site of the juxtaglomerular apparatus is possibly a functional adaptation which facilitates exchange between the afferent arteriole and the proximal convoluted tubule.

*Dr. Karsner* cautioned against the teleological implications of the term "adaptation," and emphasized that one was justified only in recognizing stimulus and response in the situations discussed. He doubted whether science would be advanced by teleological interpretations. He expressed keen interest in the studies of *Dr. Duff* on the proliferation of endothelial cells. Although the latter had conservatively disclaimed any relation between that phenomenon and the development of arteriosclerosis, *Dr. Karsner* felt that his demonstration that these cells were not foam cells might be significant.

## THE LIPID AND PROTEIN CONTENT OF TISSUE FLUID IN NORMAL AND HYPERLIPEMIC RABBITS\*

AARON KELLNER

The anatomical lesions of atherosclerosis appear to be due primarily to the deposition of lipids within the intima of blood vessels<sup>1, 2</sup> and the evidence at hand indicates that the lipids so deposited are derived mainly, if not exclusively, from the circulating blood plasma.<sup>2</sup> Since the atherosclerotic plaque is situated within the wall of the blood vessel, and since there is no evidence that antecedent damage to the overlying endothelium is necessary for the initiation of atherosclerosis, it follows that the lipids involved in the process must have crossed a presumably intact endothelial membrane, either that of the vessel itself or that of one of its vasa vasorum, and thus passed out of the blood stream into the tissue spaces of the artery wall. The studies now to be described were done in order to determine whether the intact endothelium is in fact permeable to lipid substances and to learn more about the lipid and protein content of the extracellular or tissue fluid.

### *Materials and Methods*

For such a study it would be desirable ideally to enter the tissue spaces directly and to obtain sufficient quantities of uncontaminated tissue fluid for chemical examination. Unfortunately, this was not technically feasible. It was possible, however, to obtain pure tissue lymph, the composition of which is a close approximation of, if not entirely identical with, the fluid of the extracellular tissue spaces. For this purpose a technique was devised for cannulating a subcutaneous lymphatic of the lower leg of rabbits. The details of the procedure in brief are as follows: the animal was anesthetized lightly by an intravenous injection of Nembutal and tied in the prone position to an animal board. A longitudinal incision was made in the skin of the posterior aspect of the leg just below the popliteal space, and the loose subcutaneous tissues overlying the leg muscles exposed. 0.1 to 0.2 cc. of a dilute methylene blue solution was then injected into the soft tissues of the heel, and within a few seconds after such an injection the subcutaneous lymphatics were clearly visible as delicate blue-stained channels. One of these lymphatics was carefully cannulated, using a bent 27-gauge needle to which was attached a nylon adaptor or a polyethylene catheter to conduct the lymphatic fluid to a small glass test tube. Since lymph flows sluggishly or not at all unless there is muscular activity, the foot was flexed gently to and fro continuously following cannulation. To prevent clotting of the lymph within the needle or tubing, these were rinsed with heparin just prior to use. It was possible by means of this technique to obtain quite regularly 0.5 to 2.5 cc. of tissue lymph within a period of 20 to 60 minutes. The skin incision was closed with metal clips following the procedure, and it was possible in many cases to use the same leg for two or three successive cannulations. The fluid obtained was almost always crystal clear, though colored slightly by the dye used to identify the lymph channels. The lymph fluid usually contained a small number of red blood cells which were removed by centrifugation; it is

\* These studies were supported by grants from the U. S. Public Health Service and the New York Heart Association. The valuable assistance of Dr. D. C. Dju Chang, Miss M. Kalberman, and Mrs. H. Ackerman in their development is gratefully acknowledged.



of interest that white blood cells were conspicuously scarce. It should be emphasized that the fluid obtained from subcutaneous lymphatics as herein described is quite different in its lipid and protein composition from the fluid obtained by cannulation of the thoracic duct, the commonly employed procedure for the study of lymph, for the latter fluid contains not only a substantial amount of lipid absorbed from the gastrointestinal tract, but also considerable lipid and other material derived from the liver and other organs. To eliminate these extraneous sources of lipids, the subcutaneous lymphatic was entered low in the leg, below the point where it traversed the first lymph node. The composition of the fluid obtained from such a lymphatic is, according to Drinker,<sup>2</sup> practically identical with that of extracellular or tissue fluid.

The animals employed in these studies were healthy, market-bought rabbits of both sexes and of mixed breeds, weighing between 2.0 and 3.5 kilograms. Tissue lymph and blood serum, collected at the same time, were obtained from a large number of normal rabbits and also from rabbits rendered hyperlipemic by cholesterol feeding, by the intravenous injection of the surface-active agent Triton A-20,<sup>4</sup> and by the injection of alloxan. In each case, the lipid composition of the serum and the lymphatic fluid was determined chemically, and the protein and lipoprotein composition by means of filter paper electrophoresis. Total lipid was determined by the lipid carbon method of Van Slyke and Folch,<sup>5</sup> cholesterol by a modification of the method of Schoenheimer and Sperry,<sup>6</sup> and lipid phosphorus by the procedure of Fiske and SubbaRow.<sup>7</sup> The electrophoretic studies were carried out in an apparatus similar to that described by Flynn and DeMayo.<sup>8</sup> The filter paper strips were stained for protein with bromphenol blue or naphthalene black 12B-200, and a modification of the method of Durrum, Paul, and Smith,<sup>9</sup> using oil red-O, was used for analysis of lipids. The concentration of dye in the filter paper strips was measured either by elution or by the use of an Elphor densitometer.\*

#### *Experimental Findings*

The protein and lipid content of blood serum and tissue lymph obtained from 19 normal rabbits is shown in table I. Tissue lymph was found, in general, to have a protein concentration equal to one third to one half that of the blood serum. Moreover, electrophoretic analysis of the tissue lymph revealed a pattern essentially the same as that of the serum and containing proportionate amounts of albumin and alpha and beta globulin, though somewhat less gamma globulin. A typical example is illustrated in figure 1. In a number of instances the alpha-1 and alpha-2 and occasionally also the beta-1 and beta-2 peaks were readily separable on the electrophoretic pattern; they were not considered separately, however, in computing the quantitative distribution shown in table I. It is of interest that significant amounts of such a large molecular substance as fibrinogen were regularly present in the tissue lymph. The total lipid content of the tissue lymph was also regularly about one third to one half that of the blood serum, and the major lipid fractions, cholesterol and phospholipid, were present in the tissue lymph in about the same proportion. The electrophoretic data for the distribution of the lipids indicate that in the case of both the serum and the tissue lymph the bulk of the lipid was present as alpha and as beta lipoproteins, somewhat more in the latter fraction than in the former, and small quantities of lipid were found to migrate with the albumin and occasionally also with the gamma globulin and fibrinogen fractions. In a number of experiments

\* Bender-Hobein, Karlsruhe, Germany.

TABLE I  
 PROTEIN AND LIPID CONTENT OF THE BLOOD SERUM AND TISSUE LYMPH OF 19 NORMAL RABBITS\*

	Albumin	Alpha globulin	Beta globulin	Gamma globulin	Fibrinogen	Total	Total cholesterol	Phospholipid
<i>Protein</i> (gm./100 cc.)								
Serum	4.9 (3.0-6.6)	0.7 (0.2-1.3)	0.8 (0.5-1.3)	0.9 (0.4-1.6)	—	7.3 (6.2-10.3)	—	—
Lymph	2.0 (1.1-2.6)	0.3 (0.1-0.7)	0.3 (0.1-0.6)	0.2 (0.1-0.3)	0.1 (0.04-0.2)	2.9 (2.2-3.6)	—	—
<i>Lipid</i> (mg./100 cc.)								
Serum	75 (17-138)	168 (47-253)	192 (67-348)	12 (0-64)	—	450 (258-613)	75 (49-156)	96 (80-151)
Lymph	17 (0-30)	51 (25-80)	61 (24-100)	—	17 (0-38)	148 (98-220)	35 (26-65)	56 (16-100)

\* In this and in succeeding tables, the single figures in each case represent the mean and the figures in parentheses, the range.

the concentration of glucose, a readily diffusible substance, was determined in both the serum and the tissue lymph, and was found to be virtually the same in each.

An experiment was done to learn how rapidly labelled protein molecules passed from the blood serum into the tissue lymph. It is known that Evans blue dye combines rapidly with serum albumin, and a small amount of this dye was injected into the marginal ear vein of the rabbit at the same time that lymph was being collected from a subcutaneous lymphatic of the lower extremity. Within a very few minutes the lymph that appeared in the cannula was stained light blue. To confirm that the dye in the lymph was

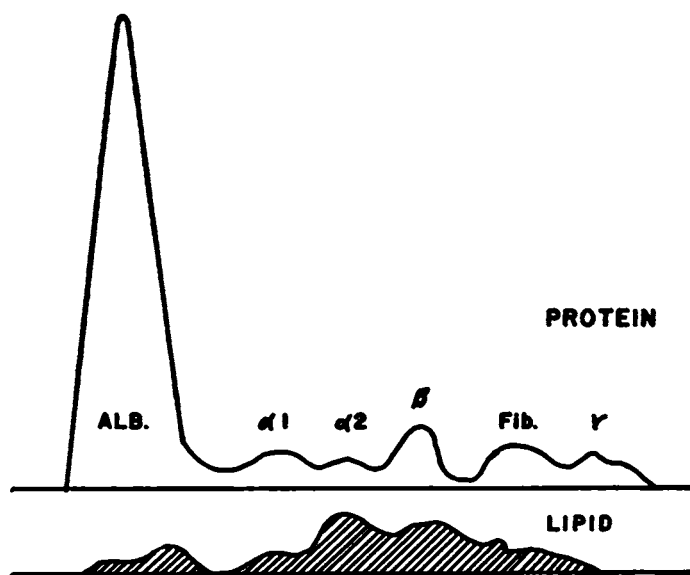

FIG. 1.—Electrophoretic Pattern of Normal Rabbit Tissue Lymph (Rabbit #1355).

TABLE II  
 PROTEIN AND LIPID CONTENT OF THE BLOOD SERUM AND TISSUE LYMPH OF 10 RABBITS  
 FED CHOLESTEROL\*

	Albumin	Alpha globulin	Beta globulin	Gamma globulin	Total	Total cholesterol	Phospho-lipid
<i>Protein</i> (gm./100 cc.)							
Serum	5.5 (4.2-7.5)	0.4 (0.1-0.7)	1.3 (0.6-2.1)	0.7 (0.6-2.0)	7.9 (6.5-10.9)	—	—
Lymph	2.5 (1.5-3.0)	0.2 (0.1-0.5)	0.4 (0.2-0.7)	0.2 (0.1-0.4)	3.3 (2.2-4.4)	—	—
<i>Lipid</i> (mg./100 cc.)							
Serum	708 (540-882)	575 (257-1000)	2680 (1571-3300)	—	3995 (2529-5400)	1864 (1075-3000)	767 (361-1596)
Lymph	296 (132-522)	234 (106-466)	568 (271-828)	—	1131 (770-1630)	728 (600-938)	194 (128-430)

\* Cholesterol—1.0 gm. and Tween 80—10 cc. were added to the diet 5 times a week for 12 weeks.

in fact bound to protein, trichloroacetic acid was added to the collected lymph; the precipitated protein contained all the blue color, whereas the supernatant was colorless.

These observations taken together indicate clearly that the capillary endothelium, while not freely permeable to lipids and proteins, does normally permit the passage of a small amount of these large molecular substances into the extracellular or tissue fluid, and that the concentration of lipids and proteins in the extracellular fluid is maintained at a level approximately one third to one half that of their concentration in the blood. It is probable that the contents of the extracellular space exist in the form of a gel rather than a fluid, and also that there is a dynamic equilibrium between the lipid and protein material in the blood and that in the extracellular space. Thus, it appears likely from these experiments that there is a constant flow of lipids and proteins across the capillary endothelium into the gel of the extracellular space, and in order to maintain equilib-

TABLE III  
 PROTEIN AND LIPID CONTENT OF THE BLOOD SERUM AND TISSUE LYMPH OF 9 RABBITS  
 GIVEN TRITON A-20 INTRAVENOUSLY\*

	Albumin	Alpha globulin	Beta globulin	Gamma globulin	Fibrinogen	Total	Total cholesterol	Phospho-lipid
<i>Protein</i> (gm./100 cc.)								
Serum	4.8 (3.9-6.4)	0.8 (0.4-1.1)	0.8 (0.3-2.1)	1.0 (0.5-1.8)	—	7.4 (6.1-9.8)	—	—
Lymph	2.2 (1.5-3.6)	0.3 (0.1-0.4)	0.3 (0.1-0.8)	0.3 (0.1-0.6)	0.1 (0-0.2)	3.2 (2.2-4.7)	—	—
<i>Lipid</i> (mg./100 cc.)								
Serum	193 (0-644)	2234 (572-5763)	2417 (823-4772)	—	—	4807 (2255-10,535)	681 (425-1037)	886 (579-1982)
Lymph	39 (0-108)	138 (30-289)	229 (113-465)	—	15 (0-66)	430 (320-625)	114 (71-230)	106 (90-183)

\* 12.5% Triton A-20, 2.0 cc./kg. was given intravenously on alternate days for 3 injections. Lymph and blood were obtained on the third day following the last injection.

rium conditions and prevent an excessive and harmful accumulation of these substances in the extracellular space, an equivalent amount is constantly removed through the tissue lymph and perhaps also by way of small venules. The mechanism whereby lipoprotein molecules traverse the capillary endothelium, whether through pores in the membrane,<sup>10</sup> across the cytoplasm, or by other means, remains to be determined. These findings are in sharp contrast to the traditional concept that the endothelium is impermeable to such large molecular substances as lipoproteins,<sup>11</sup> and they agree substantially with the observations of Wilens and Evans, who demonstrated similar permeability using blood vessel segments obtained post mortem from human beings and various animals.<sup>12, 13</sup>

Hyperlipemia was produced in two groups of rabbits by cholesterol feeding or by the intravenous injection of Triton A-20. The total protein content and the electrophoretic pattern of the serum and tissue lymph of these animals was not significantly altered, except in the case of cholesterol-fed rabbits where a substantial increase in the beta globulin component was observed (see tables II and III). The lipids in the serum and in the tissue lymph of these animals, however, were both strikingly elevated. The rabbits injected with Triton A-20, despite generally higher serum total lipid levels, had considerably less lipid in the lymph than did the cholesterol-fed rabbits. The reasons for this phenomenon are not clear. Among the possible explanations considered were: 1) that the surface-active agent affected the endothelial membrane, making it less permeable; 2) that the Triton altered the protein portion of the lipoprotein molecules; or 3) that the serum lipids of Triton-injected rabbits were aggregated into very large molecules and hence less likely to pass through the endothelium. The latter seems the most likely possibility since the serum of these animals was milky-white, in striking contrast to that of cholesterol-fed rabbits, which in most cases was merely opalescent or only slightly milky. It is of interest that the tissue lymph lipids of cholesterol-fed rabbits showed the same disparity between cholesterol and phospholipid (a high cholesterol and relatively low phospholipid) that has previously been shown to be present in the blood of such animals.<sup>14</sup> In the Triton-injected rabbits, on the other hand, the cholesterol and phospholipid levels of the tissue lymph were found to be increased in about the same degree. This finding may have bearing upon the fact that the injection of surface-active agents into cholesterol-fed rabbits afforded considerable protection against the development of atherosclerosis.<sup>14</sup>

In a small number of animals made hyperlipemic by means of alloxan, the lipids of the tissue lymph remained essentially unchanged despite an enormous concomitant increase in the serum lipids. This finding is noteworthy in light of the observation made by Duff and McMillan that alloxan diabetes protected cholesterol-fed rabbits against the development of atherosclerosis.<sup>15</sup>

A number of experiments were done to investigate some of the factors that might influence capillary permeability to lipids and proteins. Thus, increased intracapillary pressure produced by vasodilatation or by venous obstruction was found to augment greatly the rate of flow of tissue lymph, although the concentration of lipid and protein in the lymph remained essentially unchanged. This observation may have bearing upon the well-recognized fact that hypertension accelerates the development of atherosclerosis. Also, anoxia brought about a significant increase in capillary permeability, and in animals moribund from the effects of anoxia, the lipid and protein content of the tissue

lymph was almost equal to that of the blood serum. In addition, the observation was made frequently that lymph obtained from animals with grossly milky serum was water-clear in almost every case. This would suggest that the very large lipid particles (chylomicrons) that are responsible for the milkiness of serum do not readily traverse the capillary endothelium, and it would therefore cast doubt on the hypothesis that chylomicrons are important in the development of atherosclerosis.<sup>16</sup>

### DISCUSSION

The findings in these experiments lend support to the "filtration" concept of the pathogenesis of atherosclerosis.<sup>17, 18</sup> It seems likely that under normal conditions there is a constant flow of fluid containing various serum lipids and proteins across the endothelium into the walls of blood vessels; this material normally passes through the wall and is completely removed by way of vasa vasorum and lymphatics. In certain conditions, however, where there are increased amounts of lipid in the blood, or where there are excessive quantities of certain types of lipids (beta lipoproteins<sup>19</sup> or the S<sub>r</sub> 12-20 molecules of Gofman<sup>20</sup>), the removal of these particles from the wall of the vessel is incomplete and some remain behind to initiate the process of atherosclerosis. In hypertension, the increased hydrostatic pressure appears to cause an increase in the quantity of serum lipoprotein that diffuses across the vessel wall, thereby increasing the possibility for incomplete removal and hence for deposition of lipids. In those areas of the vascular tree where the removal mechanism has been altered, as for example in syphilitic aortitis or in experimentally produced trauma to the vessel wall, the free transport of lipid and other particles across the vessel wall is impeded, and in these areas the lipid is therefore more apt to precipitate and to give rise to atherosclerosis. In this theoretical formulation of the pathogenesis of atherosclerosis, the artery wall is regarded as an organ which is constantly bathed by a serum transudate containing, among other things, various serum lipoproteins, most of which pass on through, some of which doubtless are metabolized locally, and a few of which remain behind to cause mischief. Atherosclerosis, broadly considered, may thus result either from qualitative or quantitative changes in the serum lipoproteins that filter constantly across the walls of blood vessels, or from local structural changes inherent in the vessel wall, or the result of age or disease, that serve to hamper the normal passage of these fatty substances.

### SUMMARY

Studies of the lipid and protein content of the tissue lymph obtained from subcutaneous lymphatics of the lower extremity of rabbits indicate that the capillary endothelium is normally permeable to a limited extent to lipoprotein molecules, and that the extracellular or tissue fluid normally contains essentially the same lipids and proteins as are present in the blood serum, but in a somewhat lower concentration.

The bearing of these findings upon the pathogenesis of atherosclerosis is discussed.

### REFERENCES

1. Duff, G. L., and McMillan, G. C.: *Am. J. Med.* 11: 92, 1951.
2. Kellner, A.: *Bull. New York Acad. Med.* 28: 11, 1952.
3. Drinker, C. K., and Field, M. D.: *Lymphatics, Lymph and Tissue Fluid*, Baltimore, The Williams & Wilkins Co., 1933.
4. Kellner, A., Correll, J. W., and Ladd, A. T.: *J. Exp. Med.* 93: 373, 1951.

5. Van Slyke, D. D., and Folch, J.: *J. Biol. Chem.* *136*: 509, 1940.
6. Schoenheimer, R., and Sperry, W. M.: *J. Biol. Chem.* *106*: 745, 1934.
7. Fiske, C. H., and SubbaRow, Y.: *J. Biol. Chem.* *66*: 375, 1925.
8. Flynn, F. V., and DeMayo, P.: *Lancet* *2*: 235, 1951.
9. Durrum, E. L., Paul, M. H., and Smith, E. R. B.: *Science* *116*: 478, 1952.
10. Pappenheimer, J. R., Renkin, E. M., and Borrero, L. M.: *Am. J. Physiol.* *167*: 13, 1951.
11. Man, E. B., and Peters, J. P.: *J. Clin. Invest.* *12*: 1031, 1933.
12. Wilens, S. L.: *Science* *114*: 389, 1951.
13. Evans, S. M., *et al.*: *Circulation* *8*: 438, 1953.
14. Kellner, A., Correll, J. W., and Ladd, A. T.: *J. Exp. Med.* *93*: 385, 1951.
15. Duff, G. L., and McMillan, G. C.: *J. Exp. Med.* *89*: 611, 1949.
16. Moreton, J. R.: *J. Lab. & Clin. Med.* *35*: 373, 1950.
17. Anitschkow, N., in Cowdry, E. V.: *Arteriosclerosis, a Survey of the Problem*, New York, MacMillan, 1933.
18. Page, I. H.: *Circulation* *10*: 1, 1954.
19. Barr, D. P., Russ, E. M., and Eder, H. A.: *Am. J. Med.* *11*: 468, 1951.
20. Gofman, J. W., *et al.*: *Science* *111*: 166, 1950.

### DISCUSSION

*Dr. Anfinsen* asked whether animals other than rabbits became hyperlipemic but not atherosclerotic when a surface-active agent such as Triton was added to the diet.

*Dr. Kellner*, although he could not answer that question, emphasized that rabbits develop much less atherosclerosis than might be expected from the level of blood lipid produced by the intravenous administration of Triton.

*Dr. Anfinsen* stated that in his experiments with heparin he had found that combination of Triton with lipoproteins prevented the latter from being metabolized completely. It may be that ordinary lipoproteins are transported from the blood vessel to the lymph, but that abnormal lipoproteins unload a substance in transit and deposit a residue which produces atherosclerosis—the so-called delta theory.

*Dr. Gross* speculated that although there may be a reflection in the lymph of the contents of the serum, materials may be filtered out in the so-called extracellular space, which is occupied by a connective-tissue gel. With age, and under the influence of hormones, the composition and reactivity of the gel undergo marked changes. Normal lipids trapped in the gel may become altered and precipitate out of the lymph. He pointed out that the lesion of atherosclerosis arises in the extracellular area.

In reply to a question by *Dr. Page*, he stated that the connective-tissue gel is equivalent to ground substance, and is composed of many compounds as yet uninvestigated. Except for an article by *Levine* in 1918 and a more recent article by *Meyer* on the mucopolysaccharide content of the aorta, *Dr. Gross* has found no references to investigations of the components. He felt that the histochemical approach had added no information, inasmuch as the specificity of many of the techniques had not been established.

*Lt. Batchelor* suggested that there might be analogies in the effect of Triton on alpha globulins in the rabbit and in the effect of waxes commonly used as adjuvants to antibody production. The latter, when administered alone to rabbits, had been found by *Harrison Wood* to stimulate the production of C-reactive protein—an alpha globulin. (See revised estimate of electrophoretic mobility, however, in *J. Exper. Med.* *100*: 71, 1954).

*Dr. Eder* asked whether there was any indication that the protein component of the

lipoprotein in lymph is synthesized in the intercellular gel, or whether it merely passes on through with the lipid.

*Dr. Kellner* replied that although it is possible to label a protein with a dye and thereby follow its passage from the bloodstream through the extracellular "space" and into the lymphatics, it is not possible to ascertain whether it has undergone change in transit.

*Dr. Duff* emphasized that arterial endothelium may be less permeable than the capillary endothelium studied by *Dr. Kellner*. Although the latter had suggested that alteration in endothelial permeability is not the initial change, *Dr. Duff* had obtained evidence indicating that the biological properties of endothelium become altered during the development of an atherosclerotic lesion. When rabbits made atherosclerotic by cholesterol feeding are injected intravenously with large doses of thorotrast, the colloidal thorium dioxide is taken up and aggregated into particles by the endothelium covering the atherosclerotic lesions, but not by the endothelium of uninvolved portions of the artery. He felt that the acquired biological property of accumulating colloidal thorium might be associated with alteration in the permeability of the endothelium. It had been shown that this change occurred very early in the development of atherosclerotic lesions, but it had not been possible to determine whether acceptance of thorium by the endothelium developed just before or just after the first appearance of lipid in the intima.

*Dr. Gould* asked whether the technique had been used in animals other than the rabbit.

*Dr. Kellner* pointed out that the results of the thorotrast experiments could also be interpreted as indicating that injected dye initially permeates the entire vessel wall, but that at the site of atherosclerotic plaques the removal mechanism has been impaired and the dye remains in the lesions.

In reply to the question of *Dr. Gould*, he stated that he had experimented only on the rabbit and that his generalizations applied only to that animal.

## EXPERIMENTAL STUDIES ON ARTERIOSCLEROSIS

ALBERT I. LANSING

If we were to take literally the philosophy behind research on arteriosclerosis of the last twenty-five years, we would be rapidly led into two misconceptions. The impression would be gained that arteriosclerosis is a disease of overfed, overambitious, white, male executives and professional men in the United States, and second, that arteriosclerosis (recently renamed atherosclerosis) is a disease of cholesterol metabolism in which the artery plays a passive role if it plays any part at all.

Before we all turn to vegetarian diets to avoid the ingestion of cholesterol, it might be well to recall a few pertinent facts. It is a matter of record that arteriosclerosis, grossly and microscopically indistinguishable from the lesion of today, has been found in the mummies of Egyptian priests of 2,000–3,000 years ago. History tells us that the Egyptian priests of that period, though overfed, were far from subjected to the stresses of competitive life.

We hear from time to time of various national groups such as the Ceylonese, Siamese, or Chinese in whom there is a remarkably low incidence of arterial disease. It is implied or directly stated that dietary or genetic factors determine this contrasting situation. The fact is, however, that in each of the groups manifesting a low incidence of arterial disease there is also a very low life expectancy. These people simply do not live long enough to experience arteriosclerosis.

I believe that it is safe to say that arteriosclerosis knows no racial or national boundaries and is not a recent development in the history of man. Indeed, there is an abundance of evidence to indicate that arteriosclerosis, similar to or identical with that which occurs in humans, occurs spontaneously in a wide variety of animals in and out of captivity. It is reasonable to conclude that a fundamental change or group of changes is associated with arteriosclerosis.

Apropos of the second misconception referred to, it may be noted that the experimental lesion produced in the rabbit by cholesterol feeding is not entirely comparable to that which occurs spontaneously in man; that not all lesions of the arterial intima contain fat (many appear to be composed of white fibrous connective tissue); that arteriosclerosis is a focal disease (lesions are more severe at the intercostals than in adjacent areas, and more severe in the abdominal aorta than in the thoracic aorta); vessels such as the pulmonary artery are almost entirely resistant to arteriosclerotic changes *in the normal*; and that scarification of the aorta accompanying luetic aortitis is accompanied by severe atheromatosis. There can be little doubt but that the conditions existing in the artery on a highly localized basis determine the degree of susceptibility to fat accumulation.

In this connection it is worth while to review briefly some of the historical aspects of the problem.

*Arteriosclerosis*, edited by Cowdry in 1933, reveals a surprising unanimity of opinion in regard to the nature of this disease. Fox, in outlining the phylogenetic aspects of arteriosclerosis, emphasized the significance of changes in the elastic tissue of the media and the relations of such elastic tissue changes to atheromata. "The only feature that is



clear is that the less definite a lamina (elastic) protecting the media, the more definite is the atherosclerosis." Ophüls observed that "The most important change caused by aging of the arterial wall is a gradual diffuse distension due to the progressive deterioration of the elastic tissue." Wells argued strongly for the all-importance of elastic tissue failure in arteriosclerosis. The fact is that a large volume of data had been accumulated describing a characteristic fraying and fragmentation of elastic tissue in arteriosclerosis, frequent reduplication of the elastica interna, and development by elastic tissue of a profound affinity for calcium salts. Curiously enough, Anitschkow, who fathered experimental cholesterol atherosclerosis, pointed out that lesions of the arterial wall coupled with intimal fibrosis predispose to atheromata in the presence of hypercholesterolemia.

It is quite understandable that Anitschkow's production of atheromata by the administration of cholesterol resulted in an intensive effort over the last 20 years to link arteriosclerosis to faulty lipid metabolism. These studies have been strongly reinforced by the lipoprotein studies of Gofman and of Barr, by the dietary studies of Keys, and by many others too numerous to enumerate. As these studies developed it became increasingly difficult to relate elastic tissue changes in the arterial wall to the etiology of arteriosclerosis.

Our laboratory has been led to the conclusion that arteriosclerosis may be considered to be not one, but two diseases. One disease involves a defect in cholesterol metabolism or circulation, while the second disease is manifested by a breakdown in the structure of the elastic elements in the media of arteries accompanied by a calcification of this elastic material. This point of view was supported by our observations on human material that the elastic-tissue breakdown occurs prior to the formation of atheromata, that the changes in elastic tissue are associated with age and may occur without atheromata (the converse is not true), and that when these two lesions coexist the accumulation of cholesterol in the intima occurs after the elastic tissue of the underlying media has broken down.

Whether or not this formal hypothesis is sound is not too important. The cardinal point is that in human arteriosclerosis there is an almost invariable association of medial elastic-tissue degeneration with the more conspicuous atheromata. The questions are: what relation is there between cholesterol accumulation in the intima and elastic-tissue breakdown in the media; and, is there a common factor responsible for the production of both of these lesions?

It would be excessively repetitious to present once again all of the histological and analytical data which have contributed to the development of the point of view of my laboratory. For the purposes of this discussion it might be more appropriate to make a few points on the chemistry of elastic tissue in relation to age and arteriosclerosis, and to attempt to evaluate factors that condition elastic tissue in these two states. Since all of our data depend upon the method of preparation of elastin, this procedure will be described before making three points: first, that although the elasticity of arteries decreases with age, there is no apparent loss of elastin; second, that elastin extractable from old human aortas has an amino acid composition distinct from that of young elastic tissue; and third, that elastic-tissue degeneration as measured by calcification thereof occurs as a function of age.

*Preparation of Elastic Tissue*

Elastin may be prepared in a reproducible form and with several objective measures of purity. A slight modification of the method of Lowry, Gilligan, and Katersky<sup>9</sup> was applied to the tunica media of fresh human aortas. The tissue was refluxed in methanol or ethanol for one hour and in acetone for a second hour. This defatted material was then digested at 98° C. in 0.1 N NaOH and small samples taken off at five-minute intervals for chromatographic, histologic, and chemical analyses.

Two-dimensional paper chromatography appears to be an effective means of characterizing elastin. After complete hydrolysis, tryptophane exists as a trace in elastin<sup>8</sup> but is a significant component of other tissue proteins. By tracing the disappearance of the ninhydrin-colored tryptophane spot in the chromatogram one can readily determine when contaminants of elastin are removed. This was done in the NaOH digestion series, and it was determined that the tryptophane spot disappeared after 40 to 45 minutes. At this time, glycine, proline, leucine, isoleucine, and valine were readily identified in the chromatogram, and minor spots for aspartic and glutamic acid were present. The finding of these amino acids as the principal components of elastin is consistent with published analytical data for the amino acid composition of elastin.<sup>10</sup>

There was a progressive reduction in the amount of residual material through 40 to 45 minutes of digestion, after which time the residual dry weight was constant through 60 minutes (fig. 1). These data seem to indicate that digestion of elastic tissue in hot,

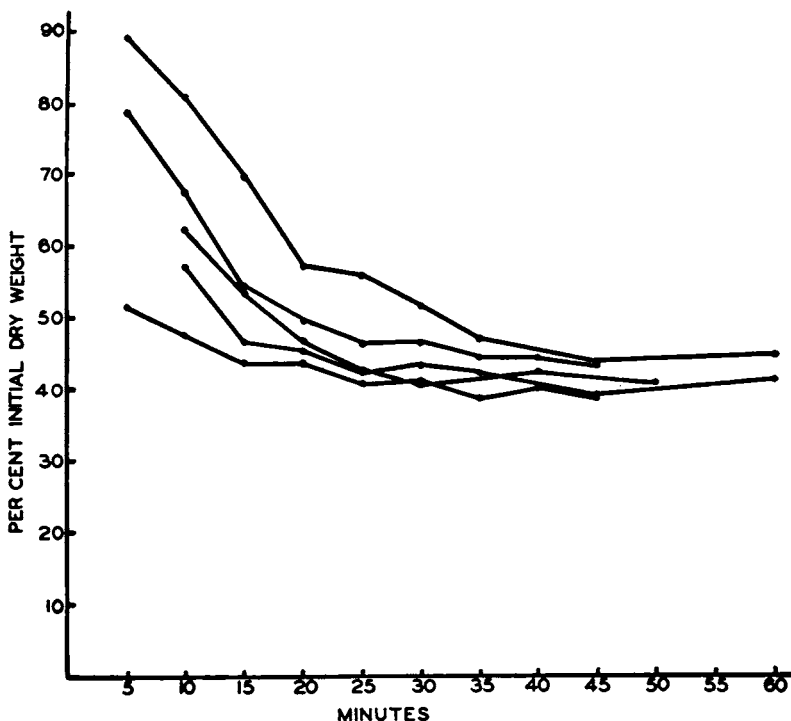

FIG. 1.—Hydrolytic curves of elastin in 0.1 N NaOH at 98° C.

dilute alkali for less than 45 minutes is not adequate to remove extraneous materials from the tissue.

Microscopic examination of samples digested in NaOH for periods less than 45 minutes revealed variable amounts of collagen and muscle after staining with Mallory's procedure. After 45 minutes no collagen or muscle could be demonstrated, and the elastin was optically homogeneous, refractile, and apparently free from contaminating structures. Likewise, elastin prepared from ligamentum nuchae was free of collagen insofar as could be determined by light microscopy and electron microscopy. It was birefringent when stretched or dried, had a refractive index of 1.534, was resistant to digestion by crystalline trypsin (Armour), and stained effectively with orcein, resorcin-fuchsin, or the Verhoeff procedure.

#### *Constancy of Human Arterial Elastin with Age*

A total of 110 human aortas and 106 human pulmonary arteries from which both intima and adventitia had been removed by stripping were analyzed for elastin content by the method just outlined.

The results obtained by these procedures on aortas ranging in age from stillborn to 103 years are summarized in figure 2. The average elastin content of the media during the first two decades of life is slightly over 48%, while in the third decade and thereafter it drops to between 41.1% and 44.1%. Because of the limited number of specimens available for analysis in the first two decades it is difficult to decide whether or not this apparent drop in medial elastin content is significant. Certainly there is no significant gain or loss of elastin after the third decade of life.

The data for the pulmonary arteries followed a somewhat different pattern from those of the aortas. During the first three decades of life the media of the pulmonary artery

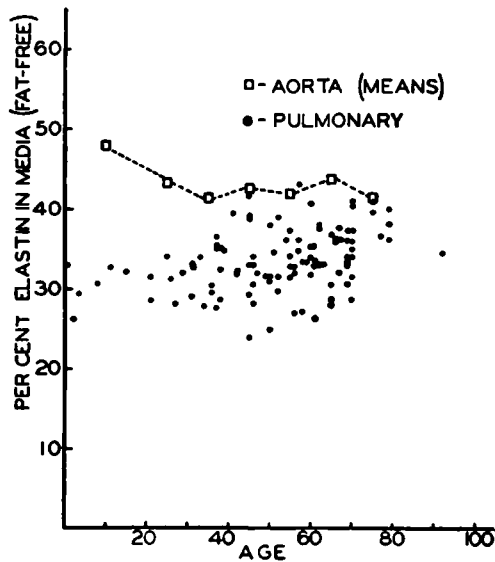

Fig. 2.—Graphic representation of elastin contents of human aortas and pulmonary arteries (media only) after extraction with 0.1 N NaOH. Data for aortas are pooled, for pulmonary arteries are individual.

contained slightly less than 31% elastin. This increased slowly but steadily throughout life to 34% in the seventh decade and to almost 37% in the eight decade. The increase of elastin with age, although small, is statistically significant.

It would appear, then, that at least after the second decade of life the elastin content of elastic vessels such as the aorta and pulmonary artery either remains constant or actually increases. The loss of arterial elasticity with age cannot be attributed to a loss of elastic tissue. It is more likely due to a change in the properties of elastic tissue with age.

#### *Amino Acid Composition of Young and Old Arterial Elastin*

Microbiological assay of aortic and pulmonary elastin prepared in the usual manner was effected by the method of Roberts, Ramasarma, *et al.* Nitrogen analyses indicated a content between 15% and 16%, suggesting that elastin is largely protein. Highly significant increases in the contents of aspartic and glutamic acids were noted in the samples of old aortic elastin as compared to those of the young elastin, in confirmation of the chromatographic findings. There also were increases in the contents of amide nitrogen. However, there was a fourfold increase in the excess of dicarboxylic acids over amide nitrogen, showing that the quantity of free carboxyl groups was increased significantly in the older specimens. The mean values for valine, proline, and glycine contents were somewhat lower in the older samples, while the leucine and isoleucine contents in the two groups were closely similar. In contrast to the findings for aortic elastin, the pulmonary elastin did not show increases in aspartic and glutamic acid contents with age. The other amino acids also did not change significantly. The contents of proline, leucine, isoleucine, and valine were virtually identical with those found in young aortic elastin. However, the contents of glycine and the dicarboxylic amino acids were higher in the pulmonary elastin. The quantity of free carboxyl groups was at least twice as great as that found in young aortic elastin, while the range showed some overlap with that of the old aortic elastin. It was found that a separation of fractions having differing specific gravities could be achieved by differential centrifugation of finely ground elastin (Wiley mill) in sucrose solution (sp. gr. 1.30). Most of the material in samples of aortic elastin from very young individuals floated on the solution after centrifugation, while most of that from old individuals settled to the bottom. A sample of the suitably washed light fraction (young light) was prepared from several young aortas and some of the heavy material (old heavy) was prepared from old aortas. Both of these materials were analyzed for calcium and the contents of 18 amino acids.

In table I are shown the contents of 18 amino acids in the light fraction of young aortic elastin and the heavy fraction of old aortic elastin prepared by suspension in sucrose in the manner described previously. In the case of the seven amino acids which were determined on whole elastin (table II), the differences observed between the young light and old heavy fractions were all similar to those found for the young and old whole elastin. The old heavy elastin showed increases in aspartic and glutamic acids and decreases in the contents of glycine, proline, and valine. There was also an increase in the number of free carboxyl groups in the old heavy sample. In addition, there was a decrease in the content of alanine. All of the other amino acids showed increases of varying degree in the old heavy elastin. Approximately 90% of the nitrogen of both samples was accounted

TABLE I  
AMINO ACID COMPOSITION OF YOUNG LIGHT AND OLD HEAVY ELASTIN  
(Separated by Flotation in Sucrose at S.G. 1.3)

Amino acid	Young "light"* g N per 100 g N	Old "heavy"† g N per 100 g N
Aspartic.....	0.38	1.11
Glutamic.....	1.83	3.01
Glycine.....	26.10	21.30
Proline.....	10.10	9.20
Leucine.....	4.52	4.76
Isoleucine.....	2.10	2.33
Valine.....	13.00	11.50
Alanine.....	23.18	21.58
Lysine.....	0.49	1.17
Arginine.....	1.78	4.35
Histidine.....	0.15	0.75
Cystine.....	0.06	0.10
Methionine.....	0.06	0.35
Phenylalanine.....	1.73	1.97
Tyrosine.....	1.45	1.76
Tryptophan.....	0.06	0.24
Serine.....	0.29	0.70
Threonine.....	0.65	1.13
Amide N.....	2.90	2.86
Total.....	90.83	90.17

\* This preparation contained 1.14% calcium and 14.9% N.

† This preparation contained 6.39% Ca and 12.5% N.

for by the analyses. The light fraction contained 1.14% calcium, while the heavy fraction contained 6.39%.

These data indicate that the amino acid compositions of young and old arterial elastin are significantly different.

It is doubtful that the shift in amino acid distribution represents a change with time in the amino acid composition of a pure protein. The elastin studied may be a mixture of two or more proteins, and the changes observed may be related to differences in the ratios of the separate constituents. How such a change can come about is not yet known. It is possible that the proteins laid down later in life may be different from those formed earlier because they are formed under the influence of fibroblasts which themselves have undergone age changes.

#### *Age Calcification of Medial Elastic Tissue*

The question has repeatedly arisen whether the breakdown and calcification of medial elastic tissue is a sequel to atheromatosis or whether this is an age-dependent phenomenon. In an attempt to resolve this question, atheroma-free segments of the upper abdominal portions of human aortas were collected and both adventitia and intima were separated by stripping. To guard against chemical contamination of the selected areas by adjacent and overlying atheromata or necrotic and calcified plaques, we selected for

TABLE II  
AMINO ACIDS, CALCIUM, AND NITROGEN CONTENTS OF ELASTIN FROM AORTAS AND  
PULMONARY ARTERIES OF YOUNG AND OLD INDIVIDUALS

Sample	Age	Aspar- tic acid, g N/ 100 g N	Gluta- mic acid, g N/ 100 g N	Glycine, g N/ 100 g N	Proline, g N/ 100 g N	Leu- cine, g N/ 100 g N	Isoleu- cine, g N/ 100 g N	Valine, g N/ 100 g N	Amide NH <sub>2</sub> g N/ 100 g N	g Ca/ 100 g	g N/ 100 g† (cor- rected)
Young aortas	15	.24	1.32	26.6	11.4	4.71	2.22	13.6	1.43	.17	15.90
	17	.32	1.67	25.8	11.1	4.76	2.31	12.3	1.43	.16	15.75
	19	.31	1.43	27.0	10.8	4.94	2.27	13.2	1.43	.18	15.82
	20	.38	1.63	26.8	11.3	4.84	2.38	12.9	—	.88	15.35
	Mean	.31	1.51	26.6	11.2	4.81	2.30	13.2	1.43	.35	15.71
Old aortas	55	.65	2.13	25.6	10.4	4.92	2.46	11.4	1.83	4.58	16.22
	59	1.35	2.70	24.0	9.4	5.01	2.43	11.4	2.30	4.74	15.50
	65	.68	2.16	24.8	11.3	4.59	2.44	11.9	1.76	6.03	15.19
	65	1.70	3.06	22.6	9.4	4.94	2.60	10.7	2.40	6.61	15.37
	74	1.15	2.33	25.2	10.7	4.73	2.21	12.0	2.22	5.14	15.32
	75	.90	2.52	23.8	10.2	4.60	2.47	11.4	2.02	8.47	15.75
	Mean	1.07	2.48	24.3	10.2	4.80	2.43	11.5	2.09	5.93	15.56
Pulmonary arteries	15	.68	1.84	30.4	11.5	4.68	2.24	12.2	1.51*	.13	16.25
	26	.66	1.99	31.3	10.7	4.96	2.28	13.6	(1.38-	.17	15.68
	77	.47	1.40	31.7	9.8	4.53	2.14	12.4	1.76)	.15	16.27
	92	.68	1.75	34.5	11.8	4.95	2.47	13.4		.64	15.78
	Mean	.62	1.75	32.0	11.0	4.78	2.28	12.9	1.51	.27	16.00

\* These values were obtained from the analysis of 10 different samples of elastin prepared from pulmonary arteries ranging in age from 31 to 79 yr.

† Calculated on a Ca-free basis, assuming all of the Ca to be present as  $\text{Ca}_3(\text{PO}_4)_2$ .

analysis 14 aortas which possessed an over-all minimum of atheromatosis. Little difficulty was experienced in collecting atheroma-free tissue in the young group, while considerable selection was required in the older specimens.

The separated tissues collected in this age series were analyzed for calcium content by the method of Salomon, Gabrio, and Smith. The data, as summarized in figure 3, show a progressive calcification of medial elastin in the absence of intimal disease.

It seems clear that change in composition of human arterial elastic tissue, which is almost invariably associated with overlying atheromatosis, is age-conditioned. That age alone is not effective is attested to by the fact that the pulmonary artery is normally

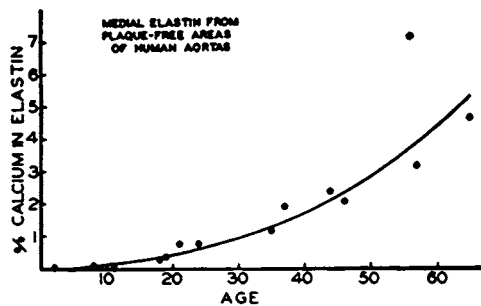

FIG. 3.—Graph showing progressive increase in calcium content of medial elastin from grossly normal areas of human aortas.

resistant to elastic-tissue change at all ages. This artery does develop typical elastic tissue changes as well as atheromatosis when it is subjected to stress, as in pulmonary hypertension.

### *The Role of Elastase*

In presenting these several forms of data, I have not been attempting to propose that the primary lesion of arteriosclerosis is elastic-tissue breakdown rather than accumulation of lipid in the intima. My point is that arteriosclerosis is a complex disease; at least in the human, it is a product of both accumulation of lipid in the intima and degeneration of elastic tissue in the media of arteries. The question is: Is there a common basis to both of these lesions, or is their occurrence coincidental? I suspect that the former possibility is valid, and that the material called elastase may be implicated in both elastic tissue and lipid metabolism. The data are far from complete, and elastase is as yet poorly defined, but sufficient experimental data are available to warrant serious consideration of the role of this material in arteriosclerosis.

Elastase, exclusively extractable from the pancreas, was originally prepared and characterized as an enzyme by Balo and Banga. It is apparently specific for elastic tissue, and acts upon the substrate to convert a fibrous protein to the globular form; in solubilizing elastic tissue there is no apparent release of peptides or amino acids. In this laboratory elastase has been used to work out the fine structure of elastic fibers. The enzyme solubilizes both elastic fibrils and a matrix material, which together make up the elastic fiber.

In a recent study of the phylogenetic distribution of elastase, Lansing, Rosenthal, and Alex not only found this enzyme in a teleost fish but also determined that it was present in the islet rather than acinar tissue. *Lophius piscatorius* (goose, monk, or angler fish) like several other teleosts has islet tissue that is anatomically separate from the acinar portion of the pancreas. Each, then, can be collected separately and in relatively pure form. We found the elastase activity to be confined exclusively to the islet tissue, and were thus led to suspect that elastase has a systemic rather than digestive function. This suspicion is supported by the well-known observation that elastic fibers resist digestion in the alimentary tract; adult human pancreatic juice has failed to show elastase activity; the yield of elastase from whole pancreas is extremely low; and beef pancreas is an excellent source of elastase. Since this animal is herbivorous there would appear to be no need for a digestive enzyme for elastic tissue.

Balo and Banga have recently indicated that the elastase content of the pancreas of human arteriosclerotics is substantially less than normal. Close inspection of their tabular data shows that age is as much a variable in their material as is arteriosclerosis. For example, the group of arteriosclerotics which yielded a mean of 9 elastase units per gram had an average age of 61 years; the group of nonarteriosclerotics who came to autopsy because of other diseases had an average age of 34 years and a mean of 155 elastase units per gram; lastly, the group of nonarteriosclerotics who came to autopsy through violent death had an average age of 31 years and 208 elastase units per gram. The possibility appears to exist that loss of elastase may be related to arteriosclerosis, to aging, or to both.

Although elastase has been crystallized by a rather laborious procedure with a very low yield, this material is generally prepared as little more than a pancreatic extract by

acid extraction and salting. In such extracts the elastase activity in vitro or in vivo is destroyed by boiling. The elastase activity of pancreatic extracts persists after fat extraction and dialysis. Curiously enough, although these conditions would suggest that elastase is a protein, the systemic effects to be outlined were obtained by oral administration of the material. A unit dose per rabbit was that amount of elastase extractable from 5 grams of pancreatin (Viokase, Viobin Corp., or Wilson's concentrated pancreatin).

In two groups of tracer studies using  $C^{14}$ -labelled acetate (COOH) and glycine ( $CH_2$ ) with and without elastase, it appears that the oral administration of this material has significant effects on the metabolism of aortic elastic tissue. Rabbits, in groups of five, were given 0.1 mc. of either of the two isotopes by intraperitoneal injection and followed for 2-28 days. Animals were sacrificed at various time intervals after injection of the glycine or acetate, the aorta from the arch to the diaphragm was removed, fat-extracted, reduced to elastin, hydrolyzed, and transferred to planchets for counting. The only difference between the controls and experimental rabbits was that the latter received daily doses of elastase for the duration of the experiment. The results with the controls indicate that the metabolism of elastic tissue is considerably like that of collagen as established by Newberger using comparable doses of the isotopes. Every indication is that the turnover of elastic tissue is very low, and indeed after administration of elastase is even lower than in the control (table III). It is difficult to propose a formal explanation for this result; one possibility is that elastase removes a particular component from elastic tissue, one that is substantially labelled in the control. Whatever the final

TABLE III  
DATA SHOWING SPECIFIC ACTIVITIES OF AORTIC ELASTIN AFTER LABELLING WITH RADIOACETATE ( $C^{14}$ ) IN NORMAL AND ELASTASE-TREATED RABBITS

Animal Number	Exp.	Dry wgt. AORTA (mg)	Dry wgt. ELASTIN (mg)	% ELASTIN	Activity cts/min	S. A. cts/min/100 mg
121	2 day	102	43	42.2	6.8	15.8
122	cont.	119	48	40.2	6.1	12.7
123		94	34	36.7	8.4	24.3
124		116	45	38.8	6.4	14.2
125		135	52	38.6	13.7	26.7
				39.3		18.7
126		146	60	41.1	6.5	10.8
127	2 day	116	50	43.1	5.4	10.8
128	Elastase	131	56	42.8	5.7	10.2
129		109	41	37.7	8.4	20.5
130		110	41	40.0	7.3	16.6
				40.9		13.8
21		94	32	34.0	361.6	1064
22	7 day	105	39	37.1	94.0	253
23	cont.	151	67	44.3	59.2	134
24		112	43	38.4	26.6	71.3
25		102	36	35.3	-----	-----
				37.8		380.5
26		169	63	37.3	30.5	81.7
27	7 day	126	48	38.2	18.0	47.1
28	Elastase	126	54	42.9	14.8	34.5
29		142	51	35.9	14.5	40.3
30		135	55	40.8	12.2	29.8
				39.0		46.7



explanation for this phenomenon may be, it seems clear that oral administration of elastase has an effect on the isotopic labelling of elastic tissue.

We have conducted several series of experiments on rabbits in which cholesterol was fed in order to produce atheromatosis and liver damage. The animals were given 0.3% cholesterol in Ralston Purina Rabbit Chow (0.3 gm. cholesterol/day), a diet which is effective in producing almost 100% occurrence of fatty livers and aortic atheromatosis after six weeks of feeding. The experimental animals received daily doses of elastase simultaneously with the cholesterol. Each control and experimental group was composed of 20 male rabbits weighing 6–7 pounds.

The administration of elastase had no effect on the level of total plasma cholesterol as determined by the method of Zak. Cholesterol levels climbed from the normal value of approximately 70 milligrams per cent to as much as 1,500 milligrams per cent. As appears to be quite usual, we encountered about 1 rabbit in 20 which was almost completely resistant to hypercholesterolemia. In two pilot ultracentrifugation runs by the method of Gofman it appeared that elastase effected a shift in  $S_f$  values in the direction of the more slowly migrating groups. This point obviously needs further study. The administration of elastase resulted in almost complete inhibition of fatty livers, an effect which was vitiated by boiling the elastase. After six weeks of feeding elastase there was a marked reduction of the incidence and severity of atheromatosis which was not as complete as the effect on fatty livers. These experiments have been repeated in three separate series with essentially the same results. The implication is that elastase, in addition to influencing elastic tissue, also behaves as a lipotropic agent. It is most unlikely that these results are due to either choline or methionine. Elastase resists fat extraction, is salted out, resists dialysis, and is inactivated by boiling. While we cannot entirely rule out proteolytic liberation of methionine in the alimentary tube, the evidence thus far is that the content of protease is very low. It may be recalled that Chaikoff and Enteman in evaluating lipotropic agents observed the existence of an anti-fatty-liver factor which is protease-free and is present in the pancreas.

Obviously work such as this raises more questions than it answers. What cells in the pancreas produce elastase? On a tentative basis there is some evidence on hand that the alpha cell is implicated. Is elastase effective systemically when it is administered parenterally? Current procedures for the refinement of elastase will render this experiment feasible. Are the effects obtained with the material called elastase, at the moment not much more than a pancreatic extract, due to one specific substance or a group of substances? This last question will only be answered by further fractionation of elastase. In the meantime it appears that there are sufficient clues with the work on elastase to establish a new approach to the problem of arteriosclerosis.

#### REFERENCES

1. Balo, J., and Banga, I.: *Biochem. J.* 46: 384, 1950.
2. Balo, J., and Banga, I.: *Acta Physiol. Acad. Scient. Hung.* 4: 187, 1953.
3. Chaikoff, I. L., and Entenman, C.: *Advances in Enzymol.* 8: 171, 1948.
4. Cowdry, E. V.: *Arteriosclerosis*, New York, MacMillan Co., 1933.
5. Lansing, A. I., Rosenthal, T. B., and Alex, M.: *J. Gerontol.* 5: 112, 1950.
6. Lansing, A. I.: *J. Gerontol.* 5: 314, 1950.
7. Lansing, A. I.: *Proc. Soc. Exp. Biol. & Med.* 84: 689, 1953.
8. Lansing, A. I., Ramasarma, G. B., Rosenthal, T. B., and Alex, M.: *Proc. Soc. Exp. Biol. & Med.* 76: 714, 1951.

9. Lowry, O. H., Gilligan, D. R., and Katersky, E. M.: *J. Biol. Chem.* *139*: 795, 1941.
10. Neuman, R. E., and Logan, M. A.: *J. Biol. Chem.* *186*: 549, 1950.
11. Salomon, K., Gabrio, B. W., and Smith, G. F.: *Arch. Biochem.* *11*: 433, 1946.
12. Zlatkis, A., Zak, B., and Boyle, A. J.: *J. Lab. & Clin. Med.* *41*: 486, 1953.

### DISCUSSION

*Dr. Lansing*, in reply to a question by *Dr. Gould* concerning the purity of the elastase obtained, stated that he had been able to crystallize it, but that it is a difficult procedure and the yield is scanty.

He added that he did not use crude pancreatic extract, but extracted defatted pancreatin with phosphate buffer at pH 6, salted out the extract with ammonium sulfate at 2/10 saturation, precipitated the trypsin and other proteins, and obtained the active fraction of elastase at 4/10 saturation. Recently he had obtained an essentially protease-free elastase by using a method of selective acetone solubility.

*Dr. Gross* reported that he had prepared elastase by the method of Balo and Banga and had obtained a very active product.

*Dr. Lansing* added that in a study of the teleost fish, in which the islet tissue is separate from the acinar tissue, all the activity was in the islet tissue alone. He suggested that there might be a connection between that observation and the loss of alpha cells in the islets of animals that had been on elastase for six to nine weeks.

In reply to further questions he stated that Balo and Banga had been studying the chemical composition of elastase. He believed that the presence of an antielastase in the blood may indicate that elastase circulates in the blood.

Although this was difficult to explain, the enzyme was effective when given by mouth.

## SUMMARY OF PART I

BENTLEY GLASS

The great variety of theories proposed to explain the origin of atherosclerosis is well illustrated by the number of hypotheses already advanced and discussed in this first session of the Symposium. It is the unenviable task of the summarizer to try to set these forth clearly and in logical relationship to one another, to say nothing of his making any attempt to evaluate them on the basis of the available data.

There are clearly two major approaches to the problem. The one focuses on the formation of atheromatous plaques on the intima of the large arterial blood vessels, especially the aorta and the coronary arteries. The other starts with the observed loss of elasticity and occurrence of lesions in the media. Dr. Lansing clearly pointed up the problem when he spoke of the conclusion reached by his own group that atherosclerosis may be considered as in fact two distinct diseases, rather than one: the first, a defect in cholesterol metabolism or circulation; the second, a breakdown of the structure of the elastic elements in the media of arteries, accompanied by calcification. In that case the great questions become, since the two phenomena are so closely associated: are they etiologically independent? or is one primary, the other secondary? and if so, which is the primary factor?

The data presented by Dr. Lansing show strikingly that although the amount of elastin in the media of the aorta and pulmonary artery does not change with age, yet its chemical composition does so. The 30-fold increase in deposited calcium is accompanied by an increase of about two times in each of the dicarboxylic amino acids (aspartic and glutamic acids) found in elastin. This alteration may be related to the amount of available elastase, which is a pancreatic hormone of islet origin and of systemic rather than digestive function. It has not been shown that these changes associated with age by themselves inevitably bring on atherosclerosis; and it would seem that studies on young individuals who have succumbed to coronary disease would from this point of view be profitable. Would such persons already show, at a relatively early age, the characteristic changes in chemical composition of elastin normally seen only in the more advanced decades of life? I am sure that Dr. Lansing has thought of this, and has probably already undertaken studies in this direction.

The media of a large artery is nourished by an intramural plexus of vessels that includes interconnections all the way from the lumen of a vein to that of the adjacent artery, according to the demonstrations cited by Dr. Winternitz. According to his view, primary lesions occur in the media because of the intermittent arterial systolic pressure on the more delicate vessels of the mural plexi, as the intima and media are compressed against the relatively unyielding adventitia surrounding them by the pressure of the blood in the lumen of the artery. These medial lesions would occur oftenest in conjunction with hypertension. Medial necroses not infrequently become the sites of hemorrhages, which may in turn lead to the deposit from the spilled blood of iron and lipid. This theory properly takes note of the frequent association of atherosclerosis with hypertension, but makes little effort to account for its association with hypercholesterolemia.

Dr. Duff has referred to experimental demonstrations that the internal elastic mem-

brane of an artery without other support can withstand far higher intra-arterial pressures than any ever recorded clinically. It therefore seems doubtful that in the presence of an intact internal elastic membrane the mechanism proposed by Dr. Winternitz could operate. Lesions in the internal elastic membrane would first have to occur. Dr. Duff has thrown some highly interesting light on this matter. Just before bifurcation, arteries expand, and at such points their walls are subject to greater tension. Intimal thickenings occur in these regions, apparently as an adaptive response to the greater tension. The thicker intima of the coronary arteries may be similarly interpreted as an adaptive response. At the same time the thicker intima is regarded as a factor predisposing to atherosclerosis. As infants grow older, the internal elastic membrane of these vessels tends to disappear, the intimal thickenings become less elastic and muscular and more collagenous, and lipid deposits increase. Similar changes take place at the site of obliteration of the ductus arteriosus and umbilical arteries, which is also recognized as a "site of predilection" for atherosclerosis to occur. Adult arteries that have temporarily or permanently lost their full utility show similar changes. The cerebral arteries in particular shed light on the condition, for as long as the elastic membrane in these vessels remains intact, atherosclerosis is confined to the intima; but whenever breaks occur in the membrane, most frequently beneath atherosclerotic lesions in the intima, then the media may be occupied and gradually destroyed by lipid degeneration.

The importance of the same type of relationship has been brought out by the experiments described by Dr. Taylor for Dr. Hass. As he mentioned, rabbits with dietary hypercholesterolemia fail to present a picture like that of human atherosclerosis. To produce the typical picture, it is first necessary to produce a lesion of the arterial wall, by transmural freezing, and then the hypercholesterolemia completes the typical picture.

In the absence of high blood cholesterol, on the other hand, the freezing of a segment of artery leads to lysis of the killed cells, followed by regeneration that produces a new wall much like the arteriosclerotic wall except for absence of large amounts of lipid in the media and absence of a proliferated fibro-elastic intima.

Can we conclude, as Dr. Hass suggests, that in aging the elastic networks of the media lose their tensile strength because of transverse fractures, and that further effects then follow? At least in the rabbit, age alone is not of primary importance in the development of the degenerative and regenerative vascular lesions. The question remains, how does the aging process lead to discontinuities in the elastic tissue? In the human subject, hypertension seems to be frequently the precipitating factor. The localization of lipids at sites of injury in the media and of proliferation in the intima may then lead to the full atherosclerotic condition.

Drs. Page and Kellner have emphasized the importance of permeability and the filtration of plasma constituents through the walls of the blood vessels, for the lipid plaques of atherosclerosis are deposited under the endothelium, and must have passed through it. Experimental evidence now demonstrates that in the rabbit the capillary endothelium is normally permeable to a limited amount of proteins and lipids. In hyperlipemic animals the transmitted lipid is strikingly increased. It seems probable, therefore, as Dr. Kellner suggests, that lipids, along with other plasma substances, normally pass through the walls of blood vessels to a certain extent and are removed by the vasa vasorum and lymphatics. Whenever there are excessive quantities of certain lipids (especially the beta

lipoproteins), complete transmission fails, and the deposits initiate atherosclerosis. Hypertension, by increasing filtration, would assist the process. According to other views that have been expressed in this session, these deposits may be expected to occur especially where intimal thickenings are present and where lesions have occurred in the internal elastic membrane and media.

As the present speaker has emphasized, in all of these conditions we must reckon with genetically determined human variability. There are probably genes that modify the detailed structure of the blood vessels, though in the human species we as yet know little or nothing of these. There more certainly exist genetic differences that alter rates of aging, and the absorption or utilization of components of the diet. There is the gene that produces idiopathic hypercholesterolemia, and at the Johns Hopkins University studies now in progress support the view that genetic factors are important in both coronary disease and hypertension. The important point to keep in mind in this connection is that genes are as amenable to modification of their consequences as any other factors, and that the study of the way in which genes produce their interrelated effects may provide invaluable clues for the anatomical, physiological, and biochemical investigations of pathological conditions.



## PART II

---

### THE REACTION OF THE ARTERIAL WALL TO INTRAMURAL HAEMORRHAGE

J. C. PATERSON

The emphasis which has been placed in recent years on the "chemical" theory of atherosclerosis has obscured the fact that other influences, distinct from those responsible for the excessive deposition of lipid in arteries, may be concerned in the pathogenesis of the disease. Certain hypothetical lipid-depositing factors in current favour are of undoubted importance in experimental cholesterol atherosclerosis of the rabbit, dog and chicken; they are perhaps responsible, in part, for the rare "greasy" cases of human atherosclerosis seen in association with familial xanthomatosis, the nephrotic syndrome, and diabetes mellitus; but there is no direct evidence that they are of significance in the production of ordinary cases of end-stage human atherosclerosis. On the contrary, evidence that they are not usually at fault (in ordinary cases) is gradually accumulating. For example, it has been found in our laboratories that the concentration of extractable lipid in coronary arteries with severe atherosclerotic stenosis is not always much greater than that in arteries with lesser grades of disease (table 1). And furthermore, we have failed, so far, to obtain any obvious correlation when the antemortem serum levels of cholesterol and  $S_f$  12-20 molecules, or the cholesterol-phospholipid ratio, are compared either with the degree of sclerosis or the lipid content of human coronary arteries after death (table 2).

Results like these do not convince one that the progression of the atherosclerotic process in man is due entirely either to lipid deposition or to abnormalities in the serum lipids. Furthermore, if one studies the structure of stenosing atherosclerotic plaques, plaques so large that they produce arterial insufficiency, the impression is gained that the fibrous tissue component is often greater than the lipid component. It would seem, then, that the factors responsible for the "sclerosis" of arteries, as distinct from those producing "atheroma", deserve attention. A variety of factors may be involved in the process, but in the present paper only one of these—intramural haemorrhage—will be discussed. Thus, most of my remarks will follow along the general line of the "vascularization" theory of Winternitz,<sup>1</sup> elaborated and modified.

#### *The Effects of Intramural Haemorrhage*

It is now generally accepted that intramural haemorrhages are intrinsic lesions within atherosclerotic plaques. If they are studied by complete serial section technique, no break in the overlying endothelium is often found.<sup>1, 2</sup> Their cause is obviously the rupture of capillaries which can be seen in the immediate neighbourhood of the extravasated blood. From the evidence at hand, intramural haemorrhages may produce a variety of effects, effects which may be either acute and catastrophic or chronic and insidious.

The best known effect is the precipitation of occluding or partially-occluding thrombi. The disruption of tissue by the haemorrhage liberates thromboplastic substances which,

TABLE I  
RELATIONSHIP OF LIPID IN CORONARY ARTERIES TO MORPHOLOGICAL GRADE OF SCLEROSIS

Grade	Minimal	Moderate	Severe
Lipid (mg. per 100 mg. of wet tissue)	2.4	4.3	6.1 x
	3.4	5.0	3.6
	3.1	4.2	10.0 x
	7.1	5.6	13.1
	6.3	5.3	5.4 x
	6.9	4.9 x	6.8 x
	3.9	5.3	5.1 x
	4.4	4.8 x	8.3 x
	8.5	7.7	8.5 x
	5.1	2.2	7.3 x
	5.2	3.3	11.5 x
	5.1	4.6	6.2 x
	5.7	6.5	6.6 x
	3.7	4.1	4.3 x
	2.6	2.8	6.1
	2.7		2.1
	4.0		6.6
	3.7		
	2.8		
	4.9		
Average	4.6 ± 0.4	4.7 ± 0.4	6.9 ± 0.7

Minimal: Severe P < .01

Moderate: Severe P < .01

Minimal: Moderate P > .1

Note: Each figure represents the concentration of extractable lipid in the entire epicardial portions of the major coronary arteries from a single individual. The arteries were graded morphologically and stripped of their outer coats prior to lipid extraction. The symbol (x) denotes evidence of coronary occlusion.

if proper conditions of eddying or stasis of blood exist, initiate the primary thrombus deposit in the lumen of the artery. The thrombus may remain small and nonocclusive; and in this event it should undergo organization and eventually be converted into a crescentic-shaped mass of collagenous tissue. On the other hand, it may enlarge progressively by recurrent deposits of thrombus material until the lumen is completely occluded. The eventual fate of these occlusive thrombi is like that of the mural type: they organize into a dense mass of collagenous tissue, traversed by newly-formed blood channels, and the end result is a fibrous plaque which permanently stenoses the arterial lumen to a significant degree. The "sclerosing" effect of arterial thrombi is thus a very obvious one. Everyone who has worked intensively on the subject agrees that these thrombi are usually precipitated by intramural haemorrhages.<sup>1, 2, 3, 4, 5, 6</sup> Scepticism still exists, of course, in certain quarters. Some pathologists will concede that an intramural haemorrhage may initiate thrombosis in certain cases, but they are not impressed with its frequency in this respect. However, from a consideration of the data in table 3, it would appear that the incidence of intramural haemorrhage in any series of cases of coronary thrombi will depend entirely upon the pains that are taken in searching for



TABLE II  
COMPARISON OF POSTMORTEM FINDINGS IN CORONARY ARTERIES WITH THE ANTEMORTEM BLOOD LIPID LEVELS

Autopsy number	Age	Postmortem tissue findings				Antemortem blood findings		
		Grade of sclerosis	Resultant lesions	Extractable lipid		Cholesterol	C/P ratio	Sf 12-20
				Total	Per cent			
				mg.	%	mg. %		mg. %
A-70-53	84	+++	Thrombus	274.5	14.0	226	.96	28
A-79-53	80	+++	Infarct	43.8	3.3	285	1.13	47
A-91-53	70	+++	None	71.8	5.3	265	1.07	33
A-75-53	64	++	None	64.0	2.8	206	1.05	42
A-82-53	84	++	Infarct	103.5	5.3	138	.81	27
A-55-53	55	+	Infarct	98.0	4.7	197	.91	24
A-63-53	74	+	Sudden death	41.0	4.7	190	.94	27
A-68-53	74	+	None	23.0	3.8	247	.91	59
A-111-53	74	+	None	70.8	4.4	223	1.02	60
						218	1.01	63
						167	.91	63

Note: These are the first fatalities in a series of over 700 patients permanently confined to our hospital, on whom blood lipid studies are being carried out at least twice a year. At death and autopsy the degree of atherosclerosis of the coronary (and other) arteries is determined morphologically, and thereafter the lipid content of the arteries is determined by chemical means. The antemortem and postmortem findings are then compared.

them. If thrombosed segments of arteries are sectioned serially at close intervals the incidence of haemorrhage in relation to thrombus is as high as 90 per cent; but if only occasional random sections are studied through the thrombus the incidence falls to less than 20 per cent. Intramural haemorrhages are often quite small, so small that they can only be demonstrated by special techniques, including serial section. If they were usually large, and easily demonstrable by random sections, they would probably have been observed and described long before 1936.

A second important effect of intramural haemorrhage is to accelerate the atherosclerotic process. The addition of blood to a plaque must increase its bulk. When the haem-

TABLE III  
INCIDENCE OF INTIMAL HAEMORRHAGE IN CORONARY THROMBOSIS USING DIFFERENT PATHOLOGICAL TECHNIQUES

Investigator	Pathological technique	Cases of thrombosis studied	Intimal haemorrhages	
			Number	Per cent
Paterson	Serial section at short intervals	58	52	89
Horn and Finkelstein	Many sections	123	64	52
Nelson	Many sections	10	9	90
Paterson	Many sections	34	21	62
Yater <i>et al.</i>	Occasional sections	158 (?)	26 (?)	16

orrhage is massive, the enlargement may be so great that arterial insufficiency results. As a rule, however, the haemorrhages are small. Single small haemorrhagic episodes will produce little effect on the size of an atherosclerotic plaque, but if they are recurrent into the same plaque the end result should be a perceptible increase in its size. The enlargement will result from the gradual accumulation of the solid elements of the blood (blood lipids, haemosiderin, etc.), and from fibrous tissue proliferation. The accelerating effects of intramural haemorrhage can thus be laid in part to organization of the clot, in part to the deposition of lipid, etc., and in part to tissue reaction to residual materials. Recurrent haemorrhages into the same plaque seem to be fairly common: blood elements in different stages of dissolution can often be seen in a single lesion, and this must mean that the haemorrhages are repetitive. The repetitive nature of the lesions can be easily explained: the organization of an intramural haemorrhage will be accompanied by granulation tissue formation with a focal increase in capillary ingrowth of the intima. Thus, as Ogilvie<sup>17</sup> aptly remarks, "vascularization of the intima initiates a vicious circle whereby haemorrhage stimulates repair and repair predisposes to haemorrhage." It would be wrong to attribute all of the progression of the atherosclerotic process in man to these haemorrhagic episodes, but from the evidence available they deserve more attention than they have received in the past.

Evidence has recently come to hand that intramural haemorrhage in certain arteries may have a third major effect—the initiation of widespread nerve reflexes with the production of vasomotor collapse and sudden death. Durlacher's findings in this respect are impressive.<sup>7</sup> He has used special clearing techniques on the coronary arteries of individuals who died suddenly, and finds that fresh intramural haemorrhages are almost invariably present in the cases with coronary atherosclerosis while they are absent in those individuals who die from obvious extracardiac causes. Durlacher offers no explanation for this phenomenon, but the mechanism given above deserves consideration.

#### *The Incidence of Intramural Haemorrhage*

The sequelae of intramural haemorrhages listed above, and in particular their accelerating effect upon the atherosclerotic process, have been viewed in the past with some scepticism; and this stems, apparently, from an imperfect understanding of the frequency with which haemorrhages are found in human arteries. They are not encountered in atherosclerotic lesions in animals (except in the dog), and this may explain the current lack of interest amongst experimentalists in their possible effects. Actually, however, fresh haemorrhages are commonly seen, at autopsy, in the aorta, and in the coronary, cerebral, and peripheral arteries of man. When the coronary arteries are studied by serial sections, intramural haemorrhages, of varying sizes, have been found in 46 per cent of 142 consecutive autopsies on men and women over the age of 40 years.<sup>8</sup> Willis<sup>9</sup> has studied the femoral arteries of 152 autopsy cases, with an average age of approximately 60 years, and has found intramural haemorrhages, often multiple, in 36 per cent of the series. Crawford<sup>10</sup> has succeeded in demonstrating deposits of fibrin in unselected parts of the thickened intima in 27 out of 50 consecutive human aortas; he considers these deposits to be unorganized residues of mural thrombi, but concedes that they may represent haemorrhages in which the red cells have disintegrated.

Thus, from the evidence at hand, fresh intramural haemorrhages are a much more frequent complication of atherosclerosis than is popularly considered to be the case.

Having due regard for their transient nature, our ability to demonstrate fresh lesions in the arteries of at least one-third of older individuals, *at any one time*, suggests that they have occurred in large numbers during a lifetime. Recently,<sup>18</sup> we have obtained some indirect evidence indicating that intramural haemorrhages of an older type may be extremely common, in early plaques as well as advanced ones. On exposing the lower thoracic human aorta to a modification of the Prussian blue reaction, areas of discoloration appear in many atherosclerotic plaques which appeared in the gross to be free from haemorrhage (fig. 1). We interpret these discolorations as being due to ferric iron. They are particularly frequent in pearly plaques, but are also found in older lesions where they often appear to encircle the plaques. The origin of these iron deposits has not yet been established, but the most reasonable explanation is that they result from the leakage of blood into tissues—from capillary rupture and intramural haemorrhage. If this is true, then these haemorrhages are extraordinarily frequent in the earlier stages of the human disease; they are not, as is popularly believed, merely the inevitable sequelae of end-stage atherosclerosis. At all events, any theory on the pathogenesis of human atherosclerosis must be competent to explain the presence in early and late lesions, not only of lipid and fibrous tissue, but of iron as well.

In summary, then, intramural haemorrhages appear to be the usual immediate cause of acute arterial occlusion (and perhaps of vasomotor collapse with sudden death), and

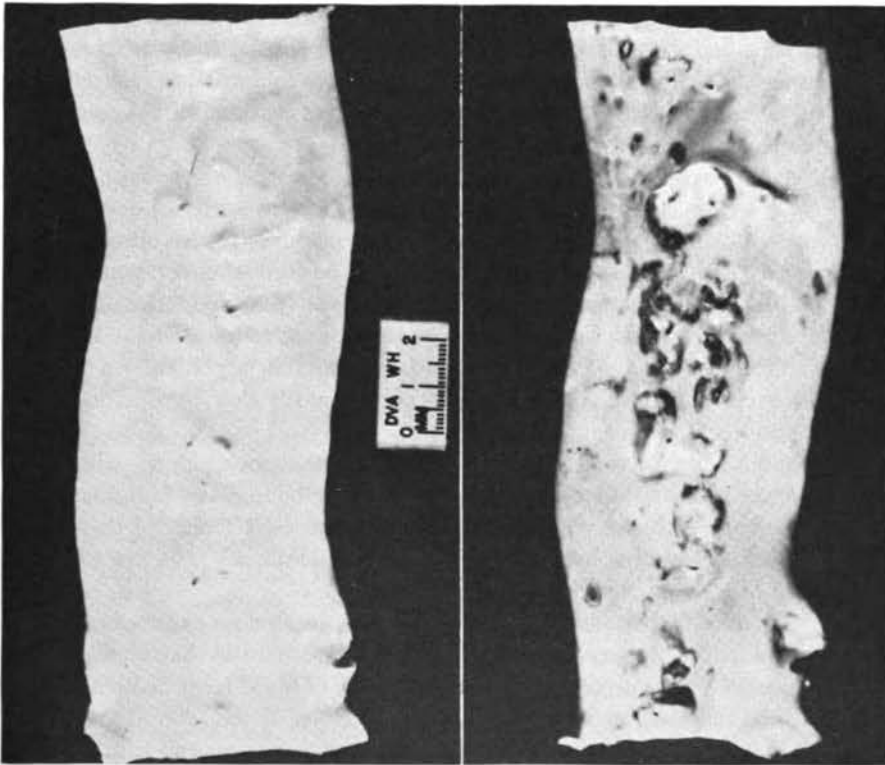

FIG. 1.—Segment of human thoracic aorta, reproduced from a coloured photograph (Ektachrome type B) using a Wratten F filter. Left, before exposure to Prussian blue reaction; right, after exposure.

when repetitive they may be important "sclerosing" and "lipid-depositing" factors in progressive atherosclerosis. The tendency to intramural haemorrhage may thus explain, in large part, why atherosclerosis achieves casualty-producing proportions in some individuals while in others it remains minimal in severity. If true, an examination of the mechanism of production of intramural haemorrhage is urgently needed, and this resolves itself into a study of the causes of capillary ingrowth into atherosclerotic plaques, and of the reasons why these capillaries rupture.

#### *The Mechanism of Vascularization of Atherosclerotic Plaques*

It should be borne in mind that everyone, certainly every adult, harbours the stigmata of early atherosclerosis in some part of his arterial system. Small deposits of lipid and fibrous tissue have thickened the intima, and it is at this time that a new blood supply to the arterial wall apparently develops. The intima, previously avascular, now develops a network of capillaries which are usually derived from the lumen of the artery although they may sometimes anastomose with the vasa vasorum in the media and adventitia. The direct origin of these newly-formed capillaries from the arterial lumen has been demonstrated repeatedly by serial section<sup>1, 2, 15, 16</sup> and by special injection techniques.<sup>11</sup> The exact cause of capillary ingrowth into plaques is not known, but the popular view is that it is an adaptive device to supply the extra nutritional demands of the abnormally thickened intima, an intima so thick that the normal mechanism of imbibition no longer suffices. If true, the prevention of intimal vascularization will only be achieved by the eradication of atherosclerosis, of even the minimal type, from the human race. And if the earliest lesions in human atherosclerosis are adaptive in nature, as referred to by Dr. Duff in this symposium, then the possibilities of ever preventing intimal vascularization appear remote.

#### *The Mechanism of Capillary Rupture*

The causes of capillary rupture in atherosclerotic plaques are also obscure. They will probably not be definitely established until they can be studied under controlled experimental conditions, and studies of this type must await the production of the human form of atherosclerosis, with vascularized plaques, in susceptible animals. In the meantime, indirect evidence from human and animal material is gradually accumulating, although progress along these lines has been extraordinarily slow considering the importance of the subject.

It seems safe to assume that capillaries within atherosclerotic plaques will be exposed to the same hazards as capillaries in other parts of the body. They will dilate and rupture if the pressure of blood within their lumina is excessively high, if they are inadequately supported by adjacent tissues, or if their endothelial cells are weakened by disease. Each of these factors deserves our attention.

Persistent arterial hypertension would seem to be an obvious cause of capillary rupture in atherosclerotic plaques. Intimal capillaries are peculiar in that they arise directly from the lumen of a large artery in which the pressure of blood is normally high, and this pressure will be reflected into the capillaries themselves. If the arterial pressure is elevated, as it is in hypertension, the danger of capillary dilatation and rupture should be increased. And the same effect, to a degree, should be produced by the transient elevations in blood pressure that occur with stress. The pathological evidence supports these

assumptions. Intramural haemorrhages of the coronary arteries, with and without coronary thrombi, have been found to be much more numerous in individuals with persistent hypertension than in those with normal blood pressures.<sup>8</sup> However, direct information on the breaking point of capillaries in different parts of the body, and under varying conditions of nutrition and health, is almost entirely lacking; and it is suggested that this might be obtained by biophysical studies on exposed capillaries in animals (and perhaps in man) using the technique of Clark<sup>12</sup> or of Algire.<sup>13</sup> The effect of elevated blood pressure on the rupture of capillaries in atherosclerotic plaques should be of interest to the Air Force. Very high pressures in the abdominal aorta and arteries of the lower extremities must at times be produced in pilots of modern high-speed aircraft; and recurrent intramural haemorrhages, with accelerated atherosclerosis, in these locations should theoretically be the result.

The weakening of the capillary endothelium by disease, so that rupture occurs at comparatively low pressures, is another point that deserves investigation. Increased capillary fragility may arise in various ways—from focal inflammatory conditions in the vessel wall, from toxic influences of a more general nature, from advancing age, from nutritional disturbances, and from hormonal imbalance. Some of these factors cannot be corrected, or even investigated; but inadequate nutrition and hormonal imbalance can. Avitaminosis C is an obvious cause of intramural haemorrhage, but whether or not minor deficiencies in this vitamin will favour capillary rupture has never been determined. Recent studies by Kramár<sup>14</sup> suggest that adrenocortical dysfunction after stress may also play some part in increasing capillary fragility. He found that rats (and men to a lesser degree) which are exposed to stress show a short period of increased capillary resistance followed by a prolonged period of markedly lowered resistance. The point of interest is that this second, dangerous period can be abolished by cortisone, but not by ACTH. The possible application of this interesting finding to the mechanism of production of intramural haemorrhage in the arteries of man is intriguing.

## REFERENCES

1. Paterson, J. C.: *Arch. Path.* 22: 313, 1936.
2. Paterson, J. C.: *Arch. Path.* 25: 474, 1938.
3. Paterson, J. C.: *Progress in Fundamental Medicine*, edited by J. F. A. McManus, Philadelphia, Lea and Febiger, 1952.
4. Wartman, W. B.: In *Amer. Assoc. Advancement Sci.*, Publ. No. 13, 1940, p. 122.
5. Horn, H., and Finkelstein, L. E.: *Am. Heart J.* 19: 655, 1940.
6. Nelson, M. G.: *J. Path. & Bact.* 53: 105, 1941.
7. Durlacher, S. H., Fisk, A. J., Fisher, R. S., and Lovitt, W. V.: *Circulation* 8: 446, 1953.
8. Paterson, J. C., and Holmes, R. B.: Unpublished observations.
9. Willis, G. C.: *Canad. M. A. J.* 67: 644, 1952.
10. Crawford, T., and Levene, C. E.: *J. Path. & Bact.* 64: 523, 1952.
11. Winternitz, M. C., Thomas, R. M., and LeCompte, P.: *The Biology of Arteriosclerosis*, Springfield, Ill., Charles C. Thomas, 1938.
12. Clark, E. R.: *Ann. Int. Med.* 9: 1043, 1936.
13. Algire, G. H.: *J. Nat. Cancer Inst.* 4: 1, 1943.
14. Kramár, J.: *Am. J. Physiol.* 175: 69, 1953.
15. Robertson, H. F.: *Arch. Path.* 8: 881, 1929.
16. Leary, T.: *Arch. Path.* 17: 453, 1934.
17. Ogilvie, R. F.: *Pathological Histology*, Edinburgh, E. & S. Livingstone Ltd., 1947.
18. Paterson, J. C., and Moffatt, T.: To be published.

## DISCUSSION

*Dr. Page* asked at how early an age the hemorrhages had been found.

*Dr. Paterson* replied that the youngest examined in his series of eight adults studied by the Prussian blue reaction was 40 years old and exhibited a minimal degree of atherosclerosis.

*Dr. Duff* reported that when hemoglobin in large quantities was injected intravenously into atherosclerotic rabbits it was taken up by the atherosclerotic plaques and converted into a substance that gave a positive Prussian blue reaction. He suggested that circulating iron taken up by the plaques might account for the blue staining described by *Dr. Paterson*.

*Dr. Paterson* stated that he had considered that possibility, but noted that only portions of some plaques were involved in the staining, while others were uninvolved. Assuming that most of the plaques have foam cells about them, he questioned whether only certain cells would take up iron and others would not.

*Dr. Taylor* asked whether *Dr. Paterson* considered that the rupture of intimal vasa vasorum was due solely to lateral pressure, or whether the quality of the tissue surrounding the vasa vasorum was a factor.

*Dr. Paterson* exhibited slides to answer this question, and suggested that intracapillary pressure, capillary fragility, and the quality of the supporting tissues would each play a part.

He stated that the plaques shown were not the sites of fresh intramural hemorrhages, but probably of old hemorrhages in which the amount of shed blood was perhaps quite small.

*Dr. Surgenor* pointed out that the iron involved in the staining reaction is probably not heme, but iron associated with the beta-1 iron-binding globulin of plasma. He suggested that an antiserum to the iron-binding protein might be used to determine whether iron was entering with the protein.

*Dr. Kellner* had found intramural hemorrhages to be common, but had seen them only in association with pre-existing atherosclerosis. He asked *Dr. Paterson* whether he had seen the hemorrhages in the absence of atherosclerosis, and whether they were a complicating or a precipitating factor.

*Dr. Paterson* felt it unlikely that the Prussian blue reaction would be found in the fibrous plaques of infants. He did not believe that the iron-staining change initiated the process, but it seemed to occur quite early in the disease.

*Dr. Winternitz* added that the changes could be produced in the dog or the rabbit by ligation of the renal artery. In reply to *Dr. Page's* question whether diseases characterized by increased capillary fragility are associated with iron staining of the vessel, he pointed out that the staining is frequently exhibited in the adventitia around atheromatous plaques, in macrophages that wander out from the lesion.

*Dr. Waters* asked *Dr. Paterson* whether he had been able to differentiate the lesions of individuals who had severe hypertension from those who did not.

*Dr. Paterson* replied that he had not, but that he expected to be able to make the differentiation.

*Dr. Waters* felt that hemorrhages in arterial lesions in hypertensive animals were due to an added factor of necrosis or other tissue change. He pointed out that in hypertensive dogs, arterial hemorrhages occurred frequently in areas of medial necrosis. After a vas-

cularized granulation tissue had been experimentally produced in the arterial intima of dogs, and severe episodes of hypertension subsequently had been induced with epinephrine, hemorrhages occurred as frequently and were as extensive in the control lesions as in those exposed to increased intravascular pressure. He emphasized that the experimental granulations are not necessarily comparable to atheromatous granulations in the human disease.

*Dr. Eder* questioned whether it was possible to differentiate histologically between the arterial lesions of subjects with hypercholesterolemic xanthomatosis and those of subjects with atherosclerosis without hypercholesterolemia.

*Dr. Paterson* replied that human familial xanthomatosis greatly resembles cholesterol-induced atherosclerosis in the rabbit. He had seen foam-cell depositions in various parts of the body in those cases, but not in ordinary human atherosclerosis.

*Dr. Eder* remarked that patients with the nephrotic syndrome may have early atherosclerosis that is quite indistinguishable from the common type of atherosclerosis.

*Dr. Lansing*, in reply to a question by *Dr. Anfinsen*, stated that the changes in elastin and in the fibrous network that he had observed in the early stages of the disease showed very good correlation with arteriosclerosis in young diabetics.

*Dr. Katz* questioned the amount of information that could be obtained from a spot check of the terminal stage of disease as to what was going on in living tissue. In response to a question whether he had observed coronary thrombosis or cardiac infarcts in cholesterol-feeding experiments in animals, he said that he had not.

*Dr. Paterson* emphasized that there is a difference between the disease in the chicken and that in man.

*Dr. Taylor* added that coronary arterial disease in the rabbit is unlike that in man. Rabbits develop medial accumulation of lipids in the intramural myocardial arteries. In some instances, the lumina are occluded by this process and small myocardial infarcts develop.

*Dr. Andrus* pointed out that experimental animals in cages are under recognized stress.

*Dr. Duff* reminded *Dr. Katz* that the pathologist observes intermediate as well as terminal stages of disease.

# THE REACTION OF ARTERIES TO INJURY BY PHYSICAL AGENTS\*

## With a Discussion of Arterial Repair And Its Relationship to Atherosclerosis

C. BRUCE TAYLOR

In 1883, Richard Thoma<sup>1</sup> described intimal proliferation or thickening of arteries as a compensatory mechanism for a weakening and loss of elasticity of the middle arterial coat. According to his views, an artery, under the influence of blood pressure, developed an outward bulging at a point of loss of structural integrity of the media. This rendered the artery too wide for the needs of the part supplied; hence, the vessel developed an intimal thickening to restore its original caliber. Thoma's concepts of vascular repair have been confirmed by a number of investigators employing various methods for injuring the medial coat.<sup>2, 3, 4</sup> The reactions of arterial walls to injuries produced by various physical agents have been reviewed through 1944.<sup>5, 6, 7</sup> In the following discussion, I will cite pertinent data from earlier reviews and studies published since then.

### *General Pattern of Arterial Repair*

Hass, Baldwin, and I<sup>8, 9</sup> have recently made a careful analysis of the sequences of degeneration and repair of areas of focal arterial injury in rabbits on a normal vegetarian diet. A summary of these studies will introduce the general pattern of repair of arterial tissue.

In anesthetized, juvenile rabbits, small aortic and arterial segments were frozen with a needle cooled by expanding carbon dioxide.<sup>8</sup> The animals were sacrificed at intervals ranging from one to twenty-four weeks after vascular injury. Serial microscopic sections of lesions revealed constant patterns of degeneration and repair.

Immediately after freezing, an aneurysmal dilatation occurred at the site of injury. This was the result of death of smooth muscle cells within the media. Disintegration of cells in the media was practically complete at the end of two weeks (fig. 1, left). Degeneration of elastic lamellas followed disintegration of smooth muscle. Individual elastic fibers within the media lost their normal wavy contour and became straight, fragmented, and fused (fig. 1, left). The internal elastic membrane appeared to remain undamaged. The external elastic membrane also retained its wavy form, but frequently was incorporated as a discontinuous membrane in fibrous tissue of the thickened adventitia. Calcification of the media, a common finding, first appeared as small granules along the margins of elastic lamellas (fig. 1, left).

From the point of view of restoration of function, the principal reaction of the aortic wall to injury was restricted to the intima. This regenerative reaction was not accompanied by the usual signs of inflammation. Cells, fibroblastic in form, were observed in limited numbers in the intima two weeks after injury (fig. 1, left). Proliferation of these

\* The experimental work described in this paper was supported by grants from the Otho S. A. Sprague Memorial Institute and the National Heart Institute. This work was done at the Rush Department of Pathology, Presbyterian Hospital, Chicago, in affiliation with the University of Illinois College of Medicine. I wish to acknowledge the enthusiastic collaboration and help of Drs. George M. Hass, David Baldwin, and Frank B. Kelly, Jr. The photomicrographs are reproduced by courtesy, of the A.M.A. Archives of Pathology.



intimal cells was most marked during the third and fourth weeks following injury and was apparently complete after four weeks (fig. 2, left). Intimal proliferation extended around the circumference of the lumen and equalled the old wall in thickness. The proliferated intimal cells served as a matrix for regeneration of other elements of vascular tissue. Collagenous and elastic fibrils quickly appeared between proliferated cells in the intima. At five to six weeks elastic tissue had acquired the arrangement and form of elastic lamellas normally found in the media of the aorta (fig. 2, right). After the third to fourth week the proliferated intimal cells began to assume characteristics of smooth muscle cells (fig. 3, left). This process was usually complete at six weeks. Formation of a new, second internal elastic membrane, beneath the endothelium, was a slower process beginning at the fifth week and apparently complete at about 12 weeks (fig. 4, left). After the twelfth week, a new aortic wall, almost indistinguishable from that of the original undamaged vessel, had regenerated in the framework of the proliferated intima (figs. 3, left and 4, left). Local aneurysms observed after freezing aortic segments were obliterated within a few weeks.

Similar studies in senile rabbits revealed that proliferation of intimal cells was less marked; hence, there was an inadequate matrix for regeneration of a new aortic wall.<sup>9</sup> In lesions as old as 24 weeks, aneurysmal sacs were only partly filled in by new intimal vascular tissue. There was no qualitative difference between new intimal vascular tissue of juvenile and senile rabbits. Formation of heterotopic bone and cartilage in the aortic adventitia was common in senile rabbits. Calcification of the degenerated media (fig. 3, left) which was marked in juvenile rabbits was less conspicuous in senile rabbits.

#### *Physical Agents Causing Arterial Injury*

Several physical agents are uniquely ideal for experimental studies on arterial injury and repair because of their specificity of location, intensity, and time of application. Most other methods employed for the production of arterial injury cannot be confined to a specific arterial segment nor can they usually be as carefully controlled as to the time and degree of injury.

Although the role of physical injuries in the genesis of arteriosclerosis is not completely established, there are many experimental, clinical, and autopsy findings which suggest that multiple minute arterial injuries may contribute to the development of this disease. Physical agents causing vascular injury fall into five major groups: 1. Electric injury; 2. radiation injury; 3. injury from heat and cold; 4. direct mechanical injury; and 5. indirect injury from forces applied to the body generally.

*Electric Injury*—Medial necrosis of carotid arteries has been observed experimentally six days after several prolonged periods of electric stimulation with accompanying arterial spasm and ischemia.<sup>2</sup> Arterial necrosis with rupture of the radial and popliteal arteries has been described in man following electric burns.<sup>10</sup> Thrombi have been produced in normal aortas of dogs by creating small differences in the electric potentials across their walls.<sup>11</sup> They form near the positive electrode. A search for minor degrees of injury of the aortic walls would have been of interest in this study.

*Radiation Injury*—The effects of ionizing irradiation on vessels have been reviewed by Warren.<sup>12</sup> Endothelium is described as being most sensitive to irradiation; consequently small vessels having large endothelial components show greatest changes following irradiation. Marked endothelial proliferation with narrowing or obliteration of the

lumina and thrombi are observed in smaller vessels. Larger arteries rarely show evidence of injury when doses of irradiation are less than 500 r. Following doses exceeding 1200 r, larger arteries show degeneration of elastic lamellas, replacement of smooth muscle cells by connective tissue, and intimal thickening. Eventual complete recovery without structural changes is observed in larger vessels when doses of irradiation are 1200 r or less.

Irradiation of young mice with 410 r (31 r/min.) has produced changes in elastic arteries that are histologically comparable to those of physiologic aging.<sup>18</sup> Elastic arteries showed premature fraying of elastic lamellas with an increased number of interlamellar fibers and increased amounts of ground substance. This method for producing vascular injury appears promising. Animals with hypercholesterolemia should be studied following this type of injury.

*Injury from Heat and Cold*—During the past fifty years numerous investigators have produced focal arterial lesions by cauterization.<sup>3, 4, 5</sup> Ssolowjew<sup>4</sup> found that such injury by cautery produces variable reactions. When all cellular elements in a portion of an artery's circumference are destroyed but the elastic framework remains intact, regenerative proliferation of cellular elements from adjacent undamaged portions of arteries occurs. These regenerating cells are found between the remaining medial elastic lamellas and in the subendothelium. Elastic tissue and cells having the appearance of smooth muscle cells are found in the thickened intima. If both cellular elements and the elastic framework are destroyed the wall is replaced by granulation tissue.

Local cold injury has been employed for the production of segmental arterial lesions in rabbits.<sup>8, 9, 14</sup> I have partially summarized these studies above; they will be discussed more fully in connection with arterial repair later. Since 1950 considerable work has been done on cold injury or frostbite, and recent reviews on clinical<sup>15</sup> and experimental studies<sup>16, 17</sup> are available. Friedman and others describe sequential changes in capillaries and arteries of rabbits' legs after experimental frostbite.<sup>18</sup> Early changes consist of hyaline thrombi; later there are evidences of medial necrosis and inflammation with thrombosis and endothelial proliferation; the final stages show endangiitis obliterans.

*Direct Mechanical Trauma*—Direct mechanical trauma of arteries, such as pinching and pulling, has been employed by a number of investigators; these studies have been reviewed.<sup>5</sup> Ssolowjew<sup>19</sup> described a unique method for producing small tears in arterial elastic lamellas. He transposed the carotid arteries of rabbits into the subcutaneum of the neck. Fixation of these vessels in this abnormal location for some time resulted in small transverse tears involving only one or several elastic lamellas. Healing was accomplished by subendothelial proliferation and formation of elastic and collagenous fibers in a thickened intima.

Surgical anastomoses of large arteries and transplantation of autologous, homologous, and heterologous arterial segments represent forms of direct mechanical arterial injury that have been studied extensively in recent years. Schloss and Shumacker<sup>20</sup> and Coleman and others<sup>21</sup> have reviewed studies on arterial transplantation published during the past six decades. Investigators agree that, in experimental animals, fresh autologous arterial grafts remain viable and that heterologous and homologous grafts undergo degeneration and are reinforced by connective tissue proliferation from adjacent tissues. Elastic tissue in transplanted homologous and heterologous grafts persists for long periods and shows slow, progressive, degenerative changes.<sup>20-24</sup> Repair at simple anastomotic sites or at sites of anastomoses of grafts consists of fibroblastic proliferation into

fibrin clots that form at the suture-lines. In all grafts an intimal fibrous layer grows tongue-like from the anastomotic sites towards the central portions of the grafts.<sup>20-25</sup> Arterial autografts have usually shown a thickened intima containing newly formed elastic fibrils.<sup>20</sup> Most investigators found no elastic tissue or smooth muscle in fibrous tissue scars at sites of anastomoses or in fibrous intimal scars in other types of arterial grafts.<sup>20-23, 25</sup> Elastic fibrils in fibrous intimal scars in arterial homografts have been described by Swan and others.<sup>24</sup>

Aneurysms and arteriovenous fistulas following direct arterial wounds have been observed clinically.<sup>26, 27</sup> Much has been written concerning arterial injury from mechanical forces within the arterial system. Hueper<sup>7</sup> has reviewed these studies, which include intrinsic hemodynamic forces and mechanical strain at sites of branching and of fixation to rigid skeletal parts. Most of this material is based upon analyses of human postmortem findings.

*Injuries from Forces Applied to the Body Generally*—When forces such as rapid deceleration, increased gravitational forces (G forces), and vibration are applied to an organism, the internal organs, circulating fluids, and soft tissues are forcefully displaced from their normal relationships with the rigid skeleton. Under these conditions arteries, which have points of fixation to both the skeleton and to organs or soft tissues, are subjected to abnormal tensile forces. During exposures to rapid deceleration and G forces, circulating blood is also forcefully redistributed within the vascular tree, resulting in increased intraluminal pressures.

Aircraft and some automobile accidents represent extreme forms of rapid deceleration. Hass<sup>28, 29</sup> has described lacerations of the aorta and its abdominal branches in fatal aircraft accidents. In some instances lacerations involved only one layer of the aorta. Reported cases of aortic rupture during rapid deceleration have been reviewed,<sup>30</sup> and aortic aneurysms following rapid deceleration have been described.<sup>31</sup> Extreme degrees of deceleration are currently being studied in primates.<sup>32</sup> Studies on human tolerances of rapid deceleration are also in progress.<sup>33, 34</sup>

Available data consist of studies on acute exposures to extreme degrees of rapid deceleration which have usually been fatal, and clinical evaluation of human tolerances of it. For full evaluation of the effects of rapid deceleration on vascular structures, one would need carefully controlled studies on animals, structurally similar to man, that had been exposed various numbers of times to graded degrees of rapid deceleration. It is possible that relatively minor exposures could produce very small arterial tears or lacerations which could only be demonstrated by careful microscopic studies. Repeated exposures to sublethal rapid deceleration could conceivably produce sufficient numbers of minute arterial tears to result in significant arterial disease.

Negative and positive G forces such as those encountered in aerial acrobatics are being actively studied.<sup>32, 35-38</sup> Studies on exposure to these types of G forces, which produce less severe degrees of downward or upward displacement of organs for more prolonged periods, have been reviewed.<sup>32</sup> Forceful displacement of blood subjects vessels to increased intraluminal pressures for moderately prolonged periods. Experimental studies indicate that vessels within the fixed cranial cavity are adequately protected from increased hydrostatic pressure during exposure to negative gravitational forces.<sup>35-37</sup> The cerebrospinal fluid and cerebral venous pressure increase simultaneously and proportionally with intracranial arterial pressure; thus, arteriovenous pressure differences

are no greater than those occurring under normal conditions. Intracranial hemorrhages occurring in experimental animals during exposure to negative G are thought to result from tears in meningeal vessels at points of entrance into the brain. Beckman<sup>38</sup> has suggested that negative G displaces the brain from its normal meningeal relations, resulting in these vascular tears. Exposure of humans to negative acceleration of 3 G for several seconds has caused distention and rupture of vessels about the head.<sup>38</sup> Sheer rupture of small vessels at the brim of the pelvis has been observed in a chimpanzee exposed to 40 negative G for 15 seconds.<sup>32</sup>

Here again full evaluation of effects of exposures to positive and negative G forces on the vascular system would require carefully controlled chronic studies on animals such as the chimpanzee. In-vivo studies on the effects of graded increases of intraluminal pressure in isolated vascular segments would be of interest and related to this problem. A few studies of this nature have been reported.<sup>38, 40, 41</sup>

The effects of long-term repetitive exposures to mechanical vibration on vessels and other structures have been reviewed.<sup>42, 43</sup> Neurovascular disturbances, with retarded rewarming of extremities after chilling, and changes in capillary filling and tortuosity have been the most striking changes in vessels.<sup>42, 43</sup> Studies on a limited number of cases indicate the occurrence of obliterative arterial disease following exposures to vibration.<sup>44, 45, 46</sup> Many more clinical and experimental data are needed to definitely determine the effects of vibration on vascular tissue. Experimental studies on rats are in progress.<sup>42</sup>

In explosive decompression and blast injuries only capillary hemorrhages, which are most pronounced in the lungs, have been described. Arterial injury has not been observed in experimental animals or in man.<sup>47, 48</sup>

#### *Arterial Repair in Man*

Restoration of functional arterial structure following injury or degeneration is achieved mainly through formation of new vascular tissue in the intima. There is ample evidence that, throughout life, man's arteries are undergoing continuous repair of small areas of medial injury or degeneration. Progressive thickening of arterial intima with increasing age is observed consistently in man<sup>49-51</sup> and in larger animals living five years or more.<sup>52</sup> Vessels subjected to greater pressures and other stresses show increased intimal thickening.<sup>50</sup> Factors implicated in loss of arterial structural integrity have been reviewed,<sup>5, 6, 7</sup> and include chemical and bacterial toxins, local and systemic nutritional factors, and degeneration or so-called "wear and tear" of aging. Duff<sup>6</sup> in 1935 proposed that ingestion of large amounts of cholesterol or cholesterol-rich foods may result in arterial injury in rabbits.

Since it appears that man is destined to have multiple, recurring, usually small medial arterial lesions, requiring repair primarily by intimal proliferation, we should try to determine whether conditions for re-establishment of structurally and functionally sound arterial channels are optimal or not.

*Human Arterial Elasticity: Its Changes with Age*—The progressive loss of human arterial elasticity with aging as described by Bramwell<sup>53</sup> does not indicate that present conditions for arterial repair are optimal. Elastic distensibility with subsequent recoil of aortic and arterial walls serves in a sense as a subsidiary pump to propel blood onward in a continuous stream during diastole; without arterial elasticity, peripheral flow of

blood would be intermittent. Bramwell's calculations<sup>53</sup> based on velocities of pulse waves indicate a fifty per cent loss in arterial elasticity between the ages of 10 and 60 years. Hass' studies<sup>54</sup> indicate that with increasing age, there are increased amounts of dense collagen in the intima and media which constrain aortic elasticity. According to Bramwell,<sup>53</sup> systolic pressure becomes increased with little change in diastolic pressure following loss of aortic and arterial elasticity. When a major artery with normal elasticity is subjected to normal blood pressures only the more distensible vascular elements are put on stretch. When greater pressures are applied, less distensible elements are put on stretch. Even in normal arteries, greater strain and injury are more probable at greater pressures; the increased incidence of arteriosclerosis in young hypertensive patients supports this concept. In older individuals, the aorta and its major branches probably sustain injuries much more frequently because they have markedly decreased distensibility and are also subjected to increased pressures in order to maintain an adequate stroke output.

When we consider the physiologic requirements of arteries, the quality of their repair tissue assumes considerable significance. I would like to discuss injury and repair as they appear to occur in man today. At this time, I shall not include atheromatous deposits occurring at sites of injury. Following medial injury or degeneration, in the aorta and its major branches, repair is usually accomplished by formation of inelastic hyalinized scar tissue located primarily in the intima and, to a lesser extent, in the media. This inelastic scar tissue reduces the quantity of functional elastic elements for distention during cardiac systole and later recoil during diastole. To compensate for loss of arterial elasticity the systolic pressure becomes elevated and the pulse pressure widened in order to maintain physiologic requirements. This results in arteries with decreased quantities of functional elastic elements being subjected to greater pressures in order to attain adequate arterial distention and recoil. These arteries, with decreased quantities of functional elastic elements, develop new sites of injury and degeneration when subjected to the greater pressures. With subsequent healing by formation of more inelastic scar tissue, the above conditions would be amplified and repeated again and again, resulting in progressive loss of arterial elasticity.

The dilated, tortuous, almost completely inelastic aorta and major branches, usually seen in older persons, probably represent the end result of this process. With losses in the elasticity of the aorta and its major branches, the physiologic requirements of distensibility and recoil of the arterial system are fulfilled by more peripheral arteries, which also begin to undergo arteriosclerotic changes.

#### *Factors Influencing Arterial Repair*

If arterial repair were accomplished in man by formation of highly elastic tissue, as occurs in normal young rabbits,<sup>8, 9</sup> the elasticity of the aorta and its major branches would probably tend to remain constant instead of decreasing progressively. The progressive marked loss of arterial elasticity in man implies an urgent need for evaluation and study of factors influencing arterial repair.

*Effect of Hypercholesterolemia on Arterial Repair*—Since man and the normal rabbit show differences in their levels of serum cholesterol and in their tendencies to develop atherosclerosis, my collaborators and I undertook a series of studies<sup>8, 9, 14</sup> to determine the effects that equalizing these differences might have upon arterial repair. I have

already discussed arterial repair in normal, vegetarian rabbits.<sup>8, 9</sup> In these animals arterial injury was followed by the formation of an essentially new arterial wall within a proliferating intima. This type of repair is rarely encountered in human arteries. In later studies<sup>4</sup> hypercholesterolemia and early atheromatosis were induced in rabbits before local arterial lesions were produced by freezing. It was felt that arterial repair under these conditions would simulate human conditions more closely. In these experiments a high incidence of localization of lipids or atheromatous deposits was observed at sites of injury in hypercholesterolemic rabbits (figs. 1, right; 3, right; and 4, right). In the aorta, atheromatous deposits were almost completely confined to the proliferated intima. They were rarely observed in aortic lesions less than 9 weeks old, and were most pronounced in lesions produced by freezing which were older than 16 weeks (figs. 3, right; and 4, right). Muscular arteries showed atheromatous changes either in the degenerate media alone or here and in the proliferated intima. Medial atheromatosis in muscular arteries was regularly accompanied by discontinuities in the internal or external elastic membrane.

It has been shown by others that hypercholesterolemic rabbits have a more rapid and abundant accumulation of lipids at sites of arterial injury than elsewhere. The earlier studies on this subject have been reviewed.<sup>6</sup> Duff<sup>6</sup> stated that in hypercholesterolemic rabbits "deposition of lipids in walls of arteries takes place only after the occurrence of a primary injury of the walls of the vessels." Recently Waters<sup>5b</sup> observed localization of infused human plasma lipids in coronary arteries of dogs following injury with chemical toxins.

The effects of hypercholesterolemia and the tendency toward atheromatosis on reparative processes in areas of arterial injury were most striking. In normal rabbits medial degeneration produced by freezing arterial segments was followed in a short time by intimal proliferation<sup>8, 9</sup> (figs. 1, left; and 2, left). In none of the normal animals was there evidence of elective localization of lipids at sites of injury. In normal rabbits, collagenous and elastic fibrils soon appeared in the proliferated intima (fig. 2, right), and cells in the proliferated intima assumed characteristics of smooth muscle cells (fig. 3, left). At about 12 weeks the proliferated intima had been transformed into an essentially new arterial wall lying within the old degenerate media (figs. 3, left; and 4, left). In hypercholesterolemic rabbits, repair of injury by regeneration of new vascular tissue in the intima was markedly altered and retarded. Sheets or scattered clusters of lipophages were found at all levels in the proliferating intima. In some lesions they were in a superficial location, while in others they were at the bases of lesions (figs. 3, right; and 4, right). Alterations in the newly formed fibroelastic intimal tissue were profound, and occurred in two forms. Lesions less than nine weeks old usually showed an intimal proliferate composed of a loosely reticular mucinous type of fibrillar collagenous tissue (fig. 3, right). This resembled the "mucinous degeneration" of collagen often found in human arteriosclerosis. Often no smooth muscle cells could be found, and fibroblasts and elastic tissue fibrils were much less numerous and poorly oriented. Older lesions showed a gradual transition to a homogeneous hyaline fusion of collagen fibrils resembling the "hyaline degeneration" of collagen encountered in human arteriosclerosis (fig. 4, right). The intimal proliferate consisted of a few degenerative fibrocytes surrounded by fused bundles of hyalinized collagenous fibrils. There were no smooth muscle cells, and elastic fibrils were infrequent, small, and poorly oriented. Comparison of figures 3, left and 4, left

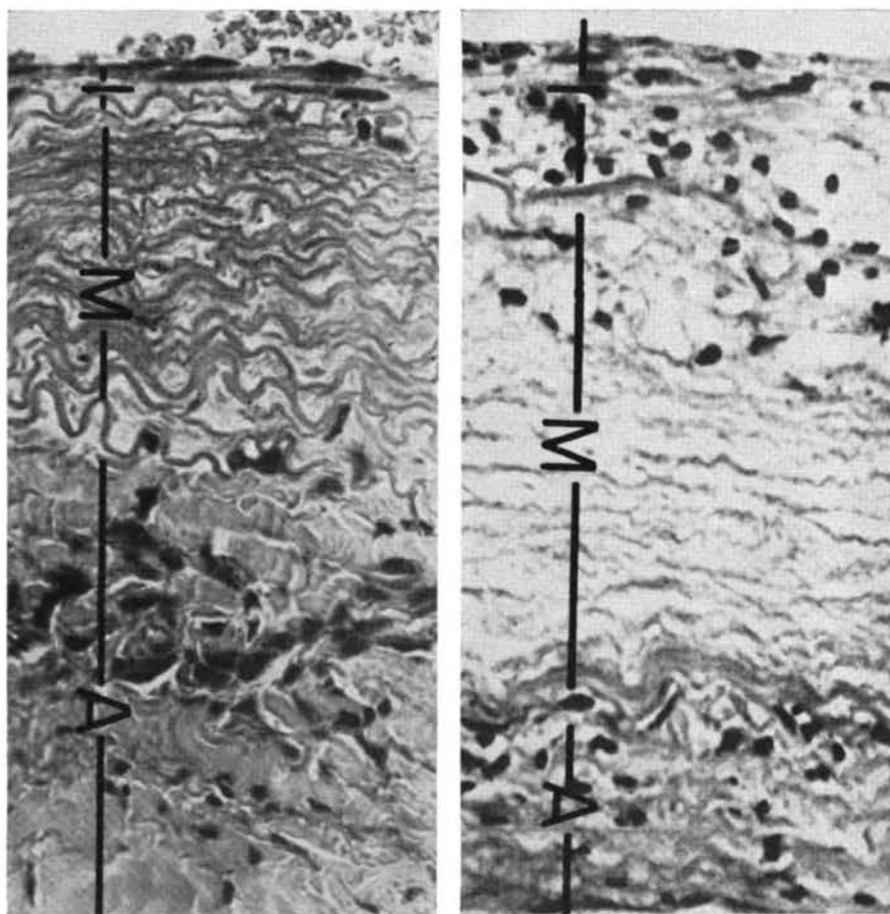

FIG. 1.—Left: Cross section of a lesion, 2 weeks old, produced by freezing the abdominal aorta of a juvenile rabbit on a normal diet. There is early proliferation of cells in the intima (I). Note the complete absence of localization of lipids in the intima and media (M). Elastic lamellas of the media (M) show discontinuities and variability in thickness, spacing, and undulation. Remnants of degenerated smooth muscle cells have largely disappeared. Granules of calcium are barely distinguishable in the interlamellar matrix of the media. Collagenous fibrils of the adventitia (A) are increased and fused into homogeneous bundles surrounding fibroblasts and mononuclear inflammatory cells.

FIG. 1.—Right: Lesion, 2 weeks old, produced by freezing the lower portion of the abdominal aorta of a rabbit with a blood cholesterol level of 640 mg. per 100 cc. While 9% of the intima of the thoracic aorta was involved by atheromas, there were no microscopically demonstrable spontaneous atheromas of the lower portion of the abdominal aorta. The extent of the proliferated intima (I), the degenerate media (M), and the adventitia (A) are indicated. Note the infiltration of lipophages throughout the proliferated intima and the immediately adjacent media. This shows the maximum degree of interruption and distortion of intimal proliferation, as well as the early elective localization of lipids at the site of injury and repair of the aortic wall. The partial preservation of the elastic networks of the degenerate media shown here is a constant finding at the site of lesions produced by freezing the aorta. Localization of lipids at sites of injury became more pronounced in older lesions and was most marked in lesions studied 16 weeks after freezing.

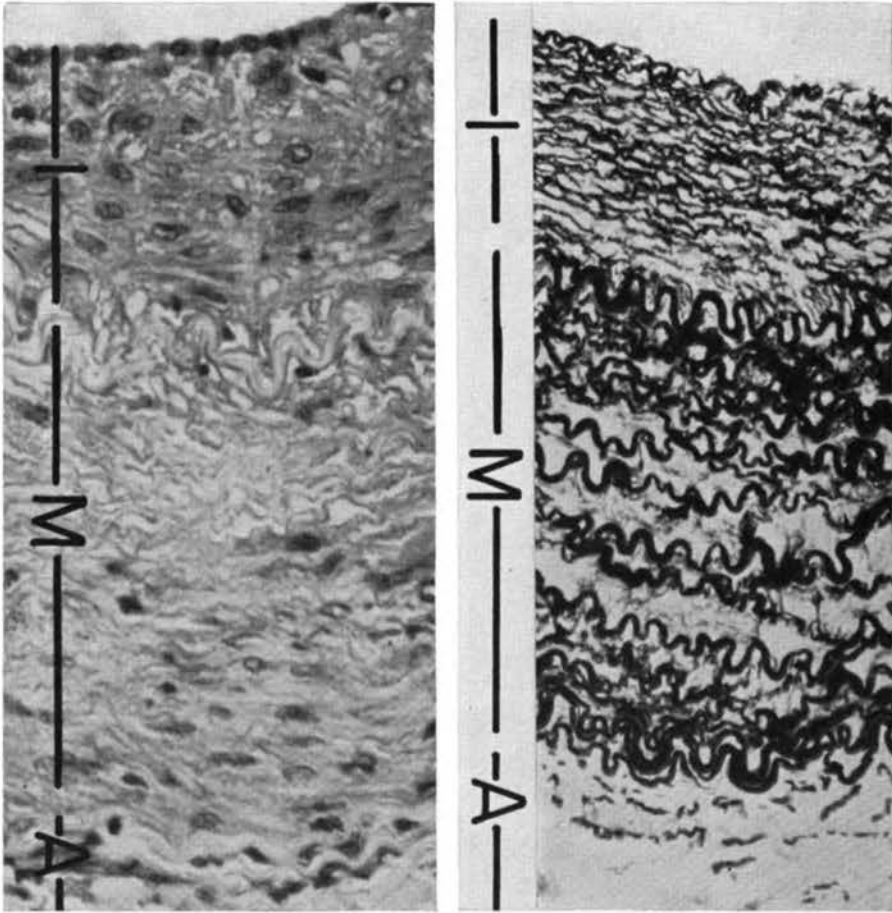

FIG. 2.—Left: Cross section of a lesion, 3 weeks old, produced by freezing the abdominal aorta of a juvenile rabbit ingesting a normal diet. There is evidence of active proliferation of the intima (I) with numerous elongated cells, differentiating into smooth muscle cells, and an abundant intercellular fibrillar matrix. The media (M) shows irregular elastic lamellas and loss of smooth muscle. Fibroblasts, some of which eventually differentiate into smooth muscle cells, have grown between remnants of elastic lamellas in the outer one-half of the media. Wavy outlines of persistent internal and external elastic membranes are detectable. The adventitia (A) resembles that of figure 1, left.

FIG. 2.—Right: Elastic tissue (Weigert) stain of an aortic lesion, 5 weeks old, produced by freezing the abdominal aorta of a juvenile rabbit on a normal diet. The proliferated intima (I) contains many thick fibrils which have become oriented to resemble thin medial elastic lamellas. At about 12 weeks elastic tissue in the proliferated intima had structure very similar to that of the medial coat of a normal aortic segment. Elastic lamellas of the media (M) apart from the internal and external elastic membranes are discontinuous, fused, irregular, and distorted. Elastic tissue of the adventitia (A) appears normal.

with figures 3, right and 4, right illustrate the marked differences between arterial repair in normal and hypercholesterolemic rabbits. It seemed that the presence of lipids had in some way modified the nature of the newly formed collagen and, perhaps indirectly, the elastic tissue. Simultaneously, the proliferating and mature cells of the intima were adversely affected.



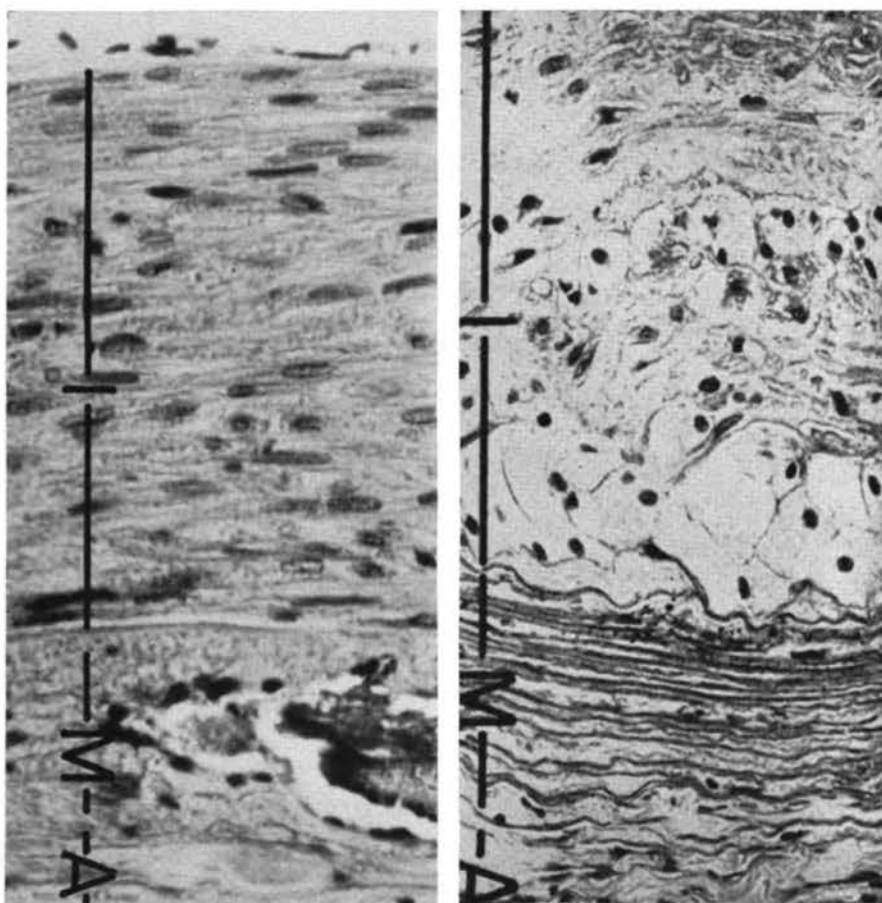

FIG. 3.—Left: Cross section of a lesion, 12 weeks old, produced by freezing the abdominal aorta of a juvenile rabbit ingesting a vegetarian diet. The intima (I) at this stage is as thick as the original undamaged media. There is no localization of lipids in the lesion. It is composed principally of parallel smooth muscle cells lying between thick lamellas of elastic tissue. The badly damaged media (M) is largely occupied by masses of calcium, which are surrounded by macrophages and dense fibrous tissue. The adventitia (A) is composed of dense bundles of fused collagenous fibrils.

FIG. 3.—Right: Lesion, 26 weeks old, produced by freezing the wall of the lower abdominal aorta of a rabbit with an average blood cholesterol level of 1,090 mg. per 100 cc. In hypercholesterolemic animals, lesions less than nine weeks old usually showed this "mucinous" degeneration of the proliferated intima. In this animal, 70% of the intima of the thoracic aorta was involved by atheromas, and there were no microscopically demonstrable spontaneous atheromas of the lower part of the abdominal aorta. The extent of the proliferated intima (I), the degenerate media (M), and the adventitia (A) are indicated. Note that the lipophage infiltration is restricted to the inner one-half of the proliferated intima. Comparison with figure 3, left, demonstrates the marked alteration in the intimal repair following freezing of the aortic wall. Fibroblasts are less numerous, and the newly formed fibroelastic tissue has a peculiar loose reticular character resembling that found in "mucinous" degeneration of proliferated intima in human arteriosclerosis.

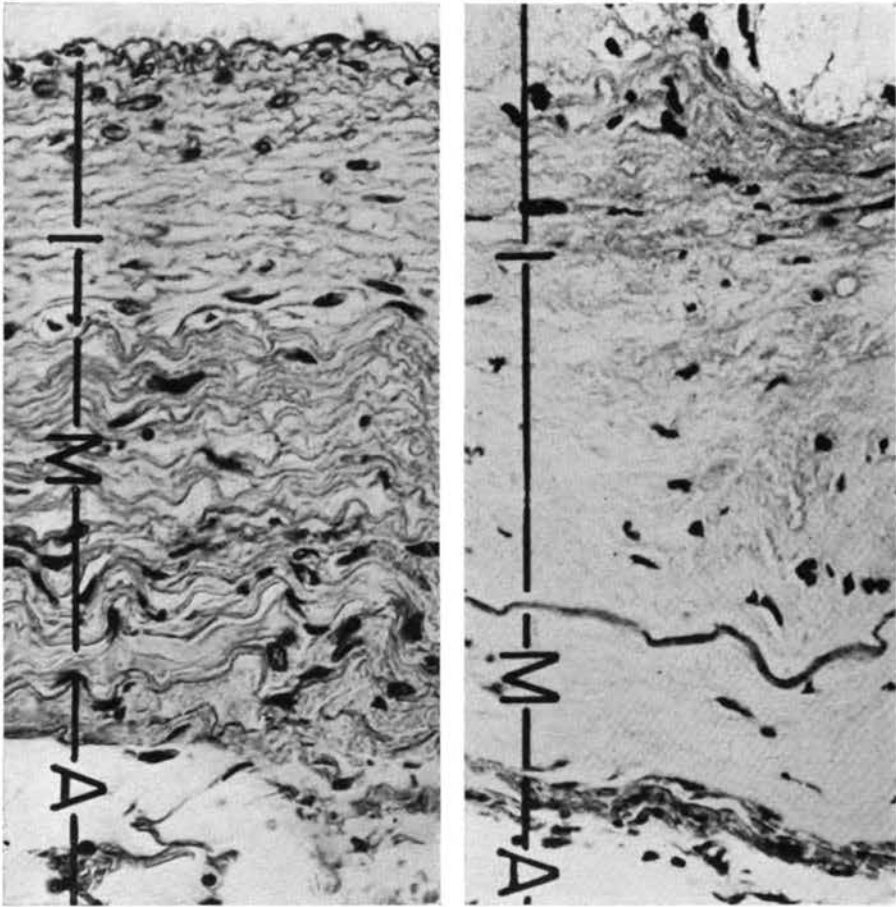

FIG. 4.—Left: Cross section of a lesion, 20 weeks old, produced by freezing the wall of the abdominal aorta of a juvenile rabbit ingesting a normal diet. Damage to the media (M) in this lesion was less severe. Proliferation of intima (I) was moderate with a less conspicuous maturation of smooth muscle cells and elastic tissue. The newly formed internal elastic membrane beneath the endothelium is moderately prominent. Elastic lamellas of the damaged media have persisted. Smooth muscle cells in the media have degenerated, though a few immature smooth muscle cells may be seen between the persistent elastic lamellas. There are no deposits of calcium. No atheromas are visible in the intima or media. The adventitia (A) is normal.

FIG. 4.—Right: Lesion, 52 weeks old, produced by freezing the wall of the renal artery in a rabbit with an average blood cholesterol level of 560 mg. per 100 cc. In this animal, 76% of the intima of the thoracic aorta was involved by spontaneous atheromas, and there were no microscopic spontaneous atheromas of the renal artery. A part of the proliferated intima (I), the full thickness of the degenerate media (M), and the adventitia (A) are shown. There is localization of lipids and lipophages in the proliferated intima. Beneath the lipid deposits there are a few residual degenerating fibrocytes surrounded by fused bundles of "hyalinized" collagenous fibrils. These changes in collagen are similar to those found in proliferated intima in human arteriosclerosis and seemed to follow the slow resorption of lipids deposited in the intimal tissues. Similar changes were found in lesions produced by freezing the aorta and iliac arteries of hypercholesterolemic rabbits. In the lesion shown above "hyaline degeneration" is also present in the degenerate media of this muscular artery.

*Other Factors that may Influence Arterial Repair*—As noted previously, with increasing age the quantity of new vascular tissue formed in normal rabbits following injury is reduced but there is no change in its quality.<sup>9</sup> Probably there are factors other than age and hypercholesterolemia that alter vascular repair. I would like to mention a few that should be considered. It is known that formation of collagen and other intercellular substances, as well as capillary proliferation, can be inhibited by vitamin C deficiency.<sup>56</sup> The effect of scorbutus on elastic tissue formation has not been reported, but alterations in staining reactions have been observed in vitamin C deficiency.<sup>57</sup> Certain natural and synthetic adrenal cortical hormones can inhibit formation of repair tissue in wounds.<sup>58</sup> Growth promoting substances have been shown to stimulate in-vitro proliferation of fibroblasts.<sup>59</sup> The effects of vitamin C, adrenal cortical hormones, and growth promoting substances on vascular repair would be of considerable interest. The effects of pyridoxine and choline deficiencies and vitamin D excesses on vascular structure are interesting and somewhat related to the problem of vascular repair. Pyridoxine deficiency in monkeys<sup>60</sup> and choline deficiency in young rats<sup>61</sup> cause profound changes in arterial structure. Excesses of vitamin D cause medial degeneration and calcification in aortas of rabbits.<sup>62</sup> In addition to experimental studies on vascular repair, the quality of vascular scar tissue in the intima and media of human arteries might well be correlated with the age and sex of the individual, the degree of hypercholesterolemia, and other factors known to affect formation of reparative tissue.

#### *A Working Hypothesis for Human Atherosclerosis*

In this section I wish to suggest a working hypothesis for the pathogenesis of human atherosclerosis in which impairment of vascular repair, by hypercholesterolemia and other factors, may play a significant role. This hypothesis, which embodies certain elements suggested previously,<sup>63-66</sup> is not presented as a full solution of the problem but is offered with the hope that it will stimulate thoughtful research on the role that vascular repair may play in this disease.

In man, atherosclerosis appears to develop slowly in the presence of mild hypercholesterolemia. When one considers the marked degrees of hypercholesterolemia which are generally required to induce atherosclerosis in experimental animals, it is difficult to understand why severe forms of this disease are so frequently observed in humans with levels of serum cholesterol often as low as about 200 to 250 mg. per 100 cc. Differences in the periods of existence of hypercholesterolemia, years in man as opposed to weeks or months in experimental animals,<sup>65</sup> and greater "filtration" distances for lipoproteins passing through thickened arterial walls<sup>66</sup> have been suggested as probable explanations.

*Interstitial Fluids in Normal Arterial Walls*—The rates at which interstitial fluids, containing lipoproteins, pass through arterial walls may be related to the genesis of atherosclerosis. A normal, resilient artery, with its active "milking" action of systolic stretch and diastolic recoil, probably moves interstitial fluids through its walls at a relatively rapid rate; interstitial fluids originating from plasma with moderately increased levels of cholesterol (about 300 to 400 mg. per 100 cc.) may show no tendency toward lipoprotein disintegration and lipid deposition in normal arterial walls. With more marked hypercholesterolemia (about 600 to 800 mg. per 100 cc.) lipid deposition may occur in normal, resilient arterial walls.

There is an urgent need for studies on arterial lymphatics. Lymphatics are probably

present in the adventitia; there is no information concerning lymphatics in the arterial media. What part lymphatic channels play in the movement of interstitial fluids of arterial walls must await future studies.

*Interstitial Fluids During Acute Arterial Injury*—Following arterial injury or degeneration, the local interstitial fluid movements are probably temporarily slowed because of loss of elastic stretch and recoil. Intramural lipoproteins may become concentrated due to dehydration of stagnated interstitial fluids by osmotic absorption of water and electrolytes into vasa vasorum. The concentrated lipoproteins may disintegrate and lipids may be deposited in acutely injured arterial walls when plasma cholesterol levels are only moderately elevated (about 300 to 400 mg. per 100 cc.). The studies of Duff<sup>6</sup> and Waters<sup>65</sup> lend support to this concept. Lipid deposition has not been observed at sites of arterial injury in rabbits<sup>8, 9</sup> and monkeys<sup>67</sup> with levels of serum cholesterol below 150 mg. per 100 cc.

*Impaired Arterial Repair and Interstitial Fluids*—In mild hypercholesterolemia (about 200 to 300 mg. per 100 cc.) the genesis of atherosclerosis may be a two-stage process requiring a long period of time. Following arterial injury or degeneration, local intramural lipoproteins may become moderately concentrated (cholesterol concentration about 400 to 500 mg. per 100 gm.) due to loss of the "milking" action of elastic stretch and recoil. During the period of repair of the injured site the intramural lipoproteins may be sufficiently concentrated to impair the quality of arterial repair tissue. The increased concentration of intramural lipoproteins, with some disintegration, probably alters the maturation of the totipotent proliferating intimal cells. Many of these cells seem to become macrophages or lipophages instead of smooth muscle cells and fibroblasts.<sup>14, 67</sup> Since fibroblasts form collagen and elastic tissue, these intercellular elements are apparently indirectly affected. The artery may become rigid at its site of injury and, without the "milking" action of stretch and recoil, the focal movement of interstitial fluids may be permanently impaired. At this site, lipids may be deposited slowly, over a period of months, even in the presence of mild hypercholesterolemia (about 200 to 300 mg. per 100 cc.). Recently we have observed impaired repair and localization of lipids at sites of arterial injury in monkeys with mild hypercholesterolemia (range, 175 to 350 mg. per 100 cc., average 250 mg. per 100 cc.).<sup>67</sup> This observation lends support to the above concept.

Other factors, such as vitamin C deficiency, may result in the formation of inelastic arterial scar tissue, giving rise to areas of arterial rigidity. In mild hypercholesterolemia atherosclerosis may develop slowly at these sites.

#### SUMMARY

The reactions of arterial walls to physical injury and the general pattern of arterial repair have been discussed. Pertinent data discussed in earlier reviews and studies reported since 1944 have been cited. In addition to arterial injury caused by electricity, ionizing radiation, heat, cold, and direct mechanical trauma, I have considered indirect injury from such forces as rapid deceleration and increased gravitational forces.

I have discussed man's aortic and arterial elasticity; continuous injury with repair by formation of inelastic scar tissue seems to result in its progressive loss with increasing age. In experimental animals, hypercholesterolemia impairs vascular repair; intimal scars often consist of inelastic scar tissue containing only a few fibroblasts. They are

primarily composed of fused collagenous fibrils showing "mucinous" or "hyaline" degeneration, and resemble intimal scars frequently found in human arteriosclerosis. I have suggested that hypercholesterolemia and certain other factors may influence human vascular repair.

Temporary loss of the "milking" action of systolic stretch and diastolic recoil following acute arterial injury and its permanent inhibition following injury with impaired repair have been suggested as contributing factors in the genesis of atherosclerosis. Even when there is only mild to moderate hypercholesterolemia, movements of interstitial fluids in inelastic arterial walls may be impeded sufficiently to result in concentration and disintegration of lipoproteins with lipid deposition. Factors influencing arterial repair are almost certainly related to the genesis of atherosclerosis and deserve intensive study.

## REFERENCES

1. Thoma, R.: Ueber die Abhängigkeit der Bindegewebsneubildung in der Arterienintima von den mechanischen Bedingungen des Blutumlaufes. Erste Mitteilung. Die Rückwirkung des Verschlusses der Nabelarterien und des arteriösen Ganges auf die Structur der Aortenwand, *Virchows Arch f. path. Anat.* 93: 443-505, 1883.
2. Lange, F.: Studien zur Pathologie der Arterien, insbesondere zur Lehre von der Arteriosklerose, *Virchows Arch. f. path. Anat.* 248: 463-604, 1924 (p. 522).
3. Schlichter, J. G.: Experimental Medionecrosis of the Aorta, *Arch. Path.* 42: 182-192 (August) 1946.
4. Ssolowjew, A.: Experimentelle Untersuchungen über die Heilungsvorgänge in der Arterienwand, *Bietr. z. path. Anat. u. z. allg. Path.* 83: 485-500, 1930.
5. Anitschkow, N., in Cowdry, E. V.: *Arteriosclerosis: A Survey of the Problem*, New York, Macmillan Co., 1933. (pp. 272-276).
6. Duff, G. L.: Experimental Cholesterol Arteriosclerosis and Its Relationship to Human Arteriosclerosis, *Arch. Path.* 20: 81-123 and 259-304 (July and August) 1935. (pp. 116-123, 265-268 and 273-296).
7. Hueper, W. C.: Arteriosclerosis, *Arch. Path.* 38: 163-181, 245-285 and 351-364 (Sept., Oct., and Nov.) 1944. (pp. 169-171 and 273-276).
8. Taylor, C. B., Baldwin, D., and Hass, G. M.: Localized Arteriosclerotic Lesions Induced in the Aorta of the Juvenile Rabbit by Freezing, *Arch. Path.* 49: 623-640 (June) 1950.
9. Baldwin, D., Taylor, C. B., and Hass, G. M.: A Comparison of Arteriosclerotic Lesions Produced in Young and in Old Rabbits by Freezing the Aorta, *Arch. Path.* 50: 122-131 (July) 1950.
10. Gordin, A. E.: Electric Shock, Electric Burns, *Indust. Med.* 10: 87-91, (March) 1941.
11. Sawyer, P. N., and Pate, J. W.: Intravascular Thrombosis of Electric Origin, *U. S. Armed Forces M. J.* 4: 23-30 (Jan.) 1953.
12. Warren, S.: Effects of Radiation on Normal Tissues. VI. Effects of Radiation on Cardiovascular System, *Arch. Path.* 34: 1070-1079 (Dec.) 1942.
13. Smith, C., and Loewenthal, L. A.: Study of Elastic Arteries in Irradiated Mice of Different Ages, *Proc. Soc. Exper. Biol. & Med.* 75: 859-861 (Dec.) 1950.
14. Kelly, F. B., Jr., Taylor, C. B., and Hass, G. M.: Experimental Atheroarteriosclerosis. Localization of Lipids in Experimental Lesions of Rabbits with Hypercholesterolemia, *Arch. Path.* 53: 419-436 (May) 1952.
15. Orr, K. D., and Fainer, D. C.: Cold Injuries in Korea During Winter of 1950-51, *Medicine* 31: 177-220 (May) 1952.
16. Shumacker, H. B., Jr., and Lempke, R. E.: Recent Advances in Frostbite. With Particular Reference to Experimental Studies Concerning Functional Pathology and Treatment, *Surgery* 30: 873-904 (Nov.) 1951.
17. Lewis, R. B.: Pathogenesis of Muscle Necrosis Due to Experimental Cold Injury, *Am. J. M. Sc.* 222: 300-307 (Sept.) 1951.
18. Friedman, N. B., Lange, K., and Weiner, D.: The Pathology of Experimental Frostbite, *Am. J. M. Sc.* 213: 61-67 (Jan.) 1947.

19. Ssolowjew, A.: Über experimentell hervorgerufene Elasticarisse der Arterien und deren Bedeutung für Lipoidablagerung, *Virchows Arch. f. path. Anat.* 283: 213-230, 1932.
20. Schloss, G., and Shumacker, H. B., Jr.: Studies in Vascular Repair. IV. The Use of Free Vascular Transplants for Bridging Arterial Defects. An Historical Review with Particular Reference to Histological Observations, *Yale J. Biol. & Med.* 22: 273-290 (Jan.) 1950.
21. Coleman, C. C., Jr., Deterling, R. A., Jr., and Parshley, M. S.: Experimental Studies of Preserved Aortic Homografts, *Ann. Surg.* 134: 868-877, 1951.
22. Graham, A. J. P.: Arterial Homografts: An Experimental Study, *Guy's Hosp. Rep.* 101: 186-206, 1952.
23. Miller, H. H., Callow, A. D., Welch, C. S., and MacMahan, H. E.: The Fate of Arterial Grafts in Small Arteries, *Surg. Gynec. & Obst.* 92: 581-588 (May) 1951.
24. Swan, H., Robertson, H. T., and Johnson, M. E.: Arterial Homografts. I. The Fate of Preserved Aortic Grafts in the Dog, *Surg. Gynec. & Obst.* 90: 568-579 (May) 1950.
25. Brooks, J.: Aortic Resection and Anastomosis in Pups Studied After Reaching Adulthood, *Ann. Surg.* 132: 1035-1051 (Dec.) 1950.
26. Brown, J. J. M.: Discussion on Vascular Injuries in War, *Proc. Roy. Soc. Med.* 39: 483-488 (June) 1946.
27. Dickinson, E. H., Hood, R. M., and Spencer, F. C.: Traumatic Aneurysm of Innominate Artery, *U. S. Armed Forces M. J.* 3: 1871-1879 (Dec.) 1952.
28. Hass, G. M.: Types of Internal Injuries of Personnel Involved in Aircraft Accidents, *J. Aviation Med.* 15: 77-92 (April) 1944.
29. Hass, G. M.: Relations Between Forces, Major Injuries and Aircraft Structure with Suggestions for Safety in Design of Aircraft, *J. Aviation Med.* 15: 395-400 (Dec.) 1944.
30. Tannenbaum, I., and Ferguson, J. A.: Rapid Deceleration and Rupture of Aorta, *Arch. Path.* 45: 503-505 (April) 1948.
31. Hollingsworth, R. K., Johnston, W. W., and McCooly, J. F.: Traumatic Saccular Aneurysms of Thoracic Aorta, *J. Thoracic Surg.* 24: 325-345 (Oct.) 1952.
32. Beckman, E. L., Ziegler, J. E., Duane, T. D., and Hunter, H. N.: Some Observations on Human Tolerance to Accelerative Stress. Phase II. Preliminary Studies on Primates Subjected to Maximum Simple Accelerative Loads, *J. Aviation Med.* 24: 377-392 (Oct.) 1953.
33. Sweeney, H. M.: Human Decelerator, *J. Aviation Med.* 22: 39-41 and 49 (Feb.) 1951.
34. Stapp, J. P.: Human Tolerance to Deceleration, *J. Aviation Med.* 22: 42-45 and 85 (Feb.) 1951.
35. Rushmer, R. F., Beckman, E. L., and Lee, D.: Protection of the Cerebral Circulation by the Cerebrospinal Fluid Under Influence of Radial Acceleration, *Am. J. Physiol.* 155: 355-365 (Dec.) 1947.
36. Beckman, E. L.: Protection Afforded the Cerebrovascular System by the Cerebrospinal Fluid under the Stress of Negative G, *J. Aviation Med.* 20: 430-438 (Dec.) 1949.
37. Rosenfeld, S., and Lombard C. F.: Cardiovascular Pressor Reflex Mechanism and Cerebral Circulation Under Negative G. Head-to-Tail Acceleration. *J. Aviation Med.* 21: 293-303 (Aug.) 1950.
38. Shaw, R. S.: Human Tolerance of Negative Acceleration of Short Duration, *J. Aviation Med.* 19: 39-44 (Feb.) 1948.
39. Moritz, A. R.: Medionecrosis Aortae Idiopathica Cystica, *Am. J. Path.* 8: 717-734 (Nov.) 1932. (pp. 730-731).
40. Oppenheim, F.: Gibt es eine Spontanruptur der gesunden Aorta und wie kommt sie zustande? *München med. Wchnschr.* 65: 1234-1237, 1918.
41. Klotz, O., and Simpson, W.: Spontaneous Rupture of the Aorta, *Am. J. M. Sc.* 184: 455-473 (Oct.) 1932.
42. Guillemain, V., Jr., and Wechsberg, P.: Physiological Effects of Long Term Repetitive Exposure to Mechanical Vibration, *J. Aviation Med.* 24: 208-221 (June) 1953.
43. Dart, E. E.: Effects of High Speed Vibratory Tools on Operators Engaged in Airplane Industry, *Occup. Med.* 1: 515-550 (June) 1946.
44. Junghanns, H.: Blütgefässschädigungen durch Dauererschütterungen infolge Arbeit mit Pressluftwerkzeugen als Berufskrankheit, *Arch. klin. Chir.* 188: 466-479 (June) 1937.
45. Barker, N. W., and Hines, E. A.: Arterial Occlusion in Hands and Fingers Associated with Repeated Occupational Trauma, *Proc. Staff Meet., Mayo Clin.* 19: 345-349 (June) 1944.

46. Mills, J. H.: Pneumatic Hammer Disease in an Unusual Location, *Northwest. Med.* 41: 282-283 (Aug.) 1942.
47. Zuckerman, S.: Discussion on the Problem of Blast Injuries, *Proc. Roy. Soc. Med.* 34: 171-192 (Jan.) 1941.
48. Vail, E. G.: Forces Produced in the Thorax by Explosive Decompression, *J. Aviation Med.* 23: 577-583 (Dec.) 1952.
49. Prior, J. T., and Jones, D. B.: Structural Alterations Within the Aortic Intima in Infancy and Childhood, *Am. J. Path.* 28: 937-952 (Sept., Oct.) 1952.
50. Gray, S. H., Handler, F. P., Blache, J. O., Suckner, J., and Blumenthal, H. T.: Aging Processes of Aorta and Pulmonary Artery in Negro and White Races. Comparative Study of Various Segments, *Arch. Path.* 56: 238-253 (Sept.) 1953.
51. Moon, H. D., and Rinehart, J. F.: Histogenesis of Coronary Arteriosclerosis, *Circulation* 6: 481-488 (Oct.) 1952.
52. Fox, H., in Cowdry, E. V.: *Arteriosclerosis: A Survey of the Problem*, New York, Macmillan Co., 1933. (pp. 153-169).
53. Bramwell, C., in Cowdry, E. V.: *Arteriosclerosis: A Survey of the Problem*, New York, Macmillan Co., 1933. (pp. 77-120).
54. Hass, G. M.: Elastic Tissue. I. Description of a Method for the Isolation of Elastic Tissue, *Arch. Path.* 34: 807-819 (Nov.) 1942. II. A Study of the Elasticity and Tensile Strength of Elastic Tissue Isolated from the Human Aorta, *Arch. Path.* 34: 971-981 (Dec.) 1942.
55. Waters, L. L.: Localization of Lipids in Injured Coronary Arteries of Dogs Following Injections of Egg-Yolk Fractions or of Hyperlipemic Human Plasma, *Circulation* 8: 437 (Sept.) 1953.
56. Wolbach, S. B., and Howe, P. R.: Intercellular Substances in Experimental Scorbutus, *Arch. Path. & Lab. Med.* 1: 1-24 (Jan.) 1926.
57. Hass, G. M.: Elastic Tissue, *Arch. Path.* 27: 334-365 and 583-613 (Feb. and March) 1939.
58. Sprague, R. G.: Cortisone and ACTH. A Review of Certain Physiologic Effects and Their Clinical Implications, *Am. J. Med.* 10: 567-594 (May) 1951 (p. 575).
59. Maganini, H., Schweitzer, A. W., and Hass, G. M.: Further Steps in Fractionation of Embryonic Growth-promoting Factors for Fibroblasts, *Fed. Proc.* 12: 395 (March) 1953.
60. Rinehart, J. F., and Greenberg, L. D.: Pathogenesis of Experimental Arteriosclerosis in Pyridoxine Deficiency. With Notes on Similarities to Human Arteriosclerosis, *Arch. Path.* 51: 12-18 (Jan.) 1951.
61. Hartroft, W. S., and Buckley, G. F.: Dietary Choline and the Cardiovascular System of Rats, *Fed. Proc.* 13: 430-431 (March) 1954.
62. Kreitmair, H., and Moll, T.: Hypervitaminose durch grosse Dosen Vitamin D, *München. med. Wchnschr.* 75: 637-639 (April) 1928.
63. Rosenthal, S. R.: Studies In Atherosclerosis: Chemical, Experimental and Morphologic, *Arch. Path.* 18: 473-506 and 660-698 (Oct. and Nov.) 1934.
64. Dock, W.: Arteriosclerosis—Some Clinical Implications, *Am. J. Med.* 11: 730-735 (Dec.) 1951.
65. Gould, R. G.: Lipid Metabolism and Atherosclerosis, *Am. J. Med.* 11: 209-227 (Aug.) 1951.
66. Page, I. H.: Atherosclerosis: An Introduction, *Circulation* 10: 1-27 (July) 1954.
67. Taylor, C. B., Cox, G. E., Hall-Taylor, B. J., and Nelson, L. G.: Atherosclerosis in Areas of Vascular Injury in Monkeys with Mild Hypercholesterolemia, *Circulation* 10: 613 (Oct.) 1954.

## DISCUSSION

*Dr. Kellner* asked whether there was any evidence that the type of flow in a rigid vessel is more detrimental to the organism than that in a flexible, elastic blood vessel. He felt that the essential factor is patency of the vessel.

*Dr. Taylor* replied that if all arteries were rigid, their hemodynamics would probably be somewhat comparable to those observed in aortic insufficiency. In a completely rigid arterial system, the diastolic pressure would drop to zero after only a minute amount of blood had escaped into the capillaries and venous system. The flow at the

arteriolar and capillary levels would probably be intermittent, with wide sweeps in arteriolar pressures. He also thought that maintaining intermittent flow at arteriolar and capillary levels was inefficient and imposed an increased load of work on the left ventricle.

*Dr. Kellner* commented that the increase in systolic pressure in older persons did not appear to be associated with adverse effects upon the heart and blood vessels or upon nutrition of the upper extremities.

*Dr. Taylor* replied that he felt that left ventricular hypertrophy and a more rapid progression of arteriosclerosis follow the increase in systolic pressure in older persons. He also commented that, although inadequate arterial flow to upper extremities is extremely rare, the severe arteriosclerotic changes in vessels such as the radial artery are probably related to the elevated systolic pressure.

*Dr. Page* agreed that decrescent arteriosclerosis is more apt to be associated with a wide blood vessel through which more blood can pass.

In reply to a comment by *Dr. Taylor* that if the vessel had no elastic recoil the blood could not maintain its flow, he pointed out that a rise in systolic pressure would result, without a corresponding rise in diastolic pressure. He cautioned against comparing that situation with essential hypertension, in which there is widespread increase in peripheral resistance.

*Dr. Surgenor* called attention to the fact that the experimental injury had been produced by freezing, which alters the beta lipoproteins.

*Dr. Taylor* agreed that freezing promotes the deposition of lipids.

*Dr. Gould* commented that the same results could be produced by damaging the artery in other ways, as well.

*Dr. Karsner* commented upon the implication in *Dr. Taylor's* paper that among the physical forces that may be influential in producing minor injury and minor tears of the blood vessel lining are accelerative and decelerative forces. This might have bearing upon the question whether exposure of aviators to strong G forces is a factor in the development of atherosclerosis. He emphasized that one must distinguish between processes in different types of arteries.

He commented that *Graybiel*, in a study of 639 aviators at Pensacola, had found that except for a slight acceleration of pulse rate there was no significant alteration of the electrocardiogram. *Dr. Karsner* also pointed out that there was little evidence to support a presumptive relationship between essential hypertension and atherosclerosis.

*Dr. Katz* suggested that studies be conducted on rabbits, chickens, and dogs to determine whether G forces are instrumental in the development of atherosclerosis.

*Dr. Taylor* replied that problems of body size and structure are encountered in studies of G forces. He felt that the rabbit would be unsuitable for such studies because of its thin, relaxed abdominal wall and its relatively large abdominal viscera. Although the chimpanzee might otherwise be satisfactory as an experimental animal, knowledge of its susceptibility to atherosclerosis was inadequate. He felt that the monkey might be a suitable animal. Although smaller, the monkey is structurally similar to man and has a known susceptibility to atherosclerosis. This animal is also readily available and can be handled easily.



## THE REACTION OF THE ARTERY WALL TO INJURY BY CHEMICALS OR INFECTION\*

L. L. WATERS

When localized inflammation occurs, through the action of chemicals or of virulent microorganisms, arteries are frequently involved. The only evidence of this process may be the transient accumulation within the wall of fluid and cellular exudate. On the other hand there may be necrosis of the coats with or without thrombus formation, or with degrees of proliferative endarteritis. As far as the vessel is concerned, the result within a few days may vary from complete anatomical resolution to scarring with obliteration. These changes and their sequential development and variation have been observed in man and have been followed in detail in the experimental animal.<sup>1, 2</sup> Qualitatively the lesions are the same, but they vary quantitatively with variations in the intensity and duration of the eliciting stimulus.

If one now turns to arterial lesions that are less obviously the result of the direct contact of chemical substances or of bacteria with tissue, to such arterial lesions as occur in periarteritis nodosa, in rheumatic disease, and in other clinical or experimental conditions associated with hypersensitive states, one finds again only quantitative variations of the basic acute inflammatory reaction of arteries.<sup>1, 3</sup> To be sure these variations, taken together with their distribution, associated visceral changes, and clinical course may allow subdivision. That one may be dealing even here with differences in stage of lesion, in intensity of reaction, or even different portions of the same lesions is suggested by the study of experimentally produced arterial changes of this type.<sup>3, 4</sup> In a group of experimental animals arterial lesions may be studied serially in space and time. When this is done it is possible within the same animal or, indeed, within the same short segment of involved artery to demonstrate a panel of anatomical variations that include those present in several clinically distinct disease groups in man, and yet the basic relationships of acute arterial inflammation and repair are present in all.

This conception of the uniformity of vascular response to injury is fortified by the fact that injury by physical agents as well as by chemical or infectious ones results in the same basic response. Of particular interest is the fact that increased intravascular pressure, experimentally produced in animals, leads to acute arterial changes that are not only in many instances similar to those occurring in hypertension in man but also are often indistinguishable from those that follow chemicals, bacteria, or the hypersensitive state.<sup>5</sup> Arterial changes associated with physical agents and hypertension are described in more detail elsewhere in this symposium.

Thus, studies of the vessel wall both in man and in the experimental animal following injury either by chemical agents, by bacterial infection, by hypersensitivity states, or by physical means indicate the great uniformity of the acute inflammatory response and the associated processes of repair. Such variations as occur are in no way unique, are quantitative, and result from differences in the intensity and duration of the eliciting stimulus (figs. 1, 2, 3).

\* Original work cited in this paper was aided by grants from the U.S. Navy, the Life Insurance Medical Research Fund, and the Veterans Administration.

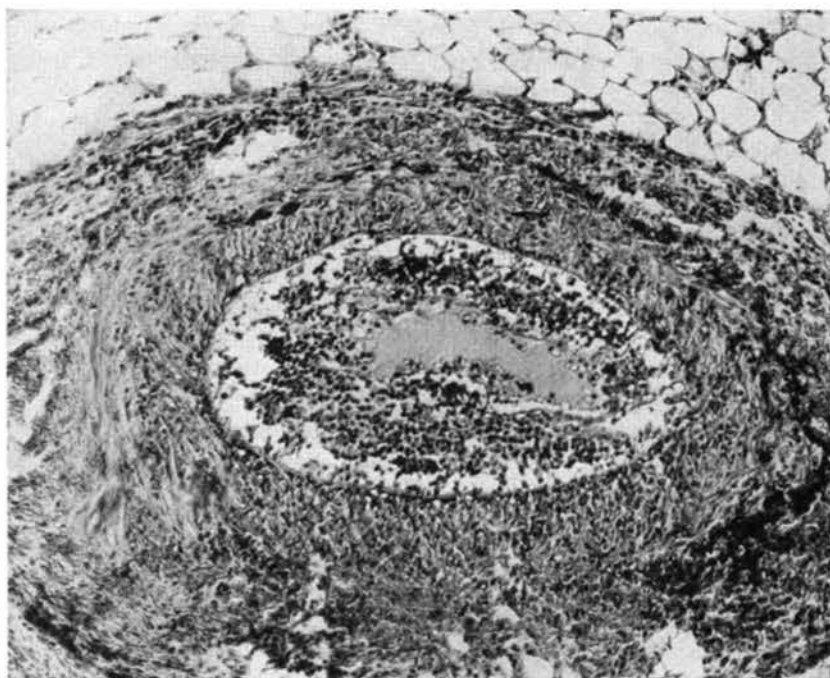

FIG. 1.—Dog. Coronary artery. Local *Staphylococcus aureus* infection. Panarteritis with extensive subendothelial exudation and proliferation.

Of what importance are these observations for the problem of arteriosclerosis? In Virchow's time—nearly a century ago—the very nature of the arteriosclerotic process was a problem. The question now, as then, is whether or not the process is initially arterial inflammation or a primary noninflammatory alteration of the arterial tissues leading to the accumulation of fat, intimal scar, atheroma, calcification, and other manifestations of the disease. Knowledge of the nature of arteriosclerosis as an inflammatory process or as another type of change is basic to considerations of etiology and prevention, and indeed even to further considerations of mechanism. If the process is inflammatory, then a large body of knowledge related to the etiology, pathogenesis, and repair of inflammation in general and as specifically related to blood vessels may be applied to the study of the disease. If, on the other hand, arteriosclerosis is a unique, specialized tissue response, this knowledge does not apply and the process remains to be characterized.

At first glance, nothing could be more dissimilar even morphologically than acute inflammatory arteritis and the average arteriosclerotic lesion. The former is characterized by medial edema and necrosis, an intense inflammatory cellular exudate, intimal and periadventitial proliferation, and lack of lipid accumulation. Its course lasts a few weeks, attaining an end-stage of medial and intimal scar. Contrast the arteriosclerotic process: In an early stage cellular exudate, a classic sign of inflammation, if present at all, is sparse. Prominent is a morphologic alteration of the ground substance of the intimal connective tissue. This, it is now believed,<sup>6</sup> consists at least in part of an accumulation of acid mucopolysaccharides in these areas, associated with visible fraying and fragmentation of elastic fibers. The etiology of these changes and their relationship

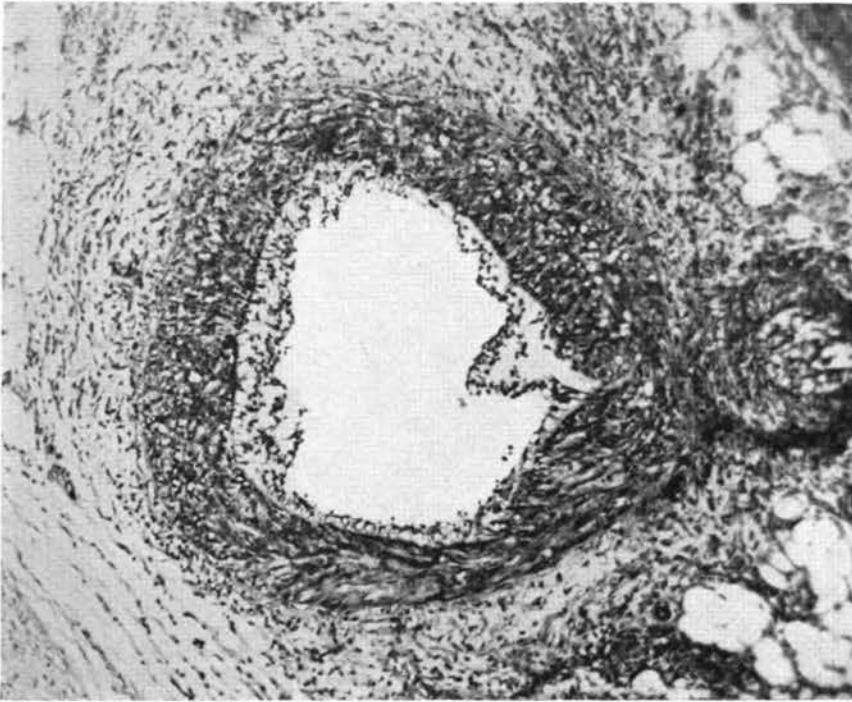

FIG. 2.—Rabbit. Coronary artery. Sensitization with foreign serum. Panarteritis with subendothelial exudation and proliferation. (Compare fig. 1)

to inflammation and to the genesis of the arteriosclerotic process, although questions of the utmost importance, are only now coming under intensive study.<sup>7, 8</sup> As the arteriosclerotic lesion develops, there is a relatively enormous accumulation of extra- and intracellular fat in the intima. There is a large increase of intimal connective tissue; the lesion is persistent and progressive over a period of years, leading to ultimate gross atheroma formation, calcium deposit, hemorrhage, and thrombus formation.

Until recently, observations on the pathogenesis of arteriosclerosis were made on material from the postmortem table or from cholesterol-feeding experiments in animals, chiefly rabbits. Morphologically the material from blood vessels in man contributed few facts to support a concept of origin in inflammation, and certainly the ability to produce the experimental disease by simple feeding of cholesterol seemed to indicate that local factors of the wall were at least not critical. From the postmortem room and animal experiments did come the basic observation, however, that the lesions of the disease are focal, suggesting that altered conditions exist in the portions of the wall involved. Second, it was noted that chronic inflammations such as syphilis or rheumatic arteritis alter the pattern of arteriosclerotic involvement of the aorta, so that advanced lesions occur in relation to the underlying inflammatory process.<sup>9, 10</sup> Thirdly, the autopsy material demonstrated that the lesions not only were focal but contained fatty substances. But in youth fat tended to disappear from the lesions, and also in once obese persons dying after an emaciating illness.<sup>11</sup> While these observations might point to an inflammatory origin for arteriosclerosis, the morphological dissimilarities already men-

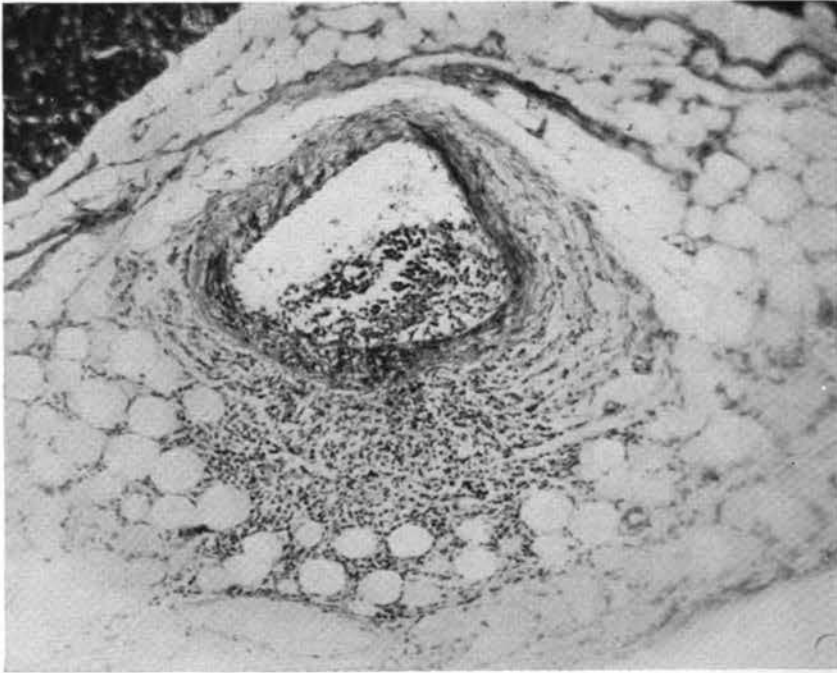

FIG. 3.—Dog. Coronary artery. Five days after intravenous injection of allylamine. Panarteritis with intimal changes similar to those present in figures 1 and 2. (Courtesy American Heart Journal.<sup>4</sup>)

tioned, the presence of large quantities of particular lipids in the lesion, its generally progressive nature, and the difficulty of assessing or controlling mural factors in the experimental production of the disease have made clarification exceedingly difficult. The presence of cholesterol-rich lipids in the lesions has been a many-sided riddle. This feature has long suggested the need of an experimental method which would allow study of the interrelationships of local and systemic factors in the establishment of the arteriosclerotic lesion.

It is in this area, where local and systemic factors are to some extent considered, that the experimental study of reactions of the vessel wall to injury by chemicals is proving of value. By injecting pure substances into animals of species (dogs) not ordinarily susceptible to spontaneous arteriosclerosis, selective injury of the coronary arteries and aorta can be obtained.<sup>4, 5</sup> This injury, as would be expected from the earlier discussion, results in the basic acute inflammatory reaction which is elicited in arteries by many categories of noxious stimuli. In a small series of animals, all variations of intensity of this process occur, from inflammation in its broadest sense—local increase of permeability—to necrosis with abundant cellular exudate and proliferative phenomena of repair. These arterial changes can be obtained in hours or days and may, by sacrificing the animals at intervals, be studied in detail throughout their life history. Of greater importance, they may be exposed at any stage to changes in their environment, particularly in the ambient blood, by altering the animal's metabolism or by other means. Thus, specifically, they may be exposed to large variations in the lipid content of the blood effected by dietary variation, or by the direct intravenous injection of lipid materials.

Such studies have been begun, and have demonstrated that the basic acute nonspecific inflammatory reaction of arteries can be rapidly and profoundly altered. Beginning with injected inert, particulate substances such as India ink<sup>12</sup> or methyl celluloses<sup>13</sup> in molecular solution, it has been demonstrated that these particles localize selectively in areas of acute arterial injury. This would appear to be a special application of Menkin's observations on localization of dyes in areas of inflammation.<sup>14</sup> Phagocytes, fixed and free, present as part of the inflammatory or repair process, become transformed into intimal "foam" cells reminiscent of the early arteriosclerotic process. Further, it can be shown that the injection of various types of lipid particles results in fatty, foam-cellular modifications of the basic inflammatory intimal response, and that these lesions rapidly lose all stigmata of their inflammatory origin and reproduce many of the early changes of arteriosclerosis in man (fig. 4). For example, repeated injections of normal lipemic human plasma<sup>15</sup> or of human plasma lipoproteins<sup>16</sup> into dogs with injured coronary arteries results in the rapid deposit of lipid-rich substances in the vessel wall selectively at sites of injury (fig. 5). Foam-cellular transformation of the inflammatory response ensues, with sequelae that find morphological counterpart in arteriosclerosis. The techniques employed for the production of the standard vascular lesions are simple, the changes result promptly, and a basically normal organism is available to test the effect of quantitative systemic or metabolic disturbances.

Attackable through these experimental means would seem to be such questions, long

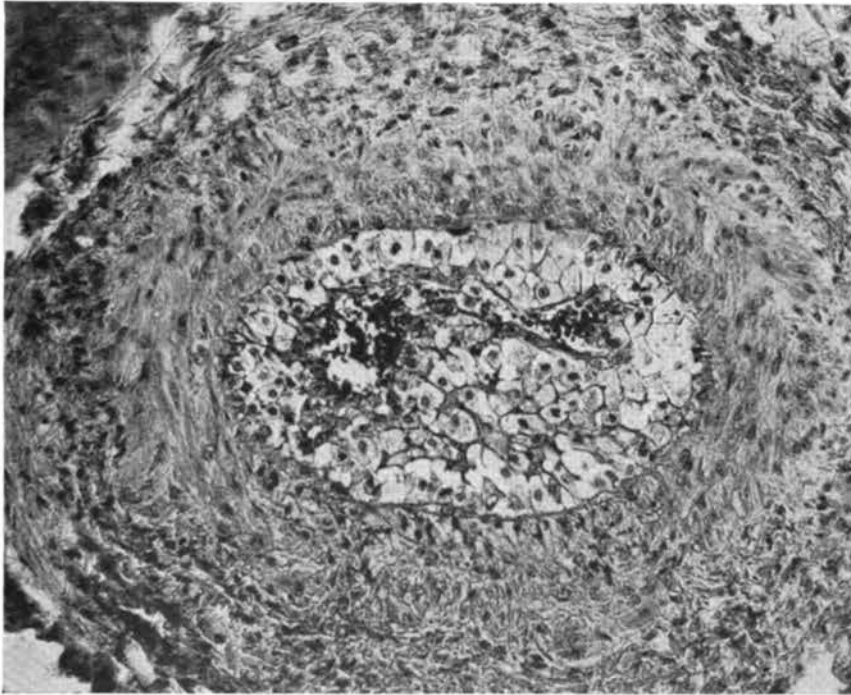

FIG. 4.—Dog. Coronary artery. Eleven days after combination of allylamine injury and intravenous injection of egg yolk. Transformation of basic changes (compare fig. 3) to intimal, fatty, foam-cellular lesion. Little evidence of prior inflammatory process.

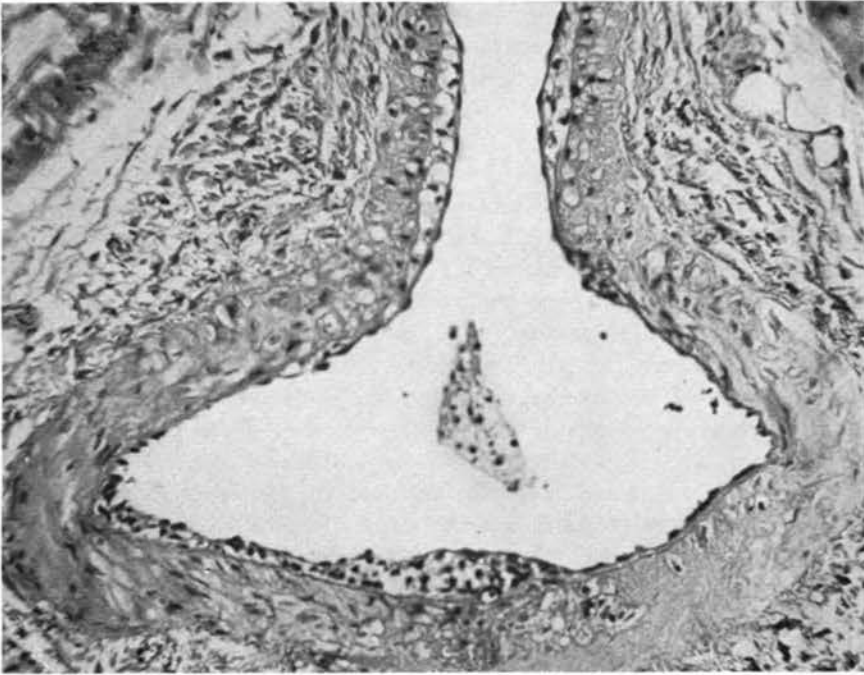

FIG. 5.—Dog. Coronary artery. Ten days after combination of allylamine injury and intravenous injection of human plasma lipoprotein. Foam-cellular subendothelial fatty accumulations in main vessel and at origin of branch.

in doubt, as to what types of stimuli injure the vessel, the localization, transport, and fate of lipid-rich materials in the vessel wall, and qualitative and quantitative studies of the substances involved in the mural deposition of lipids. Lastly, through the same means it may be possible to begin a survey of factors that might prevent or modify the development of the lesions themselves.

In conclusion, study of the reaction of the vessel wall to injury by chemicals or infection strongly suggests the uniformity of vascular response to many types of noxious stimuli and suggests further that variation is quantitative and is dependent more upon the intensity and duration of the stimulus than upon its nature. Realization of this uniformity of response allows use of the acute inflammatory reaction as an experimental tool for the study of chronic vascular disease. The basic inflammatory change can be modified, by varying systemic factors, to a reasonable facsimile of the arteriosclerotic process. The fact that such modification is possible opens a large field for investigation of the pathogenesis, etiology, and prevention of the disease.

#### REFERENCES

1. Karsner, H. T.: Primary Inflammation of Arteries, *Ann. Int. Med.* 11: 164, 1937.
2. Ramsey, E. M., *et al.*: The Response of the Rabbit's Carotid Artery to Injury, *Yale J. Biol. & Med.* 9: 37, 1936.
3. Rich, A. R.: The Experimental Demonstration that Periarteritis Nodosa is a Manifestation of Hypersensitivity, *Bull. Johns Hopkins Hosp.* 72: 65, 1943.
4. Waters, L. L.: Changes in the Coronary Arteries of the Dog Following Injections of Allylamine, *Am. Heart J.* 35: 212, 1948.

5. Waters, L. L. and DeSuto-Nagy, G. I.: Circulatory Factors in the Pathogenesis of Arteriolar Necrosis, *Yale J. Biol. & Med.* 22: 751, 1950.
6. Taylor, H. E.: The Role of Mucopolysaccharides in the Pathogenesis of Intimal Fibrosis and Atherosclerosis of the Human Aorta, *Am. J. Path.* 24: 871, 1953.
7. Altschuler, C. H. and Angevine, D. M.: Acid Mucopolysaccharide in Degenerative Disease of Connective Tissue, with Special Reference to Serous Inflammation, *Am. J. Path.* 27: 141, 1951.
8. Gersh, I. and Catchpole, H. R.: The Organization of Ground Substance and Basement Membrane and its Significance in Tissue Injury, Diseases and Growth, *Am. J. Anat.* 85: 457, 1949.
9. Anitschkow, N.: Das Wesen und die Entstehung der Atherosklerose, *Ergebn. d. inn. Med. u. Kinderh.* 28: 1, 1925.
10. Pappenheimer, A. M., and VonGlahn, W. C.: Lesions of the Aorta Associated with Acute Rheumatic Fever and with Chronic Cardiac Disease of Rheumatic Origin, *J. Med. Res.* 44: 489, 1924.
11. Wilens, S. L.: Bearing of General Nutritional State on Atherosclerosis, *Arch. Int. Med.* 79: 129, 1947.
12. McAllister, W. B., and Waters, L. L.: Unpublished experiments, 1950.
13. Waters, L. L., and Duff, R. S.: The Role of Arterial Injury in the Localization of Methyl Cellulose *Am. J. Path. (Abstract)* 28: 527, 1952.
14. Menkin, V.: *Dynamics of Inflammation*, New York, The Macmillan Co., 1940, p. 244.
15. Waters, L. L.: Localization of Lipids in Injured Coronary Arteries of Dogs Following Injection of Egg-Yolk Fractions or of Hyperlipemic Human Plasma, *Circulation (Abstract)* 8: 437, 1953.
16. Waters, L. L.: Plasma Lipids and the Arterial Wall, *Circulation (abstract)* 10: 614, 1954.

## DISCUSSION

*Dr. Duff* asked whether in *Dr. Waters'* experiments the egg-yolk emulsion or human plasma was deposited in normal portions of the dog's arteries that were unaffected by allylamine.

*Dr. Waters* replied that when given in large quantities in the normal dog, egg yolk is deposited in the aorta and large elastic arteries, but not in the muscular arteries. He emphasized that there may, in this instance, be injury produced by circulatory overload; hence, the vessels cannot necessarily be considered normal.

*Dr. Karsner* recalled a review by W. G. McCallum which had discounted the importance of infectious disease in the development of arteriosclerosis. He felt that *Dr. Waters'* presentation indicated that inflammatory lesions are of importance in the disease. *Dr. Karsner* had studied sections from 500 human aortas at different periods of life and under different circumstances and had found lesions of the arteries in infectious diseases. The same findings had been reported by *Stoerk* in 1910 in studies of influenza. He felt that *Dr. Waters'* observations of inflammation following chemical injury supported the general view that infectious diseases have some bearing on the development of arteriosclerosis.

He pointed out that the principal victim of arteriosclerosis is man, and that man is subject to a wider variety and to more frequent attacks of infectious diseases than any other animal.

*Dr. Waters*, in reply to a question by *Dr. Taylor*, expressed the opinion that the lipids that accumulated in the lesions remained there only a short time. By serial observations he had found that the lesions are completely devoid of lipids within a few weeks after the regimen of lipid injections is stopped. Upon reinstitution of the regimen, the lipid re-enters the blood vessel wall, often selectively at the sites of prior injury, and a new fatty lesion results. This in turn loses its lipid and reverts to scar, leading, when the process is repeated, to progressive occlusion of the artery.

*Dr. Winternitz* asked *Dr. Waters* whether, when allylamine was administered intravenously, intrapericardially, or by any other route, only the coronary arteries became involved.

*Dr. Waters* replied that the arteries of the retroperitoneal fat, or of other depots of body fat, often are involved.

*Dr. Winternitz* suggested that the pathological response of vessels at different sites may vary.

*Dr. Gould* asked whether histochemical staining had been employed in the slides exhibiting lipids in the experimental lesions.

*Dr. Waters* stated that he had not as yet begun such a study. However, he had observed that human plasma lipoprotein fractions precipitated in vitro or localized in the vessel wall of the experimental animal stained strongly with Sudan dyes.

*Dr. Page* asked whether inflammatory tissue generally takes up large particulate matter as well as soluble material.

*Dr. Waters* replied that it does. He felt that *Menkin's* observations on dye localization applied to the process; that it is a question of particle size and of permeability. It is possible to obtain the same response with India ink, methyl cellulose, Thorotrast, hemoglobin, or almost any particulate substance.

*Dr. Katz* asked whether the inflamed portions took up chylomicrons rather than the smaller molecules.

*Dr. Waters* felt that further study would be needed in order to answer this most important question. There was some experimental evidence that when the permeability of the vessel wall is increased by an inflammatory reaction, chylomicrons can enter the wall and be taken up by foam cells, resulting in a xanthomatous lesion. There was also preliminary evidence that under certain local conditions the same thing may occur with smaller lipoprotein particles.



## METABOLIC FACTORS IN VASCULAR DISEASE

G. M. C. MASSON

The immediately preceding speakers have described various means of eliciting local injuries to vessel walls and have demonstrated that such injury predisposes to atheromatous deposition. Their interest and mine in this topic arises from the conviction that the problem of vascular injury and of the response of the vessel wall shares position with abnormal lipid metabolism as a major issue in clinical atherogenesis.

Information, largely derived in the first instance from clinical observation, has accumulated to show that endogenous metabolic factors can act in causing local vascular injury and predispose to atherosclerosis without having intense or even minor effects on the metabolism of cholesterol.

Some of these factors are nutritional as, for example, pyridoxine deficiency in monkeys. But most of them arise in abnormal endocrine function. Thus, thyroid deficiency is associated with abnormalities of connective tissue structure and these can be presumed to participate with hypercholesterolemia in increasing the susceptibility of the thyroid deficient animal or person to atherosclerosis. Iodide overdosage has been reported to result in degenerative medial changes. At the other pole, thyroid excess has been observed to elicit medial calcific degeneration. This change may be a result of the participation of two factors, one the increased vascular reactivity which may occur in hyperthyroidism and the other the sympathetico-adrenal stimulation associated with this condition. In any case, the sympathetic mediators, adrenalin and noradrenalin, can elicit similar medial lesions in animals. The frequency of metastatic arterial calcification in hyperparathyroidism is well recognized.

The participation of the pituitary gland in causing vascular disease is not as well clinically documented as are the effects of other endocrine dysfunctions, and is presumably in any case a mediated function. Thus, people with acromegaly are believed to have some increased tendency to arteriosclerosis. Experimentally, preparations containing growth hormone have been described as causing vascular damage. The association of the adrenal cortex is better established. Hypertension and nephrosclerosis are common and often severe, in Cushing's syndrome in particular. Experimentally, as will be described below, adrenal steroids can act in eliciting vascular damage.

Lastly, the renal humoral secretions, notably renin, can justly be termed endocrines, since they are formed at one site and act at another. These too presumably participate in causing hypertension and vascular damage in renal hypertension. Possibly the hypothetical protective factor—demonstrated by bilateral nephrectomy—comes under this head also.

What follows is concerned with the interrelationships of renal and adrenal factors. The adrenal factor chosen for study is desoxycorticosterone. For a long time we had the uncomfortable feeling that its profound effects on the cardiovascular system in rats might be a pharmacological accident, since the evidence that it was a true hormone of the adrenal cortex was very incomplete. However, as we show, substances of true hormonal capacity have comparable effects. The recent isolation of "electrocortin" indicates that the accumulation of data from the use of desoxycorticosterone is peculiarly

justified, since desoxycorticosterone seems to be in essence only an enfeebled simulacrum of the natural "salt hormone" of the adrenal cortex.

These relationships can be briefly summarized from our experiments.

1. Desoxycorticosterone (DC). Given to rats maintained on 1 per cent NaCl as a drinking fluid, this steroid elicits a progressive hypertensive state with which are ultimately associated lesions in the renal and other vascular beds. These lesions correspond to those of severe hypertensive arterial disease.

2. Cortisone. Given to rats, this steroid elicits a milder hypertension, less predictable than that of DC and earlier in onset. Lesions can be defined in vascular beds throughout the body, notably in the kidneys.

3. Hydrocortisone. Its effects correspond to those of cortisone; this accords with the suggestion that cortisone becomes effective at the tissue level after conversion to hydrocortisone.

The significant difference between the activities of DC on the one hand and of cortisone and hydrocortisone on the other is that salt feeding is not a necessary condition of the hypertension and vascular lesions elicited by the latter steroids. Uninephrectomy sensitizes rats to hypertension and vascular lesions only in the case of DC treatment.

4. Sodium chloride. The susceptibility of animals to hypertension and vascular damage from excess NaCl seems to be in part a function of the ease with which they can excrete this electrolyte. Thus, the chick responds to administration of 1 per cent NaCl rather promptly. The rat does not respond at this concentration, but does to the continued administration of hypertonic salt. The dog seems well equipped to resist this effect. Fundamentally, the hypertension and vascular damage elicited by NaCl seems to be in essence the same as that elicited by provoking NaCl retention with desoxycorticosterone; indeed, hypertension and vascular lesions can be elicited by appropriate intense salt feeding as rapidly as with DCA.

5. Renin or angiotonin. The subcutaneous administration of partially purified renin to rats results in irregular, modest or ephemeral increases in arterial pressure; diuresis and proteinuria are most constantly observed, and with the passage of time, weight loss and cachexia.

These effects can be reproduced by angiotonin; they are intensified by salt feeding. No vascular lesions can be seen in normal animals with either renin or angiotonin.

6. Renin (or angiotonin) + salt + DC. We have been particularly impressed by the syndrome and associated lesions produced in rats pretreated with DC and salt and then given subcutaneously a few doses of renin or large doses of angiotonin. Most of the animals develop an eclampsia-like state associated with severe renal failure. They show at autopsy visceral hemorrhages and microscopically diffuse vascular lesions remarkable both for their severity and for the rapidity of their onset.

Clinically, this association is of interest, since salt retention and renal damage are both recognized as contributing factors in the onset of eclampsia.

7. Cortisone or hydrocortisone + renin. Pretreatment with these adrenal steroids *together with salt* sensitizes the rat to the effect of subcutaneous renin in a manner similar to that of DC. Indeed, adequate salt pretreatment has a similar, though less profound and predictable, effect.

8. Nephrectomy. Animals maintained for long periods after bilateral nephrectomy by vividialysis frequently develop hypertension and vascular lesions. The onset of these

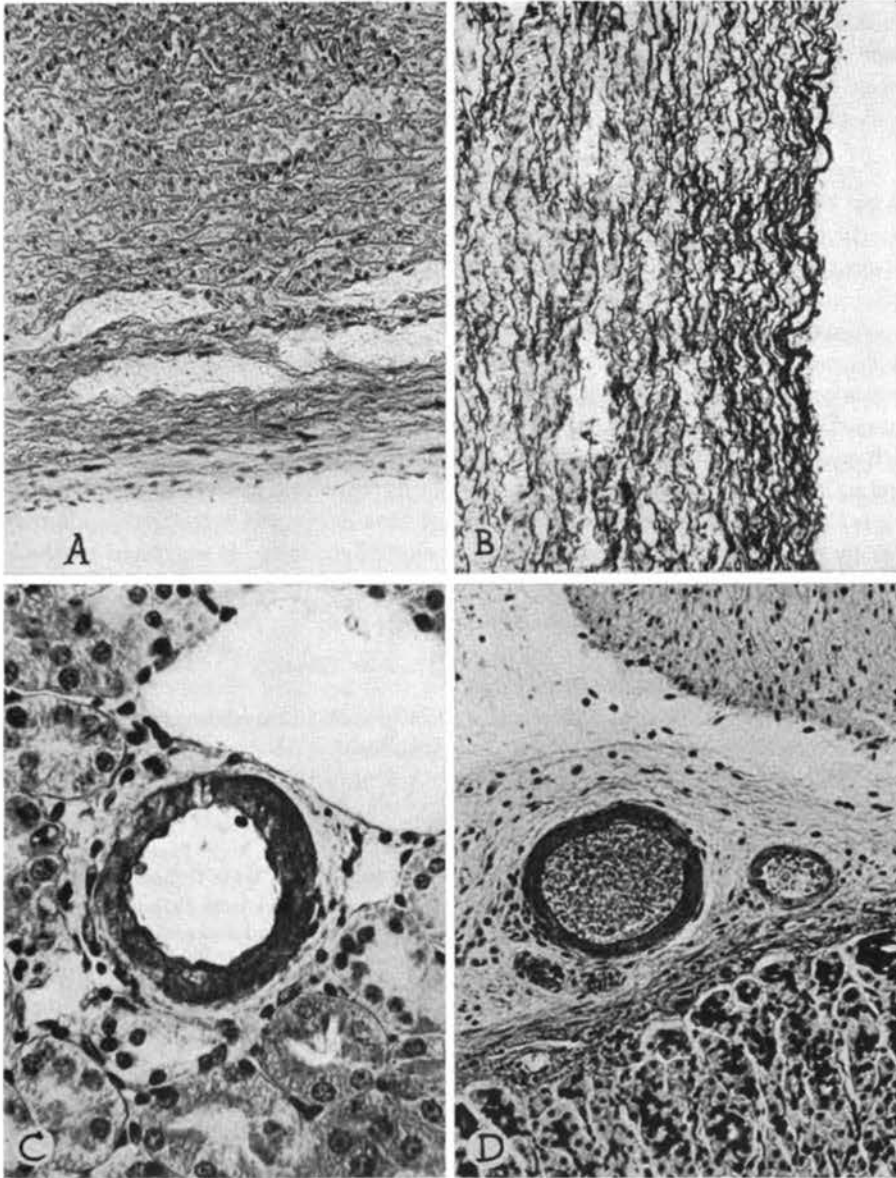

FIG. 1.—A and B: Nephrectomized dogs maintained on 1 per cent saline and injected with renin. Edema and necrosis of aorta associated with disruption and fraying of elastic fibers. A. Trichrome stain. B. Elastic stain. (Courtesy A. M. A. Archives of Pathology.<sup>4</sup>)

C and D: Rats pretreated with cortisone which received renin plus 1 per cent saline. Periodic acid-fuchsin stain. C. Hyalinization of a renal arteriole. D. Gastric arteriole showing hyalinization of wall and blood stasis. Edema of the surrounding connective tissue. (Courtesy A. M. A. Archives of Pathology.<sup>5</sup>)

manifestations of "renoprival" hypertensive disease is accelerated by overtreatment with salt, and appropriate combinations of vividialysis and overhydration intensify the lesions. The nephrectomized animal is also hyperresponsive to renin, so that nephrectomized dogs given both renin and excess salt manifest an abrupt and rapidly destructive vascular damage.

#### CONCLUSIONS

What can be inferred from this sequence of related events which have the common property of eliciting vascular damage and, in variable degree, arterial hypertension? The most important conclusion seems to be that substances present in the body and part of its normal mechanisms of homeostasis can, in appropriate combination, elicit hypertension and vascular damage. Salt somehow enters very significantly into this process, and its sensitizing effect is demonstrable in abnormals whose primary sensitization depends on nephrectomy rather than steroid excess.

In particular, these experiments demonstrate a variety of related metabolic functions which may well be concerned in the genesis of hypertensive vascular disease and, thereby, in the problem of atherosclerosis. The hypertension associated with these processes is doubtless a major factor, and that it acts on vessels sensitized to damage—either by salt excess, the renoprival state, or electrolyte shift—is suggested by the lack of a definite quantitative correlation of hypertension with vascular damage.

#### REFERENCES

1. Masson, G. M. C., Corcoran, A. C., and Page, I. H.: Some Effects of Chronic Treatment of Rats with Renin, *Am. J. Physiol.* 162: 379, 1950.
2. Masson, G. M. C., Corcoran, A. C., and Page, I. H.: Experimental Production of a Syndrome Resembling Toxemia of Pregnancy, *J. Lab. & Clin. Med.* 38: 213, 1951.
3. Masson, G. M. C., Corcoran, A. C., and Page, I. H.: Renal and Vascular Lesions Elicited by "Renin" in Rats with Desoxycorticosterone Hypertension, *A. M. A. Arch. Path.* 53: 217, 1952.
4. Masson, G. M. C., Plahl, G., Corcoran, A. C., and Page, I. H.: Accelerated Hypertensive Vascular Disease from Saline and Renin in Nephrectomized Dogs, *A. M. A. Arch. Path.* 55: 85, 1953.
5. Masson, G. M. C., del Greco, F., Corcoran, A. C., and Page, I. H.: Acute Diffuse Vascular Disease Elicited by "Renin" in Rats Pretreated with Cortisone, *A. M. A. Arch. Path.* 56: 23, 1953.
6. Masson, G. M. C., del Greco, F., Corcoran, A. C., and Page, I. H.: Effects of Renin in Rats Pretreated with Hydrocortisone and Somatotrophin, *Am. J. Med. Sc.* 226: 296, 1953.
7. Masson, G. M. C., Corcoran, A. C., Page, I. H., and del Greco, F.: Angiotonin Induction of Vascular Lesions in Desoxycorticosterone-treated Rats, *Proc. Soc. Exper. Biol. & Med.* 84: 284, 1954.

#### DISCUSSION

*Dr. Waters* asked whether *Dr. Masson* had found arterial lesions in the skin, subcutaneous tissue, and mucous membranes, or whether the lesions were mainly visceral or mesenteric.

*Dr. Masson* replied that he had not examined the skin of the animals in his experiments.

*Dr. Page*, in response to a question by *Dr. Katz* concerning the evidence as to predisposing factors, explained that it was not yet clear whether all or only part of the factors discussed may predispose to atherosclerosis. The studies by *Drs. Masson* and *Waters* were presented in order that the conferees might consider whether these types of disorder might lead ultimately to the deposition of lipid, and thereby be classed as predisposing.

## REGENERATION OF THE ELEMENTS OF THE VESSEL WALL

MICHAEL E. DEBAKEY, OSCAR CREECH, JR., AND BÉLA HALPERT

### *Arterial Wounds and Autogenous Grafts*

Microscopic study of the reparative process that occurs following suture of arterial wounds reveals almost complete structural regeneration.<sup>9, 10</sup> Shortly after closure a thrombus forms at the line of suture, and by the end of one week there is evidence of organization. As the thrombus becomes organized it contracts and becomes grossly imperceptible and covered by endothelium. Regeneration of the endothelium is complete by the end of one week. The internal elastic lamina does not reform. Regeneration of the media is delayed somewhat, being complete about the third or fourth month. Delicate elastic fibers and muscle cells grow into the scar between the everted edges of the vessel and into the granulation tissue beneath the endothelium. The adventitial and periadventitial tissues proliferate to produce a thickening over the sutured area. In brief, with the exception of the internal elastic lamina, all elements of the arterial wall regenerate in the healing process following surgical repair of a wound of an intact artery.

The fresh autogenous graft undergoes little change following transplantation. The same healing process that occurs in the lateral arterial wound takes place at the proximal and distal anastomoses of the graft. In addition to these changes, the intima of the graft becomes thickened. Staining with Weigert's elastic tissue stain indicates that this thickening is due largely to increase of elastic fibers. The cellular elements of the media survive intact, and, with exception of slight periadventitial reaction, this layer remains unchanged. Thus the arterial autograft appears to survive intact, and regeneration of practically all of its elements occurs at the sites of anastomosis (fig. 1).

### *The Reparative Process in Canine Arterial Homografts*

Microscopic studies of transplanted canine arterial homografts reveal certain characteristic changes.<sup>2, 5, 6, 8</sup> Within 24 hours the intima disappears and the inner surface of the vessel is composed of the inner elastic lamina. Wedge-shaped deposits of fibrin appear at the sites of eversion of the ends of the graft and host vessel. A thin layer of fibrin becomes deposited over the inner surface of the vessel. Within one week there is evidence of organization of the thrombus. Fibroblasts grow into the fibrin deposit that replaces the intima, first at the sites of anastomosis and then moving gradually toward the center of the graft. There is also regeneration of elastic fibers in the region of the inner elastic lamina. Within six months an intima is formed by the ingrowing fibrous connective tissue. At one year a lining resembling endothelium can be made out.

In the media there is a lack of nuclear staining early following transplantation of the canine arterial homograft. The muscular elements are replaced by hyalinizing fibrous connective tissue. Elastic tissue stains reveal that the elastic fibers in the media remain intact. As the restorative process continues, the elastic fibers become compressed so that ultimately the newly-formed intima may be thicker than the media. In the adventitia there is an inflammatory reaction representing a response of the host to the implanted homologous tissue. This reaction reaches its peak on the fifth day and thereafter healing

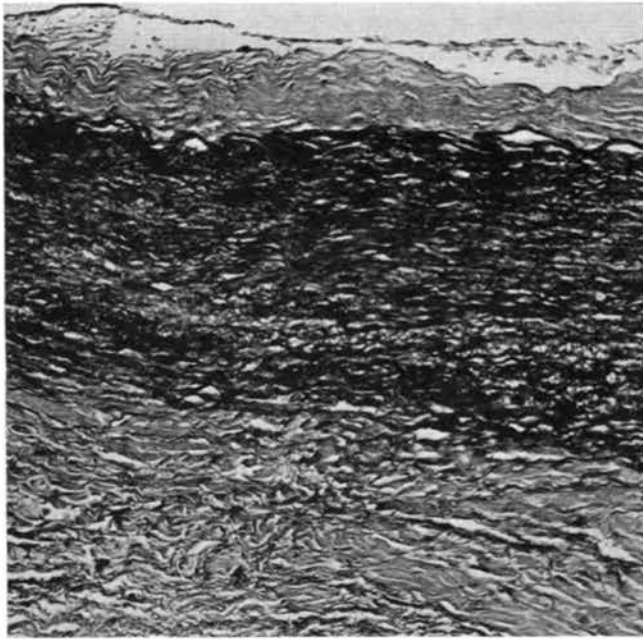

FIG. 1.—Canine autogenous aortic graft one year after transplantation. (Weigert's elastic tissue stain. Photomicrograph  $\times 90$ .)

occurs with replacement by fibrous connective tissue. Within six months the adventitia approximates the thickness of this layer in the original vessel (fig. 2).

At the anastomoses, unlike the autogenous graft, healing takes place by the formation of scar tissue. There appears to be little or no regeneration of either elastic fibers or muscular elements, and at the end of one year the everted parts of the media in the anastomosis are represented by hyalinized fibrous connective tissue.

Retrogressive changes have been observed in some arterial homografts after one year. These were in the nature of calcium deposits, myxomatous change, and fragmentation of elastic fibers.

#### *Changes in Homografts Following Production of Experimental Atherosclerosis*

The effects of atherosclerosis on aortic homografts were studied in dogs. Hypercholesterolemia was induced by rendering the animals hypothyroid by the administration of  $I^{131}$  and by the addition of cholesterol to their diet.<sup>1, 7</sup> Aortic homografts preserved in a nutrient medium were then implanted into the abdominal aorta. At the end of six months the animals that had maintained a blood cholesterol level of 1,000 mg. per 100 cc. of blood were sacrificed, and the aortas removed for study. Atherosclerosis was produced in a group of control animals in which autogenous aortic grafts were employed.

Extensive atheromatous changes were observed in the abdominal aorta including the trifurcation. Similar changes were noted in several instances along the orifices of intercostal and lumbar vessels. Grossly, the lesions were raised yellow patches up to 0.5 cm. in diameter. In some aortas the plaques coalesced, producing almost circumferential involvement. In the control group the involvement was alike in the host and the autog-



FIG. 2.—Canine aortic homograft one year after transplantation. Graft was preserved by refrigeration in balanced salt solution. (Weigert's elastic tissue stain. Photomicrograph  $\times 90$ .)

enous graft portions of the abdominal aorta. In the animals in which homografts were transplanted the atheromatous change appeared to be more extensive in the host vessels than in the grafts. In the latter group more plaques were seen just proximal and distal to the lines of anastomosis than elsewhere.

Microscopic examination of the autogenous grafts revealed areas of infiltration with foam cells in the intima, media, and about vasa vasorum in the adventitia (fig. 3). In the Weigert preparation the intimal surface was bordered by a wavy line of condensed elastic fibers with occasional flakes of fibrin attached. In focal areas of the media there was broadening of the wall with bulging into the lumen, disappearance of elastic fibers, and replacement by an amorphous fibrillar substance containing large mononuclear cells with foamy cytoplasm. In some places the media was split just below the inner elastic membrane with formation of a plaque composed of slitlike spaces and foam cells.

Microscopically, the homografts and host aortas revealed lesions similar to those described above (fig. 4). In the homografts in addition to the changes of atherosclerosis, the reparative process previously described was evident. As these grafts had been in place longer than one year, there was almost complete replacement of the grafts by fibrous connective tissue, only the elastic fibers of the media remaining. Atheromatous changes were less marked in the grafts than in the host aortas.

At first it was anticipated that the homograft, representing an area of reduced vitality of the aortic wall, would be more susceptible than the host vessel to the lesions resulting from hyperlipemia. Such results have been reported recently.<sup>4</sup> In the few experiments

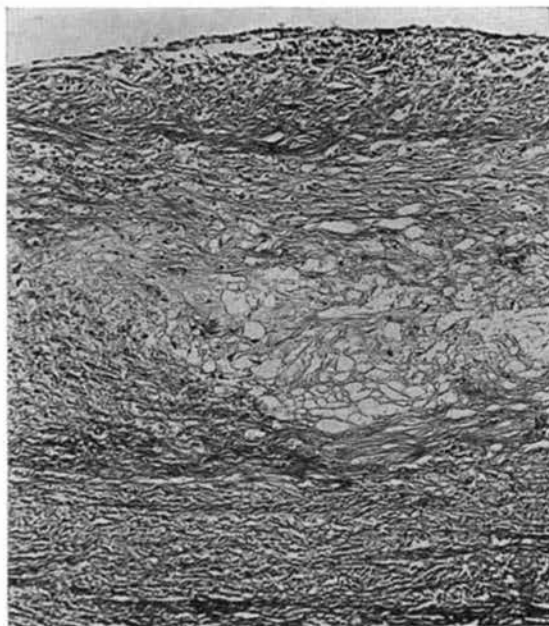

FIG. 3.—Experimentally induced atheromatous changes in canine autograft. (Masson's trichrome stain. Photomicrograph  $\times 90$ .)

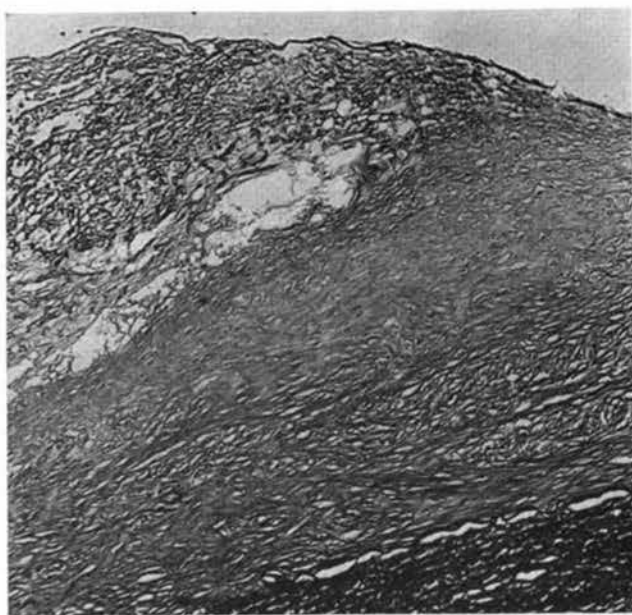

FIG. 4.—Experimentally induced atheromatous changes in canine homograft. (Weigert's elastic tissue stain. Photomicrograph  $\times 90$ .)



conducted thus far, however, the homografts appeared to be less involved than the host aortas, whereas the autografts were involved about equally with their recipient vessels. Further experiments are now in progress to determine the validity of these preliminary observations and to investigate the changes occurring in aortic homografts that may predispose to atherosclerosis.

*Regeneration and Changes in Homografts Implanted into Patients with Atherosclerosis*

The morphologic changes occurring in human aortic homografts were studied from one to 360 days following transplantation.<sup>3</sup> At the time of implantation the intima of the graft had disappeared, the media was acellular, and only the elastic fibers were intact. Shortly after transplantation the inner surface became partly covered with a layer of fibrin and the anastomoses were sealed by thrombi that filled the trough at the junction of host vessel and graft. At the end of one week, inflammatory cells were noted in the adventitia. By the end of the third week, organization of the thrombi at the anastomoses was evident, cellular infiltration had occurred about the suture lines, and new connective tissue had formed in the adventitia. In addition, collections of erythrocytes were noted in the media between the elastic fibers. By the end of the sixth week, scar tissue was evident between the host aorta and the graft. The fibrin wedge at each anastomosis was replaced by connective tissue that covered the suture material, and organization of the adjacent fibrin layer on the inner surface of the graft had begun. Near the center of the graft the luminal surface was formed by elastic fibers of the media in some places, whereas elsewhere an intima was formed by a layer of fibrin (fig. 5). There was no nuclear staining in the media, but the elastic fibers appeared well preserved. Newly formed connective tissue with coarse collagenous bundles and adipose tissue was noted in the

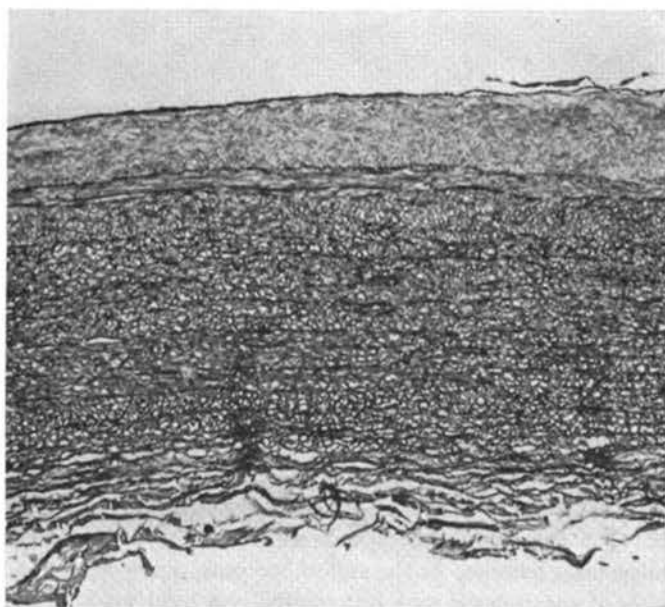

FIG. 5.—Human aortic homograft one week after transplantation. Graft was preserved by freeze-drying. (Weigert's elastic tissue stain. Photomicrograph  $\times 90$ .)



FIG. 6.—Section from proximal anastomosis of freeze-dried human aortic homograft and host aorta. The graft was removed 44 days after transplantation. The junction of atheromatous host aorta (on the left) and acellular graft (on the right) is evident. (Masson's trichrome stain. Photomicrograph  $\times 30$ .)

adventitia and increased that layer to twice its normal width. Within 70 days after transplantation the anastomoses appeared completely healed by scar tissue (fig. 6). Organization of the intima had progressed further toward the center of the graft. In many places the elastic fibers of the media formed the luminal surface. The media now contained hyalinizing fibrous connective tissue in its outer margin, and collections of erythrocytes between the elastic fibers were evident. The adventitia was composed primarily of collagenous bundles. At the end of one year, a new vessel had been formed (fig. 7a). The sites of anastomosis were represented now by dense scar tissue. The inner surface of the graft was covered by fibrous connective tissue for several centimeters from the anastomoses, while toward the center of the graft the intima was made up of

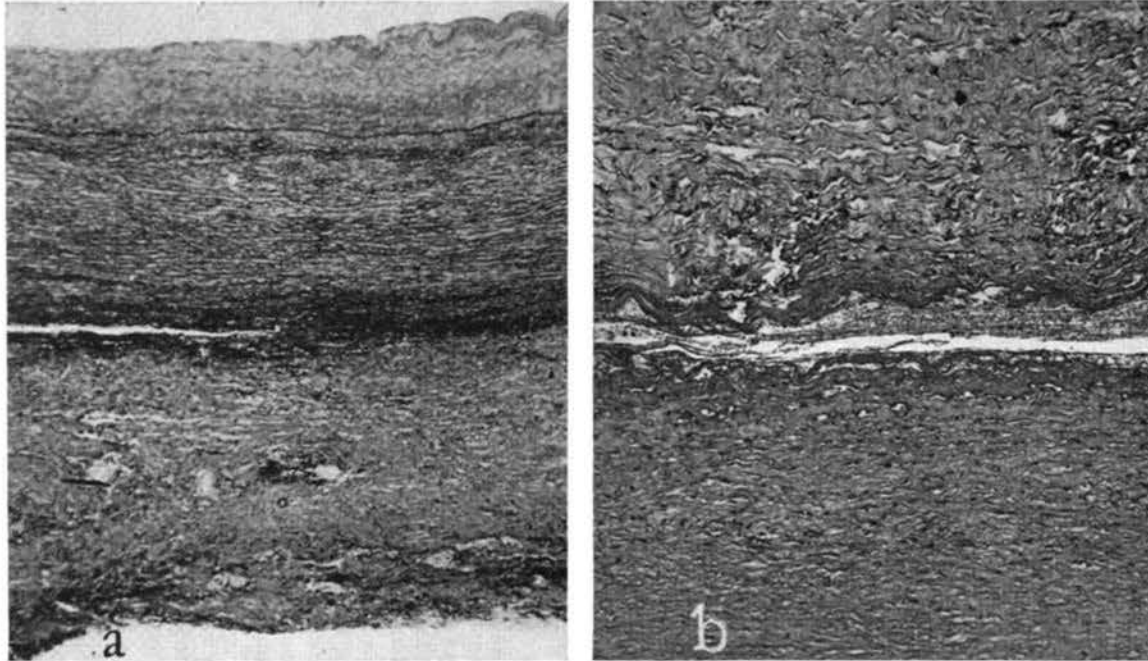

FIG. 7a.—Section from center of human aortic homograft removed one year after transplantation. (Wiegert's elastic tissue stain. Photomicrograph  $\times 30$ .) b. Higher magnification of section "a". Collections of erythrocytes are evident between media and adventitia. (Hematoxylin and eosin stain. Photomicrograph  $\times 90$ .)

a pale fibrillar substance sharply delineated from the media by an elastic lamina. In some places the inner surface of the graft was formed by the innermost elastic fibers of the media. Hyalinized fibrous connective tissue comprised about one-third of the width of the media. Elastic fibers were still well preserved, and there was no evidence of fragmentation. Extravasated erythrocytes were prominent between the adventitia and media (fig. 7b). The adventitia, almost twice the width of the media, was composed of dense hyalinizing fibrous connective tissue and contained newly formed blood vessels and nerve bundles. The blood vessels extended into the outer portion of the media. No retrogressive changes, either atherosclerotic or calcific, were noted in the graft examined one year after transplantation.

It appears, therefore, that the human homograft loses much of its structural identity after transplantation and is largely replaced by fibrous connective tissue of the host. During the period of replacement the elastic fibers of the media maintain the functional integrity of the graft. Although the ten human aortic homografts that have been studied were implanted into patients with complications of arteriosclerosis—namely, aneurysms or thrombo-obliterative disease—in no instance were changes of atherosclerosis noted in the grafts.

#### REFERENCES

1. Bevans, M., Davidson, J. D., and Abell, L. L.: Early Lesions of Canine Arteriosclerosis, *Arch. Path.* 51: 278-287, 1951.
2. Carrel, A.: Latent Life of Arteries, *J. Exper. Med.* 12: 460, 1910.
3. DeBakey, M. E., Creech, O. Jr., and Halpert, B.: Structural Changes in Human Aortic Homografts—A Study of Ten Cases, *A.M.A. Arch. Surg.*, in press.
4. Gentsch, T. O., Waters, L. L., and Green, W. W. L.: The Influence of Acute Hypervolemia on the Freeze-dried Homologous Aortic Graft, *Surgery* 35: 30-39, 1953.
5. Hierton, T. O. R.: Arterial Homograft, *Acta. orthop. Scandinav. Suppl.* 4: 104, 1952.
6. Miller, H. H., Tallow, A. D., Welch, C. Stuart, and MacMahon, H. E.: The Fate of Arterial Grafts in Small Arteries, *Surg. Gynec. & Obst.* 92: 581-588, 1951.
7. Steiner, A., and Kendall, F. E.: Atherosclerosis and Arteriosclerosis in Dogs Following Ingestion of Cholesterol and Thiouracil, *Arch. Path.* 42: 433-444, 1946.
8. Swan, H., Robertson, H. T., and Johnson, M. D.: Arterial Homografts. I. The Fate of Preserved Aortic Grafts in the Dog, *Surg. Gynec. & Obst.* 90: 568-579, 1950.
9. Tomaselli, G.: Sutura Circolare Delle Arterie Coll' Affrontamento Dell' Endotelio, *Clin. chir.* 10: 497, 1902.
10. Watts, S. H.: The Suture of Blood Vessels. Implantation and Transplantation of Vessels and Organs. An Historical and Experimental Study, *Bull. John Hopkins Hosp.* 18: 153-179, 1907.

#### DISCUSSION

*Lt. Batchelor* expressed interest in Dr. De Bakey's observation that spontaneous arteriosclerotic lesions develop in grafted dogs, and compared observations of the Navy's Experimental Surgery Unit at Bethesda on dogs similarly grafted in the abdominal aorta. The absence of clear-cut lesions of arteriosclerosis contrasts with the frequency of lesions suspected by various workers of leading to arteriosclerosis—notably mural thrombi, fat deposits, and destruction of elastic lamellas. These observations were made on grafts two years old or less.

He emphasized that the field of artery grafting may be a fruitful source of ideas and observations bearing upon the problem of atherosclerosis.

He called attention to three processes that occur in practically all grafts: fragmenta-

tion of the elastica in small clumps, but with preservation of the general architecture of the fibril elastic net; repeated small mural thrombi in frozen sections; and the presence of lipids, but without a surrounding zone of reaction. In his follow-up of one or two years he had seen many of the processes found in the disease but no composite entity that could be diagnosed as atherosclerosis, although Dr. De Bakey had found it to occur at the end of four or five years.

*Dr. De Bakey* agreed with the preceding comments. In answer to a question, he stated that mural hemorrhage had been found in areas of the graft that had been replaced by tissue laid down by the host, rather than in tissue that was originally part of the graft. The graft is gradually invaded, especially on the adventitial side, although the elastic lamina in the human transplant is still fairly well preserved at the end of one year.

He was inclined to believe that the freeze-dried grafts would show more of the changes, although his observations had not been continued long enough as yet to be certain of the difference between the freeze-dried and the fresh grafts.

He stated that his experience agreed with the conclusions of Shumacker in his review of the older literature. Contrary to expectation he had found more atherosclerosis in autografts than in homografts in dogs. From results reported in the literature he anticipated that at the end of five years lesions would be found in both homografts and autografts.

*Dr. Simeone* commented that Robert Gross had found in a five-year follow-up of children and young adults in whom he had made homotransplants into the aorta, close to the origin of the thoracic aorta, X-ray evidence of calcification which he interpreted as atheromatous changes. He observed this in three of thirty-eight patients whom he had followed one to just over five years. There were no aneurysmal dilatations, and Gross believed the changes to be of relatively minor significance.

*Lt. Batchelor*, in reply to a question by Dr. Katz, stated that he had not repeated Dr. De Bakey's experiment of superimposing atherosclerosis upon the grafted artery in the dog.

## THE REACTION OF THE ARTERY WALL TO HYPERTENSION AND TO HYPERVOLEMIA\*

L. L. WATERS

Because of the patchy distribution of arteriosclerosis, local factors apparently are involved in the development of the individual lesions. To be considered in this section is evidence that high blood pressure or increased blood volume may play a role in the occurrence of these changes. Interest in the subject stems from the frequent clinical association of hypertension with severe vascular disease, the less frequent complete nonassociation of these entities, and the striking vascular changes that occur in experimentally produced "malignant hypertension" in animals.

There has long been argument as to which is cause and which is effect—the vascular lesion or the high blood pressure.<sup>1</sup> In a section on the pathogenesis of arteriosclerosis we are not directly concerned with the possible origins of high blood pressure, but we are interested in the evidence utilized on the other side of the question. Serial biopsies of kidneys from individuals with hypertension have revealed progressive sclerosis of cortical arterioles.<sup>2</sup> While this is highly suggestive evidence for a causal relationship, it is no more than this, since any number of unknown factors might be operating to produce both an elevated blood pressure and vascular changes in the kidney in the sequence in which they occur. At least as suggestive is the large body of evidence from the post-mortem table that the lesions of arteriosclerosis are distributed not in a haphazard fashion, but generally in sites which might be expected to be exposed to extremes of mechanical stress rather than to average stresses within the circulation.

But the question remains—is there direct evidence that hemodynamic factors such as high blood pressure or hypervolemia are causally related to the arteriosclerotic process? At present the answer is not at hand, but an attempt to analyze the problem is being made through experimentation. As already stated, arteriosclerosis is a focal disease. From early times the suggestion has been made that the responsible local factor might include a nonspecific mild inflammatory reaction—the result of an injury of some kind.<sup>3</sup> Accepting this as a working hypothesis (which many do not), a number of observations have been made. When renal ischemia is produced in dogs, systemic arterial pressure is elevated. However, Goldblatt<sup>4</sup> was unable to find evidence of noteworthy arterial injury after long periods. If, on the other hand, renal ischemia was severe, with progressive nitrogen retention, not only was hypertension present but arterial necroses developed as well, similar morphologically to those occurring frequently in malignant hypertension in man.<sup>5</sup> Such experiments, though stimulating, are not particularly helpful in analyzing the role of hypertension in the genesis of vascular injury, because of the host of complicating factors. Simpler means are necessary.

As early as 1904, Josué<sup>6</sup> injected epinephrine into animals in an effort to assess directly the effect of high blood pressure on arteries. Medial necrosis, followed by calcification, was the usual result in rabbits, not arteriosclerosis. In other animals, the same changes resulted, but less consistently. An experiment of Duff, *et al.*<sup>7</sup> employing tyramine in rab-

\* Original work cited in this paper was aided by grants from the U.S. Navy, the Life Insurance Medical Research Fund, and the Veterans Administration.

bits demonstrated arteriolar necroses in the myocardium. This type of experiment was mostly discontinued, probably because changes considered to be unrelated to arteriosclerosis, even morphologically, resulted.

Recently Byrom and Dodson<sup>8</sup> attempted a direct approach to the problem by forcibly injecting large quantities of Ringer solution into the arteries of rats. Arterial necroses were found in one kidney and not in the other, which was protected by a temporary ligature on its pedicle during the period of hypertension. At face value this experiment would seem to demonstrate a clear injurious effect of hypertension on vascular wall. To anyone who will repeat these experiments, it will be apparent, however, that factors other than the mechanical one of increased intravascular pressure may be involved as well.<sup>9</sup>

Recently, an attempt to assess the role of hemodynamic factors in vascular injury has been made by returning to the injection of vasopressor substances into animals. This has resulted from the finding that aortic intimal inflammatory lesions and visceral arteriolar necroses in normal dogs follow a severe acute hypertensive episode produced by the intravenous injection of either of two structurally unrelated pressor amines, N-amyl amine and epinephrine.<sup>10</sup> That these lesions are associated with hemodynamic changes rather than with direct toxicity of the amines for the vessel wall is fortified by the finding that injections into normal dogs of yet another pressor substance, renin, results in the same lesions in the same organ pattern.<sup>11</sup> Further, the damaging vascular effects of injected epinephrine can be completely prevented by pretreatment with Dibenzamine, which abolishes the pressor effects of even enormous doses.<sup>10</sup> Finally, the extent and duration of the hypertensive episode associated with the appearance of vascular lesions is approximately the same for N-amyl amine, epinephrine, or renin.

These experiments would indicate that in the dog, at least, vascular changes follow severe short episodes of hypertension produced by vasopressor substances. The lesions occur in the base of the aorta and at the point of exit of the great branches of the arch and of the intercostals. These are favored sites for arteriosclerotic lesions in man. In the aorta, medial hemorrhage is frequent, but completely apart from this, at the sites just mentioned, the characteristic change is a slight elevation of the endothelium with accumulation of polymorphonuclear leukocytes and lymphocytes in the space beneath (fig. 1). Other inflammatory cells may be found scattered throughout the inner layers of the vessel wall. This reaction is mild and transient, resulting in intimal scar. Under normal conditions in the dog it does not contain stainable lipid. Similar changes are found at the mouths of the coronary arteries and in the first portion of the pulmonary artery.

Arterial and arteriolar necrosis occurs elsewhere in the coronary vessels (fig. 2) and in the gallbladder (fig. 3), liver, and gastrointestinal tract. Only a rare lesion is encountered in the kidneys, and none in the brain. Following administration of a pressor substance, the frequency of lesions in the portal system, the great engorgement of the veins of this area, and the rapid occurrence of enormous edema of the gallbladder have suggested a possible role of other factors—namely venous pressure, organ blood volume, and anoxemia—in the genesis of the arterial changes observed.<sup>10</sup>

In any consideration of the pathogenesis of these experimental lesions, one would like to know the role of direct toxicity of the drug, the role of the prolonged vasoconstriction, the role of a changed distribution of blood in the organs, the role of hypoxia, and, of

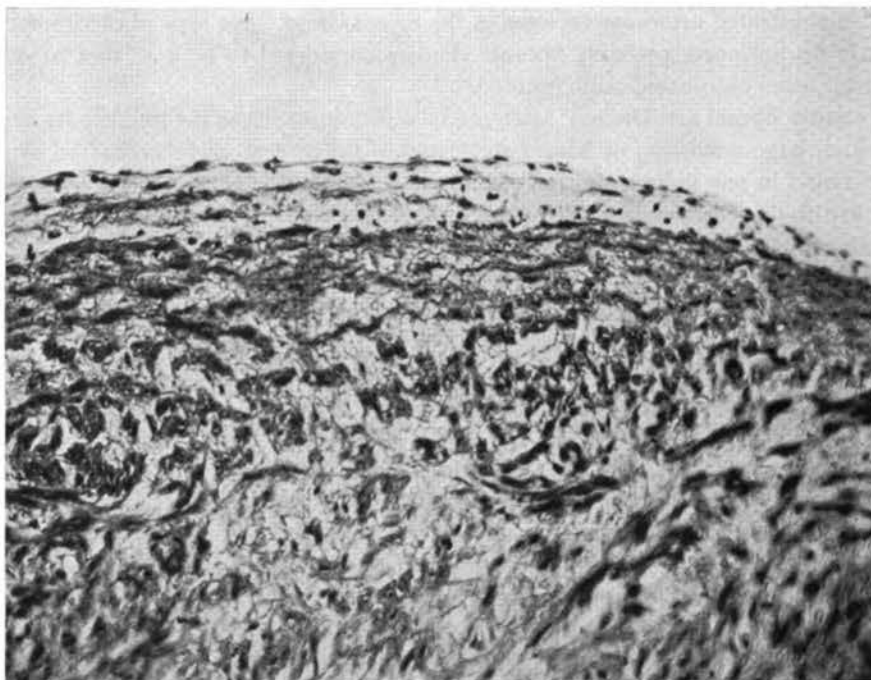

FIG. 1.—Dog. Aorta at junction of innominate artery. Subendothelial inflammatory reaction 48 hours after epinephrine-induced hypertensive episode. There is no associated medial necrosis.

course, the role of any other as yet unknown factors. The evidence has been stated for believing that a direct toxicity to the vessel wall is not concerned.

Does the prolonged vasoconstriction result in the vascular damage? This is certainly not true for the aorta and pulmonary artery. These vessels are enormously dilated during acute epinephrine hypertension. Does constriction play a role in the observed arteriolar necrosis? There is generalized constriction of the arterioles of the skin and mucous membrane, but no lesions are found here. In the viscera in which scattered lesions are found—the heart, gallbladder, liver and gastrointestinal tract—the status of the arterioles during this period of stress is not known. Are the vessels that suffer necrosis dilated, constricted, or of normal calibre? Is each vessel constricted? Are some, with less thick muscular walls, dilated due to the increased intraluminal pressure imposed on them by the constriction of their more muscular fellows? At present, these questions cannot be answered, and the fact that they cannot serves to emphasize how little is known about the exact conditions imposed by any stress on a portion of an individual artery in a given organ or tissue bed. It further points up the almost complete lack of basic knowledge as to the metabolism of the smooth muscle of the vessel wall under average conditions or under conditions of stress involving maximal constriction or dilatation.

As mentioned above, the distribution of arteriolar lesions after short severe hypertensive episodes produced in dogs by injection of vasopressor substances suggests that venous pressure changes and shifts in organ blood volume may be associated with the genesis of the arterial lesions.<sup>10</sup> Increase in central venous pressure parallel to increase in arterial pressure occurs after injection of large doses of pressor amines or of renin.



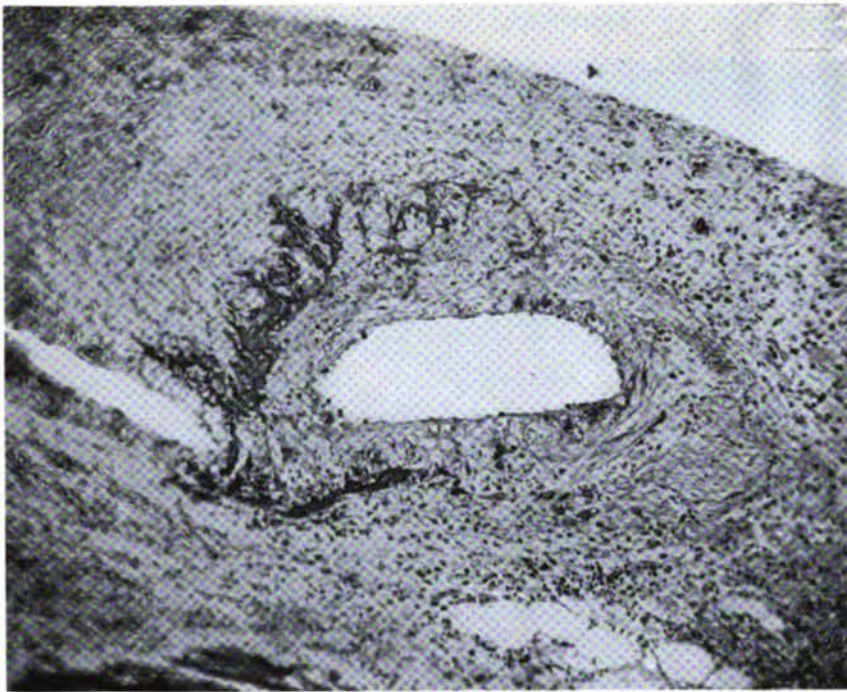

FIG. 2.—Dog. Coronary artery. Panarteritis following hypertensive episodes induced by epinephrine injections. (Courtesy Yale Journal of Biology and Medicine.<sup>10</sup>)



FIG. 3.—Dog. Artery of submucosa of gall bladder. Panarteritis following epinephrine injections. (Courtesy Yale Journal of Biology and Medicine.<sup>10</sup>)

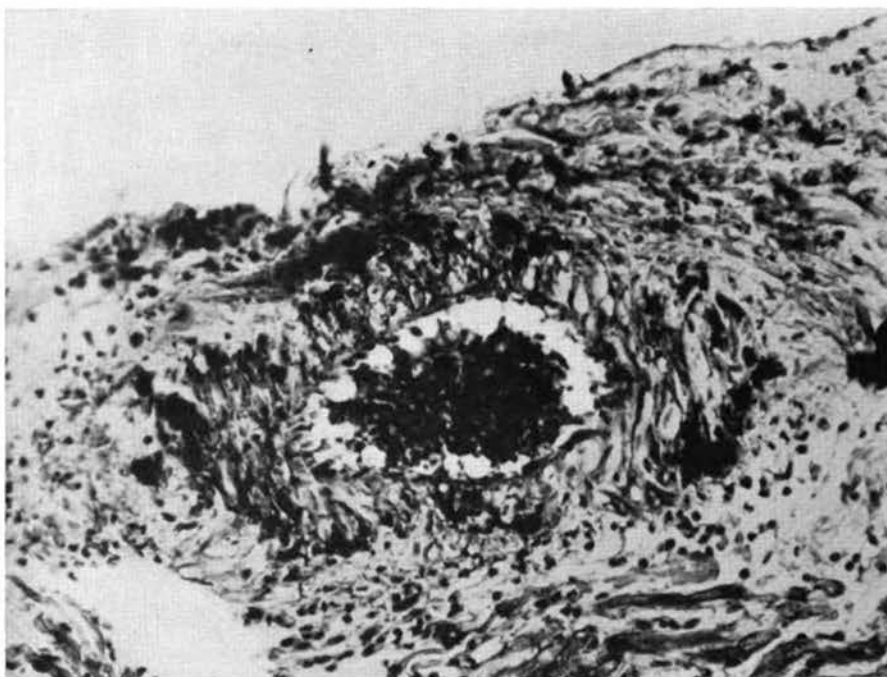

FIG. 4.—Dog. Coronary artery. Necrosis and inflammatory reaction following transfusions of compatible dog blood. (Courtesy Yale Journal of Biology and Medicine.<sup>10</sup>)

The same range and duration of venous pressure increase can be obtained without a concomitant rise in arterial pressure by giving rapid infusions of compatible blood or plasma. When this is done, the same pattern of vascular damage results as after epinephrine injection (figs. 4, 5). This suggests that changes of total blood volume or of organ blood volume may have a bearing on the development of arterial disease in these experimental conditions. Further evidence on this point is obtained from the fact that the injection of vasopressor amines and an increase in total blood volume are associated synergistically with the development of arteriolar necroses. Thus, when dogs are given blood transfusions and epinephrine together, not only does more florid vascular damage result in the usual sites, but now also diffuse, selective involvement of the renal cortical arteries occurs<sup>10</sup> (fig. 6). These observations indicate varying thresholds of injury in blood vessels in different viscera in relation to qualitative and quantitative changes in hemodynamics. Practically nothing is known concerning the factors responsible for these variations.

Although measurable anoxemia is often not present in clinical hypertensive states associated with vascular disease, nonetheless many of the experimental procedures just described in animals elicit a severe anoxemia of short duration. This is well seen, for example, after epinephrine administration. May not the resultant hypoxia of the arterial wall play a major part in its damage? Two fragments of evidence suggest that it does not. Following injection of large doses of histamine intravenously, the normal dog is in shock with the most severe anoxemia. No comparable arterial lesions are found after such episodes.<sup>11</sup> Also, in renal ischemia produced by ligation or clamping of the renal

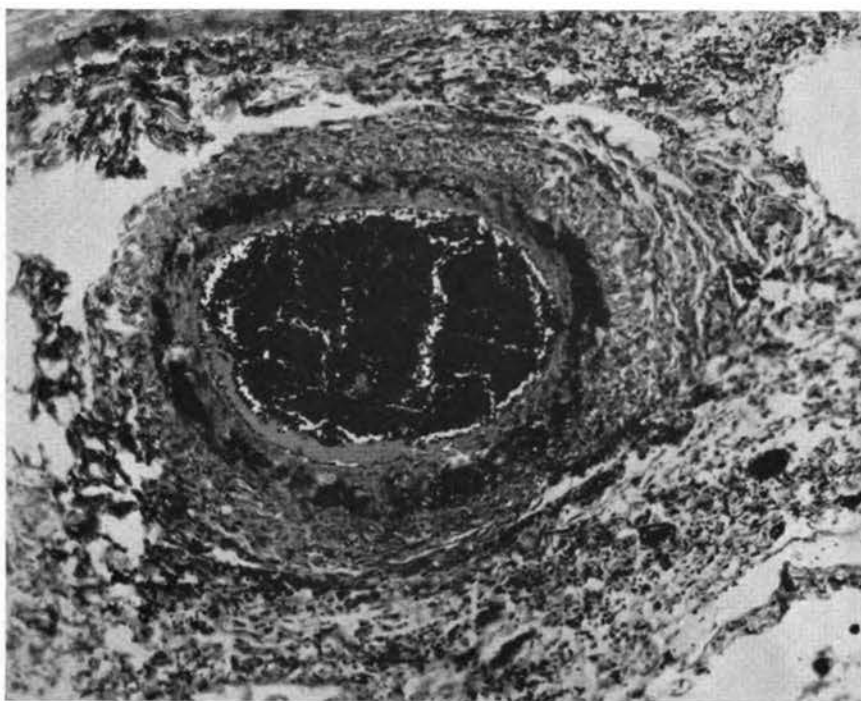

FIG. 5.—Dog. Artery of submucosa of gall bladder. Necrotizing arteritis following transfusions of compatible dog blood. (Courtesy Yale Journal of Biology and Medicine.<sup>10</sup>)

pedicle, the proximal tubule cells are the first renal structures to show effects of anoxia. After the anoxemic episode that follows transfusion and the administration of epinephrine, they remain morphologically intact, but the cortical arterioles become necrotic.<sup>10</sup>

In summary, there is considerable experimental evidence that high blood pressure can damage the vessel wall. Whether it does or not depends upon whether or not the threshold of injury of any particular vessel is exceeded; this is probably different for each segment of each vessel, and is probably changing continuously with age and with other environmental factors. The experiments have brought out the extreme rapidity with which damage to a vessel can occur and its episodic nature. Seconds or minutes of peak pressure are effective, probably more so than a steady increase over the years of the pressure mean. They have also demonstrated that the arterial lesions associated with acute hypertensive episodes are acute transient inflammations, no different qualitatively from reactions associated with other classes of injurious agents.

If it is admitted that hypertension or blood volume changes or combinations of the two initiate a mechanism that results in an inflammatory lesion or necrosis of the vessel wall, it might well still be asked: what has this to do with arteriosclerosis? It has been pointed out elsewhere in this symposium that, given proper systemic factors, simple intimal inflammation is readily transformed into a facsimile of the early lesions of arteriosclerosis. Bearing this in mind, the possible sequence: hypertension or blood volume change, arterial injury, inflammation, arteriosclerosis, is suggested.

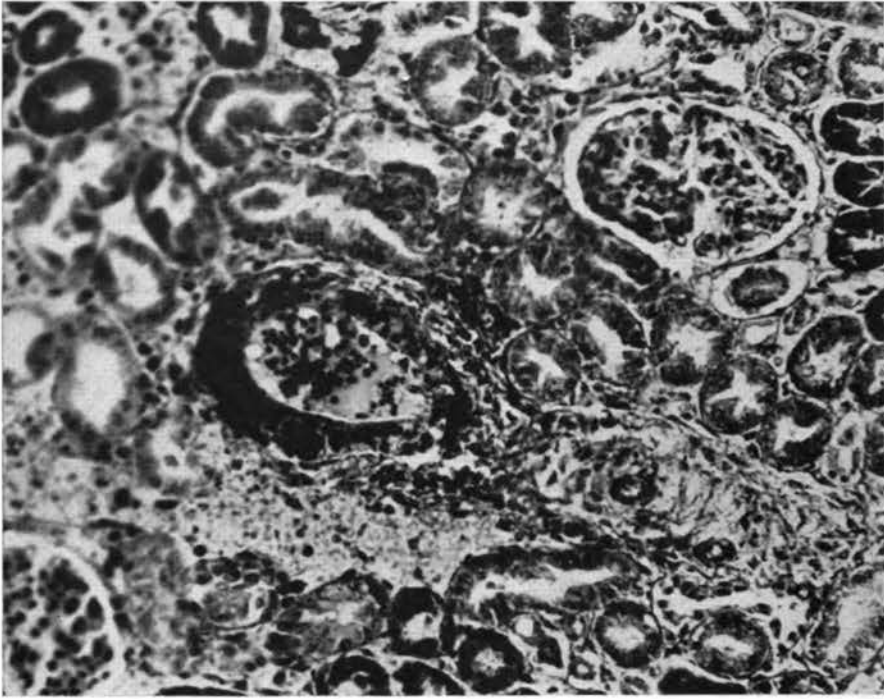

FIG. 6.—Dog. Necrosis of renal cortical artery, following combination of blood transfusions and injection of epinephrine. The cortical tubules are well preserved. (Courtesy Yale Journal of Biology and Medicine.<sup>10</sup>)

In conclusion, there remains at least one other important problem concerning the possible relationship of hypertension and the arteriosclerotic lesion. It has been shown, *in vitro*, that plasma lipids accumulate in the artery wall when plasma is forcibly filtered through.<sup>12</sup> At present, except for the evidence just mentioned, little is known of the filter-like action for plasma colloids of the normal or injured vessel at normal or increased intraluminal pressures. This is but another of the basic properties of the vessel wall that needs investigation because of its potential bearing on the pathogenesis of arteriosclerosis.

#### REFERENCES

1. Bell, E. T. (editor): *Hypertension, a Symposium*, Minneapolis, University of Minnesota Press, 1951, pp. 573.
2. Castleman, B., and Smithwick, R. H.: *The Relation of Vascular Disease to the Hypertensive State Based on a Study of Renal Biopsies from One Hundred Hypertensive Patients*, *J.A.M.A.* 121: 1256, 1943.
3. Virchow, R.: *Lectures on Cellular Pathology*, Berlin, 1858.
4. Goldblatt, H.: *Experimental Hypertension*, *Am. J. Med.* 4: 100, 1948.
5. Goldblatt, H.: *Studies on Experimental Hypertension; Production of Malignant Phase of Hypertension*, *J. Exper. Med.* 63: 809, 1938.
6. Josué, M.: *Pathogénie de l'Athérome Artériel*, *Arch. gén. de méd.* 194: 285, 1904.
7. Duff, G. L., *et al.*: *Experimental Production of Arteriolonecrosis and Medionecrosis of Arteries by Means of Tyramine Injections*, *Proc. Soc. Exper. Biol. & Med.* 41: 295, 1939.

8. Byrom, F. B., and Dodson, L. F.: The Causation of Acute Arterial Necrosis in Hypertensive Disease, *J. Path. & Bact.* 60: 357, 1948.
9. Niknejad, I.: A Study of the Effect of Increased Hydrostatic Pressure in the Pathogenesis of Experimental Arteriolar Necrosis, Yale University School of Medicine, 1950, Thesis (Unpublished).
10. Waters, L. L., and deSuto-Nagy, G. I.: Circulatory Factors in the Pathogenesis of Experimental Arteriolar Necrosis, *Yale J. Biol. & Med.* 22: 751, 1950.
11. Waters, L. L.: Unpublished experiments, 1951.
12. Wilens, S. L.: Experimental Production of Lipid Deposition in Excised Arteries, *Science* 114: 389, 1951.

## DISCUSSION

*Dr. Waters*, in response to the question whether his experiments confirmed the conclusions of Evans that one could characterize atherogenesis but not atherogenic plasma, replied that enough facts were not yet available to be sure. It was his impression, however, that there is enough lipid in the average "normal" plasma to result in arteriosclerosis, given the proper conditions in the vessel wall. Given the same conditions, lipid-rich atherogenic plasma would accelerate the process.

*Dr. Taylor* suggested that *Dr. Waters* leave the artery in the dog but apply two arterial clamps and test the effect of various lipids under pressure in vivo.

*Dr. Waters* replied that he had considered this approach. Although difficult, it could be done; but he was not certain that under these conditions enough of the various types of lipid would be deposited in the vessel wall to produce satisfactory lesions for study.

In reply to a question by *Dr. Kellner*, he stated that in dogs in which hypertension comparable in some respects to essential hypertension in human beings had been produced and sustained for at least five years, Goldblatt had not been able to find inflammatory vascular lesions comparable to those in the human subject. He felt that this might well be a question of the threshold of arterial injury.

*Dr. Masson* commented that dogs with neurogenic hypertension of a very high and fluctuating type, followed over a period of years, exhibited no lesions in the blood vessels.

*Dr. Waters* said that his experience was limited to the heart of a single dog subjected to a sudden increase in blood pressure following an increase in intracranial pressure. He had found coronary artery necrosis. This material had been kindly furnished by *Dr. A. Liebow*.

*Dr. Masson* reported that in repeating the experiments of Byrom and Dodson mentioned by *Dr. Waters*, he had measured the pressure required to produce vascular lesions in the rat. He found it necessary to inject saline under 30 to 50 pounds of pressure in order to obtain lesions, and these were limited to the kidney. Although the mesentery of the rat is very susceptible to lesions in desoxycorticosterone-induced hypertension and in renal hypertension, there were no mesenteric lesions when saline was injected under high pressure.

*Dr. Waters* stated that he had been unsuccessful in producing convincing selective necrosis of the renal arterioles by this means.

*Dr. Katz* asked whether *Dr. Waters* had obtained any effect from Dibenamine in his hypervolemic experiments. He suggested that if Dibenamine, an adrenolytic agent, could prevent hypervolemic lesions it would be of practical importance in the prevention of the type of vascular insults that occur in aviators and in the experimental centrifuge.

*Dr. Waters* replied that Dibenamine prevents lesions only when a pressor amine is

involved. He had tried other preventive measures, such as bleeding the dog before administering epinephrine, with only partial success.

*Dr. Kellner* referred to *Dr. Waters'* statement that there was a qualitative and quantitative difference in the type and amount of lipid seen in the blood vessels following the injection of chylomicron-rich plasma compared to injection of the lipoprotein fraction. He asked whether *Dr. Waters* had injected comparable amounts of lipid in the latter and whether he had followed the rate of disappearance of the lipids. He pointed out that the chylomicron is larger, that it might stay in the blood longer, and that the effects might be due to a sustained level.

*Dr. Waters* replied that in the injection experiments he had used roughly comparable amounts. He had concentrated the lipoprotein fraction from lipemic plasma. In the in-vitro filtration experiments, the amounts of fluid filtered were comparable. However, he felt that much less lipoprotein than chylomicron lipid remained in the filtering arterial segment.

*Dr. Karsner* expressed keen interest due to the fact that *Richard M. Pearce*, who performed the early experiments with epinephrine, had been his chief for several years. He suggested that *Dr. Waters* use an infusion of norepinephrine in an attempt to prolong the hypertensive effects in his studies.

He commented that although there is hypervolemia in polycythemia vera, arteriosclerosis has not been reported to be more frequent in patients with that disease.

He also suggested that a distinction be maintained between observations on arteries and on arterioles. He emphasized that in *Goldblatt's* studies in the dog the necrotizing and acute inflammatory lesions were found only in arterioles, not in arteries.

*Dr. Waters* added that an even more striking example of hemodynamic change, that which occurs in severe congestive heart failure, is not associated with the type of lesion under discussion.

*Dr. Masson*, in reply to the suggestion that norepinephrine be tried, stated that the results of chronic experiments indicated that it has exactly the same effect as epinephrine.

## SUMMARY OF PART II

G. LYMAN DUFF

I should be most remiss if I failed, at the very outset of my remarks, to congratulate the essayists of this afternoon on the excellence of their presentations. Each paper was a concise and lucid summary of a particular aspect of the general topic of this half-day session, "The reaction of the vessel wall to injury." Each paper was packed with factual information which was summarized to the point that it would be idle for me to attempt a further condensation. Rather than to summarize, my attempt will be to synthesize and generalize, in spite of the hazards inherent in premature generalizations and the risk that my own views may intrude unduly.

Several of the speakers this afternoon have re-emphasized what seems to be a self-evident fact, that since the lesions of atherosclerosis occur in patchy distribution there must be local factors in the arterial walls that predispose certain areas to disease while other areas escape. The general preoccupation with disturbances of lipid metabolism during recent years seems very largely to have obscured this obvious fact. In a recent review<sup>1</sup> Dr. McMillan and I wrote, with our tongues in our cheeks, "the casual reader of recent literature might wonder whether some authors conceive of an atherosclerosis so independent of the substrate of the vessel wall that it may occur in the absence of the blood vessels themselves." This is perhaps an overstatement; but it does need to be kept constantly in mind that, whatever disturbances of lipid metabolism may be associated with the development of atherosclerosis, local conditions in certain areas of the vessel walls must operate to predispose them to lipid deposition. Indeed, the local factors must be the determining factors, since we know that many parts of the arterial tree, though bathed by the same blood plasma, may remain completely normal in the presence of advanced atherosclerotic lesions elsewhere.

This is an old and familiar line of argument. Dr. Taylor has recalled that I urged, in a paper written twenty years ago,<sup>2</sup> the necessity of recognizing the importance of local factors in the pathogenesis of atherosclerosis. At that time I spoke of local injury to the arterial walls, using the word "injury" in its broadest sense and without being able to define all of the possible causes or the exact character of the requisite injury. However, I am not aware of any observations that have arisen in the meantime to require modification of the broad concept that some sort of local injury or degeneration with functional aberration of the vessel wall, which may be produced in a variety of ways and which may be so slight as to be scarcely detectable, is an essential prerequisite to the development at that site of the typical atherosclerotic lesion.

If this be true, it is appropriate that we should have spent the whole of this first day of the symposium on the arterial wall, and that we should concentrate attention on various kinds of arterial injury and the reactions that may follow them.

The walls of arteries everywhere include the same structural components, but arteries differ in different vascular areas because of differences in the proportions and precise arrangement of their structural elements. All arteries comprise in their structure lining endothelial cells, smooth muscle cells, connective tissue cells, collagen fibres, elastic tissues, and intercellular ground substance. It is evident from the information that has

been presented to us that these different components differ in their susceptibility to damage, and that the sensitivity of each of the structural elements is dependent to a considerable extent on the character of the injurious agent. For example, as Dr. Taylor has mentioned, the endothelium is described as being the component most sensitive to ionizing radiation. Smooth muscle seems to be somewhat less so, while connective tissue is resistant. Nevertheless, elastic membranes are susceptible to damage and, under suitable conditions of exposure, the elastic arteries of mice can be injured by irradiation in such a way as to simulate the changes of physiological aging. Injury from heat and cold may destroy all cellular elements while leaving the elastic framework damaged but intact. Direct mechanical trauma of minimal character has been shown experimentally to be capable of causing breaks in elastic membranes without producing any apparent injury to other components of the vessel wall.

It seems fairly obvious that the more violent mechanical forces involved in rapid deceleration or brought into play by increased gravitational force may be expected to produce more severe injuries in the form of tears and lacerations of arteries or partial or complete ruptures of vessels. While severe arterial injuries of this kind are clearly of immediate and practical importance to the Air Force from the point of view of human tolerance to mechanical stresses, it is of even greater importance over the long term and from the point of view of atherosclerosis to study the smallest injuries that may be done to arteries by mechanical means—hidden injuries, undetected and perhaps undetectable clinically at the time they are produced, which nevertheless may be cumulative and capable of promoting the atherosclerotic process. As Dr. Taylor has stated, it is entirely within the realm of possibility that repeated exposures to sublethal rapid deceleration or to increased G forces could produce sufficient numbers of microscopic tears in the components of the walls of arteries to result eventually in significant arterial disease.

The damage to arteries caused by chemical agents or infections also varies in degree, as Dr. Waters has shown us, according to the intensity and duration of action of the injurious agents. The injury may be so slight that morphological evidence of the injury itself is practically lacking and its presence can only be deduced from the occurrence of a minimal inflammatory reaction. On the other hand, the injury may be so intense that there is necrosis of all the coats of the arterial wall with or without thrombosis of the lumen. In the intermediate degrees of injury, the smooth muscle of the media as a rule shows itself most susceptible to damage.

The causation of acute arterial injury by physical and chemical agents and by the direct action of bacteria seems readily comprehensible, but the exact means by which hypersensitivity is effective in producing arterial injury experimentally or in the naturally occurring hypersensitivity states in man has so far defied elucidation. In this connection, Dr. Waters has brought out one point of particular interest, namely, that increased intravascular pressure produced experimentally in animals leads to acute arterial changes that are not only similar in many instances to those occurring in hypertension in man, but are also frequently indistinguishable from those that follow chemical or bacterial injuries or that are associated with hypersensitive states both in man and in experimental animals. This is not to say that the injuries in all of these examples are produced in precisely the same way, but it does illustrate dramatically the uniformity of the sequence of vascular responses when injuries of comparable quality and intensity have been wrought by any means on the arterial wall.



The role of hypertension and hypervolemia in the causation of arterial injury would appear at first glance to lend itself readily to analysis, but the papers of Dr. Waters and Dr. Masson have demonstrated how complex is the problem of their *modus operandi*, especially in the production of acute arterial injury. Dr. Waters has dealt in detail with the pathogenesis of the acute arterial and arteriolar injuries produced experimentally by pressor substances and by hypervolemia, acting either alone or together. He has brought forward persuasive evidence tending to exclude direct toxicity of the drugs employed in the experiments and to rule out the possible effects of prolonged vasoconstriction and hypoxia. On the other hand, the evidence suggests that changes of total blood volume or of organ blood volume have an important bearing on the development of the arterial and arteriolar necrosis associated with hypertension.

In addition to marshalling the experimental evidence that high blood pressure can damage arterial walls, Dr. Waters has pointed out the extreme rapidity with which damage to the arteries can occur during periods of peak pressure. I was intrigued by his statement regarding the ability of high blood pressure to damage the arterial wall: "whether it does or not depends upon whether or not the threshold of injury of any particular vessel is exceeded; this is probably different for each segment of each vessel, and is probably changing continuously with age and with other environmental factors." Here surely is a concept of great importance, but one that I think needs closer definition and certainly further exploration.

Dr. Masson's contribution falls directly into this field of enquiry. He has shown us how various endogenous metabolic factors, mostly concerned with abnormal endocrine function, are related to vascular injury and to the development of atherosclerosis. Most interesting, however, were his observations with reference to the effects of adrenal steroids, renin, angiotonin, nephrectomy, and salt, either alone or in various combinations, in causing hypertension and acute vascular injury. The experimental results that he has described led him to draw conclusions that are complementary to those of Dr. Waters regarding the effects of hypertension. Let me quote some of them. "The most important conclusion," he said, "seems to be that substances present in the body and part of its normal mechanisms of homeostasis can, in appropriate combination, elicit hypertension and vascular damage. Salt somehow enters very significantly into this process and its sensitizing effect is demonstrable in abnormals whose primary sensitization depends on nephrectomy rather than steroid excess." "The hypertension associated with these processes is doubtless a major factor, and that it acts on vessels sensitized to damage—either by salt excess, the renoprival state or electrolyte shift—is suggested by the lack of a definite quantitative correlation of hypertension with vascular damage."

Thus, from the data that have been put before us, we can picture the effects of hypertension in causing acute injury to the arteries and arterioles as being dependent, first, on the hypertension or hypervolemia itself and, second, on the varying susceptibility of the vessel walls to this kind of injury. Both factors are variables, and it appears that hypertension, slight or severe, may or may not produce vascular damage, depending on the susceptibility at any given moment of the vessel walls in the different vascular areas and in the various segments of the arterial ramifications. This is a satisfactory concept, but it is obvious that much remains to be learned about the local functional and metabolic aberrations in the vessel walls themselves that render certain areas sensitive to injury.

This is a field that has scarcely been touched and one that urgently requires investigation.

There has been paraded before us in review a wide array of agents capable of causing injury to arteries. We have examined briefly the kinds of damage they produce and some of the mechanisms of injury. What, now, of the local reactions to these injuries to the arterial walls?

The walls of arteries, like most other tissues, react uniformly to acute injuries by the rapid development of an acute exudative inflammatory reaction. This may be slight or intense, ranging from a transitory oedema of the vessel wall, in response to minor injury, to an outspoken exudation of fluid and inflammatory cells in response to injuries of more severe degree. Dr. Waters' studies have led him to the conclusion that such variations are quantitative, and depend more upon the intensity and duration of the stimulus than upon its nature. In relation to less intense but continuing injuries, inflammatory reactions of subacute or chronic type are elicited. Certain types of injuries bring out a granulomatous response, as is true in syphilitic infections of arteries, to quote but one familiar example. All of these reactions must be accompanied by functional and metabolic disturbances of the vessel wall and, perhaps more important, by changes in vascular permeability. Moreover, all of them are accompanied or followed by processes of regeneration and repair. If the injury is an acute one and not repeated, it is obvious that the ability of the vessel wall to regenerate its elements or, on the other hand, the necessity to resort to mere patching of the defect with inferior tissue, will determine not only the morphological but the functional status of that area of the vessel wall from that time onward. It is for this reason, I think, that reparative reactions have been given such a prominent place in the papers presented this afternoon.

The most desirable end-result of the healing of any injury would be the complete restoration of the original structure and function. So far as arteries are concerned this ideal of complete and perfect regeneration is seldom, if ever, achieved. Nevertheless, Dr. DeBaakey has told us that the closure by suture of wounds in normal arteries results in almost perfect restitution. Here, as in all such defects, the endothelium is regenerated rapidly and completely. The granulation tissue initially formed between the severed edges is invaded slowly by muscle cells of the media. Some elastic fibres are formed as well, both in the intima and media, but the internal elastic membrane is not restored. The end result is more or less perfect union of the media which lacks only the internal elastic membrane, but I gather that some connective tissue scar persists in the intimal and adventitial layers, and perhaps in the media as well.

The regeneration of smooth muscle cells of the media appears to occur only rather slowly, in periods of time measured in months, and it does not occur at all unless favourable conditions prevail. Dr. Taylor, in speaking of injury to arteries produced by heat, has recalled Ssolowjew's observation that the muscle cells of the media will grow into an area thus injured only if the elastic framework remains intact; otherwise the defect is made good by the growth of granulation tissue and the formation of a fibrous scar. This is reminiscent of the similar requirement of persistence of the original framework as a prerequisite to the regeneration and restoration of liver lobules after necrosis of liver cells. It seems clear, therefore, that regeneration of muscle cells in the media will occur under suitable conditions, but it seems equally clear from the study of the behaviour of various arterial injuries as one meets them in human pathological material that the

appropriate conditions are seldom met, at least in human subjects. While new elastic fibres may be produced after destruction of the media, they do not reproduce the original elastic framework. In general, it may be said that gross defects produced in the media by injury are replaced mainly by scar tissue. On the other hand, minute tears or other microscopic injuries of the media that are not associated with much disturbance of the general architecture would be expected to lend themselves most readily to repair by regeneration.

The remarkable proliferative potentialities of the subendothelial layer of the intima stand in marked contrast to the sluggish regenerative powers of the medial coat. Almost any kind of injury to the walls of arteries is followed by a proliferative response in the intima. This is true even when there is no evidence of actual destruction of any of the elements of the arterial wall, though there may be evidence of injury or irritation in the form of an inflammatory reaction. One of the best examples of this is the intimal reaction observed in the arteries in the subarachnoid space in tuberculous meningitis. In the small cerebral arteries surrounded by the tuberculous reaction the medial coat may remain quite intact, but the subendothelial layer of the intima may be greatly increased in thickness and the endothelium lifted from its normal position by the accumulation of fluid, inflammatory cells, and other indifferent cells that resemble primitive fibroblasts. Deaths from complications during the treatment of tuberculous meningitis with streptomycin have allowed us to ascertain at autopsy that the eventual outcome of this initial inflammatory reaction is a proliferative response ending in a dense concentric fibrous thickening of the intima. Since all of this may occur without any disruption of the medial coat and without any dilatation of the affected artery, I am not prepared to follow the teaching of Richard Thoma to the extent of agreeing that weakening of the vessel wall and dilatation of the artery is *essential* to the production of fibrous proliferation in the intima. I think that weakness of the media and stretching of the artery *can* stimulate diffuse intimal proliferation, but in many instances in which medial damage and intimal thickening co-exist it is probable that both are attributable to the same injurious agent, which damaged the media and stimulated proliferation in the intima at one and the same time.

The tendency of the subendothelial cells of the intima to proliferate on the slightest provocation seems to me to constitute one of the most important elements in the pathogenesis of atherosclerosis. The lesions of atherosclerosis are initially confined to the intimal layer, and they involve cellular proliferation from the very beginning. In any well-developed lesion the intimal thickening which encroaches on the lumen is composed at least as much of fibrous connective tissue as it is of lipids, as Dr. Paterson has pointed out, and in many instances it is composed mainly of hyaline connective tissue with only a small component of lipids. It behooves us, therefore, to gain some understanding of the cells from which this lush proliferation arises, some knowledge of their nature and their potentialities for differentiation.

As you all know, there has been in the past, and there still is, some difference of opinion as to whether any cells whatever exist in the subendothelial space of completely normal arteries. There are those who believe that the lining endothelium of normal arteries rests directly on the internal elastic membrane with no cells whatever in the intervening potential space. If I ever had any doubts on this question, I am now convinced that this is not so, and that in arteries of the most normal appearance in young

rabbits or in human beings, even in childhood, there are scattered cells in the sub-endothelial layer. The technique of examination of arteries from their intimal surface that I described this morning<sup>8</sup> lends itself not only to examination of the endothelium but also to the microscopic visualization of what lies beneath in the subendothelial layer. By this method one can easily find subendothelial cells where I am sure none would be seen in the examination of cross sections.

The cells that we have found as normal inhabitants of the subendothelial layer are rather widely scattered in normal arteries, but they are moderately abundant in some areas. They have an oval nucleus, a flattened cytoplasmic area of variable size, and a stellate outline with numerous long branching processes, all of which lie in the curved plane of the subendothelial space. In general, they have the appearance of primitive, undifferentiated connective tissue cells. Our observations indicate that they are capable of rapid proliferation and of differentiation into mature fibrous connective tissue cells. On the other hand, when they are presented with lipids, they are capable of accumulating lipid droplets; and the smaller ones, by drawing in their cell processes as their lipid load increases, become transformed into typical globular lipid-filled foam cells. These multipotential primitive cells normally present in the subendothelial layer of the intima must surely be the ones from which the intimal proliferative reactions take their origin.

Dr. Taylor has described the extremely interesting sequence of events whereby the wall of the rabbit's aorta, rendered necrotic by freezing, is repaired by a proliferative process which, you will note, was restricted to the intima. The proliferation of fibroblastic cells was followed by the formation of collagenous and elastic fibrils, the latter arranging themselves in a series of elastic lamellas like those normally found in the media of the aorta. The differentiation of some of the proliferating intimal cells into smooth muscle fibres is particularly interesting, in that it demonstrates another potentiality of the primitive intimal cells. The end-result was the formation of what amounted to a new aortic wall within the shell formed by the degenerating remnants of the original vessel.

Dr. DeBakey's observations also demonstrate the extraordinary proliferative properties of the subendothelial cells of the intima. Although he found that fresh autogenous arterial grafts survived virtually intact, there occurred, nevertheless, a diffuse fibrous thickening of the intima, rich in elastic fibres. His studies of the fate of arterial homografts demonstrated the disintegration of all cellular structures in the grafted segment and their replacement partly by the ingrowth of vascular fibrous tissue from the adventitial aspect but very largely, as well, by fibrous proliferation proceeding along the fibrinous lining of the graft from the intact intima at either end.

Apparently the proliferative capacity of the intima diminishes with age, as Dr. Taylor has shown in rabbits. Dr. DeBakey found that the restoration of the intimal coats of arterial homografts in atherosclerotic patients appeared to progress more slowly than in his experimental animals. He suggested that this may be due to the greater lengths of the grafts inserted in human subjects than of those commonly used in dogs. I am sure that this was an important factor, but I wonder whether diminution of the proliferative power of the intimal cells with age was not an important factor as well. Dr. Taylor has also described in detail the retardation and modification of the reparative intimal proliferation that follows freezing of the aorta in hypercholesterolemic rabbits. The presence

of lipid deposits was associated not only with retardation of the reparative proliferation in the intima, but also with the formation of mucinous or hyaline fibrous connective tissue, poor in elastic fibres, and often showing no differentiation into muscle fibres such as occurred in rabbits fed on normal diets. The whole series of observations described by Dr. Taylor and Dr. DeBakey are extremely interesting in themselves, but they are also most instructive in illustrating the capacity for proliferation and differentiation possessed by the primitive cells that normally inhabit the subendothelial layer of the arterial intima.

It seems to be one of the special misfortunes of the human race that the development of atherosclerosis should be accompanied by the formation of a new capillary network in the thickened intima. Dr. Paterson has demonstrated that these capillaries, though they may sometimes anastomose with the vasa vasorum in the media and adventitia, are usually in direct communication with the lumen of the affected artery. They presumably arise by the ingrowth of capillary buds from the lining endothelium, but precisely how and why they are formed is really unknown. Once they have made their appearance, however, their beneficial function in supplying blood to the thickened and previously avascular intima is apt to be overshadowed by the injurious effects that follow from their tendency to rupture and to spill blood into the atherosclerotic lesions that they formerly nourished.

Dr. Paterson has shown us how frequently such capillaries are formed and how frequently they rupture. The intramural haemorrhages that result can produce, in exceptional cases, complete or almost complete occlusion of the arterial lumen simply by occupying space in the wall, or they may cause partial or complete obstruction of the lumen by thrombosis, and this is common. Intramural haemorrhages may, therefore, be responsible directly, or indirectly, for acute arterial occlusion and ischaemia in the area of distribution. However, even when such immediate consequences fail to happen, there still remain the deleterious effects of repeated intramural haemorrhages on the further evolution of the atherosclerotic plaques in which they occur. Dr. Paterson has cited evidence that the haemorrhages are recurrent. Each one adds its quota of solids from the blood, and each one stirs a new wave of proliferative activity in the intima. The organization of each new haemorrhage, or of the small mural thrombi that may form in the lumen, is accomplished by further fibroblastic growth and by the formation of new capillary channels, with the added danger of further episodes of haemorrhage. The cycle of events is, therefore, a self-perpetuating one which contributes substantially to the growth of established atherosclerotic lesions. As Dr. Paterson has pointed out, we need further information on the origin of these intimal capillaries and, from the point of view of possible preventive measures, a knowledge of the factors that are responsible for their rupture is urgently required.

In conclusion, it seems appropriate to return once more to the general problem of the role of injury to the walls of arteries in the pathogenesis of atherosclerosis. So far as I am aware, every experimental observation that has ever been recorded bearing on the effect of injury to the arteries has indicated that damage to the arterial walls has a localizing and promoting influence on the development of atherosclerosis, providing that the appropriate systemic conditions are present. This is true regardless of the cause of the injury, regardless of whether it is acute or chronic, inflammatory or degenerative,

healing or healed. In other words, any structural alteration that disturbs the normal physiology of the arterial wall tends to promote the process of lipid deposition and the development of atherosclerotic lesions.

Injuries that are experimentally produced are generally rather severe ones; it is difficult to produce a slight injury and then to be sure of being able to find it. To produce an injury to an artery by cauterizing it or freezing it may seem rather artificial and violent, but is it really any more artificial and violent than causing the blood cholesterol of a rabbit, for instance, to rise to 1,000 or 2,000 mg. per cent? In the latter instance the flooding of the whole organism with lipids is apt to obscure the role of localizing factors. In these circumstances, it is probable that the smallest structural or functional aberration of the vessel wall, perhaps unrecognizable by microscopic examination, will serve to localize the lipid deposits. On the other hand, I can readily conceive that less drastic manipulation of the lipid metabolic factor may be harmless to the arteries in the absence of alterations in the vessel walls of the same character as those we recognize so easily when gross arterial injury has been produced.

There are two sides to the problem. Disturbances of lipid metabolism constitute one side; the local factors in the arterial walls that operate to permit and promote the deposit of lipids in particular areas constitute the other. It seems highly probable that the requisite local functional alterations are the result of injuries to the walls of the arteries, (if one interprets that term broadly enough) and of the reactive and reparative processes that follow them.

#### REFERENCES

1. Duff, G. L., and McMillan, G. C.: Pathology of Atherosclerosis, *Am. J. Med.* 11: 92, 1951.
2. Duff, G. L.: Experimental Cholesterol Arteriosclerosis and Its Relationship to Human Arteriosclerosis. *Arch. Path.* 20: 81 and 259, 1935.
3. Lautsch, E. V., McMillan, G. C., and Duff, G. L.: Technics for the Study of the Normal and Atherosclerotic Arterial Intima from Its Endothelial Surface, *Lab. Investigation* 2: 397, 1953.

## PART III

### AN EVALUATION OF ELECTRON MICROSCOPY IN THE STUDY OF BLOOD VESSELS\*

JEROME GROSS

#### *General Applications and Limitations*

The applicability of any tool to a specific problem generally depends on the answers to three questions: 1) What kinds of information is the method designed to give? 2) What are its fundamental limitations? 3) Can it provide useful data pertinent to the key questions raised by the problem?

The electron microscope is basically designed to reveal structural details in objects ranging in size from about 20 Å in their minimal dimension to several micra. It can also give information concerning the number, size, and shape of particles having at least one dimension in the range of 10 to 100 Å. The essential requirement for the effective use of this instrument is some identification tag for the object under study.

Identification may be accomplished in different types of preparations by several different sets of criteria:

a) If the preparation is known to be homogeneous chemically or structurally (size and shape), if its units are of a size resolvable by the instrument, and if aggregation is not excessive and does not completely alter the morphological characteristics of the individual units. Examples: Numerous plant viruses,<sup>1,2</sup> fibrinogen,<sup>1</sup> edestin,<sup>1</sup> catalase,<sup>1</sup> myosin.<sup>1</sup>

b) If the object has a highly distinctive and unique morphology as determined by previous study of purified material, it may be readily identified in a mixed population such as a tissue section or brei. It is desirable, however, to use other uniquely identifying characteristics in addition when possible (X-ray diffraction pattern or a chemical composition). Examples: Collagen,<sup>1,4</sup> E. coli bacteriophage,<sup>1</sup> mitochondria.<sup>5,6</sup>

c) The presence of a nonuniquely structured but homogeneous material always located in a specific region of a tissue, which has been well identified by other methods such as light microscopy. Example: Axoplasm of nerve fibers.

d) In the absence of morphological distinction, identification may be tentatively made if all other components of the preparation can be readily identified and there is an abundance of the nonstructured material as deduced by other means. Example: Ground substance of connective tissue in certain tissues such as cartilage, nucleus pulposus, etc.

e) Specific labelling with electron-dense stains. There are no truly specific reagents as yet.

The electron microscope may be used for the discovery and morphological characterization of biological structures or for the investigation of dynamic chemical and biological reactions.

\* This is publication no. 178 of the Robert W. Lovett Memorial Foundation for the Study of Crippling Disease, Harvard Medical School and the Massachusetts General Hospital. Part of the work cited was supported by grant-in-aid #A90(C4) from the National Institute of Arthritis and Metabolic Diseases, U.S. Public Health Service.

Typical examples of the former approach are studies of virus and bacterial morphology and the detailed structure of cellular organelles in tissue sections and breis.

The latter type of investigation generally requires greater reliance on a combined attack with several different tools. Good examples of such problems are the mechanism of muscle contraction,<sup>7</sup> fibrogenesis of collagen,<sup>8, 9</sup> the fibrinogen-fibrin transformation,<sup>1</sup> the role of cellular organelles in growth and metabolism, transport through the capillary wall,<sup>10</sup> pathological alterations, and mechanism of virus infectivity. Dynamic problems require time-sequence pictures and interpretations of spatial relationships between structures. Both types of observations are extremely hazardous and require careful statistical evaluation and control. In time-sequence studies it is far too easy to select those pictures which subconsciously satisfy a preconceived or "pretty" hypothesis. Spatial associations of several structures are frequently the result of artificial affinities produced by manipulative procedures, such as purification, fixation, embedding, surface tension during drying, internal brownian movement, electrostatic charge, etc. No known technique of sample preparation for electron microscopy is free of all these hazards. Artifacts due to contamination from reagents and other unidentified tissue components are an all too frequent and painful occurrence. Statistical evaluation is a serious problem in electron microscopy. If preparations are made by a standard procedure of allowing particles in a suspension to settle out on the supporting collodion film followed by draining of the excess fluid, then selective sedimenting time, selective adsorption to the film, and selective distortion due to drying may produce nonrandom sampling. This problem can be resolved in some cases by the specialized techniques of preparation by ultracentrifugation<sup>1</sup> and by droplet spraying combined with freeze drying.<sup>1</sup> However, even these methods are unsatisfactory for highly asymmetric particles. Statistical study of tissue sections may be very difficult because of the relatively few cells which can be studied at one time. A single section of tissue cut by a modern thin-sectioning microtome is of the order of 0.0001 cubic mm. Examination of even several hundred cells for detailed structure is a considerable job. However, when alterations in structure are all-or-none phenomena this problem is simplified.

Technically, the advances in electron microscopy have been great. The standard instruments in capable hands can resolve 50-Å structures clearly, and are capable of detecting particles down to 10 Å, the width of a single polypeptide chain. Methods of preparation of particles from suspension and of extremely thin, well fixed and embedded tissue sections have made possible considerable new advances in colloidal biochemistry and histology.

#### *Applications to vascular tissue*

*Normal Structure*—The strictly morphological approach would involve characterization of the individual components and their interrelationships. Included would be the endothelium, basement membranes, vascular smooth muscle, and the connective tissue components, fibroblasts, collagen, elastin and the ground substance. Excluding the cells, these could be investigated individually by fragmentation of the tissue, fractionation, purification of the individual components, and examination by depositing on the grid from suspension. This method is effective only when a high degree of purification of the component is possible without much structural alteration. Careful identification of the components is essential to avoid misleading interpretations.



The modern procedures of thin sectioning, fixation, and plastic embedding<sup>1</sup> are essential for revealing detailed structure in labile elements such as cells and also for demonstrating relatively intact structural interrelationships between constituents. Such special structures as basement membranes require the thin sectioning technique because they represent a very small fraction of the tissue and are not easily isolated and purified. Only the most preliminary examination of capillaries and basement membranes such as those of the glomerulus have been reported.<sup>11, 12, 13, 14</sup> Such studies might lead to the investigation of dynamic processes such as genesis of the different types of vessels in embryos, in healing wounds and tissue cultures; aging changes in the different components; tissue and species differences, etc.

*Physiological Activity*—The most prominent active properties associated with the blood vessel wall are contractility, elastic deformation, and passage of fluids and particulates to and from the tissues.

The present lively controversy as to whether plasma and tissue constituents diffuse or flow through the capillary wall would seem to invite study of the colloidal architecture of the endothelium and extracellular substances such as intercapillary cement (if it exists) and surrounding connective tissue. The "pore theory" of fluid passage may be susceptible to proof by the electron microscope, since actual pores of the order of 50 Å in diameter are postulated.<sup>15</sup> A recent hypothesis advanced by Palade<sup>10</sup> on the basis of electron microscope studies on capillary endothelium postulates as the mechanism of fluid transport an active bulk secretion by the process of pinocytosis, commonly observed in tissue culture cells, in which small volumes of the medium are engulfed and transported through the cell protoplasm.

To the writer's knowledge there has been very little if any work done on the fine structure of vascular smooth muscle. Studies on muscle structure and function have contributed greatly to our understanding of basic life processes, and investigations on forms other than striated muscle may significantly add to that progress. In addition there always exists the possibility that structural variants may be found which will shed light on abnormal contractility of the vascular musculature.

*Pathology*—Two possible structural approaches to vascular pathology are (a) examination of actual lesions by electron microscopy, and (b) a study of the sequence of changes produced in the blood vessels of experimental animals by agencies known to lead to vascular lesions.

The first proposal involves difficulties which are not inconsiderable. Sampling and identification problems in electron microscopy of normal tissues are difficult enough without the added complications of tissue destruction, inflammatory products, and the general colloidal holocaust which must occur in inflammatory and necrotic lesions. One preliminary approach to this problem is to attempt to define the range of structural reactivity of purified tissue components under the influence of known agents and controllable experimental conditions.<sup>16</sup> This point will be discussed in more detail.

Time sequence studies of structural changes in the various components of the vessel wall induced by controlled agents such as increased pressure, blood cholesterol in rabbits, allergic vascular phenomena, etc., are likely to produce useful data. However, the interpretation of the structural changes may very well require additional knowledge from other sources. Such morphological observations may be most useful in indicating the need for certain biochemical or physical chemical approaches to the problem.

It is worth re-emphasizing that the electron microscope, like all other instruments, has a narrow although powerful range of application, and will contribute most effectively when it is used in concert with other chemical and biological tools.

## REFERENCES

1. Hall, C. E.: *Introduction to Electron Microscopy*, New York, McGraw Hill, 1953.
2. Wyckoff, R. W. G.: *Electron Microscopy, Technique and Applications*, New York, Interscience Publishers, 1949.
3. Burton, E. F., and Kohl, W. H.: *The Electron Microscope*, New York, Reinhold, 1942. (Primarily for an elementary review of the principles of electron optics.)
4. Bear, R. W.: *The Structure of Collagen Fibrils*, *Advances Protein Chem.* 7: 69, 1952.
5. Palade, G. E.: *The Fine Structure of Mitochondria. An Electron Microscope Study*, *J. Histochem. Cytochem.* 1: 188, 1953.
6. Sjostrand, F. S., and Rhodin, J.: *The Ultrastructure of the Proximal Convoluted Tubules of the Mouse Kidney as Revealed by High Resolution Electron Microscopy*, *Exp. Cell Res.* 4: 426, 1953.
7. Huxley, H. E.: *Electron Microscope Studies of the Organization of the Filaments in Striated Muscle*, *Biochim. et biophys. acta* 12: 387, 1953.
8. Gross, J., Schmitt, F. O., and Highberger, J. H.: *In Vitro Fibrogenesis of Collagen*, *Proc. Fourth Josiah Macy, Jr., Foundation Conference on Metabolic Interrelations* 4: 32, 1952.
9. Porter, K. R.: *Repair Processes in Connective Tissue*, *Proc. Second Conference of the Josiah Macy, Jr., Foundation on Connective Tissue* 2: 126, 1951.
10. Palade, G.: *Fine Structure of Blood Capillaries*, *J. Appl. Physics* 24: 1424, 1953.
11. Pease, D. C., and Baker, R. F.: *Electron Microscopy of the Kidney*, *Am. J. Anat.* 87: 349, 1950.
12. Dalton, A. J.: *Structural Details of Some of the Epithelial Cell Types in the Kidney of the Mouse as Revealed by the Electron Microscope*, *J. Nat. Cancer Inst.* 11: 1163, 1951.
13. Oberling, C., Gautier, A., and Bernhard, W.: *La Structure des Capillaires Glomerulaires Vue au Microscope Electronique*, *Presse Méd.* 59: 938, 1953.
14. Hall, B. V., Roth, E., and Johnson, V.: *The Ultramicroscopic Anatomy of the Glomerulus*, *Anat. Rec.* 115: 315, 1953.
15. Pappenheimer, J. R.: *Molecular Exchange Processes in the Capillary Circulation*, *Proc. XIX Internat. Physiol. Congress*, p. 32.
16. Gross, J.: *Evaluation of Structural and Chemical Changes in Connective Tissue*, *Ann. New York Acad. Sc.* 56: 674, 1953.

# THE APPLICATION OF NEWER TECHNIQUES TO THE STUDY OF BLOOD VESSELS

FRANCIS O. SCHMITT

## *Polarization Optics*

The application of polarization optical methods to the examination of the blood vessels has been of very limited value. The method is useful primarily for the detection of preferred orientations of molecular or colloidal constituents, for deducing the shapes and orientations of submicroscopic constituents (chiefly fibrous or lamellar configurations), and for assessing the chemical nature of materials (e.g. lipid, protein, nucleoprotein, etc.). For details of this method see Schmidt,<sup>8</sup> Bennett,<sup>5</sup> and Schmitt.<sup>9</sup>

The method may therefore help in the determination of the relative amount of collagen in a vessel wall; of course, an accurate determination would require chemical methods. Elastic tissue is less readily examined, being isotropic unless stretched.

The directions in which the collagenous fibrils are wrapped in a vessel may be deduced directly from polarized light observations, provided the geometry is favorable.

The presence of crystalline aggregates may be discovered very readily. The type and intensity of the birefringence displayed depends upon the nature of the material. Many steroids and other types of 'casts' are included in this category.

The writer is unaware of any detailed investigation of the structure of blood vessels by polarized light. It is possible that such a study may prove rewarding, particularly in connection with the smaller vessels, capillaries, and tissue space surrounding the capillaries.

## *X-Ray Diffraction Analysis*

This method gives information about the orientation of fibrous constituents, the interatomic, intramolecular structure of biological materials, and also the large repeating structures, extending over hundreds of Angstrom units, as in the case of the axial period of collagen and a few other proteins. It permits identification of certain types of substances which show characteristic X-ray diffraction patterns.

X-ray diffraction patterns of the blood vessel wall would doubtless indicate the presence and the preponderant orientation of the collagen fibers. It is unlikely that it would indicate anything else in the wall unless there were crystalline organic concretions (steroids, etc). In this case it is quite possible that the substance could be identified from the pattern.

By the use of a very finely collimated beam of X-rays it is possible to obtain diffraction patterns from microscopic regions of a specimen, as Kratky showed many years ago with hair keratin. This method has been applied to the heart by Feitilberg and Kaunitz, who also demonstrated the presence of collagen in human chordae tendineae.<sup>7</sup> It is quite feasible in this way to demonstrate the invasion of vascular and other tissues by connective tissue. It is doubtful, however, that information will come from this approach which could not have been obtained from classical histological methods.

Details of the use of X-ray diffraction methods, particularly on collagenous tissue may be obtained from the review of Bear.<sup>2</sup>

*X-Ray Absorption Spectrography*

This method would seem to be very applicable to the study of blood vessels not only in fixed and prepared sections, but, in favorable circumstances, also in the living animal.

This technique has a history dating back at least to 1913, when Goby first described what he called X-ray "microradiography". Another name which has been applied is "historadiography" (Lamarque, 1936). As applied to the study of blood vessels the terms "microvasoroentgenography" (Bohatyrtshuk, 1942), "microarteriography" (Barclay, 1951) and "microangiography" (Bellman and Engstrom, 1952) have been used. (For present purposes we prefer to adopt the last named.)

Engstrom<sup>6</sup> developed the method whereby one may not only observe microscopic details of structure on a photographic emulsion by the use of X-rays, but may also gain information about the chemical composition of the structure by the measurement of intensity variations as a function of X-ray wave length, i.e. by observing the change of absorption on either side of an absorption edge. The analytical method is best applicable in a quantitative micro sense to elements of low atomic number. This method permits determination of the mass of extremely small objects (see Engstrom and Lindstrom, 1950).

However, in connection with the examination of blood vessels this method has been of less practical value than that involving the use of injected materials, such as thorotrast, which increase the X-ray contrast. Small blood vessels were first investigated in this way by Grechishkin and Prives (1935-1938) in Leningrad. Another Russian, Bohatyrtshuk, in 1944 employed fine-grain (Lippmann) emulsion, thereby observing capillaries and minute blood vessels in sections, particularly of tumors.

Following publication of a book on microarteriography<sup>1</sup> by Barclay, in 1951, Bellman and Engstrom<sup>4</sup> surveyed the theoretical background of the field and stressed the value of stereoscopic techniques in obtaining three-dimensional effects. They applied the word microangiography to the method which uses X-ray contrast media and microradiographic techniques.

The reader may obtain an introduction to this field by reading the small monograph by Bellman.<sup>3</sup> This author studied blood vessels not only on surgical and autopsy material but also on normal living animals and on those subjected to cold injury. A striking three-dimensional effect is obtained by viewing the colored stereomicroangiogram with red and blue polaroid spectacles. The sections may be as thick as 1 mm.; magnifications ranging from 57 to 125 X are shown.

It is difficult to guess the type of information which will eventually result from application of this method. Already observed are such effects as constriction, dilation, spasm, establishment of shunts, necrosis, and aggregation of cells and clots in vessels.

## REFERENCES

1. Barclay, A. E.: *Micro-arteriography*, Oxford, Blackwell Scient. Pub., 1951.
2. Bear, R. S.: *The Structure of Collagen Fibrils*, *Advances Protein Chem.* 7: 69-154, 1952.
3. Bellman, S., and Engstrom, A.: *Microangiography*, *Acta Radiol.* (Suppl. 102) pp. 1-104, 1953.
4. Bellman, S., and Engstrom, A.: *Microangiography*, *Acta Radiol.* 38: 98, 1952.
5. Bennett, H. S.: In McClung, E. D.: *Handbook of Microscopical Technique*, New York, Harper & Brothers, 1950, pp. 591-678.
6. Engstrom, A.: *Quantitative Micro- and Histochemical Elementary Analysis by Roentgen Absorption Spectrography*, *Acta Radiol. Suppl.* 63: 1-106, 1946.

7. Feitilberg, S., and Kaunitz, P. E.: X-ray Diffraction Studies of Human Chordae Tendineae, *Biochim. et biophys. acta* 3: 155-160, 1949.
8. Schmidt, W. J.: *Die Doppelbrechung von Karyoplasma, Zytoplasma und Metaplasma*, Berlin, Borntraeger, 1937.
9. Schmitt, F. O.: Tissue Ultrastructure Analysis: Polarized Light Method. In Glasser, O.: *New Medical Physics*, Chicago, Year Bk. Pubs., Inc., 1950, pp. 1128-1132.

## SUMMARY OF PART III

F. O. SCHMITT

Some of the possibilities of the use of electron microscopy for the study of arteries and blood vessel structure have been indicated by Dr. Gross.

Because no one has made detailed investigations of the vessels per se, the lantern slides exhibited were those of other studies in which blood vessels were encountered incidentally.

As a biologist I must emphasize that it is the reacting system that must be thoroughly understood. Although particular chemicals may act as evocators, they are evoking phenomena within an organized system. To understand the chemical response we must learn as much as possible of the ultrastructure of the system down to the molecular level. Dr. Gross has shown lantern slides at high resolutions of sections which are of the order of 500 Angstroms in thickness. The one of Huxley's section of muscle was 200 Angstroms or  $\frac{1}{50}$  micron in thickness. Herein lies one of the potentialities of electron microscopy: that when applied to very thin sections it begins to reveal structure at the macromolecular level.

Dr. Geren, one of my associates working in the electron microscope laboratory at the Children's Hospital, has been sectioning pure lipid systems and lipid protein complexes which we obtained from Folch-Pi and from others. She has examined these first by X-ray diffraction to disclose the molecular relationship and then has fixed the specimens with osmic acid, followed by imbedding in plastic and sectioning. The important thing is that staining with osmic acid and imbedding in plastic do not seem to change their molecular pattern.

Refinements in this technique are developing so rapidly and the resolution possible is so high that I cannot predict what will be found when these methods are applied to investigations of the blood vessel wall. I can promise you that the study will be worth doing.

It is interesting to speculate that some of the endothelial cells which are pleomorphic, and are doubtless metabolizing at great rate, may have differentiation of function undreamed of at the present time.

Although the electron microscope offers great promise for elucidation of the ultrastructure of the blood vessel wall, it should not be used in an isolated morphologic study. On the contrary, the study of the chemical dynamics of the system should be correlated as intimately as possible with the structural investigation. These two aspects should preferably be carried out in the same laboratory, inasmuch as each influences the conduct of the other.

## DISCUSSION

*Dr. Lansing* emphasized that elastin is difficult to study with the electron microscope because it is notably lacking in electron density after fixation with osmic or phosphotungstic acid.

*Dr. Schmitt* agreed, and explained that in order to obtain the high resolutions de-

scribed it is necessary to load the material with substances of high electron density such as the heteropolyacids.

*Dr. Page* asked how one could be certain that treatment with phosphotungstic acid did not disrupt the molecular orientation.

*Dr. Schmitt* replied that the studies on muscle, done by *Dr. Huxley* and referred to by *Dr. Gross*, were a result of his small-angle X-ray diffraction studies at the Cavendish Laboratories in Cambridge, England, which predicted that the myosin molecules would be hexagonally arranged and that between the myosin columns a protein, which he suspected to be actin, would be identified. This was later confirmed by electron microscope studies of osmic-fixed material heavily impregnated with phosphotungstic acid.

*Dr. Gross* agreed with *Dr. Lansing* that the electron microscope is useful only in the study of structures having the type of organization adapted to that technique.

In response to the question whether the electron microscope could be used to study arteries as well as capillaries, he replied that it would be necessary to evolve a technique to fit the tissue, but that he saw no reason why that could not be accomplished.

*Dr. Schmitt* emphasized that elastin has a peculiar structure. He suggested that the technique used in the study of muscle to demonstrate that myosin is in the A bands and not in the I bands might be adapted, through the use of elastase, to determine the architecture of elastin in the vessel. This technique used on muscle consists in dissolving out the myosin with an appropriate salt solution, thereby causing the birefringence of the A band to disappear, and eliminating the 110-Angstrom columns.

*Dr. Lansing* reiterated that he did not mean to disparage the use of the electron microscope. He had obtained good electron micrographs of arteries, but they were not more informative than good histological sections.

*Dr. Schmitt*, in reply to a question by *Dr. Anfinsen*, stated that it should be possible to hook up the shorter chains with a higher weight element by phosphorylation and make the substance visible by polarization.

In reply to a question by *Dr. Page*, he stated that polarization optics is a flexible and useful procedure. The only equipment required is a polaroid film beneath the condenser and above the objective, a high-intensity light source, and certain compensators. However, it is also necessary to understand the theory and to employ the technique properly in order to obtain useful information by this method.

He added that interference microscopy, like the phase contrast type, gives additional detail not afforded by ordinary microscopy with the usual lighting. This can be used with either stained or unstained sections. With the interference microscope it is possible to detect and quantitate differences of density within the cell.





## PART IV

---

### LIPIDS, LIPID METABOLISM, AND THE ATHEROSCLEROSIS PROBLEM A General Introduction

ALBERT L. LEHNINGER

The purpose of this paper is to provide a rather general introduction and framework of discussion for the essentially biochemical papers which follow. This Symposium brings together specialists in many different areas for "cross-fertilization," and therefore this paper is addressed largely to the nonbiochemists participating here. Space does not permit a full review of the rather general aspects of lipid metabolism as they pertain to atherosclerosis; the excellent article of Gould<sup>1</sup> should be considered as required reading for nonchemists.

The following introduction is offered by one with absolutely no research experience in the field of atherosclerosis and with only a limited background in the immense literature in this area. Nevertheless, atherosclerosis is a problem of special interest to biochemists now, because the last few years have seen the development of a tremendous momentum of research success in the chemistry and intermediary metabolism of the lipids. The atherosclerosis problem, of all the major health problems at this time, appears to be one in which biochemistry may be able to do much toward the early diagnosis and therapy, and possibly even soon. At the same time, this disease state focuses attention on some little-understood areas of biochemistry, and has already accelerated research on some major fundamental problems of lipid metabolism. This paper will concern first, some justification for considering atherosclerosis as a disease of lipid metabolism and transport; second, some rather general aspects of lipid biochemistry as it relates to atherosclerosis; and third, a very brief résumé of the recent and significant advances in the intermediary metabolism of fatty acids.

The biochemists participating in this Symposium have been asked to justify the proposition that atherosclerosis is in fact a disease of lipid metabolism and transport. More specifically, is a defect in lipid metabolism or transport the primary "trigger" factor which sets off the chain of events leading to the clinical condition? In the preceding discussions, full consideration has been given to various theories of the etiology of atherosclerosis based on damage to the intima by anoxia, hypertension, defects in the intramural circulation, intramural hemorrhage, local breakdown of lipid-phagocytic cells, and so on. These may be grouped and called the "nonlipid theories" of atherogenesis. Then there are the "lipid theories" and in particular, the "cholesterol theory." The "cholesterol theory" now has impressive support, ably summarized in the recent volume by Katz and Stamler.<sup>2</sup> However, even the staunchest proponent of the "lipid" or "cholesterol" theory present at this meeting will have to agree that there is no definitive proof that a defect in lipid metabolism or transport is the primary event, and will have to agree also that local factors must play an important role because of the characteristically patchy distribution of the lesions. But regardless of the nature of the primary event, it seems hardly necessary to justify the extensive discussions on lipids which follow in this

Symposium. After all, it is the accumulation of lipid in the vessel wall which in many cases clearly creates the immediate functional and clinical problem. Furthermore, there is ample evidence from experimental atherosclerosis of a relationship between hyperlipemia and the development of the lesion, and it is also a fact that atherosclerosis can be produced in animals by feeding a lipid, namely, cholesterol. For early diagnosis and rational preventive and therapeutic measures a knowledge of the peculiar biochemical changes involved in atherosclerosis, as in any disease, will be an essential basis. Unhappily, we know too little in *biochemical* terms at present of the "nonlipid" factors in the etiology of atherosclerosis. On the other hand, there is already available considerable important information on the lipid aspects of the problem, and at present we are witnessing an enormously increasing momentum in all phases of lipid biochemistry which can be expected to break through into new areas of understanding in the very near future. I therefore take a pragmatic view in expressing the conviction that the lipid approach will be more fruitful in the near future for diagnosis and prevention. However, until it has been clearly proved that lipids or cholesterol are the "trigger" factor, it would be ridiculous to deny the importance of continuing investigation on local injury factors of "nonlipid" nature.

To make justification of the "lipid approach" more a matter of facts and figures, let us consider the nature and amounts of the lipids present in the normal media and intima, in atheromatous lesions at various stages, and in blood plasma. Several careful studies have been made; some well-known data of Hirsch and Weinhouse<sup>3</sup> are presented in table I.

It may be noted that normal media and intima differ quantitatively in lipid distribution, but that normal intima has a lipid distribution almost identical with that of the blood plasma lipids. It may be pointed out here that plasma lipids have a relatively unique distribution among various tissues and body fluids, differing markedly from the distribution in such tissues as muscle, kidney, and so on. In the table are included some

TABLE I  
LIPID COMPOSITION OF INTIMAL LESIONS AND BLOOD PLASMA  
(Hirsch and Weinhouse<sup>3</sup>)

	Total lipid†	Cholesterol*		Phospholipid* (total)	Neutral fat
		Free	Ester		
Normal media . . . . .	8.31	17.3	16.7	34.1	31.9
Normal intima . . . . .	14.4	14.2	38.6	20.1	19.1
Early fatty plaques . . . . .	25.9	16.2	38.5	19.0	20.5
Fibrous plaques . . . . .	27.2	18.1	47.5	14.9	15.0
Calcified tissues . . . . .	12.8	21.9	47.2	13.2	13.1
Atheromas . . . . .	36.0	27.2	42.1	16.0	10.4
Blood plasma lipids . . . . .		14.1	38.3	22.8	23.3
Beef heart . . . . .		2.07	1.40	59.9	24.3
Beef kidney . . . . .		8.35	1.97	59.9	31.5

† % of wet tissue.

\* % of total lipid.

figures on muscle and kidney to illustrate this point. For this reason, the similarity of lipid distribution between normal intima and plasma takes on a special significance and has suggested that the intimal lipids, which are very largely extracellular, are derived from blood plasma by an infiltration process. Especially significant is the close correspondence of the ratios of free and esterified cholesterol. Early fatty plaques are richer in *total* lipid than normal intima but preserve the ratios of the plasma lipids, suggesting that all plasma lipids are deposited in the same ratio as they exist in plasma. As plaques become "capped" and fibrous and eventually ulcerate, the proportion of total cholesterol increases. The most striking point then is the similarity between plasma lipids, the lipids of the normal intima, and those of the *early* lesion. The later increase in cholesterol will be discussed below.

All this, however, is circumstantial evidence; the similarity between plasma lipids and early plaque lipids could be entirely fortuitous, and these figures are therefore no proof that normal intimal lipids and plaque lipids are derived from plasma lipids. If there are such things as "good" and "bad" circumstantial evidence, then I feel this evidence is "good"—but still circumstantial. It can be expected that the isotope tracer method will yield conclusive data concerning the origin of the lipids of the intima in the near future.

It has been demonstrated in Chaikoff's laboratory, by use of isotopically labeled precursors, that sections of aorta of at least one species are capable of the biosynthesis of lipids at a respectable rate,<sup>4</sup> and it must be conceded that a possibility exists that the lipids of the plaque are synthesized locally by the vessel wall and are not deposited from the blood at all. However, I believe Dr. Gould has found the aorta of certain species to be incapable of cholesterol synthesis. It appears to me far more likely that the plaque lipids are deposited from the blood rather than synthesized locally, since any point on the inner surface of the aorta, for instance, is exposed to a relatively massive rate of flow of the lipid-rich plasma which, on a molecular basis, must surely exceed the rate of biosynthesis in the relatively acellular intima by several if not many orders of magnitude. More recent isotopic tracer work on this question is discussed elsewhere in this volume by Dr. Gould.

There is more evidence that implicates lipids, and especially cholesterol, in the atherosclerosis problem: the experimental production of the lesion by feeding of cholesterol, and the relationship between atherosclerosis and plasma lipid or cholesterol levels, or both, in experimental atherosclerosis. The salient points of this evidence will be brought forward in detail by others. However, despite the eloquent arguments marshalled by Katz and Stamler in their recent monograph, I am not yet ready to align myself wholeheartedly with the "cholesterol" school of thought, of which they are champions. One reason follows from the data of Hirsch and Weinhouse. Although the cholesterol content of the fibrous and ulcerous lesions is extremely high, as may be noted in the table, it is most significant that normal intima, normal plasma, and early fatty plaques have essentially the same lipid composition, of which total cholesterol makes up about 50%. The *early* lesion is to me the significant point in the atherogenic process. The later stages, in which the proportion of cholesterol and its esters is much higher, could very well be due to selective removal of the other lipid forms by phagocytosis and autolytic changes accompanying necrosis and ulceration. I should like to point out here that among the many lipid forms, cholesterol appears to be unique in that it is not oxidized to completion in mammalian tissues to any significant extent. Although the biosynthesis of chole-

terol occurs in a number of tissues, this appears to be an essentially irreversible process as far as the steroid nucleus is concerned, although there is of course some biological oxidation of the side-chain. It is conceivable that phagocytes and foam cells at the plaque can slowly remove other lipid forms by engulfment and oxidation, but that cholesterol remains resistant and thus accumulates. Phagocytes are known to take up cholesterol particles readily in some circumstances, but it is not certain that they can degrade the cholesterol. Such cholesterol-laden macrophages may well remain at the site of the plaque and redeposit cholesterol as they die, accounting for the accumulation of cholesterol in an essentially secondary manner.

In essence, then, the similarity of lipid composition between plasma, normal intima, and the early plaque has been an important influence on research and thought, which has been supplemented by the great body of work on the relationship between cholesterol feeding and hypercholesterolemia and experimental atherosclerosis.<sup>2</sup>

To a biochemist with only a smattering of textbook pathology, it appears that there is a far greater variety of lesions characterized by faulty transport and deposition of lipids than by deposition and transport, in the strictest sense of the words, of protein, carbohydrate, or any other major chemical component of cells and tissues. Some are enumerated: Obesity is an abnormal accumulation of neutral fat in adipose tissue. Then we have the various types of fatty infiltration and yellow atrophy to which the liver parenchyma are extraordinarily susceptible and which can be caused and controlled by a great variety of influences. In sprue or celiac disease there is the failure of lipids to be transported through the intestinal mucosa. There is the deposition of cholesterol and stone formation in the biliary ducts and gall bladder. Then there is hyperlipemia, either essential or secondary to a whole host of other conditions. Then follow the great number of different xanthomatoses, lipodystrophies, lipomas, Gaucher's disease, Nieman-Pick disease, and all the other exotic lipid storage diseases. The question may be asked: What is there about lipids which predisposes to such abnormalities? Possibly the common denominator is the fact that the lipids as a class are insoluble and incompatible with an aqueous environment, and that the biochemical devices employed by the organism to keep them suspended and mobile tend to break down easily. There are, of course, many insoluble components in cells and tissues, such as keratin, elastin, and collagen. However, unlike these, the lipids are substances which must undergo physiological transport through the intestinal mucosa, through other membranes, and cell walls, and must circulate in the blood in concentrations far higher than their own inherent solubility in water. Of course, many lipids are relatively stable and fixed, as in the brain and nervous system, but of the major components of blood plasma only the lipid moieties are by themselves relatively insoluble "hydrophobic" substances. It would appear then that the lipids as a class offer the organism some problems in making them "mobile" and compatible with an aqueous environment.

In order for the lipids, as a class, to become soluble and mobile, the chemical device of the lipoprotein has evolved. In the lipoprotein the desirable "hydrophilic" characteristics of globular proteins overcome the "hydrophobic" qualities of the lipid and furnish the necessary "solubility" and mobility to the lipids. Considered broadly, then, the various pathologies involving lipid deposition and transport could result not only from defects in the biosynthesis, oxidation, or other purely metabolic transformations of the lipid moieties, but also defects in the coupling or uncoupling of the lipids with the correspond-

ing protein molecules. In fact, the latter may be by far the more important in at least some of the enumerated pathologies.

Although lipoproteins are to be discussed in more detail by others later, I should like to make a few more generalizations on lipoproteins as a class. As will be pointed out below, there are many known types of lipids and probably many more of still unknown structure. This implies that there are many different types of lipoproteins. In fact, considerable support can be marshalled for the view that *virtually all lipids normally found in tissues and body fluids exist in the form of lipoproteins or lipid-protein complexes.*<sup>5</sup> Possible exceptions to this statement may be the neutral fat droplets in adipose tissue or the large chylomicrons, but even here there is some evidence that protein plays a role in stabilizing these finely emulsified droplets of fat. The definition of a lipoprotein offered here is a very broad one and includes not only the relatively very stable lipoproteins, with rather well defined composition and size, such as those studied so thoroughly by the Harvard group, but also much more fragile and unstable types which readily dissociate and which may border on being complexes of variable composition rather than homogeneous macromolecules. Even the more fixed or structural lipids which do not undergo physiological transport may very largely exist as lipoproteins; some work we have done on lipids of mitochondria indicate that they are very tightly bound and can be extracted completely only after digestion of the mitochondria with proteolytic enzymes.

It is already clear from the work of the Gofman school and others that plasma lipoproteins exist in a spectrum of different sizes, or more properly, sedimentation rates. I merely wish to point out here that sedimentation rate is only one of several possible dimensions in which the various lipoproteins may differ among each other. The structure and function of lipoproteins is, in fact, almost completely virgin territory and only the surface of this field has been scratched. By this statement I do not mean to minimize in any way the fine work done by the Harvard group and other laboratories. Not only is there much to learn of the structure and varieties of lipoproteins, but also the mechanisms, possibly enzymatic, by which the coupling and uncoupling of the lipid and protein moieties are effected. It is in these coupling processes that I expect important clues as to the etiology of lipid storage diseases and atherosclerosis to arise in the future.

I feel this point is so important that I present the following picture as a possible biochemical mechanism in the etiology of atherosclerosis which is entirely speculative and manufactured out of whole cloth only to make my point:

Suppose the intimal (or medial) cells contain enzymes capable of splitting the lipid-protein linkages of certain types of plasma lipoproteins, and that such enzymes function normally to provide fatty acids for enzymatic oxidation in the caloric machinery of these cells. Normally these enzymes would be under some control to allow smooth function and split only enough plasma lipoprotein for immediate caloric needs. However, through the action of some local injury factor (i.e. anoxia, etc.) the cells involved autolyze, releasing a large amount of the lipoprotein-splitting enzyme locally. Lipoproteins are split in excess, and the now insoluble lipid moieties precipitate out and form the first deposits of the plaque. The lipoprotein-splitting enzyme could be rather specific, attacking only the  $S_r$  12-20 lipoproteins, for instance. However, those lipoproteins richer in phospholipid might competitively inhibit the enzyme, accounting for the inhibition of atherogenesis afforded in alloxan diabetes, in which there is a high level of plasma phospholipid,<sup>6</sup> etc., etc.

The formation and dissociation of some lipoproteins may be spontaneous and non-enzymatic; however, it is far more likely that specific enzyme systems are involved in this process physiologically. The preceding speculative "etiology" illustrates that much could be done in this area, in which Dr. Anfinsen and his colleagues have already made an excellent beginning.

The next topic that bears some discussion is the structure and function of the lipids themselves. Textbooks of biochemistry present neat little cut-and-dried classifications of the different lipids: neutral fat; phospholipids, which are broken down into lecithins, cephalins, and sphingomyelins, cerebrosides, cholesterol and its esters, and so on. There are also a number of very widely used analytical methods which are stated to measure these different classes of lipids. The generally cut-and-dried exposition of these matters in textbooks leaves the impression on non-biochemists that we know all about this subject. Actually, here also is a large area of ignorance. To take an example: among the phospholipids may be listed not only the classical lecithins, cephalins, and sphingomyelins, but also serine phosphatides, inositol phosphatides, acetalphosphatides, polyglycerolphosphatides, and the various phosphatidic acids, to include only major *known* phospholipids isolated in the last ten years. It should be pointed out that these lipids are not mere biochemical curiosities; some of the latter are present in very substantial amounts in various tissues. In addition, evidence is accumulating for the existence of many more types of phospholipids and other complex lipids, some with rather unsuspected structures and some with considerable biological activities. With this newer information has come the realization that the classical analytical methods for lipid distribution are quite unsatisfactory, particularly those dealing with phospholipids. The structure and composition of the plasma phospholipids have not yet been worked out to everyone's satisfaction.

With these more recent discoveries of whole new classes of lipids has also come the embarrassing realization that we really know very little about the function of the different lipids. To be sure, the fatty acid portion of the lipids undergoes enzymatic oxidation, releasing energy, and thus provides a large portion of the caloric requirement. Furthermore, we know that the biosynthesis of fatty acids is a very active process, by which carbohydrate and amino acids taken in excess can be converted into neutral fat for storage. The usual textbook classification into storage, transport, and structural lipids is more a matter of convenience than of any real knowledge. For instance, the textbooks say that phospholipids represent the transport form of lipid, and indeed early isotope experiments appeared to bear this out. More recent and more critical isotopic experiments indicate that phospholipids may not be the preferred transport form. Neutral fat now appears to be far more interesting in this connection than was true in the past. It may be pointed out here that the biological function of cholesterol itself is by no means clear. To be sure, it serves as a precursor of the bile acids and possibly of the sex and adrenocortical steroids. However, cholesterol and its esters are found in every cell type of the mammal so far examined. In short, then, there is very little known about the real biological functions of the various lipid types, but the isotopic tracer approach is beginning to give far more revealing answers on the function and turnover of plasma and tissue lipids.

These large gaps in our knowledge of lipid biochemistry may appear to belie my statement that the "lipid approach" to atherosclerosis may be expected to be fruitful in the

near future. However, in the last few years some important windows have opened to the problem, and very recent work provides new outlooks, approaches, and techniques which were really undreamed of only a few years ago. Others on the program will discuss cholesterol metabolism, lipoproteins, and lipid transport. As my share, I shall outline very briefly the important recent advances in the intermediary metabolism of fatty acids, the fundamental role of coenzyme-A in this and related processes, and the mechanism of the enzymatic synthesis of phospholipid from its building blocks.

The last few years have seen this whole new area of enzyme chemistry develop, with a formidable literature, to which only a few important guides can be furnished in this paper. Rather than attempt a chronological review, I shall summarize these developments only briefly and diagrammatically where possible.

First of all, the enzymatic oxidation of fatty acids (and this refers to both saturated and unsaturated acids) occurs by the gross pathway shown in the first diagram (fig. 1). It will be seen that a two-carbon fragment is the basic building block which ultimately enters the tricarboxylic acid cycle and is completely oxidized to  $\text{CO}_2$  and  $\text{H}_2\text{O}$ . In the liver these may combine with each other to form acetoacetate and  $\beta$ -hydroxybutyrate, the ketone bodies. The extrahepatic tissues, which also oxidize fatty acids, are capable of oxidizing the ketone bodies as well, via the common two-carbon fragment and the tricarboxylic acid cycle. Recent advances also have demonstrated that carbohydrate, via pyruvic acid, and the carbon skeletons of amino acids ultimately form this two-carbon unit, which thus is the common denominator and means of interconversion of fat, protein, and carbohydrate.

The enzymatic oxidation of fatty acids by this mechanism was first demonstrated reproducibly in cell-free extracts less than ten years ago. The process requires the interaction of ATP,  $\text{Mg}^{++}$ , inorganic phosphate, and certain other factors described below.

## GROSS PATTERN OF FATTY ACID OXIDATION

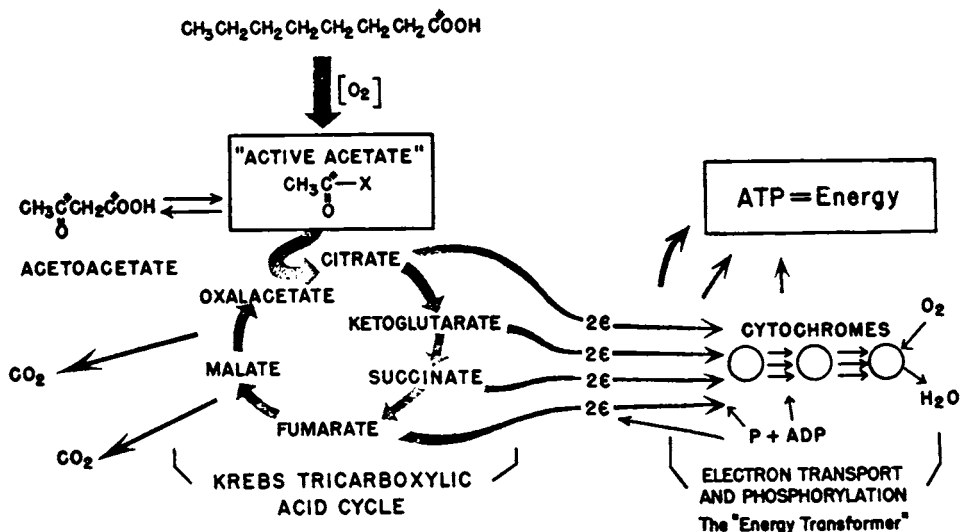
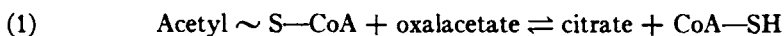

FIG. 1.—From Lehninger, A. L.: *Journal of Agricultural and Food Chemistry* 1: 1194, 1953.

It was ultimately demonstrated that this complex series of reactions, including the tricarboxylic acid cycle, takes place in the mitochondria, not only of the liver cell but of other cell types, and a good deal of information is now available relating the morphology of the mitochondria to the organized function of the enzymes making up this multi-enzyme system.<sup>8</sup>

The nature of the two-carbon fragment has become clear from the work of Lipmann and Lynen and their colleagues within the last three years.<sup>9</sup> It is an ester of acetic acid with the thiol group of coenzyme-A, indicated in the diagram (fig. 2). Coenzyme-A is thus an acetyl carrier, and acetyl-CoA is the "active" form of acetic acid. Acetyl-CoA takes part in enzymatic reactions with certain acetyl acceptors. For instance, it provides the means of entry of fatty acids into the tricarboxylic acid cycle by condensing with oxalacetate to form citrate.<sup>10</sup>



It takes part in the biosynthesis of acetoacetate:<sup>11</sup>

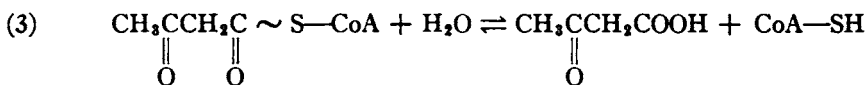
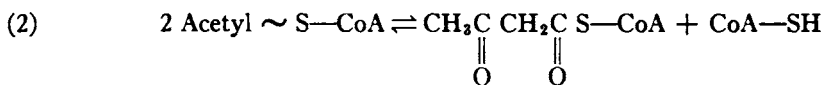

This general pattern of reactions involving acetate and coenzyme-A, and the techniques used to follow these reactions, have, within the past year, led to the definition of the mechanism of oxidation of the long-chain fatty acid to the stage of acetyl-CoA, very largely in the laboratories of Lynen, Ochoa, and Green.<sup>9</sup> The picture is presented diagrammatically in figure 3.

It is seen that the fatty acid itself undergoes activation by ATP and coenzyme-A with formation of a long-chain fatty acid ester of CoA analogous to acetyl-CoA. Enzymatic dehydrogenation takes place at the  $\alpha$  and  $\beta$ -carbon atoms through the action of a metalloflavoprotein. Hydration of the double bond so created leads to the  $\beta$ -hydroxy acid-CoA ester. Curiously, this  $\beta$ -hydroxy acid is not of the same stereochemical configuration as the free  $\beta$ -hydroxybutyrate found in the blood and urine, but the significance of this situation is not yet clear.<sup>12</sup> Finally, the  $\beta$ -hydroxy acid, in the form of the CoA ester, is dehydrogenated, yielding a  $\beta$ -keto acid-CoA ester. This undergoes an enzymatic "thiolysis" at the expense of another molecule of CoA, and we end up with a molecule of acetyl-CoA and a fatty acid chain, shortened by a two-carbon unit, in the form of its CoA ester. This cycle is repeated some seven or eight times until the whole fatty acid chain is degraded into acetyl-CoA units, which of course may then be oxidized via the tricarboxylic acid cycle or may take part in certain other vital reactions. Each of the enzymes involved has been highly purified, and Beinert and his colleagues have achieved a complete in-vitro reconstruction of the enzymatic oxidation of butyrate.<sup>13</sup> Each reaction is reversible; it has recently been demonstrated, also in Green's laboratory, that the purified enzymes, supplied with a reductant, catalyze the formation of butyryl-CoA from acetyl-CoA.<sup>14</sup> It is therefore probable that the biosynthesis of fatty acids proceeds by reversal of this reaction scheme. In a nutshell, we have here a picture of



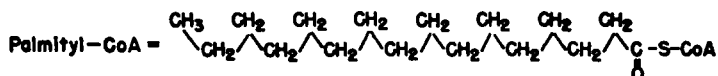
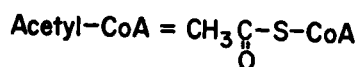
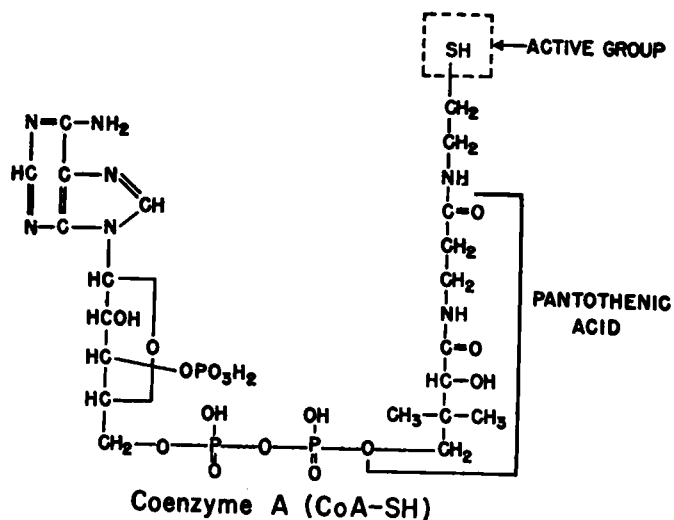

FIG. 2.—From Lehninger, A. L.: *Journal of Agricultural and Food Chemistry* 1: 1194, 1953.

progress literally undreamed of a few years ago. Furthermore, these investigations have brought a variety of new experimental methods.

You will note that this reaction scheme requires a free fatty acid or its CoA ester as the substrate. However, fatty acids, for all practical purposes, do not exist as such in tissue. This mechanism implies, then, that lipids must first undergo cleavage before the fatty acid moiety can be oxidized. Furthermore, it implies that fatty acids are built up as CoA esters and must then undergo reaction with glycerol or glycerophosphate to form the complete fat or phospholipid. The mechanism of the enzymatic synthesis of phospholipid and phosphatidic acids has also been greatly clarified in the past two years, and here again coenzyme-A plays a role.

Work in our laboratory several years ago had demonstrated that isolated mitochon-

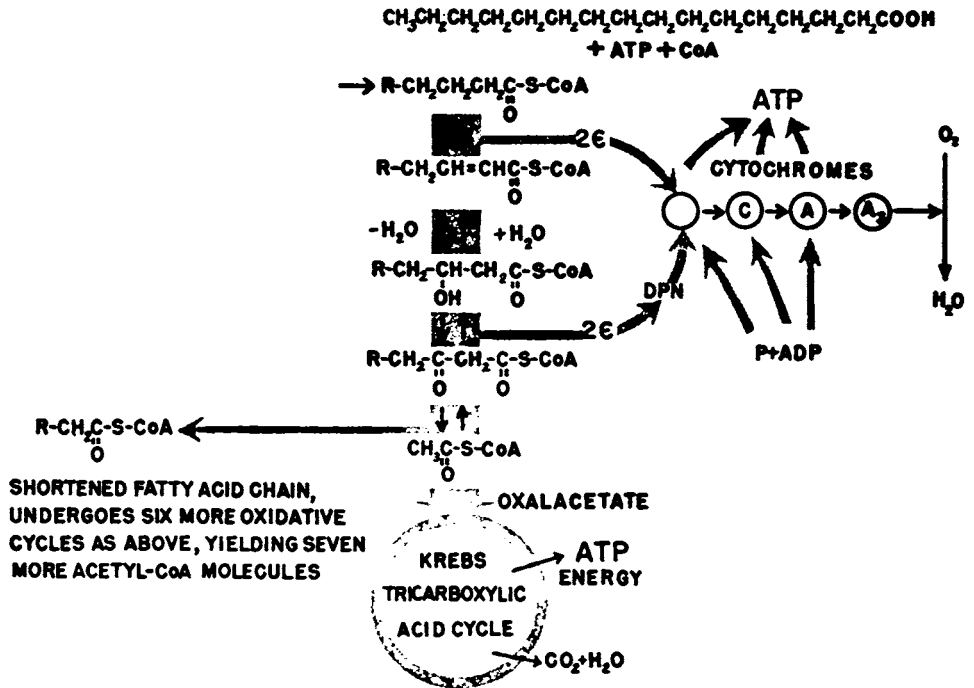

FIG. 3.—From Lehninger, A. L.: *Journal of Agricultural and Food Chemistry* 1: 1194, 1953.

dria could cause the incorporation of orthophosphate labeled with  $\text{P}^{32}$  into their phospholipids. Kennedy has recently continued this work, demonstrating that various isotopically labeled components of phospholipid such as fatty acids, glycerol, phosphate, and choline can be put together enzymatically in extracts of mitochondria to form lecithin or a phosphatidic acid<sup>15</sup> (fig. 4). Concurrent work of Kornberg and Pricer<sup>16</sup> con-

**BIOSYNTHESIS OF PHOSPHOLIPID IN MITOCHONDRIA (KENNEDY)**

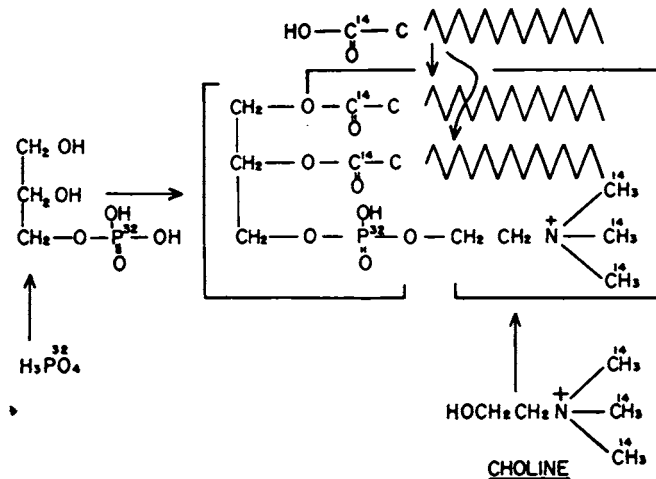
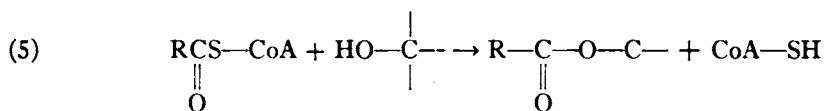
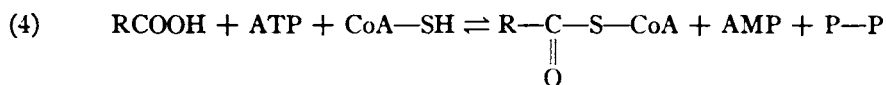

FIG. 4.—From Lehninger, A. L.: *Journal of Agricultural and Food Chemistry* 1: 1194, 1953.

firmed this and established that CoA is involved in the enzymatic synthesis of the glyceride linkage, as follows:



By this transesterification reaction, the fatty acid exchanges its CoA group for the alcoholic hydroxyl group of glycerophosphate, creating a new glyceride bond. It appears possible that this reaction is reversible, although this question has not yet been studied.

The sequence of reactions involved in the synthesis of phosphatidic acid is therefore:

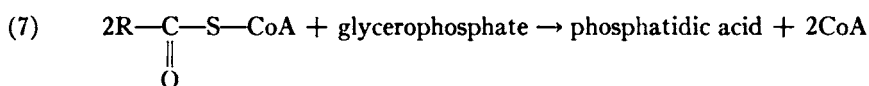
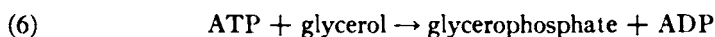

Two mechanisms appear to be involved in synthesis of the complete lecithin molecule. Kennedy has recently demonstrated that the phosphatidic acid reacts with choline to form lecithin in mitochondria. However, Kornberg and Pricer have found a separate and distinct enzymatic mechanism for introduction of choline. This appears to involve an enzymatic reaction between a diglyceride and phosphorylcholine, to form a complete lecithin molecule. Both mechanisms can now be studied on the enzymatic level.

This very recent work on the mechanism of biosynthesis of phospholipids is extremely important because it supplies the key to a fundamental common denominator in the biosynthesis of all lipids containing fatty acids in ester linkage. This key is the participation of coenzyme-A in the manner just outlined. It can be expected with some confidence that the mechanism of biosynthesis of other compound lipids will be investigated with success in the near future.

Of particular importance to the atherosclerosis problem are the enzymatic mechanisms of synthesis and hydrolysis of cholesterol esters. Although a cholesterol esterase is known and has been studied by many workers, the extremely low activity of typical preparations of the enzyme may be indicative that the reaction requires cofactors, possibly coenzyme-A. Work on the cholesterol esterase mechanism is now under way in our laboratory along these lines.

It is hoped that this brief and general introduction will have served to point out some critical areas in lipid biochemistry, as they pertain to the atherosclerosis problem.

#### REFERENCES

1. Gould, R. G.: *Am. J. Med.* 11: 209, 1951.
2. Katz, L. N., and Stamler, J.: *Experimental Atherosclerosis*, Springfield, Charles C Thomas, 1953.
3. Hirsch, E. F., and Weinhouse, S.: *Physiol. Rev.* 23: 185, 1943.
4. Siperstein, M. D., Chaikoff, I. L., and Chernick, S. S.: *Science* 113: 747, 1951.
5. Chargaff, E.: *Advances Protein Chem.* 1: 1, 1944.
6. Duff, G. L., and Payne, T. P. B.: *J. Exper. Med.* 92: 299, 1950.

7. Kennedy, E. P., and Lehninger, A. L.: In McElroy, W. D., and Glass, H. B.: Phosphorus Metabolism, Baltimore, Johns Hopkins Press, 1951, vol. II, p. 253.
8. Lehninger, A. L.: Enzymes and Enzyme Systems, Ed. J. T. Edsall, Boston, Harvard Univ. Press, 1951.
9. Reviews by Lipmann, F., Novelli, G. D., Lynen, F., Mahler, H. R., and Kaufman, S.: Symposium on Chemistry and Functions of Coenzyme-A, Fed. Proc. 12: 673, 1953. (Excellent reviews of recent progress.)
10. Stern, J. R., Coon, M. J., and del Campillo, A.: Nature 171: 28, 1953.
11. Lynen, F., and Ochoa, S.: Biochim. et biophys. acta 12: 299, 1953. Essentially concise review.
12. Lehninger, A. L., and Greville, G. D.: Biochim. et biophys. acta 12: 174, 1953.
13. Beinert, H., Bock, R. M., Goldman, D. S., Green, D. E., Mahler, H. R., Mii, S., Stansly, P. G., and Wakil, S. J.: J. Am. Chem. Soc. 75: 4111, 1953.
14. Stansly, P. G., and Beinert, H.: Biochim. et biophys. acta 11: 600, 1953.
15. Kennedy, E. P.: J. Biol. Chem. 201: 399, 1953.
16. Kornberg, A., and Pricer, W. E.: J. Biol. Chem. 204: 329 and 345, 1953.

### DISCUSSION

*Dr. Katz* felt that there could be agreement that localizing factors are not necessarily extraneous to the presence of excessive amounts of lipoproteins. He pointed out that the lesions produced by cholesterol in previously uninjured vessels are focal and not uniformly distributed.

*Dr. Lehninger*, in reply to a question by *Dr. Page* as to whether a protein is needed to make phospholipids and sodium soaps soluble, stated that although their polar groups made phospholipids relatively more soluble than neutral fat or cholesterol esters, nevertheless they still required solubilization by conjugation with protein.

He added that *Fairbairn* in Canada had proved that there is virtually no free fatty acid or soap in tissue that is fixed immediately in liquid air; that which is found on chemical analysis is due to autolytic changes post mortem. He pointed out that these substances are extremely toxic, both in general systemic action and in their specific actions on many enzyme systems. He was of the opinion that few if any lipids circulate in the form of free fatty acids or soaps.

*Dr. Anfinsen* added that the concentration of free fatty acids or sodium soaps in plasma is undoubtedly extremely minute, if it exists at all. It can all be accounted for as albumin-bound or lipoprotein-bound fatty acid. If the concentration that can be bound is exceeded, all contributions to the level of fatty acids, from whatever sources derived, cease, and any reaction tending to produce more fatty acid is inhibited. Mitochondria are poisoned by low concentrations of fatty acids or soaps.

*Dr. Gould* commented that this is equally certain in regard to phospholipids and sterols. It is noteworthy that when either fresh or lyophilized plasma is extracted with many organic solvents, practically no lipid is removed. He could not state whether the same is also true for other tissues or organs.

*Dr. Lehninger* stated that the fat droplets in adipose tissue are very large but are coated with a protein, and hence would fall into his rough definition of lipoprotein. He added that the lipoprotein complex may be either intracellular or extracellular.

*Dr. Schmitt* added that the manner in which lipid protein complexes are formed is demonstrated in the formation of the myelin sheath. *Dr. Geren* has shown in the developing embryonic nerve that individual lipid protein layers are formed in the Schwann cell and then aggregate into a myelin sheath as the lipid protein concentration increases. The concentration can be determined either by X-ray diffraction or by electron micros-

copy. In the myelin sheath it is readily identifiable as a lipid-protein complex with an identity period of 180 to 186 Angstroms, indicating that there are two double layers of lipid and at least one layer of protein. He could not predict whether in the lesion of atherosclerosis there would be found layered protein structures or individual proteolipids such as Folch-Pi had been investigating.

*Dr. Duff* pointed out that the lipid in myelin sheath will not stain with Sudan 3 or 4, but that when the sheath degenerates the droplets are stainable. He asked whether the droplets are still combined with protein, or whether they become stainable upon dissociation.

*Dr. Schmitt* replied that although the answer was not yet available, it might be obtained through X-ray studies. Examination by the method of polarization optics reveals positive polarization crosses in the degenerated lipids in the remains of the tube of Schwann, indicating that the lipids are arranged radially in clumps instead of in layers.

*Dr. Anfinsen* commented that apparently lipoproteins that are still biologically useful can be stained, inasmuch as the binding of dyes by plasma lipoproteins does not seem to interfere with their metabolism.

*Dr. Gross* pointed out that there are other lipid complexes in addition to lipoproteins. In the brain, Folch-Pi had described a glycolipid known as strandin, which has a large polysaccharide component. Dr. Surgenor also had evidence of a carbohydrate-combined lipid.

*Dr. Lehninger* was of the opinion that the whole glycolipid is attached to a protein. As to what distinguishes a free lipid from a lipoprotein in tissues, he commented that most investigators assume that if a lipid can be extracted with a fat solvent from a dry tissue, that is evidence that the lipid exists in the tissue in free form. He pointed out, however, that lipoproteins are extremely fragile and very susceptible to freezing and to the action of organic solvents under certain conditions. Accordingly, he considered that the more fragile lipoproteins may undergo dissociation under drying, extraction with fat solvents, and staining with Sudan 3 and 4.

*Dr. Schmitt* stated that the finding of a Maltese cross upon examination of a droplet of fat by polarization microscopy is not necessarily indicative of a cholesterol ester, but might represent proteins. He and Johnson had described spheroids in certain plant cells that are protein rather than fat. A positive cross merely indicates that the axes of the molecules are radially arranged.

*Dr. Gould*, although agreeing that there is probably always some protein in association with a lipid, felt that it is useful to make a distinction between "free lipids", which are visible by standard fat staining methods, and "lipoprotein lipids", which are not. Free lipids, including those in fat depots and fatty livers, and chylomicrons consist primarily of triglycerides, with relatively small and inconstant proportions of cholesterol, phospholipids, and protein; lipoprotein lipids, such as those in normal plasma and liver, consist to a much greater extent of cholesterol and phospholipids, and are considered to have a more nearly constant composition. The former, being essentially emulsified fat, are directly extractable by solvents like ether, but the latter only after denaturation of the lipoprotein by treatment with alcohol, heating, or drying.

*Dr. Page* asked whether the building-up of lipoproteins is a matter of bond strength, whether it is always mediated by enzymatic action, or whether it is a result of other methods of breakdown of fat such as the constant degradation described by Gofman.

*Dr. Lehninger* was of the opinion that ultimately in cellular metabolism the lipoproteins fed into a cell must be split up and must yield free fatty acid as fuel for the mitochondria. He visualized it as a relatively constant and extensive process: the synthesis of lipoproteins from the building blocks, and their constant degradation. Lipids are foodstuffs, and one must assume a relatively massive exchange between the plasma and the cells. Cholesterol is unique in that it is one of the few substances in the animal that are more or less irreversibly synthesized. A side-chain of the cholesterol molecule can be oxidized with the formation of bile acids and hormones, but the other rings of the nucleus do not appear to contribute to respiratory carbon dioxide. The synthesis of cholesterol is therefore irreversible, and it cannot be regarded as a foodstuff.

*Dr. Lansing* asked whether a useful parallel could be drawn between the transport of lipids in a complex lipoprotein in circulation and the transport of insoluble phosphates in tissue fluids and in the circulation, and whether the lipoprotein is enzymatically split at the site of utilization.

*Dr. Lehninger* felt that although a parallelism might exist, it would not necessarily throw light on the role of lipoproteins in atherosclerosis.

## STEROL METABOLISM AND ITS CONTROL

R. GORDON GOULD

One approach to the atherosclerosis problem is the investigation of the basic aspects of sterol and steroid metabolism, particularly from the point of view of the regulation of the plasma cholesterol level, in order to make it possible to obtain a better understanding of the changes in cholesterol metabolism associated with atherosclerotic disease. Too high a plasma cholesterol level maintained for a long period of time is known to be injurious to arterial tissue, regardless of whether the cholesterol is of dietary origin, as in the well-known cholesterol-fed rabbit, or of endogenous origin.

Of special importance to the atherosclerosis problem is the typical middle-aged American male who has a plasma cholesterol level of, let us say,  $250 \pm 50$  mg. %, a considerable amount of atheromatosis, and may or may not ultimately develop a coronary occlusion, depending largely on the particular anatomical distribution of the lesions. Regardless of whether he suffers from too high a dietary intake of cholesterol or from a defective metabolic regulation resulting in too high a plasma level of endogenous cholesterol, a better understanding of cholesterol homeostasis—the mechanism controlling the total cholesterol content of the body, and particularly the plasma level—might lead to methods of lowering the average level to a range closer to that found in population groups that are relatively free of the disease, and this, in turn, might well result in a decrease in the severity of atheromatosis and in the incidence of coronary occlusion.

A review of the fundamental aspects of cholesterol metabolism seems appropriate at this time because of the tremendous growth in our knowledge of this field during the last few years and the intensive work now going on in a number of laboratories.

### *Pathways in Cholesterol Metabolism*

Cholesterol, present in every cell in the body, is partly derived from the diet and partly from synthesis within the body. The amount present in the human dietary is variable, depending to a considerable degree on the consumption of eggs, but is typically in the neighborhood of about half to one gram per day per person. Although not a dietary essential, since the body's capacity to synthesize cholesterol is very high, it is present in many of the most desirable foods including eggs, meat, dairy products, fowl, and fish. Consequently the better the diet according to accepted standards, the higher the cholesterol content is apt to be.

*Absorption of Sterols*—Absorption of dietary cholesterol is very slow and is probably always incomplete. The fraction absorbed is impossible to determine accurately because of the secretion of large amounts of cholesterol into the intestinal lumen by the liver in bile, and by the mucosa of the small intestine and colon. This endogenous cholesterol mixes with that of dietary origin; a fraction is then reabsorbed, and the rest excreted in feces either as such or after conversion to coprosterol, a process which apparently takes place in the colon and requires the presence of phrenosin.

The presence of bile is required for any absorption to take place,<sup>1</sup> and other dietary lipids increase the efficiency of absorption on experimental diets. Under normal conditions probably between half and three quarters of ingested cholesterol is absorbed.<sup>2</sup>

Other sterols present in foods, such as dihydrocholesterol and the plant sterols, stigmasterol and the sitosterols, have long been considered as not being absorbable to any extent by mammals. However, recent studies with isotopically labeled sterols have shown that ergosterol,<sup>3</sup> sitosterol, and dihydrocholesterol<sup>4</sup> are absorbed, though not as efficiently as is cholesterol. The specificity of cholesterol absorption, although not absolute as often stated, is marked, and suggests an enzymatic mechanism.

Perhaps it was the idea that the plant sterols, being structurally closely related to cholesterol, might be able to compete for the enzymes involved in absorption that led Peterson in 1951 to the experiments that demonstrated dramatically the prevention of dietary hypercholesterolemia in chickens fed a 1% cholesterol diet by the addition of sitosterol.<sup>5</sup> Since then it has been found that either dihydrocholesterol or sitosterol will prevent to a striking degree the absorption of excessive amounts of dietary cholesterol in chickens, rabbits, and rats,<sup>6, 7</sup> and will prevent the atherosclerosis that would otherwise develop in the first two species. In experimental animals on normal diets the plasma cholesterol level is not affected by the addition of these sterols to the diet, but there is some recent preliminary evidence that in humans a decrease in plasma level may be produced in perhaps half.<sup>8, 9, 10</sup> The decrease has been stated to be most evident in those patients with the highest levels, suggesting that these agents may find a useful place in prevention and therapy of hypercholesterolemia if this effect can be maintained indefinitely.

During absorption, cholesterol is esterified to the extent of about half;<sup>11</sup> the old belief that it is transported entirely via the lymphatics to the thoracic duct has recently been confirmed by the aid of C<sup>14</sup> cholesterol.<sup>11</sup>

Absorbed cholesterol is discharged from lymph into the systemic circulation in the form of chylomicrons or large aggregates with a  $\alpha$ -S<sub>1.21</sub> of greater than 70, as Page and associates have recently shown.<sup>12</sup> When labeled cholesterol is fed to dogs in small amounts, it can be recovered within 18 hours from many body tissues, including even skeletal muscle. However, it goes primarily to the liver, blood, and spleen, and mixes rapidly and completely with the cholesterol in those tissues. Mixing in other tissues occurs at varying rates and in certain cases, particularly skin and skeletal muscle, may never reach completion. Nervous system cholesterol, constituting at least one-third of the total amount in the body, is inert towards blood cholesterol, and no evidence of exchange of molecules has been presented.

*Rate of Appearance of Dietary Cholesterol in Plasma*—When labeled cholesterol is fed in large or small amounts, the peak concentration of the labeled form in plasma is not reached until one to two days after ingestion.<sup>13, 14</sup> This hold-up in absorption takes place partly in the lumen and partly in the intestine itself, and may be considered to be a part of the homeostatic mechanism; i.e., a slow rate of absorption is of assistance in preventing sudden rises in plasma cholesterol level.

Labeled dietary cholesterol normally appears a little more rapidly in the plasma free fraction than in plasma ester or red cell fractions; after several days all three fractions reach approximately the same specific activity value and thereafter remain almost equal, with the plasma ester usually slightly higher than the free.<sup>15</sup> The rate of decrease of this equilibrium value corresponds to a 50% decrease in 8 days for humans and dogs during a period from about the 6th day through the 20th; this half-time has been considered by most investigators to be the "turnover" half-time. It appears to represent primarily the



rate of metabolism of blood-liver cholesterol by the liver, particularly its oxidation to bile acids, although some decrease in blood cholesterol specific activity due to interchange with the large, relatively inert pools of cholesterol in muscle and skin may well be influencing the rate. It would be of interest to determine more precisely what processes are included in this turnover rate.

A recent report of Biggs and Colman<sup>14</sup> states that a reversal in the relative rates of appearance of labeled cholesterol in the plasma free and total fractions occurs in some patients with an "abnormal lipoprotein spectrum." Although the results reported so far give little indication that the feeding of labeled cholesterol is likely to become a diagnostic method of practical importance, they are of interest since they give us a clue to follow in investigating the little-understood problem of cholesterol esterification. Comparison of the rates of appearance of labeled cholesterol in plasma lipoproteins following intravenous injection with those following ingestion is now being attempted in our laboratory. It is hoped that this will throw some light on the role of intestinal absorption in the above described effect.

No definite answer can be given at present to the important question of where the plasma lipoproteins are formed. Since the liver is the site of synthesis of plasma phospholipids, endogenous plasma cholesterol, and globulins, it would be logical to expect the lipoproteins to be formed in the liver cells and to emerge in the plasma fully formed. Equally possible, however, is the alternative that lipoproteins are formed in plasma, perhaps under the influence of clearing factor by reactions of the general type discussed by Dr. Anfinsen.

*Endogenous Synthesis of Cholesterol*—Synthesis of cholesterol occurs continuously in almost all body tissues, as can be dramatically demonstrated by administering C<sup>14</sup>-labeled acetic acid to an animal; on sacrificing the animal a short time later, C<sup>14</sup> cholesterol will be found in every tissue except the nervous system. It is well established that the isotope can only enter the molecule during its total synthesis from small fragments—there is no exchange of carbon atoms between acetate and cholesterol molecules—and consequently some cholesterol must have been synthesized from acetate during this time.

Under these conditions the specific activity is higher in liver than in any other tissue, illustrating the well-known fact that liver has the fastest rate of cholesterol turnover, but at least in rats a great deal more newly synthesized cholesterol is found outside the liver than in it.

The liver is of primary interest in connection with atherosclerosis since it is the source of plasma cholesterol and also since it has the most variable as well as the fastest rate of synthesis. A variety of different methods have shown that the turnover rates for liver and plasma cholesterol are both about 6 to 8 days for half-turnover in several species, including rat,<sup>16</sup> dog,<sup>17</sup> and man.<sup>18</sup> The rate at which cholesterol molecules move from liver to plasma, however, is not conditioned by the turnover rate of either tissue, but is remarkably much faster. Rates of movement of newly synthesized molecules from liver to plasma and the rates of esterification can be determined by what may be called the "flash" labeling technic. Both acetate and the series of intermediates (largely unknown) in the biosynthesis of cholesterol have extremely short half-turnover times, so that within probably half an hour and certainly one hour after the injection of a few milligrams of C<sup>14</sup> acetate, incorporation of C<sup>14</sup> into cholesterol has been completed. By

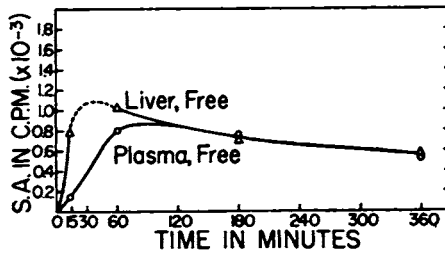

FIG. 1.—The rate of appearance of  $C^{14}$  cholesterol in the liver free and plasma free fractions of the dog, following the injection of  $C^{14}$  acetate in a mesenteric vein. The specific activity of cholesterol is plotted against time.  $\bullet$ .

taking simultaneous samples of liver and blood at various times after the injection of  $C^{14}$  acetate, data such as are shown in figure 1 may be obtained. Proof that the labeled molecules appearing in the plasma free fraction really did originate from liver was obtained in other experiments: for example, in hepatectomized dogs, no labeled cholesterol appeared in plasma.

It is thus apparent that the newly synthesized free cholesterol molecules of liver and plasma mix or interchange with great rapidity, and there is no reason to believe that unlabeled "older" molecules behave any differently. The half-time for the mixing process was estimated as about 20 minutes in dogs, and it can be shown that half of all the free cholesterol in plasma enters the liver every 30 minutes, while an equal amount of liver free cholesterol enters the plasma. No significant changes in the cholesterol concentrations of liver or plasma took place during these experiments. However, it is obvious from the rapidity of interchange that the control of the plasma level is very mobile and that large changes could conceivably take place in a short time. From this standpoint the liver and plasma may be considered as two compartments of a single entity; it is to be expected that they will have the same turnover rate of free cholesterol, as determined either by the rate of build-up of labeled molecules, measured by the Schoenheimer method, or by the rate of die-away subsequent to the attainment of equilibrium.<sup>17</sup> It seems preferable therefore to define this rapid equilibration as "interchange," although there is in the literature a tendency to lump all mixing and metabolic regeneration processes together as "turnover" and even to imply that previous determinations of turnover rate by classical methods were in error because the rapid mixing processes were not detected. Hevesey and his associates, more than 10 years ago, studied the exchange of labeled phospholipids between plasma and tissues.<sup>19</sup> They clearly differentiated this process from "turnover," a term which has long implied the metabolic breakdown and resynthesis of a body constituent.

The rates of appearance of newly synthesized cholesterol in plasma free and ester and red cell fractions of blood are shown in figure 2A for dogs and figure 2B for humans. These experiments were carried out on normal unanesthetized subjects, given acetate orally. It had long been thought that red cell cholesterol was metabolically rather inert, since its level does not change when that in plasma does. The rapid rate of appearance of labeled molecules in red cells was therefore surprising, and indicates that red cell cholesterol is not built into the cell like hemoglobin but is in a highly dissociable state. That the equilibration is directly with plasma free rather than with liver free fraction is suggested by in-vitro studies,<sup>17</sup> in which approximately the same half equilibration time

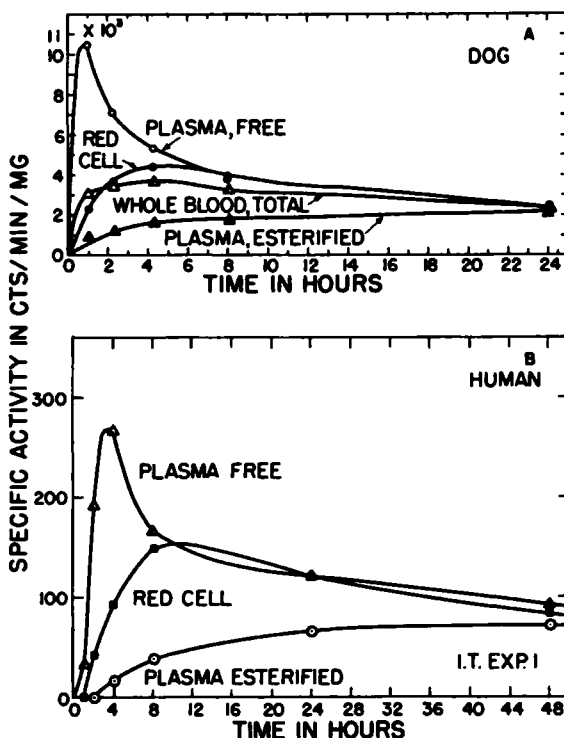

FIG. 2.—The rate of appearance of  $C^{14}$  cholesterol in blood cholesterol fractions following the oral administration of  $C^{14}$  acetate to a dog (A) and a human (B).

of about 1 hour was observed. The reversibility of the interchange was also demonstrated in the in-vitro experiments.

The curves for humans are very similar to those for dogs except that the rates are somewhat slower; plasma free cholesterol reached a peak value at approximately three hours in humans, as compared to about one hour in dogs. From these data it can readily be shown that in a 70-kg. man about 0.6 gram of free cholesterol must be crossing the liver-plasma boundary each hour in each direction.

The fact that cholesterol is so insoluble in water that it can only exist in lipoprotein combination in plasma suggests that the actual differences in concentration across the liver-plasma boundary are related to differences in the concentration of proteins capable of binding cholesterol. The situation may be considered to be analogous to the Donnan membrane equilibrium in which differences in concentration of freely diffusible electrolytes are maintained by the differences in the charged, nondiffusible proteins. If an analogous situation exists here, it might be considered that the plasma cholesterol concentration is regulated to a considerable extent by the  $\alpha_1$  and  $\beta_1$  globulin concentrations.

From the few data available on liver cholesterol esters it appears that this fraction reaches a peak value only about one-third to one-half as high as the free liver fraction, but at about the same time. It then falls more slowly than the free fraction, and eventually reaches the same value within experimental error. Plasma ester fraction approaches the specific activity of plasma free with a half-time of about seven hours, reaching the

same value, within experimental error, between one and two days. This process presumably involves the action of cholesterolesterase.

*Extrahepatic Synthesis*—By means of the in-vitro tissue slice method it has been shown, largely by Chaikoff's group, that many body tissues are capable of cholesterol synthesis.<sup>20</sup> The quantitative importance of each tissue's contribution to the total synthesis in the body can not be reliably estimated from tissue slice results but the "flash labeling" method, properly controlled, should make this possible in intact animals. It is essential that the labeled precursor be distributed uniformly throughout the body. For this reason, C<sup>14</sup> acetate injected intravenously into the peripheral circulation gives a quite different and probably more accurate picture of the relative importance of extrahepatic synthesis than intraperitoneal or oral administration. Even this method has the objection that dilution of labeled acetate by endogenous unlabeled acetate may be different in different tissues. The use of tritium water to label body water uniformly would be expected to provide the most reliable indicator and, because of the high specific activity, it is quite feasible to use a very short time period with this method. In a recent report from Frantz's group the tritium water method over a 24-hour period gave somewhat different results than the C<sup>14</sup> acetate method in comparative studies on hepatic synthesis, but the reasons for the discrepancy are not clear.<sup>21</sup>

Results presently available indicate that in rats almost three times as much cholesterol is synthesized by extrahepatic tissues as by liver. For example, in a rat injected subcutaneously with C<sup>14</sup> acetate and sacrificed one hour later, the C<sup>14</sup> cholesterol was distributed as follows: liver, 27%; small intestine, 22%; large intestine, 1.6%; skin, 20%; and the remainder of the carcass, 20.4%.<sup>22</sup> In dogs, on the other hand, there appears to be considerably less cholesterol synthesis in extrahepatic tissues, particularly intestine and skin. The few data obtained up to the present on humans only permit the statement that extrahepatic synthesis does occur in adrenals and in tumor metastases.<sup>23</sup>

*Cholesterol Synthesis in Aorta*—It has recently been suggested that synthesis of cholesterol in the aorta itself may be of significance in the development of atherosclerosis.<sup>24</sup> This is based on the demonstration of the ability of aorta tissue from chickens and rabbits to incorporate C<sup>14</sup> acetate in cholesterol in vitro. The specific activity ratios of liver cholesterol to aorta averaged 500 to 1 for rabbits and 39 to 1 for chickens. We have recently confirmed this in chickens by in-vivo methods, using a half-hour experimental period to rule out transport from liver, but have been able to find no evidence of synthesis in rat aorta by the same method.<sup>22</sup> Several years ago we were unable to detect any in dog aorta slices in vitro. This species difference makes it unsafe to assume that the human aorta can synthesize cholesterol, in spite of the similarities between chickens and humans that Dr. Katz has pointed out. Moreover, there is so much evidence indicating that the cholesterol deposited in the artery walls in atherosclerosis is derived from plasma that it seems unlikely that cholesterol synthesis in the aorta is of importance in this disease.

*Interrelations of Plasma and Tissue Cholesterol*—It has already been mentioned that exogenous cholesterol mixes completely with endogenous blood and liver cholesterol. The question arises, does that synthesized in the cells of extrahepatic tissues also mix freely with blood-liver cholesterol? Two methods have been used to investigate this question: in one, blood containing C<sup>14</sup> cholesterol in normal lipoprotein form (obtained from a donor animal given C<sup>14</sup> acetate) was injected into a normal recipient. Recipient

animals were sacrificed at intervals from 4 hours to 2 weeks, perfused, and the degree of equilibration of blood and tissue cholesterol determined. In dogs, liver and spleen gave equilibration half-times of about 4 to 8 hours, most other viscera including heart, lung, kidney, intestine, and diaphragm of about 1 day, aorta about 3 days, skin 8 to 10 days, and the nervous system showed no equilibration.<sup>26</sup> Very similar results were obtained by feeding tritium cholesterol at such a rate as to maintain a constant specific activity in blood (see table I).<sup>26</sup> As in the other tracer studies previously described, there were no significant changes in the cholesterol level of the blood or tissues during these experiments, but only changes in the identity of the molecules. It cannot be said with certainty whether the appearance of blood cholesterol in the tissues is due to interchange or to the replacement of molecules broken down by metabolic processes in the tissues. In dogs, at least, the rapidity of the equilibration in the viscera suggests that the former possibility is the more likely.

In rats fed a diet containing a constant level of 0.5% of tritium cholesterol, equilibration of most tissues was much slower and only partially complete even after 8 weeks of feeding.<sup>26</sup> This finding is in accord with the studies on extrahepatic synthesis in pointing to a considerably greater dependence on synthesis in tissue cells and a considerably less dependence on, or interchange with, blood cholesterol in rats than in dogs. In humans fed tritium cholesterol for a week equilibration between blood and certain tissues appeared quite rapid, more like dogs than rats.<sup>28</sup>

*Intermediates in Sterol Synthesis*—The last few years have seen a great outburst of important advances in the field of acetate metabolism and lipid synthesis, due to the work of many investigators. Outstanding are the contributions of Lipman, Lynen, Lehninger, Bloch, and their collaborators. In brief, the principal, and probably the only, building block in lipid synthesis is acetyl coenzyme A (acetyl CoA), which is a high energy form of acetate, already discussed by Dr. Lehninger. Acetyl CoA is formed from its constituents either by means of energy supplied by ATP or directly with energy from metabolic oxidative processes. The bond has approximately the same energy content as that in ATP but it is unique in that the methyl group of acetate is activated so that it can readily take part in condensation reactions.<sup>27</sup> Two molecules of acetyl CoA combine to form acetoacetyl CoA plus free CoA. At this point, fatty acid synthesis, sterol synthesis,

TABLE I  
EQUILIBRATION OF DIETARY AND TISSUE CHOLESTEROL. SPECIFIC ACTIVITY OF TISSUE CHOLESTEROL IN PERCENTAGE OF LIVER VALUE AFTER VARYING PERIODS OF TRITIUM-CHOLESTEROL FEEDING

	Dogs		Rats		
	12 days	17 days	2 weeks	4 weeks	8 weeks
Liver.....	100	100			
Blood.....	97	106	100*	100*	100*
Intestine.....	93	94	150	107	86
Heart, lung, kidney, spleen.....	93	93	55	58	71
Skeletal muscle.....	75	77	65	52	57
Skin.....	57	65	39	29	25
Aorta.....	61	71	—	—	—

\* In rats, the combined liver and blood value was taken as 100%.

and ketone body formation diverge. Fatty acid synthesis proceeds by reduction of acetoacetyl CoA (in several steps) to form butyryl CoA; the stepwise addition of acetyl CoA followed by reduction of the ketone group increases the chain length by two carbons to give higher fatty acids.

Acetoacetyl CoA may also be converted into acetoacetic acid by the action of a specific deacylase, or it may be used for sterol synthesis. The latter can only be partly sketched in at present, but rapid progress may be expected in the near future. Acetyl CoA may condense with the carbonyl of acetoacetic acid (or possibly some derivative such as acetoacetyl CoA or a high energy decarboxylation product) to give, after decarboxylation and dehydration, a five-carbon chain compound. This has not been definitely identified as yet, but it may be permissible to speculate that it might be beta methyl crotonyl CoA,  $\text{CH}_3\text{-C} = \text{CH-CO-S-CoA}$ .



Bloch<sup>29</sup> had previously shown that addition of pyruvate to liver slices increased the utilization of acetate carbons for fatty acid synthesis and decreased their utilization for cholesterol synthesis. This can now be explained on the basis that pyruvate acts by reducing acetoacetyl CoA and thus diverting the available acetate from sterol to fatty acid synthesis. Note that no reduction is involved in the first steps of this postulated scheme of sterol synthesis, in contrast to the first steps of fatty acid synthesis. These synthetic schemes offer a fertile field for speculation and the planning of experiments concerning the relationships of carbohydrate and lipid metabolism.

There is a growing conviction that the great array of isoprenoid compounds in nature—carotenoid pigments, vitamin A, terpenes, essential oils and rubber—as well as the plant and animal sterols are all formed from acetate via a five-carbon unit, similar to if not identical with  $\beta$  methyl crotonyl CoA.<sup>28</sup>

These units may be built up into chains by head-to-tail condensation (since the CoA linkage would be expected to activate the terminal methyl groups), or possibly by successive additions of acetyl CoA units, with a decarboxylation accompanying every third addition. In mammalian tissues, the next intermediate known is squalene, a 30-carbon, open-chain hydrocarbon. It has a center of symmetry, suggesting that it is formed from two 15-carbon units by head-to-head condensation. It is found in small concentration in human sebum, liver, and various other tissues; Bloch and his associates<sup>28</sup> have recently found evidence suggesting strongly, but not proving definitely, that it is an intermediate in sterol synthesis, and have established with considerable certainty the manner in which it is folded and cyclized to give the steroid skeleton. Three methyl groups are eliminated, so that 15 of the sterol carbons are derived from acetate methyl groups. Of the 18 acetate carboxyls, 6 had been lost during the formation of squalene, so 12 sterol carbons are derived from acetate carboxyls. This ratio of 15:12 is in perfect agreement with Bloch's experimental results of several years ago.<sup>30</sup> Furthermore, 19 carbons have been separately isolated by degradative procedures by Bloch and by Popjak,<sup>32</sup> and their origin determined by means of  $\text{C}^{14}$  tracer methods. In every case the results were in complete agreement with Bloch's scheme.

It is now apparent that during biosynthesis intermediates are formed which are probably sterols, closely related to cholesterol. They can be detected by perfusion of an isolated organ with  $\text{C}^{14}$  acetate<sup>31</sup> but are specially in evidence when an animal is in-

jected with  $C^{14}$  acetate and killed three minutes later. In the latter case only 20% of the specific activity of the liver sterol precipitable with digitonin is really due to cholesterol, as shown by exhaustive purification procedures.<sup>32</sup> The contaminants have not been identified but might include  $\Delta^7$ -cholestenol, which is known to be present in all samples of cholesterol,<sup>33</sup> or 7-dehydrocholesterol. These intermediates are present in very small amounts and consequently must have rapid turnover rates. Although in most tracer investigations the cholesterol isolated is contaminated by the presence of these materials, the evidence indicates that no significant error is involved unless the reaction time is extremely short. Purification through the dibromide eliminates most of the contaminants.

Both  $\Delta^7$ -cholestenol and 7-dehydrocholesterol have been definitely shown to be precursors of cholesterol.<sup>28</sup> The latter is, in addition, formed from cholesterol,<sup>34</sup> showing this conversion to be a reversible reaction. Dihydrocholesterol is primarily an end-product of cholesterol metabolism, but even in this case its formation appears to be reversible, since labeled dihydrocholesterol, when fed, appears in small amounts in the liver as labeled cholesterol.<sup>4</sup>

*Catabolism of Sterols*—The catabolic pathways of blood-liver cholesterol include fecal excretion of the two saturated derivatives, dihydrocholesterol and coprosterol, and of cholesterol itself; conversion into steroid hormones; and conversion into bile acids in the liver. Chaikoff's group has recently shown that this last is by far the most important pathway quantitatively in the rat and appears to account for most of the cholesterol metabolized.

When cholesterol labeled with  $C^{14}$  at the end of the side chain is injected into rats,  $C^{14}$  appears in respiratory  $CO_2$  promptly and in a considerable fraction of the dose. When labeled in ring A, at  $C_4$ , no  $C^{14}O_2$  was detectable, which indicates that complete oxidation of the ring system occurs either not at all or at a very slow rate. About 50% of the isotope is recoverable from bile in 60–70 hours, three-fourths in the form of bile acids and the remainder as sterols. Both fractions are reabsorbed, the bile acids by the portal vein directly to the liver, where they are re-excreted almost quantitatively. The cholesterol is absorbed less efficiently and by way of the lymphatics.<sup>35</sup>

The metabolic fate of the cholesterol in muscle and skin is not known. It can be shown to be synthesized in the tissues and to be broken down there also, but the metabolic end products are unknown.

The total amount of cholesterol converted into steroid hormones is no doubt a small fraction of that following other pathways. There is no question that both dietary and blood-liver cholesterol can be utilized for the synthesis of steroid hormones, but direct synthesis of hormones from small fragments has not been excluded.

#### *The Control of Sterol Metabolism*

It is self-evident that the concentration of cholesterol and other sterols is normally under homeostatic control, not only in the body as a whole, but in each tissue individually. The observation that the cholesterol content of the aorta increases tenfold in the population as a whole from 25 to 70 years of age<sup>36</sup> indicates that in our species this homeostatic control does not operate perfectly. The increase was very largely a manifestation of atherosclerosis, since in "smooth" aortas it was only twofold. This is of course merely another way of stating that the average human does develop athero-

sclerosis and that it becomes progressively more advanced with age. Increases in cholesterol in other tissues are undoubtedly not as conspicuous as in arteries if, indeed, they occur at all.

It might be argued that the accumulation of cholesterol in arteries is like the accumulation of moderate amounts of adipose tissue in most individuals, merely a common, if not inevitable, result of aging; but while an increase in fat content occurs with age in rats, dogs, and many species when access to sufficient food is allowed, in no other mammalian species does the cholesterol content increase. High fat diets have been demonstrated to increase the plasma cholesterol level in experimental animals, but not to the extent of producing atheromatosis. With the admission that the key problem in the control of cholesterol metabolism cannot be answered, let us turn to what is known.

When a high cholesterol diet is fed, information is obtained entirely different in nature to that discussed above for tracer amounts of labeled cholesterol. Ridout, Best, *et al.*<sup>37</sup> have recently shown that a definite increase in liver cholesterol ester occurs in rats after three weeks of feeding a diet containing 0.16% cholesterol. Choline has no effect on this abnormal accumulation, although a complete absence of choline from the diet will in itself cause an increase.

Since a 2,500-calorie diet containing 1 gram of cholesterol has almost the same concentration on a dry-weight basis (0.15%) as the diet used to produce abnormal accumulations in liver ester in rats, it would be most interesting to know if the cholesterol ester fraction in human liver varies with the diet in the same way. This fraction appears to be the most sensitive indicator of an increased amount of cholesterol in the body, but is unfortunately much less convenient to measure than the plasma level.

*Regulation of the Plasma Cholesterol Level*—The plasma level is definitely not regulated by the balance between absorption from the intestine and deposition in tissues, as is probably the case for chylomicrons. It is regulated by the liver by a number of mechanisms which may be classified into two types, those affecting the distribution between liver and plasma, and those affecting the total content of the liver-blood system.

When cholesterol is fed the first changes are a slight increase in liver free, a much larger increase in liver ester concentration, and simultaneously a marked decrease in synthetic rate, as measured by the incorporation of C<sup>14</sup> acetate into cholesterol either in vitro or in vivo.<sup>38</sup> This inhibitory effect has been observed in a number of laboratories, and is restricted to the liver. It is presumably actuated by the increase in liver cholesterol concentration, and Frantz has suggested that the log of the synthetic rate is inversely proportional to the total cholesterol concentration.<sup>39</sup> While our results are in agreement with this idea, it would seem more logically satisfying to find a relationship with either the free or the ester form rather than the total. The recently reported separation of free and ester by fractional centrifugation of liver homogenates<sup>40</sup> shows that they must be present in different types of lipoproteins in the cell and suggests that their metabolic roles are different, in agreement with the conclusions of the isotope studies discussed above.

Figure 3 shows the results of an experiment in which rats fed a 2% cholesterol diet for two days, and controls, were injected with C<sup>14</sup> acetate. The synthetic rate for free liver cholesterol, which is almost identical with that for total, is plotted against both ester and free cholesterol concentrations. One is tempted to consider the latter as the controlling factor, since it makes mathematical formulation of the reaction kinetics



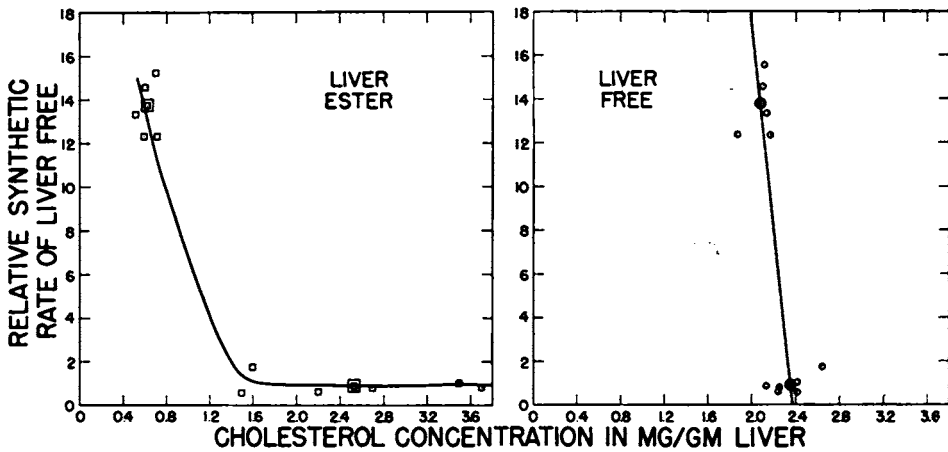

FIG. 3.—The relative synthetic rate of synthesis of liver free cholesterol expressed as a function of liver cholesterol ester concentration (left) and liver free concentration (right).

much simpler. If this is the case the rate is extremely sensitive to changes in concentration, since in these particular experiments an increase in liver free concentration of less than 0.1 mg. per gram of liver decreased the synthetic rate by one half. If the ester concentration is the controlling factor, it appears that a two- to threefold increase decreases the synthetic rate to about 5 to 10% of the control value, but that further increases in ester concentration have relatively little effect. More data are needed to settle this question.

When a high cholesterol diet is fed for longer periods of time, the liver ester fraction continues to function as a storage depot for the excess cholesterol, but eventually liver free and plasma concentrations will also rise. In a recent study<sup>37</sup> rats fed a 1.6% cholesterol diet for three weeks exhibited increases in the liver esterified cholesterol from 3.2 mg. per rat to 127 (a 4,000% increase), and in the liver free from 9.6 mg. to 14.7 (a 53% increase). It is significant that the ratio of free to ester in plasma changes very little if at all over a large range of total cholesterol levels, whereas the ratio in liver changes strikingly as the concentration rises, no matter what the cause. A fat-free diet in rats produces a drop in plasma levels but an increase in liver, particularly in the ester fraction as Alfin-Slater, Deuel, and their associates have shown. It seems clear that there is no relationship between the esterification of cholesterol in liver and that in plasma.

All of these defensive measures combined do not prevent the usual type of high cholesterol experimental diet from resulting in hypercholesterolemia. However, as Dr. Keys has pointed out, these diets contain a far higher cholesterol concentration than any human diet, and more studies concerned with the effects on lipid metabolism of 0.1 to 0.2% cholesterol diets would be of interest.

It seems probable that an increase in liver cholesterol concentration from any cause would inhibit hepatic cholesterol synthesis in the manner described above. One may speculate that one of the basic mechanisms in plasma cholesterol homeostasis is the rapid equilibration of free cholesterol molecules between plasma and liver together with a variable rate of synthesis in liver, which is dependent on the concentration present and is capable of compensating for moderate changes in either direction. Although a

possible starting point, this hypothesis does not take us very far, because it is clear that marked changes in distribution between plasma and liver do occur which may result in hypercholesterolemia without increase in liver concentration.

*Thyroid Function*—Hypothyroidism in experimental animals is associated with hypercholesterolemia but a normal or slightly elevated liver concentration, a somewhat decreased rate of cholesterol synthesis in liver, a decreased rate of turnover in plasma, and a decreased rate of excretion of cholesterol in bile. While at first glance it appears paradoxical that a decreased synthetic rate is associated with an increased plasma level, it is reasonable that hypothyroidism should result in a decrease in the rate of utilization of cholesterol. This might result in an increase in plasma level, which in turn would be expected to depress the rate of hepatic synthesis. There may, of course, be a more direct relationship between the rate of synthesis in liver and the thyroid status as well. However, the hypercholesterolemia appears to be due primarily to a change in the distribution between liver and plasma.

Friedman and his associates have shown that the rate of excretion of cholesterol in bile is considerably decreased when the liver is severely damaged by liver poisons such as carbon tetrachloride, by partial hepatectomy, and in hypothyroidism.<sup>41</sup> Since there is also a decreased rate of synthesis under all these conditions, they propose the use of this rate of excretion as a measure of hepatic cholesterol synthesis in general. However, much more drastic changes in rate of synthesis occur as a result of feeding cholesterol than as a result of hypo- or hyperthyroidism, but with no significant changes in bile cholesterol excretion. The rate of biliary cholesterol excretion would seem to be more an indicator of thyroid function, and of the rate of metabolic activity of liver in general, than specifically of cholesterol synthesis.

*Cholic Acid*—Friedman and his associates, in the course of an intensive investigation of the relation of bile to cholesterol metabolism, have found that cholic acid is a powerful stimulant in the production of hypercholesterolemia.<sup>42</sup> Ligation of the bile duct in rats results in the rapid development of hypercholesterolemia and, as Frantz *et al.* have recently shown,<sup>43</sup> in a tremendous increase in the rate of hepatic cholesterol synthesis. Cholate concentration may well play a role in the regulation of the rate of synthesis under normal conditions as well.

*Pituitary Function*—Although hypopituitarism is not associated with any marked changes in plasma level, it has recently been shown that hypophysectomy in rats decreases the rate of hepatic synthesis, both by the liver slice technic<sup>44</sup> and in the living animal.<sup>22</sup> There is no obvious explanation why hypophysectomy does not produce hypercholesterolemia, since hypothyroidism is such a conspicuous part of this syndrome.

*Surface-active Agents*—Tween and Triton, two nonionic detergents, both produce rapid and large increases in plasma cholesterol as well as other types of lipids. An injection of 50 mg. of Triton will quadruple the cholesterol level in rats in 24 hours. No significant changes in other tissues have been observed, even in liver, but by means of the tracer technic an increase in hepatic synthesis has been demonstrated which can probably account for the increased amount in plasma.<sup>45</sup> It may be postulated that these agents act by changing the distribution of cholesterol between liver and plasma, decreasing liver concentration and thus stimulating liver synthesis. The similarity in chemical properties between these detergents and the bile acids suggests the possibility

that the effects may be related. Both increase levels of all plasma lipids, not just cholesterol.

*Diabetes*—The plasma cholesterol level rises in uncontrolled diabetes in humans, but not to as great an extent as does neutral fat. It has been reported that patients well controlled by insulin and diet do not exhibit higher levels than "normals." Nevertheless, arteriosclerotic disease has become the chief cause of death in diabetics, accounting for 75% of all deaths in a recent report from the Joslin Clinic.<sup>46</sup> The hypercholesterolemia in diabetes, like that in nephrosis, is a panhyperlipemia. Little can be said at present about this derangement in lipid metabolism, but it constitutes an important and challenging problem.

*Liver Damage*—In severe liver insufficiency such as acute atrophy the plasma level falls, no doubt because liver synthesis is hindered; however, there is evidence that slight liver damage actually increases cholesterol synthesis. A period of anoxia in the isolated perfused liver gives considerably more incorporation of C<sup>14</sup> acetate into cholesterol;<sup>31</sup> this result is in agreement with observations that liver slices and homogenates often indicate a faster rate of cholesterol synthesis than is compatible with the known rate of turnover of liver cholesterol.

*X-Irradiation*—Preliminary results indicate that 2,500 r of whole body X-ray irradiation in rats increases the rate of cholesterol synthesis in liver by a factor of about 5 without affecting the rate in other tissues.<sup>47</sup> Whether this is due to liver damage or is a response to radiation damage in other tissues has not been determined.

*Dietary Fat*—Dr. Keys has presented very convincing evidence that the neutral fat content of the diet has a very important effect on the plasma cholesterol level.<sup>48</sup> Virtually nothing is known about the mechanism of this effect, and a more intensive investigation of how it is produced is one of the most pressing problems in cholesterol metabolism and atherosclerosis at the present time.

#### REFERENCES

1. Siperstein, M. D., Chaikoff, I. L., and Reinhardt, W. O.: C<sup>14</sup>-Cholesterol. V. Obligatory function of bile in intestinal absorption of cholesterol, *J. Biol. Chem.* 198: 111, 1952.
2. Cook, R. P., and Thomson, R. O.: The absorption of fat and of cholesterol in the rat, guinea pig and rabbit, *Quart. J. Exper. Physiol.* 36: 61, 1951.
3. Hanahan, D. J., and Wakil, S. J.: Studies on absorption and metabolism of ergosterol-C<sup>14</sup>, *Arch. Biochem.* 44: 150, 1953.
4. Gould, R. G: Absorbability of dihydrocholesterol and sitosterol, *Circulation*, 10: 589, 1954.
5. Peterson, D. W.: Effect of soybean sterols in the diet on plasma and liver cholesterol in chicks, *Proc. Soc. Exper. Biol. & Med.* 78: 143, 1951.
6. Nichols, C. W., Siperstein, M. D., and Chaikoff, I. L.: Effect of dihydrocholesterol administration on plasma cholesterol and atherosclerosis in the rabbit, *Proc. Soc. Exper. Biol. & Med.* 83: 756, 1953.
7. Hernandez, H. H., Peterson, D. W., Chaikoff, I. L., and Dauben, W. G.: Absorption of cholesterol-4-C<sup>14</sup> in rats fed mixed soybean sterols and beta sitosterol, *Proc. Soc. Exper. Biol. & Med.* 83: 498, 1953.
8. Pollak, O. J.: Prevention of hypercholesterolemia in the rabbit: successful prevention of cholesterol atherosclerosis. Reduction of blood cholesterol in man, *Circulation* 6: 459, 1952.
9. Shipley, R. E., and Dennison, A. D., Jr.: Agents modifying atherosclerotic lesions, *Proc. Medicinal Chem. Symp., Amer. Chem. Soc.*, in press.
10. Conrad, L. L., and Furman, R. H.: Observations on the serum lipid and lipoprotein patterns following the administration of sitosterol to normal subjects and patients with hypercholesterolemic

- nephrosis and primary xanthomatous biliary cirrhosis, Clin. Res. Proc., Amer. Fed. Clin. Res., in press.
11. Chaikoff, I. L., Bloom, B., Siperstein, M. D., Kiyasu, J. Y., Reinhardt, W. O., Dauben, W. G., and Eastham, J. F.:  $C^{14}$ -Cholesterol. I. Lymphatic transport of absorbed cholesterol- $4-C^{14}$ , J. Biol. Chem. *194*: 407, 1952.
  12. Page, I. H., Lewis, L. A., and Phahl, G.: The lipoprotein composition of dog lymph, Circulation Res. *1*: 87, 1953.
  13. Warner, I.: Rate of appearance of dietary cholesterol in blood, Fed. Proc. *11*: 306, 1952.
  14. Biggs, M. W., and Colman, D.: A quantitative metabolic defect in lipid metabolism associated with abnormal serum lipoproteins in man, Circulation *3*: 393, 1953.
  15. Hellman, L., Rosenfeld, R., Gallagher, T. F., Adlersberg, D., and Wang, C. I.: Metabolism of cholesterol- $4-C^{14}$  in hypercholesterolemia, Circulation *8*: 434, 1953.
  16. Pihl, A., Bloch, K., and Anker, H. S.: The rates of synthesis of fatty acids and cholesterol in the adult rat studied with the aid of labeled acetic acid, J. Biol. Chem. *183*: 441, 1950.
  17. Gould, R. G.: Lipid metabolism and atherosclerosis, Am. J. Med. *11*: 209, 1951.
  18. London, I., and Rittenberg, D.: Deuterium studies in normal man. I. The rate of synthesis of serum cholesterol, J. Biol. Chem. *184*: 687, 1950.
  19. Hahn, P., and Hevesy, G.: Phosphatide exchange between plasma and organs, Nature *144*: 205, 1939.
  20. Srere, P. A., Chaikoff, I. L., Treitman, S. S., and Burstein, L. S.: The extrahepatic synthesis of cholesterol, J. Biol. Chem. *182*: 629, 1950.
  21. Frederickson, D. S., Loud, A. V., Hinkelman, B. T., Schneider, H. S., and Frantz, I. D.: The effect of ligation of the common bile duct on cholesterol synthesis in the rat, J. Exper. Med. *99*: 43, 1954.
  22. Gould, R. G.: unpublished data.
  23. LeRoy, G. V., Bergenstal, D., Okita, G., Gould, R. G., Keegan, P., and Werbin, H.: to be published.
  24. Siperstein, M. D., Chaikoff, I. L., and Chernick, S. S.: Significance of endogenous cholesterol in arteriosclerosis: synthesis in arterial tissue, Science *113*: 747, 1951.
  25. Gould, R. G.: Factors controlling cholesterol synthesis in the body, Proc. Ann. Meeting, Council for High Blood Pressure Research, 1952.
  26. Campbell, D. J., Taylor, C. B., Kelly, F. B., Jr., Hagerman, J. S., Kohr, K. C., and Gould, R. G.: Cholesterol metabolism IV. Interrelations of blood and tissue cholesterol, to be published.
  27. Lynen, F.: Acetylcoenzyme A and the "fatty acid cycle", in The Harvey Lectures, 1952-53, New York, Academic Press, 1954.
  28. Bloch, K.: Biological synthesis of cholesterol, in The Harvey Lectures, 1952-53, New York, Academic Press, 1954.
  29. Bloch, K.: The biological synthesis of lipids. In Cold Spring Harbor Symposia on Quantitative Biology, 1948, vol. 13, p. 29.
  30. Cornforth, J. W., Hunter, G. D., and Popjak, G.: Studies of cholesterol biosynthesis. I. A new chemical degradation of cholesterol, Biochem. J. *54*: 590, 1953.
  31. Schwenk, E., and Werthessen, N. T.: Studies on the biosynthesis of cholesterol. III. Purification of  $C^{14}$ -cholesterol from perfusions of liver and other organs, Arch. Biochem. *40*: 334, 1952.
  32. Dayton, S., Mosbach, E. H., and Kendall, F. E.: Observations on the nature of radioactive contaminants in biosynthetic cholesterol- $C^{14}$ , Proc. Soc. Exper. Biol. & Med. *84*: 609, 1953.
  33. Fieser, L. F.: A companion of cholesterol, J. Am. Chem. Soc. *73*: 5007, 1951.
  34. Scott, M., Glover, J., and Morton, R. A.: Conversion of cholesterol to provitamin D<sub>3</sub> *in vivo*, Nature *163*: 530, 1949.
  35. Siperstein, M. D., Hernandez, H. H., and Chaikoff, I. L.: Enterohepatic circulation of carbon 4 of cholesterol, Am. J. Physiol. *171*: 297, 1952.
  36. Rosenthal, S. R.: Studies in atherosclerosis, chemical, experimental and morphologic, Arch. Path. *18*: 473 and 660, 1934.
  37. Ridout, J. H., Lucas, C. C., Patterson, J. M., and Best, C. H.: The effect of varying amounts of dietary cholesterol and of choline upon liver lipids, Biochem. J. *52*: 79, 1952.
  38. Taylor, C. B., Eckles, N. E., Hagerman, J. S., Campbell, D. J., Keegan, P., and Gould, R. G.: Cholesterol Metabolism. II. The influence of dietary cholesterol on *in vivo* cholesterol synthesis, to be published.

39. Frantz, I. D., Schneider, H. S., Hinkelman, B. T.: Relationships between the levels of dietary liver and serum cholesterol and hepatic cholesterol synthesis, *Circulation* 6: 467, 1952.
40. Schotz, M. C., Rice, L. I., and Alfin-Slater, R. B.: Further studies on cholesterol in liver cell fractions of normal and cholesterol-fed rats, *J. Biol. Chem.* 204: 19, 1953.
41. Byers, S. O., and Friedman, M.: Production and excretion of cholesterol in mammals. VII. Biliary cholesterol: increment and indicator of hepatic synthesis of cholesterol, *Am. J. Physiol.* 168: 297, 1952.
42. Friedman, M., and Byers, S. O.: Production and excretion of cholesterol in mammals. VI. Bile acid accumulation in production of hypercholesterolemia occurring after biliary obstruction, *Am. J. Physiol.* 168: 292, 1952.
43. Frederickson, D. S., Loud, A. F., Hinkelman, B. T., Schneider, H. S., and Frantz, I. D., Jr.: The effect of ligation of the common bile duct on cholesterol synthesis in the rat, *J. Exper. Med.* 99: 43, 1954.
44. Tomkins, G. M., Chaikoff, I. L., and Bennett, L. L.: Cholesterol synthesis by liver. II. Effect of hypophysectomy, *J. Biol. Chem.* 199: 543, 1952.
45. Frantz, I. D., Jr., and Hinkelman, B. T.: Effect of triton WR-1339 on cholesterol synthesis in the rat, *Fed. Proc.* 13: 211, 1954.
46. Warren, S.: An interpretation of diabetes in the light of its pathology. *Diabetes* 2: 257, 1953.
47. Gould, R. G., Keegan, P., and Van Riper, J.: unpublished results.
48. Keys, A.: The cholesterol problem. In *Proceedings of the International Congresses on Dietetics and on Diabetes*, Amsterdam, 1952.

## DISCUSSION

*Dr. Page* asked whether, when dihydrocholesterol and sitosterol are fed but not absorbed, the endogenous synthesis is markedly increased.

*Dr. Gould* stated he did not know of any reported results bearing on the effect, if any, of dietary dihydrocholesterol or sitosterol on the rate of endogenous cholesterol synthesis. However, he had found by the tracer technique that both these sterols are absorbed when fed, although to a smaller extent than cholesterol. Dihydrocholesterol is apparently converted into cholesterol during or after absorption, since the labeled liver sterols from rats fed C<sup>14</sup>-dihydrocholesterol did not lose the label on purification through the dibromide. Hanahan had reported recently that C<sup>14</sup>-ergosterol is absorbed by rats, converted into an unidentified compound, and excreted in bile. Tritium-labeled beta sitosterol, when fed to rats in single 10-mg. doses, was absorbed about one quarter as completely as similar doses of cholesterol. Its distribution in various tissues, including blood, liver, intestine, skin, and residual carcass, was similar to that of labeled dietary cholesterol. Beta sitosterol is also absorbed to a slight extent by humans, as shown by the recovery of tritium-labeled sterol from blood. The possibility that these sterols may have a direct effect on cholesterol metabolism in the liver should be considered.

*Dr. Lehninger* posed the question of the biological function of cholesterol in the mammalian organism. He noted that it is a precursor of the bile acids or steroid hormones and is made at a rapid rate in virtually every tissue, but is not a foodstuff.

*Dr. Gould* commented that too much emphasis is usually placed on the role of plasma lipoproteins in lipid transport, and too little on their role as structural components of plasma. It can safely be assumed that the presence of alpha and beta lipoproteins in definite concentration ranges is as important to the integrity of plasma as the presence of a definite concentration of albumin.

*Dr. Anfinson* suggested that cholesterol may provide proper van der Waals and hy-

drogen bonding centers in the evolution of protein molecules which have specific functions in the transportation of triglycerides and phospholipids, and that cholesterol may be merely incidental to the transport.

*Dr. Schmitt* commented that biochemists are chiefly interested in substances that furnish energy or that can be synthesized. Cell structure, however, must be maintained, and the steroid provides van der Waals forces that hold the lipids in the paraffin chains of other lipids in two-dimensional layers. As *Dr. Lehninger* had pointed out, that is one way of binding proteins.

*Dr. Lehninger*, in response to the comment of *Dr. Anfinsen* that the products of cholesterol metabolism are mainly bile acids, pointed out that the latter facilitate the re-absorption of cholesterol.

*Lt. Batchelor* suggested that a model for steroid hormone action might be sought in the known selective absorption of steroids from the gut, and particularly in its sensitivity to slight changes in configuration of the molecule.

*Dr. Eder* commented that hyperlipoproteinemia may be a more precise term than hypercholesterolemia. This term would carry with it the connotation that all the constituents of the lipoprotein increase, including cholesterol, phospholipid, and protein.

## NUTRITION AND ATHEROSCLEROSIS

GEORGE V. MANN AND FREDRICK J. STARE

According to our definition, nutrition is the science of food and the ingredients of food known as nutrients, their relations and interrelations to health and disease. In the present stage of medical development in the United States, with diseases due to poor sanitation and infectious agents increasingly well controlled, nutrition is the single most important environmental factor affecting the health of the American people. This may at first seem a paradox in such a well-fed country. But reference to tabulations of causes of death and morbidity will show that our particular affliction is arteriosclerosis, and this family of diseases can be shown to be related to diet. The relationships will be summarized here.

It is convenient for the present purpose to discuss three kinds of evidence which relate diet to the etiology of atherosclerosis. These categories represent the fundamental investigative approaches to this or any such problem. The kinds of evidence are epidemiological, clinical and laboratory.

Many of the epidemiological data have been considered in the paper of Drs. Keys and Anderson. There are a number of points made by Keys and Anderson with which we disagree. In summary these are as follows:

1. Those authors state that "if the lowest effective level for cholesterol added to the rabbit diet is converted, as milligrams of cholesterol per calorie, to human diet terms, it would appear that some three or four grams of cholesterol daily would be the minimal effective dose for man if he were as susceptible as the rabbit". However, a significant hypercholesterolemia and *gross* atherosclerosis can be produced in only 28 days if rabbits are fed 240 milligrams of added cholesterol daily. We calculate the equivalent human daily dose as 950 milligrams, an entirely reasonable intake for an American. The study of cholesterol metabolism as an approach to the causation of atherosclerosis seems to us perfectly valid.

2. The authors contend that obesity is not associated with coronary heart disease nor with an increased level of serum cholesterol. We believe that the literature they have cited does not support this interpretation, for the studies of Faber and Lund *excluded* from consideration all cases with hypercholesterolemia, and Garn *et al.* studied only subjects whose coronary disease appeared under 40 years of age. These men represent a very small proportion, and almost surely a nonrepresentative sample, of all men with coronary disease. Other supporting evidences cited are retrospective studies which used measurements obtained after the coronary artery disease had finally manifested itself and do not reflect the conditions pertaining during the period of atherogenesis. In contrast, three independent laboratories, the Framingham Study,<sup>6, 7</sup> the Donner Laboratory,<sup>8</sup> and the Department of Nutrition, Harvard School of Public Health (unpublished data) have obtained evidence that there is a significant positive correlation between relative weight and serum cholesterol levels.

3. Finally, it is not necessary to produce *severe* amino acid deficiency in monkeys in order to predispose these animals to experimental atherosclerosis. We regularly supply

cystine in our most atherogenic diets so that the monkeys are not severely deficient, but only marginally so. A severe deficiency, with the consequent anorexia, effectively prevents the hypercholesterolemia and atherosclerosis.

It should be emphasized that there is available only a minimum of information concerning the interrelation of dietaries and the prevalence of atherosclerosis among diverse human societies. This evidence needs to be exploited. There are three necessary observations in such studies: the nature of the habitual diet, with particular consideration for the daily caloric and fat intake; the levels of serum lipids, with attention to the  $\beta$ -lipoproteins and total cholesterol; and finally, the extent of atherosclerosis as determined by direct observation of tissues from subjects representing a span of ages. It is probable that the practical obstacles to a planned human experiment intended to relate these factors will finally demand a more thorough study of these matters in natural environments. In the meantime, it is necessary to be wary of conclusions drawn from impressions and inadequate observations.

Our own studies of these problems, carried out with the cooperation of Dr. Nevin Scrimshaw of the Institute of Nutrition of Central America and Panama, have now accomplished two-thirds of these objectives in that the serum lipid levels and the dietary intakes of 250 Central American natives have been evaluated.<sup>1</sup> These measurements show a pronounced dissociation between the total cholesterol and the lipoprotein levels of serum. Unlike United States citizens, these vegetarian people do not develop increasing levels of serum cholesterol with age. They maintain throughout life levels near 150 mg. %, which are characteristic only for children in North America.

The lipoprotein levels of the Central American are not very different from those of North Americans. It is apparent that such observations promise to be of critical importance in the evaluation of these serum lipid measurements. Such studies may also permit useful conclusions relating diet to the serum lipids, and, if we can secure proper autopsy material, they may permit useful correlations of the several serum lipid quantities and of diet with the prevalence of atherosclerosis.

Perhaps the most significant of all the epidemiological observations describing human atherosclerosis is the sex difference in the prevalence at various ages. This selection of males is probably better appreciated by clinicians than by the experimentalists. No hypothesis describing the genesis of atherosclerosis can ignore this fact. Any hypothesis which relates a dietary attribute such as fat intake or caloric plethora to the causation of atherosclerosis must account for the characteristic sparing of females during the child-bearing period.

Our experimental studies with rabbits have revealed a striking sex-determined resistance to cholesterol feeding.<sup>2</sup> We find male rabbits which do not respond to cholesterol feeding with the expected hypercholesterolemia and atherosclerosis far more frequently than we find female rabbits with this resistance. This reverses the usual pattern seen in human affairs. With proper hormone treatment "resistant" male rabbits can be made to respond and "susceptible" female animals can be made more resistant. All this indicates that there are important and no doubt multiple factors in addition to diet which influence the development of atherosclerosis, whether experimental or native. A unitarian theory of causation cannot be a reasonable representation of the facts.



### *Clinical Evidence*

There is a series of diseases which is almost traditionally associated with atherosclerosis because of coincidence of the two. It is generally difficult to know whether the particular disease and the atherosclerosis are related as cause and effect, but several of these pertinent situations have been studied in our laboratory, and the evidence we have will be outlined.

Many textbooks now erroneously associate diabetes mellitus with hypercholesterolemia and hyperlipemia. This error is a remnant of the preinsulin era of 30 years ago. Subjects with regulated diabetes—and many with unregulated diabetes—have no more lipemia or hypercholesterolemia than nondiabetics. Neither is the disease characterized by unusual lipoprotein patterns. It is recognized that diabetics develop atherosclerosis as well as the other forms of arteriosclerosis at an accelerated rate. Our collaborative efforts with Dr. H. F. Root and Dr. Nils Keiding of the Joslin Clinic<sup>3</sup> have indicated that diabetic subjects with cardiovascular complications of diabetes—and particularly the malignant triad of retinopathy, neuropathy, and nephropathy, which Dr. Root calls the “diabetic triopathy”—often have gross elevations of serum cholesterol and lipoproteins. We cannot distinguish cause and effect in this coincidence. Of more interest is the work done with Drs. Root, Schertenlieb, and Tuller<sup>4</sup> of the Joslin group, which has evaluated the effect of diabetic acidosis and coma and the treatment of these upon the serum lipids. We were started in this work by an observation made on a boy in diabetic coma with milky serum and very great elevation of serum lipid concentrations. Treatment with insulin and diet reversed all this in a few weeks so that the serum lipid patterns were indistinguishable from those of a normal boy. We have since studied many subjects in diabetic acidosis and find that this serum abnormality is commonly present to some degree, especially in young diabetics, i.e. with onset of diabetes under 30 years of age. Do such excursions of lipid metabolism each contribute to some vascular damage, so that such a person is finally crippled and killed by atherosclerosis? This is a practical question which has many implications in the everyday problems of managing diabetic patients.

These transitory deviations of lipid metabolism may also be of importance in the nondiabetic who overeats from time to time. In another study done in collaboration with Dr. Weldon Walker, Dr. Samuel Levine, and Dr. Donald Love at the Peter Bent Brigham Hospital<sup>5</sup> it was shown that in normal volunteers a short period of caloric plethora of an extent inducing one pound of weight gain per day almost doubled the serum cholesterol and the  $\beta$ -lipoprotein levels of the  $S_f$  12–400 classes. Since the diet was essentially fat-free (Karo syrup contributed the bulk of the excess calories) this effect was attributed to excessive calories alone. Conversely, the effect of negative caloric balance upon the serum lipids in 39 human subjects was conditioned not by the initial degree of fatness or the rate or extent of weight loss, but by the initial serum lipid levels. Only those subjects with initial cholesterol levels above 300 mg. % or  $S_f$  12–20 levels above 80 mg. % could be shown to have lowered the levels of these serum lipids by a weight reduction regimen. It remains to be demonstrated whether such serum changes do in fact influence atherogenesis.

Walker has recently published<sup>6</sup> a summary of the data of Dauber and Gofman *et al.*<sup>7</sup> relating a measure of body fatness to the levels of serum lipids of adults. This revealed

a significant, positive correlation for both sexes. Jones *et al.*<sup>8</sup> have published similar conclusions derived from independent data. Despite the vast amount of discussion of the subject, these observations and the indirect evidence obtained from insurance statistics are all the evidence available relating fatness and atherosclerosis. All will agree that this subject should be pursued more strenuously.

Hypothyroidism is often said to accelerate atherosclerosis, but it is doubtful if there is sufficient clinical and autopsy material to make an unqualified statement of the truth of this association. Our collaborative studies with Dr. Herrman Blumgart, Dr. A. Stone Freedberg, and Dr. George Kurland of the Beth Israel Hospital<sup>9</sup> have shown the profound effect of I<sup>131</sup>-induced hypometabolism in producing hypercholesterolemia and large elevations of the serum  $\beta$ -lipoproteins. The long-continued, serial follow-up of such subjects, and particularly of young females treated for thyroid malignancy, should be of value in relating serum lipid levels to the development of atherosclerosis.

The lipidoses constitute a varied and poorly understood group of diseases in which abnormalities of the serum lipids are characteristic. We have assisted Dr. Edwin Wheeler of the Massachusetts General Hospital<sup>10</sup> with a study of the disturbance of serum lipid patterns and the genetic distribution of subjects with xanthomatosis. This is a relatively rare disease, but one unquestionably predisposing to coronary artery disease. It appears that the disease is transmitted as a Mendelian trait, as had been proposed by others, and that the serum abnormality is present in childhood. The age of onset of visible xanthoma is in part determined by the severity of the serum lesion. This in turn is partially dependent upon the diet; low-fat diets will generally reduce the serum lipids of such subjects, although often they are not restored to normal by such measures.

Nephrosis and its relation to atherosclerosis have been inadequately studied. The dramatic lipemia observed is of uncertain origin. Hypoproteinemia may contribute to this lipemia, but the difficulty of dietary manipulation in such subjects makes this an awkward model for experimentation.

Experimental dietary trials in human subjects are difficult. To be meaningful, the dietaries need to be both prolonged and rigorous. The work of Hildreth *et al.*<sup>11</sup> has shown very nicely the profound effect of the total dietary fat level upon the serum cholesterol level. It is difficult to see why the myth persists that vegetable fat behaves differently in the diet than does animal fat in respect to cholesterol metabolism. There is no good evidence to support this belief. Conclusions to the contrary can generally be attributed either to an underestimate of the extent of the spontaneous ("biological") variation that is encountered particularly in serum cholesterol levels, when these are elevated, or with a failure to appreciate or to manage the technical variability of methods of measuring serum cholesterol. In their multitudinous forms these methods are often made to look deceptively simple and reliable.

It should be better appreciated, particularly in clinical affairs, that a restriction of dietary fat aimed at lowering serum lipid levels is a relative matter. A fat-free diet is, without qualification, inedible for any length of time. A diet containing less than 50 gm. of fat is exceedingly unpalatable and is unlikely to be adhered to for long. Fortunately, the desired effect will generally be obtained with less drastic restrictions of fat. Since most American males consume over 100 gm. of fat daily, a restriction to 70 gm. per day will often be effective and, after an adjustment, tolerably palatable. Dietary restrictions of fat should be individualized to suit the need, and should generally be coupled with a

reducing regimen. It is well to remember that the effect of a period of negative caloric balance upon the serum lipids is dependent upon the initial serum level, but not upon the initial relative weight.

Keys and his group have considered the matter of dietary cholesterol and its relation to atherosclerosis. We concur in believing that in the amounts conventionally consumed by Americans, dietary cholesterol is of trivial importance. The neutral fat content of two or three eggs daily will be of far more importance than the 900 to 1,000 mg. of cholesterol they contain.

On the other hand, we cannot accept Dr. Keys' dismissal of cholesterol-feeding experiments in animals on the basis that the amount of cholesterol fed in order to induce experimental disease is out of all proportion to what a human being would consume. The experimentalist is attempting, for reasons of expediency, to accelerate a process which in natural circumstances is so slow that study is virtually impossible. This manipulation of time and intensity variables can hardly be used as evidence that the experiments are invalid or that cholesterol is an artifact to the problem of atherosclerosis.

Our present knowledge reveals no significant role of the vitamins and of vitamin deficiency states in human atherosclerosis. With the possible exception of pyridoxine, none of the vitamins has been shown to be involved with the development of this disease. Rinehart and Greenberg<sup>13</sup> have reported that pyridoxine-deficient rhesus monkeys develop hypercholesterolemia and atherosclerosis. The published illustrations indicated the vessel disease to be extensive. Trials in our laboratory have not confirmed this work either with rhesus or with cebus monkeys. The reasons for this discrepancy are not clear. Considering the distribution of pyridoxine in the American dietary, it is difficult to believe that a human pyridoxine deficiency could exist.

To our knowledge a natural deficiency of pyridoxine in adult human subjects has not been demonstrated. In all mammals studied, including primates, pyridoxine deficiency is characterized by a profound microcytic anemia. This anemia is the earliest manifestation of the deficiency in experimental animals. Such an anemia would be unique in a typical human male with coronary artery disease.

#### *Laboratory Evidence*

The study of laboratory animals of various species subjected to feeding regimens is the most informative approach to an understanding of atherosclerosis. It is in this situation, permitting adequate control of variables, that efficient experimentation can be done. It is well to be aware of the extreme species variations which exist in respect to cholesterol metabolism, to natural serum lipid patterns, and to the susceptibility of vascular tissue to atherosclerotic changes. Cook<sup>14</sup> has described the species variation in respect to cholesterol absorption, and Lewis and Page<sup>15</sup> and Shull *et al.*<sup>16</sup> have discussed the serum lipid pattern differences.

Probably no single experiment has been done so often and so badly in the past 45 years as that of feeding cholesterol to rabbits for the purpose of producing hypercholesterolemia and atherosclerosis. It is not generally appreciated that sex differences of response (as described above) exist, that a dose of 1 gm. of cholesterol per day (and usually without regard for body weight) is an excessive one that will eventually prove lethal to rabbits, except when added to a diet either very low or variable in fat content. In either of these circumstances a huge variability of response, if one occurs, is assured.

It is unfortunate that rabbits cannot thrive on a purified diet. Since they do not, a commercial rabbit food with 4% added fat and furnishing 240 mg. of cholesterol daily is an optimal experimental ration. This regimen will permit differentiation of individuality of response. It will produce significant, but not lethal or incapacitating, elevations of serum and tissue lipids in 28 days. After suitable rest periods a repetition of the regimen will produce a similar response in the same animal. The experimental utility of such a preparation is obvious.

We have observed in studies done with Dr. Hilda White<sup>17</sup> that if rabbits are kept on such a regimen for many weeks, some animals will show spontaneous fluctuations of their serum cholesterol and lipoprotein levels. These changes are of an orderly nature and often have periods of one to four weeks. They occur with the known variables such as cholesterol, fat, and caloric intake constant, and with body weight and environmental temperature constant. Balance studies have revealed a direct relation between the serum cholesterol level and the proportion of the dietary cholesterol which disappears during intestinal passage. As the animal retains more fed cholesterol, the serum level increases, but as the serum level decreases the fecal cholesterol increases. A similar phenomenon has been observed in monkeys and dogs. We have proposed that a mechanism for the regulation of cholesterol assimilation exists, but we are not presently able to describe it. Our studies indicate that this mechanism is not a simple fluctuation in the action of intestinal flora upon cholesterol.

Dogs are proving useful experimental animals in the study of atherosclerosis. While a spontaneous vascular disease develops in many old dogs, it is uncertain whether this is truly an atherosclerotic process.<sup>16</sup> Kendall and his group<sup>18</sup> have shown that cholesterol feeding, coupled with hypometabolism induced by thyroid inactivation, will in time lead to atherosclerosis. In at least one animal, that group has produced vascular disease by simply adding cholesterol to a natural diet. In our laboratory Shull<sup>16</sup> has shown that cholesterol, added to either purified or natural diets, will lead to hypercholesterolemia and increase of the serum  $\beta$ -lipoproteins in dogs. In animals autopsied after three to five and one-half months vascular lesions have not been found.

Spontaneous atherosclerosis occurs with some regularity in several avian species, and is common in the domestic chicken. Dauber, Katz, and others have studied experimental atherosclerosis extensively in this species.<sup>19</sup> A notable sex difference of response has been observed. A laying hen poses an interesting problem of serum lipid transport, for she must mobilize the equivalent of a 20-gm. egg yolk each day during her laying period. This will contain from 250 to 350 mg. of cholesterol, largely combined in lipoproteins which bear striking resemblances to the  $\beta$ -lipoproteins of human serum. Those of egg yolk behave in the ultracentrifuge as  $S_r$  8-50 materials, with the majority moving as  $S_r$  26 material.<sup>20</sup> If these egg materials are in fact similar and if the serum lipoproteins of these classes are atherogenic, it is difficult to see how the hen could avoid vascular damage, unless some other tissue lesion is also necessary for atherogenesis. The demonstration of estrogen-induced hypercholesterolemia and atherosclerosis in chickens by Lindsay<sup>21</sup> suggests that the hens' physiological hyperlipemia does in fact have such consequences.

The implication that periods of caloric plethora in humans will elevate the serum cholesterol and lipoprotein level is of interest when related to the observation of Wolffe *et al.*<sup>22</sup> that stuffed geese being prepared for market show an increased incidence of

spontaneous atherosclerosis. A survey of other domestic animals which are made obese for market purposes is indicated. Similarly, the physiological obesity of hibernating animals may be associated with hyperlipemia and vessel disease.

The other species which has proved useful in experimental atherosclerosis is the cebus monkey. This small and hardy primate is well adapted to experimental studies. We have demonstrated<sup>23</sup> that cholesterol feeding alone has only a small, although discernible and probably significant, effect in raising the serum cholesterol and lipoprotein levels. If, however, the animals are deprived of the sulfur-containing amino acids, the response to cholesterol feeding is an immediate and dramatic increase of the serum cholesterol to levels of 300–800 mg. %, and of the  $\beta$ -lipoproteins of the S<sub>r</sub> 0–30 classes to abnormal levels. After 18 weeks of this treatment gross atheromata are observed in the aorta. Such animals show other evidences of sulfur deprivation, such as failure to gain or slow loss of weight and sparse coats. The animals actually absorb somewhat less cholesterol from the gut than do control animals fed cholesterol, but with adequate amino acid intakes. A liberal intake of neutral fat in the diet is essential to this response. Unlike the cholesterol-fed chicken and dog and rabbit, these monkeys do not develop visceral cholesterosis. This characteristic of the monkey disease resembles the natural human disease. This phenomenon in monkeys is obtained only with adequate amounts of dietary choline, so that it cannot be construed as a "methyl" deficiency response. The response is readily prevented or reversed with appropriate amounts of cystine, methionine, or cysteine, or by supplementation with an adequate protein. The disease has been produced in adolescent monkeys in order to avoid the possible confusion of spontaneous disease in aged animals. Spontaneous vascular disease has not been observed in cebus monkeys. Sex differences of response have not been seen, although we have used young animals and disproportionate numbers of females so that this remains an open question. Considerable individuality of both the serum and tissue response to this regimen is seen. In part this appears due to the unexplained fluctuations of intestinal disappearance of cholesterol described above in rabbits. The variability of response is no doubt also due in part to the technical difficulty of choosing an optimal level of sulfur amino acid intake to permit the lipid-vascular defect to develop, yet sufficient to prevent such malnutrition as will lead to anorexia and cachexia.

The vessel lesions have been centered in the aortic arch. They resemble in most respects the early atheromata of the human disease. We have not seen cerebral lesions or lesions of the muscular or more peripheral arteries. The coronary arteries are involved, especially at their orifices. Myocardial infarctions have not been produced.

Because a number of people have inquired whether a choline deficiency might be the basis of the deposition of lipids in vessels that we have observed, it should be emphasized that choline in generous amounts must be present in the diet to produce the lesions.<sup>23</sup>

These experimental findings in monkeys permit still another approach to the enigma of human atherosclerosis. It is of considerable importance to know how sulfur metabolism is related to this process. It is of interest to note that recent dietary surveys have indicated methionine to be the limiting nutrient in self-selected diets of two groups of midwestern women.<sup>24, 25</sup> A trial of methionine supplementation with 24 men of the Massachusetts Institute of Technology faculty has been done with the cooperation of Dr. Dana Farnsworth.<sup>26</sup> These men were selected for study because of moderate elevations of serum lipoprotein levels. A six-week period of supplementation with three grams

of methionine daily did not influence their serum lipid levels. It is difficult to see how egg- and meat-eating Americans could be deficient in their sulfur amino acid supply, for these are the proteins rich in such materials. A revival of interest in the intermediary metabolism of sulfur compounds may yet uncover some unknown mechanism of sulfur wastage, however.

It may be of interest to point out that the cebus monkeys with which we have succeeded in producing atherosclerosis were young monkeys, one to three years of age. The life span of this species is thought to be 15 to 30 years. The fact that atherosclerosis was produced in what might be termed adolescent primates, by a partial deficiency of sulfur amino acids in the presence of increased dietary cholesterol, emphasizes the possible importance of diet as a preventive factor, or conversely its importance as an etiologic factor in human affairs. It is well known that significant atherosclerosis is a common finding in young adults who die of other causes. This observation has recently been reaffirmed among American troop casualties in Korea. Diet may be important not only in middle or old age when the terminal consequences of atherosclerosis have appeared, but also in adolescent and young adult life when occult atherosclerosis is first appearing.

#### CONCLUSIONS

These manifold and often undecipherable evidences lead us to several useful conclusions.

The kinds and amounts of lipids present in serum are surely related to diet on the one hand and to atherosclerosis on the other, but the associations are imperfect. The limitations of methods of quantitation, both chemical and morphological, serve to conceal the true associations. We have, then, no simple serum criterion of the status of vessel integrity. The existing methods will permit the identification of those individuals with grossly abnormal serum lipids.

Dietary manipulation of both total calories and total fat are the most effective measures for correction of these deviations.

Severe dietary restriction of food fat, i.e. below 50 grams per day, is an unsound procedure both because such a regimen is unacceptable to most Americans and because it is difficult to maintain sound nutrition with such dietary restrictions.

Caloric balance is of importance in determining the levels of serum lipids. Weight reduction will lead to lowering of these levels if they are initially elevated, and conversely, periods of caloric plethora with gain of weight should be avoided, for this will lead to gross elevations of serum lipids. The dietary neutral fat and total caloric supply appear to be interacting variables of importance in both human and experimental atherosclerosis.

While dietary cholesterol levels are probably of little significance in natural human diets, cholesterol feeding is an extremely useful tool for the production and study of experimental hypercholesterolemia, hyperlipoproteinemia, and several forms of atherosclerosis in experimental animals.

The several useful experimental species vary both according to serum and tissue response to cholesterol feeding. Standard methods of experimental nutrition will control much of this variability, and interspecies variability should be turned to advantage by comparative studies.

In the adolescent cebus monkey, the protein quality plays a key role in the experimental production of atherosclerosis.

The vitamins and the so-called lipotropic agents do not appear to play a role in the development of atherosclerosis.

We cannot avoid the conclusion that atherosclerosis is a metabolic disease with important dietary relationships. The experimental approaches to an ultimate solution of this problem appear logically to be through the techniques and disciplines of the science of nutrition.

#### REFERENCES

1. Mann, G. V., Muñoz, J. A., and Scrimshaw, N. S.: The Serum Lipid Levels of Central Americans Compared with Those of North American Adults, *Fed. Proc.* 13: 467, 1954.
2. Fillios, L. C., Mann, G. V., and Stare, F. J.: The Variability of Response of Rabbits to Cholesterol Feeding, unpublished.
3. Keiding, N. R., Mann, G. V., Root, H. F., Lawry, E. Y., and Marble, A.: Serum Lipoproteins and Cholesterol Levels in Normal Subjects and in Young Patients with Diabetes in Relation to Vascular Complications. *Diabetes* 1: 434, 1952.
4. Tuller, E. F., Mann, G. V., Schertenlieb, F., Roehrig, C. B., and Root, H. F.: The Influence of Diabetic Acidosis and Coma upon the Serum Cholesterol and Lipoprotein in Human Subjects, *Diabetes* 3: 279, 1954.
5. Walker, W. J., Lawry, E. Y., Love, D. E., Mann, G. V., Levine, S. A., and Stare, F. J.: Effect of Weight Reduction and Caloric Balance on Serum Lipoprotein and Cholesterol Levels, *Am. J. Med.* 14: 654, 1953.
6. Walker, W. J.: Relationship of Adiposity to Serum Cholesterol and Lipoprotein Levels and Their Modification by Dietary Means, *Ann. Int. Med.* 39: 705, 1953.
7. Dauber, T. R., and others: Framingham Study, National Heart Institute, National Institutes of Health, U. S. Public Health Service, Washington, D. C.; Gofman, J. W., and others, Donner Laboratory, University of California, Berkeley, California: Unpublished data.
8. Gofman, J. W., and Jones, H. B.: Obesity, Fat Metabolism and Cardiovascular Disease, *Circulation* 5: 514, 1952.
9. Blumgart, H. L., Friedberg, A. S., Kurland, G., and Mann, G. V.: Unpublished data.
10. Wheeler, E. O., Lawry, E. Y., and Mann, G. V.: Unpublished data.
11. Hildreth, E. A., Mellinkoff, S. M., Blair, G. W., and Hildreth, D. M.: The Effect of Vegetable Fat Ingestion on Human Serum Cholesterol Concentration, *Circulation* 3: 641, 1951.
12. a. Keys, A.: Arteriosclerosis: A Problem in New Public Health, *J. Mt. Sinai Hosp.* 20: 118, 1953.  
b. Keys, A.: The Cholesterol Problem, *Voeding* 13: 539, 1952.
13. Rinehart, J. F., and Greenberg, L. D.: Arteriosclerotic Lesions in Pyridoxine Deficient Monkeys, *Am. J. Path.* 25: 481, 1949.
14. Cook, R. P., and Thomson, R. D.: The Absorption of Fat and Cholesterol in the Rat Guinea Pig and Rabbit, *Quart. J. Exper. Physiol.* 26: 61, 1951.
15. Lewis, L. A., Green, A. A., and Page, I. H.: Ultracentrifuge Lipoprotein Pattern of Serum of Normal, Hypertensive and Hypothyroid Animals, *Am. J. Physiol.* 171: 391, 1952.
16. Shull, K. H., Mann, G. V., Andrus, S. B., and Stare, F. J.: Response of Dogs to Cholesterol Feeding, *Am. J. Physiol.* 176: 475, 1954.
17. White, H. S., and Mann, G. V.: Unpublished data.
18. Steiner, A., and Kendall, F. E.: Atherosclerosis and Arteriosclerosis in Dogs Following Ingestion of Cholesterol and Thiouracil, *Arch. Path.* 42: 433, 1946.
19. Katz, L. N., and Stamler, J.: Experimental Atherosclerosis, Springfield, Ill., Charles C Thomas 1953.
20. Mann, G. V., and Lawry, E. Y.: Unpublished data.
21. Lindsay, S., Lorenz, F. W., Entenman, C., and Chaikoff, I. L.: Production of Atheromatosis in

- Aorta of Chicken by Administration of Diethylstilbesterol, *Proc. Soc. Exper. Biol. and Med.* **62**: 315, 1946.
22. Wolfe, J. B., Digilio, V. A., Dale, A. D., McGinnis, G. E., Donnelly, F. J., Plungian, M. B., Sprows, J., James, F., Einhorn, C., and Werkheiser, G.: Experimental Atheromatosis and Athero-Hepatitis in Ducks and Geese; Its Reversibility, *Am. Heart J.* **38**: 467, 1949.
  23. Mann, G. V., Andrus, S. B., McNally, A., and Stare, F. J.: Experimental Atherosclerosis in Cebus Monkeys, *J. Exper. Med.* **98**: 195, 1953.
  24. Futrell, M. F., Lutz, R. N., Reynolds, M. S., and Baumann, C. A.: Studies on Amino Acids in Self-Selected Diets, *J. Nutrition* **46**: 299, 1952.
  25. Mertz, E. T., Baxter, E. J., Jackson, L. E., Roderbuck, D. E., and Weiss, A.: Essential Amino Acids in Self-Selected Diets of Older Women, *J. Nutrition* **46**: 313, 1952.
  26. Mann, G. V., Farnsworth, D. L., and Stare, F. J.: An Evaluation of the Influence of DL-Methionine Treatment on the Serum Lipids of Adult American Males, *New England J. Med.* **249**: 1018, 1953.

### DISCUSSION

*Dr. Stare* mentioned that in his studies of adult Guatemalan males, *Dr. Mann* had found uniformly low blood cholesterol values but elevated lipoprotein levels.

He commented that the sex difference in the rabbit's response to cholesterol feeding is the opposite of that found in man, and that this sex difference in the development of experimental hypercholesterolemia can be reversed by hormonal treatment. A female rabbit that responds to cholesterol feeding will not develop hypercholesterolemia when testosterone is administered. A male rabbit that will not respond to cholesterol feeding will develop hypercholesterolemia when given an estrogen.

He stated that he, and also the investigators in the Framingham Study, had found the caloric balance to be an important factor affecting the serum levels of lipoproteins, especially where the levels are high. Weight reduction in an individual with a high level of cholesterol or of the lipoproteins in the S<sub>1</sub> 12-20 class is usually accompanied by a reduction of those levels. This does not occur in an obese individual who has an initial low level of these substances. The converse is true; that in an individual with low levels who is not overweight, a forced gain in weight of a pound a day over a period of two weeks is accompanied by an elevation of the levels.

He also pointed out that no spontaneous atherosclerosis had developed in the young monkeys used as controls in *Dr. Mann's* experiments.

*Dr. Paterson* reported that in an examination of multiple sections of the aortas of two rhesus monkeys, he had found marked fibrous plaque formation in the abdominal aorta. Although these were not particularly fat-containing they indicated that spontaneous fibrosis, at least, may occur in the monkey.

*Dr. Kalz* commented that his group had not been able to obtain the same results as *Dr. Stare* from the administration of the female sex hormone in the rabbit.

*Dr. Mann* suggested that the difference in response might be due to a difference in the amount of cholesterol in the diet. He stated that he had used only 240 mg. of cholesterol daily in a weight-maintaining caloric intake. If 1,000 mg. of cholesterol is administered daily the effect is obscured by an overloading of the liver with cholesterol esters. His rabbits were the commercial type rather than a pedigreed experimental strain. He said that it should also be emphasized that the hormone effects obtained at Harvard were measured in terms of cholesterolemia, not vessel changes.

*Dr. Pick* replied that her group had used one-quarter per cent cholesterol in oil in



some rabbits and one-half per cent cholesterol without oil in others, and that she may have given more than 240 mg. per diem.

*Dr. Taylor* reported that he had found moderately severe spontaneous atherosclerosis in 1 out of 14 monkey aortas collected from animals of uncertain age. The animals had not been on a high-fat or high-cholesterol diet.

*Dr. Mann* suggested that the term "monkeys" should not be applied indiscriminately to all of that varied order of primates.

*Dr. Anfinsen* cautioned against attempting to correlate the blood levels of any particular lipid with what is seen upon centrifugation until much more is known about plasma lipoprotein structure. He pointed out that the combination of various elements on a more specific central structure might give varying results, depending upon circumstances. There may be 50 to 100 per cent more total lipid in a sample of plasma than can be accounted for in the lipoprotein obtained by ultracentrifugation. The correlation of these levels cannot be established until more is known about the lipoproteins involved.

*Dr. Mann* felt that it was of critical importance for the evaluation of cholesterol and lipoprotein measurement as diagnostic tools to appraise the prevalence of atherosclerosis in their Guatemalan subjects, for these showed low cholesterol levels (150 mg.%) and lipoprotein levels similar to those of the North American companion group.

*Dr. Stare* commented that the results of studies made by several laboratories had demonstrated that cholesterol and lipoprotein levels are elevated by caloric plethora. He suggested that if the Air Force wishes to keep its pilots from developing atherosclerosis it should not furnish the usual 3,500 to 4,000 calories in its messes.

*Col. Milch* reported that the Air Force in its studies of Alaskan Eskimos had found cholesterol levels that were comparable to those in its oldest group of pilots. The lipoproteins in the series were comparable to the youngest group of pilots with respect to the S<sub>r</sub> 12-20 class, and the S<sub>r</sub> 0-12 class of lipoproteins correlated well with the cholesterol levels. It was found that the cholesterol levels are elevated but the lower-density lipoproteins are at a low concentration in Eskimo aborigines. *Dr. Kaare Rodahl* had reported that in his experience over a long period of Arctic exploration there have been no confirmed fatalities from cardiovascular disease among these Eskimos. The weight range of the group was comparable to that in a corresponding age group of Air Force pilots.

*Dr. Anderson* suggested that the high-fat diet of the Eskimo and the low-fat diet of the Guatemalan might account for the difference in lipoprotein findings.

*Dr. Mann* stated that the Guatemalans obtained 10 to 12 per cent of their calories from fat. He emphasized that they are vegetarians; that they are thin and do not get enough to eat. He also questioned the statement that Eskimos consume high-fat diets. This, he felt, was probably a storybook myth that originated 50 years ago when those people did consume a primitive diet, at least during the winter.

*Dr. Lawton* stated that the group studied were on a primitive diet.

*Col. Milch* added that the Eskimos selected were between the ages of 30 and 35, corresponding to a group of Air Force pilots between those ages.

*Dr. Katz* commented that he and his associates had reviewed the literature on the geographic incidence of atherosclerosis in the preparation of a survey, and that it is the

long-term diet that is important. Not only the type of diet, but how often the individuals eat and the fat intake over a long period must be taken into consideration in comparisons.

*Dr. Mann*, in reply to a question by *Dr. Page* as to the incidence of atherosclerosis in Guatemalans, stated that it is apparently of the same degree as that found by Benjamin in studies on Okinawans.

*Dr. Anderson* suggested that intermittent insults of short duration may be important in the development of atherosclerosis, and that the eating of a polar bear at one feast may constitute such a factor.

## THE RELATIONSHIP OF THE DIET TO THE DEVELOPMENT OF ATHEROSCLEROSIS IN MAN\*

ANCEL KEYS AND JOSEPH T. ANDERSON

Atherosclerosis differs sharply from the diseases that, so far, have been most successfully attacked by medical science and its public health applications. The distinction between "normal health" and "atherosclerotic disease" is a matter of degree; differentiation is more quantitative than qualitative. Among adults in the United States, at least, the question is not who has atherosclerosis, but rather who has more and who has less. For example, in 1,200 consecutive postmortem examinations of adults dead from all causes in Minnesota, some degree of atherosclerosis of the coronary arteries was almost universal. The incidence of marked atherosclerosis (grade 3 or 4), was 73 per cent among men 50 to 60 years old and 61 per cent among women of the same age.<sup>1, 81</sup>

At present, therefore, it would seem less profitable to look for a final "cause" of atherosclerosis than to seek for factors that influence its development. Hereditary and anatomical peculiarities undoubtedly play a role, but we must ask what other factors determine the quantitative outcome within the limits set by heredity. Among these factors for consideration, none is more clearly important than the diet. If a primary aim of our research is the prevention and control of unduly severe and early atherosclerotic development, then the approach through the diet appears to offer far more hope than any other avenue currently in sight.

How large that hope may be, can be gauged from the fact that the present great incidence of severe atherosclerosis and consequent heart disease in Americans is not at all representative of mankind in general and cannot be ascribed to chronological aging *per se*.<sup>28, 33</sup> The impressions of innumerable medical travelers on this point have lately been substantiated by very concrete evidence. The circumstances of war have made it possible to see in postmortem examination how little atherosclerosis there is among some populations, notably the inhabitants of Okinawa.<sup>3, 71</sup> The war also indicated what great changes in mortality from atherosclerotic heart disease, and in the extent of atherosclerosis seen at autopsy, can come about in relatively short periods of changed mode of life.<sup>20, 31, 46, 56, 73, 78</sup>

The diet seems to be the dominant factor in all of these studies. Higginson and Pepler<sup>22</sup> have been stimulated by this dietary clue to make 934 autopsies on adult Bantu. Among the Bantu the incidence of grade 3 or more atherosclerosis was barely a fifth that found among Americans of equal age; only a single case of coronary occlusion was found. The major question, then, is whether differences in the habitual diet explain, at least in part, these differences in atherosclerosis and mortality from coronary heart disease. Does more or less of some dietary factor contribute to more or less atherosclerosis at a given age in man?

Dietary factors that have been suggested as important in this connection include cholesterol in the diet, excessive calories and resultant obesity, deficiencies of various amino acids, of vitamins, and of minerals, the phytosterol content of foods, and the proportion

\* Many of the data cited were obtained in research aided by grants from the National Heart Institute, the National Dairy Council, and the Minnesota Heart Association.

of total fats in the diet. It is agreed that, besides the diet, mechanical and other factors in the blood circulation and in the arterial walls are concerned. The thesis is that the rate and extent of atherosclerotic development is the resultant of many factors, but that the diet is one of the most important of these. From the standpoint of public health and prevention, this would be fortunate indeed, for we now have the means to modify our diet at will.

#### *Dietary Cholesterol*

Animal experiments long ago seemed to implicate dietary cholesterol as a cause for cholesterol deposition in the arteries. In the rabbit and in some birds, the addition of large amounts of cholesterol to the diet produces remarkable hypercholesterolemia and subsequent atherosclerosis. The main virtue of these experiments is the demonstration of the general rule that a high level of cholesterol and cholesterol-bearing lipoproteins in the blood serum tends to promote atherosclerosis.

Unwarranted inferences have been made from cholesterol feeding experiments with animals. The evidence—both from experiments and from field surveys—indicates that the cholesterol content, *per se*, of all natural diets has *no* significant effect on either the serum cholesterol level or the development of atherosclerosis in *man*.<sup>30-33, 39, 47, 84</sup>

In the first place, the amount of dietary cholesterol required to produce hypercholesterolemia and atherosclerosis in experiments on susceptible mammalian species is far beyond the levels in natural human diets. The rabbit is the most susceptible mammal known so far. If the lowest effective level for cholesterol added to the rabbit diet is converted, as milligrams of cholesterol per calorie, to human diet terms, it would appear that some 3 or 4 grams of cholesterol daily would be the minimal effective dose for man if he were as susceptible as the rabbit. But this is several times the maximal intake in known human diets. The usual cholesterol supply in rabbit experiments corresponds to some 10 to 15 times the upper limit at which people actually consume dietary cholesterol.

In the second place, man is nothing like the rabbit in this respect. He is far more able to regulate his blood level independently of the cholesterol in the diet. A dietary load of added cholesterol which causes a 5- to 10-fold increase in the serum cholesterol of the rabbit in a month or two, produces no change or only a trivial rise of around 10 per cent in man in a matter of months.<sup>33</sup> Experiments with isotopic labelling show that the rabbit has an extraordinarily limited capacity, compared with the dog and man, to synthesize or to dispose of cholesterol.<sup>75</sup> Guinea pigs and rats seem to be intermediate between the rabbit and man in susceptibility to dietary cholesterol. Perhaps the monkey is more like man in this respect, but that does not necessarily mean that man is like the monkey in all details of cholesterol metabolism.

Finally, a large number of surveys on cholesterol in the diet and in the serum in various population samples consistently fail to demonstrate a significant relationship.<sup>16, 30, 81, 32, 33, 84</sup>

#### *Excessive Calorie Intake and Obesity*

The importance of excessive calorie intake and resulting obesity in the production of coronary and degenerative heart disease has been more widely proclaimed than objectively studied. With a given impairment of the heart, the fat man may suffer graver consequences because of the extra physical work required merely in moving around. How-

ever, this is not necessarily relevant to the problem of atherogenesis, and there is little real evidence for a direct effect of obesity on the development of atherosclerosis and coronary heart disease.

Postmortem evaluations of the incidence and severity of atherosclerosis in bodies of different degrees of emaciation and obesity were reported to reveal more atherosclerosis in the arteries of the fat cadavers,<sup>82, 88</sup> but this was not confirmed in careful studies with chemical analyses of the arteries.<sup>10</sup>

In view of the obvious importance of the serum cholesterol concentration, it is interesting that this is reduced in populations on short rations and that famine victims almost invariably have very low serum cholesterol concentrations.<sup>25, 35, 67</sup> The fact that atherosclerotic heart disease diminished sharply in many countries on restricted rations during World War II<sup>46, 56, 73</sup> is undoubtedly of major significance. But the argument that this shows an effect of obesity on atherogenesis suffers from the fact that whenever a population is faced with a restricted food supply the character of the diet tends to change even more than its total calorie content. The greatest and most invariable dietary change in famine, and under such conditions as those of World War II in much of Europe, is the replacement of fats by carbohydrates.<sup>35, 56</sup>

Comparisons of coronary disease patients with clinically healthy samples of the population reveals the fact, surprising in view of much recent propaganda, that coronary patients do not tend to be particularly fat;<sup>34</sup> they are little if any fatter than healthy "controls" of the same age in the same population.<sup>4, 15, 86</sup> Among seventy men aged 40 to 62 with coronary heart disease recently studied in the Laboratory of Physiological Hygiene, the distribution of relative obesity both before and after diagnosis was essentially the same as in a group of 198 clinically healthy men of the same age taken as random samples of the population from which the coronary patients came.

Among Army officers the presence of obesity could not be shown to promote the development of coronary heart disease.<sup>44</sup> And once coronary disease is well established neither the early<sup>4</sup> nor long-time<sup>5</sup> survival has been found to be adversely affected by the presence of obesity. Among 240 patients the 30-day survival rate after myocardial infarction was substantially the same among the fat people and those of normal weight, but was significantly poorer among the thinner patients. And among almost 4,000 patients with uncomplicated coronary heart disease, both the 5-year and the 10-year survival rate was significantly better among the obese patients (about 10 per cent of the total) than among the nonobese.

The question of serum cholesterol can be raised again. Is obesity associated with an elevated level of serum cholesterol? At any given age the correlation is very low in samples of men in England, Spain and Italy as well as in the United States.<sup>37, 38, 41</sup> The distribution of high and low values for serum cholesterol is much the same in groups of fat men as among thin men of the same age.

However, in the active state of developing obesity there may be a more significant relationship.<sup>11, 12</sup> We have been able to produce obesity in man under controlled conditions merely by increasing the total calorie intake. Most of the excess calorie intake was made up of carbohydrate. Some of the 20 subjects gained over 20 kg. in six months. During the active stage of gaining weight the serum cholesterol tended to rise in these men, the average (from regression analysis) being 2.2 mg. of cholesterol per 100 ml. of serum for each kg. of weight gain. But this increase was not maintained once weight gain ceased.

People rapidly losing weight sometimes exhibit an elevated cholesterol level and this is frequently the case in fasting, both in man and animals.<sup>27, 68, 69</sup> The metabolism of body fat dominates the energy turnover under these conditions. It is appropriate to anticipate the later argument and suggest now that, in general, fat metabolism and transport seem to be important, whether the fat comes from the diet or from the body stores.

The last point about obesity is the well-known evidence of the life insurance companies on the mortality of overweight policy holders.<sup>9</sup> There is no doubt that really obese persons, 20 to 74 per cent overweight on the usual height-weight standards, have an adverse total mortality experience compared with "standard" risks. It is important to note, however, that the more impressive experience concerns major degrees of overweight, averaging perhaps 50 pounds above the standard average weight for the same height and age. Even in these very fat people there is little evidence for an important excess incidence of *coronary* heart disease.<sup>34</sup>

#### *Specific Dietary Deficiencies*

In animal experiments, lesions resembling atherosclerosis in man have been reported to occur in the presence of several deficiencies of specific nutrients. There is as yet no evidence to indicate that these animal experiments have any relevance to "natural" human atherosclerosis.

Extreme deficiency of pyridoxine results in arterial changes in monkeys, mainly mucinous accumulation in the intima.<sup>58, 59</sup> The resulting condition is not atherosclerosis and, in any case, there is no reason to believe that man is frequently or ever exposed to comparable pyridoxine deficiency.

Mjasnikov<sup>49</sup> reported that ascorbic acid added in large amounts to the diet depressed the cholesterol level in the serum of hypertensive patients and hindered the development of atherosclerosis in cholesterol-fed rabbits. Mjasnikov also reported various effects of vitamin A, vitamin D, and nicotinic acid. None of this work is adequately supported by statistical analysis and proper controls, and there is no confirmation from elsewhere.

Twenty-six of 116 rats maintained for many weeks on a diet extremely deficient in choline were found to have intimal lesions of the arteries resembling atherosclerosis.<sup>19</sup> However, choline deficiency is apparently extraordinarily rare in man.

It has recently been reported that severe amino acid deficiencies coupled with dietary cholesterol loading can produce atherosclerosis in cebus monkeys.<sup>45</sup> In the first place, it is highly doubtful that the degree of amino acid deficiency developed in the Harvard experiments is frequently approached in the human populations in which atherosclerosis is most prevalent. And, in the second place, it may be noted that the Bantu people, who seem to be so relatively immune to atherosclerosis, are notorious for the chronic deficiency of amino acids in their diet. Nor are the Okinawans, and other Oriental people who are reputed to suffer little from atherosclerosis, blessed with a high intake of amino acids; they are in a part of the world where protein deficiency is chronic. In other words, from such epidemiological evidence as there is currently at hand, relative deficiency of proteins in the diet would be expected to hinder rather than to foment atherosclerosis.

#### *Phytosterols*

The possible effects of orally ingested plant sterols on the absorption of cholesterol in the gut or on the cholesterol metabolism are of interest, but the only question for present

consideration is whether plant sterols in natural diets may have significant effects. The ingestion of relatively large amounts of nonabsorbable substances closely related to cholesterol, including sitosterol, cholestanol, and mixed soy bean sterols, may depress the absorption of cholesterol in the gut and even influence the concentration in the blood.<sup>21, 52, 55</sup> Though such substances do occur in human diets, the amounts are generally not comparable with those which have been used experimentally. The question of a possible effect of phytosterols seems to pertain more to pharmacology than to ordinary concerns of nutrition.

#### *Dietary Fats—Experimental Studies*

The importance of dietary fats in the development of atherosclerosis in man is indicated from experiments on both man and other mammals, from surveys of populations on different diets, and from comparisons of vital statistics and data on national dietaries in different countries. The evidence is extensive and cannot be fully treated here, but the major lines of evidence must be mentioned.

The story begins in the period of confusion when efforts were being made to apply to man inferences from cholesterol feeding experiments with rabbits. In an effort to reduce hypercholesterolemia, or in the treatment of xanthomatosis or coronary heart disease, many physicians have tried low-cholesterol, low-fat diets, frequently with apparent benefit and occasionally with marked effects being claimed.<sup>51, 57</sup>

Schoenheimer<sup>64</sup> studied a patient with extreme hypercholesterolemia (800 or 1,000 mg. per 100 ml.) who showed a fall in blood cholesterol to one-third the previous value in fifty days on a pure vegetable diet. Continuation on this diet allowed the patient to maintain a normal concentration of cholesterol in her blood, but any break in the diet caused a prompt rise. Schoenheimer concluded that this patient's abnormality was simply an inability to excrete cholesterol properly. However, no computation was made of the amounts of cholesterol involved; when this is done it is evident that on the vegetable diet this patient lost from the blood about a gram of cholesterol daily for weeks on end, though on her previous diet her intake could scarcely have been half that great. Further, it is evident that a major difference between her pure vegetable diet and her previous diet was in the amount of total fat provided. In the same year (1933) Schoenheimer and Breusch<sup>65</sup> published their study on mice which showed the great capacity of the body to synthesize cholesterol and the significant fact that the addition of large amounts of cholesterol to the diet inhibited the synthesis in the body. This effect was confirmed 17 years later in dogs and rabbits.<sup>75</sup>

The introduction of the rice-fruit diet treatment for hypertension showed that this diet has a marked effect, demonstrated in a few days, of lowering the serum cholesterol level.<sup>6, 29, 66</sup> A similar cholesterol depression was produced in five days in 13 of 14 patients on a fat-free diet of protein hydrolysate and Dextrimaltose.<sup>47</sup> This effect, at first widely attributed to the absence of cholesterol in the rice-fruit diet, is identified primarily with the very low fat content of the diet; the effect is prevented or reversed by the simple addition of vegetable fat to the diet.<sup>30, 33, 39</sup> It was reported earlier, without attracting notice, that when young men changed from an ordinary diet to one in which fats provided 71 per cent of the calories, the cholesterol rose in a few days, even though the men were losing weight rapidly.<sup>8</sup>

In completely controlled experiments on physically healthy mental patients, four years

of experiments at the Hastings State Hospital have given consistent results. Within the range where total fats provide from 10 to 40 per cent of the total calories, the serum cholesterol concentration tends to respond in a few days to any major change in the proportion of fat in a constant calorie diet, and this is independent of the addition or subtraction of cholesterol in the diet.<sup>32, 33</sup> In a typical series of experiments 19 men who had for long been on a diet containing about 140 gm. of fat daily were changed to a diet with equal calories, proteins, and vitamins, but containing only 68 gm. of fat in the daily ration. The mean serum cholesterol concentration fell 25 mg. per 100 ml. in one to two weeks. When the fat intake was dropped to 11 gm. daily, calories, proteins, vitamins, and cholesterol remaining constant, the serum level declined a further 21 mg. per 100 ml. And when the fat intake was restored by adding vegetable oil to the diet (replacing carbohydrate) the previous serum cholesterol values were regained in two weeks. Self-experiments on three healthy persons have given results in full agreement with our own, both in regard to the effect of the total fat level in the diet and in regard to the effect of vegetable oil.<sup>23</sup>

In such experiments a major effect is usually observed within a few weeks or less, but it is important to inquire about its persistence. Prolonged experiments in the Laboratory of Physiological Hygiene have shown that when the dietary fat intake is changed, a new plateau of serum cholesterol tends to be established in three or four weeks and to remain as long as the diet is continued without change, at least up to six months, i.e., as long as the controlled experiments were continued on the same men. Our results are fully in accord with those of Wilmot and Swank<sup>65</sup> in which four normal persons and fifteen patients with multiple sclerosis were maintained for prolonged periods on a low-fat diet (30 to 50 gm. of total fat daily) containing normal amounts of cholesterol (0.7 to 1.0 gm. daily). The low-fat, high-cholesterol diet produced a marked fall in both total cholesterol and phospholipids in the blood serum. With continuation of the diet for periods up to one year the phospholipid levels tended to return to their previous (ordinary diet) values, but the reduction in serum cholesterol persisted as long as the low-fat diet was maintained.<sup>76</sup>

The interpretations of some experiments on man have been confused because of failure to recognize that egg yolks are highly fatty (over 31 per cent fat) as well as rich sources of cholesterol. For example, Messinger *et al.*<sup>48</sup> were puzzled when they observed that feeding pure cholesterol had less effect than feeding smaller amounts of cholesterol in egg yolks. Okey and Stewart<sup>54</sup> made systematic dietary experiments on four young women on a basal diet relatively abundant in both fats and cholesterol. When the yolks of four eggs were isocalorically substituted in the daily diet there was a significant rise in the serum cholesterol, but the addition of plain cholesterol in an amount equivalent to that in the egg yolks had no such clear effect. The authors did not remark on the fact that four egg yolks provide about 20 gm. of pure fat.

The relationship between the proportion of calories from fats and the serum cholesterol concentration in man may not extend to the extreme of a diet of almost pure fat. When 70 to 85 per cent of the total calories are provided from fat the serum cholesterol level of hospital patients may be unchanged,<sup>72</sup> or may actually fall.<sup>43</sup> What may be the mechanics of events in this extremely artificial situation is conjectural.

Much recent work on cholesterol emphasizes the large quantitative differences between species in its metabolism, with man being very unlike most laboratory animals. But



there is also some evidence from experiments on rats pointing to an effect of dietary fats independent of dietary cholesterol. The addition of lard, oleic acid, and stearic acid to the diet of rats clearly produced a rise in the serum cholesterol in the experiments of Swell and Flick.<sup>74</sup> Other data on young rats<sup>42</sup> also suggest an effect of corn oil, but the material is too small for proper analysis.

### *Dietary Fats—Population Samples*

Elsewhere we have pointed out the fact that, although it may be difficult to estimate accurately differences in the habitual fat intake between individuals and between different population segments of a given country, comparisons between countries disclose large differences.<sup>31. 32. 33</sup> In Japan and parts of Africa the total ether-extractable fats in the diet account for only 8 to 10 per cent of the total calories. At the other end of the scale is the United States where national food balance data, as well as various surveys, indicate something over 40 per cent of the total dietary calories provided in the form of fats.

Canada, Australia, and New Zealand have national dietaries in which fats provide an average of some 37 or 38 per cent of the calories, the mean value for England and Wales is around 35 per cent, and other countries in northern Europe are in the same general range. Italy, Spain, and Portugal are in great contrast, with only around 20 per cent of the total calories being derived from fats.

The possible effects of these national dietary differences may be considered in regard to the serum cholesterol picture or in regard to the incidence of atherosclerosis. Both approaches lead to a consistent over-all picture.

### *Serum Cholesterol in Populations on Differing Fat Intakes*

The first comparison is between clinically healthy men in the metropolitan areas of St. Paul-Minneapolis and Naples, Italy.<sup>33. 36. 37. 38. 41</sup> The average diets in the two groups provided about 40 per cent and 20 per cent, respectively, of total calories in the form of total extractable fats.

From young manhood until the early thirties (age 18 to about age 30 to 35) the serum cholesterol values in the Italians and in the Minnesotans were not statistically different; the mean values at mean age 25 were very nearly the same, as was the age trend (a mean rise of about 2 mg. of cholesterol per 100 ml. of serum per year of age). But with increasing age, whereas the serum cholesterol values continue to rise progressively in the Minnesotans, there was no significant further age trend among the Italians. In the fifties the mean cholesterol value in the Minnesotans was some 40 to 50 mg. per 100 ml. higher than in the Italians. The relative obesity of the two groups of men was practically identical; in middle age both Minnesotans and Italians averaged slightly heavier than the average, for given height, of U. S. men as indicated in the usual tables (Medico-Actuarial Investigations of 1912).

A similar comparison was made between Minnesota men and lower-class Spaniards in Madrid. The results resembled those in the Minnesota-Naples comparison except that the cholesterol differences in middle age were even larger, being of the order of 60 to 80 mg. per 100 ml. higher in the Minnesotans in the fifties. The diet of these Spaniards was found to be low in calories as well as in total fats, though the percentage of total

calories supplied from fats was somewhat higher than in the Neapolitans. These Spaniards were relatively thin, the average relative body weight averaging 10 to 12 per cent less than among Minnesotans of the same height and age. There was at most only a trivial correlation between relative obesity and serum cholesterol concentration within this group.<sup>41</sup>

A sample of clinically healthy men of a more favored social and economic class (physicians and executives) in Madrid was also studied in parallel with the sample of the general (poor) population. These relatively wealthy Madrileños subsist on an abundant diet rich in total fats. They proved to be like the Minnesotans in regard to relative obesity and in the serum cholesterol concentration at all ages.<sup>41</sup> By selecting the thinner men of this wealthier class and the fatter men of the poorer class it was possible to form two groups matched in regard to age and relative obesity. The serum cholesterol difference at ages over 30 still persists with these matched groups of Spaniards.

Two samples of clinically healthy men in the London area in England have been studied recently.<sup>38</sup> The habitual diets of the middle-aged men were carefully studied in detail and it was found that total fats provided, on the average, 35.4 per cent of their total calories. Again, as with all other groups mentioned here, the young men corresponded closely to the Minnesota series. The middle-aged men were much more like the Minnesotans and wealthy Spaniards than the poor Spaniards or the Neapolitans in their cholesterol values. However, these Englishmen were much thinner, at all ages, than the Minnesotans and were only slightly fatter than the poor Spaniards.

The native Bantu of South Africa are interesting because their habitual diet is very low in total fats. The concentration of serum cholesterol in these people is somewhat lower than in Minnesotans in youth<sup>77</sup> but the difference becomes progressively much greater with age, being 80 mg. or more per 100 ml. at age 50.<sup>79</sup> It is significant that autopsy studies on these Bantu disclose remarkably little atherosclerosis,<sup>22</sup> far less than among Danes of equal age (who eat a high-fat diet).<sup>80</sup>

During February–April, 1954, new studies were made on four samples of men in Naples and on a sample of men in Bologna, Italy, where the diet contains more fat than in any other part of Italy. The results will be reported in due course, but they are in full confirmation of our previous conclusions about the interrelationships between the diet, the cholesterol and lipoproteins in the blood serum, and the incidence of coronary heart disease in populations.

So far, then, it appears there are no exceptions to the rule that the average concentration of cholesterol in the blood serum of clinically healthy middle-aged men is roughly proportional to the percentage of total fats in the diet. The effect of the dietary fat level is less prominent in youth than in middle age. The situation among women is much less clear, but they do not seem to differ greatly from men in serum cholesterol.<sup>40, 41</sup>

A question may be raised as to the situation among Eskimos because of their popular reputation of eating a very high-fat diet. Unfortunately, there are no adequate systematic data on serum cholesterol in Eskimos of given age and sex subsisting on known diets. However, the Eskimo in modern times tends to eat a diet as low as or lower in fats than does the average European, not to mention the Americans.<sup>70</sup> A study on Aleut Indians, whose fat intake apparently is not greatly different from that of Americans, disclosed serum cholesterol values comparable to those of Americans.<sup>13, 14</sup>

*Atherosclerosis in Populations on Differing Fat Intakes*

There are innumerable published statements, unaccompanied by acceptable objective data, that atherosclerosis and coronary heart disease are rare in populations whose diets are notably low in fats. The unanimity of these reports from many parts of the world is impressive in spite of the absence of the numerical tabulations often demanded to count as "scientific" evidence. But final conviction is forced by systematic pathological studies.<sup>3, 22, 71</sup>

Perhaps even more significant are the data of vital statistics, because they treat with whole populations and disclose differences that cannot be explained away by arguments about diagnostic criteria.<sup>32, 33</sup> It is impossible, for example, to suggest that the vital statistics of Japan, which indicate only a minute fraction of the U. S. death rate from degenerative heart disease at given ages, mean merely that Japanese physicians fail to diagnose nine out of ten cases of angina pectoris and coronary heart disease. Nor, for example, are the indicated differences between Italy, Britain, and the United States eliminated by detailed analysis of all of the ascribed causes of death.

In the case of middle-aged men in Italy and in the United States, a gross excess of coronary disease deaths among the Americans is the only tenable explanation of the total mortality rates from all causes in these countries. Suppose on death certificates American physicians write "heart disease" three times as often as they should, or the Italian physicians fail to recognize two out of three cases of death from heart disease. There then remains the problem of accounting for an otherwise inexplicable excess of deaths from all causes among the American men in the age range of 40 to 60 years.

Further information is found in comparisons of male and female deaths. It is agreed by everyone that in the United States the death rate from coronary and related heart disease is several times higher in middle-aged men than among women of equal age. This ratio is lower in England and Wales, and in Italy the ratio is not much above unity. Is it possible that American physicians can discern coronary disease in men but not in women? Or that Italian doctors have the reverse peculiarity of recognition in the two sexes? This leads to logical absurdity, of course. No such bizarre phenomena appear in the vital statistics for neoplasms, cirrhosis of the liver, nephritis, or even for intracranial lesions of vascular origin.

The analysis of international vital statistics shows a striking feature when the national food consumption statistics are studied in parallel. Then it appears that for men aged 40 to 60 or 70, that is, at the ages when the fatal results of atherosclerosis are most prominent, there is a remarkable relationship between the death rate from degenerative heart disease and the proportion of fat calories in the national diet.<sup>33</sup> A regular progression exists from Japan through Italy, Sweden, England and Wales, Canada, and Australia to the United States. No other variable in the mode of life besides the fat calories in the diet is known which shows anything like such a consistent relationship to the mortality rate from coronary or degenerative heart disease.

Evidence for an important relationship between dietary fat and atherosclerosis in man is provided by hospital and clinic records, postmortem studies, and vital statistics in Europe during World War II.<sup>33</sup> In Britain the changes in mortality ascribed to degenerative heart disease and in the percentage of the total calories supplied by fats were small but they were parallel. In other areas of northern Europe during the war years there was

a marked decrease in the total fat intake, and this was associated with evidence for a decline in atherosclerosis roughly proportionate to the dietary change. This was clearly shown both in vital statistics and in the pathologists' reports in the Scandinavian countries, the largest changes in arteriosclerotic heart disease being in Norway and Finland where the decline in fat consumption was greatest and least in Denmark where the diet was relatively unchanged.<sup>46, 56, 73, 78</sup> In neutral Sweden, where the age distribution of the population and the medical and public health services were not changed during the war, the death rate from arteriosclerosis and chronic myocarditis fell sharply on low fat diets and rose only with the resumption of "normal" fat usage in the postwar years.<sup>20</sup> In Norway and Sweden the change was clearly evident in two years. In Finland, arteriosclerotic deaths had declined at least 30 per cent in men and at least 20 per cent in women by 1942; in 1943 and 1944 arteriosclerotic deaths were barely a third as numerous as in the prewar years.<sup>78</sup> That serum cholesterol values declined in populations on low-fat diets during the war seems certain.<sup>25, 61, 62, 63</sup>

The implication obviously is that in the war: 1) The usual (prewar) progression of atherosclerotic development with age was rapidly arrested, or 2) A given degree of atherosclerosis suddenly became less apt to produce a fatal outcome, or 3) There was actually some reversal of the atherosclerotic process. The Finnish data suggest that the second possibility, a less lethal outcome, was operative to some extent because the decline in the incidence of severe atherosclerosis seen post mortem was much less than the decline in mortality. But the same evidence shows that there *was* a real decline in the incidence of atherosclerosis as observed post mortem, so either arrest of the usual development or some regression, or both, did occur.

#### *The Effects of Different Dietary Fats*

Until recently almost all of the clinical attempts to reduce serum cholesterol primarily involved a reduction in animal fat intake, in the belief that dietary cholesterol is important. But the effects of vegetable fats and oils have been clearly demonstrated in controlled experiments.<sup>23, 39</sup> Recently Cochrane *et al.*<sup>7</sup> have reported that in five diabetics on a very high-fat diet (averaging over 50 per cent of calories from fats), a change from animal to vegetable fats (mostly "margarine," not further specified, and unsalted nuts) at the same intake level produced a definite fall in plasma cholesterol and phospholipid concentrations. How far these results may have relevance to more normal people and diets is uncertain.

In the Laboratory of Physiological Hygiene most of our demonstrations of the effects of fat intake have been made with corn oil or cottonseed oil or both. Recently, however, we have carried out an elaborately controlled experiment on 24 men in which olive oil and cottonseed oil were compared. These fats were chosen because, among common food fats of vegetable origin, they have the greatest chemical dissimilarity. Besides the use of control (before and after) periods, each subject was studied on both types of fat, and the effect of sequence was also controlled. No difference between the effects of olive oil and of cottonseed oil on serum cholesterol concentration could be found.

#### *Alcohol*

In many individuals in the United States and in other Western countries alcohol provides an appreciable part of the total calorie supply and must be reckoned in the diet

somewhere. Does alcohol have any effect on cholesterol metabolism or atherosclerosis in man? Wilens<sup>82</sup> agreed with earlier views that atherosclerosis is less frequent among alcoholics than in the general population, but suggested this is probably due to other variables besides the alcohol *per se*. Hobson *et al.*<sup>24</sup> studied 98 old men (66 to 85 years old) living alone; of these, 12 were classed as heavy drinkers and 14 as lifelong abstainers. The (log) mean concentration of serum cholesterol was 224 mg. per 100 ml. in the heavy drinkers, 305 in the teetotalers, while the value for the entire group of 98 men was 268, the differences being statistically significant.

The evidence indicates that, for reasons yet unknown, heavy drinkers may tend to have low serum cholesterol values and a reduced incidence of severe atherosclerosis.

#### DISCUSSION

The results of a number of experiments and group comparisons with human beings clearly show an effect, without precise identification of the responsible factor, of different degrees of "luxury" of the diet on serum cholesterol. In the 36 weeks' experiment of Groen *et al.*<sup>18</sup> on sixty healthy volunteers, the highest serum cholesterol averages (about 250 mg. per 100 ml.) were found when the subjects were on the diet highest in fats and proteins (45 and 16 per cent of the calories, respectively), and the lowest values (mean about 200 mg. per 100 ml.) occurred when fats and proteins made the least contribution to the diet (37 and 10 per cent, respectively). Comparisons in Finland of civil prisoners on a cheap diet with control subjects on a more luxurious type of diet showed similar relationships.<sup>26</sup> The diets were nutritionally "adequate" in all of these studies. Similar questions arise in comparing Jews and Gentiles in Amsterdam.<sup>17</sup> The picture of high-fat diet, high serum cholesterol, and excessive atherosclerosis among the Jews would conform to other evidence.

Generally speaking, natural human diets low in fats tend to be low in proteins also, though this is not necessarily the case. From epidemiological studies some effect on atherosclerosis of proteins as well as of total fats in the diet cannot be excluded. *If* protein intake is a factor, the conclusion would be that a high protein intake favors the development of atherosclerosis. We believe this is unlikely, but much more research is needed.

It should be observed also that in population comparisons made to date the possible role of physical activity is difficult to rule out.<sup>60</sup> The Italians and poor Spaniards we have studied undoubtedly do more physical work than our Minnesotans or the rich Spaniards, for example. But the amount of physical energy expenditure among the Englishman we studied was at least comparable to that of the Italians. Here again, obviously, research is barely in its beginnings.

In the past, comparisons between population groups and between patients and controls have often been confused because of inattention to age and the requirements for proper statistical evaluation. Measurements of age trends in serum cholesterol and related lipoproteins may be obscured in small groups by the large variation between individuals of the same age.<sup>40, 63</sup> In general, it appears that each individual has his cholesterol-regulatory mechanism set according to his own individuality, but that its general response to age and diet tends to conform to a common pattern. In this pattern a response to total fats in the diet, increasingly prominent from the end of physical growth at least to the onset of old age, is both prominent and important.

In the present discussion attention to the chemistry of the blood serum has been fo-

cussed on the total cholesterol, partly because there is far more information about this than any other relevant item of analysis, partly because we still insist<sup>53</sup> there is no evidence that other recommended analytical items have really significantly different or greater diagnostic or prognostic value. Measurements of total cholesterol, of the cholesterol/phospholipid ratio, of the S<sub>T</sub> 10-20 and S<sub>T</sub> 12-20 fractions obtained by ultracentrifugation, of the beta lipoprotein (Cohn's method X) cholesterol, lipid, protein, or mass—all have great and similar value in differentiating groups in regard to atherosclerosis and all have very poor predictive value for individuals. We may hazard the opinion, from our own comparisons of these several methods as well as from the recent literature,<sup>2, 53, 60</sup> that the cholesterol in the beta lipoprotein fraction may ultimately prove most useful, but the margin of superiority over the other measurements will be small.

At the start of this paper it was indicated that we would not attempt to discuss mechanisms here. This involves serious limitations, but these are not necessarily of first importance at the broad practical level. Historically, and until now, mankind's most conspicuous successes in preventing or controlling major diseases have come about through measures applicable to the population, mainly developed from epidemiological researches, in advance of detailed understanding of pathological mechanisms.

This is not to decry the value of fundamental studies on mechanisms, but it does point to the virtue of research on the relationships between factors in the mode of life and the development of disease, even in the absence of proper knowledge about the intervening processes. Further, the epidemiological approach, based on full appreciation of all available physiological and biochemical information, will unquestionably provide important clues for research on mechanisms.

Finally, the fact that the diet appears to have an important effect on the development of atherosclerosis in man is of particular interest in those countries where atherosclerosis is most prevalent because, in general, those are the countries where the availability of foodstuffs and a versatile food-processing industry would most readily permit alteration of the diet to suit health needs. The United States is the outstanding example, of course.

#### SUMMARY AND CONCLUSIONS

1. Experiments on laboratory animals show that whenever the concentration of cholesterol (and cholesterol-bearing lipoproteins) in the blood is maintained at a high level, there is a marked tendency towards the development of atherosclerosis. Surveys and clinical observations indicate the same principle holds for man.

2. Hospital records, postmortem studies, and vital statistics confirm impressions that there are great differences between different populations in the age-incidence and severity of atherosclerosis. There is no evidence that these differences depend on race, climate, intercurrent diseases, or the adequacy of public health and medical services.

3. During World War II there were major changes in the incidence of atherosclerosis and mortality from atherosclerotic heart disease in several populations. These changes, as well as the differences between populations indicated above, are consistent with the theory that the diet is a major factor in the development of atherosclerosis in man.

4. Man differs greatly in regard to quantitative details of cholesterol metabolism from most animal species studied so far. Application to man of the results of animal experiments easily leads to erroneous conclusions.

5. Dietary cholesterol has little or no influence on the blood cholesterol level in man over the range of all ordinary human diets. Further, there is no evidence that dietary cholesterol, other things being equal, has any influence on atherosclerosis in man.

6. The influence of excessive calorie intake and resulting obesity, *per se*, on the serum cholesterol level of man is small. Further, there is no proof that obesity, *per se*, has any influence on the development of atherosclerosis in man, though it may cause a greater degree of disability and strain from a given degree of coronary disease.

7. Both controlled experiments on man and studies of populations on different diets show that the total fat content of the diet, or the proportion of total calories supplied from fats, has a major effect on the serum cholesterol level of adults, the effect being smaller in young persons. Further, the prediction that this relationship will have an important effect on the incidence of atherosclerosis and mortality from degenerative heart disease is borne out by data from various countries. In effect, this relationship offers a reasonable explanation for the phenomena noted in paragraphs 2 and 3 above.

8. Consideration of the possible effects of other dietary factors, including proteins and vitamins, discloses no evidence for important effects in man on either serum cholesterol or atherosclerosis.

9. The effects of different food fats in man have been inadequately studied. Experiments here indicate that all food fats produce effects, but that there are quantitative differences between the responses to butterfat and to cottonseed oil.

#### REFERENCES

1. Ackerman, R. F., Dry, T. J., and Edwards, J. E.: Relation of Various Factors to the Degree of Coronary Atherosclerosis in Women, *Circulation* 1: 1345, 1950.
2. Barr, D. P., Russ, E. M., and Eder, H. A.: Protein-lipid Relationships in Human Plasma, *Am. J. Med.* 11: 480, 1951.
3. Benjamin, E. L.: Report of Two Hundred Necropsies on Natives of Okinawa, *U. S. Nav. M. Bull.* 46: 495, 1946.
4. Billings, F. T., Kalstone, B. M., Spencer, J. L., Ball, C. O. T., and Meneely, D. R.: Prognosis of Acute Myocardial Infarction, *Am. J. Med.* 7: 356, 1949.
5. Block, W. J., Jr., Crumpacker, E. L., Dry, T. J., and Gage, R. P.: Prognosis of Angina Pectoris: Observations in 6,882 Cases, *J.A.M.A.* 150: 259, 1952.
6. Chapman, C. B., Gibbons, T., and Henschel, A.: The Effect of the Rice-fruit Diet on the Composition of the Body, *New England J. Med.* 243: 899, 1950.
7. Cochrane, G. C., Michaels, G. D., and Kinsell, L. W.: Dietary Modifications of Plasma Cholesterol and Phospholipid Levels in Diabetic Patients, *J. Clin. Nutrition* 1: 295, 1953.
8. Consolazio, F. C., and Forbes, W. H.: The Effects of High Fat Diet in a Temperate Environment, *J. Nutrition* 32: 195, 1946.
9. Dublin, L. I., and Marks, H. H.: Mortality Among Insured Overweights in Recent Years, *Tr. A. Life Insur. M. Dir. America* 35: 235, 1952.
10. Faber, M., and Lund, P.: The Human Aorta. Influence of Obesity on the Development of Arteriosclerosis in the Human Aorta, *Arch. Path.* 48: 351, 1949.
11. Firstbrook, J. B.: The Effect of Changes in Body Weight on Atherosclerosis in the Rabbit, *Science* 111: 31, 1950.
12. Firstbrook, J. B.: Factors Influencing the Atherosclerotic Process, *Circulation* 2: 464, 1950.
13. Garn, S. M., and Gertler, M. M.: Arcus Senilis and Serum Cholesterol Levels in the Aleutian Islands, *New England J. Med.* 242: 283, 1950.
14. Garn, S. M., and Gertler, M. M.: Age and Sex Differences in Serum Cholesterol of Aleut, *Canad. M. A. J.* 64: 338, 1951.
15. Garn, S. M., Gertler, M. M., Levine, S. A., and White, P. D.: Body Weight Versus Weight Standards in Coronary Artery Disease and Healthy Group, *Ann. Int. Med.* 34: 1416, 1951.

16. Gertler, M. M., Garn, S. M., and White, P. D.: Diet, Serum Cholesterol and Coronary Artery Disease, *Circulation* 2: 696, 1950.
17. Groen, J., Kamminga, C. E., Reisel, J. H., and Willebrands, A. F.: Cholesterol Content of Blood Serum from Jewish and Gentile Blood Donors, *Nederl. tijdschr. v. geneesk.* 94: 728, 1950.
18. Groen, J., Tjong, B. K., Kamminga, C. E., and Willebrands, A. F.: The Influence of Nutrition, Individuality and Some Other Factors Including Various Forms of Stress, on the Serum Cholesterol; an Experiment of Nine Months Duration in 60 Normal Human Volunteers, *Voeding* 13: 556, 1952.
19. Hartroft, W. S., Ridout, J. H., Sellers, E. A., and Best, C. H.: Atheromatous Changes in Aorta, Carotid and Coronary Arteries of Choline-deficient Rats, *Proc. Soc. Exper. Biol. & Med.* 81: 384, 1952.
20. Henschen, F.: Geographic and Historical Pathology of Arteriosclerosis, *J. Gerontol.* 8: 1, 1953.
21. Hernandez, H. H., Peterson, D. W., Chaikoff, I. L., and Dauben, W. G.: Absorption of Cholesterol-4-C<sup>14</sup> in Rats Fed Mixed Soybean Sterols and  $\beta$ -Sistoterol, *Proc. Soc. Exper. Biol. & Med.* 83: 498, 1953.
22. Higginson, J., and Pepler, W. J.: *J. Clin. Investigation* 33: 1366, 1954.
23. Hildreth, E. A., Mellinkoff, S. M., Blair, G. W., and Hildreth, D. M.: The Effect of Vegetable Fat Ingestion on Human Serum Cholesterol Concentration, *Circulation* 3: 641, 1951.
24. Hobson, W., Jordan, A., and Roseman, C.: Serum Cholesterol Levels in Elderly People Living at Home, *Lancet* 265: 961, 1953.
25. Horst, W.: Beitrag zum Lipoidstoffwechsel bei chronischer Unternahrung, *Klin. Wchnschr.* 28: 184, 1950.
26. Josephson, B., Dahlberg, C., and Totterman, C.: On the Effect of Nutrition upon the Blood Count and Chemical Composition of the Blood, *Scandinav. J. Clin. & Lab. Invest.* 4: 237, 1952.
27. Kartin, B. L., Man, E. B., Winkler, A. W., and Peters, J. P.: Blood Ketones and Serum Lipids in Starvation and Water Deprivation, *J. Clin. Investigation* 23: 824, 1944.
28. Katz, L. N., and Stamler, J.: *Experimental Atherosclerosis*, Springfield, C. C. Thomas, 1953.
29. Kempner, W.: Treatment of Hypertensive Vascular Disease with Rice Diet, *Am. J. Med.* 4: 545, 1948.
30. Keys, A.: Human Atherosclerosis and the Diet, *Circulation* 5: 115, 1952.
31. Keys, A.: The Cholesterol Problem, *Voeding* 13: 539, 1952.
32. Keys, A.: Diet and the Incidence of Heart Disease, *Bull. Univ. Minn. Hospitals and Minnesota Medical Foundation*, 24: 376, 1953.
33. Keys, A.: Atherosclerosis: A Problem in Newer Public Health, *J. Mt. Sinai Hosp.* 20: 118, 1953.
34. Keys, A.: Obesity and Degenerative Heart Disease, *Am. J. Public Health* 44: 864, 1954.
35. Keys, A., Brozek, J., Henschel, A., Mickelsen, O., and Taylor, H. L.: *The Biology of Human Starvation*, Minneapolis, University of Minnesota Press, 1950.
36. Keys, A., Fidanza, F., Scardi, V., and Bergami, G.: The Trend of Serum-cholesterol Levels with Age, *Lancet* 263: 209, 1952.
37. Keys, A., Fidanza, F., Scardi, V., Bergami, G., Keys, M. H., and Di Lorenzo, F.: Studies on Serum Cholesterol and Other Characteristics of Clinically Healthy Men in Naples, *Arch. Int. Med.* 93: 328, 1954.
38. Keys, A., and Keys, M. H.: Serum Cholesterol and the Diet in Clinically Healthy Men in the London Area, *Brit. J. Nutrition* 8: 138, 1954.
39. Keys, A., Mickelsen, O., Miller, E. v. O., and Chapman, C. B.: The Relation in Man Between Cholesterol Levels in the Diet and in the Blood, *Science* 112: 79, 1950.
40. Keys, A., Mickelsen, O., Miller, E. v. O., Hayes, E. R., and Todd, R. L.: The Concentration of Cholesterol in the Blood Serum of Normal Man and Its Relation to Age, *J. Clin. Investigation* 29: 1347, 1950.
41. Keys, A., Vivanco, F., Rodriguez Miñon, J. L., Keys, M. H., and Castro Mendoza, H.: Studies on the Diet, Body Fatness and Serum Cholesterol in Madrid, Spain, *Metabolism* 3: 195, 1954.
42. Kim, K. S., and Ivy, A. C.: Factors Influencing Cholesterol Absorption, *Am. J. Physiol.* 171: 302, 1952.
43. Kinsell, L. W., Partridge, J., Boling, L., Margen, S., and Michaels, G.: Dietary Modification of Serum Cholesterol and Phospholipid Levels, *J. Clin. Endocrinol. Metab.* 12: 909, 1952.



44. Levy, R. L., White, P. D., Stroud, W. D., and Hillman, C. C.: Overweight: Its Prognostic Significance in Relation to Hypertension and Cardiovascular-renal Diseases, *J.A.M.A.* *131*: 951, 1946.
45. Mann, G. V., Andrus, S. B., McNally, A., and Stare, F. J.: Experimental Atherosclerosis in Cebus Monkeys, *J. Exper. Med.* *98*: 195, 1953.
46. Malmros, H.: The Relation of Nutrition to Health—A Statistical Study of the Effect of War-Time on Arteriosclerosis, Cardiosclerosis, Tuberculosis, and Diabetes, *Acta med. scandinav.* (suppl. 246) p. 137, 1950.
47. Mellinkoff, S. M., Machella, T. E., and Reinhold, J. G.: The Effect of a Fat Free Diet in Causing Low Serum Cholesterol, *Am. J. M. Sc.* *220*: 203, 1950.
48. Messenger, W. J., Porosowska, Y., and Steele, J. M.: Effect of Feeding Egg Yolk and Cholesterol on Serum Cholesterol Level, *Arch. Int. Med.* *86*: 189, 1950.
49. Mjasnikov, A. L.: Über den Einfluss einiger Vitamine auf die Cholesterinämie und die Entwicklung der experimentellen Atherosklerose, *Klin. med., Moscow* *28*: 3, 1950.
50. Morris, J. N., and Heady, J. A.: Mortality in Relation to the Physical Activity of Work, *Brit. J. Indust. Med.* *10*: 245, 1953.
51. Morrison, L. M., Awierlein, M., and Wolfson, E.: The Effects of Low Fat-Low Cholesterol Diets on the Serum Lipids, *Circulation* *2*: 475, 1950.
52. Nichols, C. W. Jr., Siperstein, M. D., and Chaikoff, I. L.: Effect of Dehydrocholesterol (Cholestanol) Administration on Plasma Cholesterol and Atherosclerosis in the Rabbit, *Proc. Soc. Exper. Biol. & Med.* *83*: 756, 1952.
53. Nikkilä, E., Studies on the Lipid-protein Relationship in Normal and Pathological Sera and the Effect of Heparin on Serum Lipoproteins, *Scandinav. J. Clin. & Lab. Invest.* *5*: Supp. 8, 1953.
54. Okey, R., and Stewart, D.: Diet and Blood Cholesterol in Normal Women, *J. Biol. Chem.* *99*: 717, 1933.
55. Peterson, D. W.: Effect of Soybean Sterols in the Diet on Plasma and Liver Cholesterol in Chicks, *Proc. Soc. Exper. Biol. & Med.* *78*: 143, 1951.
56. Pihl, A.: Cholesterol Studies. II. Dietary Cholesterol and Atherosclerosis, *Scandinav. J. Clin. & Lab. Invest.* *4*: 122, 1952.
57. Priddle, W. W.: Hypercholesteremia: An Analysis of 529 Cases and Treatment of 297 by a Low Animal Fat Diet and Desiccated Thyroid Substance, *Ann. Int. Med.* *35*: 836, 1951.
58. Rinehart, J. F., and Greenberg, L. D.: Pathogenesis of Experimental Arteriosclerosis in Pyridoxine Deficiency, *Arch. Path.* *51*: 12, 1951.
59. Rinehart, J. F., and Greenberg, L. D.: Arteriosclerotic Lesions in Pyridoxine-deficient Monkeys, *Am. J. Path.* *25*: 481, 1949.
60. Russ, E. M., Eder, H. A., and Barr, D. P.: Protein-lipid Relationships in Human Plasma, *Am. J. Med.* *11*: 468, 1951.
61. Schettler, G.: Einfluss der Ernährung auf den Cholesteringehalt des Blutes, *Klin. Wchnschr.* *28*: 565, 1950.
62. Schettler, G.: Neues vom Cholesterinstoffwechsel, *Ergebn. inn. Med. u. Kinderh.* *3*: 299, 1952.
63. Schettler, G.: Arteriosklerose und Cholesterinstoffwechsel, *Deutsche med. Wchnschr.* *78*: 989, 1953.
64. Schoenheimer, R.: Über eine Störung der Cholesterin-Ausscheidung (Ein Beitrag zur Kenntnis der Hypercholesterinämien), *Ztschr. f. klin. Med.* *123*: 749, 1933.
65. Schoenheimer, R., and Breusch, F.: Synthesis and Destruction of Cholesterol in the Organism, *J. Biol. Chem.* *103*: 439, 1933.
66. Schwartz, W. B., and Merlis, J. K.: Nitrogen Balance Studies on Kempner Rice Diet, *J. Clin. Investigation* *27*: 406, 1948.
67. Sherlock, S., and Walshe, V. M.: Studies of Undernutrition, Wuppertal 1946-9, *Med. Res. Council, London, Special Rept. Ser., No. 275*, 1951, p. 123.
68. Shope, R. E.: Sugar and Cholesterol in Blood Serum as Related to Fasting, *J. Biol. Chem.* *75*: 101, 1927.
69. Shope, R. E.: Hypercholesterolemia of Fasting as Influenced by Separate Administration of Fats, Carbohydrates, and Proteins, *J. Biol. Chem.* *80*: 133, 1928.
70. Sinclair, H. M.: The Diet of Canadian Indians and Eskimos. *Proc. Nutrition Soc., London*, *12*: 69, 1953.
71. Steiner, P. E.: Necropsies on Okinawans, *Arch. Path.* *42*: 359, 1946.

72. Steiner, A. Significance of Cholesterol in Coronary Arteriosclerosis, *New York State J. Med.* 48: 1814, 1948.
73. Strom, A., and Jensen, A. R.: Mortality from Circulatory Diseases in Norway, *Lancet* 260: 126, 1951.
74. Swell, L., and Flick, D. F.: Effect of Dietary Fat and Cholesterol on the Blood Cholesterol Level of Rats, *Am. J. Physiol.* 174: 51, 1953.
75. Taylor, C. B., and Gould, R. G.: Effect of Dietary Cholesterol on Rate of Cholesterol Synthesis in the Intact Animal Measured by Means of Radioactive Carbon, *Circulation* 2: 467, 1950.
76. Urbach, R., Hildreth, E. A., and Wackerman, M. T.: The Therapeutic Uses of Low Fat, Low Cholesterol Diets: I. Treatment of Essential Familial Xanthomatosis, *J. Clin. Nutrition* 1: 52, 1952.
77. Van Oye, E., and Charles, P.: Contribution a l'Étude de la Fonction Hépatique chez le Noir Africain. 6. La Cholestérolémie, *Ann. Soc. belge de méd. trop.* 32: 297, 1952.
78. Vartiainen, I., and Kanerva, K.: Arteriosclerosis and War-Time, *Ann. med. int. Fenniae* 36: 748, 1947.
79. Walker, A. R. P., and Arvidsson, U. B.: *J. Clin. Investigation* 33: 1358, 1954.
80. Wanscher, O., Clemmesen, J., and Nielsen, A.: Negative Correlation Between Atherosclerosis and Carcinoma, *Brit. J. Cancer* 5: 172, 1951.
81. White, N. K., Edwards, J. E., and Dry, T. J.: The Relationship of the Degree of Coronary Atherosclerosis with Age in Men, *Circulation* 1: 645, 1950.
82. Wilens, S. L.: Bearing of General Nutritional Status on Atherosclerosis, *Arch. Int. Med.* 79: 130, 1947.
83. Wilens, S. L.: The Absorption of Arterial Atheromatous Deposits in Wasting Disease, *Am. J. Path.* 23: 793, 1947.
84. Wilkinson, C. F., Jr., Blecha, E., and Reimer, A.: Is There a Relation Between Diet and Blood Cholesterol?, *Arch. Int. Med.* 85: 389, 1950.
85. Wilmot, V. A., and Swank, R. L.: The Influence of Low-Fat Diet on Blood Lipid Levels in Health and in Multiple Sclerosis, *Am. J. M. Sci.* 223: 25, 1952.
86. Yater, W. M., Traum, A. H., Brown, W. G., Fitzgerald, R. P., Geisler, M. A., and Wilcox, B. B.: Coronary Disease in Men Eighteen to Thirty-nine Years of Age, *Am. Heart J.* 36: 334, 481, 683, 1948.

## DISCUSSION

*Dr. Glass* commented that population studies involve many variables, of which the diet is only one, and furthermore that the genetic variables render correlations difficult to interpret. Studies of the frequencies of various genes in different racial groups have indicated that the percentages of the genes in one group do not correspond to those in another race or even in other populations of the same race. In order to avoid the effect of genetic variables it would be necessary to conduct the dietary experiments on an adequate number of monozygotic twins, so as to obtain in each pair a control individual and an experimental individual of exactly the same genotype. Although that approach has hitherto appeared to be impracticable, the frequency of monozygotic twins is one in 200 births, and adequate numbers might be made available to the Air Force by the draft. He felt that if the Air Force could sponsor dietary experiments on monozygotic twins, much valuable information would be obtained.

*Dr. Taylor* suggested that *Dr. Anderson* include in his studies the data obtained by *Rosenthal* (*Arch. Path.* 18: 473-506 and 660-698 [Oct. & Nov.] 1934) on the higher incidence of atherosclerosis in the Chicago Negro as compared to that in Chicago whites. The diets of these two groups are discussed by *Rosenthal* (p. 495) and described as being about similar.

*Dr. Stare* emphasized that not only the protein but also the amino acid content of

diets should be compared. In the corn diet of the Bantu, lysine is the limiting factor. In rice diets, lysine and threonine are limiting factors. He also emphasized that the atherogenic diet used with the monkeys must contain an adequate amount of sulfur amino acids to keep the animal eating and to promote growth.

*Dr. Page* emphasized that in applying the conclusions derived from broad population studies to clinical medicine one should keep in mind that individual patients vary markedly in their response to changes in diet. He further cautioned against assuming that the cholesterol level rises uniformly with increasing age.

*Dr. Kellner* pointed out that conclusions as to the effects of metabolic and dietary factors turn upon the method by which the incidence of atherosclerosis in a population is diagnosed. The customary method is to study cases of death from myocardial infarct or degenerative diseases, mainly atherosclerosis of specific localization in the coronary artery. He questioned whether there is any necessary correlation between the influence of dietary and metabolic factors in such strategically located atherosclerosis and in total atherosclerosis. He was unaware of any evidence that an individual with myocardial infarction necessarily would have more total atherosclerosis than an individual of the same age without infarction, or one who had not died from cardiac degenerative disease. His laboratory had just begun to collect data which suggested that individuals after myocardial infarction tend to have a greater incidence of total atherosclerosis, but the evidence was as yet inconclusive.

*Dr. Page* cautioned that in putting a patient on a low-fat diet to avoid atherosclerosis, the change should be made gradually.

## SUMMARY OF PART IV

R. GORDON GOULD

The preceding group of four papers, which have all been concerned with systemic biochemical approaches to the atherosclerosis problem, have almost completely ignored the local tissue factors. This does not mean, however, that biochemists deny the importance of local factors. Perhaps one thing all of us here can agree on is that atherosclerosis is a disease (or group of diseases) of metabolism in which factors in the arteries themselves play a determining role in the localization of the lesions, but in which systemic factors determine whether or not any lesions will be formed. Nutritional considerations are recognized as being among the most important determinants of the systemic factors. Prognostically the localizing factors are often of critical importance, but from the preventive standpoint, the metabolic factors are a more promising field of investigation. I believe that biochemists tend to feel optimistic about the prospects for real progress in atherosclerosis in the near future, based on the possibility of control of the systemic factors.

Dr. Lehninger has stressed the fact that the earliest lesion is of most interest. While there is still no rigorous proof that lipid infiltration is the first event in plaque formation, an increase in lipid concentration from 14% to 26% has been reported to occur during the formation of early plaques, and evidence of any change taking place before lipid infiltration is hard to find. The work Dr. Taylor presented yesterday showed that in rabbits, damage to the artery alone caused a proliferative reaction which was not atheromatous in nature; when cholesterol was fed, deposition occurred both in the normal and in the damaged artery, but in the latter resemblance to the human disease was much closer than in the former. This suggests, although it does not prove, that in the human disease some local damage precedes the lipid deposition. Perhaps only by finding a certain preventive will we be able to prove definitely what the cause really is. It is clear, at least to biochemists, that of the two factors—local damage and plasma lipid abnormality—the latter is more important, since it alone can produce severe atheromatosis in animals, whereas the former alone cannot.

Dr. Lehninger raised the very interesting question whether phagocytes can degrade cholesterol as well as accumulate it. With the methods available now it should certainly be possible to attack this problem experimentally. Chaikoff's group have found that when cholesterol labeled with  $C^{14}$  in the end of the side chain is fed to rats, the rats sacrificed, and their tissues sliced and incubated, recovery of  $C^{14}$  as  $CO_2$  proves oxidation of the cholesterol side chain in a number of tissues. As far as I know they have not studied macrophages.

It was brought out by Dr. Lehninger that lipids depend on the specific proteins with which they are combined to keep them in solution or suspension in the aqueous medium in the body. Diseases characterized by abnormal transport or deposition of lipids may well be due to defects in the proteins involved or in the coupling of the lipids to the proteins. Until very recently it was impossible to study the protein part of the lipoproteins because of the difficulties of purifying the lipoproteins, but rapid progress in this field

seems now to be possible, not only with plasma lipoproteins but also with soluble tissue lipoproteins.

Other aspects in which one may expect important advances are the structure and function of the lipids themselves. One of the greatest handicaps in lipid chemistry has been the difficulty of separating mixtures of closely related compounds. With the advent of all the various types of chromatography and of counter-current distribution, improved methods of isolating pure lipids can be expected. As an example might be mentioned the isolation of the cholesterol ester fraction, in pure crystalline form, by simple chromatographic methods on either alumina or silicic acid. This makes possible an attack on such important problems as the role of cholesterol in the absorption and transport of the essential fatty acids, and the question whether the cholesterol ester fatty acids in atherosclerotic lesions differ from those in normal tissues.

Although the true function of cholesterol is not known at present, the rapidity of appearance of acetate  $C^{14}$  atoms in cholesterol is most impressive; it convinces one that there must be important reasons for the rapid and continuous synthesis of cholesterol which is observed.

The role of acetyl CoA in lipid metabolism was emphasized. By way of summary, it is perhaps worth listing the possible fates of this key intermediate: (a) oxidation to  $CO_2$  via the citric acid cycle, (b) reversible condensation to form fatty acids, (c) irreversible condensation to form sterols, and (d) reversible condensation to form ketone bodies. Fascinating as have been the recent developments in this field, it will be equally as fascinating to learn the mechanisms controlling what fraction of the acetate pool follows each of these pathways. For example, we know that most—perhaps 60 to 80 per cent—of labeled acetate is directly oxidized to carbon dioxide. Only a few per cent are converted into cholesterol, and a somewhat larger but extremely variable fraction into fatty acids. Many factors, including pyruvate and insulin, affect the extent of incorporation of acetate into fatty acids, but little is known about how these effects are mediated. The control of the relative amounts of metabolites following alternative pathways is a field of fundamental biochemical and physiological importance.

Isotopically labeled cholesterol can be used to determine the pathways of dietary cholesterol in the body including its absorption, appearance in blood and tissues, and its catabolic pathways. By far the largest fraction is converted into bile acids and eventually excreted in feces.

Isotopically labeled precursors of cholesterol can be used to study cholesterol synthesis in liver and extrahepatic tissues and the movement of newly synthesized cholesterol from one tissue to another. In view of the interest which has been shown in the question whether the aorta itself synthesizes cholesterol, a few words might be added at this time. In the first place, the question itself does not appear to be of practical importance because of the overwhelming mass of evidence indicating that the cholesterol which accumulates in atherosclerotic arteries is derived from plasma. However, it is of theoretic interest. Chaikoff and associates have reported that chicken and rabbit aorta are capable of cholesterol synthesis *in vitro*. Several years ago we found that dog aorta *in vitro* was capable of oxidizing acetate to carbon dioxide and of converting it into fatty acids but not into cholesterol. Very recently using intact animals, injecting acetate intravenously and sacrificing 30 minutes later (to prevent movement of labeled cholesterol molecules from one tissue to another), we have found an appreciable rate of synthesis in chicken

aorta, but only a negligible rate in rats. Thus, the answer to the question seems to be that some species do and some do not, a common if unsatisfactory state of affairs.

Perhaps the key to the problem of atherogenesis lies in the homeostatic control of the plasma cholesterol level and the distribution of cholesterol between alpha and beta lipoproteins. Little can be said about these mechanisms at present but it may be useful to recognize two types; 1) the distribution of cholesterol between liver and plasma, and 2) the cholesterol concentration and rate of synthesis in liver and the equilibrium between free and esterified forms in liver. The first appears to be of primary importance. A variety of deviations from the normal state have been described; for example, in hypothyroidism we find marked hypercholesterolemia, a normal liver concentration, and a decreased rate of synthesis, whereas in the cholesterol-fed rat we find a greatly increased liver cholesterol ester concentration, a decreased rate of synthesis, and only slightly increased levels in the liver free and plasma fractions.

Nutritional aspects of atherosclerosis have been thoroughly covered by Drs. Mann and Anderson. They are in agreement that a low fat diet is at present the most promising approach to the prevention of atherosclerosis. It seems to be well established that low fat diets are more effective than low cholesterol diets in lowering serum cholesterol and such related functions as the ratio of cholesterol in beta to that in alpha lipoproteins, the levels of the various  $S_r$  lipoprotein classes, and the "atherogenic index." Dr. Mann pointed out that a diet containing less than 50 gm. of fat per day is not only unpalatable but nutritionally unsound. However, if the fat intake is kept between 50 and 100 gm., or better between 50 and 70 gm. per day, an appreciable decrease in plasma cholesterol will be observed. In spite of the correlation which has been observed by Dr. Anderson and Dr. Keys, and also by others, between low fat diets and relative freedom from atherosclerosis in population groups in Europe, Africa, and Asia, there is not yet any proof that a deliberate change in diet will prevent the development of the disease in Americans. No doubt studies along these lines are now under way, but it will take some years to obtain a definite answer.

The many differences between species in regard to the metabolism of sterols and other lipids and in the development of atherosclerosis have been stressed by several speakers. Although discouraging from the standpoint of applying the results of animal experiments to humans, these differences can and should be taken advantage of in learning more about basic mechanisms, in the same way that differences between normal and disease states have been used for this purpose.

One of the most baffling differences is the observation that experimental atherosclerosis in all animal species can only be produced by cholesterol feeding—fat alone is not sufficient—whereas in humans dietary cholesterol is now considered to be of relatively little importance. A high fat diet alone is considered responsible for a high plasma cholesterol level and the gradual development of atherosclerosis. The way in which dietary fat influences cholesterol metabolism is not understood, and constitutes a particularly important field for future work.

It is known that man is much more efficient in maintaining a constant plasma cholesterol level when large amounts of cholesterol are ingested than most, if not all, other species. Messinger and associates fed patients a diet containing 30 gm. of cholesterol and 90 gm. of fat daily for 29 days with no significant increase in plasma cholesterol level.

What happened to all this cholesterol? Was it entirely unabsorbed, was it partially absorbed and stored in esterified form in the liver as in the rat, or was it destroyed?

Other species differences include the effect of estrogens, which prevent coronary atherosclerosis in chickens, as Drs. Katz and Stamler have shown, but apparently accentuate it in rabbits. Their effectiveness in humans is now under investigation; estrogens certainly do not constitute an ideal form of therapy, especially in males, because of side effects, but may lead the way to better therapeutic agents.

Both Dr. Mann and Dr. Anderson demonstrated a good scientific attitude of scepticism towards a number of commonly accepted, often-quoted but not rigorously proved beliefs. Dr. Anderson questioned whether there really is a correlation between obesity and atherosclerosis or hyperlipemia. Dr. Mann pointed out that regulated diabetes is not characterized by hypercholesterolemia or hyperlipemia, so that the widely prevalent vascular disease associated with diabetes cannot simply be attributed to hypercholesterolemia. The commonly accepted correlation between hypothyroidism and atherosclerosis also rests on little evidence, according to Dr. Mann, and should be critically re-examined and re-investigated.

In conclusion, I would like to mention with enthusiasm the recent work on elastase presented by Dr. Lansing yesterday. This enzyme gives promise of providing a fresh and interesting approach to atherosclerosis, and should stimulate interest in the much-neglected field of the metabolism of arterial tissue.





## PART V

---

### EXTRACELLULAR LIPOPROTEINS

DOUGLAS M. SURGENOR

The term lipoprotein describes a class of conjugated proteins. By the usual criteria, such as solubility in water and salt solutions, amphoteric behavior, and size and shape, they are typical proteins. Yet they may contain in a bound state, as an integral part of their structure, relatively large amounts of fatty substances which in the free state are quite hydrophobic and soluble only in organic solvents.

#### *Isolation and Distribution*

Fractionation of large pools of normal plasma yields two distinct groups of lipoproteins which together account for approximately 90% of the total plasma lipid (estimated as cholesterol).<sup>1, 2</sup> Called  $\alpha$ - and  $\beta$ -lipoproteins because of their electrophoretic mobilities, they separate into different fractions, thus reflecting different solubility characteristics. In their physical properties and composition, some of which are summarized in table I, they are also quite dissimilar.

In the fractionation process, the  $\beta$ -lipoprotein is readily concentrated into a fraction in which it comprises about one third of the total protein. Attempts to purify it further by chemical means have thus far been unsuccessful because of the similarity in solubility properties of the various components of the fraction. Highly purified preparations have therefore been obtained by a final purification of the crude fraction in the preparative ultracentrifuge.<sup>3</sup> The purified  $\alpha$ -lipoprotein was obtained by chemical means, although the preparations were far less satisfactory, and therefore the characterization less reliable than was achieved in the case of the  $\beta$ -lipoprotein.<sup>4</sup>

The 10% of the plasma cholesterol not associated with the major lipoproteins can be largely accounted for in other fractions. These include: (a) The cholesterol-bearing protein which is found in eluates from barium sulfate, used in the isolation of prothrombin from plasma. This accounts for only 1% of the plasma cholesterol, but appears as a distinct fraction.<sup>5</sup> (b) Approximately 3% of the plasma cholesterol is found in the gamma globulin fraction. The high ratio of cholesterol to phospholipid suggests that this does not represent contamination by the  $\beta$ -lipoprotein.<sup>6</sup> (c) A further small amount of cholesterol is found in the residues following extraction of the  $\beta$ -lipoprotein. This has not been characterized.<sup>6</sup>

The fractionation studies, made on large pools of normal human plasma collected and processed without respect to age and sex, thus reveal a spectrum of lipoproteins which differ widely in amount, in physical and chemical properties, in lipid content, and probably also in physiological function. Just as it is difficult, if not impossible, to elucidate the mechanism of blood coagulation by studying whole plasma, it is obvious that a basic understanding of lipid metabolism and of the physiological roles of the various lipoproteins must come through the study of the isolated components and of their various interactions. The beginnings of such a study have already been made, notably by Barr

TABLE I  
COMPOSITION AND PROPERTIES OF MAJOR LIPOPROTEINS OF HUMAN PLASMA\*

	Alpha	Beta
Per cent of plasma proteins.....	3	5
Per cent of plasma cholesterol.....	28	63
Molecular weight (anhydrous).....	$0.2 \times 10^6$	$1.3 \times 10^6$
Size.....	$50 \times 300\text{\AA}$	185 $\text{\AA}$ (sphere)
Water of hydration: gm./gm. dry prot.....	0.2	0.6
Intrinsic viscosity.....	0.066	0.041
Hydrated density.....	1.16	1.032
<i>Lipid in gm./100 gm. lipoprotein:</i>		
Unesterified cholesterol.....	3.3	8.3
Cholesterol esters.....	15.0	39.1
Phospholipids.....	21.0	29.3
Carotenoids.....	0	0.03
Estriol.....	0	(0.001)
	39.3	76.7
Total lipids.....	60	23
Protein moiety.....		
<i>Mole Ratios:</i>		
<u>Free cholesterol</u> .....	0.27	0.27
<u>Total cholesterol</u>		
<u>Cholesterol</u> .....	1.3	2.1
<u>Phospholipid</u>		
<u>Cholesterol</u> .....	0.053	0.28
<u>Nitrogen</u>		

\* Data taken from Refs: 1-4, 6, 18.

and his associates in New York,<sup>7, 8, 9</sup> by Lever and his associates in Boston,<sup>10, 11, 12</sup> and by the group at the National Heart Institute under Anfinsen.<sup>13, 14</sup> Barr, Lever, and their coworkers have taken advantage of a simple separation of plasma proteins into fractions, two of which contain the  $\alpha$ - and  $\beta$ -lipoproteins respectively.<sup>15</sup> They have thus been able to accumulate rather complete data concerning the lipid distribution in these two major compartments in normal individuals and in a wide variety of pathological states, using as little as 5 ml. of plasma.

The procedure employed for the above analytical fractionation of plasma has been called Method 10, and involves the use of relatively simple standard reagents. However, the use of ethanol in the process requires that all separations be carried out at  $-5^{\circ}\text{C}$ . This requirement has apparently constituted a serious deterrent to the use of analytical fractionation in general clinical laboratories. It is hoped that a new analytical procedure, now under study, will simplify the requirements for equipment and allow more general use of the method. The new procedure is based on a modification of the more recent fractionation methods which take advantage of metal-protein interactions in aqueous systems at  $0-3^{\circ}\text{C}$ . The elimination of ethanol circumvents the need for subzero temperatures and results in great simplification.<sup>16</sup>

The import of the results obtained in the fractionation studies is discussed elsewhere

in this symposium by Eder. Suffice it to say, however, that they reveal a striking constancy in the levels of  $\alpha$ -lipoprotein, even in diseases characterized by marked hyperlipemia. Conversely, variations in lipid content are reflected almost quantitatively in the amount of lipid in the  $\beta$ -lipoprotein compartment. These and other findings tend to exclude the  $\alpha$ -lipoprotein, and probably also the trace lipoprotein components, from an important role in diseases of lipid transport or metabolism; indeed, the physiological functions of these lipoprotein components remain completely obscure.

### *$\beta$ -Lipoproteins*

The purified preparations of  $\beta$ -lipoprotein obtained from large pools of plasma contain a single main component electrophoretically and in the analytical ultracentrifuge. However, the main peak exhibits considerable boundary spreading when solutions of the lipoprotein in solvents of density near that of the protein are analyzed in the ultracentrifuge. This suggests the likelihood that the  $\beta$ -lipoprotein is not homogeneous, but rather that the preparations studied consisted of a series of molecules of similar but not identical physical properties, not unlike the gamma globulin antibodies.

Strong evidence for the existence of several discrete components in highly purified  $\beta$ -lipoprotein preparations has been found from study of the rabbit antisera to such preparations.<sup>17</sup> The antigens used were essentially free of contamination by gamma globulins, albumin, and the  $\beta_1$  metal-combining globulin. These studies revealed as many as five or six components in purified  $\beta$ -lipoprotein, including indication of an immunochemical relationship of these components with a lipid-poor  $\beta_1$ -globulin component of Fraction III.<sup>2</sup> These results are consistent with the ultracentrifugal findings which suggest the existence of several related  $\beta$ -lipoprotein components.

The preponderance of lipids over protein in the  $\beta$ -lipoproteins results in a unique property; the density of the hydrated molecule is about 1.032, compared with densities of 1.33–1.34 for most plasma proteins.<sup>18</sup> This unusual density was first noted by Pedersen.<sup>19</sup> On increasing the density of the solvent by the addition of magnesium sulfate, Pedersen achieved conditions in which the  $\beta$ -lipoprotein sedimentation rate was extremely slow while the sedimentation rates of the other plasma proteins remained essentially unchanged. Recently Gofman, Lindgren, and Elliott<sup>20</sup> have used solvents of even higher density with the result that the  $\beta$ -lipoproteins (and other less dense lipoproteins) actually sediment upwards (or float toward the meniscus) in the centrifugal field. In a solvent of given density (usually 1.063) the rate of upward sedimentation is described by a "flotation constant" ( $S_f$ ) in contrast with the usual sedimentation constant. Introduction of this technique overcame several practical and theoretical obstacles to the ultracentrifugal analysis of these lipoproteins.

The Berkeley group have applied this method to the ultracentrifugal study of whole plasma.<sup>21, 22</sup> In the high density medium, they have observed, in addition to components with the expected physical behavior of  $\beta$ -lipoproteins, a new series of components, most of which have flotation rates ( $S_f$  constants) greater than the chemically isolated  $\beta$ -lipoproteins, suggesting that the densities of these new components can be as low as 0.96. It is difficult to evaluate the relationships between this new series and the lipoproteins isolated from pooled plasma. Unfortunately, only fragmentary chemical data have been published by the Berkeley group. Making use of these, Oncley and Gurd<sup>6</sup> have made the following tentative identifications. The component designated  $S_f = 2$  resembles the

lipoprotein of Green, Lewis, and Page.<sup>23</sup> Although the Cleveland group have found the chemical composition of this component to be very similar to that of the  $\beta$ -lipoprotein, the  $S_f = 2$ , and indeed the  $D = 1.07$  and  $D = 1.12$  components of Gofman and coworkers are not found in lipoprotein preparations isolated from fresh plasma by the chemical methods. The  $S_f = 4$  and  $S_f = 6$  components have physical and chemical properties within the range found for the isolated  $\beta$ -lipoprotein preparations.  $S_f = 6$  to 16 components are also observed in trace quantities in isolated  $\beta$ -lipoprotein preparations.  $S_f = 17$  and higher components were not observed in fractions from large pools of plasma; they were probably excluded in the final ultracentrifugal step of purification. These have been reported by the Berkeley group to contain increasing amounts of triglycerides, probably not in discrete groups. The  $D = 1.07$  component, which sediments in the normal fashion even in the high density medium, somewhat resembles the  $\alpha$ -lipoprotein in molecular weight, but the reported density (1.07) is lower than has been observed for the isolated  $\alpha$ -lipoprotein. Recently, Oncley and Mannick in a detailed study of the physical chemical heterogeneity of  $\beta$ -lipoprotein preparations have found very close agreement in the contents of  $S_f$  components of preparations obtained by the flotation method and by the chemical procedure.<sup>24</sup> These findings thus confirm the validity of the two preparative procedures.

Ultracentrifugal flotation studies of a large number of normal and abnormal plasmas undertaken by the Berkeley group confirm the importance of the  $\beta$ -lipoproteins, and particularly of the  $S_f$  series of components, in relation to lipid transport and metabolism. The  $S_f$  components appear to constitute a series of related states of lipid metabolism, the higher  $S_f$  components being increasingly rich in triglycerides and sensitive to dietary intake of fat and cholesterol.<sup>22</sup> In terms of total plasma cholesterol, the components of  $S_f = 12$  and greater comprise approximately 10% of the total; the bulk of the cholesterol is associated with the  $S_f = 4$  and 6 components, which are also the main components of the  $\beta$ -lipoprotein preparations of Oncley and coworkers.<sup>3</sup> Following a large number of analyses, Gofman and his group have found a tendency to correlation between the amount of certain classes of  $S_f$  components and atherosclerotic states and have referred to various ranges of  $S_f$  components as the "atherosclerogenic band."<sup>25, 26, 27</sup> It now begins to appear, however, that the analytical fractionation procedure, which yields a  $\beta$ -lipoprotein fraction that includes the whole range of flotation components, may provide the simplest index of predisposition to or actual existence of atherosclerotic lesions.

#### *$\beta$ -Lipoprotein Structure*

Although the analytical studies are suggestive of a relationship between  $\beta$ -lipoproteins and certain disease states, very little light has yet been shed on the abnormal mechanisms which may be responsible. From the chemical viewpoint, we would like to know as much as possible of the structure of this bizarre group of proteins, and of the nature of the chemical interactions by which they load and unload fatty substances. The work of Oncley,<sup>6</sup> Macheboeuf,<sup>28</sup> and others affords a limited estimate of the structure. The data in table I emphasize the preponderance of lipids over the protein part of the molecule. To aid in visualizing the structure of the molecule, these data have been converted to volume fractions, and expressed diagrammatically in figure 1, which is taken from Oncley.<sup>29</sup> In so doing, the water content has also been included. The latter has been estimated to be about 0.6 gm. of water per gm. of dry protein, or 44,000 moles of water per mole

of lipoprotein. The water is thus a major component (ca. 39%) of the molecule as it circulates in the blood stream; its importance structurally is suggested by the sensitivity of the lipoprotein to freezing or drying, both of which produce irreversible changes in the molecule. Furthermore, the water must be involved in the bonding of the lipids, as indicated by the changes in extractability of the lipids which take place when the physical state of the water is altered.

As we have already noted, the physical data indicate that the  $\beta$ -lipoprotein is a spherical molecule, and the solubility data are those of a typical euglobulin; the characteristic lipid properties are completely lacking. This at once suggests a structure in which the outermost aspects of the molecule are those of the protein moiety. However, even if the

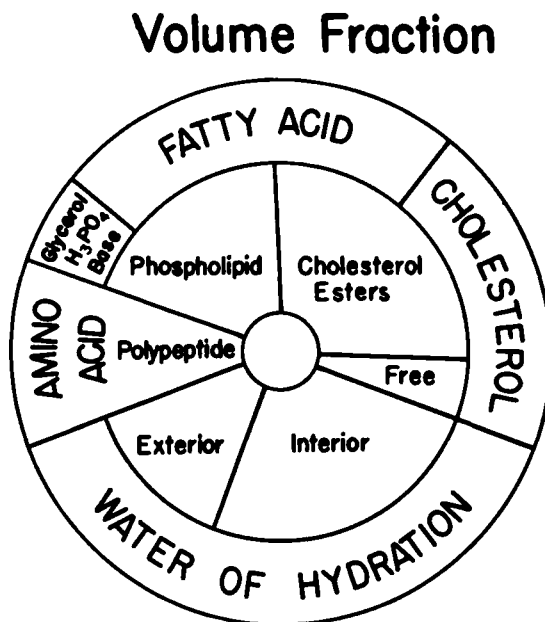

FIG. 1.—Composition of  $\beta$ -lipoprotein in volume fractions (based on data from table I).

protein be spread in a layer at the periphery in a thickness of one peptide chain, there is only enough to cover about half the surface. If the charged groups of the phospholipids, mainly quaternary ammonium and phosphate groups, are also included, then the total number of charged groups is approximately doubled. That these are available is indicated by titration data. Largely on this evidence, Oncley has postulated a kind of mosaic surface comprising both peptide and phospholipids, the latter oriented predominantly with their charged groups at the surface.<sup>3</sup>

Such an orientation assumes an internal structure consisting primarily of water and lipids, a combination not seemingly compatible. Oncley and others have called attention to the existence of a number of remarkable complexes which can exist in the solid state between urea and aliphatic hydrocarbons and between water and certain normally incompatible substances. In the crystal structure of such compounds as water and urea there are well defined void spaces which can act as receptor sites for substances with the proper

molecular dimensions. Because of the possibility of van der Waals attractions with the matrix compound, the resulting structures can be quite stable.

These postulates concerning the structure of the  $\beta$ -lipoprotein would all be consistent with one of the most distinctive characteristics of proteins—their great internal rigidity. Unlike most high molecular weight polymers, the proteins, by virtue of a large number of internal bonds, are remarkably rigid molecules. The huge number of possible steric configurations and the specificity of natural interactions derive to no small extent from the internal rigidity of the proteins.

#### *Interactions*

Two characteristics of the atherosclerotic lesion have been repeatedly stressed. These are the nonuniform occurrence of the lesion and its fatty nature. When these are linked with the simultaneous finding of an abnormal plasma lipoprotein pattern, the suggestion of a defect in lipid transport or metabolism has emerged. The presence of fatty substances in the lesion might be due either to deposition from a lipoprotein (of plasma or tissue) or to a failure in a normal process of removal of such lipids. In addition, some specific factor, probably not in the plasma, must be assumed to explain the spotty distribution of the lesion.

In short, the inference is strong that a biochemical lesion occurs in the mechanism by which the lipoproteins load or unload their lipids. Since there are several discrete lipid components, there could obviously be more than one mechanism; indeed, the uptake and release of each component might be controlled by separate mechanisms. Two types of controls immediately suggest themselves, the one enzymatic and the other physical. Unfortunately, there is still only fragmentary evidence of the possible importance of either mechanism in diseases associated with hyperlipemia; nevertheless, they merit serious consideration.

Enzymatic mechanisms are attractive to postulate because they are compatible with specificity, and at times make possible interactions otherwise slow or difficult to carry out under physiological conditions. Only two reactions of this type have been reported. Petermann, using a crude culture filtrate of *Clostridium perfringens*, produced rather deep-seated changes in  $\beta$ -lipoprotein which were accompanied by loss of lipids and nitrogen with only slight release of phosphorus.<sup>30</sup> This observation has not been pursued. The other enzymatically controlled interaction is that of the clearing reaction, discussed fully elsewhere.<sup>14</sup>

Although enzymatic mechanisms may thus be involved, physical chemical forces, such as are observed in the mass action effect, can undoubtedly suffice to control uptake and release of lipids by the lipoproteins. The work of Gould has revealed the labile equilibria with respect to cholesterol which exist between the plasma lipoproteins and those of the red cell membrane, not apparently controlled by enzymes.<sup>31</sup> In a number of important studies,<sup>28</sup> Macheboeuf was able to displace lipids from lipoproteins, often quite specifically, by taking advantage of the mass action principle, with substances sterically related to the lipids in the protein.

Many other natural interactions apparently proceed without the intervention of enzymes, and often are susceptible to reversal under mild conditions by physical or chemical forces. These include the well known binding of many types of small ions and mole-

cules by human albumin, the formation of the antigen-antibody complex, and the interaction of iron with the iron-binding protein, to cite but a few examples.

Because of their unique composition, the lipoproteins—particularly the  $\beta$  group—are susceptible to still another kind of reaction, that of oxidation. This is manifested in several ways. One of the most rapid effects is the destruction of the carotenoid pigments, which results in a decrease in light absorption in the visible wave lengths and an increase in the ultraviolet. Oxidative changes, probably in the unsaturated fatty acids, are responsible for increased densities, with concomitant increases in sedimentation rates in high-density media. Oxidation also results in an increase in negatively charged groups at neutral pH, with a resulting increase in electrophoretic mobility. The latter is observed even in whole plasma, during paper electrophoresis; it is minimized by excluding oxygen during the experiment.<sup>32</sup> Oxidative degradation markedly decreases the solubility of  $\alpha$ -lipoproteins,<sup>4</sup> but does not appear to affect  $\beta$ -lipoprotein solubility.

The lipoproteins thus far studied appear to be less stable in the isolated state than in whole plasma. This may be due, at least in part, to the removal, during purification, of plasma components which exert protective or antioxidant effects on the lipoproteins. The existence of one such factor that is dialyzable has been reported.<sup>33</sup> Attempts are now being made to purify the lipoproteins by avoiding exposure to oxygen. The inclusion of antioxidants during processing has not thus far yielded favorable results.

The peculiar contrast of constituents which occur in the lipoproteins confers an inherent fragility and renders them highly susceptible to abnormalities. All of these possible chemical interactions of the lipoproteins must be further investigated; none can be excluded from consideration at the present time.

#### REFERENCES

1. Cohn, E. J., Strong, L. E., Hughes, W. L., Jr., Mulford, D. J., Ashworth, J. N., Melin, M., and Taylor, H. L.: *J. Am. Chem. Soc.* 68: 459, 1946.
2. Oncley, J. L., Melin, M., Richert, D. A., Cameron, J. W., and Bross, P. M., Jr.: *ibid.* 71: 541, 1949.
3. Oncley, J. L., Gurd, F. R. N., and Melin, M.: *ibid.* 72: 458, 1950.
4. Cohn, E. J., Strong, L. E., and Blanchard, M.: Unpublished observations.
5. Surgenor, D. M., Alexander, B., Goldstein, R., and Schmid, K.: *J. Phys. & Colloid Chem.* 55: 98, 1951.
6. Oncley, J. L., and Gurd, F. R. N.: in *Blood Cells and Plasma Proteins*, edited by J. L. Tullis, New York, Academic Press, 1953, pp. 337-357.
7. Barr, D. P., Russ, E. M., and Eder, H. A.: *ibid.* pp. 382-391.
8. Russ, E. M., Eder, H. A., and Barr, D. P.: *Am. J. Med.* 11: 468, 1951.
9. Barr, D. P., Russ, E. M., and Eder, H. A.: *ibid.* 11: 480, 1951.
10. Lever, W. F., and Hurley, W. A.: *Blood Cells and Plasma Proteins*, edited by J. L. Tullis, New York, Academic Press, 1953, pp. 392-403.
11. Lever, W. F., Gurd, F. R. N., Uroma, E., Brown, R. K., Barnes, B. A., Schmid, K., and Schultz, E. L.: *J. Clin. Investigation* 30: 99, 1951.
12. Lever, W. F., Schultz, E. L., and Hurley, N. A.: *Arch. Dermat. & Syph.* 63: 702, 1951.
13. Anfinson, C. B., Boyle, E., and Brown, R. K.: *Science* 115: 583, 1952.
14. Anfinson, C. B.: This symposium.
15. Cohn, E. J., Gurd, F. R. N., Surgenor, D. M., Barnes, B. A., Brown, R. K., Derouaux, G., Gillespie, J. M., Kahnt, F. W., Lever, W. F., Liu, C. H., Mittelman, D., Mouton, R. F., Schmid, K., and Uroma, E.: *J. Am. Chem. Soc.* 72: 465, 1950.
16. Surgenor, D. M., Mannick, V., and Kramer, R.: 5<sup>th</sup> International Congress of Blood Transfusion, Paris, Sept. 13-19, 1954.

17. Gitlin, D.: *Science* 117: 591, 1953.
18. Oncley, J. L., Scatchard, G., and Brown, A.: *J. Phys. & Colloid Chem.* 51: 184, 1947.
19. Pedersen, K. O.: *Ultracentrifugal Studies on Serum and Serum Proteins*, Uppsala, Almquist and Wiksells, 1945.
20. Gofman, J. W., Lindgren, F. T., and Elliott, H. A.: *J. Biol. Chem.* 179: 973, 1949.
21. Lindgren, F. T., Elliott, H. A., and Gofman, J. W.: *J. Phys. & Colloid Chem.* 55: 98, 1951.
22. Jones, H. B., Gofman, J. W., Lindgren, F. T., Lyon, T. P., Graham, D. M., Strisower, B., and Nichols, A. J.: *Am. J. Med.* 11: 358, 1951.
23. Green, A. A., Lewis, L. A., and Page, I. H.: *Fed. Proc.* 10: 191, 1951.
24. Oncley, J. L., and Mannick, V.: 5<sup>th</sup> International Congress of Blood Transfusion, Paris, Sept. 13-19, 1954.
25. Gofman, J. W., Jones, H. B., Lindgren, F. T., Lyon, T. P., Elliott, H. A., and Strisower, B.: *Circulation* 2: 161, 1950.
26. Gofman, J. W.: *Advances Biol. & Med. Physics* 2: 269, 1951.
27. Gofman, J. W., Jones, H. B., Lyon, T. P., Lindgren, F. T., Strisower, B., Coleman, D., and Herring, V.: *Circulation* 5: 119, 1952.
28. Macheboeuf, M.: *Blood Cells and Plasma Proteins*, edited by J. L. Tullis, New York, Academic Press, 1953, pp. 358-377.
29. Oncley, J. L., and Gurd, F. R. N.: Unpublished data.
30. Petermann, H. L.: *J. Biol. Chem.* 162: 37, 1946.
31. Gould, R. G.: *Am. J. Med.* 11: 209, 1951.
32. Russ, E. M.: Personal communication.
33. Ray, B. R., Davisson, E. O., and Crespi, H. O.: *J. Am. Chem. Soc.* 74: 5807, 1952.

## DISCUSSION

*Dr. Schmitt* agreed with *Dr. Surgenor's* hypothesis that the nonpolar residues of a protein may interact with the nonpolar residues of a lipid. Although a lipid-protein complex is usually visualized as a linkage of polar end to polar end, this may not be true in the case of certain lipids, especially those rich in steroids. Following *Langmuir's* suggestion it has recently been shown that the nonpolar-nonpolar interaction, when integrated over all of the available chains of a fatty acid, can be very strong, but can be rapidly interrupted by a nonpolar solvent.

In reply to a question by *Dr. Page* as to how cholesterol combines, he was of the opinion that it could combine in a planar fashion, although not strictly planar as the term is used in crystallography. It is conceivable that cholesterol can overlay the surface of the protein layer, in view of the fact that *Sobotka* has shown that it spreads in that manner in monolayers.

*Dr. Gould* suggested that the choleic acids might serve as useful models in investigating the structure of lipoproteins. Desoxycholic acid, like the protein component in plasma lipoproteins, is able to combine with cholesterol and cholesterol esters to form water-soluble complexes. Although, structurally, desoxycholic acid appears to have nothing in common with a polypeptide chain, the spatial arrangement of nonpolar groups capable of interacting with nonpolar groups in sterols may be similar and may provide a lead in the experimental attack on this difficult problem.

*Dr. Page* asked whether *Dr. Gould* conceived the choleic principle to be limited to choleic acid and bile salts, or whether it had a broader application.

*Dr. Gould* replied that it is by no means a general property even of bile acids, but is limited to desoxycholic and apocholic acids. (The latter is desoxycholic acid with a double bond in the 8-14 position.) It is only a better understanding of the choleic acid principle which might have a broader application. In fact, it is the high degree of speci-



ficacy of this effect, together with the observation that the lipid properties of lipids present in choleic acids are completely masked (just as are those in beta lipoproteins), which suggests that a reinvestigation of the structure of choleic acid by modern physicochemical methods would certainly be interesting and might well be rewarding in connection with lipoprotein structure.

*Dr. Surgenor* suggested a similar analogy in the combination of urea with hydrocarbons. The urea crystallizes and apparently leaves a hole into which the hydrocarbons fit, under the influence of van der Waals forces.

*Lt. Batchelor* cited observations on the role of fatty acid in the crystallization of serum albumin, recently extended by Dintzis. Reversible elimination of the fatty acid using ion exchange is accompanied by a reversible loss of crystallizability. He had also found that the molecular size and shape is determined by the presence or absence of the fatty acid. When he removed all the fatty acid from the albumin by ion exchange at neutral pH he obtained a molecule that could not be crystallized. Upon reintroducing fatty acid into the system, one-half mole per mole of albumin, he obtained a 50% yield of crystals. When he put back one molecule of fatty acid he obtained practically a 100% yield of crystals.

*Dr. Lehninger* suggested that the beta lipoprotein actually isolated may in reality be a building block of a vast number of proteins of larger size, and that the isolation procedure may break down a number of bonds and reduce the substance to a common denominator.

*Dr. Glass* asked whether the presence of lipid on the surface of the molecule protects it against the action of enzymes, such as carboxypeptidase, that attack protein molecules by splitting off amino acid end groups.

*Dr. Surgenor* replied that this had not been studied, but would be interesting to ascertain.

In reply to questions, he was unwilling to speculate as to whether protein in which the lipid had been removed from its surface by the cold method was undenatured.

It was the consensus that when lipid is removed from lipoproteins it can not be put back again.

## LIPOPROTEINS IN THE ARTERIAL WALL

LT. WILLIAM H. BATCHELOR, (MC) USNR\*

These studies were initiated to illuminate certain observations made in the study of artery grafting. The dog appears to tolerate a grafted segment in the repair of an aortic defect better if the segment is first prepared by drying from the frozen state with subsequent reconstitution in water. Comparing the responses to fresh and to dried segments, the difference is slight if the graft segments have been obtained from the same species,<sup>1</sup> but it is striking if they have been obtained from the pig.<sup>2</sup> An attempt has been made to look for effects of drying on arterial proteins that might give some clue to this difference.

The inquiry was limited to those proteins readily soluble in dilute salt solutions at neutral pH, a decision based upon considerations largely contingent, and one open to several objections. This solubility group may be expected to include plasma proteins, probably present as contaminants, and to include little else. It may be of interest to this gathering, however, to characterize briefly the proteins actually isolated from artery, purposely starting from the trivial position that these may be nothing but plasma, and examining those findings that point away from that position. A second purpose is to call attention to the potential usefulness of protein interactions with zinc ion and of drying from the frozen state in the study of arterial lipoproteins.

Artery extracts were prepared from rinsed segments fragmented with mortar and pestle. The extraction conditions were such that the net effect approaches that obtained using neutral buffered isotonic salt solution (see Appendix for details). The extracts were analyzed for protein, cholesterol, and lipid phosphorus. Representative findings are tabulated below, supplemented by lipid data from organic solvent extractions of dried tissue, taken in part from the literature as noted.

The aqueous extract of fresh dog aorta could not be distinguished from dog plasma by the characteristics here studied (table I, entry 1). Referring to Dr. Eder's studies, his corresponding figures for dog plasma would be: 0.2 milligram of cholesterol accompanying 10 milligrams of protein (assuming a protein content of 70 grams per liter), and a cholesterol/lipid phosphorus mole ratio of 0.8. (See table, note a, on interconversion of units.) This suggested similarity to plasma proteins was extended in studies of zinc ion interactions, and of histochemical studies before and after drying from the frozen state. The zinc ion interactions will be considered in the discussion of human arteries below. The findings after drying from the frozen state comprise the remainder of this section dealing with dog artery.

The second entry in the table contrasts the proteins extracted after drying from the frozen state with those obtained from fresh artery as described in entry 1. Although the protein yield from the dried artery remains comparable, the cholesterol yield is lower by a factor of ten, with a similar change in phospholipid yield. The histologic finding, also peculiar to the dried artery, is shown in figure 1. This section was taken from an artery previously dried from the frozen state and stained with Sudan III. Certain characteristics of these deposits support the belief that they represent the lipid extractable in aque-

\* The opinions and conclusions expressed in this paper are those of the author, and are not to be construed as official or necessarily reflecting those of the Medical Department of the United States Navy, or of the Naval Service at large.

TABLE I  
LIPID CONTENT OF ARTERIES AND OF AQUEOUS EXTRACTS OF ARTERIES

No.	Source	Solvent	Protein	Cholesterol	Chol./ Lip. P Mole Ratio <sup>a</sup>
1	Fresh dog artery	Water	10 mg <sup>b</sup>	0.23 mg <sup>b</sup>	0.8
2	Dog artery, freeze-dried	Water	14	0.02	2
3	Dog artery, freeze-dried	Ether	(0)	0.8	0.5
4	Bovine artery <sup>c</sup>	(Mixed organic)	(0)	0.9	0.5
5a	Human artery, flexible	Water	O.D. = 10	0.63 <sup>d</sup>	1.7
5b	Diluted plasma	—	O.D. = 10	0.3 <sup>d</sup>	1.7
6	Human arteries, normal <sup>c</sup>	(Mixed organic)	(0)	3.1	1.2
7	Human arteries, sclerotic <sup>c</sup>	(Mixed organic)	(0)	7-40	2-6
8	Human artery, sclerotic	Water	O.D. = 10		3.5

<sup>a</sup> In comparing these figures with those presented by Dr. Eder, the difference in units used in reporting the ratio of cholesterol to lipid phosphorus must be taken into account. The mole ratio here used yields a value close to *twice* the weight ratio used by Dr. Eder.

<sup>b</sup> Results are expressed as milligrams per gram of wet tissue unless specified otherwise.

<sup>c</sup> Recalculated from the data of Redmond *et al.*<sup>3</sup>

<sup>d</sup> Cholesterol figures in 5a and 5b are expressed as milligrams per milliliter of solution. The optical density at 280  $m\mu$  was first adjusted to 10 in the attempt to achieve comparable protein concentrations.

<sup>e</sup> Recalculated from the data of Buck and Rossiter.<sup>4</sup>

ous solution from fresh but not from the dried artery. The particular characteristics are presence after drying from the frozen state but not before, and irregularity in its distribution, occurring usually near the adventitia and extending toward the intima at branch sites as shown, but allowing more uniform reproduction by the expedient of soaking the dried artery in plasma followed by a second drying from the frozen state. From the combined chemical and histologic observations it appears that the lipid recovered from the fresh dog artery by aqueous extraction may well represent plasma, and its anatomical distribution is consistent with the idea that the plasma was introduced in the course of isolating the artery. The occurrence of fat deposits in the media has consequences for artery grafting, regardless of origin, but for the study of arterial lipids in relation to arteriosclerosis the obvious consideration is simply that this source of arterial lipids be recognized as possible artifact. Comparison of cholesterol yields for entries 1 and 3 in the table shows that this source of cholesterol may represent a significant part of the total.

Turning to studies based upon human material, several findings emerge that give warrant for abandoning the trivial position based on plasma contamination in favor of an explanation based on interactions between artery and plasma proteins occurring in the living animal. This is unequivocal in atheromatous material, but there is a hint from the normal tissue as well. An aqueous protein extract prepared from normal human artery is characterized in entry 5a, a hypothetical plasma in 5b. The cholesterol-lipid phosphorus ratios are comparable (see also Dr. Eder's figures and note a. of this table), but the cholesterol-protein ratio falls well outside of the normal range, being twice that of normal plasma. This finding can be reconciled with the presence of a representative sample of normal plasma lipoproteins, but not of the total plasma proteins. A protein mixture extracted similarly from an atheromatous aorta showed additional properties that set it

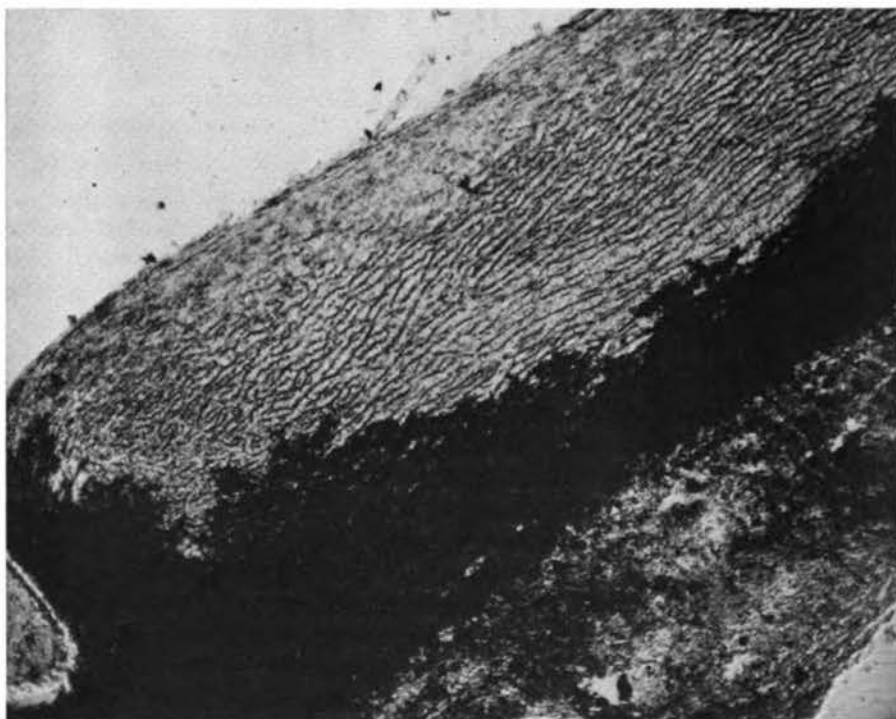

FIG. 1.—Dog aorta, dried from the frozen state, stained for fat; longitudinal section. The vessel lumen lies in the upper left-hand corner. Note the branch represented at the lower left, the fat infiltrating the full thickness of the media in that region, and its restriction to the outer media elsewhere. The thrombus occluding the branch together with the abundant adventitial tissue are the result of implantation for six days. Frozen section of formalin-fixed tissue stained with Sudan III,  $\times 35$ .

apart from normal plasma, one of which is tabulated under entry 8. The cholesterol-lipid phosphorus ratio of 3.5 falls well beyond the range of normal plasma lipoproteins and within the range reported for total lipid extracts of sclerotic arteries, as tabulated in entry 7. Similar data on normal arteries is given in entry 6. A second finding distinctive of the atheromatous specimens presented itself as a peculiarity of solubility in the presence of zinc ions. Briefly, the lipoproteins isolated from atheromatous aortic segments exhibit *high* solubility under conditions such that the lipoproteins of normal plasma appear quite insoluble (See Appendix). Other information on this complex consists of the findings that it accounts for a significant portion of the total abnormal lipid, and that no localization of this material in histologic sections has been achieved on a comparison of frozen sections before and after drying from the frozen state. In addition to technical difficulty, account must be taken of the possibility that this complex does not share the property peculiar to some plasma lipoproteins of release of lipid on drying.

In conclusion, these findings are offered in support of the plausible notion that the study of arterial lipids might advantageously follow the example of plasma lipid chemistry in taking account of the existence of lipids as part of larger molecular complexes. Study of those complexes readily soluble in dilute salt solutions reported here offers little knowledge of the normal artery except to define a significant contamination problem

together with a simple remedy, but offers evidence that a significant part of the abnormal lipid accumulation in atheromatous arteries may be present as a water-soluble complex. Continued study of such material might be called upon to help search for evidence of specificity in the interaction of plasma lipoproteins with the artery, of chemical modification subsequent to lipoprotein sequestration in the artery wall, and of the operation of structural factors in these processes.

#### APPENDIX

It was thought desirable to begin the extraction of components from arterial tissues under starting conditions such that the proteins are initially held insoluble, thus restricting opportunity for altering labile components and permitting closer definition of extraction conditions. Use was made of existing knowledge of zinc ion interactions with proteins,<sup>5, 6</sup> applied as follows. The extraction of proteins soluble in dilute salt solutions was carried out under conditions of temperature near freezing, using M/10 NaCl containing M/100 ethylenediamine tetra-acetate buffered to pH 7.4. The arteries were prepared for this extraction by trimming loose adventitia and by saline washing, followed by fragmentation, reversible protein precipitation, again working in the cold, in the presence of M/100 zinc ion at neutral pH. The use of a mixture of glycinate and acetate of zinc prevents precipitation of zinc hydroxide. The use of zinc solution in proportions of ten times the weight of the artery yielded fairly complete precipitation of proteins as judged by the absence of trichloroacetic acid precipitable material in the supernatant. The finding of abundant protein soluble under these same conditions in atheromatous arteries presented a striking contrast to the normal, but one difficult to explain. The failure of large excesses of zinc ion addition to reduce the solubility would argue against a simple explanation based upon sequestration of the zinc as in soaps.

#### REFERENCES

1. Pate, J. W., and Sawyer, P. N.: *Am. J. Surg.* 86: 3, 1953.
2. Pate, J. W., Sawyer, P. N., Sewell, W. H., and Batchelor, W. H.: Unpublished observations.
3. Redmond, R. F., Milch, L. J., Calhoun, W. W., and Chinn, H. I.: Air University School of Aviation Medicine, Randolph Field, Project 21-32-027.
4. Buck, R. C., and Rossiter, R. J.: *Arch. Path.* 51: 224, 1951.
5. Cohn, E. J., Surgenor, D. M., Schmid, K., Batchelor, W. H., Isliker, H., and Alameri, E.: *Discussions of the Faraday Society*, No. 13, 176, 1953.
6. Alameri, E., and Batchelor, W. H.: Unpublished observations.

#### DISCUSSION

*Dr. Duff*, in reply to a question by Lt. Batchelor, agreed that deposits of the mush from which the name "atheroma" is derived do not occur in normal arteries.

*Dr. Waters* commented that plasma lipoprotein fractions filtered by the vessel wall in vitro could be removed by dissolving them in saline. He added that when precipitated, undenatured human lipoprotein is injected into the wall of a carotid artery or under the skin of an animal it disappears within 24 hours, but that when chylomicrons are injected the lipid is not rapidly removed.

*Dr. Eder* noted that Lt. Batchelor had obtained a rather high cholesterol-phospholipid ratio in the arteriosclerotic vessel, and suggested that beta lipoprotein, which has a higher cholesterol-phospholipid ratio than plasma, may enter the wall of the vessel selectively.

*Lt. Batchelor* agreed that this was a possible interpretation but suggested that the high solubility in the presence of zinc argued against it.

*Dr. Anfinsen* pointed out that during storage of pooled samples a slow lipolysis may produce fatty acids, and raised the question whether the zinc method depended upon the presence of fatty acids.

*Lt. Batchelor* agreed that it is reasonable to look for zinc-lipid interactions as a basis for the sensitivity of lipoproteins to this ion, but pointed out that these interactions were worked out with freshly collected blood and not with stored material.

*Dr. Lehninger* commented that in earlier studies, in which the plaque-lipid deposit was considered to be similar in composition to the plasma lipids, attention was focused on the lipids *per se*. The concept was now developing that the *lipoproteins* go through intact, and he felt it possible that during atherogenesis mechanisms may develop which unload the lipid from the lipoprotein. He considered *Lt. Batchelor's* approach to be a very important one.

Regarding the suggested procedure of using an immunochemical method to identify the protein in the extracts, he asked whether the antigenicity and specificity would be sharp enough.

*Lt. Batchelor* replied that considerable progress had been made by *Gitlin* in the immunochemical characterization of beta lipoprotein, making use of the technique of *Oudin* using gelatin-supported antibody.

In spite of its lack of specificity, he considered that the technique is sensitive and worthy of trial on the extracts under consideration.

*Col. Milch* commented that when an aorta is set up in an organ culture on a pump and is perfused with bovine blood diluted 50 per cent with *White's* solution, the aorta will concentrate cholesterol in its wall. Analysis of organ cultures obtained by *Dr. N. T. Werthessen* at the Southwest Institute revealed no decrease in the lipoprotein concentration of the perfusate.

*Lt. Batchelor* stressed the position that the lipid demonstrated histologically after freeze-drying probably arises in the course of removing the vessel, but suggested that a comparison of arteriosclerotic lesions before and after freeze-drying might permit detection of certain lipoproteins in these lesions.

## PHYSIOLOGICAL ASPECTS OF LIPID TRANSPORT\*

CHRISTIAN B. ANFINSEN

The atheromatous lesion is characterized by its abnormally high content of lipid substances, including cholesterol present as crystalline deposits. This histochemical observation in conjunction with numerous nutritional studies<sup>1, 2, 3, 4</sup> suggesting the atherogenic effect of cholesterol has, over the years, resulted in the focussing of research attention on the concept of cholesterol as perhaps the most important etiologic factor in atherogenesis. Large numbers of statistics<sup>5, 6</sup> have been accumulated on the levels of plasma cholesterol in health and disease and on the changes in these levels brought about by dietary manipulation, hormone therapy,<sup>7, 8, 9</sup> and the administration of drugs or cholesterol analogs.<sup>10, 11</sup>

The development in our knowledge of the physical state of lipids in plasma and tissues, just summarized for us by Drs. Surgenor and Batchelor, has caused a considerable shift in research emphasis in recent years. It is now quite evident that lipids are transported in the circulating plasma in the form of protein complexes. It becomes of prime importance, therefore, to consider the enzymatic and hormonal factors concerned in normal lipoprotein metabolism, aberrations in which may combine with the physical and anatomical factors described in the preceding discussions to produce localized lesions.

Fat exists in the plasma either as chylomicrons, relatively poor in all constituents other than neutral fat, or as lipoproteins divided into fairly well-defined density and charge classes and containing varying proportions of protein, phospholipids, cholesterol, and triglycerides. In view of the virtual absence of uncombined lipids in plasma we should now consider the results of chemical analyses and the variations in these results due to disease and experimental manipulation in terms of lipoprotein parameters only. From this point of view, phospholipid-cholesterol ratios and cholesterol concentrations become quite inadequate descriptions of the distribution of lipids between the  $\alpha$ -lipoproteins on the one hand, and the class of  $\beta$ -lipoproteins on the other.

The level of plasma lipids is the result of a dynamic equilibrium between two processes; first, the introduction of fats from absorption of exogenous sources and from the constant reshuffling of depots,<sup>12</sup> and second, the hydrolytic and oxidative removal of these substances in the visceral and peripheral tissues. Superimposed upon this basic situation are the lipoprotein-transforming reactions which take place in tissues and in the circulating plasma itself, and which recent experimental data suggest may play a considerable role in the determination of the pattern of distribution of plasma lipids.

In the normal individual, chylomicrons appearing in the plasma after the ingestion of fat are rapidly removed. The distribution of plasma lipoproteins, which may show a transient increase in the  $\beta$  components of low density (high neutral fat content), rapidly returns to the "normal" situation characterized by a ratio of  $\beta/\alpha$  lipoprotein of about 2:1.<sup>13</sup> The rate of *absorption* of fat, as indicated by the chylomicron studies of Zinn & Griffith,<sup>14</sup> does not appear to be significantly different in atherosclerotic and nonathero-

\* The studies cited from the National Heart Institute were carried out by Drs. E. Boyle, J. Bragdon, R. Brown, R. Gordon, R. Havel, E. Korn, and C. Anfinson.

sclerotic subjects. Their results would rather suggest that a difference exists in the "metabolic control of fat transport" since late postabsorptive or fasting samples showed marked differences in the levels of chylomicrons and lipomicrons in the plasmas of these two groups of subjects.

This slower rate of metabolic removal of lipids from circulating plasma is perhaps the most characteristic laboratory feature of atherosclerosis and of the allied metabolic diseases in which it constitutes a common sequela. Recent advances in techniques for the physical and chemical study of lipoproteins has resulted in extensive support for this point of view. Let us now consider first, some of the better documented findings in regard to the lipoprotein patterns of plasma in health and disease, and second, the present state of knowledge concerning the biochemical regulation of these patterns. Extensive enumeration of specific references is clearly not possible here due to space limitations, and the reader is referred to a number of excellent reviews including those of Nikkilä,<sup>15</sup> Jones *et al.*,<sup>16</sup> Gofman *et al.*,<sup>18</sup> Gould,<sup>17</sup> and a series in the Discussions of the Faraday Society.<sup>18</sup>

Dr. Surgenor has outlined for us the nature of the ultracentrifugal, electrophoretic, and fractionation techniques that have been employed for the isolation and study of the various lipoproteins found in plasma, and discussed their chemical and physical properties in some detail. As you all know, these techniques have been widely applied to the consideration of the abnormal plasma picture. The so-called x-protein of Pedersen,<sup>19</sup> reported by him to be present in relatively low levels in adolescents,<sup>20</sup> was subjected to intensive study by Gofman *et al.*,<sup>21</sup> whose elegant ultracentrifugal methods have constituted perhaps the greatest single stimulus to research in this field. Their well-known findings, indicating an elevated low-density  $\beta$ -lipoprotein content in the plasma of males in relation to females, in the aged in relation to the young, and in diseases involving aberrant lipid metabolism and predisposing to atherosclerosis, such as diabetes, nephrosis, and myxedema, have been extensively corroborated by a variety of methods in a number of laboratories. Russ, Eder, and Barr,<sup>22</sup> using alcohol-fractionation techniques, early demonstrated a similar dependency of the concentration of total  $\beta$ -lipoproteins on sex, age, and disease.

In these latter studies the total  $\beta$ -lipoprotein spectrum was considered, rather than specific density classes as in the work of the Donner Laboratory group. The rough correlations which can be made almost equally well between the various physiological situations considered and the levels of  $S_r$  10-100 lipoproteins,<sup>16</sup> the total  $\beta$ -lipoprotein spectrum,<sup>22</sup> and the total cholesterol content of plasma,<sup>23</sup> is a striking reflection of the fact that the  $\beta$ -lipoproteins act as the major carriers of plasma sterol (about 70%) in the normal case, and of an even higher proportion in many pathological situations,<sup>15, 21, 22, 24, 25</sup> The more sluggish removal of chylomicrons from the circulating plasma of the aged and the metabolically sick when considered in conjunction with findings such as those described above indicate clearly that the term "etiologic factors" must be reserved for phenomena considerably more subtle than the mere presence of abnormal concentrations of  $\beta$ -lipoproteins in plasma. Specifically, we must examine the enzymatic and hormonal systems which regulate these levels.

What do we know of the nature of  $\beta$ -lipoproteins that can help us generalize the process of lipid transport? Chemically, the increasingly less dense components contain progressively more triglycerides and less cholesterol, phospholipid, and protein. As has been



shown in the studies of Gofman *et al.* and of other investigators, lipoproteins of very low density appear to be degraded progressively in the direction of the normal  $\beta$ -lipoprotein pattern both with time in normal individuals following fat ingestion, and following the administration of ant clotting agents such as heparin, which we shall discuss more fully below. Immunological studies have indicated strong cross-antigenicity between the normal  $\beta$ -lipoprotein and lipoproteins of lower density.<sup>26</sup>

As one general explanation of these findings, it seems possible that the members of the class of  $\beta$ -lipoproteins may differ mainly, if not completely, in the proportion of neutral triglyceride molecules incorporated in their basic matrix. On the basis of recent chemical, electrophoretic, and ultracentrifugal evidence, discussed below in connection with heparin, one must also keep in mind the possibility that metabolic breakdown products of neutral fat, namely fatty acids, di-, and monoglycerides, are also present to a considerable extent in the "abnormal"  $\beta$ -lipoproteins.

In recent years a considerable interest has arisen in connection with the role of heparin as an antilipemic agent. The original studies of Hahn<sup>27</sup> on the chylomicron-removing properties of heparin have been greatly extended in numerous laboratories.<sup>28-33</sup>

Using a variety of techniques, it has been shown that low-density  $\beta$ -lipoproteins and chylomicrons are rapidly removed from plasma through the action of a "clearing factor" whose activity is induced by heparin administration. This plasma factor appeared, for some time, to be formed or activated by a second enzyme system in *tissues*, which utilized an inactive protein in plasma in conjunction with heparin to yield the active enzyme.<sup>31, 39</sup> More recent experiments by Dr. E. Korn<sup>40</sup> in our laboratory have considerably clarified the nature of heparin action. Studies on extracts of acetone powders of normal heart tissue indicate the presence of an enzyme with the properties of a "lipoprotein lipase" which catalyzes the hydrolysis of the triglycerides of chylomicrons but not of simple neutral fat emulsions (e.g. coconut oil emulsion). The latter type of substrate does, however, become digestible following preincubation with normal serum, during which process "synthetic" chylomicrons are presumably formed. The acetone powder extracts are activated severalfold by the addition of low levels of heparin, and both the basal and heparin-induced activity are completely inhibited by protamine and moderate ionic strengths, characteristics not observed in the case of ordinary pancreatic lipase (see below).

These recent experiments suggest that the clearing factor activity found in plasma following heparin injection may be the result of activation and release of the apo-enzyme portion of the tissue "lipoprotein lipase".

The activity of clearing factor may be roughly quantitated by measuring the decrease in turbidity resulting from its action on the alimentary lipemic sera of humans and dogs, on turbid sera from alloxan-diabetic rabbits, or on synthetic triglyceride emulsions.<sup>15, 38, 41</sup> More recently, some of the inherent difficulties in the measurement of turbidity changes in intrinsically unstable fat emulsions have been obviated by direct analysis for fatty acid, glycerol, or both, released during fat hydrolysis.<sup>42</sup>

The process catalyzed can be broadly summarized by the equation:

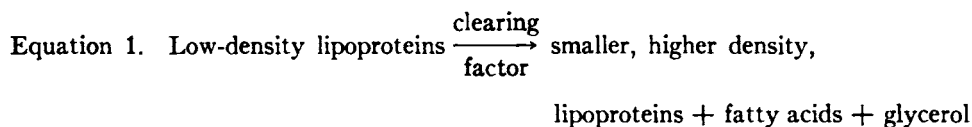

Fractionation and purification studies have yielded clearing factor preparations which permit the demonstration<sup>37</sup> of additional requirements for the proper functioning of the system. Thus, one can demonstrate that serum albumin is necessary as a binding and transporting agent for the fatty acids released, which, in the absence of albumin, strongly inhibit the hydrolysis of triglycerides by clearing factor (although such hydrolysis can also proceed when calcium ions are employed as the fatty acid binding agent). In figure 1, for example, are presented data indicating the progressive decrease in clearing factor activity during the titration of a clearing system with oleate. Nearly complete inhibition occurs when serum albumin has bound approximately 7-8 moles of fatty acid per mole. In certain clearing systems containing adequate supplies of albumin, one can demonstrate a further requirement for an additional "coprotein" component of serums (table I), the nature of which is at present somewhat obscure. The experiments on the tissue "lipo-protein lipase", outlined above, suggest that this coprotein effect may be concerned with the proper physical state of substrate particles.

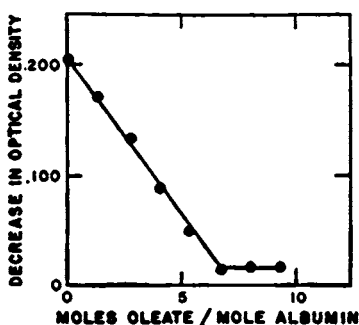

FIG. 1.—Inhibition of lipemia clearing reaction by oleate.

In the study of heparin action it is of particular interest to determine whether or not this substance is a component prosthetic group of clearing factor. Although the enzyme has, unfortunately, not been purified sufficiently to permit a direct analytical test of this possibility, several findings provide influential evidence in its support.

W. D. Brown<sup>43</sup> and others,<sup>15, 44, 45</sup> have demonstrated that injection of small amounts of the antiheparin agent, protamine, can reverse the clearing effect of heparin in alimentary lipemia, and more recently Bragdon and Havel<sup>46</sup> have shown that this effect is due to an increase in the content of  $\beta$ -lipoproteins of the density class  $S_r$  10 and above. The elevated levels are rapidly lowered by heparin administration. Although the clearing factor activity in the plasma of animals not receiving heparin is demonstrable only with difficulty,<sup>15, 31</sup> the protamine results strongly suggest the presence of low levels of the enzyme under conditions of normal fat transport. The recent experiments discussed above which indicate that clearing factor is located normally in tissues would explain this.

The presence of heparin in clearing factor is also indicated by studies on the inhibitory effect of protamine on the partially purified enzyme or on active plasma samples. The data summarized in figure 2 show that half-inhibition occurs at a protamine level of approximately  $5 \times 10^{-6}$  molar under the conditions used. Earlier experiments failing to show this inhibition of the clearing of turbid sera were undoubtedly obscured by the "clumping" effect<sup>47</sup> of protamine on chylomicron suspension, avoided in the case of the

TABLE I  
EFFECT OF ALBUMIN AND SERUM ON PURIFIED CLEARING FACTOR

Cofactor supplied to purified clearing factor	Decrease in optical density after	
	1 hr.	2 hr.
0.....	.004	.009
.2 cc. 5% albumin.....	.046	.069
.2 cc. 5% albumin + .005 cc. normal serum.....	.109	.159

present experiments by preincubation of serum with protamine before addition to the substrate suspension. The inhibition is also shown by determination of glycerol production as in table II. This table also demonstrates the complete dissimilarity between clearing factor and ordinary pancreatic lipase both as regards protamine inactivation and sensitivity to high ionic strengths.

It is of interest to consider the effect of heparin administration on low-density lipoproteins from the standpoint of the chemistry of the clearing reaction. The generalized equation above (equation 1) can be written more informatively as follows:

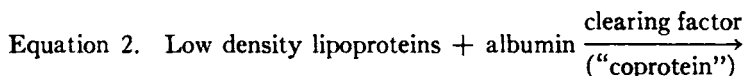

higher density lipoproteins + albumin (fatty acid)<sub>n</sub> + glycerol

(+ "solubilized" mono- & diglycerides)

As indicated, decrease in the content of the triglycerides does not proceed with a stoichiometric correspondence between fatty acid and glycerol. As shown in table III turbidity decrease and fatty acid release follow a more or less parallel course, while glycerol production lags well behind.<sup>42</sup> These data indicate the intermediary accumulation of di- and monoglycerides in a solubilized, nonturbid form and, as suggested in equation 2, require

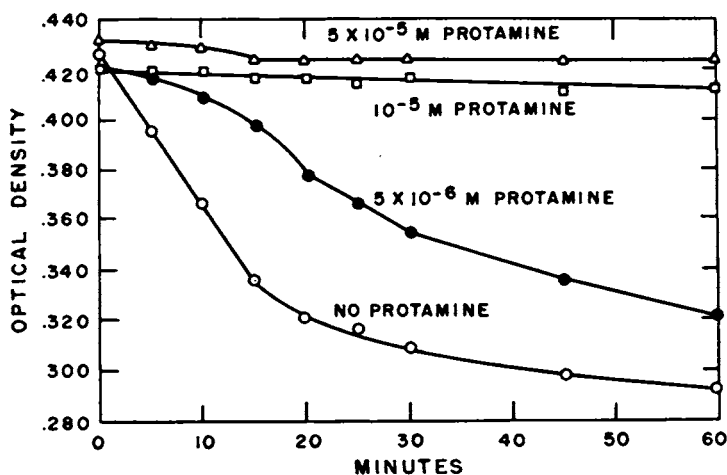

FIG. 2.—Inhibition of clearing factor by protamine.

TABLE II  
EFFECT OF HIGH IONIC STRENGTH AND PROTAMINE ON CLEARING FACTOR AND LIPASE ACTIVITY

Tube #		$\mu\text{M}$ Glycerol produced/30 min.
1	cf control	0.187
2	+ $10^{-5}$ M protamine	0.090
3	+ 1 M NaCl	0
4	lipase control	0.397
5	+ $10^{-5}$ M protamine	0.384
6	+ 1 M NaCl	0.417

Clearing factor (cf)—15 mg. alcohol fraction<sup>28</sup> per ml. 0.125 M  $\text{NH}_2\text{-NH}_4\text{Cl}$  buffer, pH 8.5, preincubated with salt and protamine at levels indicated. 0.4 cc. of preincubated mixture assayed against coconut oil emulsion.<sup>28</sup> Same incubation procedure used for lipase (steapsin).

the postulation of a solubilizing binding site for such compounds. Such a site might be the protein-phospholipid-cholesterol matrix of the  $\beta$ -lipoproteins themselves, although the possible involvement of additional factors such as the elusive "coprotein" or the cholesterol-poor, phospholipid-rich fraction described by Turner *et al.*,<sup>48</sup> cannot be overlooked in this regard.

Ultracentrifugal<sup>23, 24</sup> as well as starch and paper electrophoretic studies<sup>15</sup> have indicated that clearing factor action, *in vivo* and *in vitro*, leads to an increase in the  $\alpha_1$ -lipoprotein component of plasma concomitant with the marked fall observed in the level of  $\beta$ -lipoproteins. More recent studies with free electrophoresis<sup>49</sup> have clearly shown that the electrophoretic mobility of a portion of the  $\beta$ -globulin peak is markedly shifted during the *in-vivo* clearing of low-density  $\beta$ -lipoproteins following heparin administration, and that this shift is a transient one that disappears in subsequent blood samples. This shift in mobility can be reproduced by the addition of amounts of sodium oleate to the preheparin plasma sample equivalent to that released *in vivo*. Figures 3b, c, d, e, and f show this shift and progressive reversion from the initial pattern, 3a, of the mobility of a portion of the  $\beta$ -globulin peak of a patient with idiopathic hypercholesterolemia following heparin administration. Figure 3g represents the initial preheparin sample to

TABLE III  
CHANGES IN FREE FATTY ACID AND GLYCEROL (HCHO RELEASED BY PERIODATE) CONTENT, AND IN TURBIDITY DURING THE CLEARING OF COCONUT OIL EMULSION

Time (min.)	Turbidity ( $E_{500}$ )	% of max. change	Fatty acid $\mu\text{M}$	% of max. change	Glycerol $\mu\text{M}$	% of max. change
0	0.578	—	4.2	—	0	—
15	0.468	23	8.2	29	0.7	17
30	0.306	56	10.6	46	1.1	26
60	0.194	79	14.9	77	1.7	41
120	0.108	97	16.7	90	2.9	69
180	0.094	100	18.2	100	4.2	100

(Each reaction tube contained 2 ml. of postheparin plasma containing clearing factor, 3 ml. 5% bovine albumin, 4 ml. buffer,<sup>28</sup> and 1 ml. 0.5% coconut oil emulsion. Incubated at 37° C. One tube analyzed at each time indicated above.)

which an amount of sodium oleate has been added approximately equivalent to that released under physiological conditions.

In the light of these observations the postulation of an actual transfer of intact lipid molecules from  $\beta$ - to  $\alpha$ -lipoproteins, as suggested by certain data of Nikkilä<sup>15</sup> and others, must be made with some caution. It appears quite possible that the production of electrophoretically observed " $\alpha$ -lipoprotein" by the action of clearing factor on  $\beta$ -lipoproteins may be explained to a large degree by strong fatty acid binding capacity in these latter protein molecules. Electrophoretic changes induced by the binding of heparin itself to plasma proteins, although demonstrable at higher levels,<sup>15, 50</sup> are not detectable at the low levels administered in in-vivo studies (less than 20 $\gamma$ /ml. plasma).

The shifting ratio of electrophoretic  $\alpha$ - and  $\beta$ -lipoprotein components due to fatty acid production observed in acute experiments with heparin, such as those described above, may bear little relation to the trends in this ratio that have been studied so intensely of late in connection with disease. The investigations of Eder, Russ, and Barr,<sup>51</sup> Nikkilä,<sup>15</sup> Swahn,<sup>26</sup> Pratt,<sup>52</sup> Kunkel and Slater,<sup>24</sup> and others suggest strongly that the  $\alpha/\beta$  ratio may be a more sensitive indicator of abnormality in lipid metabolism than the level of  $\beta$ -lipoproteins alone. The  $\alpha$ -lipoproteins in these studies appear to be of a well-defined

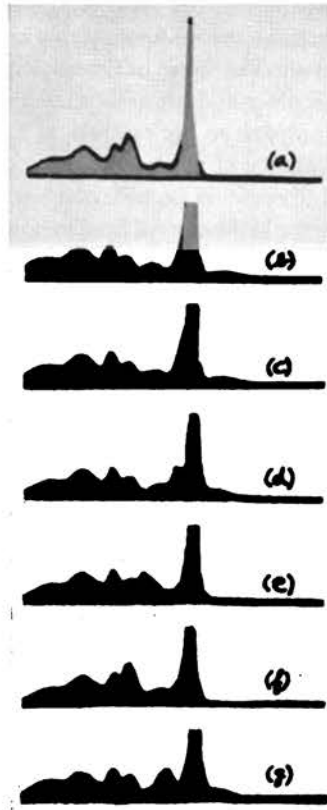

FIG. 3.—Electrophoretic mobility of portion of  $\beta$ -globulin peak in patient with idiopathic hypercholesterolemia. (a) Initial pattern. (b)–(f) Shift and reversion following heparin administration. (g) Equivalent shift produced by adding sodium oleate to initial sample.

chemical nature involving relatively constant proportions of protein, phospholipid, and cholesterol, although the extent of the coincidental presence of more transient lipoprotein-fatty acid complexes produced during the normal metabolism of low-density  $\beta$ -lipoproteins cannot be evaluated at present.

The metabolic role of the  $\alpha$ -lipoproteins is, at the moment, completely unknown.

#### SUMMARY AND SPECULATION

The central role of  $\beta$ -lipoproteins in the transport of neutral fat appears to be rather well established. Their function in cholesterol and phospholipid transport, on the other hand, is more difficult to evaluate, although the high proportion of plasma cholesterol in this protein fraction and the rapid rate of turnover of lipoprotein sterol<sup>17</sup> are highly suggestive.

The available experimental evidence supports the conclusion, accepted by most workers in the field, that the accumulation of  $\beta$ -lipoproteins of abnormally low density and high triglyceride content reflects metabolic deficiencies in the normal process by which these large molecules are degraded in the direction of the normal plasma picture. The results obtained in studies of heparin action and of heparin antagonists strongly suggest, although still inferentially, that the clearing-factor system may be in large part responsible for the maintenance of normal levels of lipoproteins in plasma. Indeed, a consideration of the levels of lipoprotein-specific lipase in tissues, in conjunction with the plasma ultrafiltration experiments of Kellner and his associates discussed elsewhere in this volume, suggests an interesting approach to the problem of lipid disposition.

The apparently unimpaired ability of most individuals, normal or otherwise, to utilize administered heparin for  $\beta$ -lipoprotein degradation leads one to consider the possibility that a major physiological error in diseases of lipid metabolism may be concerned with the formation of this hormone-like material in mast cells, or with the mechanism controlling its secretion.

Thus, as indicated in figure 4 by the dashed line, it is not inconceivable that a block or deficiency in a lipid-triggered homeostatic mechanism may be implicated in plasma lipid abnormalities, or that such abnormalities may result from insufficiencies in the bio-

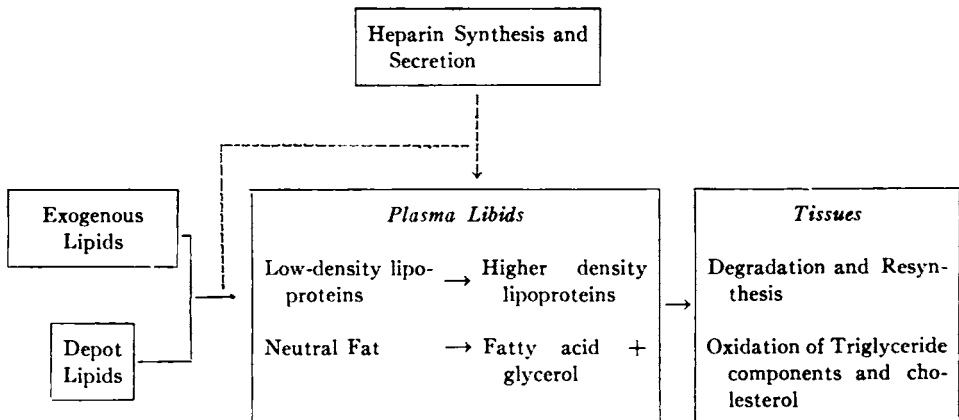

FIG. 4.—Possible action of insufficiencies in heparin synthesis or secretion in producing abnormal lipid metabolism.

synthesis or release of heparin. The analogy that can be drawn between the present considerations and the case of the glucose-insulin system in diabetes is sufficiently stimulating to warrant serious investigation.

## REFERENCES

1. Anitschkow, H., in Cowdry, E. V.: *Arteriosclerosis*, New York. The MacMillan Co., 1933.
2. Steiner, A., and Kendall, F. E., *Arch. Path.* **42**: 433, 1946.
3. Mann, G. J., Andrus, S. B., McNally, A., and Stare, F. J.: *J. Exper. Med.* **98**: 195, 1953.
4. Page, I. H., and Brown, H. B.: *Circulation* **6**: 681, 1952.
5. Keys, A.: *J. A. M. A.* **147**: 1514, 1951.
6. Keys, A., Mickelsen, O., Miller, E. V. O., Hayes, E. R., and Todd, R. L.: *J. Clin. Invest.* **29**: 1347, 1950.
7. Stamler, J., Pick, R., Katz, L. N., Lewis, L., and Page, I. H.: *Circulation* **6**: 460, 1952.
8. Adlersberg, D., Schaefer, L. E., and Drachman, S. R.: *J. Clin. Endocrinol.* **11**: 67, 1951.
9. Barr, D. P., Russ, E. M., and Eder, H. A.: *Circulation* **6**: 455, 1952.
10. Siperstein, M. D., Nichols, C. W., and Chaikoff, I. L.: *Circulation* **7**: 37, 1953.
11. Pollak, O. J.: *Circulation* **7**: 696, 1953.
12. Bernhard, K., and Schoenheimer, R.: *J. Biol. Chem.* **133**: 703, 1940.
13. Gofman, J. W., Jones, H., Lindgren, F., Lyon, J., Elliott, H., and Strisower, B.: *Circulation* **2**: 161, 1950.
14. Zinn, W. J., and Griffith, G. C.: *Am. J. M. Sc.* **220**: 597, 1950.
15. Nikkilä, E.: *Scandinav. J. Clin. and Lab. Invest.* **5** (Suppl. 8) 1953.
16. Jones, H. B., Gofman, J. W., Lindgren, F. T., Lyon, T. P., Graham, D. M., Strisower, B., and Nichols, A. V.: *Am. J. Med.* **11**: 358, 1951.
17. Gould, R. G.: *Am. J. Med.* **11**: 209, 1951.
18. Several authors: *Discussions of the Faraday Society* **6**: 1949.
19. Pedersen, K. O.: *Ultracentrifugal Studies on Serum and Serum Fractions*, Stockholm, Almqvist & Wiksells, 1945.
20. Pedersen, K. O.: *J. Phys. & Colloid Chem.* **51**: 156, 1947.
21. Gofman, J. W., Lindgren, F., Elliott, H., Mantz, W., Hewitt, J., Strisower, B., and Herring, V.: *Science* **111**: 166, 1950.
22. Russ, E. M., Eder, H. A., and Barr, D. P.: *Am. J. Med.* **11**: 468, 1951.
23. Keys, A.: *J. Gerontol.* **7**: 201, 1952.
24. Kunkel, H. G., and Slater, R. J.: *Proc. Soc. Exper. Biol. & Med.* **80**: 42, 1952.
25. Swahn, B.: *Scandinav. J. Clin. & Lab. Invest.* **5** (Suppl. 9), 1953.
26. Aladjem, F., and Lieberman, M.: *Fed. Proc.* **13**: 486, 1954.
27. Hahn, P. F.: *Science* **98**: 19, 1943.
28. Weed, C. B.: *Canad. M. A. J.* **51**: 578, 1944; *Proc. Can. Physiol. Soc.* 1948.
29. Anderson, H. G., and Fawcett, B.: *Proc. Soc. Exper. Biol. & Med.* **74**: 768, 1950.
30. Graham, D. M., Lyon, T. P., Gofman, J. W., Jones, H. B., Yankley, A., Simonton, J., and White, J.: *Circulation* **4**: 666, 1951.
31. Anfinsen, C. B., Boyle, E., and Brown, R.: *Science* **115**: 583, 1952.
32. Nikkilä, E. A., and Majanon, S.: *Scandinav. J. Clin. & Lab. Invest.* **4**: 204, 1952.
33. Lindgren, F. T., Freeman, N. K., and Graham, D. M.: *Circulation* **6**: 474, 1952.
34. Boyle, E., Bragdon, J., and Brown, R. K.: *Proc. Soc. Exper. Biol. & Med.* **81**: 475, 1952.
35. Waldron, J. M., and Friedman, M. H. F.: *Fed. Proc.* **7**: 130, 1948.
36. Spitzer, J. J.: *Am. J. Physiol.* **171**: 492, 1952.
37. Gordon, R. S., Boyle, E., Brown, R., Cherkas, A., and Anfinsen, C. B.: *Proc. Soc. Exper. Biol. & Med.* **84**: 168, 1953.
38. Brown, R. K., Boyle, E., and Anfinsen, C. B.: *J. Biol. Chem.* **204**: 423, 1953.
39. Brown, R. K., and Kauffman, D.: *Fed. Proc.* **12**: 183, 1953.
40. Korn, E. D.: *Science*, **120**: 399, 1954.
41. Grossman, M. I.: Report No. 110, Army Medical Nutrition Laboratory, 1953.
42. Korn, E., Gordon, R. S., Anfinsen, C. B., Cherkas, A., and Quigley, T.: Unpublished data.

43. Brown, W. D.: *Quart. J. Exper. Physiol.* **37**: 75, 1952.
44. Hewitt, J. E., Hayes, T. L., Gofman, J. W., Jones, H. B., and Pierce, F. T.: *Cardiologia* **71**: 353, 1952.
45. Spitzer, J. J.: *Fed. Proc.* **12**: 137, 1953.
46. Bragdon, J., and Havel, R.: *Am. J. Physiol.* **177**: 128, 1954.
47. Swank, R.: *Am. J. Physiol.* **164**: 798, 1951.
48. Turner, R. H., Snavely, J. R., Goldwater, W. H., and Randolph, M. L.: *Yale J. Biol. & Med.* **24**: 450, 1952.
49. Gordon, R. S.: *J. Clin. Invest.* (in press).
50. Hoch, H., and Chanutin, A.: *J. Biol. Chem.* **197**: 503, 1952.
51. Eder, H. A., Russ, E., and Barr, D. P.: Personal communication.
52. Pratt, R. M.: *Fed. Proc.* **11**: 270, 1952.

### DISCUSSION

*Dr. Gross* asked whether heparin was specific or whether other polysaccharides would produce similar results.

*Dr. Anfinsen* replied that almost any substances similar to heparin will act in the same way, provided the molecular weight is high enough and the substance contains sulfate.

In reply to a question by *Dr. Page*, he stated that dextran sulfate has a similar though less marked effect. He added that the mast cells are probably the source of heparin.

*Dr. Gross* pointed out that the blood vessel wall, in common with other connective tissues, contains sulfated polysaccharides and that these compounds undergo considerable change as the organism ages. He considered it possible that the sulfated polysaccharide content of some tissues may be exhausted or otherwise altered with age, and that if this constitutes a mechanism for the removal or degradation of lipoproteins in tissues, the alteration might account for the deposition of lipids in some areas but not in others.

In reply to a question by *Dr. Page*, he stated that the ground substance contains enough mucopolysaccharides and high-polymer carbohydrates to make this rationale of practical importance.

Although it is known that the rat has an abundance of mast cells, while the rabbit has few, he felt that there is inadequate evidence that the mast cells are the sole agency for the production of high-polymer sulfates.

*Dr. Anfinsen* was of the opinion that the mast cells may be the source of the polysaccharides. He reported that he had instituted a small-scale study of the biosynthesis of heparin in an attempt to learn more about its structure.

He emphasized that the action of heparin is not entirely nonspecific; that a polyglycuronic compound will induce activity, but that the chondroitin type of polysaccharide will not.

*Dr. Surgenor*, with regard to the role of serum albumin in the transport of fatty acids, estimated that this protein can carry on the order of eight moles of  $C_{18}$  fatty acid or 100 mg. per ml. of plasma—an appreciable amount.

*Dr. Anfinsen* suggested that the rise in neutral fat in Fraction IV + V + VI following heparin administration observed by *Dr. Eder* might actually be an increase in free fatty acid in that fraction, since the method of determining neutral fat also determines free fatty acid.

In reply to *Dr. Gould's* question whether it was purely coincidental that the same substances that have an effect on the serum lipoproteins also have an effect on coagulation, he stated that he had never found a compound that had one activity without the other.



*Dr. Lehninger* asked whether it is possible to modify the course of cholesterol-induced atherogenesis by the administration of heparin or any one of the heparin antagonists.

*Dr. Anfinsen* replied that many were attempting it. He had heard reports of the regression of xanthomatous lesions under the influence of heparin. He added that the administration of heparin to a patient with hypercholesterolemia rapidly reduces the cholesterol level.

*Dr. Katz* stated that these reports had been confirmed by Horlick, working in Dr. Duff's laboratory.

*Dr. Duff* added that Dr. Horlick had found only a moderate retardation of the development of cholesterol atherosclerosis in rabbits under heparin treatment, and no effect at all on the regression of the lesions. Lesions were induced by feeding cholesterol for three months, and the cholesterol feeding was then stopped. After a rest period of seven weeks, heparin was given to one half of the animals, and observations were continued for three months. There was no difference between the lesions in the heparinized and the nonheparinized groups at the end of the period of observation.

*Dr. Gross* commented that it would be of interest to determine whether heparin actually goes through the vessel wall.

## PLASMA LIPOPROTEINS IN ATHEROSCLEROSIS AND RELATED DISEASES\*

HOWARD A. EDER

Recent physiochemical studies have shown that the serum lipids exist almost entirely as constituents of lipoproteins.<sup>1, 2</sup> Because of the large body of evidence relating atherosclerosis to plasma lipids,<sup>3</sup> the study of the nature and concentration of the plasma lipoproteins in atherosclerosis and related diseases is a subject of considerable current interest and importance. Three methods are generally used for the separation of the plasma lipoproteins: zone electrophoresis,<sup>4, 5, 6</sup> ultracentrifugal flotation,<sup>7, 8</sup> and chemical fractionation. In our studies the separation of lipoproteins was accomplished with Cohn's method 10 in which the solubilities of the plasma proteins are altered by variations in pH, ethanol concentration, ionic strength, and protein concentration.<sup>9, 10, 11</sup>

Ordinarily, three fractions are separated. The first, corresponding to Cohn fractions IV + V + VI, consists largely of albumin but also contains the alpha lipoproteins as well as smaller amounts of other proteins. The second corresponds to Cohn fraction II and consists largely of gamma globulin. The third, corresponding to Cohn fraction I + III, contains the beta lipoproteins as well as other alpha and beta globulins and fibrinogen. Since these fractions contain proteins other than lipoproteins, the amount of lipoprotein must be estimated indirectly. As indicated by Dr. Surgenor, alpha lipoproteins have a cholesterol content of about 12% and beta lipoproteins about 30%. If one divides the quantity of cholesterol in fraction IV + V + VI by 0.12 or the cholesterol in fraction I + III by 0.30, one arrives at an estimate of the quantity of lipoprotein in the fraction. This estimate is very rough because of the uncertainty as to the exact composition of the alpha lipoproteins and because of the fact that the lipoproteins in fraction I + III may be of variable cholesterol concentration.<sup>12</sup> In order to avoid these errors the quantity and distribution of lipoproteins have been described in these studies in terms of the cholesterol content of the fractions.

### *Cholesterol Distribution in Normal Subjects*

In table I are presented data on cholesterol distribution in normal subjects of both sexes at various ages. The absolute amount of cholesterol in fraction IV + V + VI is quite similar in all age groups except in cord plasma, where it is considerably lower. The cholesterol in fraction I + III increases appreciably with age. Despite the low absolute quantity of cholesterol in fraction IV + V + VI in cord blood it constitutes a high percentage of the total, and this percentage decreases with age. In the plasma of normal young individuals the percentage of the total plasma cholesterol in fraction IV + V + VI rarely falls below 20%. With increasing age many so-called "normal" individuals have values of less than 20%. The difference in this value between young males and young females is of interest, especially in relationship to the lower incidence of coronary artery disease in young females.

\* The original studies described were carried out at the New York Hospital-Cornell Medical Center in association with Dr. D. P. Barr and Miss Ella M. Russ.

TABLE I  
CHOLESTEROL DISTRIBUTION IN NORMAL SUBJECTS

	Cord blood	Women age 19-35	Men age 22-35	Women age 45-65	Men age 47-62
Plasma, mg./100 ml.....	65	190	215	274	264
Fraction IV + V + VI, mg./100 ml.....	28	60	52	53	53
Per cent of total.....	43	33	25	25	20
Fraction I + III, mg./100 ml.....	37	123	153	208	209
Per cent of total.....	57	66	75	80	80

*Cholesterol Distribution in Disease*

In table II is shown the cholesterol distribution in the plasma of survivors of myocardial infarction, patients with the nephrotic syndrome, and patients with familial hypercholesterolemia. The patients who had survived myocardial infarction were always studied after a period of at least six weeks following the acute episode. In all these diseases the absolute amount of cholesterol in fraction IV + V + VI is reduced, while the amount in fraction I + III is increased. In all instances the percentage of cholesterol in fraction IV + V + VI is markedly reduced. In only three of the nearly 100 patients with coronary artery disease was the percentage of total cholesterol in fraction IV + V + VI greater than 20%. Many of the patients with atherosclerosis have plasma cholesterol concentrations well within the normal range, but because of the absolute reduction in the cholesterol found in fraction IV + V + VI and the increase in fraction I + III, the percentage in IV + V + VI is reduced. All patients with idiopathic hyperlipemia exhibit abnormal patterns of the same type shown in the table. Many diabetics have similar abnormal patterns.

*Cholesterol-Phospholipid Ratios*

The distribution of phospholipid in the two lipoprotein-containing fractions parallels the distribution of cholesterol. The data shown in table III are the means of cholesterol-phospholipid ratios for each group. In fraction IV + V + VI this ratio is similar for all

TABLE II  
CHOLESTEROL DISTRIBUTION IN ATHEROSCLEROSIS AND RELATED DISEASES

	Atherosclerosis*	Nephrosis	Familial hypercholesterolemia
Plasma, mg./100 ml.....	274	551	404
Fraction IV + V + VI, mg./100 ml.....	34	23	34
Per cent of total.....	13	5	9
Fraction I + III, mg./100 ml.....	228	509	360
Per cent of total.....	87	95	91

\* Survivors of myocardial infarction.

TABLE III  
CHOLESTEROL-PHOSPHOLIPID RATIOS

	Plasma	Fractions	
		IV + V + VI	I + III
Cord blood.....	0.56	0.43	0.82
Young women aged 19-35.....	0.86	0.53	1.26
Young men aged 22-35.....	0.94	0.49	1.27
Older women aged 51-62.....	1.00	0.51	1.40
Older men aged 47-62.....	1.00	0.52	1.35
Atherosclerosis, aged 22-67.....	0.95	0.45	1.22
Nephrosis, aged 3-70.....	1.10	0.43	1.24
Hypercholesterolemia, aged 14-60.....	1.23	0.51	1.41

groups. In fraction I + III the ratio is low in cord plasma and higher in the remaining groups. In the individual samples the ratios varied considerably about the mean, but in no plasma did the ratio in fraction IV + V + VI approach the range found in fraction I + III. (The coefficient of variation of the ratios is about 10%.) Not shown in the table are the data obtained in a few patients with idiopathic hyperlipemia in whom ratios of 0.80 to 0.90 were observed in fraction I + III. From these data it is apparent that the mean cholesterol-phospholipid ratio in the plasma of any group is a function of lipoprotein distribution: thus, when the proportion of beta lipoprotein is high, the ratios will be high. In individual plasma the variation of the ratios in the fractions is such that the plasma ratio cannot be used to predict distribution of lipoproteins.

*Distribution of Cholesterol and Phospholipid in Animals*

Some studies of animal plasma have been made (table IV). Since this method of fractionation was developed for human plasma there may be error in its application to plasma of other species. Russ and Raymunt<sup>13</sup> have recently studied the application of this method to dog plasma and found by electrophoretic analysis of the fractions that the separation of lipoproteins was similar to that found for human plasma. Such a demonstration is necessary for each new species to be studied.

TABLE IV  
LIPID DISTRIBUTION IN ANIMALS

	Man	Dog*	Rabbit*
Plasma			
Cholesterol (mg./100 ml.)	190	144	52
Cholesterol/phospholipid	0.86	0.42	0.47
Fraction IV + V + VI			
Per cent of total cholesterol	33	87	51
Cholesterol/phospholipid	0.52	0.41	0.35
Fraction I + III			
Per cent of total cholesterol	66	12	42
Cholesterol/phospholipid	1.28	0.74	0.81

\* Determinations on single animals.

In the dog, although the plasma cholesterol is within the human range, the bulk of the cholesterol is in fractions IV + V + VI. The cholesterol-phospholipid ratio in fractions IV + V + VI is about the same as in human plasma, but that in fractions I + III is considerably lower. The plasma cholesterol-phospholipid ratio is accordingly low. In rabbits the plasma cholesterol is low, but it is distributed fairly evenly between the two lipoprotein-containing fractions. In a single chick the pattern was not greatly dissimilar to man.

#### *Free and Ester Cholesterol Distribution*

When the fractions are analyzed for free and total cholesterol by the Sperry-Schoenheimer method (table V) the ratio of free to total cholesterol is always lower in fraction IV + V + VI than in fraction I + III. The ratio in unfractionated plasma is intermediate. This constant difference between the fractions affords a good illustration of the specificity of lipid binding in the lipoproteins. In idiopathic hyperlipemia the ratio is markedly increased in fraction I + III. The relationship of this observation to the

TABLE V  
FREE/TOTAL CHOLESTEROL

	Plasma	Fractions	
		IV + V + VI	I + III
Normal.....	0.29	0.24	0.33
Atherosclerosis.....	0.29	0.24	0.33
Nephrosis.....	0.33	0.29	0.33
Hypercholesterolemia.....	0.32	0.22	0.32
Hyperlipemia.....	0.45	0.29	0.42

chemical nature of the low-density lipoproteins present in this disease will be discussed subsequently.

#### *Neutral Fat Distribution*

In table VI are shown neutral fat concentrations in plasma and in the two lipid-containing protein fractions. In order to precipitate completely the proteins in fraction I + III human albumin was added; this contained sodium caprylate and acetyl tryptophane, which interfered with the determination of total lipid carbon. Accordingly, the neutral fat in that fraction was estimated by subtracting that found in fraction IV + V + VI from that in plasma. Furthermore, the method used in the neutral fat determination, carbon combustion, does not differentiate between triglycerides and fatty acids. It is likely that some of the "neutral fat" found in fraction IV + V + VI is free fatty acid since albumin, which is known to bind fatty acids, is present in this fraction. All that can be concluded from these data is that the neutral fat in plasma is found largely in fraction I + III, and when there is an increase in neutral fat, either as the result of disease or fat ingestion, the increment is almost entirely in fraction I + III.

#### *Other Methods of Separation of Plasma Lipoproteins*

From these data on the chemical composition of the fractions it is possible to compare this method of protein separation with others. By zone electrophoresis plasma lipid mi-

TABLE VI  
NEUTRAL FAT DISTRIBUTION (mg./100 ml.)

	Plasma	Fractions	
		IV + V + VI	I + III*
Normal.....	170	46	126
Atherosclerosis.....	305	45	259
Nephrosis.....	1120	60	1060
Hypercholesterolemia.....	549	41	508
Hyperlipemia.....	3088	87	3001

\* Estimated by subtracting the amount in fraction IV + V + VI from that in plasma.

grates chiefly in two fractions, one with the mobility of alpha globulin and the other with the mobility of beta globulin. About 30% of the total cholesterol is present in the alpha component.<sup>5, 6</sup> The cholesterol-phospholipid ratios in the two components are almost identical with those found in fraction IV + V + VI and I + III.<sup>4, 5</sup> Furthermore, on paper or starch the lipid in fraction IV + V + VI migrates as alpha globulin and that in fraction I + III migrates as beta globulin.<sup>14</sup> This evidence indicates that the separation of lipoproteins by these two techniques is very similar.

When plasma is brought to a solvent density of 1.063 by the addition of concentrated salt solution and then subjected to ultracentrifugation, a layer of lipoprotein floats upward which has the electrophoretic mobility of beta globulin and corresponds in cholesterol content to that found in fraction I + III.<sup>15</sup> In a series of young adults studied by this technique at the National Heart Institute in association with Dr. Havel, the distribution of cholesterol between the top and bottom fractions was virtually identical with that found by Cohn fractionation. When this top layer is subjected to further ultracentrifugation, further separation of lipoproteins occurs, with those of lowest density having the most rapid rate of flotation.<sup>7</sup> It seems possible that these low-density lipoproteins may be aggregates of beta lipoprotein with varying amounts of neutral fat.

Dr. Bragdon,<sup>12</sup> has analyzed these low-density components chemically and found that the material of lower density than  $S_{f10}$  had ratios of free to total cholesterol from 0.50 to 0.60 and cholesterol-phospholipid ratios as low as 0.50. In our patients with idiopathic hyperlipemia, in whom the plasma concentrations of the low-density lipoproteins are very high, fraction I + III also had high ratios of free to total cholesterol and low ratios of cholesterol to phospholipid. These data suggest that the low-density lipoproteins may have further chemical differences from the beta lipoproteins hitherto described.

#### *Obstructive Jaundice and Acute Hepatitis*

In obstructive jaundice and acute hepatitis, lipoproteins are present which differ considerably from those found in normals and in patients with the diseases thus far discussed.<sup>16</sup> Illustrative of this are the data in table VII showing the lipid distribution in a patient with biliary cirrhosis. The quantity of cholesterol in fraction IV + V + VI is markedly increased. Upon electrophoresis this material migrates with beta globulin, as does the lipid in fraction I + III. However, in addition to the solubility differences of the lipoproteins in the two fractions there is a difference in cholesterol partition; whereas all

TABLE VII  
LIPID DISTRIBUTION IN BILIARY CIRRHOSIS

	Plasma	Fractions	
		IV + V + VI	I + III
Cholesterol (mg./100 ml.).....	1180	838	296
Free/total cholesterol.....	0.90	0.98	0.59
Phospholipid (mg./100 ml.).....	2237	1532	481
Cholesterol/phospholipid.....	0.53	0.54	0.62
Neutral fat (mg./100 ml.).....	252	61	119

the cholesterol in fraction IV + V + VI is free, in fraction I + III the proportion of free cholesterol varies between 50% and 80% of the total. That the lipoproteins present in fraction I + III differ from the usual beta lipoproteins is demonstrated by the very low cholesterol-phospholipid ratio. These two abnormal lipoproteins have been found in a variety of types of obstructive jaundice and in all cases of early acute hepatitis. When jaundice subsides these lipoproteins rapidly disappear and are replaced by the "normal" lipoproteins.

*The Effect of the Administration of Sex Hormones*

The reproducibility of this method of chemical fractionation has made possible careful study of the serial changes in lipoprotein pattern produced by various agents.<sup>17, 18</sup> Because of the differences between young men and young women in lipoprotein concentrations, the effects of estrogen administration on plasma lipoproteins were studied. In table VIII are summarized the mean values before and after estrogen administration to 14 male survivors of myocardial infarction. They received either 1.0 mg. per day of ethinyl estradiol (Estinyl) or 15 mg. per day of conjugated equine estrogens (Premarin). The cholesterol in fraction IV + V + VI increases, the cholesterol in fraction I + III tends to decrease to a greater extent, and plasma cholesterol levels fall. The change is apparent by the first week and nearly maximal by the second or third week. Upon cessa-

TABLE VIII  
ESTROGEN ADMINISTRATION

	Before	After
<b>Plasma</b>		
Cholesterol (mg./100 ml.).....	268	222
Cholesterol/phospholipid.....	0.97	0.75
<b>Fraction IV + V + VI</b>		
Cholesterol (mg./100 ml.).....	31	58
Per cent of total cholesterol.....	12	28
Cholesterol/phospholipid.....	0.46	0.44
<b>Fraction I + III</b>		
Cholesterol (mg./100 ml.).....	228	157
Per cent of total cholesterol.....	69	42
Cholesterol/phospholipid.....	1.22	1.04

TABLE IX  
ANDROGEN ADMINISTRATION

	Before	After
<b>Plasma</b>		
Cholesterol (mg./100 ml.) . . . . .	211	235
Cholesterol/phospholipid . . . . .	0.87	1.00
<b>Fraction IV + V + VI</b>		
Cholesterol (mg./100 ml.) . . . . .	46	28
Per cent of total cholesterol . . . . .	22	14
Cholesterol/phospholipid . . . . .	0.46	0.43
<b>Fraction I + III</b>		
Cholesterol (mg./100 ml.) . . . . .	157	199
Per cent of total cholesterol . . . . .	78	86
Cholesterol/phospholipid . . . . .	1.20	1.26

tion of estrogen administration cholesterol values rapidly return to their original levels. Concomitant with these changes in cholesterol are decreases in the cholesterol-phospholipid ratios in fraction I + III and in the plasma. Women with coronary artery disease and normal men and women show similar responses to estrogen administration.

The administration of methyl testosterone in doses ranging from 10 to 50 mg. per day produced exactly opposite effects (table IX).

These observations suggest that the concentrations of the plasma lipoproteins are in part regulated by sex hormones. They offer an explanation for sex differences in lipoprotein patterns. They also demonstrate that lipoprotein patterns are subject to chemical manipulation. At the present time little is known as to the mechanism whereby hormone administration affects plasma lipoprotein concentrations. Elucidation of this mechanism would contribute greatly to our understanding of the mechanism controlling the concentrations of the plasma lipoproteins. While these observations have obvious therapeutic implications, extensive long-term clinical investigation is necessary before these agents can be considered for use in clinical practice.

#### REFERENCES

1. Oncley, J., Scatchard, G., and Brown, A.: *J. Phys. & Colloid Chem.* 51: 184, 1947.
2. Gofman, J. W., Glazier, F., Tamplin, A., Strisower, B., and DeLalla, O.: *Physiol. Rev.* 34: 589, 1954.
3. Gubner, R., and Ungerleider, H. E.: *Am. J. Med.* 6: 60, 1949.
4. Kunkel, H. G., and Slater, R. J.: *J. Clin. Investigation* 31: 677, 1952.
5. Nikkilä, E.: *Scandinav. J. Clin. & Lab. Invest.* 5 (Suppl. 8) 1953.
6. Swahn, B.: *Scandinav. J. Clin. & Lab. Invest.* 5 (Suppl. 9) 1953.
7. Gofman, J. W., Lindgren, F. T., and Elliott, H.: *J. Biol. Chem.* 179: 973, 1949.
8. Lewis, L. A., and Page, I. H.: *Circulation* 7: 707, 1953.
9. Cohn, E. J., Gurd, F. R. N., Surgenor, D. M., Barnes, B. A., Brown, R. K., Derouaux, G., Gillespie, J. M., Kahnt, F. W., Lever, W. F., Liu, C. H., Mittleman, D., Mouton, R. F., Schmid, K., and Uroma, E.: *J. Am. Chem. Soc.* 72: 465, 1950.
10. Russ, E. M., Eder, H. A., and Barr, D. P.: *Am. J. Med.* 11: 468, 1951.
11. Barr, D. P., Russ, E. M., and Eder, H. A.: *Am. J. Med.* 11: 480, 1951.
12. Bragdon, J.: Personal communication.
13. Russ, E., and Raymunt, J.: In press.
14. Russ, E. M.: Personal communication.
15. Eder, H. A.: Unpublished observations.



16. Eder, H. A., and Russ, E. M.: *J. Clin. Investigation* 33: 564, 1953.
17. Barr, D. P., Russ, E. M., and Eder, H. A.: *Tr. A. Am. Physicians* 65: 102, 1952.
18. Barr, D. P.: *Circulation* 8: 641, 1953.

### DISCUSSION

*Dr. Surgenor* commented that many investigators had asked him whether the various animal plasmas can be fractionated by the methods developed for human plasma. He pointed out that widely varying distributions of the various components had been observed, depending upon the species. He asked how firmly the distinction between alpha and beta lipoproteins had been established in the various experimental animals.

*Dr. Eder* replied that in the dog, Miss Russ had demonstrated that alpha and beta lipoproteins were separated. No such confirmatory studies had been carried out in the chicken or rabbit. It was of interest, however, that both rabbit and pig serum show about the same distribution by ultracentrifugal separation as is found in Cohn fractionation. He emphasized that in any new species the separation must be checked by electrophoresis.

*Dr. Duff* reported that Gottlieb of Madison, Wisconsin had called his attention to the fact that swine develop a few minute lesions that are much like the minute fatty flecks in the human aorta, although the lesions do not become pronounced even in old pigs.

*Dr. Mann*, in reply to a question by Dr. Anfinson, stated that the diet commonly fed to hogs on a farm is low in fat. In the Midwest the diet is predominantly corn, fortified with animal protein, and contains approximately five to eight per cent fat. He estimated that 90 per cent of slaughterhouse material consists of hogs six to ten months old.

*Dr. Eder*, in reply to a question by Dr. Gould concerning comparison of the results of chemical fractionation of serum from patients with biliary cirrhosis with those obtained by zone electrophoresis, stated that the latter technique usually reveals one lipid peak with the mobility of beta globulin. By fractionation, lipid is found in Fraction IV + V + VI and in I + III, and when the fractions are analyzed electrophoretically the mobility of the lipids in both fractions is identical with that of beta globulin. There are chemical differences between the lipids in the two fractions, and these suggest that the separation is not an artifact but that there are two different lipoproteins.

*Dr. Page* asked whether Dr. Eder felt that the distribution has any prognostic value as far as atherogenesis is concerned.

*Dr. Eder* replied that an abnormal pattern is unusual in individuals under 35 and when found is usually associated with disease. In apparently normal older people abnormal patterns are not uncommon, and their significance had not as yet been assessed. There is no correlation between the degree of deviation of the lipoprotein distribution and the extent of atherosclerotic disease.

*Ll. Batchelor* suggested that the peculiar difficulties attending extension of fractionation procedures to the study of pathologic plasmas be kept in mind, particularly with the lipid-rich "alpha globulin" observed in biliary cirrhosis. Would all the lipids of that fraction precipitate with the relatively small amount of protein present, for example, on the addition of zinc?

*Dr. Eder* replied that Dr. Lever and Miss Russ had found that in biliary cirrhosis a portion of the lipid in Fraction IV + V + VI was not precipitable by zinc. Furthermore, on partial isolation the lipoprotein in Fraction IV + V + VI was found to have a protein content less than that of alpha or beta lipoprotein.

## THE ROLE OF THE HORMONES IN ATHEROSCLEROSIS\*

L. N. KATZ, J. STAMLER, AND R. PICK

Considerable change has occurred in our attitude toward atherosclerosis in the decade and a half since this department began a major program of study of this disease. Atherosclerosis is now clearly delineated as a distinct entity—the most important entity—among the arterioscleroses. Atherosclerosis is no longer linked in loose, confusing synonymity with hypertension. Atherosclerosis is no longer dogmatically identified with aging. It is now clearly established that atherosclerosis is a disease—a disease consequent upon alterations in cholesterol-lipid-lipoprotein metabolism.

This cholesterol-lipid-lipoprotein concept of atherogenesis is fundamental to most of the research proceeding on this problem today. Based on this concept of atherosclerosis as a metabolic disease, the investigative assault has proceeded predominantly on two fronts: 1) the influence of diet; and 2) the role of hormones. The present paper is concerned primarily with the latter. However, it is hardly possible to deal soundly with the problem of endocrines and atherosclerosis without a preliminary reformulation of the problem of diet and atherosclerosis.

In the last year or two, a school of thought has arisen which challenges the thesis that diet, and particularly dietary cholesterol, is of significance in human atherogenesis. The argument goes as follows: Tracer studies have demonstrated that the cholesterol of plasma and tissues originates chiefly by endogenous synthesis from acetate radicals, and not from the ingested cholesterol of the diet. Moreover, it is argued, endogenous cholesterol synthesis is nicely attuned to variations of the cholesterol intake, thereby efficiently accomplishing over-all regulation of cholesterol metabolism. Thus (the argument continues) dietary cholesterol must play only a secondary, insignificant role in cholesterol metabolism and therefore in atherogenesis. Diet has little to do with human atherogenesis, and dietary regulation is of little avail in the control of this disease process.<sup>1, 2</sup> This concluding thesis is often stated circumspectly, as if its authors really have serious doubts and misgivings about it.

This line of reasoning, we submit, is inadequate factually and conceptually. In point of fact, it has but one valid foundation: It *is* correct that the bulk of body cholesterol is endogenously synthesized from acetate of the metabolic pool. But it is *not* correct that regulation of cholesterol metabolism is so efficient as to be uninfluenced by diet. All recent studies demonstrate precisely the opposite, *i.e.*, that the pattern of diet *over the life span* significantly influences cholesterol-lipid-lipoprotein metabolism, particularly patterns of cholesterolemia and lipoproteinemia.<sup>3-5</sup>

Even if (contrary to the actual facts) one should accept as valid the concept of completely precise body regulation of cholesterol metabolism, this still would not justify the conclusion that diet has no influence on cholesterol metabolism. What is the actual situation? As cholesterol intake and absorption increases, hepatic synthesis decreases.<sup>6</sup> Ideal (not actual) result: constancy of plasma and tissue cholesterol. Two alternative meta-

\* This work was supported in part by the Chicago Heart Association, the National Heart Institute, and the Michael Reese Research Foundation. Dr. Stamler is an Established Investigator of the American Heart Association.

bolic pathways, therefore, presumably lead to the same end result (fig. 1). But even assuming such perfect regulation, does present knowledge permit us to say that both these alternative metabolic pathways are, over the life span, equally benign with respect to the pathogenesis of atherosclerotic disease? Is this not an unsolved problem remaining to be investigated—a most urgent one in view of the actual facts demonstrating that the autoregulation of cholesterol metabolism is *not* perfect in response to continuous cholesterol ingestion over the life span?

What is the fundamental generalization derived from the findings of tracer studies, and what bearing does it have for the atherosclerosis problem? As Schoenheimer brilliantly emphasized in "The Dynamic State of Body Constituents,"<sup>7</sup> the results of experiments with labelled metabolites compel an abandonment of rigidly mechanistic views that there are two independent types of metabolism, exogenous and endogenous, and that the

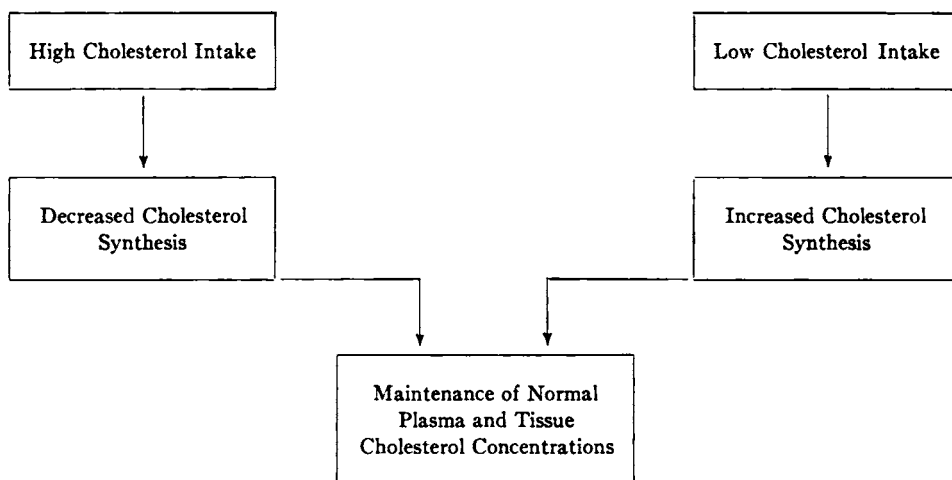

FIG. 1.—Alternative metabolic pathways with high and low dietary cholesterol intake.

structural elements of the body are primarily in a fixed or stable state. "The new results imply that not only the fuel but the structural elements are in a steady state of flux. The classical picture must thus be replaced by one which takes account of the dynamic state of body structure."<sup>7</sup>

This radically different concept of the dynamic state of body structure lends no support to ideas minimizing the influence of diet on the organism. Quite the contrary. If any and all parts of the organism are in continuous flux, then all the more intimate must their interlinkage be with elements derived from the diet. All the more sensitive must the organism be, particularly over the life span, to the quality and quantity of nutrient with which it enters into dynamic interrelationship. All the more complex must the interplay be between organism and environment, ontogenetically and phylogenetically.

It is instructive to re-examine—in the light of the foregoing concepts—certain cardinal facts already known about the interrelationships among diet, cholesterol-lipid-lipoprotein metabolism, and atherogenesis: In population groups ingesting a diet low in cholesterol and lipid over the life span, plasma cholesterol levels are remarkably low

(in terms of American "normal" values). Such populations seem to be remarkably free of atherosclerosis.<sup>3-5</sup>

The present-day "normal" American diet, rich in cholesterol-lipid derived in large measure from dairy and poultry products, is (in terms of human phylogenesis) a relatively recent innovation in nutrition.<sup>3, 5, 8</sup> This is a diet of civilization—a diet markedly different from any ever consumed by primitive peoples (excepting pastoralists) or wild animals. As a species, man phylogenetically has not acquired the ability to adjust perfectly to this diet. Hence, ontogenetically, in population groups ingesting this diet over the life span, plasma cholesterol levels tend to rise postnatally and remain high thereafter.<sup>3-5</sup> Such population groups experience an extensive morbidity and mortality due to atherosclerosis. However, when such groups are compelled to abandon their life span dietary habits for a significant period of time (*e.g.*, the European experience during World War II), the tendency to atherosclerosis is reversed.<sup>3</sup>

Finally, atherosclerosis can be induced in animals (rabbit, chick, dog, monkey, guinea pig, hamster) *only* by feeding a diet high in cholesterol.<sup>3</sup> (The exception, estrogen-induced aortal atherosclerosis in chicks, is an exception that proves the rule, since the lesions are a consequence of hormone-induced hypercholesterolemic hyperlipemia.)

All these observations demonstrate that body structure (specifically plasma and arterial structure) is indeed in a steady state of flux, subject to profound influences from the life-span pattern of diet—influences which (in the case of high cholesterol-lipid intake) may lead to pathologic alteration, to atherogenesis.

In marshalling these facts and concepts about the relationship between diet and atherogenesis, there is no intention to propound any oversimplified idea that atherosclerosis is merely a problem of diet, pure and simple. When atherosclerosis is approached biologically as a phenomenon of groups (in contradistinction to the clinical approach to individuals), it is easy to see that such a view is erroneous. Thus, it would be relatively simple to select a group of 1,000 American males, aged 40 or 50 or 60, who over the life span have ingested a typical American diet high in cholesterol and fat. Despite the essentially identical patterns of food ingestion, marked individual differences would be present within the group in morbidity and ultimate mortality due to atherosclerosis (although over 90% would exhibit gross anatomic evidence of atherosclerosis).<sup>3, 5, 9</sup> Who among us is not familiar with the perennial octogenarian who has been eating ham and eggs (or the equivalent) morning, noon and night for lo these 80 years—apparently with complete immunity? And who among the males here is not jealously aware that the so-called weaker sex is remarkably immune to coronary atherosclerosis in the middle decades? This phenomenon can hardly be attributed to dietary differences.

However, lest such facts mislead us to the erroneous conclusion that diet has nothing to do with atherosclerosis, let us remind ourselves that among 1,000 males in another population group (*e.g.*, the Bantu or Okinawans), atherosclerosis would be as remarkably infrequent clinically and anatomically at age 40 or 50 or 60 as it is frequent in our 1,000 American males.<sup>3, 4</sup> And this ethnic group difference *can* be attributed to differences in life span pattern of diet, particularly cholesterol-lipid intake.

The ingestion over the years of a diet rich in cholesterol and lipid is apparently a prerequisite for the development of significant atherosclerosis in a population group. Individual differences—endogenous factors—come into play in determining whether a given person develops significant atherosclerosis. More correctly, the interrelationship is un-

doubtedly more complex, in that the nature of the given organism not only influences the response to diet, but the diet in turn influences the organism and its endogenous response to diet over the years. That is, as originally stated, there is a profound interplay throughout life between organism and diet, between endogenous and exogenous. What remains to be done is to unravel the precise details and mechanisms of this interrelationship.

This approach to the biology of atherosclerosis has been the theoretical foundation of this department's research program. Our main line of endeavor has been experimentally to delineate aspects of the interaction between diet and organism in atherogenesis. The general design of such experiments has been to feed an atherogenic diet and to analyze the response to that diet under varying conditions of endogenous function of the organism.

Based on data long extant on man, it was apparent that variations in *endocrine function* might play a key role in the response of the organism to a potentially atherogenic diet. The tendency to hypercholesterolemia and atherosclerosis in hypothyroidism, nephrosis, hyperadrenalism, and diabetes mellitus pointed in this direction. The variations in atherogenesis over the life span suggested a possible influence of the subtle changes in hormonal balance accompanying the several ages of man. Most striking was the marked sex difference in human susceptibility to coronary atherosclerosis—the remarkable immunity of premenopausal women to this disease, an immunity which markedly diminishes or disappears after the menopause.<sup>3</sup>

These findings of the clinic and the pathology laboratory were the specific background for our experimental program on the influences of endocrines on atherosclerosis in the cholesterol-fed chick. The choice of the chick was not fortuitous. An experimental animal was sought that would obviate the criticisms of previous work with rabbits (criticisms which, incidentally, are now known to be hardly valid).<sup>3</sup> An omnivorous species was looked for, and one that developed hardening of the arteries spontaneously, as well as in response to increased cholesterol ingestion. It was established that the domestic fowl meets these requirements, and is a splendid species for chronic experimental work in the laboratory.<sup>3, 10, 12</sup> For years a "farm" of 300–600 chickens has been maintained, varying in age from one day to two years. Considerable attention has been focussed on problems of control and quantitation with respect to the nutritional, biochemical, physiological, and pathological phenomena under study.<sup>3</sup>

It was found that over the life span chicks—like humans—exhibited variations in susceptibility to the atherogenic effect of a cholesterol-supplemented diet.<sup>3, 13</sup> During the first seven weeks of life, for example, cockerels on a mash supplemented with 2% cholesterol plus 5% cottonseed oil developed a hypercholesterolemia in the range 200–500 mg. % (normal: 100 mg. %), with minimal atherogenesis. At about eight weeks of age, cholesterolemia rose spontaneously to a level of 800–900 mg. %, and intensified atherogenesis supervened. This pattern persisted until about the 20th week of life, when plasma cholesterol levels again fell and atherogenic activity practically ceased. During the period 20–26 weeks of age, there was even a tendency to regression of aortal and coronary lesions. Similar, less clearly defined variations in response occurred at later age periods. The endogenous factors responsible for these variations remain to be determined.

The thyroid might be expected, on both clinical and experimental grounds,<sup>3</sup> to influence the organism's response to a high cholesterol intake. And in fact it proved possible

to demonstrate a tendency for thyroid hormone to inhibit diet-induced hypercholesterolemia and atherogenesis.<sup>3, 14</sup> All the organic iodine-containing compounds—thyroid powder, thyroxine, diiodotyrosine, triiodothyronine—tended moderately to depress hypercholesterolemia and atherogenesis;<sup>15</sup> in the dosages utilized, thyroxine was apparently the most effective. In contrast, potassium iodide had no such effect. Thyroid-stimulating hormone of the anterior pituitary (TSH) was also consistently without influence in chronic experiments. These thyroid-induced changes were not due simply to generalized hypermetabolism *per se*, since dinitrophenol failed to exert any influence.<sup>3, 16</sup>

However, the most conspicuous facts emerging from the several studies with thyroid hormone were the limitation and inconsistency of its effect. At most, hypercholesterolemia and atherogenesis were only partially inhibited. In some experiments, effects were minimal, even with doses of thyroid as large as 1.0% in the diet (1.0–2.0 grams/chick/day).

In view of the markedly intensified atherogenesis in human diabetes mellitus, another important aspect of our program was a survey of the influence of the pancreas. In one series of experiments, an extended study was made of the effects of various pancreatic preparations, oral and parenteral, on cholesterolemia and atherogenesis in intact and depancreatized cholesterol-fed cockerels.<sup>3, 17</sup> The results were entirely negative—with lipocaic, pancreatin, activated whole dried pancreas, lecithin, anti-fatty-liver factor and a parenteral pancreatic extract. This accorded with previous negative results with choline and inositol,<sup>3, 18, 19</sup> reinforcing the conclusion of the ineffectiveness of feeding large doses of lipotropic factors in atherosclerosis.

Of course, the foregoing experiments did not directly explore the effects of diabetes mellitus. Towards this end, studies were undertaken on the effects of pancreatectomy. These presented some species-difference difficulties, for depancreatized chicks on a normal diet manifested no evidence of deranged lipid or carbohydrate metabolism: growth and development were normal, as were plasma glucose, cholesterol, phospholipid and fatty acid levels; no fatty livers developed. However, in response to a diet supplemented with 2% cholesterol plus 5% cottonseed oil (2CO diet), pancreatectomized cockerels exhibited intensified hypercholesterolemia and atherogenesis.<sup>3, 20</sup> This abnormality was not manifested when cholesterol alone (without oil) was fed. At this time, one can only speculate as to the subtle interrelationships reflected by these empiric findings.

Having demonstrated a defect in lipid metabolism in pancreatectomized chicks, it remained to be seen whether any alterations in carbohydrate metabolism could be elicited, and whether thereby the objective of rendering chicks diabetic might be achieved. This was in fact accomplished by glucocorticoid administration. With exhibition of whole adrenal cortical extract or hydrocortisone (compound F), definitive evidence emerged of an abnormality in carbohydrate metabolism—*i.e.*, of a relative insulin deficiency in pancreatectomized (as well as alloxanized) chicks.<sup>3, 21</sup> The hormone-induced gluconeogenesis rendered these birds diabetic.

In order to proceed with the study of experimental atherogenesis in diabetic chicks, hydrocortisone (compound F) was administered in a chronic experiment to cholesterol-fed, alloxanized or depancreatized cockerels.<sup>3, 22, 23</sup> Sustained hyperglycemia supervened, with glycosuria; moderate to marked enhancement of hypercholesterolemia occurred, with an increase particularly of the low density lipoproteins. Despite these changes, how-

ever, these steroid-pancreatic diabetic chicks exhibited no intensified aortal or coronary atherogenesis. Hyperadrenalism with diabetes did not aggravate atherosclerosis in chicks ingesting an atherogenic diet. Here again, one can only speculate at this time as to the basis and significance of these experimental findings—findings which would appear to be in contrast to verified observations on man.

The foregoing study was simultaneously an aspect of our survey of the influence of adrenal cortical function on cholesterol-induced atherogenesis in chicks. The findings of these experiments may be briefly summarized: The mineralo-corticoid desoxycorticosterone acetate (DCA) induced polydypsia, polyuria, ascites, and moderate hypertension in cholesterol-fed cockerels, without influencing carbohydrate and lipid levels. A concomitant moderate intensification of aortal atherosclerosis supervened.<sup>3, 22, 24</sup> The glucocorticoid cortisone (compound E) was relatively inert in chicks. Even in large doses, it exerted minimal effects on growth and development, and on carbohydrate and lipid levels. It did, however, have moderate androgenic and pressor influences; concomitantly it effected a moderate intensification of coronary and aortal atherogenesis.<sup>3, 22, 23</sup> These results with DCA and cortisone reinforce the conclusion—derived from previous observations<sup>2</sup>—that hypertension, when present in an organism with an atherogenic potential, accelerates and intensifies atherogenesis.

As already indicated, hydrocortisone was highly active in the chick. In the intact cholesterol-fed cockerel, it induced retardation of growth and development, moderate hyperglycemia, and intensification of hypercholesterolemic hyperlipemia. No elevation of blood pressure occurred, nor was coronary or aortal atherogenesis aggravated.<sup>3, 22, 23</sup> ACTH tended to produce effects similar to those of hydrocortisone.<sup>3, 22, 23</sup> Thus, it was further confirmed that neither hyperadrenalism nor steroid diabetes *per se* markedly influenced cholesterol-induced atherogenesis in chicks.

By far the most striking results obtained to date in studies on hormones and atherosclerosis have been those with the estrogens. Given either parenterally or orally to cholesterol-fed cockerels, estrogens induced the following alterations: feminization; increase in the ratio of free to total plasma cholesterol (FC/TC); enhanced hyperphospholipemia with lowering of the ratio of plasma total cholesterol to lipid phosphorus (C/P) to normal levels; depression of  $\alpha$ -lipoprotein levels; reduction of S<sub>t</sub> 20–100+ levels; and prevention of coronary atherogenesis without influencing formation of aortal lesions.<sup>3, 22, 25</sup> These effects were seen with all estrogenically active compounds (oral or parenteral, natural or synthetic) tested to date—estradiol, estrone, equilenin, mixed conjugated equine estrogens, and diethylstilbestrol (pellet implantation). On the other hand, several estrogen-like compounds of low estrogenic potency, which failed to feminize in the dosages utilized, also failed to influence lipid patterns and coronary atherogenesis. Progesterone was likewise without influence.<sup>26</sup> Estrogens retained their effectiveness against coronary atherogenesis in depancrealized chicks, and in cockerels with hyperadrenalism and steroid diabetes, induced by concomitant administration of corticoids or ACTH.<sup>27</sup> Moreover, the estrogens apparently prevented DCA- and cortisone-induced hypertension.

Once these facts had been established, the questions immediately arose: Can the several estrogen effects be dissociated in any way? Can coronary lesions be prevented without feminization and/or alteration of plasma lipids? Appropriate experiments were designed to explore this problem. To date, partial success has been achieved. By combined

administration of estrogen and androgen in a 1:3 ratio, it proved possible to maintain male secondary sex characteristics, and yet to induce the typical estrogen effects on the lipids and the coronary vessels of cholesterol-fed cockerels.<sup>22, 28</sup>

All the foregoing experiments explored the prophylactic potential of estrogens against cholesterol-induced coronary atherogenesis. The questions insistently presented themselves: What about the therapeutic potential of estrogens? Could coronary lesions, once established, be reversed? This problem was subjected to experimental analysis. After feeding a cholesterol-oil diet for eight weeks, estrogen administration was instituted—with continued feeding of the atherogenic mash. At the end of thirteen weeks, *i.e.* after five weeks of estradiol exhibition, the coronary vessels were found to be practically free of lesions.<sup>22, 29</sup> The estrogen had reversed both the lipophage and fibroblastic components of the coronary atherosclerotic plaques. Coronary atherosclerosis is a reversible process!

All these studies were done in cockerels, *i.e.*, immature growing male chicks, utilizing dosages of exogenous estrogen that might be regarded as pharmacologic. Hence, an experiment was undertaken to determine the effects of the endogenous physiologic estrogen secretion of the egg-producing hen, and to compare the susceptibility of sexually mature male and female chickens to cholesterol-induced aortal and coronary atherogenesis. It was found that mature cholesterol-fed hens exhibited a plasma lipid pattern identical with that induced in cockerels by exogenous estrogens. Further, like estrogen-treated cockerels, they were remarkably immune to coronary (but not to aortal) atherosclerosis.<sup>30</sup> In contrast, cholesterol-fed roosters (lacking a supply of estrogen) developed extensive lesions in both the coronary vessels and aorta. Thus, sexually mature chickens, unlike immature birds,<sup>31</sup> but like sexually mature humans, exhibited a significant sex differential in susceptibility to coronary atherogenesis.

This immunity of estrogen-secreting, egg-producing hens to coronary atherogenesis was not due to mobilization and disposal of cholesterol and lipid via egg laying, since it was also present in oviduct-ligated hens, wherein yolks were deposited into the peritoneal cavity and subsequently reabsorbed.<sup>30</sup> This freedom from coronary lesions is undoubtedly a consequence of endogenous physiologic estrogen secretion. This sex difference in susceptibility to coronary atherogenesis in mature chickens, remarkably paralleling the phenomenon seen in humans, lends further support to the concept that estrogens play a key role in this human phenomenon.

These experimental findings with estrogens compel the formulation of several important questions: Why do estrogens exert their effect only on coronary atherogenesis? What is the basis for this finding of segmental differences in atherogenesis—a finding which has its parallel in man? How much previous work on experimental atherosclerosis is incomplete and hence misleading, because it confined itself to pathologic examination of changes in the aorta only?

What is the relationship between this segmental effect on the coronary vessels and the concomitant estrogen-induced alterations in plasma lipids? Are the changes in the plasma C/P and FC/TC ratios of key importance? Or the change in  $\alpha$ -lipoprotein? Or in S<sub>f</sub> 20–100+ levels? Or are all of these merely associated findings, unrelated to the ability of estrogens to prevent and reverse coronary atherogenesis? Is the estrogen effect mediated at all via plasma cholesterol-lipid-lipoprotein alterations, or is it rather mediated via direct action on the coronary vasculature—on intima-ground substance-elastin?



tic membrane permeability, or on lipophage-fibroblast activity, or on vasa vasorum? By what mechanisms does estrogen reverse both the lipophage and fibroblastic components of coronary atherosclerotic plaques? In any case, why not an effect on the entire arterial tree? Why the selective affinity for the coronary vessels?

Further, what is the significance for atherogenesis of other metabolic-physiologic effects of estrogens, *e.g.*, on clotting mechanisms and thrombus formation? Along the same line, what is the relationship of the estrogen effect on coronary atherogenesis to other, well-known actions of these hormones on the vascular tree—*e.g.*, their effects on caliber and permeation of small blood vessels? And how do estrogens prevent the rise in blood pressure ordinarily seen when DCA or cortisone are administered?

What is the significance (in terms of the basic problem of the relationship between diet and organism in atherogenesis) of the fact that estrogens reverse coronary lesions despite continued feeding of the atherogenic material, cholesterol—*i.e.*, that estrogens are effective despite persistent marked hypercholesterolemic hyperlipemia? And what influences are being exerted on the endocrines themselves by the diet fed in these chronic experiments (a question almost totally unexplored to date)?

Will it eventually prove possible to develop a preparation capable of preventing and reversing coronary lesions, without feminizing and altering lipid patterns? Or is this a biologic impossibility?

Is the effect of estrogens on cholesterol-induced coronary atherogenesis unique for avian species, or does it have general biologic significance for higher vertebrates, including mammals, particularly *Homo sapiens*? Are these experimental findings a key to the enigma of the sex difference in susceptibility to coronary atherosclerosis in humans—or is this a false lead?

Many of these questions are currently being attacked in this and other departments. This last is probably the crucial question from the viewpoint of our humanistic task as investigators to advance the prevention and cure of disease. Certainly considerable data are now available from human studies suggesting a decisive role of estrogen in the relative immunity of premenopausal women to clinically significant coronary atherosclerosis.<sup>3, 32, 34</sup> However, the last word on this still remains to be spoken. Nevertheless, the experimental and clinical findings have been positive enough to encourage us to embark upon a carefully controlled, thoroughgoing, long-term clinical study on the ability of estrogens to prevent recurrences of myocardial infarction and prolong life in males under age 50 who had a recent coronary attack. A definitive answer may be forthcoming in three to five years.

In conclusion, it may be said that—viewed over all—this program of experimental investigation on endocrines and atherosclerosis has demonstrated profound influences of the hormones on lipid metabolism and the atherogenic process. Moreover—in conformation of a basic thesis—it has indicated an intricate interplay between diet and endogenous, endocrine-regulated function of the organism. Lest any tendency arise to be over-impressed with current achievements, appropriate emphasis has been given to a few among many of the unanswered immediate questions posed by the findings themselves—questions demanding an answer if the general problem is to be solved. And by way of addendum—to undermine further any tendency to self-satisfaction—note should be taken of the fact that amidst the considerable body of research recently accomplished

on atherosclerosis, hardly a report has appeared on the influence of the central nervous system—the regulator, integrator, coordinator, and distributor of the entire activity (including the endocrine activity) of higher organisms.

It is most appropriate to conclude at this point—on a note emphasizing the questions unanswered, the investigations not yet completed or even begun.

#### ACKNOWLEDGMENTS

It is a pleasure to acknowledge the contribution to this research program over the years of our former and present principal associates, Drs. D. V. Dauber, L. Horlick, and S. Rodbard. These investigations were successfully accomplished only by virtue of the excellent cooperation and assistance of the technical members of the department's atherosclerosis research group: L. Adams, E. Arnold, P. Bland, C. Bolene-Williams, G. Crowley, M. Dudley, W. Foote, L. Friedberg, D. Friedman, L. Havel, P. Johnson, C. Kakita, E. Levinson, J. Meyer, M. Michael, J. Morris, and Ronald Wallace.

#### REFERENCES

1. Gutman, A. B.: Editorial: Present Status of Atherosclerosis as a Derangement of Lipid Metabolism *Am. J. Med.* 14: 1, 1953.
2. Pihl, A.: Cholesterol Studies II. Dietary Cholesterol and Atherosclerosis, *Scandinav. J. Clin. & Lab. Invest.* 4: 122, 1952.
3. Katz, L. N., and Stamler, J.: *Experimental Atherosclerosis*, Springfield, Illinois, Charles C. Thomas, 1953.
4. Keys, A.: Atherosclerosis: A Problem in Newer Public Health, *J. Mt. Sinai Hosp.* 20: 118, 1953.
5. Dock, W.: Atherosclerosis—Inevitable or Controllable? *Canad. M. A. J.* 69: 355, 1953.
6. Gould, R. G.: Factors Controlling Cholesterol Synthesis in the Body, *Proc. Annual Meeting, Council for High Blood Pressure Research, American Heart Association*, 1952, p. 3.
7. Schoenheimer, R.: *The Dynamic State of Body Constituents*, Cambridge, Mass., Harvard University Press, 1942.
8. Stamler, J.: Paleonutrition, Paleopathology, Modern Biochemistry and the Problem of Diet and Atherosclerosis, in preparation.
9. Enos, W. F., Holmes, R. H., and Beyer, J.: Coronary Disease Among United States Soldiers Killed in Action in Korea, *J.A.M.A.* 152: 1090, 1953.
10. Dauber, D. V., and Katz, L. N.: Experimental Cholesterol Atheromatosis in an Omnivorous Animal, the Chick, *Arch. Path.* 34: 937, 1942.
11. Dauber, D. V., and Katz, L. N.: Experimental Atherosclerosis in the Chick, *Arch. Path.* 36: 473, 1943.
12. Dauber, D. V.: Spontaneous Arteriosclerosis in Chickens, *Arch. Path.* 38: 46, 1944.
13. Rodbard, S., Bolene, C., Pick, R., Lowenthal, M., Gros, G., and Katz, L. N.: The Age Factor in Cholesterolemia and Atheromatosis in the Chick, *Circulation* 2: 473, 1950.
14. Dauber, D. V., Horlick, L., and Katz, L. N.: The Role of Desiccated Thyroid and Potassium Iodide in the Cholesterol-Induced Atherosclerosis of the Chicken, *Am. Heart J.* 38: 25, 1949.
15. Stamler, J., Pick, R., and Katz, L. N.: Further Studies on the Effects of Thyroid Hormones and Thyroid Stimulating Hormone on Hyperlipemia and Atherogenesis in the Cholesterol-Fed Chick, in preparation.
16. Stamler, J., Silber, E. N., Miller, A. J., Akman, L., Bolene, C., and Katz, L. N.: The Effect of Thyroid- and of Dinitrophenol-Induced Hypermetabolism on Plasma and Tissue Lipids and Atherosclerosis in the Cholesterol-Fed Chick, *J. Lab. & Clin. Med.* 35: 351, 1950.
17. Stamler, J., Pick, R., and Katz, L. N.: Failure of Vitamin E, B<sub>12</sub> and Pancreatic Extracts to Influence Plasma Lipids and Atherogenesis in Cholesterol-Fed Chicks, *Circulation* 8: 455, 1953.
18. Stamler, J., Bolene, C., Harris, R., and Katz, L. N.: Effect of Choline and Inositol on Plasma and Tissue Lipids and Atherosclerosis in the Cholesterol-Fed Chick, *Circulation* 2: 714, 1950.
19. Stamler, J., Bolene, C., Harris, R., and Katz, L. N.: Effect of Choline and Inositol on Plasma and

- Tissue Lipid and on Spontaneous and Stilbestrol-Induced Atherosclerosis in the Chick, *Circulation* 2: 722, 1950.
20. Stamler, J., and Katz, L. N.: The Effect of Pancreatectomy on Lipemia, Tissue Lipidosis and Atherogenesis in Chicks, *Circulation* 4: 255, 1951.
  21. Stamler, J., and Pick, R.: Marked Acute Hyperglycemic Response of Depancreatized Chicks to Adrenal Cortical Extract (ACE), *Proc. Soc. Exper. Biol. & Med.* 75: 803, 1950.
  22. Stamler, J.: Sex and Adrenal Steroids in Experimental Atherosclerosis, *Proc. Annual Meeting, Council for High Blood Pressure Research, American Heart Association* 1952, p. 45.
  23. Stamler, J., Pick, R., and Katz, L. N.: Effects of Cortisone, Hydrocortisone and ACTH on Lipemia, Glycemia and Atherogenesis in Cholesterol-Fed Chicks, *Circulation* 10: 237, 1954.
  24. Stamler, J., Pick, R., and Katz, L. N.: Effect of Desoxycorticosterone Acetate on Cholesterolemia, Blood Pressure and Atherogenesis in Chicks, *Circulation* 4: 262, 1951.
  25. Pick, R., Stamler, J., Rodbard, S., and Katz, L. N.: The Inhibition of Coronary Atherosclerosis by Estrogens in Cholesterol-Fed Chicks, *Circulation* 6: 276, 1952.
  26. Stamler, J., Pick, R., and Katz, L. N.: Further Studies on Estrogen Prophylaxis of Cholesterol-Induced Coronary Atherogenesis, *Circulation* 8: 436, 1953.
  27. Stamler, J., Pick, R., and Katz, L. N.: Estrogen Prophylaxis of Cholesterol-Induced Coronary Atherogenesis in Chicks Given Adrenal Corticoids or ACTH, *Circulation* 10: 247, 1954.
  28. Stamler, J., Pick, R., and Katz, L. N.: Prevention of Coronary Atherosclerosis by Estrogen-Androgen Administration in the Cholesterol-Fed Chick, *Circulation Res.* 1: 94, 1953.
  29. Pick, R., Stamler, J., Rodbard, S., and Katz, L. N.: Estrogen-Induced Regression of Coronary Atherosclerosis in Cholesterol-Fed Chicks, *Circulation* 6: 858, 1952.
  30. Stamler, J., Pick, R., and Katz, L. N.: Inhibition of Cholesterol-Induced Coronary Atherogenesis in the Egg-Producing Hen, *Circulation* 10: 251, 1954.
  31. Rodbard, S., Bolene-Williams, C., Pick, R., and Katz, L. N.: A Comparison of the Tendency to Cholesterol-Induced Atherogenesis in Young Male and Female Chicks, in preparation.
  32. Wuest, J. H., Jr., Dry, T. J., and Edwards, J. E.: The Degree of Coronary Atherosclerosis in Bilaterally Oophorectomized Women, *Circulation* 7: 801, 1953.
  33. Gertler, M. M., Hudson, P. B., and Jost, H.: Effects of Castration and Diethylstilbestrol on the Serum Lipid Pattern in Men, *Geriatrics* 8: 500, 1953.
  34. Barr, D. P.: Some Chemical Factors in the Pathogenesis of Atherosclerosis, *Circulation* 8: 641, 1953.

## DISCUSSION

*Dr. Paterson* asked whether *Dr. Katz* could explain the absence of cardiac infarcts in the extreme grades of coronary atherosclerosis that are produced experimentally in the chicken.

*Dr. Katz* replied that the study of atherosclerosis does not ordinarily include myocardial infarction; that the latter is a focal localization of an extreme degree of the process, associated with ulceration and thrombosis, and with heart strain. He added that chickens, unlike human subjects, are not subject to extraordinary strain.

*Dr. Paterson* reported that he had fed cholesterol to chickens and had then subjected them to repeated electrical shocks while they were feeding, over long periods of time, but had failed to produce cardiac infarcts.

*Dr. Taylor* suggested that in his long-term study of young persons with myocardial infarcts *Dr. Katz* should give consideration to following their pulse-wave velocities. He felt that this procedure would probably be more instructive than repeated electrocardiograms.

*Dr. Katz* replied that aside from their use in bioassay, he was not using electrocardiograms in his study. For the moment, no pulse-wave velocity studies were contemplated.

## SUMMARY OF PART V

CHRISTIAN B. ANFINSEN

The subject matter of this afternoon's papers is of a sort that is particularly enjoyable to attempt to summarize, because it has to do with an area of metabolism which is essentially uncharted and yet clearly an area of most fruitful possibilities. As we have heard during the presentation of these papers, we are dealing with molecules whose ubiquity is well recognized but whose chemical structures and metabolic significances are almost entirely obscure. Dr. Surgenor has pointed out that certain well-defined lipoprotein fractions can be isolated and characterized chemically. Thus, we have evidence of two major classes of lipoproteins: first, those of the low-density, so-called beta lipoprotein type, and second, a class of higher-density components termed alpha lipoproteins. Information on the former class is most clearly defined in the case of the normal beta<sub>1</sub> lipoprotein, characterized by a cholesterol to phospholipid ratio of about 2.0 on a molar basis and a free to total cholesterol ratio of about 0.3. The alpha lipoprotein, on the other hand, shows a cholesterol to phospholipid ratio of about 1. Neither of these two classes appears to contain significant quantities of triglycerides. In connection with these characterizing ratios it should be pointed out, however, that the numbers I have just mentioned are not necessarily rigidly established ones. Upon comparison of data obtained on samples prepared by chemical and ultracentrifugal methods of separation, there appear rather marked variations in the total amounts of the two lipoprotein classes of plasma, and in their relative contents of cholesterol and phospholipid. The finding of lower quantities of lipoproteins in plasma when determined by ultracentrifugal analysis than when calculated from chemical analysis suggests particularly that further scrutiny of the optical methods used for ultracentrifugal quantitation might be of considerable interest.

One statement of fact which has been made repeatedly during the last two days would certainly appear to be a well-founded one, namely, that all plasma lipid is present as lipoprotein. Again, as has been stressed by both Dr. Eder and Dr. Surgenor, this fact leads us to a situation where it is clear that we should consider the lipid content of plasma, not in terms of the analytical values for the individual lipid components, but rather in terms of the distribution of these components between the two major classes of lipoproteins. The methodology now available makes the collection of such data reasonably simple, experimentally, and the use of such more rational parameters should permit us to appraise much more accurately the subtle metabolic influences which condition the ratio of the concentrations of the alpha and beta lipoprotein components of plasma.

As everyone in the field of lipoprotein chemistry will agree, the probability of heterogeneity in the alpha and beta lipoprotein fractions, although not yet systematically explored, seems a very likely one. In this connection, it is perhaps reasonable to introduce a note of caution in connection with the interpretation of many of the data already available. Many of these data, based on physical measurements, must be carefully examined, it seems to me, for the presence of artifactual findings resulting from the nonspecific binding or adsorption of lipid components such as fatty acids, phospholipid, di- and monoglycerides, etc. Thus, electrophoretic differences produced by excesses or deficiencies of fatty acid binding on lipoprotein components of plasma, particularly in disease,

might well lead to erroneous conclusions from the experimental data. Similarly, the degree of binding of triglycerides in the beta lipoprotein class, with possible resulting changes in the levels of secondarily bound cholesterol, cholesterol esters, and phospholipid, might well lead to considerable confusion, in the absence of careful control, concerning the specificity of such binding and the nature and origin of the protein moieties of these low-density molecules.

To digress momentarily before returning to this thread of thought, let us consider some of the alternatives that have been suggested by the presentations we have heard.

We have been concerned here with the phenomenon of atherogenesis and consequently, for the sake of simplicity, may limit ourselves to consideration of circumstances in vessel tissue and in circulating blood. We have, on the one hand, to consider the metabolism of the vessel itself, in which one cannot as yet rule out the possible endogenous overproduction of specific lipid components or the faulty utilization of one or more of the lipid components deposited there in lipoprotein form, derived from other sources than the vessel itself. Endogenously produced vascular lesions seem perhaps somewhat unlikely at the present, in view of the rather sluggish activity of arterial tissue in respect to cholesterol and protein metabolic processes. Nevertheless, metabolic studies such as those recently performed by Chaikoff, Frantz, Zilversmit, and others, as well as chemical and physical characterizations as discussed by Dr. Batchelor, may ultimately strengthen the case for this possibility.

As we all know, a more popular view during recent years has been that lesions are related to factors in plasma. This hypothesis implies that plasma contains lipoproteins of abnormal chemical or physical characteristics with specific affinity for vessel tissue. The presence of such abnormal components rests at present, to the best of my knowledge, mainly on inference. The assumption that they are present does not seem too far-fetched in view of the highly suggestive correlations obtained in such studies as were discussed by Dr. Eder and Dr. Katz this afternoon.

"Abnormal" lipoproteins could accumulate in plasma as the result of several metabolic defects which might tend to increase the concentration of plasma components of normally transient existence. First, tissues which remove and metabolize lipid which is in the process of transport might be defective in their abilities to do so. Second, abnormal concentrations of these molecules might accumulate by overloading of the transport mechanism as a consequence of abnormally stimulated fat mobilization from one tissue to another. Third, we cannot rule out effects, similar to those observed by Byers and Friedman and others with synthetic detergents, in which an abnormal metabolic product analogous to Triton might, in combination with lipoproteins, prevent their normal catabolism. This first general hypothesis implies the presence of "abnormal" molecules derived from "normal" lipoprotein molecules (such as those that exist in the plasma of healthy young females).

A second general hypothesis might be constructed based on the thesis that there occurs a *de-novo* production of lipoprotein of an entirely new species, both as regards the protein part and the lipid part of the molecule. This latter possibility seems highly unlikely, since it would imply a new protein synthetic mechanism and a genetic change in the control of protein synthesis.

Let us attempt to construct a hypothesis, embodying as little complication as possible, which might adequately satisfy the experimental findings that have been discussed.

This hypothesis is, in fact, a reiteration in less positive terms of the concepts proposed by Gofman, Pedersen, and others. We must necessarily disregard the role of the alpha lipoproteins, since we have, at present, no conception of the metabolic function of the substances in this class. Let us suppose that the normal beta lipoprotein (with perhaps a certain degree of heterogeneity, but having in general well-defined ratios of cholesterol and phospholipid and a fixed protein structure), upon extrusion from its site of synthesis, is converted to materials of various lower densities by the adherence of triglyceride from the various tissues perfused by the plasma in which this protein resides. Let us superimpose on this basic situation the simultaneous or subsequent adherence to the molecule, either enzymatically or by virtue of physical solubility or charge effects, of other lipid constituents. We know that such characteristics as cholesterol-phospholipid ratios are altered in lipoproteins of very low density as compared to the "normal" beta component. It seems quite possible that such aberrations in chemical and physical features might well be due to variations in the availability of phospholipid, cholesterol, and fatty acids for binding, as well as the relative metabolic efficiency of tissues in the delipidation of these molecules during circulation. In this simplified picture we might conceive, therefore, that the fundamental metabolic error is present at a metabolic level, involving lipoprotein metabolism and synthesis combined with physical factors leading to peculiar propensities for arterial wall tissue, such as chemical composition, size, solubility, or charge.

The construction of hypotheses that fit with most of the experimental findings in the field of atherosclerosis is a relatively simple task since, at present, we have to deal only with the surface of the problem. Such mental gymnastics, however, merely evade the central question at hand, namely, the nature of the controlling mechanisms which determine normality and abnormality.

At various times during the discussions of the past two days, note has been taken of the marked correlation which can be made between the ratios of alpha to beta lipoprotein components, as well as to their absolute concentrations. Such correlations as have been indicated to us by Dr. Eder are certainly highly suggestive, and point up the necessity for a serious consideration of the metabolic origin and function of alpha lipoproteins. In view of the rapidity of lipid exchange on lipoprotein molecules, it has seemed to us that the logical and obvious approach to this problem must now be made through the study of the protein moieties of lipoproteins, since these structures will undoubtedly exhibit the chemical and genetic rigidity generally embodied in the structure of a biologically specific molecule. Studies in this direction, with the use of amino-acid labelling, should predictably open a large and fruitful field of research.

Equally striking in these discussions has been the obvious though completely unexplainable influence of hormones on the pattern of lipoprotein distribution and metabolism. The common parameters at present appear to be most likely concerned with sex hormones and age, at least in the human. The plasma lipoprotein patterns, when taken together with susceptibility to atherosclerotic changes in various animal species, suggests further the involvement of other hormonal influences not apparent at present. In my own discussion on the possible role of heparin in these processes, I have gone so far as to suggest that one might even conceive of heparin, or one of its derivatives, as a hormone itself.

I think most of us will agree at the present time that the future of research in this field

lies in the study of the factors controlling lipid metabolism and, more specifically, lipoprotein metabolism, since it is in this area that the most reasonable experimental correlations with the atherosclerotic process have been observed.

### CONCLUDING REMARKS

*Dr. Page* expressed his appreciation to the participants for keeping within the allotted time. He spoke for the group in thanking the Air Force for its sponsorship of a symposium which had been profitable to all in attendance. He also expressed his recognition of the work involved in the arrangements made by the Academy-Council staff for the symposium.

In closing he read the quotation from Aristotle that is inscribed on the National Academy of Sciences building: "The search for Truth is in one way hard and in another easy. For it is evident that no one can master it fully nor miss it wholly. But each adds a little to our knowledge of Nature, and from all the facts assembled there arises a certain grandeur."

*Dr. Winternitz* expressed his thanks to *Dr. Page* for his service as Chairman of the Symposium.







---

RC 692 .N3 1954

National Research Council  
(U.S.). Division of Medical

Symposium on atherosclerosis

---