



Permafrost International Conference: Proceedings (1966)

Pages
576

Size
8.5 x 11

ISBN
030933912X

Building Research Advisory Board; National Research Council

 [Find Similar Titles](#)

 [More Information](#)

Visit the National Academies Press online and register for...

- ✓ Instant access to free PDF downloads of titles from the
 - NATIONAL ACADEMY OF SCIENCES
 - NATIONAL ACADEMY OF ENGINEERING
 - INSTITUTE OF MEDICINE
 - NATIONAL RESEARCH COUNCIL
- ✓ 10% off print titles
- ✓ Custom notification of new releases in your field of interest
- ✓ Special offers and discounts

Distribution, posting, or copying of this PDF is strictly prohibited without written permission of the National Academies Press. Unless otherwise indicated, all materials in this PDF are copyrighted by the National Academy of Sciences.

To request permission to reprint or otherwise distribute portions of this publication contact our Customer Service Department at 800-624-6242.

Copyright © National Academy of Sciences. All rights reserved.



CONTRIBUTING SPONSORS

BUREAU OF PUBLIC ROADS
CATERPILLAR TRACTOR COMPANY
NATIONAL SCIENCE FOUNDATION
OFFICE OF CIVIL DEFENSE
OFFICE OF NAVAL RESEARCH
PURDUE UNIVERSITY SCHOOL OF CIVIL ENGINEERING
U. S. AIR FORCE CAMBRIDGE RESEARCH LABORATORIES, TERRESTRIAL SCIENCE LABORATORY
U. S. ARMY CORPS OF ENGINEERS
U. S. ARMY MATERIEL COMMAND
U. S. NAVY FACILITIES ENGINEERING COMMAND
U. S. PUBLIC HEALTH SERVICE

COOPERATING ORGANIZATIONS

AMERICAN GEOPHYSICAL UNION
AMERICAN SOCIETY OF CIVIL ENGINEERS, SOILS MECHANICS AND FOUNDATIONS DIVISION
AMERICAN SOCIETY FOR TESTING AND MATERIALS, DIVISION OF MATERIALS SCIENCES
NATIONAL ACADEMY OF SCIENCES—NATIONAL RESEARCH COUNCIL, HIGHWAY RESEARCH BOARD
NATIONAL RESEARCH COUNCIL OF CANADA, ASSOCIATE COMMITTEE ON SNOW AND SOIL MECHANICS

PROCEEDINGS

International Conference on

PERMAFROST

INTERNATIONAL CONFERENCE

11-15 NOVEMBER 1963
LAFAYETTE, INDIANA

PRESENTED BY

BUILDING RESEARCH ADVISORY BOARD
NATIONAL ACADEMY OF SCIENCES—NATIONAL RESEARCH COUNCIL
WASHINGTON, D. C.

AT

PURDUE UNIVERSITY

GENERAL CONFERENCE CHAIRMAN
KENNETH B. WOODS

PLANNING COMMITTEE
A. J. ALTER
JAMES A. BENDER
RICHARD L. CAMERON
TREVOR A. HARWOOD
ARTHUR H. LACHENBRUCH
ROBERT F. LEGGET
KENNETH A. LINELL
ROBERT D. MILLER
WILLIAM J. NIEMI
TROY L. PÉWÉ
A. L. WASHBURN

NATIONAL ACADEMY OF SCIENCES—NATIONAL RESEARCH COUNCIL
WASHINGTON, D. C.

PUBLICATION NO. 1287

1 B 641.76

1963

e.1

Price: \$35.00

**Available through the
Printing and Publishing Office
National Academy of Sciences—National Research Council
Washington, D. C. 20418**

**Inquiries concerning this publication should be addressed to:
The Executive Director, Building Research Advisory Board,
National Academy of Sciences—National Research Council,
2101 Constitution Avenue, N.W.,
Washington, D. C. 20418**

Library of Congress Catalog Card Number: 65-60092

PB 222 484

FOREWORD

This first International Conference on Permafrost was presented by the Building Research Advisory Board on 11-15 November 1963, with Purdue University serving as host, and with sponsorship provided by both public agencies and private organizations. Bringing together some 300 engineers, researchers, manufacturers, and builders from around the world, the conference represented the first effort to achieve a comprehensive exchange of information on the fundamental properties and behavior of permafrost, and the related findings of water, snow, and ice research, as well as engineering and construction solutions for problems of building in permafrost areas.

The published Proceedings contains papers presented by scientists and engineers from nine countries (Argentina, Canada, Germany, Japan, Norway, Poland, Sweden, USA, and USSR) together with pertinent discussions, to constitute at this time the most comprehensive compendium of current information on permafrost. Editing of these manuscripts has been kept to a minimum, and has been directed solely toward achieving essential consistency while preserving the total integrity of the contribution of each author.

The Board gratefully acknowledges the effort expended by each participant and supporter: Conference committee and discussion panel members, organizational sponsors, and authors. A particular word of thanks is due to Professor F. J. Sanger for provision of translations from the Russian.

The Board also wishes to acknowledge the originating efforts of Mr. Harry B. Zackrison, Sr., Chairman of the Board at the time of program initiation, and the implementing efforts led by Mr. Richard H. Tatlow III, Chairman at the time the Conference was held.

ALBERT G. H. DIETZ

Chairman

BUILDING RESEARCH ADVISORY BOARD

CONFERENCE RESOLUTION

WHEREAS the first International Conference on Permafrost has assembled scientists and engineers from Argentina, Austria, Canada, Great Britain, Japan, Norway, Poland, Sweden, Switzerland, United States of America, Union of Soviet Socialist Republics and West Germany for discussion of more than 100 papers, considering the many scientific and engineering interests and viewpoints on permafrost and related physical, chemical, geological, biological and engineering problems on both an interdisciplinary and international basis; and

WHEREAS the significant advancement made toward cooperative, systematic, interdisciplinary, international study and assessment of permafrost phenomena made through conferences such as this first International Conference on Permafrost has been demonstrated to contribute immeasurably to scientific and engineering progress; now, therefore,

BE IT RESOLVED that this conference urges that a second International Conference on Permafrost be planned and held with the objectives of further interdisciplinary support and participation, and

BE IT FURTHER RESOLVED that the Planning Committee for the first International Conference on Permafrost be requested to form an interim committee of international, interdisciplinary character to foster and encourage a second International Conference on Permafrost, and

BE IT FURTHER RESOLVED that copies of this resolution be forwarded to the National Academy of Sciences—National Research Council, and to all participants, sponsors, and cooperating organizations in the first International Conference on Permafrost.

CONTENTS

SESSION I GENERAL SESSION

HARRY B. ZACKRISON, SR.
 K. B. WOODS
 Opening Remarks
 ROBERT F. LEGGET
 Permafrost in North America
 N. A. TSYTOVICH
 Permafrost Problems

SESSION II SOILS AND VEGETATION PANEL 2a

WILLIAM S. BENNINGHOFF
 Relationships between Vegetation and Frost in Soils
 ROLAND E. BESCHEL
 Hummocks and Their Vegetation in the High Arctic
 R. J. E. BROWN
 Influence of Vegetation on Permafrost
 ALBERT W. JOHNSON
 Plant Ecology in Permafrost Areas
 JOHN B. O'SULLIVAN
 Geochemistry of Permafrost: Barrow, Alaska
 NORMAN W. RADFORTH
 Origin and Significance of Organic Terrain Features
 HUGH M. RAUP
 Turf Hummocks in the Mesters Vig District,
 Northeast Greenland
 J. C. F. TEDROW
 Arctic Soils
 F. C. UGOLINI
 Soil Investigations in the Lower Wright Valley, Antarctica

MASSIVE GROUND ICE PANEL 2b

ARTHUR H. LACHENBRUCH
 Contraction Theory of Ice-Wedge Polygons:
 A Qualitative Discussion
 J. ROSS MACKAY
 Pingos in Canada
 TROY L. PÉWÉ
 Ice-Wedges in Alaska—Classification, Distribution,
 and Climatic Significance
 ERWIN SCHENK
 Origin of Ice-Wedges
 G. WILLIAM HOLMES
 HELEN L. FOSTER
 DAVID M. HOPKINS
 Distribution and Age of Pingos of Interior Alaska
 JERRY BROWN
 Ice-Wedge Chemistry and Related Frozen Ground
 Processes, Barrow, Alaska

I. J. BARANOV
 V. A. KUDRYAVTSEV
 Permafrost of Eurasia
 B. N. DOSTOVALOV
 A. I. POPOV
 Polygonal Systems of Ice-Wedges and Conditions
 of Their Development
 V. A. KUDRYAVTSEV
 Theory of the Development of Frozen Rock Masses
 P. A. SHUMSKIY
 B. I. VTYURIN
 Underground Ice

SESSION III GEOMORPHOLOGY

J. BRIAN BIRD
 Limestone Terrains in Southern Arctic Canada
 ROBERT F. BLACK
 THOMAS E. BERG
 Patterned Ground in Antarctica
 FRANK A. COOK
 Patterned-Ground Research in Canada
 ARTURO E. CORTÉ
 Experiments on Sorting Processes and the Origin of
 Patterned Ground
 K. R. EVERETT
 Instruments for Measuring Mass-Wasting
 ALFRED JAHN
 Origin and Development of Patterned Ground in
 Spitsbergen
 JAN LUNDQVIST
 Patterned Ground in Sweden
 ANDERS RAPP
 Solifluction and Avalanches in the
 Scandinavian Mountains
 ERWIN SCHENK
 Origin of String Bogs
 JOHN R. WILLIAMS
 ROGER M. WALLER
 Ground Water Occurrence in Permafrost Regions of Alaska
 H. J. WALKER
 L. ARNBORG
 Permafrost and Ice-Wedge Effect on Riverbank Erosion
 OSCAR J. FERRIANS, JR.
 Permafrost Map of Alaska
 DONALD R. NICHOLS
 Permafrost in the Recent Epoch
 L. V. BRANDON
 Evidences of Ground Water Flow in Permafrost Regions
 I. J. BARANOV
 Problems of Zonal Relationships in the Development
 of Permafrost

A. I. POPOV S. P. KACHURIN N. A. GRAVE Features of the Development of Frozen Geomorphology in Northern Eurasia Discussion—Session 3	181 185	M. S. KERSTEN Thermal Properties of Frozen Ground F. J. SANGER C. W. KAPLAR Plastic Deformation of Frozen Soils RAYMOND N. YONG Soil Freezing Considerations in Frozen Soil Strength GEORGE W. AITKEN Reduction of Frost-Heave by Surcharge Loading N. A. TSYTOVICH Instability of Mechanical Properties of Frozen and Thawing Soil S. S. VYALOV Rheology of Frozen Soils Discussion—Session 6	301 305 315 319 325 332 338
SESSION IV PHASE EQUILIBRIA AND TRANSITIONS			
G. R. LANGE H. L. MCKIM Saturation, Phase Composition, and Freezing-Point Depression in a Rigid Soil Model R. D. MILLER Phase Equilibria and Soil Freezing EDWARD PENNER Frost-Heaving in Soils SHUNSUKE TAKAGI Fundamentals of the Theory of Frost-Heaving SHUNSUKE TAKAGI Theory of Freezing-Point Depression with Special Reference to Soil Water P. J. WILLIAMS Suction and Its Effects in Unfrozen Water of Frozen Soils Z. A. NERSEOVA N. A. TSYTOVICH Unfrozen Water in Frozen Soils I. A. TYUTYUNOV Phase Transformations of Water in Soils and the Nature of Migration and Heaving Discussion—Session 4	187 193 197 203 216 225 230 234 238	SESSION VII EXPLORATION AND SITE SELECTION R. E. FROST J. H. McLERRAN R. D. LEIGHTY Photointerpretation in the Arctic and Sub-Arctic DAVID F. BARNES Geophysical Methods for Delineating Permafrost B. L. HANSEN Instruments for Temperature Measurements in Permafrost T. A. HARWOOD Dew Line Site Selection and Exploration M. JUUL HVORSLEV T. B. GOODE Core Drilling in Frozen Soils G. H. JOHNSTON Engineering Site Investigations in Permafrost Areas G. R. LANGE Refrigerated Fluids for Drilling and Coring in Permafrost J. D. MOLLARD J. A. PIHLAINEN Airphoto Interpretation Applied to Road Selection in the Arctic G. Y. SEBASTYAN Preliminary Site Investigation for the Foundation of Structures and Pavements in Permafrost V. P. BAKAKIN A. N. ZELENIN Excavation of Frozen Soils V. P. USHKALOV A. M. PCHELINTSEV A. I. YEFIMOV A. I. DEMENTYEV Engineering Geocryological Research Discussion—Session 7	343 349 356 359 364 371 375 381 387 395 400 405
SESSION V THERMAL ASPECTS			
R. J. E. BROWN Relation Between Mean Annual Air and Ground Temperatures in the Permafrost Region of Canada E. F. LOBACZ W. F. QUINN Thermal Regime Beneath Buildings Constructed on Permafrost F. J. SANGER Degree-Days and Heat Conduction in Soils R. F. SCOTT Factors Affecting Freeze or Thaw Depth in Soils SV. SKAVEN-HAUG Control of Frost Penetration in Norway H. A. THOMPSON Air Temperatures in Northern Canada with Emphasis on Freezing and Thawing Indexes V. S. LUK'YANOV Computation of the Depth of Freezing and Thawing in Soils G. V. PORKHAYEV Temperature Fields in Foundations Discussion—Session 5	241 247 253 263 268 272 281 285 291	SESSION VIII SANITARY AND HYDRAULIC ENGINEERING AMOS J. ALTER Sanitary Engineering in Alaska D. G. BALL I. H. CALL U.S. Sanitary and Hydraulic Engineering Practice in Greenland	407 409
SESSION VI PHYSICO-MECHANICAL PROPERTIES OF FROZEN GROUND			
C. W. KAPLAR Laboratory Determination of the Dynamic Moduli of Frozen Soils and of Ice	293		

A. B. YATES		E. L. LONG	
D. R. STANLEY		The Long Thermopile	487
Domestic Water Supply and Sewage Disposal in the Canadian North	413	D. H. MACDONALD	
WARREN GEORGE		Design of Kelsey Dikes	492
Water Supply and Drainage in Alaska	420	I. MIYAKAWA	
G. L. HUBBS		M. KOYAMA	
Water Supply Systems in Permafrost Areas	426	T. TAKAHASHI	
LARS-ERIC JANSON		Frost-Heave of Roads in Hokkaido, Japan	497
Water Supply Systems in Frozen Ground	430	R. W. J. PRYER	
W. B. PAGE		Mine Railroads in Labrador-Ungava	503
Arctic Water Supply and Wind Energy	434	E. S. PHILLEO	
E. F. RICE		Guides for Engineering Projects on Permafrost	508
O. W. SIMONI		A. E. PIKE	
The Hess Creek Dam	436	Mining in Permafrost	512
CHARLES SARGENT		GORDON B. PRITCHARD	
Water Works Supply Systems in-Permafrost Areas	440	Foundations in Permafrost Areas	515
M. J. SASSANI		GEORGE K. SWINZOW	
Sanitary and Hydraulic Engineering in the Antarctic	442	Tunneling and Subsurface Installations in Permafrost	519
KENNETH R. WRIGHT		S. THOMSON	
ORREN W. FRICKE		Icings on the Alaska Highway	526
Water-Freezing Problems in Mountain Communities	447	JAMES A. BROWNING	
P. A. BOGOSLOVSKIY		JAMES F. ORDWAY	
V. A. VESELOV		Use of Internal Burners for Working Permafrost and Ice	530
S. B. UKHOV		ROBERT M. DAVIS	
A. V. STOTSENKO		Gravel Fill Roads on Permafrost and Glacier Ice	535
A. A. TSVID		B. A. RZHANITSIN	
Dams in Permafrost Regions	450	B. P. GORBUNOV	
M. M. PORFIR'YEV		L. I. KURDENKOV	
G. V. PORKHAYEV		V. F. ZHUKOV	
Utility Networks in Permafrost Regions	455	A. N. KURYACHIN	
N. I. TOLSTIKHIN		Thawing and Consolidation of Permafrost Prior to Construction	538
N. A. VEL'MINA		P. I. MEL'NIKOV	
A. I. YEFIMOV		S. S. VYALOV	
Hydrogeology in Permafrost Regions of the USSR	458	O. V. SNEZHKO	
Discussion—Session 8	462	G. F. SHISHKANOV	
		Pile Foundations in Permafrost	542
SESSION IX		SESSION X	
EARTHWORK AND FOUNDATION ENGINEERING		CLOSING SESSION	
E. H. BEISTLINE		Moderators' Report	549
Placer Mining in Frozen Ground	463	Appendix	
FREDERICK E. CRORY		Conference Committee	559
Pile Foundations in Permafrost	467	Conference Panels	559
G. H. JOHNSTON		Conference Registrants	561
Pile Construction in Permafrost	477		
K. A. LINELL			
C. W. KAPLAR			
Description and Classification of Frozen Soils	481		

SESSION I GENERAL SESSION

OPENING REMARKS

HARRY B. ZACKRISON, SR., Chief, Engineering Division Military Construction,
Office of Chief of Engineers, Department of the Army

We have assembled here at this famous campus the ideas of the most knowledgeable men in the world on construction in permafrost. This conference enables the representatives of ten nations to exchange not only their own thinking and experience, but also that of their associates back home. This conference is an effort to collect and correlate all the extant, important scientific and engineering knowledge on construction in that one fifth of the world's land mass underlaid with permanently frozen ground.

We have programed here more than 100 outstanding papers by 147 authors from ten nations. These papers examine the disciplinary interfaces between many diverse fields, such as agronomy, archeology, ecology, geology, architecture, rheology, prospecting, thermodynamics, meteorology, soil mechanics, materials testing, photogrammetry, topography, sanitation, structures, and hydrography, to name only a few.

This conference is presented under the auspices of the Building Research Advisory Board of the National Academy of Sciences-National Research Council. At the time this conference was being programed, I was chairman of BRAB, and I am here on behalf of the chairman, Richard H. Tatlow, III.

I want to take this opportunity to commend the conference planning committee, under the very able chairman, K. B. Woods, for an outstanding piece of work. Their efforts have resulted in an excellent plan for achieving the aims of the conference.

Since the participants of this conference have such diverse interests, many of you may not be acquainted with the operations of BRAB, so I will outline its history and activities. The Building Research Advisory Board is a unit of the National Academy of Sciences-National Research Council, operating within its Division of Engineering and Industrial Research.

The National Academy of Sciences is a private, nonprofit organization, dedicated to science and to its use for the general welfare. Under its 1863 Congressional charter signed by President Lincoln, it was designated as an official advisor to The Federal Government in scientific and technical matters. A close working relationship has existed between the Academy and the government, even though the Academy is not a governmental agency.

The National Research Council was set up by the Academy

K. B. WOODS, Head, School of Civil Engineering, Purdue University

The scientists and engineers meeting here today to attend this International Conference on Permafrost bring results of many years of study, research, and experimentation on the subject. It is the first time an opportunity has been provided to bring together experts from many countries and disciplines to discuss various aspects of permafrost.

It is the aim of the conference to gain a better understanding and to be able to develop a new approach toward harnessing this phenomenon for the benefit of mankind. We hope to provide an encyclopedia of much of the world's knowledge on permafrost, which covers one-fifth of the world's land surface.

The enthusiastic response of individuals from government agencies, universities, industrial concerns, consulting firms, and military establishments from the United States and Canada, the Soviet Union and several other foreign countries, makes

in 1916 at the request of President Wilson to provide a means for scientists and distinguished leaders in science-related areas to work closely with the Academy through membership on various boards and committees of the Council.

The National Academy of Sciences-National Research Council receives funds from private and public sources in the form of contributions or grants, in addition to carrying out contract assignments. The work of NAS-NRC is to stimulate research and application of research and to promote effective utilization of the scientific and technical resources of the country, in order to serve the government and to further the general interests of science.

To pursue these objectives in the field of building, the Building Research Advisory Board was organized in 1949. It comprises 30 individuals appointed for three-year terms by the Academy-Research Council from among the ranks of outstanding scientists, engineers, technologists, architects, builders, and others—from industry, the professions, academic and government circles—involved in building. The work of BRAB is coordinated and directed by an executive director and a staff of architects, engineers, and technical personnel in Washington, D. C.

As a unit of the NAS-NRC, BRAB works to stimulate and correlate building research activities; it is authorized to study, on request, any subject of science, art, or technology in the field of building and to advise on questions submitted by any department or agency of The Federal Government, or by private sources when in the public interest. In all its activities, BRAB's effectiveness is dependent on the personal contribution of each individual who collaborates in these undertakings by giving generously of time, knowledge, and effort. This, certainly, has been the case with those who have contributed to the success of this conference.

BRAB has provided the forum. I am certain you will use it well for the benefit of all who may wish to build in permafrost.

We in the Building Research Advisory Board of the National Academy of Sciences-National Research Council are happy to have provided the means whereby the existing knowledge in the field of permafrost could be exchanged by the considerable numbers of representatives in these related fields from all over the world.

this meeting an outstanding achievement and contributes importantly to the knowledge on the subject.

This conference has been made possible through the efforts of many individuals and organizations. I want particularly to mention the Building Research Advisory Board and the work of Robert M. Dillon, its executive director; Clayford T. Grimm, the conference secretary, and Harry Zackrison, former chairman of BRAB and member of its executive committee. Especially I want to mention the public relations committee directed by Kenneth T. Simendinger, of Henry J. Kaufman & Associates; Robert E. Fischer, Architectural Record; Frederick S. Merritt, Engineering News-Record, and Louise Levitas, of Purdue, who was in charge of press relations during the conference.

This meeting was conceived originally by Thomas B. Pringle, chief, Civil Engineering Branch, Corps of Engineers;

Kenneth A. Linell, chief, Experimental Engineering Division, U.S. Army Cold Regions Research and Engineering Laboratory, at Hanover, N. H., and your speaker. In May, 1960 the Office of the Chief of Engineers asked the three of us to make an extensive inspection of foundation designs and performance in many sections of Alaska. We were pleased with practically all of the installations inspected, but it became obvious that various types of civilian construction had been done naively and without any sufficient knowledge of approved methods for handling permafrost. As a result we recommended to the Office of the Chief of Engineers that a conference, similar to this one, be organized and a proceedings printed to include the contributions and discussions.

The conference, being of broad interdisciplinary character, required the contributions of experts in many fields. Your chairman is indebted to the individuals who have worked for many months to make the meeting possible. These include A. J. Alter, Alaska Department of Health and Welfare; James A. Bender, U.S. Army Cold Regions Research and Engineering Laboratory; Richard L. Cameron, Ohio State University; Trevor A. Harwood, Canadian Department of National Defense; Arthur H. Lachenbruch, U.S. Geological Survey; Robert F. Legget, National Research Council of Canada; Kenneth Linell, Robert D. Miller, Cornell University; William J. Niemi, Bureau of Public Roads; Troy L. Péwé, University of Alaska, and A. L. Washburn, Yale University.

We are also indebted to many individuals who helped obtain

financing for the meeting and for publication of the proceedings. Responding to requests for assistance were the National Science Foundation, the Caterpillar Tractor Co., U.S. Army Corps of Engineers, U.S. Navy Bureau of Yards and Docks, U.S. Air Force Cambridge Research Laboratories (Terrestrial Sciences Laboratory), Bureau of Public Roads, Office of Public Defense, U.S. Army Materiel Command, the Public Health Service, and the Office of Naval Research.

We also appreciate very much the efforts of the following cooperating agencies who have helped in publicizing and making the conference a successful venture: National Research Council of Canada (Associate Committee on Snow and Soil Mechanics), American Society of Civil Engineers (Soil Mechanics and Foundations Division), American Society for Testing and Materials (Division of Materials Sciences), American Geophysical Union, and Highway Research Board of the National Academy of Sciences-National Research Council.

Also, I wish to express appreciation to many of my colleagues at Purdue, especially G. A. Leonards, who assisted me throughout the planning and development of the entire program; Margaret Crites, who helped me for eight months in all aspects of organizing the conference; conference division personnel for their complete cooperation, and many members of the Purdue staff including others in the School of Civil Engineering for help of many kinds through a long period of time.

PERMAFROST IN NORTH AMERICA

ROBERT F. LEGGET, Division of Building Research, National Research Council of Canada

Permafrost is a regular feature of extreme northern and southern terrain throughout the world, its boundaries dictated by the laws of physics alone. It is entirely appropriate to find such an international gathering as this assembled to consider the problems presented by permafrost wherever it is found, through a sharing of the results of observation and by discussion. It is likewise most appropriate to have this gathering on the campus of Purdue University, internationally known for the terrain interests of its Department of Civil Engineering, as for so many other distinctive contributions to the advance of knowledge and sound learning.

Since the Union of Soviet Socialist Republics and Canada share the dubious distinction of each having within its borders more permafrost than is to be found in all other countries of the world combined, Antarctica possibly excepted, it is fitting that a Soviet and a Canadian speaker should have been asked to present at this opening session the necessary general background for the deliberations of the week. I count it a privilege to speak for Canada at this time, the privilege being a pleasure as I find myself in the good company of my personal friend, N. A. Tsytovich.

At the outset, it would be well for us to agree upon what we are talking about. Agreement will surely be given to the fact that permafrost is a condition of the ground and not, of itself, a material. The name is used to describe that condition of the ground when its perennial mean temperature is always less than 0°C. Sloppy scientific semantics have led to the same word being very generally reserved to describe, colloquially, water-bearing silts and clays that are perennially frozen. It is entirely probable that the word will be used in this way during the proceedings of this conference, so popular has this misuse become, but the correct use of the name should always be adopted whenever possible.

Even the word "permafrost" itself, first coined, it is believed, by Siemon Muller, is regarded by some as semantically unfortunate. In 1946 the late Kirk Bryan published an eloquent plea for the use of philologically correct terms in the study of frozen ground [1]. Bryan's suggested use of such words as "cryopedology" and "pergelisol" was logical and entirely cor-

rect. Unfortunately, however, common usage sometimes pays little or no attention to logic and so these words have not achieved the recognition for which Bryan pleaded. Permafrost, therefore, is the accepted name for the subject matter of this conference. The name will doubtless long continue to be given to the perennially frozen condition of ground that will always be so significant a determinant of northern development.

It must readily be admitted that although it is this condition with which we are to be concerned, the temperature of the ground when it consists of solid rock or well-drained sand and gravel is usually a matter of little moment—subfreezing temperatures having no deleterious effect upon the properties of these materials. The carrying out of engineering works, such as the installation of water mains, is naturally affected by subfreezing temperatures below ground but permanent solutions to such problems are readily available. Disintegration of certain exposed rock types may perhaps be accelerated and the associated freezing of surface waters in open joints may lead to such interesting phenomena as the "growing rocks" at Churchill, Manitoba. It is, however, the effect of the perennially frozen condition upon water-bearing soils, when this condition is thermally disturbed, that creates serious problems which may be widespread.

This aspect, therefore, of permafrost came to the attention of the early explorers of the Canadian North and of Alaska. Many of these men were acute observers; their long journeys into the unknown showed their inquiring turn of mind. In their records are occasional references to the unusual occurrence of frozen ground. They found that they could cultivate in the few short weeks of summer what we now call the active layer. The phenomenal rate of growth in the North surprised them.

Joseph Robson was one of the early writers on the North. His Account of Six Years Residence in Hudson's Bay from 1733-36 and 1744-47 was published in London in 1752 [2]. He observed that

The garden-ground at York-fort and Churchill-river thawed much sooner and deeper in the space of one month, than the waste that lies contiguous to it . . . by the heat therefore

which the earth here would acquire from a general and careful cultivation, the frost might be so soon overcome, that the people might expect regular returns of seed-time and harvest.

This suggestion is still valid for the extreme southern boundary of permafrost but could not have been successfully applied in the areas mentioned by Robson. He relates that "in September 1745 (he) tried the frost in the ground, by digging in a plain near the fort." But the explanations he applies to what he observed make strange reading today, being based on the concept that "it is the moisture that communicates the freezing quality."

James Isham was a more accurate observer among these eighteenth century sojourners in the North. His Observations on Hudson's Bay 1743 is a justly famous work that has been republished in modern form with careful annotations [3]. Here is Isham's comment on the subject of this conference, written 220 years ago:

The shortness of the summer's is not sufficient to thaw the Ice the severity of the winter occasion's therefore itt geathers more and more Every year, for which Reason the frost is never out of the ground, in these parts, for in Dig'ing three or four foot downe in the ground in the mids't of the summr. you shall find hard froze'n Ice, which Ice may be ab't two foot thick, then come to soft ground again, for a small Depth and above six or Eight foot Downe itt's all hard Ice, - in Summer itt's with much Difficuly you may Dig so Low down.

(Needless to say the spelling and punctuation are as in Isham's original book.)

Since the buildings used by the early settlers in the North were generally of relatively simple types, it is not surprising that the perennially frozen character of the ground upon which they built occasioned relatively little comment. Wooden sills placed directly upon the ground surface seem to have been the almost universal type of foundation until relatively recent years. Roads were nonexistent (apart from the short stretch joining the quarry with Fort Prince of Wales at what is now Churchill, Manitoba). The only real disturbance of the ground was necessitated by the burial, when civilized burial was possible, of those who died in the North. In this somewhat macabre way early experience with frozen ground was accumulated. James Isham observed:

... these men that are so froze, or any one that Dyes and are Burried 6 foot under the surface of the ground, continues hard froze for many Year's, and Believe never will be thaw'd unless taken up, -by the Experience of frozen ground

Because this is an international and not merely a North American conference, it may be of value to note that no less a scientist than Charles Darwin encountered the same situation in a far different part of the world. In his fascinating book The Voyage of the Beagle, Darwin relates that in the South Shetland Islands:

The soil here consists of ice and volcanic ashes interstratified; and at a little depth beneath the surface it must remain perpetually congealed, for Lieut. Kendall found the body of a foreign sailor which had long been buried, with the flesh and all the features perfectly preserved. It is a singular fact, that on the two great continents in the Northern hemisphere (but not in the broken land of Europe between them), we have the zone of perpetually frozen under-soil in a low latitude - namely, in 56° in North America at the depth of three feet, and in 62° in Siberia at the depth of 12 to 15 feet - as the result of a directly opposite condition of things, to those of the southern hemisphere. On the northern continents, the winter is rendered excessively cold by the radiation from a large area of land into a clear sky, nor is it moderated by the warmth-bringing currents of the sea; the short summer, on the other hand, is hot. In the Southern Ocean the winter is not so excessively cold, but the summer is far less hot, for the clouded sky seldom allows the sun to warm the ocean, itself a bad absorbent of heat; and hence the mean temperature of the year, which regulates the zone of perpetually congealed under-soil, is low.

It is evident that a rank vegetation, which does not so much require heat as it does protection from intense cold, would approach much nearer to this zone of perpetual congealation under the equable climate of the southern hemisphere, than under the extreme climate of the northern continents.

Here is the young scientist, for Charles Darwin was only in his mid-twenties at the time of his visit to the South Shetlands, writing his record that was published in 1832 [4].

This was the heroic age of exploration. It is even possible to mention the name of Sir John Franklin, in this brief review, for the surgeon and naturalist attached to his expeditions of 1819-22 and 1825-26 was the man who became Sir John Richardson. He was one of the great explorers of the Canadian North and commanded the Franklin search expedition of 1848-49. He was perhaps the first man to write papers specifically on permafrost [5].

In a paper published in 1851 he said, "Another phenomenon intimately connected with the mean temperature of a district is the 'ground ice' or 'permanently frozen subsoil'. The lateral extent of this substratum, its southern limits, and its thickness, are interesting subjects of inquiry" [6]. With these words of over a century ago all of us would agree.

In the latter part of the last century, the Royal Geographical Society had an active committee on the "Depth of Permanently Frozen Soil in the Polar Regions, its Geographical Limits, and Relations to the Present Poles of Greatest Cold." General Sir G. H. Lefroy, a northern explorer of note, was chairman. His report for 1889 presented observations on permafrost for 22 locations, most of them in Canada, accompanied by some pointed observations that would not be out of place if voiced at this conference [7]. Such evidences of early interest in permafrost were conspicuous by their rarity.

As we approach the twentieth century, therefore, permafrost may rightly still be called the great unknown of the North. It required the activities of the engineer, civilian, and later, military, to reveal the problems that perennially frozen ground can present when natural conditions are disturbed. Reference to the Klondike gold rush, starting in 1896, may sound a strange note at this academic gathering and yet those chaotic days must be recalled, if only briefly. It was the discovery of gold on Bonanza Creek that was probably the start in North America of man's interference, on anything but a minute scale, with ground that had been kept frozen for so long a period by the operation of natural processes.

The area of the Klondike gold rush in the Yukon Territory was not glaciated in Pleistocene times. One result of this geologically interesting fact was the occurrence of most of the gold in river terrace gravels. These were generally found to be covered by substantial thicknesses of organic material, the combination pointing clearly in the direction of mining by hydraulic methods. There was little difficulty in removing the "muck" even though both it and the underlying gravels were found to be in a perennially frozen condition, resisting the usual process of sluicing because of their temporarily solid condition.

The gradual development of methods that would thaw out these valuable gold-bearing soils is a story of great interest and one that may not have received all the attention it should have by more recent students of permafrost. In summary, thawing by exposing the gravels to the influence of solar radiation was a natural starting point, satisfactory and economical but devastatingly slow. The use of wood fires on the surface of the frozen gravels was a logical second step, speeding up the process of thawing but steadily becoming uneconomical (and eventually almost impossible) as all supplies of local timber were gradually used up. The use of steam jets and of circulating hot water, inserted into frozen gravel banks by means of jetted pipes was the next phase of development, one widely used despite some tragic accidents in early days before proper experience had been accumulated. Finally, with the advent of more powerful pumping machinery, the use of large volumes of cold water yielded similarly satisfactory results. This method is still generally in use in the mining operations that continue

to this day in the Yukon and Alaska—though in scope, in type, and in glamor, different from the early operations that caught the imagination of the world [8, 9].

All these procedures, interesting as they are, were designed to destroy the condition of permafrost, whereas the aim in almost all other engineering operations is to preserve it. In the erection of buildings for human or other occupancy, for example, the last thing that is wanted is any change in the condition of the ground upon which the buildings are founded. Fortunately, almost all buildings in the North, until relatively recent years, have been simple wooden structures, heating systems having been almost universally some variant of the common stove. With simple sill foundations placed directly on the surface of the ground, little trouble was encountered with thawing of underlying frozen soil. Such movements as did occur were very easily corrected, this being regarded as no more than ordinary maintenance. The buildings that constitute the northern posts of the Royal Canadian Mounted Police, for example, spread all over the wide extent of the Canadian Arctic and have never been a cause for concern because of any foundation difficulties. The post of Herschel Island, established in 1903 by taking existing buildings built by whalers of California redwood planks, are still satisfactory after almost a century of service and have required very little maintenance.

When the Royal Canadian Corps of Signals established its pioneer post in the Mackenzie Delta in 1922, at a location that developed into the town of Aklavik, its location on a stretch of frozen silt but a few feet above river level caused no serious problems. These developed only when attempts were made in recent years to give the town some modern amenities. The problems thus revealed resulted eventually in the decision to found the new town of Inuvik on the higher ground adjacent to the east side of the Delta [10].

So was it also with the Hudson's Bay Company. For well over two centuries the familiar buildings of this great and unique company were built all over the North and maintained through the years without any unusual difficulty. They also were relatively simple structures, with heating systems that would be regarded today as primitive. The first move away from this traditional practice showed that permafrost cannot be forgotten in the practice of modern northern building.

In the late 1930's "The Company" decided to start providing its devoted post managers with improved living conveniences. A new type of manager's house was designed, incorporating a concrete basement and standard furnace heating system. The house was duly built in the new mining settlement of Yellowknife on the north shore of Great Slave Lake. Even though solid rock is the predominant terrain, a sheltered site was chosen for the house which, although ideal from the point of view of exposure, happened to be underlaid by perennially frozen water-bearing silty clay.

The post manager who occupied the new house was the envy of all his colleagues in the North. His heating system worked splendidly. Toward the latter part of the first winter, however, cracks began to appear near the front steps. Next it was noticed that the house was clearly settling, but it was some time before it was finally realized that the heat loss through the basement walls and floor was gradually thawing the frozen soil with lamentable results. Initial remedial measures proved to be ineffective. Eventually the furnace had to be removed and the basement filled in. The house today stands 18 inches lower than when first built, but the experience it provided has been turned to good effect in all further company building.

This incident in the development of the North, typical of the start of modern building in the North by almost all organizations, took place just as World War II was starting. Clearly a change had to be made in methods of dealing with northern terrain in the face of modern technical developments—a change that the imperatives of wartime hastened in an almost alarming manner.

Prior to the outbreak of the war, there had been a start at gold mining on Great Slave Lake and on Lake Athabasca; and the famous Eldorado uranium mine on Great Bear Lake was producing. All these mining ventures were in permafrost—but it was permafrost in solid rock almost exclusively—and so few

unusual problems were encountered. Development of the petroleum reserves at Norman Wells on the Mackenzie River had also started. Here the sad results of thawing perennially frozen water-bearing silts and clays had made themselves evident. Experimentation was started. Some of the earliest foundations to be placed on gravel pads were installed here, but the location was an isolated one. Its pioneer experience was known only to the few [11]. Valuable experience was also gained during the construction of the Hudson Bay Railroad, between The Pas and Churchill, but this was available only to those who had worked on the line and in railway archives. The experience was made available for public use many years later [12].

Despite military secrecy, many wartime building operations achieved almost unenviable publicity. The construction of the Canol pipeline across the mountains from Norman Wells to Whitehorse was one such project; equal in scope and imagination was the building of the airfields that constitute the highly successful Northwest Staging Route and the associated Alcan Highway—both in active use today and steadily being improved. Still further north, the first Joint Arctic Weather Stations were established on the Queen Elizabeth Islands in the immediate postwar period. Their construction marked a significant advance in northern building practice in North America.

The history of the development of Alaska is similar to the pattern just described for northern Canada, although rather more recent in its several phases. Prior to the purchase of Alaska in 1867 by the United States from Russia, and for some years following, only small fur-trading settlements and fishing villages existed.

It is of interest to note that a member of the staff of the U.S. Geological Survey, Israel G. Russell, was attached to the U.S. Coast and Geodetic Survey party that set out from San Francisco in the spring of 1889 to establish the boundary between Alaska and the Northwest Territories of Canada. Russell was an acute observer: His example in having a long paper recording his observations in Alaska printed in the Bulletin of the Geological Society of America for March 1890, less than a year after he sailed from San Francisco, is an example that can shame many of us today [13].

In this paper he has a section, Depth of Frost in the Arctic, in which he questions whether permafrost is the result of the annual freezing of successive depositions or the accumulation of surface frost "penetrating down." He includes the calculations of a colleague in the Survey, R. S. Woodhouse, that are the earliest known to me in permafrost research. Unfortunately, they were based on the assumption that "at the beginning of time the first 1,000 or 2,000 feet had a uniform temperature," and so the results are questionable; but the attempt was a notable one and certainly a pioneer effort.

The discovery of gold at Nome in 1899 and at Fairbanks in 1902 was of great importance in precipitating development of the territory. In 1910 an overland trail was opened from the ocean port of Valdez to Fairbanks. These were in no small part responsible for further development of fishing, mining, and agriculture in areas through which they passed. The most important new road to both Alaska and the Yukon has been the Alcan Highway, constructed in 1942.

Since Alaska became a state, road building has sharply increased. The urgent requirement of defense systems and associated military facilities from 1940 to the present must also be regarded as a most important reason for the opening up of this great area. Permafrost was encountered and had to be considered, more critically in recent years, in most of the various stages of the development of Alaska, and much valuable experience was gained in many fields of endeavor. The annual Alaska Science Conferences testify to the current scientific activity in this new state.

The imperatives of war allowed little time for experimentation or study. Most northern building in the emergency of those years had to be carried out on a rather hit-and-miss basis. Valiant efforts were made to assemble useful information on northern building problems. The most notable contribution undoubtedly was Muller's book on permafrost, first published as Permafrost of Permanently Frozen Ground and Related Engineer-

ing Problems (1943) and soon to be published in revised form by McGraw-Hill. Much of the information assembled by Muller was from Soviet sources [14].

The most remarkable aspect of the opening of the North during the emergency was the excellent work done—and not the few failures, spectacular though some of them may have been. Of unusual significance was the design and erection of several 600-ft steel towers, one of which was at Kittigazuit, northeast of Inuvik in the Mackenzie Delta [15]. The special problems in the absorption of solar radiation introduced by the large area of steel exposed in this tower, which had to be founded on frozen water-bearing soil, were fully recognized and compensated for in the design. The result was that the tower served quite satisfactorily and with no appreciable movement until its demolition in 1955. Although located in Canada, this tower was designed by the United States Air Force as a part of the joint North American defense effort.

In 1947, at Fairbanks, the Corps of Engineers began important field research on problems of perennially frozen ground. This work was administered from the St. Paul District Office and one of the district engineers responsible for that early undertaking has since become Chief of Engineers, Lieut. Gen. W. K. Wilson, who is honoring this conference by speaking at the banquet. On the arctic coast, the United States Navy established its Arctic Research Laboratory at Point Barrow in 1946. In postwar years, this station became a well known center for field studies in many scientific disciplines including terrain studies, as the proceedings of this conference will make clear. Correspondingly, the early work at Fairbanks has been continued and is now administered by the Cold Regions Research and Engineering Laboratories (CRREL) of the United States Army, Corps of Engineers.

This is the organization that has been responsible for noble research work on permafrost and other arctic terrain problems at the important defense base at Thule in Greenland which, it should not be forgotten, is considered as part of North America. On the eastern coast of Greenland, further south, there is some unusually interesting field research work being conducted on solifluction and allied problems by another pioneer in this field, A. L. Washburn.

Despite the necessarily expedient character of much of the wartime activity in northern regions (the Canol pipeline, for example, was partially dismantled soon after the end of hostilities), some of the changes then effected contributed to the permanent transformation of the Arctic that has forever removed its isolation. The Alcan Highway and the airfields of the Northwest Staging Route have become essential parts of the northern transportation picture. The Joint Arctic Weather Stations continue to make an invaluable contribution to worldwide meteorological information. In a similar way, although mining enterprises must always be transitory (gold mines on Lake Athabasca and the uranium mine on Great Bear Lake having now been closed down), the early mining ventures down the Mackenzie River changed this great waterway for all time [16].

Prior to the mid-1930's, the waterway was seen by few and used mainly by the Hudson's Bay Company for the private supply of its posts in the western Arctic and within the great valley itself. About 5000 tons of freight was the maximum ever carried in any one summer season. Even before the war this had been changed dramatically by the freight needs of the mines; wartime traffic turned the Mackenzie into one of the great water routes of North America. Its unique character and unusual climate which brings the tree lines to within a few miles of the arctic coast, coupled with wartime experience and further mining developments in the area, confirmed its importance. It was natural, therefore, that this area should have been the scene of the start of postwar Canadian permafrost research.

In 1947, the National Research Council of Canada established its Division of Building Research, the prime function of which is to provide a research service for building throughout Canada. Building in the North was clearly one of its problems and as early as 1949 plans were made for a general survey of northern building. These were implemented in 1950 when a small team passed the entire summer in a detailed examination of all existing buildings down 1200 miles of the Mackenzie val-

ley from Hay River on Great Slave Lake to the arctic coast [17]. This was a joint enterprise of the Division and the Canadian Army (Royal Canadian Engineers). The survey revealed problems encountered with the foundations of recent buildings when built on perennially frozen soil, and it confirmed the great value of the pioneer research work carried out at Norman Wells by Imperial Oil Limited in connection with its small refinery there.

A somewhat similar Mackenzie River expedition was arranged for the year following, but this time with special reference to terrain conditions and their evaluation by means of aerial photography. The study was an extension of work previously carried out in Alaska under the direction of the general chairman of this conference, K. B. Woods. A further reason for the pleasure that participation in this program gives to me personally will be immediately evident: Professor Woods and I have shared a keen and active interest in permafrost throughout all these postwar years [18].

The expeditions down the Mackenzie led to the decision to establish a small research station for the field study of permafrost problems at some convenient location on the river. Norman Wells had so many advantages that the cooperation of Imperial Oil was solicited and most cordially and fully given, leading to the initiation of the Northern Research Station of the Division of Building Research of the National Research Council, located within a very few miles of the Arctic Circle. To begin with, two buildings left over from the Canol project were used. In 1956 they were replaced by two well-equipped prefabricated wooden buildings, a residence and a laboratory, officially dedicated for this intended use by the late E. W. R. Steacie, president of the Council, appropriately enough by the light of the midnight sun. This was during a visit which the governing body of the Council paid to Arctic Canada, clear indication of the attention that Canada was finally giving to its northern development [19].

In more recent years, this growing interest has been well indicated by the widespread investigations of a number of American and Canadian scientific organizations. Any attempt to list all of these groups would lead inevitably to invidious omissions. A special example is the work of the Geological Survey of Canada all over the Canadian Arctic. The Survey's pioneer use of helicopters and of specially equipped light planes is now well known. These reports on many parts of the North, although naturally geological in character, inevitably include many references to permafrost. The current interdisciplinary investigation of the Canadian Polar Continental Shelf on the northwest edge of the Canadian Arctic Archipelago is similarly relevant. Drilling for oil in the Queen Elizabeth Islands has now started and consideration has been given to the use of such holes for ground thermal studies. Although the difficulties are formidable, a deep hole drilled on Melville Island by a group of oil companies headed by Dome Petroleum Limited was instrumented by the Jacobsen-McGill Arctic Research Expedition. Drilled holes were used earlier at the site of the Joint Arctic Weather Station at Resolute, on Cornwallis Island.

Field studies into more specialized aspects of permafrost were conducted in recent years by the Geographical Branch of Canada's Department of Mines and Technical Surveys, not only in the western Arctic where the more general work of the National Research Council has been concentrated, but also in the eastern Arctic. In the eastern part of Quebec and adjacent parts of Labrador great iron deposits were discovered and are now being extensively worked in open pits. Here the perennially frozen condition of the ore rock gave rise to a variety of unusual problems, all additional to the usual ones encountered with frozen soil. Technical staffs of the responsible mines are carrying out field studies and research. At Schefferville, Quebec, in the heart of this area, McGill University in 1954 established its sub-Arctic Research Laboratory which served as a valuable center for much useful field study of permafrost.

Further north, the now famous but initially very secret DEW line was constructed along the arctic coast, from Alaska to Greenland. Logistics probably constituted the major problem in this gigantic undertaking since the actual structures used are not large or unduly complex, involving only the careful

adoption of accepted foundation methods, especially for sites on perennially frozen soil. The wide use of aerial photographs for preliminary reconnaissance of these sites was a design feature of interest, as it was also for the selection of the site of the new town of Inuvik in the Mackenzie Delta. Now the administrative center for all Canadian governmental operation in the northwest of the Dominion, Inuvik replaced the old settlement of Aklavik. Almost all the buildings are founded on piles that were steamed into the frozen soil. These foundations are performing very well [20].

Road access to this remote Canadian town, within a very few miles of the arctic coast, is planned; but for a long time access must continue by water down the Mackenzie and by air using the excellent landing strips, almost all successfully built on perennially frozen soil, that now serve the great valley. Road construction is slowly forging northward. In Alaska and the Yukon, extensive road mileage now exists between the 60th and 65th parallels. The gold-mining center of Yellowknife on Great Slave Lake, NWT, can now be reached by road through the use of a ferry crossing the Mackenzie. And the south shore of Great Slave Lake will soon be reached by a new railroad, being specially constructed to serve the newly discovered zinc-lead ores at Pine Point.

Somewhat to the south in the province of Manitoba, the International Nickel Company now has in operation a nickel plant of the same order of magnitude as those in the famous Sudbury basin. The plant and associated townsite of Thompson are located in the southern fringe area of the permafrost region. Foundation problems common in more northern building practice were encountered sporadically, thus making them difficult to deal with economically [21]. To serve the great plant and the town, the Kelsey water power plant was built 55 miles to the northeast by Manitoba Hydro. The plant is unique in that two of the larger dykes necessary for the creation of the reservoir had to be built over perennially frozen soil with the knowledge that the water in the reservoir would inevitably change the thermal regime of the underlying ground. The performance of the dykes is being very carefully observed, this being a field research project of unusual fascination.

This bird's-eye view of the steady development of northern Canada can be supplemented by a picture of the older northern establishments in both Canada and Alaska, such as the Hudson Bay Railroad and the Alaska Railroad, that have been performing quite satisfactorily for many years.

One can think of all these engineering works without consciously remembering that all depend for their essential stability upon the underlying frozen ground. But the fact that men are drilling for oil, constructing roads and railways, building new towns, municipal utilities, and even large water power plants—all north of the southern limit of this condition called permafrost—shows clearly that unusual terrain conditions will not impede northern development.

All too much of this northern work, however, has been done without full appreciation of the precautions that must be taken when building on permafrost, with consequent troubles and quite unnecessary cost. As in so many other fields, this has been the unfortunate result of lack of communication, coupled, probably in some cases, with the North American falling of too much hurry, leaving no time to the civil engineer for proper study and investigation of what is known before construction begins. Thus, it is that this conference is so clearly to be welcomed, bringing together from many countries those who have actual experience with permafrost. The proceedings of the conference will assuredly serve for many years as a valuable storehouse of knowledge, available for consultation by all who are concerned with perennially frozen ground.

Gathering information, however, valuable as it is, constitutes only a part of the challenge of permafrost. There is so much more to be found out about it, and about the measures that can be taken to control its effects upon engineering works, and vice versa, that fertile fields for research surround the alert student of the North. Of special importance, certainly in Canada, is a more accurate delineation of the actual extent of permafrost, a major project upon which we are now actively

engaged, just as Richardson suggested more than a century ago [22].

It may be appropriate to observe that continental United States has its own permafrost, even in New England, the top of Mount Washington having been shown to be in a perennially frozen condition through the drilling of a special test hole near its summit. Trifling though this occurrence may seem to be, it can almost be taken as a symbol of the challenge presented by permafrost.

That frozen mountain top can remind us that permafrost has long since ceased to be a mystery. We know that it is a condition of the ground intimately associated with the mean annual local air temperature. We can now determine when to expect it. When it is anticipated, we can plan our engineering activities accordingly. This we must do as northern Canada and Alaska are slowly but surely developed for the use and convenience of man. If every engineer who is called upon to work in the North will remember some of the unanswered questions about the scientific aspects of permafrost, the constructive linking of his developmental work with the inquiries of the scientist will surely assist in still further rolling back the boundaries of our understanding of the wonderful world in which we live.

ACKNOWLEDGMENT

The author is grateful to G. H. Johnston and R. J. E. Brown, colleagues who are fully engaged in northern research work, for assistance in the preparation of this paper.

REFERENCES

- [1] Kirk Bryan. "Cryopedology—The Study of Frozen Ground and Intensive Frost Action with Suggestions on Nomenclature," *Am. J. Sci.*, Vol. 244, 1946, pp. 622-642.
- [2] Joseph Robson. *Account of Six Years Residence in Hudson's Bay from 1733-36 and 1744-47*, London, 1752, J. Payne and J. Bouquet.
- [3] J. Isham. *James Isham's Observations on Hudson's Bay, 1743, and Notes and Observations on a Book entitled A Voyage to Hudson's Bay in the Dobbs Galley, 1749*, ed. by E. E. Rich and A. M. Johnson, Champlain Soc. for Hudson's Bay Record Soc., 1949.
- [4] Charles Darwin. *The Voyage of the Beagle*, 1832, Bantam Classic, 1958, p. 213.
- [5] John Richardson. "Notice of a Few Observations which It Is Desirable to Make on the Frozen Soil of British North America," *J. Roy. Geog. Soc.*, Vol. 9, 1839, pp. 117-120.
- [6] John Richardson. *A Journey of a Boat-Voyage through Rupert's Land and the Arctic Sea, in Search of the Discovery Ships under Command of Sir John Franklin*, London. Longman, Brown, Green and Longmans, 1851.
- [7] Sir G. H. Lefroy. "Report upon the Depth of Permanently Frozen Soil in the Polar Regions, Its Geographical Limits, and Relation to the Present Poles of Greatest Cold," *Proc. Roy. Geog. Soc.*, Vol. 8, 1889, pp. 740-746.
- [8] *The Yukon Territory—Its History and Resources*, issued by the Hon. W. J. Roche, Minister of the Interior, Ottawa, Canada, 1916.
- [9] H. C. Cooke, W. A. Johnston. "Cold Occurrences of Canada, Summary Account," *Geol. Survey Canada*, Dept. Mines, Canada, *Econ. Geol. Ser. No. 10*, 1933.
- [10] C. L. Merrill, J. A. Pihlainen, R. F. Legget. "The New Aklavik: Search for the Site," *Engr. J.*, Vol. 43, 1960, pp. 52-57.
- [11] R. F. Legget. "Construction North of 54°," *Engr. J.*, Vol. 24, 1941, pp. 346-348.
- [12] J. L. Charles. "Permafrost Aspects of the Hudson's Bay Railroad," *Proc. Am. Soc. Civil Engrs.*, Vol. 85, SM6, 1959, pp. 125-135.
- [13] I. G. Russell. "Notes on the Surface Geology of Alaska," *Bull. Geol. Soc. Am.*, Vol. 1, 1889, pp. 99-162.
- [14] S. Muller. *Permafrost or Permanently Frozen Ground and Related Engineering Problems*, Strategic Studies No. 62, U.S. Army, 1943.

- [15] L. A. Nees. "Pile Foundations for Large Towers on Permafrost," Proc. Am. Soc. Civil Engrs., Vol. 77, No. 103, 1951.
- [16] R. F. Legget. Machines for the Mines, The Beaver, Outfit 271, March 1941, pp. 20-22.
- [17] J. A. Pihlainen. Building Foundations on Permafrost, Mackenzie Valley, NWT, Nat. Res. Coun. Div. Bldg. Res. Ottawa, DBR 22, 1951.
- [18] K. B. Woods, R. F. Legget. "Transportation and Economic Potential in the Arctic," Traffic Quart., Vol. 14, 1960, pp. 435-458.
- [19] "Permafrost Research in Northern Canada," Nature, Vol. 178, 1956, pp. 716-717.
- [20] J. A. Pihlainen. "Inuvik, NWT, Engineering Site Information," Nat. Res. Coun. Div. Bldg. Res., Ottawa, NRC 6757, 1962.
- [21] G. H. Johnston, R. J. E. Brown, D. N. Pickersgill. Permafrost Investigations at Thompson, Manitoba—Terrain Studies, Nat. Res. Coun. Div. Bldg. Res., Ottawa, NRC 7568, 1963.
- [22] R. J. E. Brown. "The Distribution of Permafrost and its Relation to Air Temperature in Canada and the U.S.S.R.," Arctic, Vol. 13, 1960, pp. 163-177.

PERMAFROST PROBLEMS

N. A. TSYTOVICH, National Association of the USSR for Soil Mechanics and Foundation Engineering

I wish to greet the present high assembly on behalf of the Soviet scientists—the pioneers in investigation of permafrost.

Permafrost was mentioned for the first time in the Siberian military reports of Glebov and Golovin (1642). The first scientific investigation of permafrost in Yakutsk and at other points of eastern Siberia was carried out by academician A. F. Middendorf, a Russian scientist, who published a book in 1848 entitled Journey in Siberia. In this book Middendorf paid great attention to studying permafrost temperature, which he, himself, measured in prospecting holes and in a special pit dug in Yakutsk.

In 1895 a well-known Russian geologist, I. V. Mushketov, in cooperation with V. A. Obruchev and others, wrote the first Instructions for Investigation of Frozen Soils in Siberia. N. S. Bogdanov, A. V. Lvov, and other engineers who devoted their effort to the construction art and the search for water-supply sources and who generalized the experience of the building of the first railroads in Siberia and the Far East, made a large contribution to the investigation of permafrost in 1912.

In 1927 the general work of M. I. Sumgin, Permafrost within the USSR, was already published in the Soviet Union. The publication of this work marks the establishment of cryopedology as an independent branch of science. Beginning in 1930, investigation of permafrost in the Soviet Union has been carried out mainly by the USSR Academy of Sciences in a planned manner.

After five to ten years it became possible to generalize the numerous experimental data in such fundamental works as Principles of Mechanics of Frozen Grounds (1937), Frozen Soil Science (1940), etc.

Many theoretical and applied works were published recently (on mechanics of frozen soils, engineering geocryology, thermal physics, bases and foundations, etc.), and in 1959—the general monograph Principles of Geocryology was published in two parts. The later editions extend the range of the problems of permafrost investigation to all the objects connected with the cryosphere, thus laying the foundation of a more comprehensive science.

In summarizing the achievements of the Soviet specialists in investigations of permafrost, it should be emphasized that the basic methods of stable building on permafrost have already been worked out in the Soviet Union. We build the same kind of houses, industrial buildings, and structures on permafrost as in the regions outside the permafrost zone. For instance, in the city of Norilsk, built on permafrost under severe arctic conditions, workers and employees live in modern, many-storied stone houses with all conveniences, such as central heating, hot water, bathrooms, etc. Besides, the city has a swimming pool and other sports institutions functioning all year round.

Expeditions and stationary investigations have made it

possible to establish the regularities in the formation of frozen soils and underground ice, as well as their types and geographical distribution, and the dynamics of cryogenic processes.

Based on the investigation of physics and mechanics of frozen soils, the theory of incomplete freezing of water in dispersed soils and the theory of dynamic equilibrium of unfrozen water and ice in frozen soils have been suggested and developed; intensive physico-chemical processes in freezing and frozen soils have been proved; quantitative and qualitative changes of the mechanical properties of soils (in case of freezing and further decrease of temperature) have been shown, and methods of estimating the rheological processes in frozen soils have been established. Theoretical principles and new procedures have been worked out (for investigation of freezing, frozen, and thawing soils) such as: Methods of geocryological survey, electrical prospecting, heat-mass exchange, structural-optic determination (using sections of ice and frozen soils), adhesion forces and microhardness, and creep and stress-rupture strength.

All this has made possible extensive utilization of scientific achievements in minerals production, in building various types of structures on permafrost, and in using winter cold for the purposes of the national economy.

For further progress in developing the northern regions as well as further success in building on permafrost, it is, however, necessary to continue thorough investigation of the processes of mechanical, thermal, and physicochemical interaction of permafrost with various objects of man's economic activity. Such investigations should be based on detailed study of the properties of permafrost and its change under the influence of external factors. Many problems can be solved only by mutual efforts of all the investigators under the conditions of international cooperation.

The following tasks seem to be urgent in further investigations:

1. To establish, on the basis of integrated studies of frozen soils, the general laws that define the processes of interaction of permafrost with various objects of economic activity, and to work out methods for controlling these processes.

2. To develop engineering methods for solving complicated problems of building by using the simulation theory and electronic computers on problems of thermal physics and mechanics of frozen and thawing bases, on calculation of artificially frozen soil guards, and on complex problems of foundations.

3. To improve the methods of building and maintenance of structures built on permafrost by industrialization and automation of some processes.

Please accept once again my greetings on behalf of the Soviet permafrost investigators and my wish for great success of the present conference.

RELATIONSHIPS BETWEEN VEGETATION AND FROST IN SOILS

WILLIAM S. BENNINGHOFF, University of Michigan

Ten years ago some plant ecologists, including myself, felt confident of their abilities to evaluate probabilities of intensive frost action or permafrost in soils from the nature of the vegetation on the site and evidences of recent vegetation history. This attitude was naive. We had some appreciation for the complexity of the heat transfer problems at the soil surface and in the vegetation boundary layer; but we too readily assumed that our interpretations, bolstered by temperature measurements at a few points in space and time, would allow usable approximations of the effects of different kinds of vegetation cover on the thermal regime of the underlying soils.

Our conclusions were in good part professional translations of common knowledge of practical men working in the North. With help from those men we hit upon some coincidences of vegetation and soil-frost phenomena that have proved useful. We have as yet few satisfactory descriptions of actual mechanisms relating vegetation to soil frost. The aim of this paper is to redefine the vegetation-soil thermal regime and to suggest some approaches that may assist in understanding the processes that couple these phenomena.

At first glance this would not seem a difficult system to analyze. The problem is one of radiant energy transfer, largely in the infrared wavelengths, from the sun and atmosphere to the soil, with certain modifications imposed by the intervening vegetation. However, even simple kinds of plant cover contain considerable variety in forms and spacing of the plants; the plants change in character from season to season, and the community changes from year to year. The plants and their residues continuously change the physical as well as the biotic character of the site as long as they occupy it. The plants and their residues were elaborated by means of a small portion of the solar energy supplied to the site, and they in turn modify the energy pathways within the vegetation stratum out of all proportion to the stored energy they represent.

These materials and forms of biological origin are in a class apart from the inorganic elements of landscape; they have different physical characteristics and are distributed over the landscape in a mosaic of patterns governed by quite a separate set of constraints. The patterns of vegetation have some relations to patterns of physical characters of sites, but in few instances can we satisfactorily explain one pattern by the mere presence of the other.

Taking note of variation in vegetation over short distances and potential influences on the thermal-energy field, we are sometimes surprised by the relatively small differences in frost phenomena in the soils of those sites. On the other hand, we may see differences from place to place in soil frost features where we can detect no corresponding differences in the vegetation or soils.

In the Big Delta area of Alaska, sedge tussock, hummock bog, and black spruce muskeg vegetation was found to be a reliable indicator of permafrost at a shallow depth in poorly drained lowland sites and on some north-facing slopes of moraines [1]. On outwash deposits vegetation was unreliable as an indicator. On the west side of the lower Delta River, outwash mantled by eolian sand and silt has a very shallow permafrost table and is covered by dense, vigorous spruce forest. On the east side of the Delta River there is also heavy spruce forest on outwash, but permafrost is deep or absent. Commonly observed characters of vegetation provide neither

straightforward nor universal indications of the frost characteristics of the soils.

In sub-Arctic areas where permafrost is discontinuous, the temperature of the soil immediately beneath the active layer is near 0°C. In these regions local influences may displace the temperature slightly in either direction to make the difference between permafrost or no permafrost. In regions of continuous permafrost, vegetation influences the depth of annual thaw but not the occurrence of permafrost. The occurrence and magnitude of seasonal frost action in the upper layers of soil are everywhere influenced by local conditions of the energy environment, especially those imposed by weather and modified by vegetation.

My work is with vegetation and its environmental relations. But here I will risk going beyond my competence in physical aspects of radiation and heat in order to explore ideas about thermal budget derived from botanical observations and to evaluate some investigation techniques that appear promising. I will welcome criticism and guidance.

VEGETATION AS A BOUNDARY LAYER FOR ENERGY EXCHANGE

Considerable progress has been made recently on heat budgets of glaciers and snow covers [2, 3, 4] and of lakes [5], where the surface and subsurface materials and states are relatively uniform. Geophysical and engineering investigations of heat flow in the ground are achieving useful approximations, even with the assumption of effective homogeneity of thermal properties and heat load. The work of Lachenbruch [6] on three-dimensional heat conduction in permafrost in the presence of a heat load anomaly is an especially significant step. Very recently exploratory efforts have been made to investigate the energy budgets of the environments of terrestrial biotic communities, notably by David M. Gates [7, 8, 9]. The mantle of vegetation over the greater part of the land surfaces of the world provides so complex a filter between the sun and atmosphere above and the ground beneath that investigations of energy exchange within it have been discouraging. It may prove helpful to view this problem from the standpoint of the vegetation, in spite of the fact that, for me at least, it is not possible to put this inquiry on a quantitative basis at this time.

I should acknowledge a debt to C. C. Nikiforoff for some of the ideas contained here. With the prescient view afforded by his experience, he described [10] the soil for us as the "excited skin of the subaerial parts of the earth's crust," and he demonstrated the key role of vegetation in the fixation, storage, and diversified release of the energy largely responsible for this excitation.

Gates' [7] summary equation for the energy environment of organisms can be adapted with respect to definitions of certain terms to provide a means for pointing out the energy field loci of several processes pertinent to the thermal regimes of soils, as follows:

$$(1-r)(S+s) + R_a - R_g + LE + G + C - (P-M) = 0 \quad (1)$$

where

(1-r)(S+s) is direct plus scattered sunlight, less that reflected by soil surface

R_a is infrared thermal radiation from atmosphere and objects above ground surface, including organisms

- R_g is infrared thermal radiation from ground
- LE is evaporation of water, with L being the latent heat of evaporation and E the quantity of water evaporated
- G is conduction of heat between bodies, including organisms, significant mainly to bodies or their parts in contact with soil, or water, ice, or snow on the ground
- C is convection of heat to or from bodies, including free convection in still air or water, and forced convection in windy air or moving water
- P is photosynthesis by green plants, an energy-storage term
- M is metabolism of photosynthate and its derivatives by all organisms, an energy-release term

The effective plus and minus signs may be reversed diurnally and seasonally for R_a , R_g , LE, G, and C with respect to the ground surface, and P may drop to zero, so that during some periods the value for M will exceed the value for P. For a uniform mineral surface with no vegetation, this simplified model would be a relatively practical equation; but vegetation introduces highly complex variables into every term, even to some degree that of direct solar radiation for levels beneath thin foliage, which filters out certain spectral bands.

Vegetation increases the variety and area of surfaces playing a part in the radiation environment by at least several orders of magnitude. This is tantamount to vastly increasing the roughness of the earth's surface, but with the added effects of increased diversity in the kinds of surfaces. The R_a and R_g functions are thus made highly complex, especially in vegetation with a closed canopy, beneath which middle and far infrared radiation is to a considerable extent trapped.

Vegetation modifies the LE function possibly as much as an order of magnitude, primarily by the additional process of evaporation of transpiration moisture given off by foliar organs; and most of that water is obtained by roots beneath the soil surface. The LE function is increased in magnitude also by the greater surface area of objects that intercept rain and snow and augment exposure to evaporation [3]. Even a shrub of modest size could conceivably intercept and evaporate 1000 g of meteoric water in one day, withdrawing approximately 590,400 cal (at 10°C) for the vaporization of that water. If we assume this shrub provides cover to 4 sq m of ground surface, the energy lost amounts to 147,600 g cal/sq m or 14.8 g cal/sq cm, or nearly 3% of the total daily global radiation at Fairbanks in June [11]. Evapotranspiration is more continuous, at least during the growing season, and causes withdrawal of even larger quantities of heat for vaporization of water. Furthermore, evapotranspiration increases under more intense direct insolation, thus moderating the heat load on the soil surface.

The conduction function (G) relates to bodies in contact with a material or medium not subject to convection. The underground parts of plants in contact with solid soil particles and soil water (where convection is largely restrained) probably conduct heat to and from the soil in proportion to the thermal diffusivity of the plant body plus the algebraic sum of forced convection of internal fluids such as the transpiration stream. Thermal diffusivity (α) is a function of conductivity (k), specific heat (c), and density (ρ) in the relation

$$\alpha = \frac{k}{c\rho} \quad (2)$$

Lumber from common temperate woods is reported to have conductivity values of 0.23 to 0.86 $\times 10^{-3}$ and diffusivity values of 1.25 to 1.60 $\times 10^{-3}$, near the commonly used mean of 1.43 $\times 10^{-3}$ for both the conductivity and diffusivity of water [12]. The diffusivity values of most soils are several times as great, in keeping with their greater conductivities and greater densities. We need to inquire into the significance of plant body heat conduction between the atmosphere and the soil. Empirical inquiry is the only practical approach with our present understanding of the many variables potentially operable.

The convection function (C) is also modified by vegetation, especially the kinds that develop layer structure enclosing convection systems within the vegetation stratum [13]. Vegetation generally moderates convective heat transfer between atmosphere and ground by reducing forced convection (wind) over the soil surface. Where there is standing water on the soil surface, covering vegetation reduces insolation and convective transfer in the water, and plant forms breaking the water surface inhibit forced advection and convection from wind and current action.

The last two terms of (1) require special consideration. Photosynthesis (P) is essentially a storage term, with significant and long-range effects on all the other terms except that of direct solar input. P represents not more than about 2% efficiency in fixation of direct solar input (Riley [14] estimated 0.18% as a mean value for the plant world). But P is cumulative up to a point of equilibrium with metabolism (M), the term for the life processes that are largely responsible for releasing the energy accumulated in P. The term P represents the standing crop of plants and animals plus the dead material (humus) in all states of degradation by organisms and by non-biological agents. A very significant point is that photosynthesis, being a photochemical reaction, maintains the free-energy level of the absorbed solar radiation by synthesizing compounds high in energy potential.

The energy of these compounds runs the ecosystem by the metabolic processes M, an extremely involved chain of events with manifold pathways and countless side effects on the thermal energy environment. The photosynthetic plants, in forms ranging from microscopic algae to trees, grow and change the energy landscape by their forms and various thermal characteristics. Plants reproduce their kinds and provide subsistence to the nonautotrophic organisms (animals and nongreen plants), through which the energy is passed until dissipated by loss of efficiency. Along the way the metabolic processes result in transfer of heat in R_a , R_g , G, and C and in use of heat for evaporation.

The biological forms within the vegetation mantle of the earth are all elaborated from this relatively minor fraction of the energy input to the system. But because P fixes that input at a high free energy level, and because M represents transfers of energy with high efficiency (more than 20%, in at least some steps in animal food chains), the energy reservoir created by P has a relatively long-term effect expressed with remarkable diversity.

Organisms increase the thermally active surfaces and reaction variety in the atmosphere-solid-earth boundary layer [13]. In the colder climates productivity is lower because of the shorter season for photosynthesis at significant rates (some evergreen plants, notably conifers, are known to be photosynthetically active at low rates in sunlight when ambient temperatures do not permit measurable growth). But the metabolic processes are similarly curtailed, even more strongly curtailed in litter and humus layers of cold wet soils, so that organic residues accumulate. These residues—litter, humus, and peat—add still another set of special thermal conditions to the boundary layer between soil and atmosphere.

We are aware of the high resistance dry humus offers to heat transmission, and, on the other hand, the ability of humus to hold water, with its (10 to 15 times) greater conductivity, high specific heat, and latent heat of vaporization. My point is that this 2% or less of solar input that gets channeled into the metabolic pathways by photosynthesis has modifying effects on the energy environment out of all proportion to its share of the total input.

Through P and M there is feedback in this system that develops certain limits to fluctuations within the energy environment of the vegetation layer. These controls will not greatly alter the total heat load on the solid earth, but they can conceivably moderate extremes or change distribution of heat in space or time. For example, a foliage layer intercepts a large proportion of direct insolation and dissipates some heat through LE, but it also intercepts the upward component of R_g and C within the vegetation and reduces the forced convection component (wind) of C. (W. E. Loomis has pointed out

[15] that in leaves absorption of the infrared of sunlight is low, but absorption of the longer wave lengths of infrared from the ground and other objects is nearly complete.)

The climate within the vegetation layer is thus moderated. If the foliage layer is opened by disturbance, species with greater light and temperature tolerance will enter, and plant succession will eventually restore the structure of the vegetation best suited to the prevailing climate. Thus moderation of the internal climate is restored. This is deviation-counteracting or morphostatic feedback to use the terms of Maruyama [16]; it suppresses diversity. On the other hand, on sites with poor drainage, shade and constantly higher humidity within the vegetation can lead to accumulation of mosses and humus on the soil surface and to eventual waterlogging so that a foliage layer above ground may give way to moss, low shrub, and herb vegetation of a bog nature that progressively intensifies the waterlogging. Here is a deviation-amplifying system giving rise to divergence, morphogenesis in the terms of Maruyama.

In the sub-Arctic and Arctic, certain special conditions are dictated by the short growing season, low sun angle, and winter darkness and long daylength in summer. Yocum [17] has shown that

... from the combined effects of the optical properties, heat transfer properties, and transpiration... plants decrease the heat load on the earth in the tropics and during the summer of temperate regions. Likewise they increase it in the winter of temperate zones. Thus they increase the amplitude of the time and space dependent temperature oscillations on the earth.

The higher the latitude, the less solar radiation available during the winter, so that the compensating increase of winter heat load by plants sticking through the snow is largely lost. Therefore, it is possible that the total effect of sub-Arctic and Arctic vegetation is to decrease the heat load on the earth's surface.

By no means do all plant communities develop closed canopy layers. Grassland, marsh, bog, and spruce forest communities that are so widespread in the North are examples of communities lacking foliage canopies. Therefore, one might expect that longer-wave length infrared radiation would tend to escape upward even during the growing season.

A forest of pyramidal spruce trees spaced about one crown diameter apart might also be expected to develop a kind of cellular pattern of radiation and convection under sunlight in absence of wind; sometimes snow-melt patterns in spruce forests imply this system. But just as the low sun altitudes in the North result in lower input of solar energy per unit area of the earth's surface, erect objects intercept more direct insolation that might otherwise reach soil surfaces. It is true that the sun moves through more nearly a complete circuit of the horizon; but where the shadows at noon are more than twice as long as the heights of the plants, a well-stocked stand of spruce, willows, or even grasses will keep the ground surface mostly in shade. Pyramidal spruce trees with spacing interval less than the minimum height will keep very nearly all of the ground surface in constant shadow. Objects in the shadows are irradiated primarily by infrared wave lengths about 2 microns and longer. As Gates [8, 9] has pointed out, plants have greater absorbance in these wave lengths and are heated readily while the source is available; however, as strong absorbance in a given spectral band is complemented by strong emittance in the same band, the plant surfaces cool rapidly by radiation.

During long days of summer there is little opportunity for release from the heat load derived secondarily from insolation, except by shadow from a major topographic feature, with thermal consequences nearly like those of nightfall. Shade effects of evergreen forest at 64°N are well demonstrated by de Percin's microclimatic study of a spruce forest and a clearing at Big Delta [11]. For the period June 12-30, 1956 the mean daily (Eppley radiometer) global radiation in the forest was 165 langleys in contrast to 452 langleys in the clearing.

In 1946 Brunt [18] stated in an address before the British Ecological Society:

When soil has vegetation the effective locus of both absorption and radiation is no longer the surface of the ground, but is somewhere within the limits laid down by that surface and the uppermost parts of the vegetation. The locus of absorption and radiation is then not a horizontal surface, but a layer of depth depending upon the vegetation.

He pointed out further that vegetation introduces a special factor in the thermal budget, that of evapotranspiration, which adds to simple evaporation at exposed surfaces the extraction of water from deeper layers in the soil and releases to the atmosphere under control by biological responses to other conditions. To these generalizations two more should be added: Vegetation diversifies the radiation environment over the sub-aerial surface of the earth, and vegetation represents a reservoir of stored energy that has many side effects on the thermal regime.

INVESTIGATING THE VEGETATION BOUNDARY LAYER

Virtually every study of energy budget in a natural system has disclosed unanticipated and unexplained anomalies, and thus new problems to be investigated. The thermal budget involving the vegetation boundary layer specifically has been less explored, but it certainly will prove no less complex. Yet we must get on with such studies, utilizing the better sensors and improved techniques now available for detection and measurement of thermal phenomena.

Point observations by thermometry and meager point sampling by radiometry have given us kaleidoscopic glimpses of thermal states. We need to determine distributions of quantities of thermal energy and rates of transfer. Of key importance are determinations, or at least approximations, of density, specific heat, and either diffusivity or conductivity (transmittance) for common substances in the vegetation-soil system. I have been able to find only scattered records of these properties for commercially used materials, and many of the observations were made with standards of accuracy and attendant conditions inadequate for our purposes.

We also need observations on reflectance and absorbance of the surfaces of these common natural materials, with attention to differences from one spectral band to another. With radiometers now available at reasonable cost, it should not require excessive labor or cost to obtain this information. Some of these tests could be made in the laboratory, and some should be made there in order to control adequately the spectral composition of illumination, temperature, and the moisture state of the surface under study; however, similar tests can and should be made under field conditions. Inconsistencies in results may lead to discoveries of additional variables imposed under the natural system.

Another kind of empirical investigation might be made practical for field use by coupling a laser system or other radiant energy projecting device with a radiometer. The laser could project a narrow band width of energy of measured intensity (and measured quantity if desired) upon a natural surface. A radiometer with appropriate band width sensor would be simultaneously trained on the irradiated surface to determine the reflectance. Currently, laser sources are available only for wave lengths as long as the near and middle infrared bands, as far as I know. Temperature sensors might be emplaced at appropriate depths beneath the irradiated surface to measure the thermal diffusivity of the body under the applied radiation load.

In the study of translocation of water in plant stems, use has been made of an experimental technique whereby a pulse of strong heat has been applied to one level on the stem so that temperature sensors at levels up and down the stem can detect the arrival of the heated internal fluid. This technique might be adaptable to studies of thermal diffusivity (or thermal resistance, as it has been called in empirical building research [19]) in plant stems and roots, humus layers, and layers of soil. For example, a string of temperature sensors (e.g., ceramic thermistors) could be emplaced in vertical series in soil, large roots, aerial stems attached to those roots etc., with an alternately interposed series of electrical resistance heating elements. Each heating element could

be energized independently with measured amounts of power so that the diffusing thermal anomaly could be measured by the network of sensing elements. By such an artificial temperature-anomaly technique, one could obtain empirical approximations of thermal diffusivity at critical points in a given site and under various conditions imposed by different seasons and weather sequences.

At the scale of the plant community and site, we could apply the technique of temperature integration or summation by sucrose ampoules to determine a total value for above-freezing temperatures at separate levels within the vegetation layer, within the litter, and at various levels within the soil. This method was described by Pallmann, Eichenberger, and Hasler [20] and modified by Berthet [21]. A solution of sucrose in water is changed to fructose and glucose at temperatures above 0°C. At constant pH the progress of the conversion is dependent upon temperature; and the polarimetric measure of the amount of inverted sugar, adjusted by the constant of inversion determined for the solution, permits calculation of the temperature summation (for temperatures above 0°C) for the exposure period. For slow inversion pH 2.92 is recommended, and for rapid inversion, pH 1.21. For inhibiting biological activity in the solution Berthet recommends addition of 35% formalin solution rather than sealing the glass ampoules as Pallmann did.

One of my students, A. W. H. Damman, used more than 100 sucrose ampoules with success in comparing growing season temperature summations in litter under various forest stands in Newfoundland. This method would be useful for thaw periods, either a full thaw season or as a monitor for thaw temperatures at other seasons. The advantage of this method is the ease and economy with which above-freezing temperature summations can be secured for a large number of sites.

Perhaps we have continued to rely so much on point temperature measurements alone because that approach in the atmosphere, if the water content is known, is adequate for thermal budget studies in that relatively uniform medium. The soil and associated vegetation mantle are anything but uniform, and their component materials are almost constantly changing in characteristics that have thermal significance and at rates and through time periods that are affected by an uncounted number of variables. Instruments are now available for measurement by remote sensing of reflected and emitted infrared radiation from surfaces, at scales appropriate for areas ranging from a square centimeter to a major portion of a continent. The varieties and general methods of this approach have been described by Colwell [22, 23] and in various articles in the Proceedings of the First and Second Symposia on Remote Sensing of Environment [24, 25]. Principles and present potentialities of remote sensing in general are described by Dana Parker [26], and the current state of infrared technology by Joseph Morgan [27].

Infrared imagery obtained by airborne sensors is planned for investigating thermal regimes of different plant communities in the University of Michigan Botanical Gardens. This area of about 200 acres has been mapped with respect to surficial materials, geomorphic units, agricultural soils, and plant communities; and we are establishing a program of observations there for a long-range study of the Fleming Creek watershed in connection with the Vigil network of hydrologic studies on small watersheds throughout the world. Photography with infrared film will be used, and it is hoped that imagery from longer wave length infrared can be obtained through other instrumentation.

A device that seems most promising is the airborne infrared detector coupled with a scanner, as described by Morgan [27]. The print-out can be in the form of an infrared strip map, which according to Morgan, can record energy variations corresponding to temperatures of a fraction of a degree. He states further that:

... a typical radiometer with an angular field of view of 5 milliradians and a detector time constant of 1 microsecond, operated in an aircraft at an altitude of 1,000 feet would have a ground resolution of 5 feet and would measure the radiation from a patch of terrain 5 feet square. . . . The rate of coverage is approximately 1,000 square miles per hour which is a typical value for a modern infrared scanner. . . .

[And] by modulating the scanner signal to operate a cathode ray tube, we can generate a picture using circuitry very much like that of standard television practice.

The information from the scanner can be placed line by line on photographic film in approximately the same way it was scanned. The scanning and recording process yields a picture indicating the distribution of radiation only in a qualitative way, as the quantitative aspects of scanning are lost in the steps of recording, photographing, and printing. However, there remains the opportunity for comparing intensities of images within the same picture and of relating image intensities to temperatures that were taken simultaneously on the ground. A single picture with information from one spectral-band width may not permit differentiation of reflected and emitted radiation, but differentiation may be accomplished in many instances by either multiband sensing, as recommended by Colwell [22], or by securing imagery for the same site under both day and night conditions (with and without solar illumination).

By utilizing simultaneous ground temperature observations and airborne radiometer records of actual temperatures of points within the scope of the imagery [5], infrared strip maps could be made to yield quantitative surveys of landscape units with respect to thermal states. If such surveys are conducted at close intervals around the clock, diurnal changes can be determined; if made at intervals around the year, seasonal changes could be approximated. Survey by airborne devices will provide generalized information that readily permits comparison of thermal characteristics of one site with another, an important aspect of research on ground frost phenomena.

CONCLUSIONS

We can validly make two assumptions. Where vegetation covers the ground, the energy-flux boundary between atmosphere and earth surface is a layer as thick as the height of the vegetation plus the layer of humus and root systems beneath it. On a surface that is uniform with respect to topography and materials, anomaly patterns of radiant energy flux (the amount of radiant energy of all wave lengths crossing a unit area of surface) between the atmosphere and solid earth are due to variations in vegetation composition or state. From these assumptions it follows that vegetation has a role in the occurrence of frost in soils.

The significance of vegetation in governing the occurrence of permafrost in soils decreases, however, the more the earth surface mean annual temperature is depressed below the freezing point. Where the surface mean annual temperature is not more than 2° or 3°C below 0°C, the kind and condition of the vegetation cover will be critical to the development and duration of permafrost, but where the surface mean annual temperature is more than several degrees below 0°C, the vegetation cover exercises little control. Vegetation does exert an influence, however, on the occurrence, extent, and effects of seasonal frost in the upper layers of soil, wherever the climate will produce such freezing.

The total effect of vegetation is to: (a) reduce the quantity of radiant energy that escapes either directly (by reflection) or indirectly to the atmosphere; (b) increase the long wave length infrared component in the energy that does escape to the atmosphere; (c) increase the energy diverted to work as in metabolism of organisms, physical and chemical weathering of rock materials, etc.; and (d) increase the store of energy on the earth in short-term forms as in vaporized water and in long-term forms as in humus and coal.

We now have the capabilities for investigating thermal exchange within a given unit of vegetation and to some extent, quantitatively. Microclimatological studies of recent years where radiation balance was recorded provide many of the observations needed for evaluating the thermal budget of a small unit of landscape. To that kind of survey we can now add radiometric surveys to measure temperatures of given surfaces and, by use of several band widths, at least the relative proportions of reflected and emitted radiation.

We need many measurements of specific heat, reflectance, and transmittance of plant parts, humus and soils of different composition, snow in different states, and other natural materials in order to demonstrate details of the thermal economy. Experiments with artificially introduced heat loads could be performed to determine pathways and rates of heat exchange. Temperature integration methods could be used to evaluate total heat budgets at specific loci in natural systems. It would be practical to undertake such surveys on landscape units of the order of 500 sq m, where soil and vegetation are as nearly homogeneous as possible throughout, and for distances of 500 to 1000 m on all sides. Marshes or sedge tundra would be well suited. Forest stands, especially those lacking uniformly closed canopies as the spruce or spruce-birch forests, would be much more complex.

We also have capabilities now for radiometry from airborne platforms that will permit rapid surveys of extensive areas of landscape. If such surveys were repeated several times each season and accompanied by ground observations of thermal conditions at appropriate reference stations, variations in thermal budgets over considerable areas could probably be related to permafrost and seasonal frost conditions in the soils.

REFERENCES

- [1] G. W. Holmes, W. S. Benninghoff. "Terrain Study of the Army Test Area, Fort Greely, Alaska," U.S. Geol. Survey for Waterways Exp. Sta. Corps of Engrs., U.S. Army, Washington, D. C., Vol. 1 (text), 1957.
- [2] D. H. Miller. "The Influence of Snow Cover on Local Climate in Greenland," J. Meteorol., Vol. 13, 1956, pp. 112-120.
- [3] D. H. Miller. "Snow in the Trees—Where Does It Go?" Western Snow Conf. Proc., 1962, pp. 21-27.
- [4] D. W. Boyd, L. W. Gold, G. P. Williams. "Radiation Balance during the Snow-Melt Period at Ottawa, Canada," Eastern Snow Conf. Proc., 1962, pp. 24-34.
- [5] D. J. Portman, F. C. Elder, E. Ryznar. "Research on Energy Exchange Processes (Summer 1960)," Univ. Mich., Great Lakes Res. Div. Publ. No. 7, Proc. 4th Conf. on Great Lakes Res., 1961, pp. 96-109.
- [6] A. Lachenbruch. "Three-dimensional Heat Conduction in Permafrost Beneath Heated Buildings," U.S. Geol. Survey Bull. 1052-B, 1957, pp. 51-69.
- [7] D. M. Gates. "Winter Thermal Radiation Studies in Yellowstone Park," Science, Vol. 134, 1961, pp. 32-35.
- [8] D. M. Gates. Energy Exchange in the Biosphere, Harper & Row, N. Y., 1962.
- [9] D. M. Gates. "The Energy Environment in Which We Live," Am. Scientist, Vol. 51, 1963, pp. 327-348.
- [10] C. C. Nikiforoff. "Reappraisal of the Soil," Science, Vol. 129, 1959, pp. 186-196.
- [11] Fernand de Percin. "Microclimatology of a Subarctic Spruce Forest and a Clearing at Big Delta, Alaska," Quartermaster Res. and Engrg. Center, Natick, Mass., Tech. Rept. EP-130, 1960.
- [12] L. R. Ingersoll, O. J. Zobel, A. C. Ingersoll. Heat Conduction, with Engineering, Geological, and Other Applications, Univ. Wisconsin Press, Madison, 1954, rev. ed.
- [13] D. M. Gates, C. M. Benedict. "Convection Phenomena from Plants in Still Air," Am. J. Bot., Vol. 50, 1963, pp. 563-573.
- [14] G. A. Riley. "The Carbon Metabolism and Photosynthetic Efficiency of the Earth," Am. Scientist, Vol. 32, 1944, pp. 132-134.
- [15] W. E. Loomis. "Absorption of Radiant Energy by Leaves" (abstr.), Ecol. Soc. Am. Bull., Vol. 44, 1963, p. 83.
- [16] M. Maruyama. "The Second Cybernetics: Deviation-Amplifying Mutual Causal Processes," Am. Scientist, Vol. 51, 1963, pp. 164-179.
- [17] Conrad Yocum. "Transmission and Reflection of Radiant Energy Within Plant Populations" (abstr.), Ecol. Soc. Am. Bull., Vol. 44, 1963, pp. 83-84.
- [18] David Brunt. "Some Factors in Micro-Climatology," Quart. J. Roy. Meteorol. Soc., Vol. 72, 1946, pp. 185-189.
- [19] Margaret Fishenden. "Heat Transmission," Dept. of Sci. & Ind. Research (London), Bldg. Res. Spec. Rept. 11, 1929.
- [20] H. Pallmann, E. Eichenberger, A. Hasler. "Eine neue Methode der Temperaturmessung bei ökologisches oder bodenkundlichen Untersuchungen," Ber. Schw. Bot. Ges., Vol. 50, 1940, pp. 337-362.
- [21] P. Berthet. "La Mesure Ecologique de la Temperature par Détermination de la Vitesse d'Inversion du Saccharose," Vegetatio, Vol. 9, 1960, pp. 197-207.
- [22] R. N. Colwell. "Some Practical Applications of Multi-band Spectral Reconnaissance," Am. Scientist, Vol. 49, 1961, pp. 9-36.
- [23] R. N. Colwell. "Platforms for Testing Multi-Sensor Equipment," Univ. Michigan, Proc. 2nd Symp. on Remote Sensing of Environment, 1963, pp. 7-49.
- [24] Institute of Science and Technology, Univ. Michigan. Proc. 1st Symp. on Remote Sensing of Environment, Ann Arbor, Feb. 1962.
- [25] Institute of Science and Technology, Univ. Michigan. Proc. 2nd Symp. on Remote Sensing of Environment, Ann Arbor, 1963.
- [26] Dana Parker. "Some Basic Considerations Related to the Problem of Remote Sensing," Univ. Michigan, Proc. 1st Symp. on Remote Sensing of Environment, 1962, pp. 7-23.
- [27] Joseph Morgan. "Infrared Technology," Univ. Michigan, ibid., 1962, pp. 61-80.

HUMMOCKS AND THEIR VEGETATION IN THE HIGH ARCTIC

ROLAND E. BESCHEL, Queen's University, Kingston, Ontario

During the summers of 1960 and 1962 the author worked on the geobotany of central and western Axel Heiberg Island (79° 30' N 90° to 95° W) and of the Fosheim Peninsula of Ellesmere Island (80° N, 85° W) [1, 2]. A great part of the ice-free land in the regions studied is covered with fine grained soils derived from soft Mesozoic shales and siltstones. Fragments of basalt and quartzitic sandstone are frequently mixed with the fines. The mixture was formed by amorphous solifluction or was deposited as till. Sorting by water and wind produced silt beds in flood plains, occasionally small dunes, and thin, loess-like deposits on lee slopes. Coarse sediments of boulders and gravel form the basalt and sandstone layers as mountain-top detritus and talus slopes, or as outwash fans in front of glaciers. Organic deposits are very rare. They are restricted to small accumulations of raw humus around bird perches and to thin peat layers

in shallow ponds. The mineral fraction constitutes the bulk of these soils even in the purest organic sediments.

The soils show a great variety of surface forms. Amorphous solifluction seems to be of little importance at present and no solifluction lobes were observed. Slopes with a greater amount of large fragments often have the material sorted in stripes or stone garlands. Parts of massive talus slopes started to move as boulder streams. Sorted structures on level ground are rare.

A large part of the land is covered with unsorted polygons and hummocks. Unsorted polygons range from cell sizes of 30 m to 10 cm. The largest units often contain a network of polygons with a diameter of a few meters, which in turn may be composed of cells or hummocks with a diameter of a few decimeters.

Hummocks range from a few meters to a few centimeters in diameter. Only an arbitrary division of this great variety of forms into types seems possible. All sizes of hummocks and polygons can be observed, and some of the smaller polygons may develop into hummocks. A complex of environmental factors produces these forms; different processes may be responsible to varying degrees for the development of patterns of a given size.

STRUCTURE OF THE VEGETATION

Plant cover varies greatly. The flora of Axel Heiberg Island consists of only 137 species of vascular plants, about 250 lichen species, and nearly 200 species of bryophytes. Many species show wide ecology, and plant lists of different communities show a confusing array of combinations of the same plants. Griggs [3] compared this great variety of groupings in arctic vegetation with the large number of different species combinations in weed patches of temperate latitudes. Immaturity of the vegetation should in both cases be responsible for a nearly free combination of a great number of species on a given place. The youth of the soil invaded by weeds is compared with the perpetual instability of the soil due to frost action. Raup [4], Hopkins and Sigafos [5], and Sigafos [6] stress cryoplanation and frost churning as important factors that prevent development of a climax in arctic vegetation. However, comparison of 63-year-old photographs with the present condition [7] shows that surprisingly few changes occurred in the pattern of stones as well as in the open plant cover of ground moraine on slopes up to 10° on Disko Island. Further evidence for a greater stability of fine grained substrates in the Arctic than previously assumed will be presented below.

Whatever the reasons, arctic vegetation shows numerous plant groupings stably existing side by side. In a given area the transitions of one plant community to another may be limited, but in another region the same sharp transition will occur between plant communities of a slightly different composition. Within the climate difference in a 1000-m altitude or over several degrees in latitude, the composition of communities will change greatly, but all intermediate combinations of species may be met. Each stand is a unique combination of species within a continuous series. This individualistic concept of the plant community [8] helps to clarify the structure of arctic vegetation. Vegetation types are more or less arbitrarily selected segments of a continuum. Some groupings may be more common than others, but this may well be a development parallel to the percentage distribution of the various habitats.

High arctic regions show not only a strong correlation of topographic site and plant cover, but also a good agreement of surface patterns with plant cover and site. Some of these types will be described as far as they relate to hummocky ground. Hummocks developed by growth and those developed by erosion were observed.

HUMMOCKS DEVELOPED BY GROWTH

Carex ursina grows on silt in the uppermost intertidal at the head of the Expedition Fjord (79°23' N, 91°08' W). Lower on the shore it is replaced gradually by a homogeneous mat of *Puccinellia phryganodes*. The *Carex ursina* belt grades upward into a sward of *Dupontia fisheri* and other glycophytes. Few other plants grow in the belt of optimum development of *Carex ursina*. The sedge forms individual cushions of 2 to 5 cm in height and 7 to 15 cm in dia., which are separated by bare silt spaces of 10 to 30 cm in width. The cushions are small hummocks of silt which appear randomly spaced within the indicated dimensions. The hummocks very likely grow by trapping silt during the highest tides, but this does not explain their spacing. *Carex ursina* forms continuous plane swards on shores of Melville Peninsula, eastern Baffin Island, Disko Island, and Nuvssuaq Peninsula.

Deschampsia brevifolia and *Poa arctica caespitans* cover scattered hummocks of 15 to 25 cm in dia. and 5 to 15 cm in

height on plains close to the shore north of Middle Fjord (79°45' N, 96° W). Many of these hummocks have a tail of sand on their southeast side. The sand, blown by prevailing north-west winds from the barren beach, is trapped efficiently by the tufted grasses. The hummocks are irregularly spaced, but usually they are several meters apart.

Poa alpigena colpodea, *Poa hartzii vivipara*, *Alopecurus alpinus*, *Salix arctica*, *Polygonum viviparum*, and *Stellaria ciliatosepala* grow on rather regularly cone-shaped sand heaps, 1 to 4 m in dia. and 30 to 120 cm in height, in the lower Expedition Valley (79°23' N, 90°58' W). This dune area covers about a hectare. The individual hummocks are commonly covered only with one of the listed species. Sand heaps seem to develop on clones or on individuals of those plants that could keep their growth in step with the amount of deposition. Eroded hummocks show typical cross-bedding of the sand without any folding or distortion of the layers. Hummocks of similar structure but covered with *Salix glauca* were observed near the margin of the inland ice north of Jakobshavn, West Greenland. Böcher [9] describes them from Søndre Strømfjord, West Greenland. *Carex Bigelowii* and *Polygonum viviparum* form such hummocks near the Barnes Icecap on Baffin Island. These sand heaps may be separated by flat spaces several times their width or they may abut directly upon one another and appear in the latter case very regularly spaced. The pattern may be influenced by the turbulence of the wind.

The slightly raised edges of furrows separating large ice-wedge polygons in the Expedition Valley have become bird perches in their highest parts [7]. Excess fertilization permitted the development of hummocks of raw humus to 60 cm in height and 2 m in dia. on these spots. The hummocks are spaced 100 to 200 m apart in relation to the size of the territories of long-tailed jaegers. These hummocks grew by the regurgitated pellets and droppings of the birds, by a faster production of plant matter than its decay, by the trapping of dust between the plants, and by the rise of the permafrost table in the hummock under the insulating blanket of the humus. Although expansion of the ice-wedges raised the edges of the furrows, the hummocks do not seem to grow by special frost heave under the mounds of raw humus.

Peat hummocks are common surface features of arctic, sub-arctic, and alpine regions. Under this term, I combine a number of related types which are described as tussocks and peat rings [5]; hummocky heath-sedge vegetation [10]; peat hummocks [9]; Torfhügel [11]; Kleinhügelbildungen [12]; frost hummocks [13, 14]; turf hummocks [15]; and Bultenböden, Rasenhügel, thufur, and palsat [16]. These surface features have in common a layer of fibrous organic matter, either of peat or of a dense sod of living plants, and they contain a core of fine grained mineral soil or ice. These structures have been pushed up by frost heave in interaction with the vegetation. They are commonly developed in wetlands.

Nothing comparable has been seen on Axel Heiberg Island and Fosheim Peninsula. This may be due to the absence of tussock- and cushion-forming wetland species. The dominating wetland plants in the region studied, *Eriophorum triste*, *E. scheuchzeri*, *Carex stans*, *Pleuropogon sabinii*, *Dupontia fisheri*, *Alopecurus alpinus*, *Equisetum arvense*, *E. variegatum*, are all stoloniferous geophytes which form loose mats instead of tufts. The dominant bryophytes of wetlands, *Drepanocladus*, *Calliergon*, *Polytrichum* are also matforming. Peat hummocks have been observed in central Baffin Island or in Alaska, where tussocks of *Eriophorum vaginatum spissum* are usually raised on mounds [5].

HUMMOCKS DEVELOPED BY EROSION

Clay hummocks are a common feature in the most continental parts of the High Arctic. Their development could be inferred in the vicinity of the airstrip of Eureka, Ellesmere Island (Figs. 1, 2, 3). The airstrip is maintained by adding soil onto its surface. This soil is scraped with bulldozers from the surrounding slopes which are composed of the weathered shales of the Jurassic or Cretaceous Deer Bay formation. The rapid melting of ice-wedges and other bodies of ground ice that be-

come uncovered during these operations leads to mudflows which expand upward. The undisturbed surfaces on level ground show only shallow trenches over the ice-wedges of giant polygons and sometimes traces of smaller polygons separated by very narrow cracks. The vegetation consists nearly exclusively of vascular plants. *Alopecurus alpinus*, *Puccinellia angustata*, *Agropyron boreale*, and *Salix arctica* dominate, but the total plant cover rarely exceeds 10%.

The upper end of an expanding mudflow is indicated by widened cracks between polygons 20 to 50 cm in dia. (Fig. 1). The cracks of 3 to 10 cm in width are bridged occasionally by roots of *Salix arctica* up to 1 cm in dia., which suggests that the cracks formed after the growth of the willows. The largest willows form patches 2.5 m in dia. and possess close to 100 growth rings in their central burls [17]. The soil must have been sufficiently stable at one time. There are no rocks present on which large crustose lichens indicate a greater age.

The cracks become progressively wider down the slope, and only 10 m away (Fig. 2) the polygons are changed to hummocks that are separated by furrows of at least 30 cm in depth and up to 30 cm in width. Plants grow only on the flat surfaces of the hummocks. Some meters farther down the hummocks do not appear prismatic but rounded. On the edge of the smooth and soft part of the mudflow many of the hummocks have been tilted as shown by the disoriented plant remains (Fig. 3) found 10 m downhill.

Many slopes on Fosheim Peninsula are covered with sparsely vegetated clay hummocks intermediate between the types shown in Figs. 2 and 3. Walking over these hard hummocks is just as cumbersome as crossing boulder fields. The hummocks are



Fig. 1. Contraction cracks on a mudflow



Fig. 2. Widened cracks and fully developed clay hummocks



Fig. 3. Toppling clay hummocks with very disturbed plant cover

identical with the Zellenboden as described by Sørensen [18]. The hemispherical or cylindrical clay hummocks are covered by plants on their tops as well as on their flanks to an equally low amount without indications of distinct zones. Their surfaces appear stable. Occasionally the soils contain a few small stones. If clay hummocks occur there, the stones do not show any recognizable pattern or sorting within the hummocks and on their surfaces.

Smith [19] clearly demonstrates this random distribution of stones in clay hummocks near Lake Hazen, Ellesmere Island. Clay hummocks are nonsorted structures as defined by Washburn [20], and their origin from convection cells, as Sørensen [18] assumed, appears unlikely. Thermal contraction rather than desiccation may form the cracks initially. In the hummock sequence of Figs. 1, 2, 3, the cracks very likely widened due to desiccation and solifluction, but the clay hummocks of Fosheim Peninsula have been formed more gradually by erosion. They do not seem to move downhill as there is no sign of accumulation or toppling of hummocks toward the lower parts of slopes. Their sparse plant cover has reached maturity in equilibrium with the desert climate of Eureka.

In slightly less continental areas, as on south-facing and moderately wind-exposed slopes of the Expedition Valley, hummocks of smaller size, 10 to 30 cm wide and 6 to 25 cm high, are covered from 30 to 85% by plants. *Dryas integrifolia*, *Kobresia myosuroides*, and *Carex nardina* dominate beside some earth lichens, e.g., *Alectoria nigricans*. Porsild [21] mentions the *Dryas-Kobresia* hummock tundra of the clay plains of the western Arctic islands as an indicator of formerly more active congeliturbation and relates it to peat hummocks.



Fig. 4. Head-size hummocks of unsorted boulder clay

The Dryas-Kobresia hummocks of Axel Heiberg Island differ only slightly from clay hummocks. Their plant cover is much too open to induce an uplift as in peat hummocks. The greater part of the Dryas clay hummocks and Dryas hummocks of Powell [22] and the "second stage of earth hummocks" of Smith [19] belongs to the same type. Many localities on Axel Heiberg Island with vegetation dominated by Kobresia myosuroides and Carex nardina do not show hummocks or polygons. These places are usually wind-exposed ridges of bedrock or edges of terraces. Their soils are covered with stones and the fine grains have been blown away from the surface.

In slight depressions on open slopes of central Axel Heiberg Island abound well-vegetated hummocks 20 to 60 cm in width and 10 to 30 cm in height (Fig. 4). Dryas integrifolia and various soil lichens, especially, Thamnotia vermicularis dominate the vegetation while graminoids are nearly absent. A cover of 80 to 95% is characteristic for these Dryas-Thamnotia hummocks. If the hummocks are formed of till they still show occasional stones on the surface and do not exhibit any sorting or arrangement of the stones within them. The "fully developed earth hummocks" of Smith [19] belong to this type or may be transitional to the next.

HUMMOCKS OF PROBLEMATIC DEVELOPMENT—EARTH HUMMOCKS

Cassiope hummocks have been described from several arctic regions by Polunin [23]. Smith [19] mentions Cassiope tetragona as locally abundant in wetter sites in the channels between the earth hummocks covered by Dryas. Sharp [24] defines earth hummocks in a wider sense and includes structures here mentioned as peat hummocks, but his descriptions refer mostly to patterns with size, shape, and composition of Cassiope hummocks. His Fig. 6 shows a slope in the Yukon Territory that may well be covered with Cassiope.

In central Axel Heiberg Island, Cassiope hummocks are the characteristic surface cover of sheltered slopes. These slopes face south or west in the Expedition Valley but they always face away from the mountain wind. Cassiope tetragona grows on horizontal surfaces as well but hummocks are absent there. The hummocks are usually 30 to 80 cm wide and 15 to 40 cm high. While the previously mentioned hummocks are always circular in plan, the Cassiope hummocks and some hummocks transitional to Dryas-Thamnotia hummocks are elongated horizontally on steeper slopes, as indicated earlier by Sharp [24]. Slopes with Cassiope hummocks have a reliable snow cover and melt free later than the previously mentioned hummock types. The last remnants of the snow are very dirty. A dust layer of a few millimeters' thickness may cover the plants after the snow has disappeared. These hummocks are free of stones although they may rest upon talus or till (Fig. 9). Plant cover is complete and 1 sq m may harbor over 40 plant species. Liverworts are common in only this hummock type.

Salix arctica, Polygonum viviparum, and Oxyria digyna are the dominating species on wide and low hummocks in more sheltered situations where the snow stays even longer than in the previous type. These snowpatch hummocks have a complete cover of plants but the species diversity is low. Lichens are nearly absent, and the cover of bryophytes is negligible. The variety of vascular plants may be greater than on other hummocks, but in extreme snowpatches only Salix and Polygonum may be present. Snowpatch hummocks commonly occur lower on slopes than Cassiope hummocks, but depressions on sheltered slopes may be covered by them as well (Fig. 10). These hummocks are circular or elongated horizontally. Their surfaces are sometimes flattened and parallel the slope. The furrows between them are wider than in the four previous types.

Hummocks are usually absent in central Axel Heiberg Island toward the bottom of slopes or in the centers of little valleys on slopes. These habitats have water seeping over the surfaces during the melting of the snow. In the second half of June the soil dries up and hardens. During the end of July and August, however, many of these sites soften again. The progressive thaw of the active layer frees more gravitational water. It percolates downhill on top of the permafrost and

rises to the surface in lower parts. Active solifluction seems to be limited to these sites. The soils are commonly arranged in sorted stripes on angles of slopes of only a few degrees, but the much steeper slopes bear hummocks. The vegetation may cover 100% of the wet slopes. A great variety of vascular plants occurs there. Up to 27 species of vascular plants were found growing in 1 sq m. (For comparison, an old field contains about ten, and a rich deciduous forest about five species of vascular plants in 1 sq m.) Grasses and sedges dominate on these wet slopes. Occasionally the graminoids may extend onto some low and rather irregular hummocks either in transition to the snowpatch, or to the Cassiope hummocks. A graminoid hummock type may be distinguished accordingly.

THE HUMMOCK CATENA

Different surface patterns described above as developed by erosion may occur more or less pure and alone on a slope, or they may grade into another type. Sequences along a slope correspond to those listed, but some parts are commonly omitted. Nearly all combinations have been observed on Axel Heiberg Island.

Cassiope and snowpatch hummocks become rare toward more continental regions (in the eastern parts of Axel Heiberg Island, in the vicinity of Eureka, or at Lake Hazen on Ellesmere Island). Conversely, Dryas-Kobresia and clay hummocks decrease in importance in the more oceanic parts toward the west of the island. All hummock types decrease toward the northern lowlands and toward greater altitudes.

The absence of a certain hummock type within a sequence often depends on local topography. A low basalt cliff may have some Dryas-Kobresia hummocks on top and Cassiope hummocks at its base while a low slope of moderate exposure may have Dryas-Thamnotia hummocks grading directly into a wet slope. Analogous to the catena of soil profiles along a moisture gradient in a given area, the sequence of hummocks along a similar gradient may be called a hummock catena. Hummock types, like classifications of patterned ground or of plant communities, could be arranged in a logical system. The inherent artificiality of these thought systems has led to many sterile debates. It seems more rewarding to study the actual transitions along a catena, aiming at a correlation with the environmental factors that act as causative agents for the pattern.

One hummock profile was studied in the Expedition Valley which shows a sequence from Dryas-Kobresia hummocks to a wet slope within 30 m (Fig. 5). South of the Expedition River lies a raised delta northeast of the Little Matterhorn at 50 m in altitude. The delta has been cut by a brook. Radio-carbon dates of peat lower than the delta and of shells above the height of the delta suggest between 4,200 and 10,000 years since its emergence. The present slope of the cut may be several thousand years younger, but the vegetation on the undisturbed northern edge of the delta does not differ from the



Fig. 5. Hummock profile area with ice ax in center

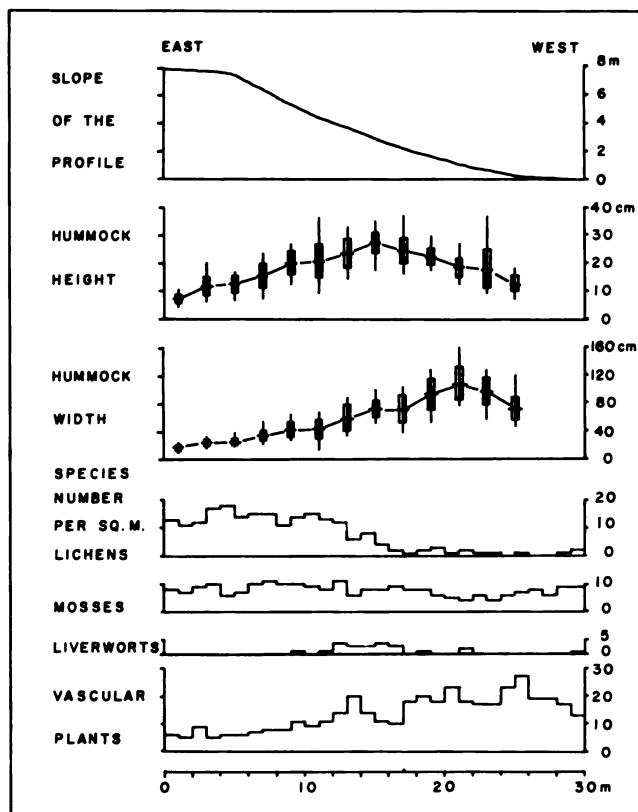

Fig. 6. Profile of hummock catena shown in Fig. 5

vegetation in the cut where the profile was taken. This indicates that the plant cover of the profile cannot get more mature under present environmental conditions.

The slope of this hummock profile was measured along a steel tape with an Abney level (Fig. 6). Within each 2-m interval along the base line, I recorded from both sides of the tape the height and width of hummocks to a total of 20 measurements. These 2-m strips were outlined by horizontal strings. Hummock height was determined as the mean of the vertical heights of the top of the hummock measured from the furrow above and the furrow below the hummock. The width was likewise determined as the mean of the greatest and the smallest diameter of the hummock, if it differed noticeably from a circular outline. A number of further measurements that promise meaningful results could be made on such hummock populations. Ranges, means, and standard deviations of the measurements are shown in Fig. 6; the relationship of height means to width means is shown for each 2-m interval in Fig. 7. Unevenness of the ground in the last two intervals is so slight that no measurements could be made there.

A wooden frame of 1 by 1 m with a wire stretched across 10 cm from the edge parallel to the base line was placed over each meter of the profile. The presence of all macroscopically visible plants was noted for each square meter but lichens growing on stones were omitted. The cover of each plant species, the total cover, the bare ground, and the amount of surface taken up by stones were estimated in percentage for a strip 10 cm in width and 0.1 sq m in area. Such an estimate is quite accurate as each centimeter along the tape means 1%. The cover of each species was totaled from the areas estimated for each patch of the plant. Estimates always added close to 100% and the necessary corrections of a few per cent were made in the estimate of the dominating species. Specimens of critical plants were collected at each meter. The total number of species in the four largest taxonomical groups is plotted for each square meter in Fig. 6. The number of liverwort species may be somewhat higher than recorded as many species occur only as minute

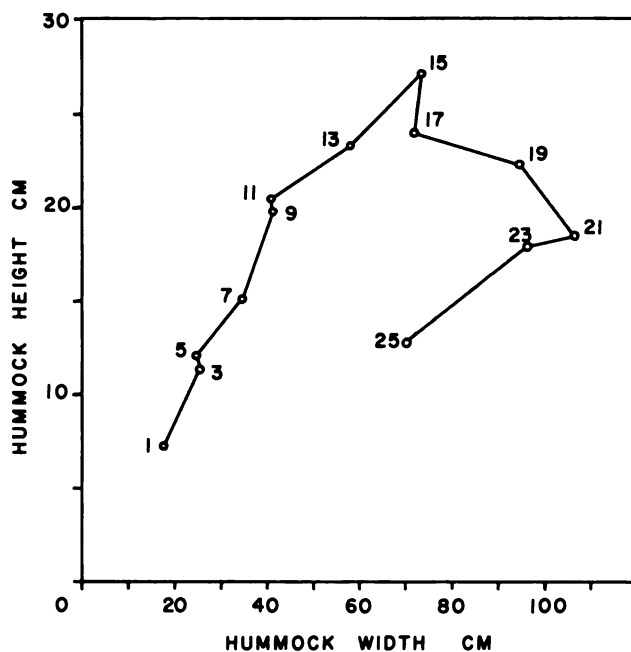

Fig. 7. Mean relationship of hummock height to hummock width at intervals along the profile

admixtures to cushions of other liverworts and may have not been recognized.

The cover of some common plants in each quadrant of 1 by 0.1 m is plotted in Fig. 8. Values of the four most common plants are shown in a different scale than the others. Presence of a species outside the 10-cm strip but within the 1-m strip is indicated by dots.

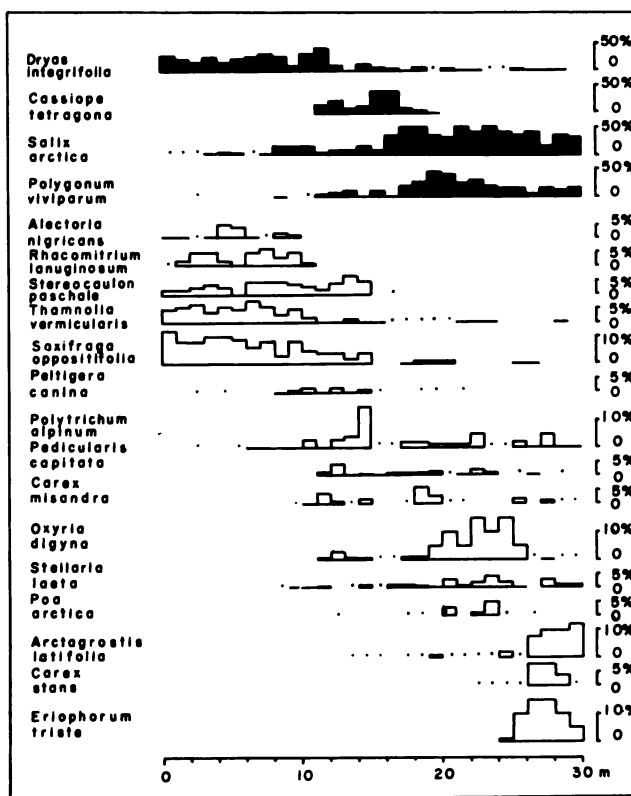

Fig. 8. Cover percentages of some common plants

Few references to size and shape differences of hummocks could be found. Polunin [23] reports that on Southampton Island "The *Dryas* forms tussocks of varying size up to half a metre in diameter, which tend to be larger towards the bottoms of banks or depressions," Sørensen [18] writes about Zellenboden: "Meine Beobachtungen aus Ostgrönland scheinen am ehesten in die Richtung zu weisen, dass die stark gewölbten Felder sich am häufigsten über austrocknendem Grunde finden, während die flachen besonders auf feuchtem Boden vorkommen." The size of the units of structured soil, which Sørensen assumes to be convection cells for polygons and hummocks alike, depends again on the water content of the soil. He mentions only observations on polygens, but his statement refers by implication to hummocks as well.

The continuous and gradual change of hummock height and width and of the vegetation suggests that these patterns have been formed by differences in environmental processes which are a matter of degree and not one of kind. Such an environmental factor could be time, and one might envisage some kind of succession linking a great part of these hummock and vegetation patterns into one sequence of development. The assumption, however, that a side-by-side sequence corresponds to a sequence in time may be very misleading. It becomes even more hazardous to arrange in a time sequence patterns that do not even exist side-by-side. I cannot agree with the succession of earth hummocks as outlined by Smith although I concur with his statement: "The origin of these earth hummocks is not clear" [19].

The increase of hummock size downhill could be interpreted as a growth process. Each hummock could move downhill by slow creep and increase in size on the way. The motion might be accelerated by the pressure of the growing hummocks against each other and the greater water content of the soils on lower parts of slopes. Frost heave and growth of the hummocks by sucking or pressing fines into the structure as outlined by Beskow [25] might cause such a development.

A motion of hummocks downhill is indicated by steeper slopes of hummocks toward the valley, by the occasional formation of crypts on the lower side of *Cassiope* hummocks, and especially by buried plant layers under the part of the hummock facing downhill. This is shown by Sharp [24] and was found on the Gate Ridge in Axel Heiberg Island (Fig. 9). The remains of *Cassiope* stems extended recognizably for 15 cm under the hummock. This proves that the hummock moved at least 15 cm since its formation and not necessarily more.



Fig. 9. Bisect of west-facing earth hummocks on basalt talus with a complete cover of vegetation

The situation south of Crusoe Glacier (Fig. 10) makes the hypothesis of hummock succession and movement highly unlikely. Snowpatch hummocks are surrounded on this slope on all sides by *Cassiope* hummocks. Any hummock moving through

the central *Polygonum* patch on this slope would have to decrease again in width and increase in height. The development might have come out of phase there, but this would have led to unequal distribution of sizes; some hummocks ought to be compressed at the limit of the snowpatch hummocks, which is not the case.



Fig. 10. West-facing flank of a raised beach

Further evidence against a hummock succession along the catena could be found through grain-size analysis. Soil samples were collected especially along a vegetation profile across the Gate Ridge in the Expedition Valley including the bisect shown in Fig. 9. Oven-dried samples of 100 to 150 g were treated with a rubber pestle and shaken in a standard sieve series. Breaking up of the aggregates seems more efficient in nonsorted soils where hard stones act as additional abrasives during the shaking. The grain sizes in sorted soils should tend to be smaller as the analysis indicates. The cumulative percentages in Table I are based on the amount of the soil passing through a 4.75-mm sieve as 100%. Roots were removed from the soils.

Table I. Grain size distribution in cumulative percentages of some soil types in the Expedition Valley, Axel Heiberg Island

Particles							
Sieve No.	Size, smaller than mm	Cumulative Weight Percentages in Sample					
		1	2	3	4	5	6
4	4.75	100	100	100	100	100	100
16	1.19	76.3	88.1	99.0	98.5	100	100
30	0.59	63.7	78.9	92.6	88.5	99.6	99.0
50	0.297	53.8	67.5	80.2	72.9	97.6	95.8
80	0.178	45.9	54.3	61.5	55.0	93.2	88.6
200	0.074	32.7	31.9	27.2	22.0	60.4	59.4

The six samples in Table I are described as follows: Soil is 5 to 10 cm in depth in a wind-deflated ground moraine on top of the Gate Ridge. (2) Soil is 40 to 50 cm in depth below the top of the *Cassiope* hummock shown in Fig. 9 as No. 2. This hummock lies 80 m southwest and 8 m lower than the previous locality. (3) Soil is of the same hummock on top of a buried boulder and is 5 to 10 cm below the surface of the hummock on its upper slope shown in Fig. 9 as No. 3. (4) Soil is 5 to 10 cm in depth below the top of the hummock shown in Fig. 9 as No. 4. (5) Soil is 5 to 10 cm below the highest point of a snowpatch hummock at 21 m of the hummock profile south of the Expedition River. The locality is indicated by the ice ax in Fig. 5. (6) Soil is 5 to 10 cm in depth below the lowest part of a furrow beside the previous sample.

Hummocks at the upper end of the catena consist of unsorted material and contain many stones like the nonsorted, deflated ground moraine (sample 1). *Cassiope* hummocks are composed

of fine grained, well sorted particles and lack stone (samples 3 and 4). The Cassiope hummock shown in Fig. 9 rests on talus that has the spaces between the boulders filled with a mixture of grain sizes quite comparable to the material in the unsorted ground moraine (sample 2). The snowpatch hummock of the hummock profile (samples 5 and 6) has an even greater silt and clay fraction than the Cassiope hummock at the Gate Ridge. These samples are from different localities, however, and further proof is needed before this difference in grain size between Cassiope and snowpatch hummock can be considered significant.

Had the small Dryas hummocks grown by accretion or infusion into larger Cassiope hummocks, the latter should still contain some of the stones. The absence of stones, gravel, and much of the coarse sand in the earth hummocks suggests a different development and rules out any substantial movement of the hummocks since their formation. The possible origin of the earth hummocks can now be narrowed further. These structures developed in situ. A gradual growth in width is not possible as the structures did not move away from each other. More likely they developed from the beginning in the diameter class determined by their position on the catena. The earth hummocks may have grown in height gradually. The fine grained material could have entered by frost heave from below if a thick enough mantle of vegetation provided the insulation to delay freezing under the hummock. Yet, vegetation on the best developed Cassiope and snowpatch hummocks covers tops and furrows with a continuous blanket. Before the hummocks started to grow, differences in the vegetation must have been even slighter. Further, the vegetation covers the ground 100%, but the soil itself does not possess a distinct layer of insulating peat or humus. Rootlets in the Cassiope hummocks penetrate 50 cm down to the underlying strata as shown in Fig. 9. An infusion of fine grained material by frost heave should push these roots aside.

The supply of material coming from below is unlikely; this leaves, as the last possibility, deposition from above. The pronounced sorting of the grain sizes in the earth hummocks makes wind deposition quite likely. The dirt layer, accumulating on Cassiope and especially on snowpatch hummocks after the snow melts, is clear evidence for the hypothesis of hummock growth by the deposition of dust on vegetation as in the formation of loess. A further point in favor of the loess hypothesis can be seen in the distribution of the plants. Only fast-growing lichens like Peltigera canina, P. aphtosa, and Stereocaulon paschale extend from the upper segments of the catena with numerous lichens into the zone of the Cassiope hummocks; even these lichens are absent from the snowpatch hummocks.

Bryophytes can withstand some sedimentation, but even they decrease in the snowpatch hummocks as well as in the dune areas. Snowpatches in other arctic regions often possess dense carpets of liverworts. Such a snowpatch vegetation occurs in Axel Heiberg Island, mostly at greater altitudes and in more oceanic regions. Sedimentation on lee slopes in valleys with strong winds and wide expanses of bare ground in the outwash fans in front of glaciers seems to be adequate to provide all the material for the earth hummocks. Sedimentation in the sparsely vegetated upper parts of the catena decreases progressively, and the Dryas-Kobresia hummocks may even be eroded by the wind.

The width of the hummocks seems to be governed by water content of the soils and depth of thaw at the beginning of the freezeup. Thermal contraction breaks the soil into cells of rather definite size. Such cells may originate in a carpet of Racomitrium lanuginosum. The mat of this moss may be an early phase in the development of Cassiope hummocks over talus.

Thick mantles of peat and humus develop over moist surfaces only under less extreme climatic conditions. There the opportunity seems favorable for the formation of peat hummocks. Types intermediate to earth hummocks and to hummocks forming by erosion can be expected. Peat hummocks may occur in a more southern hummock catena, probably in the segment corresponding to the position of the graminoid hummocks in a hummock catena of Axel Heiberg Island.

ACKNOWLEDGMENT

The Jacobsen - McGill Arctic Research Expedition and the National Research Council of Canada supported these studies. I should like to thank my colleagues of the expedition, especially Dr. Fritz Müller, for their fine collaboration.

REFERENCES

- [1] R. E. Beschel. "Botany; and Some Remarks on the History of Vegetation and Glaciation," Jacobsen-McGill Arctic Res. Expedition to Axel Heiberg Island, 1961, Montreal, McGill Univ., pp. 179-199.
- [2] R. E. Beschel. "Geobotanical Studies on Axel Heiberg Island in 1962," Axel Heiberg Island, Prelim. Rept. 1961-1962, 1963, Montreal, McGill Univ.
- [3] R. F. Griggs. "The Problem of Arctic Vegetation," J. Wash. Acad. Sci., Vol. 24, 1934, pp. 153-175.
- [4] H. M. Raup. "Vegetation and Cryoplanation," Ohio J. Sci., Vol. 51, 1951, pp. 105-116.
- [5] D. M. Hopkins, R. S. Sigafos. "Frost Action and Vegetation Patterns on Seward Peninsula, Alaska," U.S. Geol. Surv. Bull., Vol. 974 C, 1951, pp. 51-100.
- [6] R. S. Sigafos. "Frost Action as a Primary Physical Factor in Tundra Plant Communities," Ecology, Vol. 33, 1952, pp. 480-487.
- [7] R. E. Beschel. "Observations on the Time Factor in Interactions of Permafrost and Vegetation," Proc. 1st Canadian Conf. Permafrost, Natl. Res. Coun. Canada, Assn. Com. Soil Snow Mech. Tech. Memo., Vol. 76, 1963, pp. 43-56.
- [8] H. A. Gleason. "The Individualistic Concept of the Plant Association," Bull. Torrey Botanical Club, Vol. 53, 1926, pp. 7-26.
- [9] T. W. Böcher. "Oceanic and Continental Vegetational Complexes in Southwest Greenland," Meddelelser om Grønland, Vol. 148, No. 1, 1954, pp. 125-141.
- [10] H. C. Hanson. "Vegetation and Soil Profiles in Some Solifluction and Mound Areas in Alaska," Ecology, Vol. 31, pp. 606-630.
- [11] H. Gams. "Torfhügelmoore in den Zentralalpen," Naturwissenschaftliche Monatsschrift "Aus der Heimat", Vol. 54, Nos. 4, 5, 1941, pp. 60-66.
- [12] G. Furrer. "Solifluktionsformen im schweizerischen Nationalpark," Ergebnisse der wissenschaftlichen Untersuchungen des schweizerischen Nationalparks, Neue Folge, Vol. 4, 1954, pp. 201-275.
- [13] P. J. Williams. "Solifluction and Patterned Ground in Rondane," Skifter Norske Videnskabs, Akademe Oslo I. Matematisk - Naturvidenskabelige Klasse, Vol. 1959, No. 2, 1959, pp. 1-16.
- [14] P. J. Williams. "Climatic Factors Controlling the Distribution of Certain Frozen Ground Phenomena," Geografiska Annaler, Vol. 43, 1961, pp. 339-347.
- [15] H. M. Raup. "Turf Hummocks in Northeast Greenland," Am. Assn. Adv. Sci. Meeting, Denver, Colo., Dec. 1961.
- [16] C. Troll. "Strukturböden, Solifluktion und Frostklimate der Erde," Geologische Rundschau, Vol. 34, 1944, pp. 545-694.
- [17] R. E. Beschel, Deirdre Webb. "Growth Ring Studies on Arctic Willows," Axel Heiberg Island, Prelim. Rept. 1961-1962, 1963, Montreal, McGill Univ.
- [18] T. Sørensen. "Bodenformen und Pflanzendecke in Nordostgrønland," Meddelelser om Grønland, Vol. 93, No. 4, 1935, pp. 8, 17, 47.
- [19] D. I. Smith. "The Geomorphology of the Lake Hazen Region, NWT," Montreal, McGill Univ., Ottawa, Defense Res. Bd., Rept. D. Phys. R (G) Hazen 15, 1961, photos 9, 10, 11, pp. 78-82.
- [20] A. L. Washburn. "Classification of Patterned Ground and Review of Suggested Origins," Geol. Soc. Am. Bull., Vol. 67, 1956, pp. 823-866.
- [21] A. E. Porsild. "The Vascular Plants of the Western Canadian Arctic Archipelago," Natl. Museum Canada Bull., Vol. 135, 1955.
- [22] J. M. Powell. "The Vegetation and Microclimate of the Lake Hazen Area, Ellesmere Island, NWT," Montreal, McGill Univ.; Ottawa, Defense Res. Bd., Rept. D. Phys. R (G) Hazen 14, 1961, Figs. 24, 25, pp. 8, 112.

[23] N. Polunin. "Botany of the Eastern Canadian Arctic III. Vegetation and Ecology," Natl. Museum Canada Bull., Vol.

104, 1948, pp. 109, 147, 229, 247.

[24] R. P. Sharp. "Soil Structures in the St. Elias Range,

Yukon Territory," J. Geomorphology, Vol. 5, 1942, Fig. 7, pp. 274-301.

[25] G. Beskow. "Erdfliessen und Strukturböden der Hochgebirge im Lichte der Frosthebung," Geol. Fören. Stockholm Förh., Vol. 52, 1930, pp. 622-638.

INFLUENCE OF VEGETATION ON PERMAFROST

R. J. E. BROWN, National Research Council, Canada

In permafrost regions numerous climatic and terrain features operate singly and in combination, determining the extent, thickness, and thermal regime of the perennially frozen ground. One of the terrain features is vegetation which forms a continuous or discontinuous mantle on the ground (soil) surface and exerts direct and indirect influences on the underlying permafrost.

Vegetation has a direct influence on the permafrost by its thermal properties which determine the quantity of heat that enters and leaves the underlying ground in which the permafrost exists. Components of the energy exchange regime at the ground surface and thermal contribution of each of them to permafrost are modified by surface vegetative cover. Vegetation also exerts an indirect influence on permafrost by affecting climatic and other terrain features, which in turn have a direct influence on the permafrost.

These direct and indirect influences vary with time and space. The environment in which permafrost exists is dynamic as are the individual components of this environment. Vegetation is one of these dynamic factors and varies with time. As one type of vegetation is succeeded by another, so the underlying permafrost is changed with time. As a result, permafrost existing today reflects direct and indirect influences of the past as well as the present. The effects of vegetation also vary in space, being greater, for example, in the taiga zone than in the tundra.

The sum of these influences with their variation in time and space is manifested in the variations which exist in the permafrost. The depth from ground surface to permafrost table, the temperature regime of the ground above the permafrost and of the permafrost, and the extent and thickness of permafrost are all conditioned by vegetation on the ground surface. Because vegetation is so closely interwoven with climatic and other terrain factors affecting permafrost, it is frequently difficult or impossible to single out the role of vegetation alone.

Even within the vegetation complex itself, some components have more influence than others. It is frequently difficult to delineate the boundary between living vegetation and underlying organic matter, litter, humus, peat, muck, and to separate the influence of these two layers. It is most convenient, therefore, to consider the combined living and dead material lying on the mineral soil as vegetation, although each may have a different effect.

Further complications are caused by the fact that the influences of vegetation may vary depending on conditions under which they occur. As a result, it is possible for a certain combination of vegetation and other factors to produce one set of permafrost conditions at one time or place, and a different set of conditions at another time or place.

Because vegetation is such a widespread factor of the permafrost environment, a large body of literature is devoted to this topic in North America and the USSR. Russian literature is particularly voluminous, the most prominent authors being B. A. Tikhomirov and A. P. Tyrtikov. (The latter has compiled two lengthy and comprehensive review papers on the influence of vegetation on permafrost [1, 2].) Work has also been carried out in Scandinavia on variations in near-surface ground temperatures under different types of plants and on use of plant types as snow depth indicators [3, 4]. Both have important implications in the relationship between vegetation and permafrost.

Present knowledge of the influence of vegetation on perma-

frost are reviewed. The complex nature of the problem makes it impossible to cover all facets. Canadian experience is cited when available with supplementary information derived mostly from Russian observations.

SURFACE ENERGY EXCHANGE

The annual heat exchange equation [5, 6] at the earth's surface can be written as

$$R + LE + P + B = 0 \quad (1)$$

where (R) is the annual radiation balance (net radiation), (LE) is heat involved in evaporation (including evapotranspiration)-condensation, (P) is heat involved in conduction-convection (turbulent heat exchange), and (B) is thermal exchange in the ground.

The contribution of each of these components to the heat transfer mechanism operating between soil and atmosphere is modified by vegetation properties at the interface of these two media which comprise the permafrost environment. Russian studies show that the heat exchange equation can be used in permafrost regions to relate the ground thermal regime to the surface energy exchange regime [7, 8].

Net Radiation and Albedo

Studies undertaken in Labrador-Ungava [9], using a Kipp and Zonen solarimeter, confirm the higher albedo—solar radiation mostly 0.3-2.0 μ —of treeless lichen-covered surfaces, being 13.55% in contrast to 11.67% for lichen-spruce woodland, 6.52% for spruce bog, 9.78% for muskeg, and 11.13% for a closed forest.

At Norman Wells, NWT, where permafrost is widespread, observations by the Division of Building Research, National Research Council, Canada, showed that lichen possessed higher reflectivity values than true mosses and Sphagnum. Nevertheless, these two plant types maintain the permafrost table at about the same level in a given area, and ground temperatures under both plant types are similar. Therefore, if lichen rejects a higher proportion of the net radiative flux than moss, this may be compensated by the moss rejecting a higher proportion than lichen of some other component of the energy exchange.

Another aspect of the radiation component of heat exchange is the influence of forest growth in reducing the intensity of solar radiation at the ground surface which decreases the heating of the ground. If, for example, radiation in an open area is 1.5 cal/sq cm/min it may be reduced to 0.01 cal/sq cm/min under a dense forest canopy. In winter the forest hinders the rate of radiation from the ground but the effect is not as pronounced because of reduced foliage [1, 2].

Conduction-Convection

Direct measurement of the convective component is extremely difficult. In energy exchange studies, quantitative values can be obtained by two methods: (1) All of the other components of the heat exchange equation are measured and it is assumed that the remainder equals the convective component; (2) Bowen's ratio can be used which relates this component to the evaporative flux. Since the annual heat exchange equation at the earth's surface can be written as

$$R = LE + P \quad (2)$$

It follows that an increase in heat transfer by evaporation decreases the amount of turbulent exchange and vice versa. Investigators in the USSR stated that the ratio of (P) to (LE) at the treeline is about 1 to 6 or 1 to 7, increasing to about 1 to 3 with increased surface roughness in the south-central part of the taiga where the permafrost boundary occurs [5]. The (P) to (LE) ratio at Point Barrow, Alaska, was 1 to 0.7 [10, 11]. Bowen's ratio for saturated Sphagnum in Ottawa, Canada, at the Division of Building Research, was about 1 to 8.

Variations in turbulent heat exchange with different plant species have not been examined in permafrost regions. On a microscale, the roughness factor provided by the vegetation is greatly reduced north of the treeline. On a microscale, Sphagnum tends to produce an uneven microrelief in the form of hummocks, mounds, and peat plateaus in contrast to areas covered with true mosses and lichen which have less microrelief. This could result in ground surface air turbulence being significantly greater over a Sphagnum-covered area.

Evaporation

Evaporation (including evapotranspiration) withdraws heat from the surrounding atmosphere and from incident solar radiation [12]. Vegetation draws water from the soil by transpiration, thus depleting the soil of the heat held by that water. There appear to be variations in these mechanisms from one plant species to another in permafrost regions, but the magnitude of variations and the contribution of this component to ground thermal regime are not clear.

The mechanism of moisture transfer in moss and lichen is not clearly understood, but both are nonvascular plants and cannot transpire in the sense that vascular plants do. Sphagnum especially, and to a lesser degree true mosses, tend to absorb and raise water in the manner of a lamp wick. Mosses and lichens have a large water-holding capacity and are strongly hygroscopic [13, 14, 15]. They absorb water not only from precipitation but also from atmospheric vapor, the latter being absorbed in direct proportion to the relative humidity of the air. Yet during a dry period they tend to lose moisture rapidly. Probably at some point in the humidity scale for the atmosphere, losses exceed the gains of moisture by the lichens.

Tyrtikov [2] postulates that as vegetation absorbs moisture from the soil there is a commensurate increase in the soil thermal conductivity. This occurs at the same time as the evaporation of the water lowers the air temperature, especially near the ground surface, and so reduces the warming of the soil. Immediately after a rainfall, the sun rapidly dries the tips of the moss but this drying extends only to a depth of about 5 cm, thus protecting the lower layer of moss from excessive loss of moisture.

When dry, lichens absorb water slowly from water vapor. This process is negligible, however, compared with the absorption of liquid water because, during a rainfall, the water content of the aerial parts may rise from 50 to 250% within a few hours [14]. The loss of water vapor to the air may occur rapidly if the difference in vapor pressure between the air and the lichen is great, so that on a drying day, the surface of the lichen becomes dry rapidly. Observations by the Division of Building Research at Norman Wells, NWT, of the moisture content in a lichen cover during a dry period showed 8% moisture content in the top 1 in. of the lichen in contrast to nearly 200% at the bottom of the 2-in. lichen cover. Unlike Sphagnum and true mosses, lichen may not be acting as a wick in drawing moisture from beneath, but it appears to be protecting underlying moisture from evaporating influences of the air above. Rapid evaporation or diffusion exchange of water vapor from the wet basal layer to the atmosphere above the lichen may contribute, however, to low soil temperatures and a high permafrost table.

Despite speculation that the high permafrost table under true moss, Sphagnum, and lichen may be caused in part by high evaporation rates that prevent large quantities of heat from entering the ground, observations at Norman Wells in the summer of 1959 showed that rates of water loss from moss and lichen were about equal to each other but lower than from a grass-like

sedge, species unknown, or grass [16]. Observations in the summer of 1960 showed that rates for moss, lichen, and the sedge were about equal to or lower than for grass.

Meteorological factors play a prominent role in evaporation and transpiration rates where soil moisture is not a limiting factor. Physiological characteristics and radiation and thermal properties of plants such as moss and lichen, which maintain high permafrost tables, probably contribute significantly by evaporation and transpiration to the energy exchange regime of permafrost. A discrepancy arose at Norman Wells where the sedge did not maintain a high permafrost table but displayed evapotranspiration rates comparable to rates of moss and lichen. This may have been caused by the lower insulating values of the sedge which permitted a greater depth of thaw during the summer.

Conductivity

Vegetation has a marked insulating effect on underlying permafrost. This is true of mosses, lichens, and particularly, of peat. Increase in depth of thaw in permafrost areas where vegetation has been removed has been widely observed.

Variations in the thermal conductivity of peat with moisture content contribute to conditions conducive to formation of permafrost [2]. When dry, peat has a low thermal conductivity, equivalent to that of snow (about 0.00017 g cal/sec sq cm °C cm). When wet, its thermal conductivity is greatly increased (unsaturated peat is about 0.0007 g cal/sec sq cm °C cm; saturated peat—e.g., about 0.0011 g cal/sec sq cm °C cm); when frozen, its thermal conductivity is increased many times over that of dried peat and approaches the value for ice (e.g., saturated frozen peat about 0.0056 g cal/sec sq cm °C cm). During the summer a thin surface layer of dried peat, which has a low thermal conductivity, hinders heat transfer to underlying soil. During the cold part of the year, peat is saturated from the surface, and when it freezes its thermal conductivity greatly increases. Because of this, the amount of heat transferred in winter from ground to atmosphere through the frozen ice-saturated peat is greater than the amount transmitted in the opposite direction through the surface layer of dry peat and underlying wet peat in summer. A considerable portion of heat is also required during the warm period to melt the ice and to warm and evaporate the water. The net result is favorable to a permafrost condition.

The rate of organic and peat accumulation varies with the type of vegetation and influences thermal conductivity of the surface soil layer and thermal regime of the underlying permafrost. In a given climatic zone, less organic material accumulates from meadow and steppe vegetation than from forest and bog vegetation. Organic material accumulates more quickly in a coniferous forest than in a deciduous forest. Coniferous forests with their dense tree crowns and acidic litter tend to create conditions suitable for the development of mosses, particularly where a cool climate has reduced evaporation to a point where the forest floor will be moist despite a low rain fall. The rate of accumulation in a forest is related to many factors, including the presence or absence of moss and lichen cover, its species composition, and the degree of swampiness. In a forest with a surface cover of Sphagnum, a peat horizon forms more quickly than in a forest with true moss.

CLIMATIC AND TERRAIN FEATURES

Vegetation exerts both an indirect influence on permafrost by modifying climatic and other terrain features, which themselves influence permafrost, and a direct influence by its role in the heat transfer mechanism between ground and atmosphere. The influence of vegetation on various microclimatic features, drainage and the water regime, snow cover, and the influence of one type of vegetation on another, are important aspects. These features are so closely interrelated that it is difficult to assess their individual contributions without including some aspects of other features.

Microclimate

Vegetation decreases air current velocities within its strata and therefore impedes heat radiation from the soil to the air when the latter is cooler, as at night [15], and during periods of the year when soil temperatures are warmer than the air [13].

The density and height of trees influence wind velocities near the ground surface. Wind velocities are lower in areas of tall dense tree growth than where trees are stunted and scattered, or absent. Higher velocities, resulting possibly from fewer obstructions in areas of sparse tree growth cause more heat to move away from these areas per unit time than from the areas of dense growth. In the southern fringe of the permafrost region, permafrost is more commonly associated with areas of sparse or no tree growth for a number of reasons. Other factors being equal, the possibility of slightly lower air temperatures because of higher wind velocities in these areas may contribute to a ground temperature condition conducive to the existence of permafrost.

Air movement, such as the drainage of cold air at night from an elevated area downslope to a depression, is a microclimatic feature associated with relief, which may also be significant. Even microrelief features, such as peat plateaus, may produce sufficient differences in elevation to cause downslope air drainage at night.

Vegetation, especially tree growth, intercepts a significant portion of atmospheric precipitation, both rain and snow, by as much as 10 to 40% [2]. Any rain that reaches and penetrates the ground carries heat with it toward permafrost so that interception of rain results in a reduction of heat entering the ground. On the other hand, interception of snow by trees results in a lower accumulation on the ground and the possibility of deeper seasonal frost penetration. Increased shading caused by snow on tree branches reduces the amount of solar radiation received at the ground surface, but this is counteracted partly, at least, by the reduction of radiation from ground surface into atmosphere.

Drainage

Ground that permits the greatest degree of water penetration usually thaws to the greatest depth [13]. There is evidence that extensive root systems impede downward percolation of water and therefore restrict soil thawing [13]. On the other hand, roots, especially dead and decaying ones, may provide channels for water penetration and sometimes loci for the growth of granules and small stringers of ice [13].

Vegetation impedes surface runoff. In forests, particularly where vegetation is not disturbed, runoff amounts to less than 3% of the total rainfall, whereas in open areas and on the plains, it exceeds 60% [1]. The rate of runoff to precipitation is probably also significant to permafrost. Subsurface drainage is slow in peat because of its filtration properties.

Snow Cover

The low thermal conductivity of snow and its double role as inhibitor of frost penetration during winter and soil thawing in spring has been noted by many authors [13]. The retention of snow in the crowns of trees has already been mentioned. In spring, the snow cover remains on the ground longer in forested areas than in the open. Where strong winds prevail, more snow accumulates under a vegetation cover than in open areas. Snow protects the ground from freezing in winter but it also increases the moisture content of the soil in summer, thus contributing to lower summer ground temperatures [1].

In Labrador-Ungava a good correlation was noted by Ives [17] and Annersten [18] between the vegetation and snow accumulation and the distribution of permafrost. On exposed ridge summits, where vegetation was virtually absent, snow accumulation was kept to a minimum by the wind, and permafrost 200 ft thick existed. In sheltered gullies, vegetation was better developed, snow accumulated in the winter, and permafrost was only a few feet thick or absent.

Vegetation Properties

Within the framework of the complex interrelation existing

among various terrain features that affect the ground thermal regime, such as relief, drainage, soils, snow cover, and vegetation, special characteristics of some plant types may significantly influence permafrost and also indicate the existence of permafrost.

Tikhomirov [19] mentions several characteristics that influence the ground thermal regime of true mosses and Sphagnum: it possesses low thermal conductivity, high moisture holding capacity, and may shield roots of vascular plants from low air temperatures; it promotes uniform thawing and protects soil from runoff, solifluction, erosion, and thermokarst. Moss reduces the temperature amplitude of underlying soil. Tikhomirov postulates that heat from moss in late winter recrystallizes snow at the moss contact, that photosynthesis is possible under a thin snow cover, and that hollows form in the snow in which the air temperature is higher than the outside air temperature, producing favorable conditions for plant growth under the snow. Porsild states that solar radiation is the more likely source of heat [20]. He also questions photosynthetic activity beneath even a thin snow cover and the provision of favorable conditions for plant growth under the snow.

Robinson noted that in fall the melting of early snow fills the moss with moisture enabling it to conduct heat at a more rapid rate; this permits greater heat loss from the ground and deep penetration of seasonal frost [21]. In summer the top few inches dry to a point where they act as an effective insulating blanket. Therefore the presence of a deep layer of moss keeps the soil at a low temperature continuously and favors development of permafrost. Moss is very water absorbent. The lower portion of a moss layer is usually moist and this maintains the ground in a damp or wet condition.

Certain plant types provide rather reliable indicators of the existence of permafrost. At Thompson, Man., Canada, the presence of Sphagnum, and/or stands of spruce varying from small trees in open stands to moderately large trees in nearly closed stands, was found usually to be associated with permafrost, if the drainage was fairly good [22]. In northern Alberta, all but a few of the permafrost occurrences were found in low flat depressions [23].

In these areas two associations of vegetation predominated. One was grass-like sedge with little or no tree growth and thin moss cover. These areas were almost always wet and no permafrost existed. The other consisted of Sphagnum, lichen patches, and scattered stunted black spruce. Some of these areas were wet and contained no permafrost. The remainder were drier, and permafrost occurred at depths ranging from about 2 to 4 ft. At the edges of these areas, the permafrost dropped off abruptly.

Three varieties of vegetation are shown in Fig. 1, taken Sept. 20, 1962 (57°47'N, 117°50'W), 3.2 miles west of MacKenzie Highway, Alberta, Canada, in the southern fringe of the discontinuous zone of the permafrost region.



Fig. 1. Variety of vegetation associations with related variations in permafrost occurrence

The light-toned vegetation in the foreground and middle ground consists of sedge (*Carex* sp.) and grass with a thin discontinuous cover of feather and other non-*Sphagnum* mosses in standing water. No permafrost was encountered.

The dark toned island in foreground (man kneeling) is a slightly elevated peat plateau with ground cover of hummocky *Sphagnum* and Labrador tea. Depth of moss and peat is 4 ft 2 in.; black organic silt 4 ft 2 in. to 6 ft 0 in.; dense bluish silt clay 6 ft 0 in. to below 7 ft. Permafrost table extends from 2 ft 9 in. to 7 ft below ground surface. Permafrost occurs also in the dark almost treeless patch (same ground vegetation) at right, between sedge area in middle ground and forest in background. The forested area consists of spruce, poplar, jackpine, and birch; no permafrost was encountered here.

VEGETATION ZONES AS A PERMAFROST INDICATOR

In Canada, Alaska, and the USSR, the influence of vegetation varies from one geobotanical zone to another. In Canada and Alaska, permafrost occurs in tundra and taiga zones. In the USSR, it occurs in these two zones and also extends southward into the steppe. The variety of vegetation associations, the quantity of vegetable matter, stand height, and density, and rate of peat accumulation are all greatest in the taiga, gradually diminishing northward into the tundra and southward into the steppe. The degree and variety of the influence of the vegetation on the permafrost changes in a parallel manner [2].

In the northern part of the tundra the vegetation has little influence on permafrost because it is sparse and the vegetative period lasts less than two months. It causes local variations in depth of thaw and helps impede erosion. The destruction of the vegetation accelerates thawing only slightly.

In the southern part of the tundra, the vegetation becomes more abundant, peat mantles part of the surface and attains thicknesses of several feet in some basins. The main influence of the vegetation is on the depth of thaw. If vegetation is removed, the depth of thaw will increase; erosion will increase and thermokarst will develop if thawing proceeds at different rates over an area or if there are local differences in the ice content of the frozen ground.

In forest tundra, vegetation mass is greater than in the tundra, and the rate of accumulation of organic material is higher. Extensive peat bogs form and water basins are encroached by vegetation and permafrost forms. Woody and brush vegetation grow which accumulate snow leading to higher permafrost temperatures than in the tundra. If the vegetation is removed, the depth of thaw increases but this is counteracted to some extent by lower snow accumulation and a decrease in permafrost temperatures [1].

The maximum development of vegetation occurs in the taiga. Here vegetation has its greatest influence on permafrost even in very small localized areas causing variations in its extent, depth of thaw, and ground temperatures. Frequent forest fires cause variations in the occurrence and thickness of permafrost over short distances in the taiga.

Mass, density, height and influence of vegetation, and rate of accumulation of organic matter are less in the steppe than in the taiga, but depth to permafrost is greater.

ALTERATION OF PERMAFROST CONDITIONS

Changes take place in the permafrost as a result of the vegetation. The influences include the effect of vegetation on depth of thaw and depth to permafrost, the temperature regime in permafrost and the ground above, and extent and thickness of permafrost.

Depth of Thaw

The most easily observed and measured characteristic of permafrost is depth of thaw and variations in types of vegetation are often readily noticeable. Because this is so, more observations have been made on this aspect of the relation of vegetation to permafrost than any other. Despite the large number of observations reported in the literature, mechanisms opera-

tive in thawing of the active layer and permafrost and causes of variations from one type of vegetation to another are not clearly understood. One difficulty in comparing depth of thaw observations in various localities is caused by variations in climate, variations in other terrain factors closely associated with the vegetation, and by minute, but possibly significant, variations within a particular type of vegetation.

Removal of vegetation cover in a permafrost area causes an increase in the depth of thaw. At Inuvik, NWT, in the continuous permafrost zone, the maximum depth of thaw in an undisturbed moss-covered area was 2 ft in contrast to depths of 5 to 8 ft in areas stripped three years previously [24]. On land stripped for cultivation at Inuvik, the original maximum depth of thaw was about 2 ft prior to disturbance (1956). By 1959 the ground thawed to a depth of 70 in. [25].

The surface cover and peat appear to have much greater influence on depth of thaw than the underbrush and trees. At Inuvik, in undisturbed areas and in areas where the underbrush and trees had been removed three years previously but with the moss cover left intact, the depth of thaw was 2 ft—similar to the depth prior to any disturbance [24]. At Norman Wells, depth of thaw measurements were recorded by the Division of Building Research in different types of vegetation from 1957 to 1959. The greatest depth of thaw occurred in the grass-like sedge area with no moss cover reaching a depth of 5 ft 6 in. after about 3350 degree days of thawing. The next greatest depth of thaw was observed in a wooded area having a ground cover of 4 in. of moss overlying 3 in. of peat, reaching 4 ft 6 in. after 3350 degree days of thawing. The next greatest thaw, 3 ft 3 in., occurred in a treeless grass-like sedge and moss area with a 3-in. moss cover overlying 6 in. of peat. The shallowest depth of thaw, 2 ft, was observed in a sparsely treed area having 5 in. of moss overlying 18 in. of peat. Evidently, the depth of thaw decreased with an increase in the combined thickness of living moss and peat; the density and size of tree growth did not appear to make much difference.

Russian investigators found that of all the types of ground cover, *Sphagnum* appears to retard thawing most. In the Igarka region of the USSR, the depth of thaw in 1950 under this cover was 18 cm (7.1 in.) on 13 July, 22 cm (8.7 in.) on 3 August, and 26 cm (10.2 in.) on 2 September in contrast to 25, 31, and 35 cm (9.8, 12.2, 13.8 in.) on the same dates under true mosses consisting of *Hypnum* and other species [1, 2].

The relative influence of living ground cover and underlying peat has been investigated. It has been postulated that peat retards thawing even more than living mosses and lichens. In the arctic region of the Yenisey River in Siberia, removing the moss and lichen but leaving the peat layer resulted in an increase in the depth of thaw by 20 to 50%. After both living cover and peat were removed, depth of thaw increased by 1.5 to 2.5 times [1, 2].

Temperature Regime

Just as the vegetation exerts a marked influence on the depth of thaw and the depth to permafrost, it also modified ground temperatures both in permafrost and the ground above. An increase in depth of thaw leads to an increase in ground temperature and degradation of permafrost. A decrease in depth of thaw leads eventually to an aggradation of the permafrost.

At Norman Wells, ground temperatures were measured in the thawed layer by the Division of Building Research in 1959 and 1960 to assess the effect of different types of vegetation on underlying soil temperatures during the summer. In September 1959 the mean air temperature was 41.2°F and the mean ground temperature at the 1-ft depth for this period in various vegetation areas were: grass (no moss or peat) 40.0°F, sedge (no moss or peat) 36.5°F, grass-like sedge (3 in. true moss over 6 in. peat) 35.0°F, moss (5 in. *Sphagnum* over 18 in. peat) 32.5°F, lichen (2 in. lichen over 24 in. peat) 32.6°F.

There appeared to be a general decrease in temperature with increased combined moss and peat thickness. Temperatures were similar under moss and lichen although living moss was much thicker than lichen. The combined thickness of living cover and peat was, however, approximately equal. Ground

temperatures taken in 1960 in the thawed layer showed that they were highest under the grass area, lower under the sedge, and lowest under the moss and lichen. Temperature amplitudes also decreased in the same order. Thermal resistance and damping effect of moss and lichen were shown by the fact that monthly mean air temperatures were about 10°F higher in 1960 than in 1959, but the difference in mean ground temperature at the 1-ft depth was less than 1°F.

Ground temperature readings were also taken at Norman Wells down to the 20-ft depth in permafrost under the sedge, moss, and lichen. Even below the 10-ft depth, the mean temperature under the sedge for August and September 1960 was about 3°F higher than under the moss and lichen, which were about equal. Above this depth the difference was even greater. Similarly, the temperature amplitudes in the top 10 ft were twice as much under the sedge.

There is no doubt that vegetation modifies the temperatures of the seasonally thawed layer and permafrost. In all cases, ground temperatures in summer will rise when the vegetation cover is removed. On the other hand, the effects of winter air temperatures will penetrate to greater depths than in undisturbed areas. The net effect on mean annual temperature will depend on other factors, such as snow cover.

It is difficult to compare the effects of different types of vegetation on permafrost because different types frequently grow in close association or in a mosaic, and the individual effect of each may not be readily apparent.

Extent and Thickness

A change in depth of thaw and a change in temperature of the active layer and the permafrost produced by a change in vegetation establishes a change in temperature gradient. This results in either aggradation or degradation of the permafrost. In the southern fringe of the permafrost, the removal of the vegetation may result in disappearance of the permafrost. The establishment of a moss cover may lead, perhaps, to the formation and accumulation of permafrost.

CONCLUSION

This paper reviews various ways in which vegetation affects permafrost. Some mechanisms add heat to the ground, others facilitate heat loss from the ground. Some add heat at one time and contribute to heat loss another time. Influences of vegetation are almost all reversible depending on the conditions under which they occur. The complexity and multifaceted effects of vegetation on permafrost often lead to a situation where under one set of conditions a plant community decreases the soil temperature and increases it under other conditions.

It is very difficult to attach absolute quantities to each facet of the vegetation influence—total them, and arrive at the resultant direction and magnitude of heat flow at a particular time, much less perform this operation for all the past influences and assess their effect on the present permafrost situation. Even if each factor could be measured quantitatively, the contribution of some is so minute that the cumulative error would be unrealistic. In addition, there are factors which are probably not even known or possible to measure.

The best solution appears to be to measure obvious effects of vegetation, such as depth of thaw, temperatures, extent and thickness of permafrost which are manifestations of the net heat gains and heat losses to the ground, and relate these to variations in environmental components. The same permafrost conditions may occur in two adjacent areas, but the combination of vegetation and other factors producing two similar sets of permafrost conditions may be quite different.

ACKNOWLEDGMENTS

The author wishes to acknowledge the helpful comments of A. E. Porsild and W. K. W. Baldwin, National Herbarium, Department of Northern Affairs and National Resources, Ottawa; the late J. A. Pihlainen, Ottawa, and W. S. Benninghoff, Department of Botany, University of Michigan. This is a contri-

bution from the Division of Building Research, National Research Council, Canada, and is presented with permission of the director of the division.

REFERENCES

- [1] A. P. Tyrtikov. "The Effect of Vegetation on Perennially Frozen Soil," *Materialy K Osnovam Ucheniya O Merzlykh Zonakh Zemnoy Kory (Materials for the Basis of Study of the Frozen Zones of the Earth's Crust)*, Issue III, 1956, pp. 85–108.
- [2] A. P. Tyrtikov. "Permafrost and Vegetation," *Fundamentals of Geocryology*, Vol. 1, Chap. 12, Acad. Sci. USSR, Moscow, 1959, pp. 399–421, (Text in Russian).
- [3] E. R. Dahl. "Mountain Vegetation in South Norway and Its Relation to the Environment," *Skrift. utgitt av Vidensk.-Ak. Oslo, I, Mat. Natur. Kl., No. 3*, 1956.
- [4] R. Nordhagen. "Mountain Vegetation as a Record of Snow Cover Thickness and Duration," *Medd. fra Vegdirektoratet*, Nos. 1, 2, 4, 1952, pp. 1–31.
- [5] A. A. Grigor'ev. "Concerning Certain Geographical Relationships of Thermal and Water Exchange on the Surface of Dry Land and Means of Further Study of Materials and Energy in the Geographical Environment," *Izvest. Acad. Sci. USSR, Geog. Ser.*, No. 3, 1958, pp. 17–21, (Text in Russian).
- [6] M. I. Budyko. *The Heat Balance of the Earth's Surface*, U.S. Dept. of Commerce, Office of Climatology, 1958, (Transl. by N. A. Stepanova, from *Gidrometeorologicheskoe izdatel'stvo*, Leningrad, 1956).
- [7] K. A. Sychev. "Thermal Balance of the Active Layer of Permafrost in Summer," *Problemy Arktiki i Antarktiki*, No. 1, 1959, pp. 87–93, (Text in Russian).
- [8] N. A. Shpolyanskaya. "The Influence of the Heat Exchange Between the Soil and the Atmosphere on Permafrost in Transbaikalia," *Vestnik Moskovskogo Universiteta*, No. 2, 1962, pp. 37–42, (Text in Russian).
- [9] I. C. Jackson. "Insolation and Albedo in Quebec-Labrador," *McGill Subarctic Res. Papers*, No. 5, Jan. 1959.
- [10] J. R. Mather, C. W. Thornthwaite. "Microclimatic Investigations at Point Barrow, Alaska, 1956," *Climatology*, Drexel Inst. Tech., Lab. of Climatology, Centerton, N.J., Vol. 9, No. 1, 1956.
- [11] J. R. Mather, C. W. Thornthwaite. "Microclimatic Investigations at Point Barrow, Alaska, 1957–1958," *ibid.*, No. 2.
- [12] R. F. Legget, H. B. Dickens, R. J. E. Brown. "Permafrost Investigations in Canada," *Proc. 1st Intl. Symp. Arctic Geology*, Vol. 2, *Geology of the Arctic*, Univ. Toronto Press, 1961, pp. 956–969.
- [13] W. S. Benninghoff. "Interaction of Vegetation and Soil Frost Phenomena," *Arctic*, Vol. 5, No. 1, March 1952.
- [14] E. M. Fraser. "The Lichen Woodlands of the Knob Lake Area of Quebec-Labrador," *McGill Subarctic Res. Papers*, No. 1, Dec. 1956.
- [15] M. I. Sumbin, S. P. Kachurin, N. I. Tolstikhin, V. F. Tumel'. "General Permafrost Studies," *Acad. Sci. USSR, Moscow*, 1940, pp. 160–165 (Text in Russian).
- [16] R. J. E. Brown. "Potential Evapotranspiration and Evaporation Observations at Norman Wells, NWT." *Proc. Hydrology Symp. No. 2 - Evaporation*, Natl. Res. Coun., March 1961, pp. 123–127.
- [17] J. D. Ives. "A Pilot Project for Permafrost Investigations in Central Labrador-Ungava," *Dept. Mines and Tech. Surv., Geog. Paper No. 28*, Ottawa, Canada, 1961.
- [18] L. Annersten. "Ground Temperature Measurements in the Schefferville Area," *P. Q. Proc., 1st Canadian Conf. Permafrost*, Natl. Res. Coun., Assn. Comm. Soil and Snow Mech., Tech. Memo. No. 76, Jan. 1963, pp. 215–217.
- [19] B. A. Tikhomirov. "The Importance of Moss Cover in the Vegetation of the Far North," *Botanicheskiy Zhur.*, Sept. 1952, pp. 629–638 (Text in Russian).
- [20] A. E. Porsild. *Natl. Herbarium*, Ottawa, Canada, priv. comm., 1963.
- [21] J. M. Robinson. *Dept. of Forestry*, Canada, priv. comm., 1959.
- [22] G. H. Johnston, R. J. E. Brown, D. N. Pickersgill. "Permafrost Investigations at Thompson, Manitoba, Terrain

Studies," Natl. Res. Coun., Tech. Paper No. 158, Oct. 1963 (NRC 7568).

[23] R. J. E. Brown. "Permafrost Investigations on the Mackenzie Highway in Alberta and Mackenzie District," Natl. Res. Coun., Tech. Paper No. 175, June 1964 (NRC 7885).

[24] J. A. Pihlainen. "Inuvik, NWT, Engineering Site Information," Natl. Res. Coun., Tech. Paper No. 135, Aug. 1962 (NRC 6757).

[25] F. S. Nowosad, A. Leahey. "Soils of the Arctic and Subarctic Regions of Canada," Agr. Inst. Rev., March 1960, pp. 48-50.

PLANT ECOLOGY IN PERMAFROST AREAS

ALBERT W. JOHNSON, University of California, Los Angeles

Botanists whose field activities have taken them to the arctic and alpine portions of the world have stressed the importance of perennial and seasonal frost phenomena in modifying vegetation patterns. Biological studies related to presence of soil ice are thus far largely confined to descriptions of surficial patterns; little experimental work has been accomplished. Washburn's [1] review of the many hypotheses proposed for patterned ground genesis illustrates the difficulty in explaining patterns and processes; these problems are compounded for the botanist who must rationalize his interpretations of vegetation patterns with physical systems.

The relevant botanical literature in this field has been reviewed [2 to 5]. Many workers [6 to 13] have contributed significantly to the accelerated interest in these phenomena since World War II. Most of this geobotanical work is concerned with the influence of frost action on modifying plant distribution to which permafrost has been assigned a contributing, if passive, role. Although permafrost is not a limiting requirement for the formation of patterned ground [14], patterned ground features are generally more widespread in permafrost areas.

Permafrost is not a part of the plant environment (Mason and Langenheim [15]), because plants apparently do not grow in it. Permafrost modifies the operational environment of the plant. This paper discusses how permafrost modifies environments and determines vegetation patterns in the Ogotoruk Creek Valley of northwestern Alaska. Frost action is considered only peripherally.

VEGETATION AND PERMAFROST

The following interrelationships are suggested between permafrost and vegetation:

1. Permafrost impedes drainage of water derived from precipitation and runoff.
2. Permafrost maintains low temperatures in the root zone during the growing season.
3. The aggregation of masses of soil ice leads to surficial irregularities, while melting of this ice produces thermokarst topography and other features including pond and lake formation.
4. Permafrost provides an impervious substrate similar to bedrock upon which seasonal freezing-thawing processes, including solifluction, occur more intensely than in deep, well-drained soils.
5. Plant roots are restricted to the active layer.
6. Vegetation cover damps temperature extremes in the soil and helps maintain high permafrost levels; it slows penetration of heat and cold into the soil in spring and fall.
7. Vegetation retards frost action as well as the kind of erosion associated with the melting of soil ice.

Many papers imply that the presence of permafrost in a region has more influence than regional climate in determining the vegetation patterns of the landscape. For example, Benninghoff [2] says "...thawing throughout the summer in the upland soils of dry interior Alaska is believed to provide water for the relatively luxuriant forests."

Both permafrost and vegetation respond to regional climate; modification of climate to the extent of removing the permafrost would radically change the characteristics of the vegetation,

not only because of changes in the soil moisture regime, but for other equally important reasons.

OGOTORUK CREEK VALLEY

The Ogotoruk Creek Valley (68° 05'N, 165° 45'W) in northwestern Alaska is an area of approximately 40 sq miles, and it lies well within the limits of the continuous permafrost zone as defined by Sumgin [16] and applied locally by others [17, 18]. The physical and biological characteristics of the valley are well known because of a concentration of bio-environmental studies in the area during the Project Chariot program, two summaries of which have appeared to date [19, 20].

The Ogotoruk Creek Valley is contained by two major ridge systems and is about 2.5 miles broad where the Creek debouches into the Chukchi Sea; it widens to about 5 miles at the headwaters of the Creek. Local relief varies from sea level to slightly more than 1000 ft in a few isolated summits. All bedrock in the area is of consolidated marine sediments, ranging in age from Early Mississippian to Cretaceous [21] and consisting of limestone, dolomite, chert, sandstone, and mudstone. Unconsolidated Pleistocene deposits some 10 to 50 ft thick overlie the bedrock in more than 50% of the area. They include colluvium, terrace gravel, floodplain alluvium, ancient beach deposits, peat, and aeolian sand and silt. Limestone and dolomite deposits are limited to the west side of the valley, while the acidic sandstones and mudstones are found at low elevations on the west side of the valley and comprise all the rocks on the eastern side.

Permafrost is continuous in all rock and sediment deposits to depths of more than 1000 ft at points more than 1000 ft inland but thinning to about 950 ft deep near the shore of the Chukchi Sea [21]. The upper limit of permafrost is variable according to surficial conditions of soil texture, exposure, drainage, and vegetation cover. Seasonal heat input and soil moisture determine year-to-year fluctuations in the depth of the active layer. Measurements on steep slopes (with scanty or no vegetation) suggest that permafrost lies within 2 m of the surface; measurements of fine grained soils suggest that on gentler slopes and flats (with almost complete vegetation) the upper limit of permafrost lies within 1 m of the surface. It is probable that the active layer has thickened somewhat during the last century because calculations by Lachenbruch et al. [22] suggest that the mean annual ground surface temperature has risen on the order of 2°C in that period. Under open standing and running water, the active layer is somewhat thicker.

Soils

Soil groups of the Ogotoruk Creek Valley that have been classified [23] fit the framework provided for the Alaskan arctic soils by Tedrow and his group. Tedrow and Harries [24] note no significant pedological boundary between the subarctic forest and the tundra; podsolization processes characteristic of the subarctic forest become progressively weaker toward the north with changing environmental conditions; moistening effects from shallower thawing (due to low temperatures, low evapotranspiration, deranged drainage patterns, and permafrost features) cause the most important changes. They point out further that podsolization has little or no relation to formation of the widespread tundra group which is produced under impeded drainage,

while areas of good drainage become more and more restricted. On the latter, the arctic brown soil, [25] which is the arctic counterpart of the subarctic podsol soil, is found.

Arctic pedogenesis is related to a drainage catena and vegetation is related to it [26]. Briefly, arctic brown soils support upland vegetation types, while the wet tundra and bog soils support wet meadow and typical bog vegetation; in dry areas one finds barren types characteristic of the High Arctic. Corresponding soils and vegetation relationships are outlined for the Ogotoruk Creek Valley in Fig. 1.

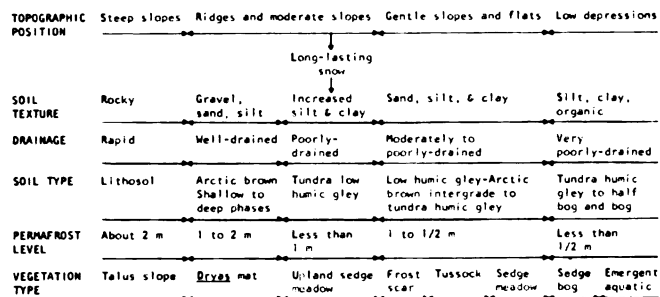

Fig. 1. Vegetation in relation to edaphic gradients in the Ogotoruk Creek Valley, Alaska

Climate

The climate of Ogotoruk Creek Valley was studied for three years, and the data are at least indicative of regional climatic conditions. Air temperatures remain consistently above freezing during only June, July, and August, although there are many warm days in May and September (Fig. 2A). The spring and fall transitions are rapid. During April and May in the spring and September and October in the fall, daily temperature fluctuations cross the freezing-thawing boundary frequently. Soil temperatures follow the same patterns, but the extremes are damped; deeper soil layers, especially below 10 to 15 cm, respond much more slowly and show much less variation than the upper layers (Fig. 2B). Even with the total summer's heat accumulation, soil temperatures below 30 cm are only a few degrees above freezing.

Precipitation was measured at about 8 in. annually, with most occurring as summer rains. This is significant because it means that the soil is relatively saturated at the time the soil freezes. In fact, a sudden freeze following a heavy rain in the fall of 1960 resulted in the tundra surface being almost completely coated with ice [27]. The possible inaccuracy of these precipitation measurements will be discussed below.

Wind velocities are high in both duration and intensity. Winds above 70 km/hour are not uncommon especially during the winter, and mean velocities in this period are likely to be above 20 km/hour. The intense winds at Ogotoruk Creek have been attributed to "the strong pressure gradient which normally exists between the high pressure areas over the Polar Icepack and the strong low pressure cyclones in the Bering Sea, and to the fact that the Ogotoruk Valley is the first and lowest outlet or channel around the DeLong Mountains between these areas of high and low pressure" [20].

Because of the small amount of winter precipitation and high wind velocities, most tundra surface has a shallow snow cover except in depressions where many feet of snow may accumulate. Because prevailing wind direction is offshore during winter, snow, plant parts, and soil are blown onto the sea ice; as a result the Valley is brown in winter (except during or immediately after a snowstorm), and the sea ice is discolored for some distance offshore. Large drifts of snow, which are abundant in the lee of ridges or in stream beds, persist well into the summer.

Vegetation

Johnson et al. [28] studied flora, vegetation, and plant ecology of the Ogotoruk Creek Valley. They report a rich vascular

flora of about 300 species. Vegetation is primarily low arctic in composition. Eight major vegetation types are described from the Ogotoruk watershed based on species composition and correlation with physiographic features of the landscape. The most frequent vegetation types and their relationship to topography, soil type, and permafrost are summarized in Fig. 1.

Dryas mat types—On most of the upland ridges and slopes and on the lower ridges and weathered bedrock outcrops within the valley, the vegetation is dominated by mats of Dryas octopetala, the cover of which varies greatly from place to place according to wind exposure and the extent of winter snow cover; frost action and solifluction locally modify the surface expression of the type. On steeper slopes the Dryas mats are distorted into step- and stripe-like patterns. Scattered among the Dryas plants are several other mat-forming species such as Oxytropis nigrescens, Silene acaulis, Salix phlebophylla, and Arenaria arctica. Low matted shrubs of Vaccinium uliginosum, V. vitis-idaea, Arctostaphylos alpina, Cassiope tetragona, and Empetrum nigrum are found in small depressions where snow accumulates. Carex microchaeta, Hierochloa alpina, Pedicularis lanata, and Luzula confusa are typical of another group of less common plants. About 30% of the valley is covered by Dryas-dominated vegetation.

Sedge-meadow type—Two species, Eriophorum angustifolium and Carex aquatilis, often form a nearly continuous cover on poorly drained sites bordering lakes and streams and on gentle slopes. Sphagnum spp. and other mosses are abundant. Where solifluction and frost action have created small ridges and hollows, a number of herbaceous species and shrubs occur on the higher drier sites, the more common being Luzula confusa, Cardamine microphylla, Valeriana capitata, Salix pulchra, Salix arctica, and Betula nana. Ice-wedge polygons and frost

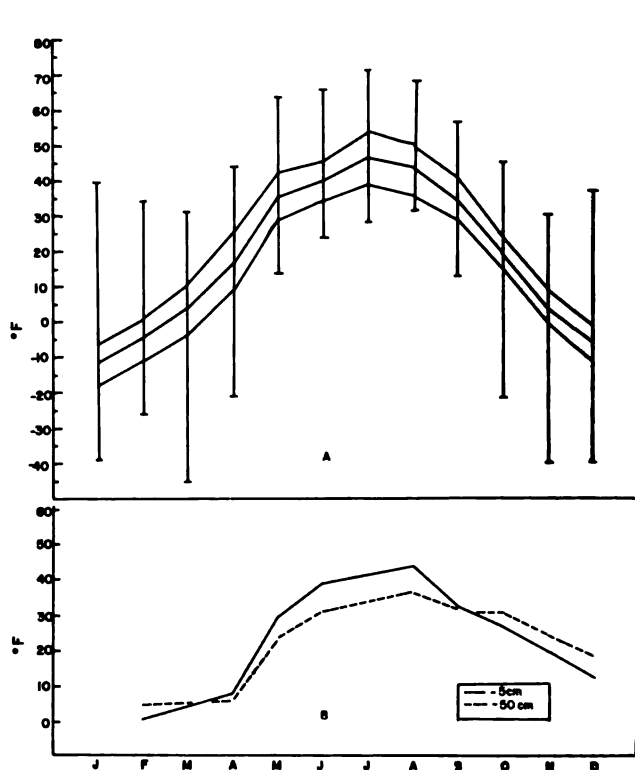

Fig. 2. Ogotoruk Creek Valley, (after AEC, 1962)

A. Average maximum, minimum, and mean air temperature at 120 cm height for 1959-1961. Vertical bar on each month shows absolute maximum and minimum

B. Mean soil temperatures at 12 to 14 stations, 1960-1961

scars are found in this type. The sedge-meadow type covers about 12% of the valley.

Sedge-tussock type—Tussocks of *Eriophorum vaginatum* occupy extensive areas on the gentle slopes between Ogotoruk Creek and the adjacent ridges. The tussock type usually occupies sites that are slightly better drained than the sedge meadows. Ericaceous shrubs such as *Vaccinium vitis-idaea* and *Ledum decumbens* and the willow, *Salix pulchra*, are often found growing out of the tussocks. Other herbaceous plants are scarce except where associated with microtopographical discontinuities. Moss cover is high between tussocks, while fruticose lichens are common on the tussocks. Ice-wedge polygons and frost scars are common. Nearly 40% of the valley area supports the tussock type.

Other types—Several other vegetation types of minor extent occur in the Ogotoruk Creek Valley. Where drainage is improved on fine grained soils along the edge of the valley floor or on interfluvial summits on the valley floor, *Carex bigelowii* dominates the vegetation. Where long lasting snow-beds occupy moderate slopes, upland extensions of sedge-meadow vegetation are found. Where snow accumulates and remains until late spring or midsummer, a number of heterogeneous snow-bed communities occur. Along the coast in the vicinity of lagoons and where stream terraces are sometimes flooded, brackish marshes in which *Eriophorum angustifolium*, *Deschampsia caespitosa*, *Arctophila fulva* and *Puccinellia* spp. comprise the greatest cover. Riparian willow communities are found along the major drainages. Talus slopes, strands, and tundra ponds support a thin but characteristic flora.

PERMAFROST EFFECTS ON PLANT ECOLOGY OF THE VALLEY

Permafrost and Soil Moisture

The western North American Arctic is characterized by low precipitation which for many arctic areas is said to average less than 10 in. annually. Some botanists and geographers have suggested that precipitation alone is insufficient to support the vegetation found on these arctic landscapes. Reason suggests that this can hardly be the case. Recent studies [29] suggest that sampling errors are of sufficient magnitude to underestimate precipitation by one-half or more; also, it has been demonstrated that evapotranspiration is less than precipitation in many parts of the arctic [31]. Nevertheless, permafrost contributes significantly to the maintenance of high soil moisture by confining all melt and rain water to the upper few decimeters in the soil. Melting of seasonal frost also provides water for plant growth. Permafrost cannot provide water unless there is a progressive degradation of the permafrost table over a period of several years, as is sometimes the case when soils are stripped of their natural vegetative cover by fire or agriculture [32]. In any event, permafrost may be discounted as a source of soil moisture in tundra areas.

The sedge-meadow and sedge-tussock vegetation types in the Ogotoruk Valley owe their existence, at least in large part, to permafrost. On the corresponding soil types, the tundra humic gley and the tundra low humic gley, internal drainage would improve if permafrost were absent; the soils would become at least weakly zonal, and *Carex bigelowii* and its associates would probably occupy these sites. At present these tundra soils are always wet under vegetation. Where plant cover is absent locally, as on frost scar surfaces, soils may dry out during even brief rainless periods during summer in the upper 5 to 10 cm, but below those depths they are always saturated, and a hole dug to permafrost will fill with water within minutes. Probably no other vegetation type in the Ogotoruk Valley would undergo such a qualitative change should permafrost retreat to deeper levels or disappear.

Permafrost and Frost Action

Quantitatively, the bulk of frost action processes influencing plants in the Ogotoruk Creek Valley are those which produce and maintain nonsorted circles, which because of surficial

disturbances are untenable for plant growth. In all tussock areas, for example, an average of about 17% of the total ground surface is covered by nonsorted circles. The immediate causes of vegetation disruption in these features are due to seasonal frost action rather than permafrost per se. Everett [33] has discussed annual formation of needle ice in fine grained, bare soil surfaces in the Ogotoruk Valley. These needles, which are sometimes up to 10 to 15 cm in length, lift and churn the soil surface as they form. Needle ice forms both in spring and in fall, but because of the tendency of the soils to be rather wet in fall, its development is most pronounced then.

The growth of a second kind of ice, sirlain ice or lens ice, displaces soils because of the aggregation of water by suction processes and produces the characteristic frost heaving of nonsorted circles in the Ogotoruk Valley. The spaces occupied by ice lenses during winter do not close when the ice melts; these retain the convexity which was originally produced by the ice segregation. Large masses of ice which accumulate during formation and growth of ice-wedges also displace considerable volumes of soil and produce vegetation patterns. Concrete ice, the third type of ice described by Everett, includes all nonpatterned ice types, is most often found in the soil under vegetated areas, and consists most simply of frozen pore water.

Frost action is most intense in areas where soils are frost susceptible and where soil moisture is high during spring and fall. Even on soils which are only marginally frost sensitive, as in *Dryas* uplands, frost action occurs most markedly in the vicinity of melting snow-beds where a more or less constant moisture source is assured. By maintaining high moisture levels in the active layer, permafrost encourages seasonal formation of needle and sirlain ice. Also, because permafrost is like bedrock in resisting deformation from above, all active layer displacement due to ice-lens formation shows up as surficial heaving. In summary, permafrost is not essential for frost action, but it may, indirectly, influence its magnitude in the ways suggested above.

Permafrost and Solifluction

In addition to its influence on quantitative modifications of frost action, permafrost otherwise advances habitat instability and vegetation disruption in the Ogotoruk Valley by (1) providing a slippery, impermeable surface over which soil may slide slowly or catastrophically; (2) increasing erosion; (3) promoting the formation of thaw lakes and ponds through mass melting.

Johnson [34] describes a mudflow from the Ogotoruk Valley which owes its maintenance, at least in part, to the presence of permafrost. In this case, the mudflow occurs in a semi-circular concavity averaging about 1 m in depth and extending downslope for about 50 m and across the slope for about 30 m. The sea of mud below the scarp of the flow is a bluish-grey, highly viscous, silty clay; floating on it is vegetation which has been detached from the surface as the scarp migrates upslope. The flow occurs on a very gentle slope of only 2°. Apparently this flow did not spew downslope in one mass but is being enlarged by annual augmentations from the scarp face. This is suggested because parts of the flow farthest downslope are completely covered by vegetation, while those parts of the flow directly below the scarp are almost bare; also, downslope parts of the flow have been folded, presumably by pressure from above the later flows.

Permafrost functions here by providing a steep slippery surface. Above and below the retreating scarp, permafrost is more or less parallel with the slope; at the scarp surface, however, it is oriented at about 37° with the horizontal because of melting at the face of the dark scarp. Yearly increments of heat are sufficient to melt only a few decimeters upslope from the scarp; the soil, when saturated, most likely in late summer, slides on this steep surface, and the vegetation is torn loose and slides with it. Contributing to the periodic nature of this flow is the fact that the vegetation here is arranged in linear rows of tussocks due to frost action. This system shows uniquely the combined influence of frost action, permafrost, and vegetation in promoting soil instability.

Ice-wedge polygons occurring on sloping ground are of the raised center type in the Ogotoruk Valley, because the active layer over the ice-wedges reaches to the top of the wedge and lowers its surface. Wiggins [35] and Britton [10] describe the relationship of vegetation to ice-wedge polygons in the Barrow area. A lowered ice-wedge results in a trough separating the high centers and constitutes a natural drainage for melt and rain water. Where stream backcutting enters a polygon field, erosion accelerates melting and accentuates local relief. The resultant lowering of the permafrost table within the polygons causes a change in the vegetation type from tussocks to vegetation dominated by *Carex bigelowii*. In extreme cases, erosion deepens the trough many feet, leaving the polygons standing as isolated columns. Mass caving of these remnants then results in elimination of all vegetation and the washing away of the silty soil. This sequence of events is fairly common in the Ogotoruk Valley.

Ice-wedge melting always quantitatively changes the vegetation type, no matter what initiates the melting. Weasel travel, for example, has broken the surface vegetation overlying ice-wedges in many parts of the Ogotoruk Valley, has produced scars several decimeters to several meters deep, and the vegetation has been changed or eliminated completely.

The role of permafrost in promoting solifluction on slopes is not clearly understood. Early workers such as Frodin [36], Sørensen [37], and later Hanson [38] believed that permafrost encourages downslope movement of soils. Solifluction terraces in Alaska show little evidence of movement after they attain a height sufficient to allow a rise of permafrost within the terrace itself [39]. Solifluction terraces were shown to form in areas free of permafrost, and downslope soil movement was attributed to frost heaving and reduction of shear strength in soils [40]. On the basis of these and our own observations, it seems likely that terrace formation is benefited by permafrost, but that as growth occurs, permafrost probably slows movement of the terrace by becoming incorporated into it. Terrace growth then occurs by increment of materials washed onto the surface. In the Ogotoruk Valley, solifluction terraces occur only in areas where long lasting snow-beds lie on moderate slopes.

Britton [10] has carefully documented the thaw-lake cycle on the arctic coastal plain of Alaska. Here lakes and ponds expand their margins by thawing into the frozen ground with subsequent erosion and submergence of the shore soil and vegetation. Hopkins [41] has described similar processes from the Seward Peninsula. In the Ogotoruk Valley pond expansion occurs at the expense of sedge-meadow or sedge-bog vegetation, but apparently the kinds of cyclic events described by Britton do not occur—probably for want of suitable topography.

Everett [33] describes a minor landslide on a moderate southeast facing slope in the Ogotoruk Valley and speculates from surficial evidence that repeated sliding occurs on this and other areas similar to it at times in spring when the gravel and turf are supersaturated with snow-melt water. At such times sliding occurs on a frozen base of medium to fine gravel. The vegetation here is an upland sedge meadow. Scars of this kind probably require many years to eradicate.

In summary, slope movement of materials may in special cases be intensified by the presence of permafrost, especially when soils are saturated with rain or melt water or both at a time when the permafrost layer is at a depth favorable for sliding. Probably, most of the great mass-wasting process on slopes that gradually levels all ridges has more to do with intense frost-riving in these climates (coupled with the effects of gravity) than with permafrost.

Permafrost and Soil Temperature

Only the upper 5 to 10 cm of soil in the Ogotoruk Valley are subject to short term fluctuations in the air temperature. Below those levels soil maxima and minima are rarely more than 2 or 3° apart for any of the months of the growing season. Moreover, temperatures below 20 cm in depth are usually less than 40°F during every month of the year. These low temperatures may be attributed partly to permafrost, partly to low soil

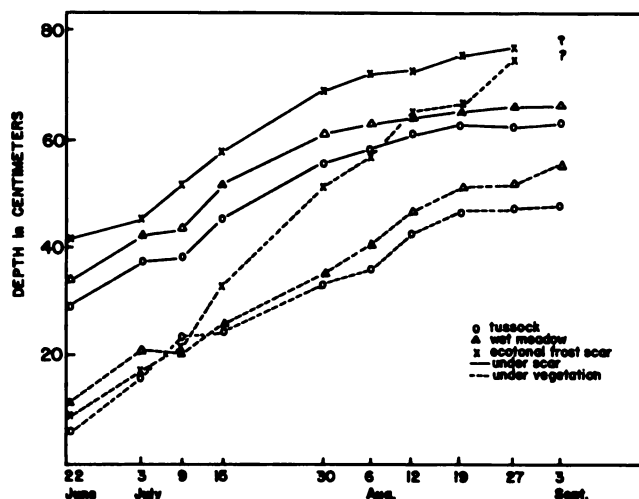

Fig. 3. Seasonal change to depth on frozen ground under three vegetation types, Ogotoruk Creek Valley, Alaska, 1961

porosity and high moisture content, and partly to the insulating vegetation cover. Neiland et al. [42] measured the retreat of permafrost in soils of three vegetation types during the summer of 1960 in the Ogotoruk Valley, and compared bare and vegetated areas within each type (Fig. 3). They found that under wet meadow and tussock vegetation, frost levels were nearly the same; rate and depth of retreat during summer compared favorably in the two types. In a third type which is ecotonal between tussocks and upland situations, and consequently composed of coarser soils, the frost line retreated deeper into the soil by the end of the growing season, and the frost line under the vegetation caught up with the nonvegetated areas by that time, presumably because of better internal drainage and less effective insulation by the vegetation. The absolute measurements compare favorably with work in similar vegetation by others [13, 43, 44, 45] who were working in the Alaskan Arctic. Where permafrost lies deeper in the soil, temperatures are higher at comparable depths—not only because of the greater distance to permafrost, but also because of that complex of soil characteristics which encourages the more rapid penetration of heat from above.

Permafrost and Plant Distribution

More than one-half of the land area within the Ogotoruk Valley is covered by tundra soils where permafrost lies within 1 m of the surface. Only about one-fifth of the 300 vascular plant species in the Valley are found in these cold, wet habitats, the other species occurring on sites where permafrost has little or no influence in species ecology. There are two parts to this problem. One involves the physiological mechanisms which enable plants to inhabit these permafrost habitats, and the other is concerned with the long-range evolutionary history of the arctic flora as a whole.

A recent paper by Bliss [46] reviews the physiological mechanisms which are important in arctic plant ecology. Quoting Dadykin [47], he notes that some species accumulate starch, carry on cell division, and absorb water at temperatures at or very close to 0°C. Species successful in permafrost habitats are also characterized by a variety of asexual reproductive mechanisms including vegetative reproduction and apomictic mechanisms. This is important because we have noted that plants of permafrost habitats are often well behind other species in their flowering periods, and in some unfavorable seasons, may fail to flower at all. Considerably more information on adaptations of plants to cold, wet soils is needed before generalizations can be made.

According to other writers [48], species occupying the Eurasian arctic are composed of diploids that sent ancient arctic-alpine species and polyploids that spread out over the

Arctic during the postglacial period.

Our analyses of polyploid levels in the Ogotoruk Creek flora show that in general the diploids are not associated with permafrost habitats, but that species growing in those habitats are likely to be high polyploids. These species probably originated from ancient diploid species, and they owe their success to their ability to take advantage of rapidly expanding permafrost habitats during the entire Pleistocene Epoch.

ACKNOWLEDGMENTS

Many other scientists and field assistants contributed to the Project Chariot botanical program. I should like to thank Leslie A. Viereck, Bonita Neiland, Ross Johnson, and Herbert Melchior. I am also grateful to K. R. Everett of the Institute of Polar Studies, Ohio State University, for the opportunity to examine his manuscript on slope movement studies.

REFERENCES

- [1] A. L. Washburn. "Classification of Patterned Ground and Review of Suggested Origins," Geol. Soc. Am. Bull., Vol. 67, 1956, pp. 823-866.
- [2] W. S. Benninghoff. "Interaction of Vegetation and Soil Frost Phenomena," Arctic, Vol. 5, 1952, pp. 34-44.
- [3] D. M. Hopkins, R. S. Sigafos. "Frost Action and Vegetation Patterns on Seward Peninsula, Alaska," Geol. Surv. Bull. 947-C, 1950, pp. 50-100.
- [4] W. H. Drury, Jr. "Bog Flats and Physiographic Processes in the Upper Kuskokwim River Region, Alaska," Contr. No. 178, Gray Herbarium Harvard Univ., 1956.
- [5] W. H. Drury, Jr. "Patterned Ground and Vegetation on Southern Bylot Island, NWT, Canada," Contr. No. 190, Gray Herbarium Harvard Univ., 1962.
- [6] H. M. Raup. "Vegetation and Cryoplanation," Ohio J. Sci., Vol. 51, 1951, pp. 105-116.
- [7] H. M. Raup. "The Vegetation of Southwestern Mackenzie," Sargentia VI, 1947, pp. 1-262.
- [8] R. S. Sigafos. "Soil Instability in Tundra Vegetation," Ohio J. Sci., Vol. 51, 1951, pp. 281-298.
- [9] R. S. Sigafos. "Frost Action as a Primary Physical Factor in Tundra Communities," Ecology, Vol. 33, 1952, pp. 480-487.
- [10] M. E. Britton. "Vegetation of the Arctic Tundra," Arctic Biol., 18th Biol. Colloq., Oregon State College, 1957, pp. 12-25.
- [11] W. D. Billings, H. A. Mooney. "An Apparent Frost Hummock-Sorted Polygon Cycle in the Alpine Tundra of Wyoming," Ecology, Vol. 40, 1959, pp. 16-20.
- [12] P. L. Johnson, W. D. Billings. "The Alpine Vegetation of the Beartooth Plateau in Relation to Cryopedogenic Processes and Patterns," Ecological Monog., Vol. 32, 1962, pp. 105-135.
- [13] H. C. Hanson. "Characteristics of Some Grassland, Marsh, and Other Plant Communities in Western Alaska," ibid., Vol. 21, 1951, pp. 317-378.
- [14] C. Troll. "Strukturboden, Soliflukton und Frost Klimate der Erde," Geol. Rundschau, Vol. 34, 1944, pp. 545-694. Transl. 43 by H. E. Wright, Jr., U.S. Army SIPRE, 1958.
- [15] H. L. Mason, J. Langenheim. "Language Analysis and the Concept Environment," Ecology, Vol. 38, 1957, pp. 325-340.
- [16] M. I. Sumgin. Perennially Frozen Ground in the Limits of USSR, Far Eastern Geophys. Obs., Vladivostok, 1927, (Text in Russian).
- [17] T. L. Péwé. "Permafrost and its Effect on Life in the North," Arctic Biol., 18th Biol. Colloq., Oregon State College, 1957, pp. 12-25.
- [18] C. J. Heusser. "Pleistocene and Postglacial Vegetation of Alaska and the Yukon Territory," ibid., pp. 62-72.
- [19] Committee on Environmental Studies for Project Chariot. "Bioenvironmental Features of the Ogotoruk Creek Area, Cape Thompson, Alaska," At. Energy Comm., Office Tech. Inf., TID-12439, 1960.
- [20] Committee on Environmental Studies for Project Chariot. "Bioenvironmental Features of the Ogotoruk Creek Area, Cape Thompson, Alaska," 2nd summary, ibid., TID-17226, 1962.
- [21] R. Kachadoorian. "Engineering Geology of the Chariot Test Site on Ogotoruk Creek near Cape Thompson, Northwestern Alaska," Geol. Invest. Support Project Chariot, etc., U.S. Geol. Surv. Trace Elements Invest. Rept. 779, 1961.
- [22] A. H. Lachenbruch, G. W. Greene, B. Vaughn Marshall. "Interim Report on Geothermal Studies, Ogotoruk Valley, Northwest Alaska," ibid.
- [23] N. Holowaychuk, J. H. Petro, H. R. Finney, K. R. Everett. "Prelim. Rept. Soil Classification Mapping and Analyses and Soil Movement Studies," Project Chariot Environmental Program, Ohio State Univ., 1961.
- [24] J. C. F. Tedrow, H. Harries. "Tundra Soil in Relation to Vegetation, Permafrost, and Glaciation," Oikos, Vol. 11, 1960, pp. 237-249.
- [25] J. C. F. Tedrow, D. E. Hill. "Arctic Brown Soil," Soil Sci., Vol. 80, 1955, pp. 265-275.
- [26] J. C. F. Tedrow, J. Cantlon. "Concepts of Soil Formation and Classification in Arctic Regions," Arctic, Vol. 11, 1959, pp. 166-179.
- [27] L. A. Viereck, R. E. Johnson, H. Melchior. "Ogotoruk Creek Botanical Investigations, Cape Thompson, Alaska," Project Chariot-Phase III Prog. Rept., 1960, Univ. Alaska.
- [28] A. W. Johnson, L. A. Viereck, R. Johnson, H. Melchior. "The Vegetation and Flora of the Ogotoruk Creek-Cape Thompson Area, Alaska," in press, 1964.
- [29] R. F. Black. "Precipitation at Barrow, Alaska, Greater Than Recorded," Am. Geophys. Union Trans., Vol. 35, 1954, pp. 203-206.
- [30] E. E. C. Clebsch. "The Summer Season Climate and Vegetational Gradient Between Point Barrow and Meade River, Alaska," M.S. thesis, Univ. Tenn., 1957.
- [31] J. R. Mather, C. W. Thornthwaite. "Microclimatic Investigation at Point Barrow, Alaska, 1956," Drexel Inst. Tech. Publ. Climat. 9, 1956, pp. 1-51.
- [32] A. H. Mick. "Arctic and Subarctic Agriculture," Arctic Biol., 18th Biol. Colloq., Oregon State College, 1957, pp. 100-109.
- [33] K. R. Everett. "Slope Movement and Related Studies," Unpubl. Manuscript, Inst. Polar Studies, Ohio State Univ., 1962.
- [34] A. W. Johnson. "Preliminary Studies on the Influence of Frost Action and Related Phenomena on the Vegetation of the Ogotoruk Creek Valley," Prog. Rept., Univ. Alaska, 1960, pp. 1-60.
- [35] I. L. Wiggins. "The Distribution of Vascular Plants on Polygonal Ground near Point Barrow, Alaska," Contr. Dudley Herbarium, Vol. 4, 1951, pp. 41-52.
- [36] J. Frödin. "Über das Verhältnis Zwischen Vegetation und Erdflüssen in den Regionen des Schwedischen Lappland," Lunds Univ. Årsskr., N. F. Afd. 2, Ed. 14, 2. No. 24, 1918, pp. 3-31.
- [37] Th. Sørensen. "Bodenformen und Pflanzendecke in Nordostgrönland," Meddelelsen om grönland, Vol. 93, 1935, pp. 1-69.
- [38] H. C. Hanson. "Vegetation and Soil Profiles in Some Solifluction Mound Areas in Alaska," Ecology, Vol. 31, 1950, pp. 606-630.
- [39] S. Taber. "Perennially Frozen Ground in Alaska: Its Origin and Extent," Bull. Geol. Soc. Am., Vol. 54, 1943, pp. 1439-1548.
- [40] P. J. Williams. "Some Investigations into Solifluction Features in Norway," Geog. J., Vol. 123, 1957, pp. 42-58.
- [41] D. M. Hopkins. "Thaw Lakes and Thaw Sinks in the Imurok Lake Area, Seward Peninsula, Alaska," J. Geol., Vol. 57, 1949, pp. 119-131.
- [42] B. Neiland, A. W. Johnson, R. Johnson. "Influence of Frost Action on the Vegetation of the Ogotoruk Creek Valley," Prog. Rept., Univ. Alaska, 1962, pp. 1-49.
- [43] L. C. Bliss. "A Comparison of Plant Development in Micro-Environments of Arctic and Alpine Tundras," Ecological Monog., Vol. 26, 1956, pp. 303-337.
- [44] E. D. Churchill. "Phytosociological and Environmental Characteristics of Plant Communities in the Umiat Region of Alaska," Ecology, Vol. 36, 1955, pp. 606-627.

- [45] J. V. Drew, J. C. F. Tedrow, R. E. Shanks, J. J. Koranda. "Rate and Depth of Thaw in Arctic Soils," Am. Geophys. Union Trans., Vol. 39, 1958, pp. 697-701.
- [46] L. C. Bliss. "Adaptations of Arctic and Alpine Plants to Environmental Conditions," Arctic, Vol. 15, 1962, pp. 117-144.
- [47] V. P. Dadykin. "Peculiarities of Plant Behavior in Cold Soils," Voprosy Botaniki, Vol. 2, 1954, pp. 455-472, in Russian; pp. 473-489, in French.
- [48] A. P. Sokolovskaya, O. S. Strelkova. "Geographical Distribution of the Polyploid Plant Species in the Eurasian Arctic," Bot. Zhurn., Vol. 45, 1960, pp. 369-381.

Supported by United States Atomic Energy Commission, Contract AT (04-3-310).

DISCUSSION

R. E. BESCHEL, Queen's University, Kingston, Ont.—The conclusions regarding the positive correlation of a shallow active layer in the substrate with a high number of polyploids in the vegetation are very likely based on an artifact.

A higher incidence of polyploidy among monocotyledons is well known. Love and Love write: "In the subarctic and arctic regions the frequency of polyploids reaches more than 70%; 50 to 60% within the dicotyledons, and up to 100% within the monocotyledons." In warm temperate regions they find "perhaps only 20 to 30% [polyploids] within the dicotyledons and 50 to 60% within the monocotyledons." (A. Love, Doris Love, "Arctic Polyploidy," Proc. Genetics Soc. Can. 2, 1957, pp. 23-27.)

Along an environmental gradient from dry to wet, the percentage of monocotyledons increases as a rule. This happens in a continuum from a maple forest to a sedge meadow in temperate North America as well as in an arctic vegetation gradient; e.g., the hummock catena discussed in my contribution to this conference shows (from the upper, dry extreme at 1 m to the lower, wet extreme at 30 m) the following ratios of monocot species to dicot species for each square meter of the transect: 0, 0.25, 0.13, 0, 0.20, 0, 0.17, 0.33, 0.14, 0.57, 0.29, 0.22, 0.27, 0.42, 0.40, 0.37, 0.25, 0.50, 0.42, 0.50, 0.64, 0.50, 0.89, 0.70, 1.09, 0.86, 1.0, 0.50, 0.78, 0.62.

GEOCHEMISTRY OF PERMAFROST: BARROW, ALASKA

JOHN B. O'SULLIVAN, Allis-Chalmers Manufacturing Co., Milwaukee, Wis.

The major factors causing variation in salt content of permafrost are texture, depth and moisture content of the sediments, and history of the particular site.

The Barrow area is the northernmost portion of the recently emergent coastal plain extending across northern Alaska. The area is underlain by permafrost to a depth of 1300 ft [1]. Seasonal temperature fluctuations are approximately 20°, 8°, 3°, and 2°C at 10 in., 10, 20, and 30 ft, respectively; below this zone the minimum temperature is about -10°C [1]. The marine sediments have been modified drastically by cryopedologic processes and locally by the formation of thaw lakes.

Study of aerial photographs indicates that little of the area has been untouched by the thaw lake cycle [2] since emergence. To avoid the possibility of disturbance, the profiles were obtained from areas not visibly touched by lakes. This, it was hoped, would yield profiles differing because of the materials and permit evaluation of the effect of climatic variations since the development of permafrost. The locations of cited profiles are shown in Fig. 1.

PROCEDURE

Sampling Methods

Holes, up to 3 ft in dia. and 20 ft in depth, were drilled with

The frequency of polyploidy rises along any gradient along which the frequency of monocotyledons increases. This occurs in temperate regions just as well as in the Arctic. The correlation with permafrost appears only fortuitously.

CLOSURE

Dr. Beschel's discussion is based on his conclusion that the percentage of polyploidy in the flora of the Ogotoruk Creek Valley has been related to a moisture catena and that the report of polyploid species in habitats modified by shallow permafrost layers is based on an increase in monocotyledonous species in those environments.

First, nowhere is it stated in this paper that an analysis of polyploidy along a moisture catena has been made. The statement is made that one does not ordinarily find diploids associated with permafrost environments and that most of the species found in these habitats are high polyploids. This statement is true whether one considers only monocotyledonous plants, only dicotyledonous plants, or both.

Second, Dr. Beschel assumes that the number of monocotyledonous species increases along the moisture catena in the Ogotoruk Creek Valley similarly to the area he studied in the High Arctic. This is incorrect; the greatest number of monocotyledonous species in the Ogotoruk Creek Valley grow in intermediate habitats regarding soil moisture.

Third, it should be pointed out that moisture is only one aspect of environmental change in respect to shallow permafrost layers. Soil temperatures, frost action, and soil texture also change, for example. All of these phenomena are important to plant growth in permafrost habitats.

Finally, Dr. Beschel apparently thinks that ecology and polyploidy in the arctic flora are unrelated. If polyploidy plays a role in plant adaptation, it is reasonable to assume that it has been important during the period of climatic and physiographic change during the Quaternary. If this is so, it is not regarded as fortuitous that one finds many polyploid species growing in just those habitats which show most markedly the effects of Quaternary climate, i.e., those places in which shallow permafrost, high moisture levels, and cold temperatures have greatly modified the environment.

an auger. This facilitated two sampling methods: (a) bulk sampling off the raised auger flight, and (b) hand sampling in the hole. The heterogeneity in both sediment and ice content causes hand sampling at foot intervals to yield more erratic data than the auger samples. However, hand sampling has its greatest value in examining small increments, differing materials, and ice-soil structures. Hand samples, unless for a specific horizon, were taken from a 6- to 10-in. interval covering one-third the circumference of the hole.

Sample Treatment

Two approaches used were leaching of the sample with a liter of distilled water or extraction of the soil solution near field moisture. If the field moisture was near or below saturation, distilled water was added to exceed saturation before the solution was extracted. Extraction near saturation was avoided because negative adsorption then becomes a critical unknown [3]. Negative adsorption is caused by an unequal distribution of ions within the soil water as a result of surface tension. Therefore, the first increment of solution removed is more concentrated than the second, and so on. Thus a concentration value based on partial removal of the soil water is higher than for total removal. The percentage of error increases with decreasing moisture and with increasing surface area of the soil;

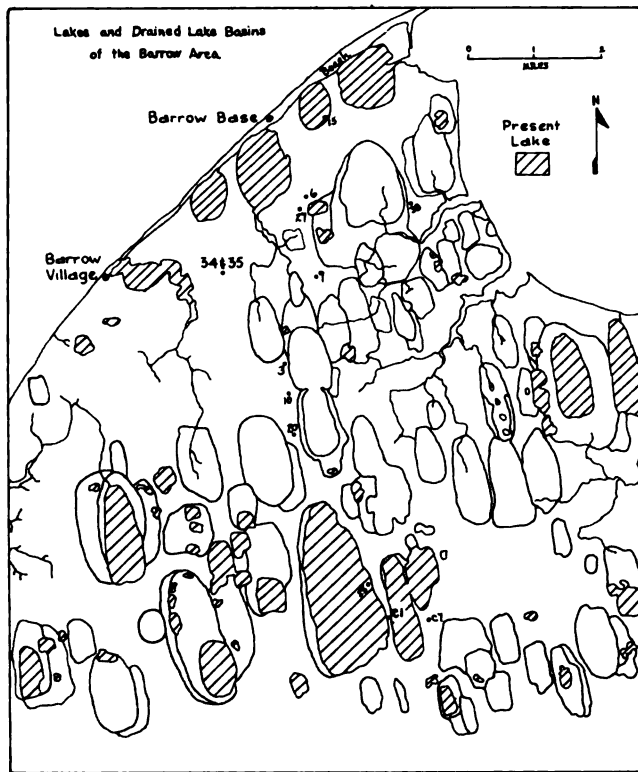

Fig. 1. Location of figured profiles

the percentage decreases with increasing concentration of solution. This error can exceed 30%.

Predrying samples with high organic content influences the composition of the soil solution. Drying the organic matter initiates its decomposition which continues during subsequent rewetting, yielding a dark solution of organic colloids. This effect is most pronounced in the leached samples where removal of the salt increases colloid dispersion and hence its amount.

Analytical Methods

Salinity was determined by analysis of individual ions and measurement of the solution conductance. Ionic analysis was complete for about 60 leachates and all but the alkalis on 40 more. Since the ionic balance

Σ cations - Σ anions
 Σ cations + Σ anions

was less than 1% for 81% of those analyzed, the remaining 40 alkalis were calculated by difference. Briefly the methods used were:

- Ca + Mg and Ca by EDTA titration, Mg by difference
- Na and K by flame photometry, Li as internal standard
- SO₄ gravimetrically as BaSO₄ with BaCl₂
- HCO₃ methyl orange end point with H₂SO₄
- Cl, by titration with mercuric nitrate
- Specific conductance, 0.01N KCl as standard (1412 μ mhos at 25°C), a cell constant of 0.3/cm, and a 60-cycle bridge

The leachates, which varied in color because of organic colloids, were cleared before analysis by heating with 30% H₂O₂. The oxidation of the organic colloids introduces an error since the liberated metal ions have a higher conductance than the organic complexes. For the few light brown solutions checked, the increase in conductance was 30 to 60 μ mhos, an increase of 6 to 13%. In high salt-low organic samples, this increase is insignificant.

The conductance versus concentration relationship can be

approximated by two linear equations and the coefficients determined by the least-squares method. Those few samples showing a large deviation, because of high SO₄ to Cl ratios, were eliminated. The general equation is

$$\text{In (meq/liter)} = Z \text{ In } (C_S) + C \tag{1}$$

for $C_S > 5000 \mu\text{mhos}$, $Z = 1.2070$; $C = -6.3793$; 22 data points
 for $C_S < 5000 \mu\text{mhos}$, $Z = 1.0654$; $C = -5.1918$; 78 data points
 where C_S is specific conductance in μmhos (per cm) at 25°C.

To evaluate the normal reproducibility of the conductance measurements, leachates and soil solutions were periodically rerun. These data are given in Table I. Briefly stated, 75% of the samples differed by less than 3%. Variation around the conductance equation was also about 3%. Reproducibility was poorer at Barrow where the short term, indoor, temperature fluctuations were much greater.

Table I. Check on conductance measurements of solutions (All data are given in percentage)

Error Based on Initial Reading ^a	Barrow Samples ^b	Ames, Iowa Samples ^c	Error	Barrow Samples	Ames, Iowa Samples
$\geq \pm 6.0$	10	1.5	$\geq \pm 2.5$	30	27
$\geq \pm 5.0$	15	3.0	$\geq \pm 2.0$	40	38
$\geq \pm 4.0$	21	8.0	$\geq \pm 1.5$	46	54
$\geq \pm 3.5$	25	11.0	$\geq \pm 1.0$	63	69
$\geq \pm 3.0$	25	24.0	$\geq \pm 1.0$	37	31

^aTwo readings taken from two days to two weeks apart to include time dependent changes; readings calculated to three significant places

^bTotal of 68 samples; maximum error = -10.6

^cTotal of 74 samples; maximum error = -6.1

Expression of Data

To describe salinity variations within a profile and areally, a basis for sample comparison is needed. For a solution basis, measurement is direct from conductance to mg/liter or meq/liter. Though conversion to a dry soil basis is simple at low salt contents, at high salt concentrations the equivalence of meq/liter and meq/1000 g H₂O (or mg/liter and ppm) is no longer valid. Only at very high salt concentrations (Table II) do these errors approach the error due to other factors. One can make a correction, with sufficient accuracy, by assuming the same density variation as NaCl solutions [4]. Fig. 2 shows meq/liter versus (F), where (F) is the error between meq/liter and meq/1000 g H₂O. The curve may be approximated by linear equations and the coefficients obtained by

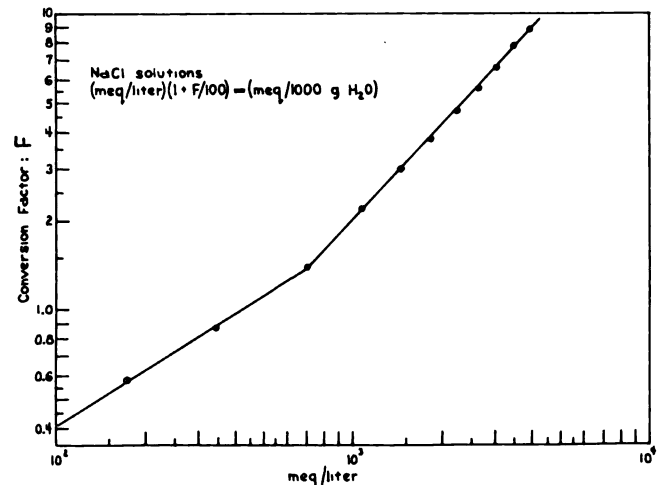

Fig. 2. Conversion of meq/liter to meq/1000 g H₂O; NaCl solutions

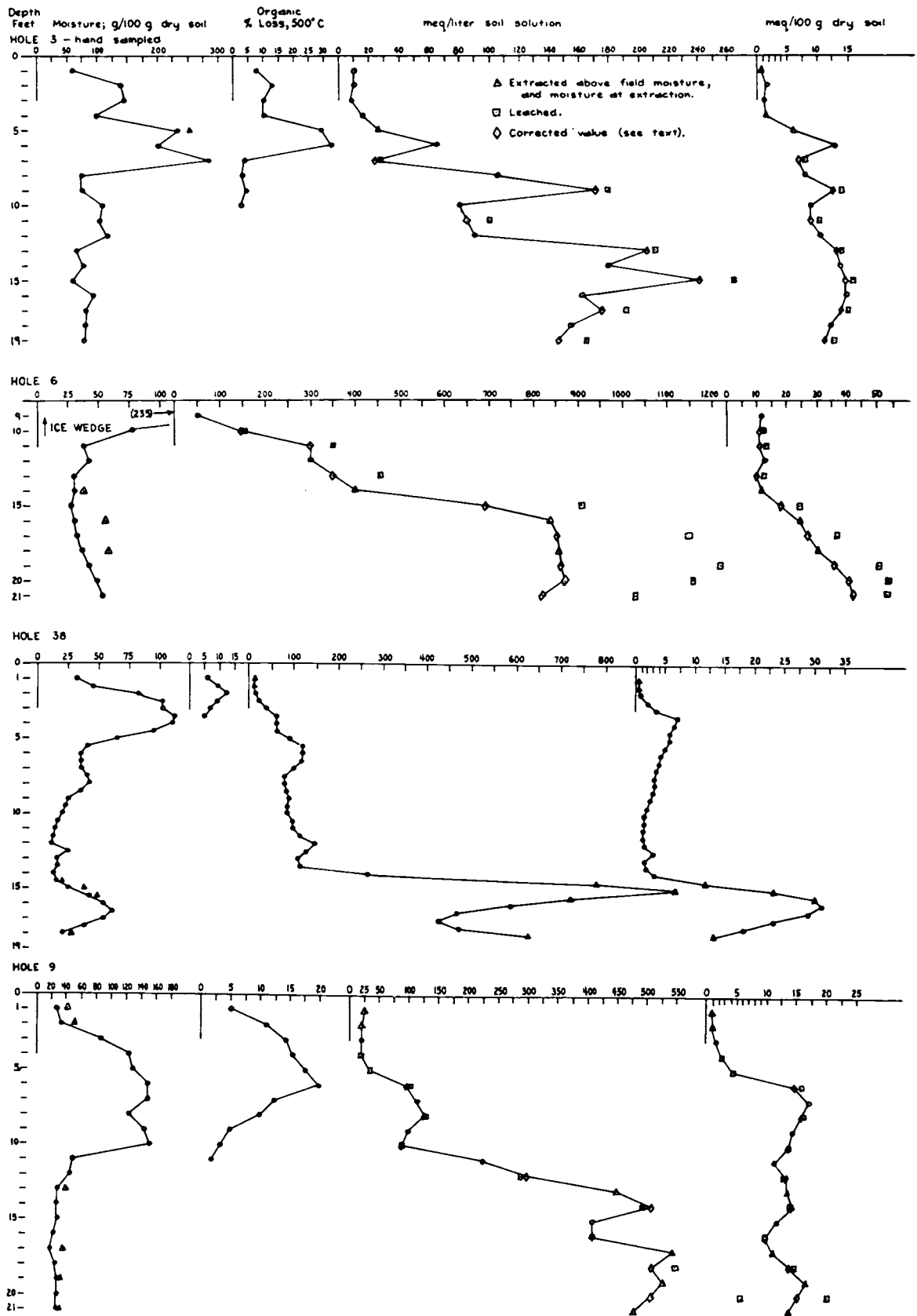

Fig. 3. Representative profiles of primary surface sites

least-squares. The general equation is

$$\ln(F) = Z \ln(\text{meq/liter}) + C \quad (2)$$

for <700 meq/liter, $Z = 0.6361$; $C = -3.8323$
 for >700 meq/liter, $Z = 1.0672$; $C = -6.6688$

For (1) and (2) most of the routine calculations are easily handled by a computer. From the basic inputs of solution conductance and moisture content, the output may be obtained in practically any weight or volumetric units. In this paper, moisture content refers to all moisture removed at 110°C whether originally present as ice, surface-adsorbed water, or brine. Realization that the moisture occurs in various forms is useful, even though the proportions cannot be estimated without calorimetry, surface area, and salinity.

Table II. Error in volumetric-weight equivalence at high salt concentrations

Cs, 25°C millimhos	Meq/liter	Meq/1000 g H ₂ O	% Error	Mg/liter ^a	Ppm	% Error
~ 30	420	424	+1	24 400	24 000	-1.6
~ 60	1000	1020	+2	58 000	55 800	-3.8
~100	1900	1976	+4	110 000	103 000	-6.4

^a Assumed equivalent weight of 58

The units employed here are meq/liter soil solution and meq/100 g dry soil. These may be approximately converted to Mg/liter (or ppm) or percentage of salt by multiplying by 58 or 0.058, respectively. Milliequivalents/100 g dry soil is usually meant when referring to soil salinity. All ionic ratios are equivalent ratios.

DISCUSSION OF RESULTS

Sample Treatment

In general the difference between leached and extracted samples is no greater than that between duplicates, except for the organic-drying effect or the presence of other soluble salts. Unfortunately many of the samples, especially the finer sediments and some sands, contained gypsum concretions. These leached samples yielded anomalously high salinities when compared to the soil solutions of adjacent samples. From the chloride content of the leachates, a corrected value for the salinity was calculated on the assumption that the cation to chloride ratio should be the same as sea water. These corrected values were in good agreement with the soil solution values. For holes 3 and 9 (Fig. 3) the difference between corrected and leached was about 5%, but for holes 6 the corrected value was 20 to 30% lower than the leached value. For samples of low salinity, this can easily become 70 to 90%. Table III shows a comparison between extracted and leached with and without prior drying.

Table III. Comparison of sample treatments

Sample	Moisture Dry Basis	Organic % Loss, 500°C	meq/100 g soil		
			Soil Soln.	Leached w/drying	Leached w/o drying
35-3	170	14.7	0.85		
35-4	190	27.7	0.85	2.40	1.10
35-5	225	27.8	0.90		0.95
35-6	325	21.1	0.90	2.30	1.05
35-7	180	10.9	1.65		1.60
35-8	130	7.9	2.10	2.30	
35-9	120	7.9	3.00		3.40
35-10	120	8.6	4.50	4.60	
35-11	130	13.9	8.35		8.10
35-12	115	9.1	11.60	10.60	
35-13	115	8.5	12.00		
35-14	165	5.2	11.40	10.90	

Conductance Equation

As the leachates might have a different conductance equation

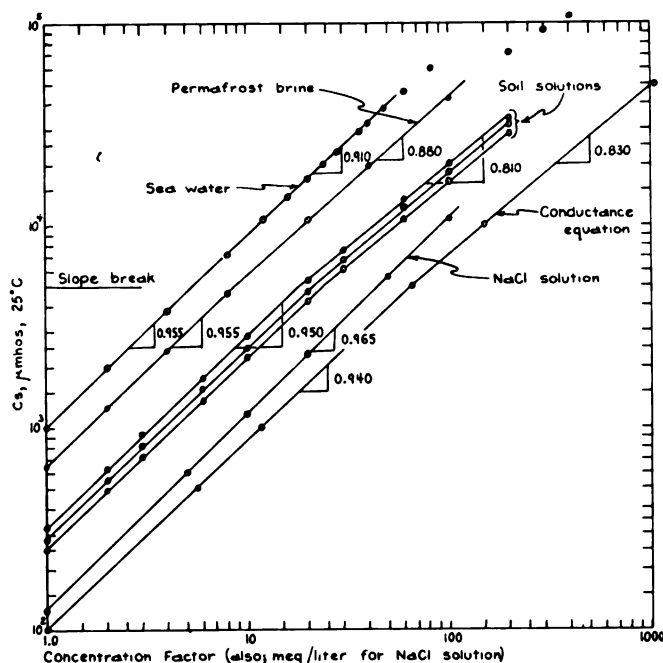

Fig. 4. Conductance-concentration relations for various solutions

than soil solutions, they were compared by the following method: Several soil solutions were mixed and three different solutions were prepared. They were diluted with conductance water and a series of solutions was obtained for each. Conductance was measured and plotted versus the concentration factor, taking the most dilute of each series as unity. The lines for the soil solutions, a flowing brine within the permafrost, the conductance equation for sea water [5], and NaCl solutions [6] are shown in Fig. 4. This method may be used to compare solutions since the slopes of the dilution curves will vary with variations in ionic species.

The more gentle slope of the conductance equation results from the higher calcium and magnesium and lower sodium contents of the leachates, as compared with sea water (see Ionic Variations section preceding Conclusions). Calcium and magnesium have lesser equivalent conductances than sodium. At higher concentrations, leachates had relatively higher sulfate contents. Sulfate has a lower equivalent conductance than chloride and contributes to the reduction in slope. The NaCl curve has the steepest slope, as would be expected. These conductance deviations increase with concentration and probably account for the deviation between the brine and sea water curves. Why the soil solution curves are less steep at high concentrations as compared to the conductance equation is uncertain but may be due to the organic colloids present. In general, the equation is applicable to both soil solutions and brines. For conductances above 40 to 50 millimhos, either a third linear segment must be calculated or the entire curve fit to a different equation. For higher conductances a 1000-cycle bridge is desirable since polarization errors would be reduced.

Initial Freezing of Sediments

In the initial freezing of a sediment saturated with sea water, the temperature of the freezing front will vary with the amount of water available and rate at which it is supplied to the front, the diffusion of ions away from the front, and the temperature gradient. The temperature of the front governs brine concentration in equilibrium with the ice and therefore of the brine left in the soil as the front moves past. Using the data presented by Assur [7], the brine concentrations in equilibrium with ice at -2°, -4°, -6°, and -8° are 675, 1315, 1920, and 2510 meq/1000 g H₂O, respectively.

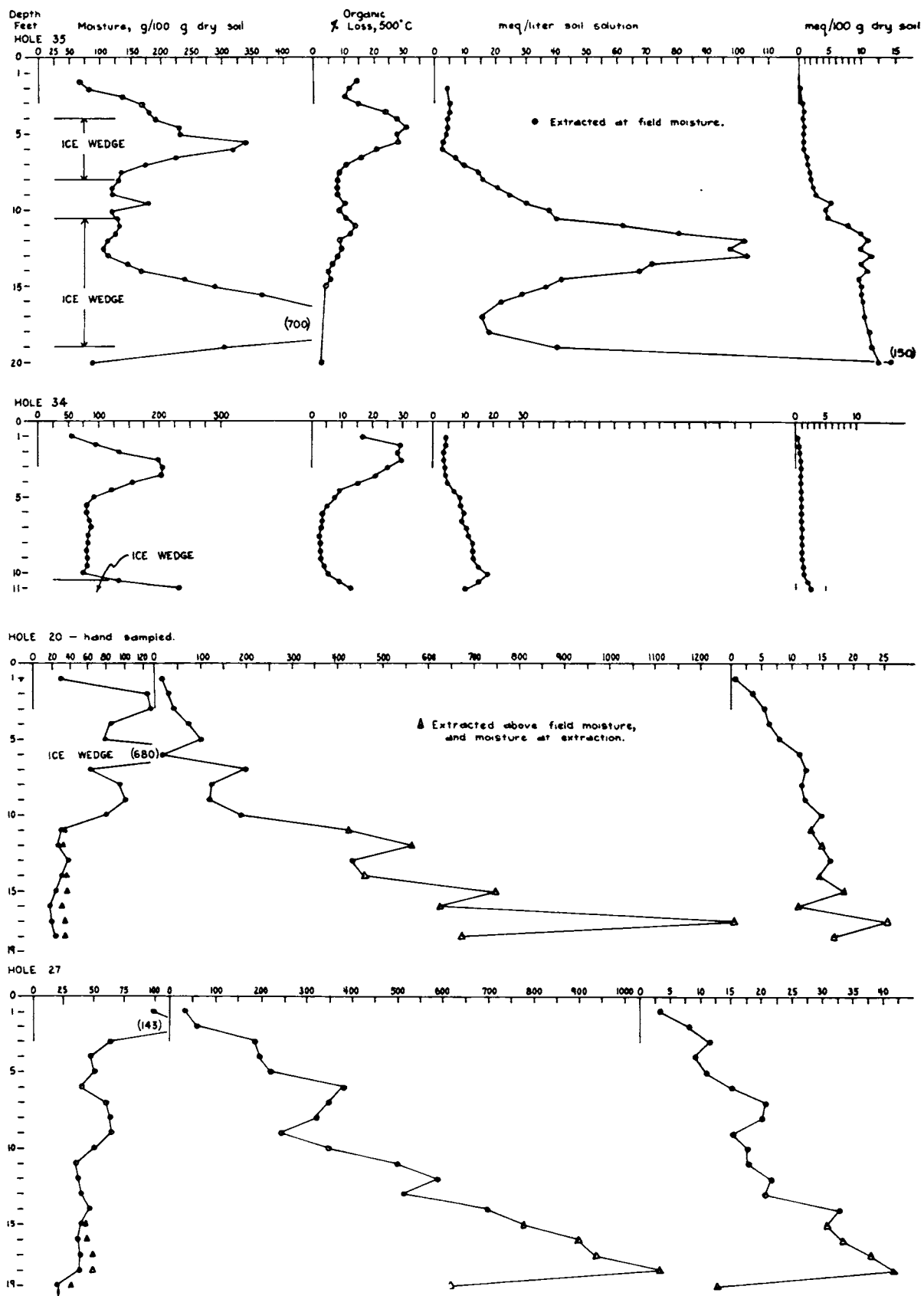

Fig. 5. Representative profiles of primary surface sites

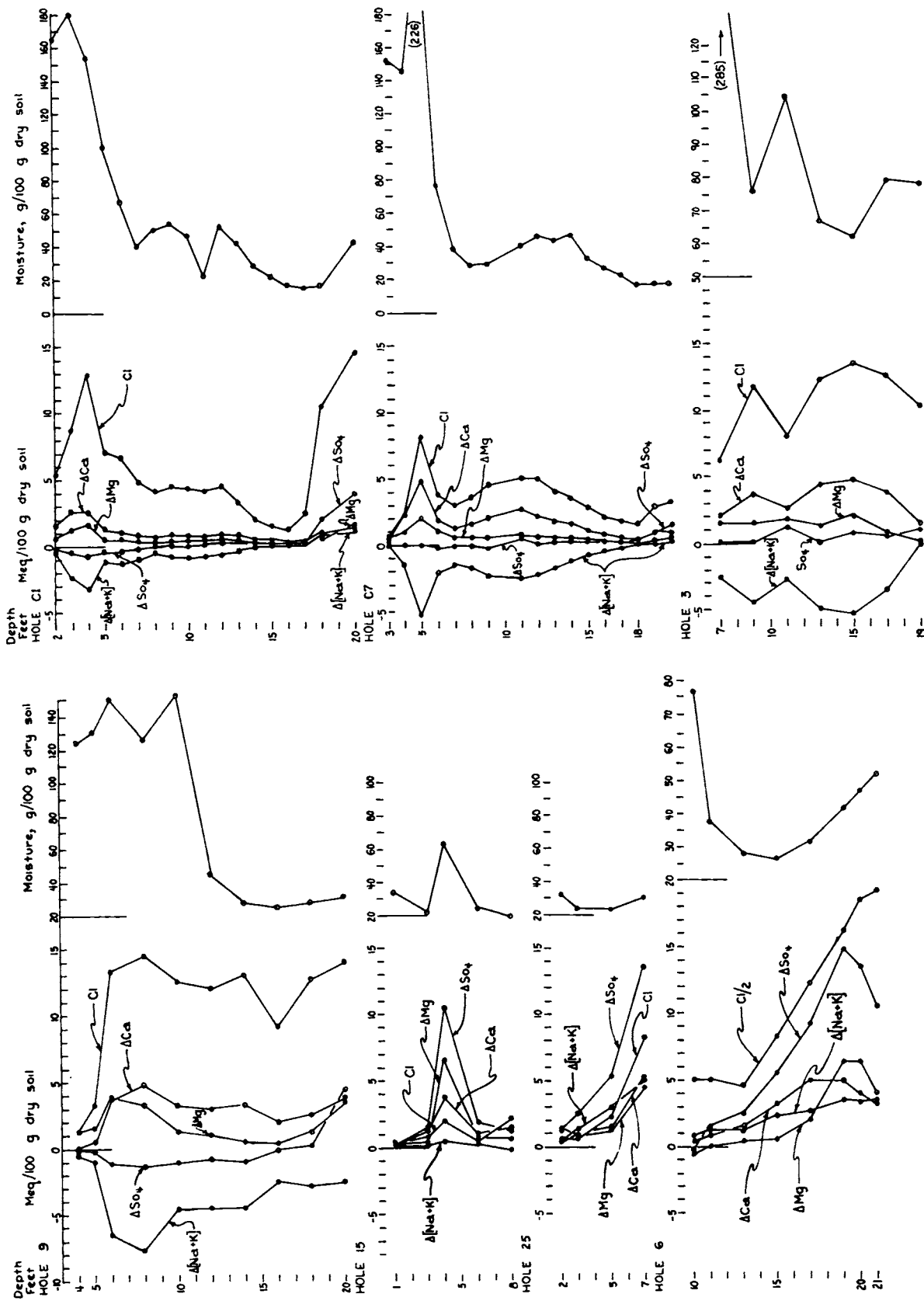

Fig. 6. Ionic variation and trends in the permafrost

The ice phase with brine inclusions is usually relatively salt free. For sea ice, one season old, the average salinity is about 5/mil. Measurements on 2 cores gave a range of 75 to 95 meq/liter (7000 to 8600 μ mhos). Old sea ice is usually about 2/mil, as a result of brine migration. Wedge-ice ranges from 0.2 to 4.2 meq/liter (30 to 500 μ mhos) [8]. This low salt content explains why the contamination in hole 35 (Fig. 5) did not affect the soil salinities. But salt content of ice in the soil structure could be greater and more variable since it was in contact with brine during freezing.

Factors Affecting Salinity

Heterogeneity—The initial heterogeneity of sediments is a result of deposition in a near shore environment. During freezing of sediment, variation in ice segregation also caused heterogeneity, even within otherwise uniform material. The upper 20 ft of permafrost is locally contorted as a result of ice-wedge growth and other cryopedologic processes. Deformation of permafrost in compression is aided by changes in brine volume in response to temperature. As an approximation, the brine volume doubles with a temperature rise from -8° to -4°C and again from -4° to -2°C.

Depth—In general there is an increase in salinity with depth. The most rapid increase occurs in the interval from 4 to 6 ft with an increase of 3 to 6 times (usually from 4 to 12 meq/100 g). Some soil solutions had salinity values of 1/2, 1, and 2 times sea water at depths of 7, 14, and 17 ft, respectively. Sea water, as used here, has a concentration of 607 meq/liter (salinity, 34.3/mil). Flowing brines occur in the frozen sediment, but were seldom encountered in the profiles studies. The one used in the dilution-conductance study had a concentration of 2200 meq/liter (salinity, 118/mil). Using the table given by Assur [7], the freezing point of the brine should be -7.4°C.

Texture—Texture of the sediment influences the salinity. Coarse sands and sandy gravels usually contain 1 to 6 meq/100 g. Silts and sandy silts have a tendency to level off between 12 and 20 meq/100 g with depth, whereas the finer silty clays have 30 to 40 meq/100 g dry soil. Using a saturation moisture basis instead of unit soil would lessen the textural bias since the saturation moisture increases with decreasing particle size. These textural changes can cause rapid changes in the salinity profiles. In hole 6 (Fig. 3) and hole 27 (Fig. 5) there is an increase in clay with depth, and in the latter a change to silt at 20 ft. The profile of hole 38 (Fig. 6) shows the changes from sandy silt into gravelly sand at 5 ft, from sandy gravel into silty clay at 14.5 ft, and the clay maximum at 16 ft. The increase in salinity between 17 and 20 ft in hole C1 (Fig. 6) coincides with the change from sandy gravel to silty sand.

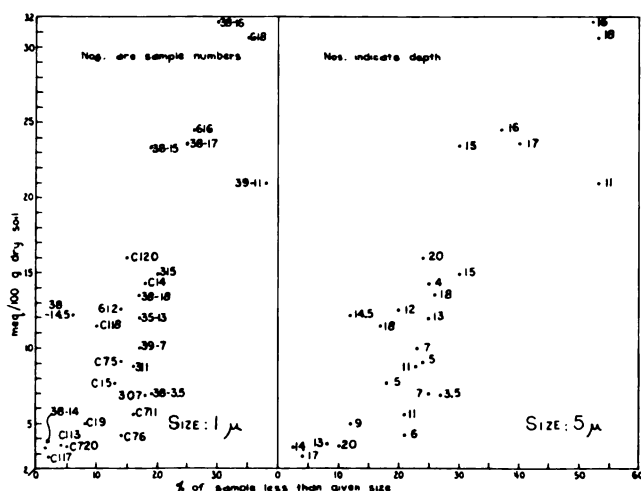

Fig. 7. Size effect in soil salinity

The relation between meq/100 g and percentage of sample less than 1 and 5 μ in size is shown in Fig. 7. Other sizes were tried but the above gave the least scatter. The scatter is still so great and trends with depth so variable that general predictive use is not feasible.

Moisture contents—Ice was always present and, with thawing, diluted the brine present in the soil portion. Therefore, the meq/liter values are erratic and reflect changes in ice content more than salinity of the soil. Reducing soil solution values to meq/liter based on the saturation moisture of the soil would be more realistic. That most of the salt is associated with the soil as interstitial brine is shown by the meq/100 g dry soil values which are less affected by variations in moisture content.

Duplicate hand samples were taken to see the variation between samples of different ice content but of similar sediment. One profile (hole 10, Fig. 8) was duplicated by hand, as were the samples in Table IV. The results, as a rule, were erratic and all variations were noted, from increasing to decreasing soil salinity with increase in moisture. Some of this variation can probably be related to differing salinity of the ice in the ice-soil structure, though probably the greatest cause is difference in brine saturation of the soil phase. The variations in moisture reflect differences in behavior during freezing and therefore in brine concentration, and may also affect later brine drainage. Consequently, to characterize a profile it is necessary to have profile-size samples, as from the auger.

Table IV. Comparison of duplicate samples, differing primarily in moisture content

Sample	Depth (ft)	Moisture	meg/liter	meg/100 g	Moisture	meg/liter	meg/100 g
S910	10.5	38.5	370	14.3	120.0	120	14.5
		47.7*					
S914	14.0	28.1	390	11.0	74.6	85	6.4
		39.1*					
S814	14.5	30.3	355	10.8	93.3	54	5.0
SH128	11.5	200.0	142	28.4	910.0	43	39.2
SH138	8.5	62.2	112	7.0	155.0	36	5.5
SH139	9.5	61.6	230	14.2	85.8	195	16.7
S702	2.0	67.4	17	1.15	110.0	14	1.55

*Moisture at extraction

Ionic variation—The ionic analyses used to define the conductance-concentration relation may be used to search for ionic variations. In evaluating the latter, the theoretical milliequivalents of each ion was computed using the ion to chloride ratio of sea water; then this value was subtracted from the amount determined analytically. The resultant value is called Δ (e.g., Δ Ca, Δ Na), a positive value indicating an excess. An excess of sodium and sulfate, which precipitate from sea water brine at -8°C, was not observed, so brine drainage must have taken place above that temperature.

Two definite variations were noted: (a) Excess of calcium and magnesium, with calcium deviations in excess of magnesium, and an equivalent deficit in sodium; the magnitude of this variation increases with increasing chloride concentration. (b) a major increase in magnesium, which tends to approach or exceed calcium, and an increase in sodium with an increase in the sulfate ion. Analysis of some of the concretions indicated they were gypsum containing almost no magnesium. Magnesium sulfate is not reported as precipitating from sea water brines, though it might be possible with these concentrations exceeding sea water. Hole 6, in which concretions are common, and hole 9 (Fig. 6) typify these variations.

The variations are best explained by an ion exchange reaction within the soil-brine system. At high concentrations, sodium displaces calcium and magnesium from the complex; this exchange increases with increasing sodium concentration (i.e., increasing chloride). As gypsum dissolves and the calcium concentration increases, the exchange is partially reversed and sodium and magnesium are displaced. The magnesium is apparently more readily displaced than the sodium. Though these were leachates, the exchange reactions should

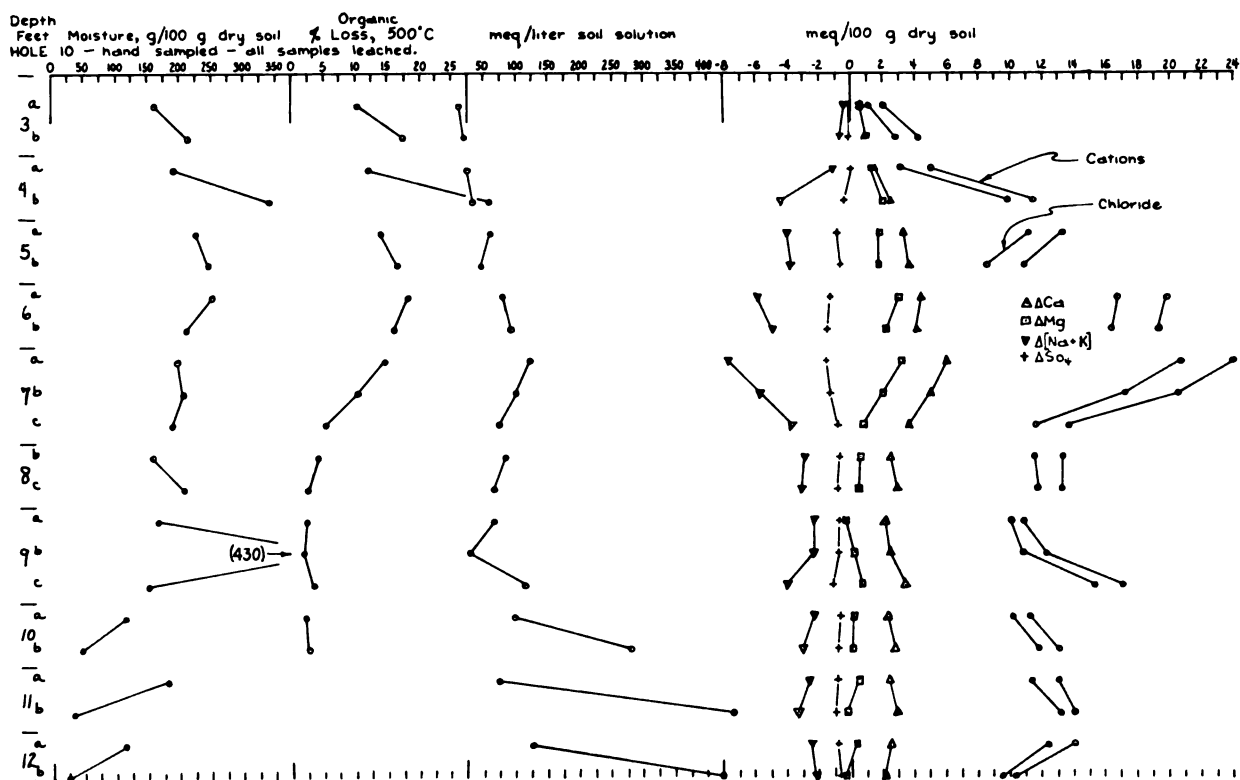

Fig. 8. Variation in salinity in adjacent samples

also occur in soil solutions; therefore, this must be kept in mind when using ionic ratios and interpreting conductance data.

CONCLUSIONS

The salinity of the permafrost results from the post-emergent freezing of the marine sediments. Freezing was rapid enough that leaching of the interstitial sea water was almost wholly prevented. The lower salinity in the upper 10 to 15 ft is due primarily to drainage of the residual brine during initial freezing, later under seasonal temperature cycling, and to the leaching of past active layers.

Based on the salinity data, the active layer thickness does not seem to have exceeded 4 to 6 ft in the past. However, in one area (holes 34 and 35, Fig. 3) the sediment has been leached to a depth of 10 ft, which also coincides with the top of truncated ice-wedges. In this area the salinity increases from 3 to 12 meq/100 g (25 to 102 meq/liter) between 9 and 12 ft with no significant change in either moisture content or texture. Settlement calculations based on moisture and density data indicate that at the time of leaching the active layer was 3 to 5 ft thick. This, in part, explains the deviation between this and similar areas. The area is covered in more detail by Brown [8].

ACKNOWLEDGMENTS

These organizations supported this work: Office of Naval Research and the Arctic Institute of North America (grant, 1958-1959) and the National Science Foundation (post-doctoral fellowship, 1961-1962); the Arctic Research Laboratory (ARL), Barrow, Alaska, for equipment and logistic support during winter and spring of 1958-1959 and spring of 1962, and the Geology Department at Iowa State University which supplied equipment

and space for most of the laboratory work.

I wish to thank Max Brewer, Director ARL, and K. M. Hussey, Iowa State, for encouragement and cooperation. Discussions and work in 1962 with Jerry Brown, U. S. Army CRREL, were valuable, as was field and laboratory aid of Richard Faas, at Iowa State.

REFERENCES

[1] M. C. Brewer. "Some Results of Geothermal Investigations of Permafrost in Northern Alaska," *Am. Geophys. Union Trans.*, Vol. 39, 1958, pp. 19-22.
 [2] M. E. Britton. "Vegetation of the Arctic Tundra," 18th Biol. Colloq., *Arctic Biol.*, Oregon State College, Corvallis, Ore., 1957, pp. 54-58.
 [3] C. A. Bower, J. O. Goertzen. "Negative Adsorption of Salts by Soils," *Soil Sci. Soc. Am. Proc.*, Vol. 19, 1955, pp. 147-151.
 [4] C. D. Hodgman. *Handbook of Chemistry and Physics*, 41st ed., 1960, Chemical Rubber Publ. Co., Cleveland, Ohio.
 [5] "Electrical Conductivity of Sea Water," *Graph No. L-22759D*, Industrial Instruments Inc., Cedar Grove, N. J.
 [6] H. S. Harned, B. B. Owen. *The Physical Chemistry of Electrolytic Solutions*, 3rd ed., Reinhold Publ. Co., N.Y., 1958.
 [7] A. Assur. "Composition of Sea Ice and Its Tensile Strength," NAS-NRC Publ. 598, *Arctic Sea Ice*, 1958.
 [8] J. Brown. "Ice-wedge Chemistry and Related Frozen Ground Processes," in this volume.
 [9] W. L. Boyd. "Limnology of Selected Arctic Lakes in Relation to Water Supply Problems," *Ecology*, Vol. 40, 1959, pp. 49-54.
 [10] L. A. Douglas, J. C. F. Tedrow. "Tundra Soils of Arctic Alaska," 7th Intl. Cong. of Soil Sci., *Trans.*, Vol. 4, 1960, pp. 291-304.

ORIGIN AND SIGNIFICANCE OF ORGANIC TERRAIN FEATURES

NORMAN W. RADFORTH, McMaster University, Hamilton, Ontario

South of the permafrost fringe organic terrain, muskeg, as it is known in Canada, often occurs in depths exceeding 40 ft. Both in and beyond the influence of permafrost where it can be at least 6 ft deep, it may cover areas from several to many hundreds of square miles. It is now regarded as a major feature of contemporary terrain with circumpolar significance.

Much work in MacFarlane's bibliography [1] and the considerable work of this author support the hypothesis that because the constituents of organic terrain are primarily of vegetal origin, their preserved state (as peat) reflects ordered processes. Basic to this is the reasoned assumption that the biological behavior resulting in successional phenomena, arising as peat is formed, is a function of genetic potential affected by climatic, edaphic, biotic, or all three influences.

Though aspects of this hypothesis are still under examination, the proposition now enjoys theory status because the large body of evidence reveals recurring characteristics and phenomena which have facilitated classification of organic terrain by objective process. Microfossils, as polospores, tissues, or cuticles of plants indigenous to peat have aided the classification problem [2, 3, 4]. The order manifested in vegetal cover, microtopography, and structure of peat have also been studied [5]. The association of biological trend with physiographic influence began with an examination of subsurface ice phenomena as related to organic terrain [6] and culminated in study of geomorphic pattern [7] and an appraisal of the principles involved in airphoto-interpretation of the ordered features of organic terrain.

Organic terrain may arise at any time. Its occurrence has been initiated with greatest frequency on glaciated surfaces, on or off the present permafrost zone. In accounting for the basic phenomena and features reflecting the nature and organization of organic terrain, it seemed reasonable to begin the study of its origin and characteristics at places where the dynamics of the contemporary icecap reveal the most recently exposed surface of the mineral terrain.



Fig. 1. Cover formula "F" consists of matted nonwoody organic terrain less than 2 ft high



Fig. 2. Cover formula "EI" on plain consists of predominantly woody growth less than 2 ft high with a mat of mosses

This proposition assumes that organic terrain exists at or near the edge of the icecap. In 1962, on southern Ellesmere Island, the author was able to identify organic terrain about 50 ft away from the ice face. A year later organic terrain was found a few feet from pack ice on lands in the vicinity of Alert (Ellesmere Island) where, at altitudes exceeding 1000 ft above sea level, it also occurs.

In these areas, peat in depths exceeding one ft is rare; the depth is usually three to five in. Its occurrence is patchy in areas rarely exceeding a square mile and often sporadic in areas only one to several square feet in extent.

SOME BIOLOGICAL OBSERVATIONS

Although, as yet, no microfossil analysis has been made of Ellesmere Island peat, information has accrued that facilitates comparison of this peat with that associated with permafrost near Churchill, Manitoba, on which microfossil studies are reported [2, 8].

Recurring types of microfossil spectra, pollen and spores of indigenous species, appear in the Churchill area. Each corresponds to its own type of vegetal cover as classified by the author in 1953. Certain of these cover types shown in Figs. 1, 2, 3, 4, and 5 and known to be characteristic for northern organic terrain cover [9, see map] recur widely on Ellesmere Island at Goose Fjord, Okse Bay, Alert, and Lake Hazen, and on Greenland near Thule. It is reasonable to infer that these cover types indicate contrast in composition of spectra in the subtending peat found near the ice front as they did for peat further south on the permafrost. A similar contrast is noted when organic terrain from Churchill (FI and EI cover formulas) is compared with that from as far south as Parry Sound in the Georgian Bay area of Ontario [10].

Organic terrain types universally differ consistently both in area and in depth. When the more southern organic terrain was examined by type of microfossil composition at the bases of the spectral axes, it was predicted that FI and EI cover would occur and predominate on organic terrain just originating. The author's Arctic survey bears this out.



Fig. 3. Sequence of letters in the formula indicate order of prominence of components. Cover formula "EI" consists of a nonwoody, low stature mat providing densest component and the highest layer "F" with woody cover (see broad laws) a lower, less dense component "E" and moss mat 4 in. high "I" below the leaves

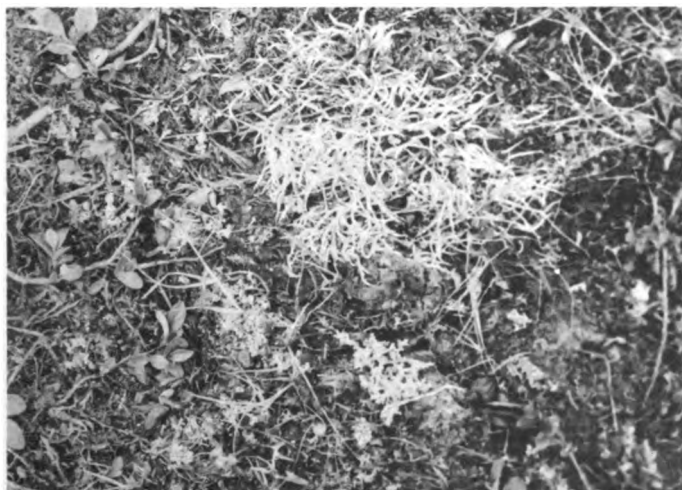

Fig. 4. Cover formula "EH" consists of the more prominent woody low growth "E" with lichenaceous growth "H", leathery and less than 4 in. high



Fig. 5. Ridges consist of commonly coalescing mounds. Cover formula is "EFI"; "E," the woody most prominent element is more difficult to detect than "F," the less common nonwoody component (less than 2 ft high) and the mossy mat "I," which the others combine to obliterate

The author believes [7] that the theory of climax requires too much qualification to warrant its application for organic terrain. The present work contributes support of this despite the relative youth of the organic terrain in the far Arctic. Though climate above and below contrast markedly, vegetal succession for given kinds of organic terrain remains virtually the same; there has been no evolving to dominants in the course of time, and vastly differing climates are conducive to the establishment of closely related and enduring colonizers growing more than 1500 miles apart.

The work in the far north has also confirmed that the initiation sequence in floras does not necessarily commence with thallophytic as the primary colonizers of naked mineral terrain to be followed by nonwoody plants and finally woody supplanters—a classical claim. In fact, this sequence can occur in reverse. In any case, close to the icecap on recently uncovered slightly eroded ground, low shrubs and woody higher plants are often the first to colonize (Fig. 6).

As the arctic organic terrain arises, woody and nonwoody colonizers are well segregated and, when primary, they later associate with thallophytic secondary components to produce the two commonest cover types, FI (nonwoody) and EI (woody by reason of class E).

Observation leads one to conclude tentatively that the nonwoody initiators of organic terrain accommodate to high water table, whereas the woody colonizes in highly variable densities of water content or in the wet areas of low water table (Figs. 1, 3, and 8—nonwoody; Fig. 4—woody). Nonwoody and woody colonizers invade together and persist together as peat forms either where gravitational water fluctuates widely on a seasonal pattern or where it is constantly moving at a rate appreciable to the eye (Figs. 3, 8).



Fig. 6. A flat woody shrub is often a primary colonizer



Fig. 8. A group "island" of foot-high hummocks

Not only is water a significant factor in the initiation of organic terrain, it also appears to be important in initial segregation of organic terrain types and in succession.

Water may also be basic as a limiting factor to the progress of biological interaction (e.g., competition and formation of plant associations). Individuality of either species or plant form or both would seem to be independent of society influence, if indeed the latter is real at all. This is especially suggestive in the light of independence in method of colonization, segregation, biological attitudes in succession, and culmination of successional trends—despite wide range of

temperature, edaphic, and geographic differences.

TOPOGRAPHIC EVALUATION

In separate work [11, 12], the author has dealt with aerial interpretation of organic terrain by which topographic delineation can be appreciated over large areas. In accounting for origin of organic terrain the principles and terminology by which topography is characterized from the air are adaptable. Characteristic macrotopographic and microtopographic features presenting morphological patterns useful in identification and classification are useful in assessing origin. The writer has shown relationship between topography and features of biological organization; it has also been claimed [11, 12] that there is relationship between pattern and vegetal cover type and its distribution. Pattern relates also to mineral sublayer, to prevalence and kind of ice, to development of kind, amount, and shape of organic mass (peat), and to behavior of the water factor in the course of peat history [13].

The initiation of organic terrain in the Arctic is associated with this complex. Micro- and megatopographic differences arise at the onset of organic terrain. The topographic features noted in the south are all found in proximity to the icecap where it is obvious that some of them arose because of precursors reflected in the mineral terrain.

Hummocks (Fig. 8) abound. Mounds are numerous either as isolated or coalescing elements (Fig. 5). Ridges (Figs. 5, 7, 11) are common. Polygons (Figs. 2, 7) also arise. Other features occur, for example sloping and vertical pond margins and subsurface and surficial ice configurations.

Occurrence of hummocks is now accepted not only as a function of plant growth—exemplified by sedges, grasses, occasionally rushes, and mosses sometimes associating—but is also related to freeze-thaw phenomena in fine grained soils. In organic terrain hummocks appear sporadically in groups, and, at the season of greatest melt, are on ground of very low bearing strength. When open water surrounds them, the hummocks appear as islands (Fig. 8).

On occasion the hummocks coalesce at their bases unilaterally. Some evidence of this is seen in the watery background in Figs. 7 and 11, but most of the linear features in these photographs are accountable to other development. Hummocks, therefore, do not commonly associate to form ridges. Their contribution to macrotopography is significant mainly for lack of effect (like the condition produced in the rim of the extrusion to the frozen lobe in Fig. 12, which is featureless) or in the wide bands or "braids" evident in the valley shown in the air photograph (Fig. 9).

Coalescence of unit microfeatures is best appreciated in the study of mounds which arise in relation to cover types shown in Figs. 2, 3, and 5.



Fig. 7. Hummocks and mounds show coalescence and polygonal pattern in organic terrain

A single low mound at a young stage of development is seen in the center of Fig. 3. In time these become larger in width and height, coalesce, and produce ridges of the type in Fig. 5. Hummocks rarely become mounds and certainly the reverse apparently never applies. If there is association between hummock and mound it arises through coalescence and mutual overgrowth to produce effects typified at the edge of the watery background (Fig. 7), and more typically in the outer fringe of ridging in Fig. 11.

This above description accounts only in part for ridge development. Further examination of Fig. 7 shows the formation of polygons of about 2 ft in dia. (foreground). This condition is extended into the region of flood in the background of the photograph. Here the boundaries of the polygons are not always clear because of flooding, but they persist. The vegetation in the boundaries covers shallow peat which deepens at a greater rate in the wetter places to form the major contribution to ridging. This is a coalescing of polygon boundaries. Because some sides of the boundaries produce ridge effect more actively than others random ridging (as shown) arises.

As the ridges increase in size those in close proximity

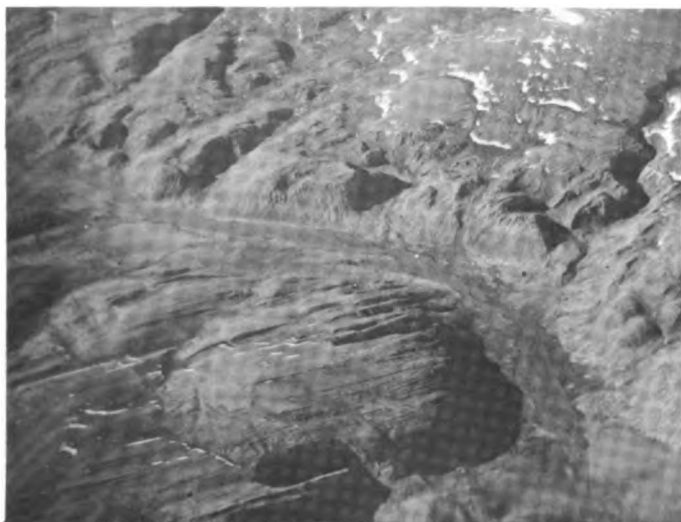

Fig. 9. A "braided" foundation of organic terrain seen from about 800 ft. Hummocks cannot be seen unless they coalesce forming ridges (lower right is an evanescent braid)

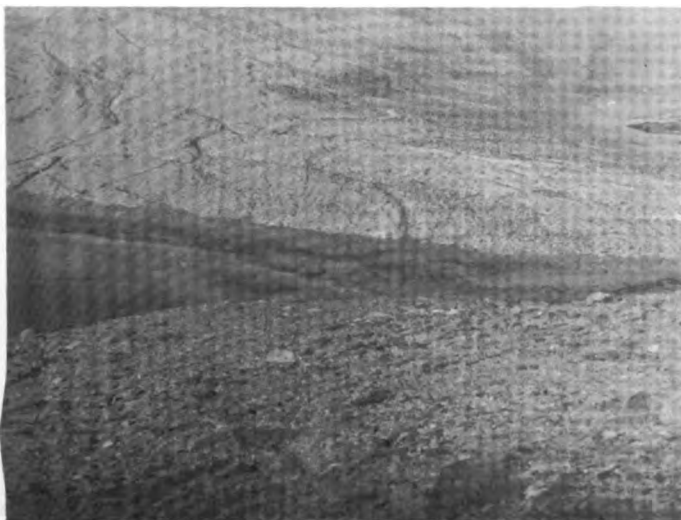

Fig. 10. Ridges in depression of organic terrain show beginning of a reticulated airformed pattern, photographed at about 800 ft

coalesce. This can only result in modifications to the original distribution of water. Eventually a macropattern of ridging (Fig. 9 - lower right; Fig. 10).

Attention is drawn to a comparison of Figs. 2 and 7: The polygons of Fig. 7 contribute to ridging whereas those of Fig. 2 generate a continuing polygonal pattern. Polygons have already been described by the writer [6]. Configurations known as irregular and regular peat plateaus [2] develop from groups of these polygons when a local drainage gradient serves the area. A gradient of this nature is seen at the right and foreground of the polygon group (Fig. 2) where the delineating boundaries fade out.

In the vicinity of Lake Hazen at the foot of McGill Mountain in such an area as that shown in Fig. 2, peat plateaus were developing and the peat was about 20 in. deep. As this occurs, peat formation deteriorates due to lack of sufficient water at the maximum amplitude of depth. At these places in the plateau collapse, subsidence, and wind erosion occur locally; this accentuates the primary irregularity. Also, when drying commences, mounds at the boundary edges (see row of mounds on rims of polygons at the center of Fig. 2) are first to be affected by wind erosion which results in polygons with reddish brown rims in which mounding has been obliterated.

Fig. 2 clearly demonstrates that the polygons on the side of the hill (background) are physically associated with those in the organic terrain in the center. This is convincing evidence that the polygons do not necessarily have their origin in organic terrain and that the effects of polygons in the organic overburden are therefore functions of activity in mineral terrain. On the other hand, polygon boundaries may arise in organic overburden (Fig. 2). Also, the photograph shows that boundary formation is out of line with the two conspicuous series on the hillside. This still does not exclude the possibility of the mineral sublayer possessing the causal factor for polygon formation in the organic overburden. That the organic matter also contributes and may cause boundaries to be initiated cannot be denied. Therefore, macropattern for polygons in organic terrain, like that for ridging, is in part inherent.

Dryas-crowned microfeatures which stipple the faces of the polygons on mineral terrain in Fig. 2 (background hillside) are not perpetuated in the organic terrain. This applies even for a given polygon in which both mineral and organic terrain occur. This supports the view that organic terrain has inherent potential for initiating and perpetuating microtopographic structure.

Aerial Interpretation for High Arctic Organic Terrain

In the context of this work it is sufficient to indicate that established method in aerial interpretation [14, 15] is valid for the high Arctic. Explanations of phenomena associated with vegetal and topographic features offered in the present work should assist photointerpretation following identification, and anticipate the needs of the user.

An example of this assistance is the explanation of the origin of ridging in relation to the airform patterns known as vermiculoid I, II, III, and as reticuloid. The source of the ridging in the airform configuration depends upon amount of water, its dispersal, its gradient, its seasonal relations, and (in the high Arctic) the diurnal effect on volume of melt water. Behavior of the water factor has been shown to control the type of ridging to a significant degree. A proper study of the airform patterns leads to understanding of which edaphic or microtopographic control in mineral sublayers is pertinent, even though these influences are not visible to the airphoto interpreter.

Of the airform patterns characterizing organic terrain when it is viewed from 10,000 to 30,000 ft [16], dermatoid (Figs. 9 and 12) and reticuloid (Figs. 9 and 10) are now known to apply for high Arctic study. Terrazzoid, stipplid, and marblid are apparently lacking. In the author's opinion terrazzoid is arising especially in southern Ellesmere where lichenaceous cover is more extensive, but the areas of incidence are so small that they escape notice. The same applies

for marbloid which at lower altitudes is often seen to have polygoid [12] as a constituent. Stipploid, of course, exists only when trees or aggregates of shrubs are present as components of cover—a condition not obtaining for the high Arctic.

ICE IN ARCTIC ORGANIC TERRAIN

The author's expression, "climafrost," [2] was used to define a perennial condition of frozen ground, which on the one hand was not permanent and which by definition and inference was not seasonal as is active frost. Frost pertains in this instance to temperature, not ice; the latter is from time-to-time an effect of subzero ($^{\circ}\text{C}$) ground temperature.

It is the ice effect that is usually significant in organic terrain studies because gravitational, capillary, or hygroscopic water, separately or in combination, must be considered where organic terrain exists.

In the organic terrain of the high Arctic, ice (as derived from active frost, climafrost, and permafrost) plays a significant role. Where mountains or high hills are present, as they are on Ellesmere Island, the snows under 24-hour sunlight soon disappear in summer, and the water from that source rapidly reaches the lakes or sea. Because precipitation is not excessive in the growing period, the significant excess water comes from residual snow drifts and icecap country. Where permanent ponding is lacking this summer-long supply serves the low lying areas, continuously moistens the terrain in many areas, and facilitates the formation of organic terrain. This source of water is markedly augmented by differential thawing of either the ice of active frost or, to a lesser extent, of climafrost. Hence, high Arctic organic terrain depends largely on either surface or subsurface ice for its initiation and development.



Fig. 11. Ridges forming at edge of open water in organic terrain



Fig. 12. Dermatoid airform pattern at edge of a frozen lake (see dark patch off the end of the finger-like lobe of ice)

Depth to ice in late summer in the mineral sublayer has not been studied intensively; but it is known that beneath polygons overlain with the deepest peat depth to ice is least. Where hummocks occur, depth is greatest; where there are drainage gradients the depths are intermediate. Therefore, depth from the surface of the ground to the top of permafrost ice in summer behaves differentially; the geomorphology of the subsurface ice mass is in part controlled by presence, kind, and depth of organic terrain above it.

To the extent that organic terrain is present in high Arctic landscape, the onset, distribution, and development of erosional patterns will be affected. Partly because of this, and because it is seldom that microtopographic structure on mineral terrain buried beneath the organic is lacking, it is unreasonable to conclude that for the south the subtending mineral terrain surface beneath the organic is necessarily flat, concave, and featureless.

Finally, as time advances and distance from the ice face increases, direction and amount of either seepage or free flow of surface and subsurface water will change (there is evidence to prove this on Ellesmere Island). If this change is considerable, it is likely that it will affect the type of organic terrain under formation. In these cases an evolution in vegetal succession will take place. Examples in which such change arises would be detected best, far from the icecap, where time would be sufficient to allow for the process of change. It is significant that such changes are recorded in certain microfossil spectra for the Fort Churchill area [8]. The deposits on Ellesmere are probably too young to reflect evolution in succession, but further exploration is required to substantiate this.

DEVELOPMENT OF PEAT STRUCTURE

The classification of organic terrain encompasses mechanical structure of peat reflected in botanical terms. The sixteen categories of structure [5] are not all represented in the high Arctic. If they were, one might expect to find all the airform patterns also represented.

Woody fine fibrous peat occurs where peat plateaus are developing and it is here that lichens (Fig. 5) arise—(Class H in cover classification). Between the top of the subsurface ice and the lichens there is usually enough water present to maintain peat development, but the drying effect that accompanies local collapse seems to coincide with local appearance of Class H. This class, therefore, not only marks the position of topmost amplitude of subsurface ice conformation, it also serves as an indicator of this condition occurring in relatively dry woody fine fibrous peat.

To the south, on the Arctic mainland, this condition is more widespread and covers exceedingly large areas—being first to convey a terrazzoid condition [14] and further south, a marlboid condition. For all conditions the H factor in organic terrain is apparently a sure index of presence of geomorphic peaks in permafrost ice. It disappears near the icecap front in the north and at the southern fringe of permafrost in the south.

Amorphous-granular and nonwoody fine fibrous peats are commoner in the high Arctic and occur at the edge of the icecap near the northern ice pack at altitudes greater than 1000 ft. From mid- to late summer nonwoody fine fibrous peat marks the positions of gradients on subsurface ice slopes, and the amorphous-granular peat occurs above the extremities of concavities in the subsurface ice contour. Where a woody fibrous constituent arises, slope of subsurface ice contour intensifies in the sense that the ice surface draws nearer to the ground surface.

The relationship between vegetal cover type, (the indicator of past structure type), and subsurface ice contour has yet to be explained. Whatever the explanations, they are essential for an understanding of the dynamics of geomorphology on both a long and short term (seasonal) basis. The study is attractive too because it lends itself to aerial interpretation.

ACKNOWLEDGMENTS

The aerial studies in this investigation were supported by the Defense Research Board of Canada (Geophysics Section). Ground interpretation was assisted by the National Research Council of Canada.

REFERENCES

- [1] I. C. MacFarlane. "A Preliminary Annotated Bibliography on Muskeg," *Biblio. No. 11*, Natl. Res. Coun., Ottawa, 1955.
- [2] N. W. Radforth. "Suggested Classification of Muskeg for the Engineer," *Eng. J.*, Montreal, Vol. 35, 1952, pp. 1-12.
- [3] H. R. N. Eydé. "An Assessment of Component Tissues of Peat," Ph.D. thesis, McMaster Univ., 1961.
- [4] J. M. Stewart. "Interpretation of Organic Terrain by the Cuticular Components of Peat," *ibid.*, 1963.
- [5] N. W. Radforth. "Range of Structural Variation in Organic Terrain," *Trans. Roy. Soc. Canada*, Ser. 3, Sect. 5, Vol. 49, pp. 51-67.
- [6] N. W. Radforth. "Palaeobotanical Method in the Prediction of Subsurface Summer Ice Conditions in Northern Organic Terrain," *ibid.*, Vol. 48, 1954, pp. 51-64.
- [7] N. W. Radforth. "Organic Terrain and Geomorphology," *Can. Geog. 6*, Vols. 3-4, 1962, pp. 166-171.
- [8] N. W. Radforth, L. Suguitan. "Definitive Microfossils Pertinent to Physiographic Difference in Muskeg," *Trans. Roy. Soc. Canada*, Ser. 3, Sect. 5, Vol. 53, 1959, pp. 35-41.
- [9] N. W. Radforth. "Distribution of Organic Terrain in Northern Canada," *Proc. 7th Muskeg Res. Conf.*, Ottawa, 1961.
- [10] L. Suguitan. "Palynological Evaluation of Five Muskeg Landscape Patterns," Ph.D. thesis, McMaster Univ., 1963.
- [11] N. W. Radforth. "Organic Terrain Organization from the Air," Handbk. 1. (Altitudes less than 1000 ft), Defence Res. Bd., Ottawa, D. R. No. 95, 1955.
- [12] N. W. Radforth. *ibid.*, Handbk. 2. (Altitudes 1000-5000 ft), Ottawa D. R. No. 124, 1958.
- [13] N. W. Radforth. "Soils of Canada," *Organic Terrain*, Roy. Soc. Canada, Spec. Publ. No. 3, ed. R. F. Leggett, Univ. Toronto Press.
- [14] N. W. Radforth. "Application of Aerial Survey Over Organic Terrain," *Roads Engr. Constr. Mag.*, Natl. Res. Coun., No. 42, Ottawa, 1956.
- [15] N. W. Radforth. "Principles of Airphoto Interpretation as Related to Organic Terrain," *Intl. Peat Cong.*, Leningrad, USSR, 1963.
- [16] N. W. Radforth. "Airphoto Interpretation of Organic Terrain for Engineering Purposes," *Trans Symp. Photo-Interpretation*, Intl. Archives Photogrammetry (Delft, Holland), Vol. 14, 1962, pp. 507-513.

TURF HUMMOCKS IN THE MESTERS VIG DISTRICT, NORTHEAST GREENLAND

HUGH M. RAUP, Harvard University

Turf hummocks are abundant in the Mesters Vig district and form so conspicuous a feature in the landscape that any analysis of the vegetation requires that they be dealt with critically (Fig. 1). They are widespread and common in subpolar, alpine, and many temperate lands throughout the world.

Hummocks, in general, are of two kinds. First, are those formed by the proliferation of single plants of *Caespitose* species, usually of grasses and sedges. Though widespread in the world, this kind is especially well developed in western arctic Canada and Alaska, where studies of it by Hopkins and Sigafos [1] are definitive. The second type is composed primarily of various species of mosses. These hummocks are formed by the radial proliferation of mosses from central starting points to more or less dome-shaped masses. This is by far the most common type and is the only one found in the Mesters Vig district.

ORIGINS

In a common form of the turf hummocks at Mesters Vig (Figs. 1, 2), the living portion of the mosses forms a cap 2.5 to 5 cm thick on the top. It grades downward into a layer of dark brown to black, root-filled turf of varying thickness depending on hummock size. At its base the turf commonly merges into a greasy, fine textured humus layer which usually is only 2 to 3 cm thick. Beneath this humus, and forming a roughly conical or dome-shaped core of the hummock, is a mass of stony loam similar to that underlying the surrounding surfaces.

A common vascular flora for a hummock of this kind shows a rather dense cover in which *Vaccinium uliginosum*, *Salix arctica*, and *Carex Bigelowii* are primary species. Secondary species might be *Cassiope tetragona* and *Polygonum viviparum*. Most of the vascular plants are rooted in the turf, though a few roots of the woody species are sometimes found to shallow depths from 5 to 15 cm in the mineral soil immediately beneath. The single exception is the willow (*Salix arctica*), which almost invariably sends a rather simple stout root downward into the mineral soil and then laterally, more or less parallel to the ground surface at depths of 5 to 15 cm. This root may extend outward two meters or more from its point of origin, far beyond the limits of its turf hummock.

Such hummocks present problems for the geomorphologist as well as for the student of vegetation, for they contain micro-relief features in the mineral horizons as well as variations in plant cover. Research literature on them is extensive, but scattered. Much of the geological research is summarized in papers by Sharp [2], Troll [3], and Washburn [4], but no similar reviews of botanical literature seem to be available.

Geomorphologists have considered the hummocks as frost-induced "patterned ground," and Washburn [4] classified them as "non-sorted nets." A few botanists, such as Griggs [5], Hanson [6], Sigafos [7], and Billings and Mooney [8], have studied their structure and development, but most others who have noticed them have treated them in terms of their surficial vegetation. They have been variously classified as: *heath* - *Oosting* [9], *DeLesse* [10], (in part), *Hanson* [6], *Griggs* [5];



Fig. 1. Well-developed, mature turf hummocks in the Mesters Vig district, Northeast Greenland

moor - Böcher [11], Steindorsson [12]; marsh (drier phase) - by Polunin [13].

Those who have expressed opinions on the relation of hummocks to depth and duration of snow cover (Böcher [11, 14], and Polunin [13]) have regarded them as snow patch vegetation.

Those who have attempted to apply successional concepts in the tundra have invariably placed well-developed hummocks near the "climax," usually calling their vegetation a "sub-" or "pre-climax." Griggs [5] thought that hummocks in the Katmai region of Alaska formed a "permanent subclimax" dating from shortly after the disappearance of the last ice.

Dissections and observations of a large number of turf hummocks in the Mesters Vig district brought out the following facts:

Well-defined, growing hummocks are found only on sites abundantly supplied with gently flowing surface water throughout most of the frost-free season. They may be common on

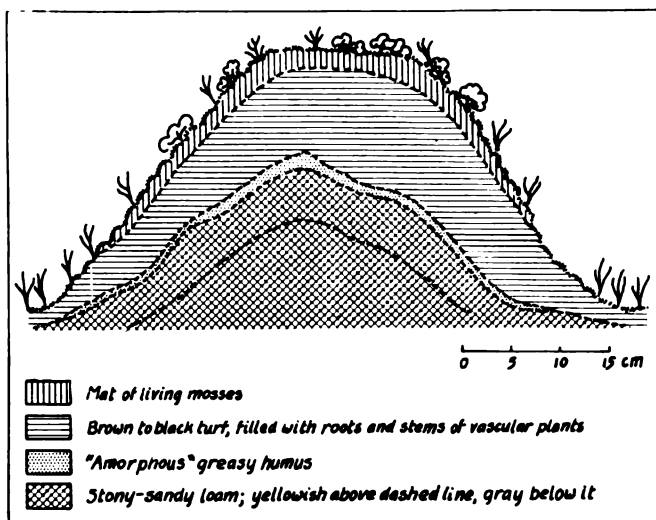

Fig. 2. Cross section of a mature hummock developed on fine textured soil and containing an earth core

drier sites, but here they are always in some state of disintegration.

They are found on any kind of soil, from gravel to clayey silt or stony loam, and on slopes of from 1° to 15°.

They may or may not have earth cores. If well-defined cores are present, the underlying mineral soils usually are fine textured ones—the silts and silt loams. If sandy material is found in the cores, the hummocks containing them are usually situated in stream channels where flood water has partially submerged them and deposited sand during early stages of hummock growth.

In some areas underlain by fine textured soils, the earth cores appear to have predated development of the hummocks, at least in embryo. These cores were formed on the fronts of small gelifluction lobes, so that hummocks which later grew over them may show ridged or arcuate patterns. The term "gelifluction" is here used to mean solifluction in association with frozen ground.

There is marked asymmetry in well-developed hummocks, oriented to the direction of the slope. Their upslope sides are steepest, in places almost vertical, while their lower sides taper off more gradually.

Due to insulating properties of the turf, mineral soils in the interiors of the hummocks freeze later in the autumn than those in the inter-hummock areas, and remain frozen much later in spring and early summer.

Hummocks range in size from small ones only 5 to 10 cm high and broad, to large ones 50 cm high and more than a meter broad at the base.

Basic requirements of slope and water supply for hummock growth in the Mesters Vig district are found mainly in two kinds of places. The first is in the broad networks of shallow channels or sheet runoff areas on the till and gelifluction deposits on mountain flanks. The second, and most extensive, is on long gentle slopes extending from the shores of Kong Oscars Fjord up to the bases of nearby hills and mountains. In both cases sources of necessary moisture are perennial snowdrifts or meltwater from thawing ground, primarily the former. Summer precipitation is insignificant in most years.

In mountain-stream channels, the spacing of hummocks usually is wide, but actively growing hummocks on the lower slopes are closely spaced. Deteriorating ones are nearly always widely spaced and have their vascular flora reduced to a single species, the arctic willow. In the late stages of disintegration they become low piles of twigs and organic rubble.

Because mosses form the basic component of hummock turf, it may be assumed that they figure predominantly in the initial stages of the turf accumulation. Further, because hummock growth is closely associated with abundant surface water, it may be assumed that aquatic mosses are highly significant to the incipient stages of hummock growth. However, hummocks do not begin to have appreciable volume or height until more mesophytic mosses appear on them; but before this can happen there must be some kind of "eminence," or "microelevation" above the uniformly wet surfaces. This sequence in the mosses is, of course, not new, for suggestions of it are found in the works of several students such as Holtum [15], Harmsen [16], Oosting [9], and Hanson [6]. But the origin of the small "microelevations" has been given little attention.

In shallow channels of mountain streams the small micro-relief features are likely to be stones over which the mosses grow as thick caps, or they may start with a small deposit of sand or silt in an eddy. This acquires a mat of mosses which enlarges and becomes impregnated with more sand and silt to form the core of a hummock that gradually grows to large size. A few species of mosses form more or less hemispheric polsters which are the initial stages of hummock growth, but they are not abundant in the region; they are more or less restricted to springs, or to extreme snow-bed situations just below snowdrifts. The upfreezing of stones in wet, fine textured soils takes place rapidly and frequently. This process first domes the surface, and eventually the stones break through. It is a valid source of small microrelief, and hummocks are occasionally found that have such stones projecting into their turf. Al-

ready mentioned is the development of hummocks over the pre-existing microrelief of small gelifluction lobes.

But when all the turf hummocks (of origins dealt with thus far) are added together, only a fraction of the total visible in the Mesters Vig landscape are accounted for. On the long gentle slopes bordering Kong Oscars Fjord, rising to altitudes of 30 or 40 m, are great fields of them on surfaces that are essentially devoid of any system of microrelief that can account for the origin of dense aggregations that occur or have occurred there.

At the bases of hills subtending these slopes are perennial snowdrifts. Meltwater from drifts issues from them on broad fronts, and flows out over the relatively smooth slopes in sheets. In summer it waters these surfaces to only limited distances below the drifts, perhaps a hundred meters or so, and the soils become progressively drier downslope.

ONE HUMMOCK AREA

One of these situations is here described in some detail (Fig. 3). The slope is underlain by a pebbly clayey marine silt which, toward the hills, is mingled with sandy materials derived from sandstones that form these hills. The silt is wet and mire-like during spring and early summer thaw. Its surface becomes dry and brittle in mid- and late summer. It is formed into nonsorted, domed polygons 0.5 to 1.5 m in diameter, separated by deep cracks and these in turn are subdivided into lesser polygons. Near the base of the hills the sandy material appears to have been spread out over the silts which have been pushed up through the sandy material by frost action to form irregular bare patches in the sandy area which has, itself, only a thin vegetation cover. Immediately below a snow drift at the slope's top, about 1.5 km from the shore of the fjord, is a conspicuous bright green patch of vegetation.

Just below the melting margin of the drift is an extreme snow bed situation characterized by a crust of dead, blackened moss, and a few scattered living moss polsters, some of which are hummock-like and have *Salix arctica* growing on them

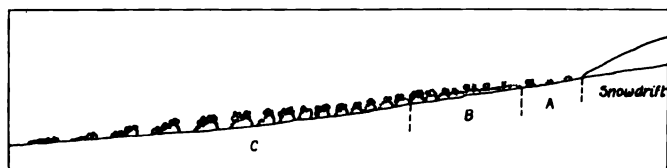

Fig. 3. Transect of a turf hummock system developed on a long gentle slope below a perennial snowdrift

(Fig. 3, zone A). This zone generally gives way to a nearly continuous mat of aquatic mosses among which are a few marsh grasses, sedges, rushes, and cotton grasses (Fig. 3 B). The site is saturated, with water standing in small pools and seeping through it. In the upper part of this zone there is practically no microrelief in the surface of the moss mat. Toward the lower part, however, there are low convexities in the moss surface.

These low mounds, which form where the moss mat is 5 to 10 cm thick, have more mesophytic mosses in them, and are the substratum for several species of vascular plants that are common on hummocks: *Salix arctica*, *Dryas octopetala*, *Vaccinium uliginosum*, *Polygonum viviparum*, *Cassiope tetragona*, *Saxifraga oppositifolia*, *Pedicularis hirsuta*. Marsh plants of moss mat are also present, but the more aquatic of these, such as *Eriophorum* and *Juncus*, begin to be more common in low areas between mounds. Water is fairly evenly spread in most of this zone, but toward the lower margin it begins to be more distinctly confined to fixed channels among the low mounds.

This mossy meadow below the snow bed appears to be a crucial one in the genesis of the turf hummocks. Minor elevations in the mineral soil surface easily give rise to a few of the low moss mounds, but there are not nearly enough of them

to account for all that develop. Where vascular plants occur they become centers for the accumulation of humus, and thus raise low mounds. But other mounds seem to be due merely to irregularities in growth rates of the aquatic mosses themselves.

Downslope from this zone hummocks are progressively better defined as separate units (Fig. 3 C). Meltwater is rather firmly confined to channels between the hummocks, and becomes dispersed over a progressively wider area. During the spring thaw the channels usually are full; but later in the season they are only moist, for late summer snow melt does not reach this far downslope.

Mosses in these hummocks begin to show some mortality due to summer desiccation, and are more easily eroded by the now channeled meltwater in the ensuing spring. Hummocks here begin to show the asymmetry oriented to slope that had been mentioned. Deterioration is progressively more evident still farther downslope, where a gradual weeding out produces wider spacing among a few degraded relics. Presumably the first to go are those least firmly held together by matted stems and roots. Finally, on the dry slopes beyond the reach of any appreciable summer moisture, hummock mosses disappear completely (Fig. 4).

It would be well at this point to consider the thermal regimes that attend these changes. It is now generally agreed that earth cores develop or are accentuated under some turf hummocks as the latter grow in size, and that the major process involved is differential freezing and thawing. Because the soil under the thicker layers of moss and turf in the central parts of hummocks freezes considerably later in autumn than the bare or thinly covered soil between hummocks, and because the latter soil freezes from the surface downward in the presence of a firm subsurface horizon such as permafrost or bedrock, lateral pressures are set up which force material upward in still unfrozen areas under the thick turf layers.

In the developmental sequence here proposed for turf hummocks, nothing could be expected to happen in the production of earth cores until there were pronounced differentials in the thickness of the moss and turf, and until flowage channels had clearly defined the hummocks and broken the continuity of the moss mat. It is significant that no trace of earth cores could be found under small hummocks 10 cm high formed in this way, even over fine textured clayey silts.

Presumably the process of bulging up the earth cores, once started, could go on so long as there was enough moisture in the soil for freezing and consequent pressure effects. In this instance it certainly would be decreasingly effective downslope,



Fig. 4. Later stages of hummock deterioration

but the point at which it would cease to function is unknown. One effect of raising earth cores is to increase the height of the hummocks, and thus to increase the rate of desiccation of the mosses. Injury by frost heaving to the roots of plants growing in the inter-hummock areas probably reaches its height in this period of growth in the earth cores.

Thus far, a transect (Fig. 3) is described here as if it embodied a process of change. It is merely inferred that the segments of the transect were stages in the process. This can have no justification until time can be inserted into hummock development, so that one does not have to substitute space for time in the analysis.

A notable feature of the degrading hummocks is the reduction of their vascular flora essentially to a single species, *Salix arctica*. Where disintegration of hummocks is complete, the only things left to mark their former presence are the willows, still living, that formerly grew on them (Fig. 5). That these willows had their origin in former hummocks is shown by the fact that the bases of their stems are well above the ground surface, so that their roots are commonly exposed as much as 5 to 15 cm before entering the soil. For a time upper portions of the willow roots were thought to have been exposed by frost heaving. Dissections of turf hummocks were made in order to compare growth forms of the roots above and below ground. Roots in the hummock turf were found to resemble those in the raised willows closely. Though heavier and simpler than the stem systems, the roots tended to show sharp angles and crooks in their growth direction. In contrast, roots of *Salix arctica* that are below ground are usually long and relatively straight. Those heaved out of the soil by frost in active stone nets show this.



Fig. 5. Living willow (*Salix arctica* Pall.) with the upper part of its root projecting above the surface of the ground

SIGNIFICANCE OF WILLOWS

Willows with raised stem-bases, here called "perched" willows, are extremely common in the Mesters Vig area. On the slope here described they can be picked up in thousands. In the 1958 season, 68 specimens were gathered in an area of perhaps 50 acres beginning in the lower part of the widely spaced deteriorating hummocks and extending over the dry slopes below and on either side of them.

Although willow growth is exceedingly slow, the annual rings or zones of growth are easily seen under a microscope. The annual increments, however, are commonly discontinuous around the central axis. To find the age of a root or stem, therefore, it is necessary to select the radius that has the most rings or parts of rings. The oldest willow collected in this area germinated about 1852, but the oldest of which we have record in the Mesters Vig district germinated about 240 years ago.

Irregularity in the amount of annual increment is the rule among these willows. Regularity, even for periods as short as 10 or 15 years, is rare. Irregularity usually takes one of two forms. Scattered throughout are occasional very narrow rings, occurring singly or sometimes two together. The next ring following these very thin ones usually is equivalent in thickness to the preceding ones. The other common irregularity is a major suppression in growth rate that appears suddenly, with a series of thin rings, followed by thickening of the annual increment which may or may not get back to what it was before the suppression.

Whatever the cause of the first type of irregularity, perhaps unusually short growing seasons such as are known to occur, it seems to have no serious effect upon general growth performance. Suppressions, on the other hand, seem to cause serious depletions in the vigor of the plants. The sudden appearance of suppressions, and the commonly slow rate at which the plants recover from them, argue for their being due to injury of some kind. Some injuries are obvious, for the roots and stems are gnawed by rodents, sometimes nearly girdled. Less evident injuries, though probably no less significant, could be caused by frost heaving of the roots. Excessive desiccation in unusually dry summers might cause some injury, but this is doubted because there is always a small residue of moisture in even the driest of soils 10 to 15 cm deep.

The first chart gives basic data for the 68 specimens collected in 1958 (Fig. 6). On the left side are the specimen numbers. Time, in 5-year intervals, is marked at the top of the chart, with the more recent at the left and the year 1860 at the extreme right. Opposite each specimen number the rectangular black spot indicates the germination year, while the crosses at irregular intervals give dates at which suppressions appeared in the growth rings.

By adding the number of origins in each year, and then adding these totals cumulatively from right to left, the second chart was produced (Fig. 7 A). Here the same time scale is used, but at the left is a scale showing numbers of plants from zero at the bottom to 68 at the top. Using cumulative totals of origins, by years, points on the curve show the numbers of these willows that were in existence in any year since 1860. In 1910, for example, about 30 were in place and growing, but in 1900 there were only half that number.

Invasion of this part of the slope by *Salix arctica* appears to have been slow until about 1900, for it took the preceding half century for 15 of these willows to become established. The curve shows that the period of most abundant establishment was between 1900 and 1930, but a notable rate decline occurred after 1923. During this 30-year period about 65% of the willows appeared. Nearly all were there by 1935, and there were no more origins after 1941.

A third chart was made by adding the number of suppressions for each year and plotting them on the time scale as simple sums, not cumulatively (Fig. 7 B). A total of 162 suppressions was recorded for all years. The chart indicates that suppressions began as early as 1880, when there were only five plants to record them. They were infrequent, however (one to three per year), until the mid-1920's, even though by that time about 55 plants were available to show them. In 1925, when over 80% of the plants were already established, only about 21% of all suppressions recorded had occurred. After the mid-1920's they came with an increasing frequency which continued until 1958. Nearly half, 48%, were recorded after 1941, when the last of the willows become established.

Another way of showing this is to chart the suppressions cumulatively, and compare the trends of their curve with those of the population curve (Fig. 8). The suppression curve remains low until about 1923, when the curve of population increase had nearly reached the end of its steepest pitch. Then the suppression curve begins the rapid rise that continues until 1958. After 1923 the curve of population increase begins to fall off. It is strongly suspected that this period of notable breaks in curves was coincident with the segregation of the hummocks into units separated by bare channel areas, which in turn made the hummocks more suitable habitats for gnawing rodents, brought about the conditions for differential freezing

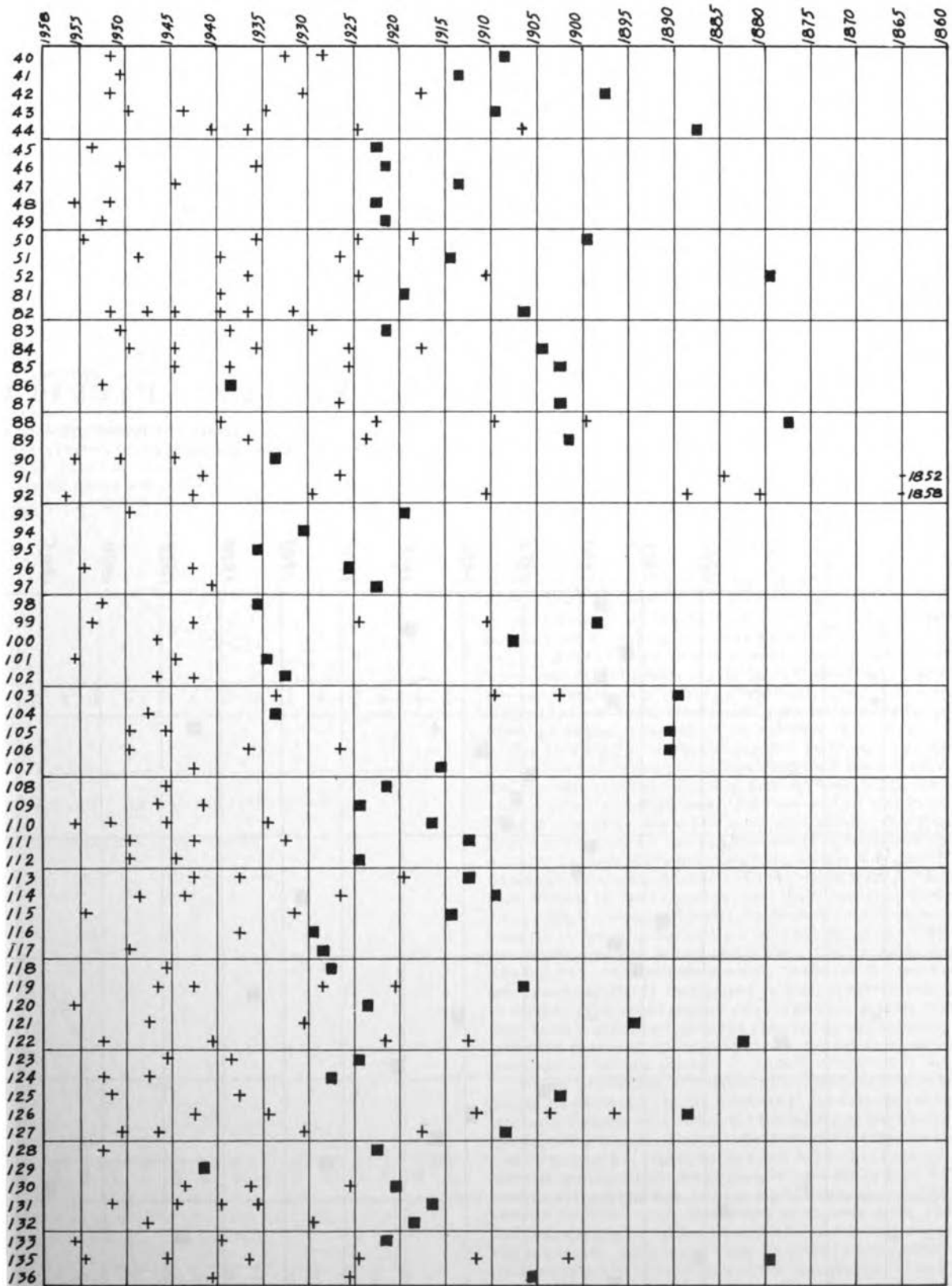

Fig. 6. Dates of origin of 68 living perched willows collected in 1958 (solid blocks) and dates of suppressions in their growth rates (plus signs)

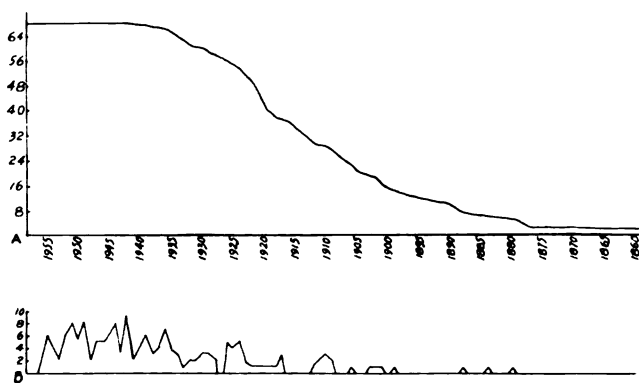

Fig. 7. Section A: Curve of cumulative population growth of 68 plants;

Section B: Total suppressions by years

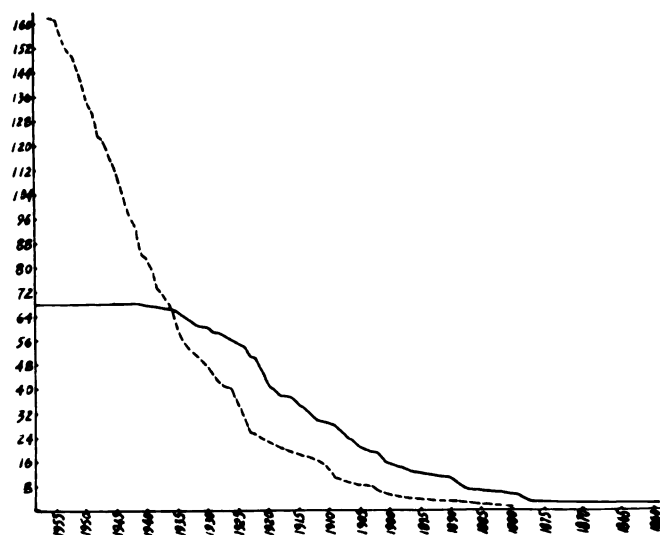

Fig. 8. Dashed curve of suppressions (added cumulatively) is compared with solid curve of population

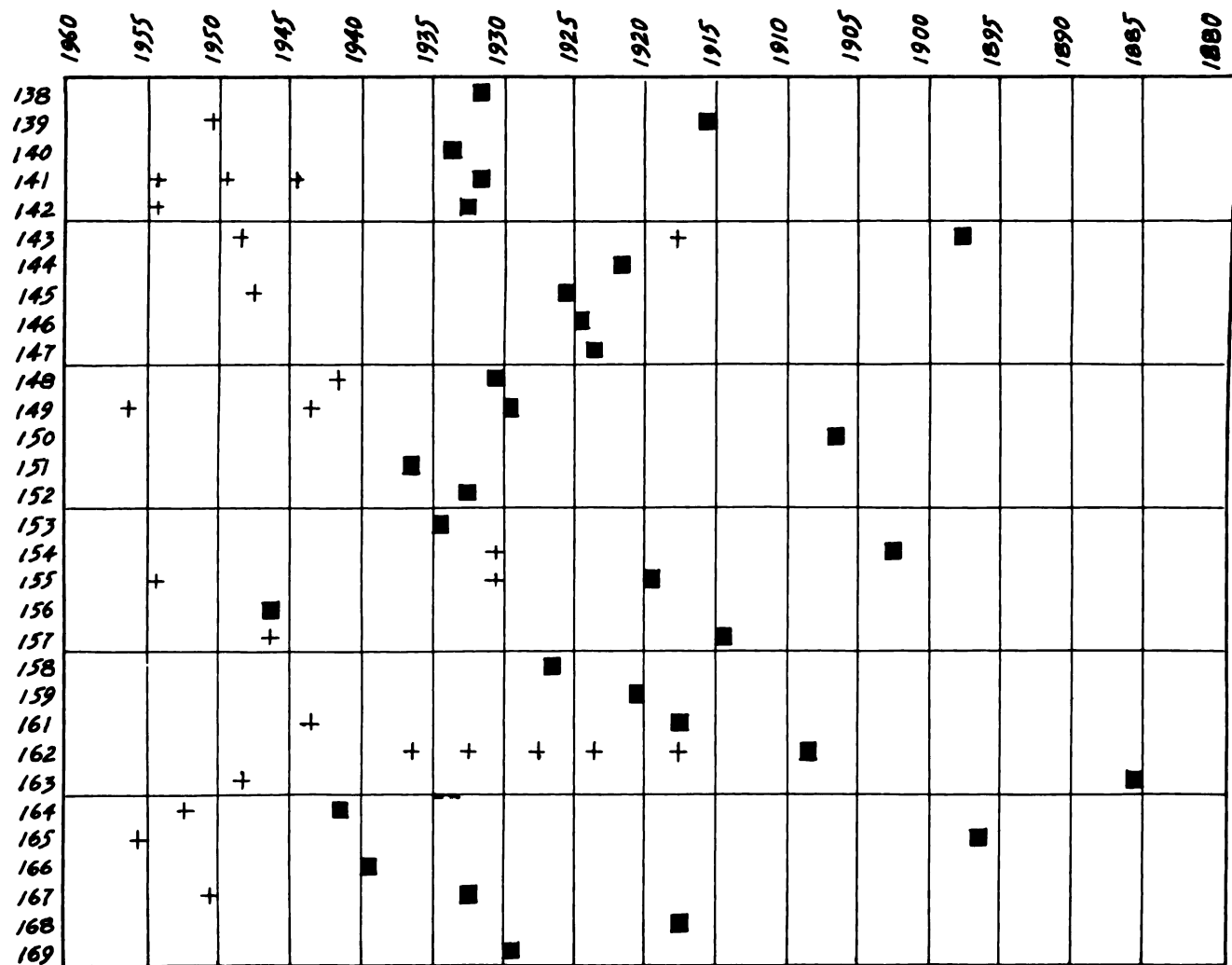

Fig. 9. Dates of origin (solid blocks) and dates of suppressions (plus signs) of 31 living willows collected in 1960

and thawing that produced the earth cores, and set the stage for frost damage to roots.

Field notes for the collection area, as for many others of similar nature, carry the expressions "high mortality rate" or "as many dead willows as living ones." Evidence in sections of the living plants, coupled with the obvious mortality seen on the ground, shows that a certain percentage of the willows now fail to survive the suppressions each time they occur, and that the population is losing ground very rapidly indeed.

Most of these willows, judging by what is known of their structure, must have germinated 5 to 10 or 15 cm above the present ground level, in the surface of a saturated, mossy, slightly hummocky meadow. This meadow must have extended widely over this slope. Evidence that the willows appeared so early, and lived through early as well as later stages of turf hummock growth and disintegration, is in their forms and growth patterns. If they had germinated on the tops of hummocks 20 to 40 or more cm high, their now exposed roots would be much longer. Consequently, they must have become established when the hummocks were very small or almost nonexistent in the moss mats. The correlation between timing of the probable development of hummocks as well-defined units, and that of the rapid increase in number of suppressions, is at least presumptive evidence.

This was checked by a great deal of data. Thirty-one more specimens of roots and stems were collected and sectioned in 1960, this time from a saturated hummocky meadow a short distance below the snowdrift (Figs. 9, 10). This area simulated

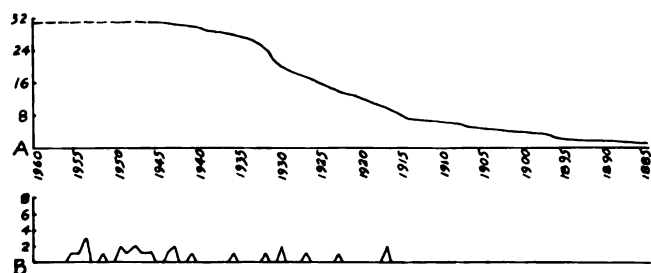

Fig. 10. Section A: Curve of population growth;

Section B: Suppressions in 31 willows

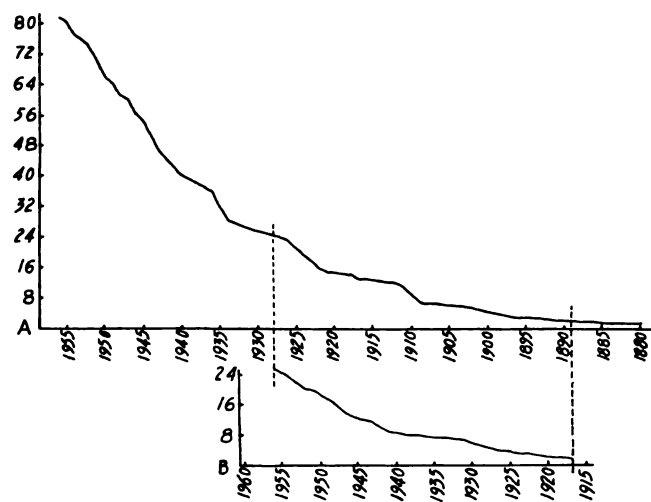

Fig. 11. Section A: Curve of suppressions in Fig. 6;

Section B: The curve of suppressions in Fig. 9, added cumulatively

the growing conditions for willows that presumably obtained over a great deal of the slope about 1910 or 1920. The cumulative curve for suppressions in these willows, which begins with 1917 and continues up to the present, is duplicated in a curve for 31 of the perched willows only in a period of equal length ending in the mid-1920's (Fig. 11).

DEVELOPMENT AND DECLINE OF HUMMOCKS

The principal change that seems to have occurred on the slope has been the reduction of its water supply. Because the main water source is summer thaw from perennial snowdrifts, these drifts are presumed to have been greatly reduced during at least the last 40 years. A great deal of evidence has accumulated for a general amelioration of the climate around the North Atlantic basin in the last 75 years [Koch 17]. This would have the effect, on the slope discussed here, of progressively reducing the size of the snowdrifts available to supply summer meltwater, of eliminating others, and in general, of promoting desiccation.

Turf hummocks have probably developed and deteriorated as inferred from the transect, and most or all of the sequence has been "lived through" by individual willow plants. Apparently, the whole sequence can be completed in 60 years, and probably in 30 or 40 years. Some progression in space, or "up-slope" migration of wet-meadow, turf-hummock systems probably has occurred as the fronts of the snowdrifts have retreated.

The chronology suggested for this single case is not likely to apply widely, except that all or most of the hummock systems in the Mesters Vig district probably have developed within the climatic amelioration of the last 75 years. Within this period any stage or combination of stages could be prolonged or shortened by variations in slope, insolation, water supply, or the nature of the soils. Hummocks developed on other kinds of terrain will show different sequences. Shifts in drainage patterns due to various mass wasting phenomena are frequent and sometimes violent in this district. Such a shift can stop the growth of a hummock system in midcareer, or rehabilitate one in a late stage of decay. Presumably a general enlargement of the snowdrifts would simply move the systems back down the slopes, expanding them at the same time.

The Mesters Vig turf hummocks look as though they were primarily vegetational phenomena, and their vegetation has the appearance of near stability that has been attributed to similar structures elsewhere. But their natural history shows them to be only transient and perishable things. Their mesophytic mosses have a flash of success for a time, and actually account for most of the hummock volume; but they have to do this quickly before the erosional and thermal machinery, that they produce by their dense growth, their insulating properties, and by the channelling of water, isolates them and raises them too high in the air. Desiccation then begins to injure them, making their erosion easier and faster. The hummocks are in part built by, and eventually wholly destroyed by, physical processes which they themselves by their presence help to set in motion. The seeds of their destruction are present from the early growth stages for once the channelling and erosion start, given the overweening influence of the retreating water supply, there can be but one ending.

The whole complex of interacting processes, from beginning stages to dissolution of the hummocks, runs its course in time intervals that are well within the life spans of the longer lived plants of the tundra. Biological succession in the hummocks, if it occurs at all, is fragmentary and of no consequence. Most of the vascular plants concerned are drawn from that curious and surprisingly large group of arctic species that seem to be more or less insensitive to environmental gradients. The vascular plants appear when the hummocks are quite small and saturated. They last as long as there is any appreciable moisture at all in the turf, but in the last stages of hummock decay, the moss and turf are thoroughly dry, and there remain only the willows, the most tolerant of all.

ACKNOWLEDGMENTS

The present paper is a résumé of a more detailed one for the

Meddelelser on Grønland. I am indebted to the editors for permission to use this material, and particularly for the use of certain text figures.

Materials for the discussion of turf hummocks were accumulated during the field seasons of 1956, '57, '58, and '60 in the Mesters Vig district in Kong Oscars Fjord, Northeast Greenland. I am greatly indebted to my wife who assisted me in all of the field work, and to Dr. A. L. Washburn, a keen student of arctic geomorphology with whom I collaborated in the Greenland research, and with whom I have had many discussions of mutual problems. The National Science Foundation has been most generous in supplying funds for travel to and from Greenland.

REFERENCES

- [1] D. M. Hopkins, R. S. Sigafos. "Frost Action and Vegetation Patterns on Seward Peninsula, Alaska," U.S. Geol. Survey Bull. 974-C, 1951, pp. 51-101.
- [2] R. P. Sharp. "Soil Structures in the St. Elias Range," J. Geomorphology, Vol. 5, 1942, pp. 274-301.
- [3] C. Troll. "Strukturboden, Solifluktion und Frostklima der Erde," Geol. Rundschau, bd. 34, 1944, pp. 545-694. Eng. transl. by H. E. Wright, Jr., publ. as Transl. 43, U.S. Army SIPRE, 1958.
- [4] A. L. Washburn. "Classification of Patterned Ground and Review of Suggested Origins," Bull. Geol. Soc. Am., Vol. 67, 1956, pp. 823-866.
- [5] R. F. Griggs. "The Vegetation of the Katmai District," Ecology, Vol. 17, 1936, pp. 330-417.
- [6] H. C. Hanson. "Vegetation and Soil Profiles in Some Solifluktion and Mound Areas in Alaska," Ecology, Vol. 31, 1950, pp. 606-630.
- [7] R. S. Sigafos. "Soil Instability in Tundra Vegetation," Ohio J. Sci., Vol. 51, 1951, pp. 281-298.
- [8] W. D. Billings, H. A. Mooney. "An Apparent Frost Hummock - Sorted Polygon Cycle in the Alpine Tundra of Wyoming," Ecology, Vol. 40, 1959, pp. 16-20.
- [9] H. J. Oosting. "Ecological Notes in the Flora," in "The Coast of Northeast Greenland," by L. A. Boyd, Am. Geog. Soc. Spec. Publ. 30, 1948, pp. 225-269.
- [10] H. DeLesse. "Flore et Vegetation de l'Ege, Groenland," Actualités Scientifiques et Industrielles, 1180, 1952, pp. 1-143.
- [11] T. W. Böcher. "Studies on the Vegetation of the East Coast of Greenland between Scoresby Sound and Angmagssalik," Medd. om Grøn., bd. 104, No. 4, 1933, pp. 1-32.
- [12] S. Steindorsson. "Studies on the Vegetation of the Central Highland of Iceland," The Botany of Iceland, Vol. 3, 1945, pp. 351-547.
- [13] N. Polunin. "Botany of the Canadian Eastern Arctic, Part III. Vegetation and Ecology," Natl. Museum Can. Bull. 104, 1948, pp. 1-304.
- [14] T. W. Böcher. "Oceanic and Continental Vegetational Complexes in Southwest Greenland," Medd. om Grøn., bd. 148, No. 1, 1954, pp. 1-336.
- [15] R. E. Holtum. "The Vegetation of West Greenland," J. Ecology, Vol. 10, 1922, pp. 87-108.
- [16] L. Harmsen. "Moses." The Scoresby Sound Committee's 2nd East Greenland Expedition in 1932, Medd. om Grøn., bd. 104, No. 7, 1933.
- [17] Lauge Koch. "The East Greenland Ice," Medd. om Grøn., bd. 130, No. 3, 1945.

ARCTIC SOILS

J. C. F. TEDROW, Rutgers University, New Brunswick, N. J.

Compared with other major soil regions, the development of arctic soil concepts has had a rather curious history. Most reports of investigations have come from men whose main interest has been in fields other than that of soil science. This is true for the arctic soils of Eurasia as well as for those of North America. Literature from these other fields has, however, been of considerable importance. We have been able to profit from the reports of geologists, particularly from studies of permafrost, patterned ground, and physical and chemical weathering [1, 2, 3].

Botanists have made many important contributions in the field of ecology [4, 5]. Engineers have produced valuable information in the areas of particle size, moisture levels, and freeze-thaw phenomena [6, 7]. But the core of the arctic pedologic problems—that is, those problems dealing with particle sizes within the genetic profile, structure, ion exchange, pH, composition of the soil solution; organic matter composition, levels of mineral weathering within the profile and attendant parameters of pedology—have received comparatively little study. Because classification and survey techniques and other studies relating to the pedogenic processes have been neglected, the dynamics of arctic soil systems are understood only in general terms.

The first serious effort at examining soils from a fundamental viewpoint is found in the work in Germany (1810-1875) of Thayer, Krause, Sprengel, Humboldt, Fallou, Knop, and Brendt. Shortly thereafter Dokuchaev, in his Classification of Soils, virtually sparked the birth of a new science—pedology [8]. In his classification scheme Dokuchaev made use of tundra as a genetic soil term. From 1875 to 1935 followers of Dokuchaev crystallized concepts of soil formation and classification. Among these men, the work of Sibirtzev, Glinka, Gedroiz, Afanasiev, Neustruev, and Zakharov was brilliant. In Germany during this era Ramann and Stremme were also making outstanding contributions, as were, in the

United States, Hilgard and Marbut. This period from 1875 to 1935 might well be called the golden era of pedology. But studies at this time were concerned with the soils of the temperate and warm climates, and conditions for the study of the soils of the Arctic were, unfortunately, not favorable.

Prior to Dokuchaev, Von Middendorf [9] had distinguished between high and low tundra; high tundra was said to have relatively dry mineral soils, and low tundra to have bog or marsh-type vegetation. Other investigators subsequently pointed out that arctic soils were silty, mildly acid, turfey, wet; had a degree of frost displacement; were usually underlain by permafrost, and were found north of the tree line. This last characteristic introduced bias of a high order, because the separation was botanical and not one based on soil properties.

TUNDRA SOILS

Much valuable information on tundra soils stems from the work of Sumgin [10] and Polyntseva and Ivanova [11], who described the general features of these soils. Dokuchaev's differentiation of the tundra soils as glacial soils of the arctic latitudes was later recognized by Sibirtzev as a "special type of zonal soils of the tundra." Glinka reported that a marshy type of soil formation predominated in the tundra. Dokuchaev, Sibirtzev, and Glinka generalized their ideas by theoretical concepts and not by physical research in the arctic region [12].

The views of other arctic investigators merit special recognition. Sochava [13] discussed the tundra soils of the Anabar basin with glei and peaty-glei characteristics. Podzol formation was detected on the sands and subsands but not on the glei soils. The idea of relating tundra soils to those of the steppes was ridiculed.

Gorodkov [14] related the similarity of the soil of the tundra to marshes and sod soils of the northern forest zone and

pointed out that the soils of the two zones represent only a quantitative change in pedogenic processes; he indicated that if a special zone be assigned to the Arctic it should be the zone of the polar desert.

Filatov [15] reported that soil processes in the northern areas seldom go beyond the stage of soil primitives, with little genetic variety. He also described "dry, turf-lichen tundra on hard rocks," and the presence of podzolic soils on sands and subsands with no podzol formation on the finer textured soils.

Kreida [16] divided the tundra of northern USSR into arctic, northern, and southern. Cryptoglei- and glei-structure soils were reported in the arctic subzone, with cryptoglei solonchaks in the littoral belt. The northern zone is comprised mainly of soils with pronounced frost displacement. The southern zone is characterized by surface glei and residual glei podzolized soils on fine textured soils and of illuvial-humic podzolized soils on coarse-textured material. Dwarf podzols are present along some of the river valleys. Kreida pointed out the increase in podzolization from north to south with a lower percentage of cation saturation in the south. He recognized a special type of soil formation in the tundra which consists of the interaction of biochemical and other leaching processes coupled with frost displacement.

Svatkov [17] reported that there is justification for defining a special type of arctic soil formation; and on Wrangel Island he recognized arctic polygonal, arctic sod, arctic glei, bog, and mountain arctic soils, with numerous subdivisions.

Although very little work has been done on the soils of arctic Canada, some important general observations have been made [18, 19, 20].

In recent years tundra soils have been studied to a considerable depth; not only was the active layer investigated, but also the upper portion of permafrost zone [21]. Interesting morphological features were revealed, the most important being the ever-present concentration of organic matter in the upper portion of the permafrost.

Vital activity in tundra soils is limited in the warmer regions to three or four months and in the colder sectors to two months. Universal wetness in the main tundra belt is well

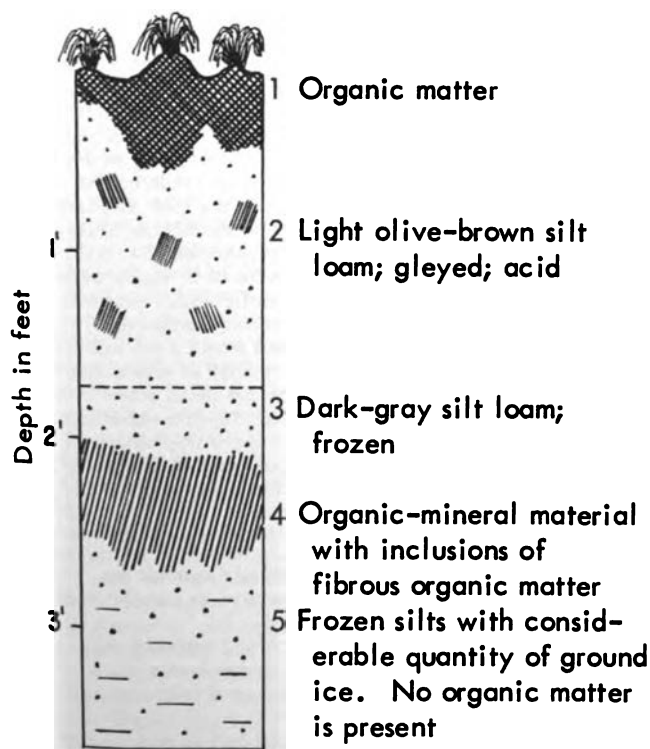

Fig. 1. Diagram of tundra soil profile, northern Alaska—dashed line approximates permafrost table

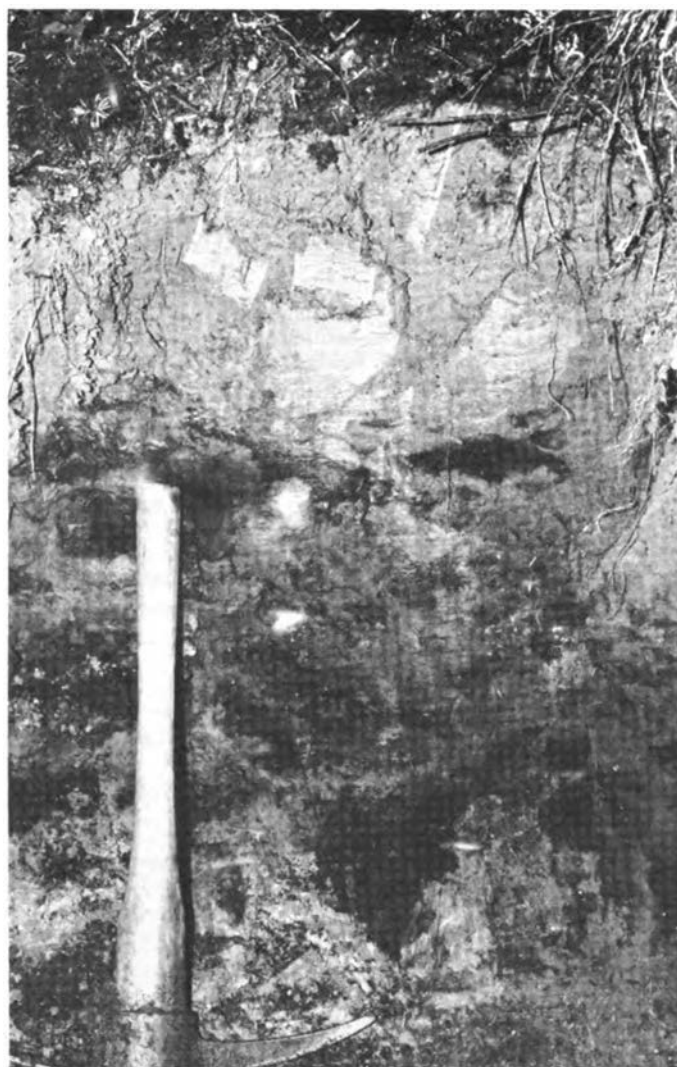

Fig. 2. Dark areas in the photograph of a tundra soil profile from northern Alaska are due to concentrated organic matter (horizon 4 of Fig. 1)

known and can be related to the impervious nature of the permafrost, low temperatures, natural precipitation, and possibly, condensation. Silty soil textures predominate, a condition long recognized in arctic science. Soil texture appears to be a reflection of the grain size of the rock [22]. Wide textural variations, however, are found, and they range from the heavy clays of the bentonite deposits (where clay may be 60 to 80%) to the loamy sands associated with certain aeolian deposits. To date no one has been able to demonstrate textural differences within the tundra profiles that can be ascribed to pedogenic processes, but there is fragmentary evidence that silt is concentrated at the surface.

Tundra soils are moderately acid near the surface, and pH values tend to increase with depth. Reconnaissance surveys of Drew [23] and Douglas [24] showed that extensive areas of alkaline tundra soils are present in northern Alaska, a condition that probably relates to loess activity and involves carbonate bearing minerals. Despite the persistent presence of carbonates throughout many tundra profiles, a fundamental acid-glei process operates in the soil. In the mildly acid, silty parent material, data indicate that the base saturation of the surface horizon of tundra soils approximates 25 to 50% [25, 26]. On silt soils and other bare surfaces, salts accumulate during the dry seasons. When a sample of a white crust near Umiat, Alaska, was X-rayed, it was found to consist of thenardite, which attests to the upward movement of salts.

If one uses chemical parameters only, many of the bare mineral "soils" of the Arctic will fall into the category of saline soils [26].

The origin of the organic matter in the upper portion of the permafrost (Figs. 1, 2) is of special interest. This permanently frozen organic layer occurs in an erratic pattern, with the zone of concentration generally some 2 to 6 in. thick and at a depth of 15 to 50 in. below the surface [21, 25, 26].

The genesis of this layer has not been established, but several statements can be made concerning its origin: (1) It is not a result of aeolian burial. This has been established by field evidence and by laboratory analyses involving particle sizes, heavy and light mineral suites, and clay mineralogy. (2) The material is below the maximum depth of seasonal thaw and must be a relic of a warmer episode. (3) C-14 dating of five samples from northern Alaska yielded values ranging from 8150 to 10,600 years (Table I). (4) Analyses of the identifiable plant remains, including pollen, indicate that the buried vegetation approximates the plant communities currently growing in the region (Table I) and approximates the findings of Livingstone [27].

Table I. Carbon 14 dating of deep organic concentration within tundra soils (Fig. 1, horizon 4) of Northern Alaska

Sample No. ^a	Location	Depth (in.)	C-14 Date (Years)
^b L 400 B	Barrow	23-24	10 600 ± 260
^b L 400 C	2 miles N. of Umiat	46-48	8 150 ± 150
^c L 511 B	Franklin Bluffs	19-21	8 800 ± 400
^d I 354	10 miles S. of Umiat	16-22	9 325 ± 250
^d I 356	10 miles S. of Umiat	16-22	9 130 ± 240

^aL are determinations by Lamont Laboratories

^bI are determinations by Isotopes Inc.

^cC-14 tests on samples L 400 B and L 400 C made on hot NaOH insoluble residue

^cPlant remains determined by J. E. Cantlon, Michigan State University; vegetation similar to present, high in *Dryas*

^dPollen analyses by P. A. Colinvaux, Duke University. Plant remains are *Betula*, *Ericales*, *Cyperceae*, *Gramineae*, and others

There is increasing evidence that there was a period(s) of warmer climate in the northern hemisphere. Recently Broecker [28] indicated that there was an abrupt warming in North America some 11,000 years ago, and evidence supports this general hypothesis. Other studies [29, 30, 31, 32] also present convincing evidence of past warmer climates in the northern hemisphere. Sheludiakova [33] reports remnants of forest vegetation in the tundra and a repeated displacement of the forest boundary northward, then again southward. Obruchev [34] describes cedar, birch, pine, larch, and spruce pollen in the peat deposits of the Anadyr basin.

If the interpretations of these investigators are correct, the time of the development of the concentration of organic matter deep in the tundra soils of Alaska probably coincides with the warming trend during late Wisconsin time. Organic remains could have reached their present position only when the seasonal thaw occurred to a greater depth than it now does, thus supporting the probability of an earlier warmer climate. This would merely suggest the general time when the events took place, but would not establish the process. Organic concentration is as present in tundra soils of the Gubik formation as it is in older deposits in northern Alaska. There is fragmentary evidence that this deep organic layer is present in at least one Soviet sector (Svatkov [17]), although the information is too incomplete to suggest that it is a circumpolar phenomenon.

At any time and place tundra soil morphology reflects two

processes: One process relates to soil formation and involves organic matter production and a mildly acid-glei process; the other is a destructive, physical process—that is, frost action including solifluction [35 to 41]. In order to account for soil morphology, the two processes, one soil-forming, the other soil-destroying, must be carefully equated. Literature on the subject of frost displacement is rather voluminous. In more recent years there have been a number of quantitative studies undertaken on the subject and, fortunately, we no longer have to rely on descriptions alone [42-48].

BOG SOILS

In northern Alaska, bog soils are associated with tundra soils in a highly intricate geographic pattern. On the coastal plain, bog soils are extensive [23], occupying, in the northern fringes, probably 25 to 50% of the land area. In the southern coastal plain and foothills, bog soils occur in swales, on wide terraces, and on the flat topography associated with certain upland positions. The Brooks Range has few, if any, bogs. Bog soils are generally formed from mixed sedge-Sphagnum, and are commonly 2 to 4 ft—sometimes as much as 30 ft—in the draws. The reaction of these bog soils is mildly to strongly acid, but in certain organic soils present-day calcareous loess deposition may be influencing certain acidity levels, a condition which has not, however, been studied.

WELL-DRAINED SOILS

That well-drained soils occur in the arctic regions has been known for over a century [9], but prior to 1930 few investigations of these soils were conducted. During the past 10 years a number of reports have made possible the diagram (Fig. 3) of positions where they normally occur. These soils are commonly present on narrow ridges, kames, lateral moraines, and dunes where permafrost is some 2 to 4 ft deep [49]. Based on morphology alone these brown-colored soils are scarcely separable from their northern forest counterparts. If sites for construction can be selected, these soils should receive the careful attention of engineers, because they have the properties of soil that are desirable for construction (in certain sectors they occupy, unfortunately, only small, local areas). These soils have been known by a variety of names [50-53], but this in itself is not too important.

Arctic brown soils develop a solum to a depth approximating 20 in. A range in textures is present, but sandy loams predominate. Clay is usually in greatest quantity at the surface and decreases slightly with depth. An acid condition is usually present at the surface, with pH values increasing at depth. Carbonates, existing as white, brown, or even black crusts are commonly precipitated on the lower sides of the rock fragments. Even though carbonates are precipitated on the coarse skeleton, the fines themselves may be acid in reaction [54, 55].

This suggests a delicate pedologic balance in which evapotranspiration approximates leaching in arctic soils; evidence has been further substantiated by the work of Mather and Thornthwaite [56] and by the unpublished work of the late R. E. Shanks and his associates. Mineralogy of arctic brown soil indicates that a low order of weathering takes place in the solum, including alteration of feldspars to clay-like substance. Clay minerals consist of altered micas, kaolinite, chlorite, iron-bearing minerals, clay-size feldspar, and quartz [54, 57]. Organic matter studies show C to N ratios of about 15 to 20.

MISCELLANEOUS SOILS

Lithosols, rock land, and regosols, virtually without any genetic horizon differentiation, are extensive in certain areas of the Arctic.

Recently Ugolini, Tedrow, and Grant [58] reported well drained organic soils formed on certain black shales of northern Alaska. These apparently correspond to the shungite soils of Karelia [59].

The northern extension of rendzina soil had been a somewhat unknown factor, but it has now been identified in northern Alaska [60].

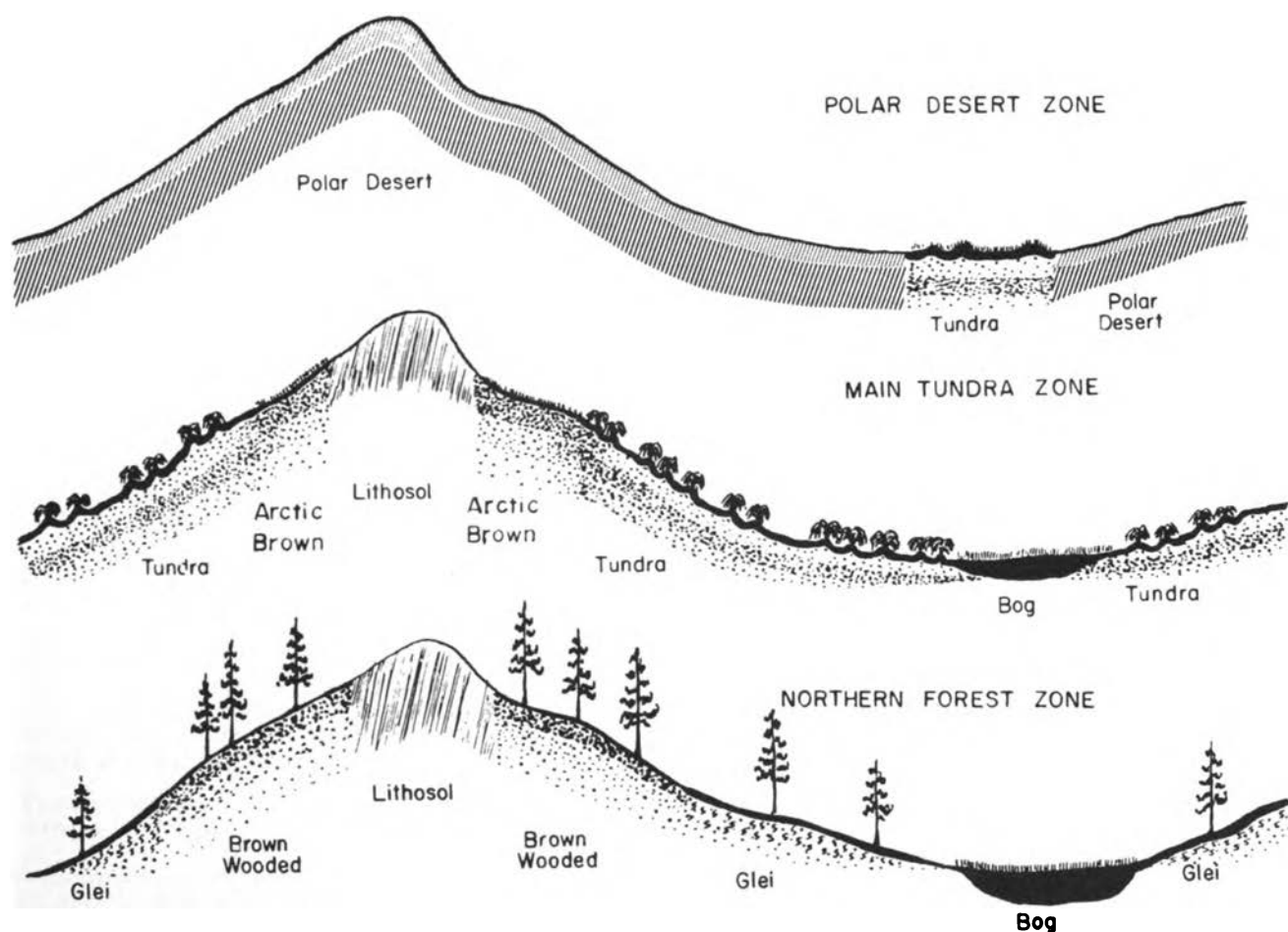

Fig. 3. Diagram of soil patterns in northern areas

SOIL PROCESSES AND CLIMATIC GRADIENTS

Soil formation across northern climatic gradients are briefly discussed here, particularly the natural soil changes within the entire region of ice free land north of the tree line. When Dokuchaev compiled his original soil map of Eurasia, land north of the tree line was designated as an undifferentiated soil zone. Glinka's map listed virtually the same regions as tundra with parts of the eastern Siberian highlands designated as vertical soil zones. Prasolov's map constituted a refinement of the soil boundaries of the earlier Soviet workers, and the arctic soil region was designated as polar tundra with certain mountain soils. Gerasimov [61] designated the southern portion of the tundra region as glei soils of the sub-polar tundra, and the extreme northern zone as primitive soils of the polar tundra. The work of Gerasimov is a realistic approach and can serve as a foundation for future work.

Kubiiena [62] introduced the term arctic rawmark for the polar desert soil and this was later used in Spitsbergen by Smith [63]. In a similar fashion, McMillan [64] recognized tundra soils in the southern tundra region and rawmark in the Far North. Comparing the soils of the main tundra belt to those of the extreme northern ice free areas, there are two major changes: one relates to the weakening of the soil forming agencies, and the other to a shift from the predominantly tundra soils to those of the polar desert (Fig. 3).

In following the brown wooded soils northward from the boreal forest (Fig. 3) at the tree line, there appear to be a few morphological changes as well-drained soils grade into arctic brown soils of the main tundra belt [65]. This is also true of the glei, bog, and the podzol-like soils (Fig. 3). It is more

realistic to view conditions at the forest-tundra ecotone as a slowly changing continuum with strong morphological affinities on both sides of the tree line. The northern forest zone has brown, wooded, glei and bog soils. Usually the mean July temperatures are 50°F. Northward into the main tundra zone the brown wooded soils grade into arctic brown and the glei soils into tundra. Mean July temperatures in the main tundra zone approximate 40 to 50°F. The polar desert zone of the Far North has mean July temperatures of usually <40°F and is characterized by predominantly stony conditions with little soil development.

In addition to the shift in soil properties with latitudes, there is in the arctic and boreal regions somewhat of a corresponding shift with altitude. This principle was laid down by Dokuchaev at the turn of the century and is applicable for arctic as well as certain other regions. Petrov [50], Glazovskaia [66], and Tedrow and Brown [67] describe the various soil changes with altitude.

PATTERNED GROUND

Perhaps the most voluminous literature of the arctic concerns patterned ground. Attempts to relate certain forms of patterned ground to genetic soils have met with some success. Certain types of patterned ground are commonly associated with specific soils but there are, on the other hand, many conditions under which there appears to be no correlation between the two [68, 69]. Drew [23] and Brown [70] described the problems and constructed some preliminary maps in selected areas of northern Alaska.

ARCTIC SOIL MAPS

Gerasimov [71] compiled a soils map of Eurasia which perhaps constitutes our most authoritative reference for any northern region. Gerasimov and associates [72] recently compiled a smaller map of the northern Soviet region which shows a number of soil delineations. Soils maps of northern Canada [73] and northern Alaska [74] are highly generalized. Johannesson [75] published a soils map of Iceland showing various physiographic-soil conditions.

FUTURE PROBLEMS

With this brief review of some northern soils one fact becomes obvious—the solutions to most of our problems lie ahead. It seems appropriate then to suggest some future pedologic research needs in arctic regions:

1. Since very little is known of the soils of northern Canada, particularly the whole northeastern sector [76], an effort should be made to conduct, in detail, reconnaissance and local studies in this least known soil region of the arctic.
2. An effort should be made by all nations which circle the Arctic Ocean to unify soil nomenclature; if differences cannot be reconciled, attention should then be directed toward listing an equivalent terminology. Ideally this would involve the exchange of small field parties on an international basis.
3. Fundamental studies on arctic soil genesis, morphology, and classification should receive special attention. Problems of the composition of the soil solution, ion uptake, mineral weathering, soil-plant relationship at low temperatures, frost action, patterned ground in relation to the genetic soil, soil classification, and cartography merit early attention.

ACKNOWLEDGMENTS

Journal series paper of the New Jersey Agri. Exp. Sta., Rutgers—The State University of New Jersey. These studies were aided by a contract between the Office of Naval Research, Department of the Navy and the Arctic Institute of North America. Reproduction in whole or in part is permitted for any purpose of the United States Government.

Appreciation is extended to P. A. Collinvaux, of Duke University, for pollen analyses and J. E. Cantlon, of Michigan State University, for identification of certain plant remains.

REFERENCES

- [1] A. Cailleux, G. Taylor. Crypédologie, étude des sols gelés, Hermann, ed., Paris, 1954.
- [2] A. L. Washburn. "Classification of Patterned Ground and Review of Suggested Origins," Geol. Soc. Am. Bull., Vol. 67, 1956, pp. 823-866.
- [3] C. Troll. Structure Soils, Solifluction, and Frost Climates of the Earth, Transl. 43, U.S. Army SIPRE, Wilmette, Ill., transl. from German, 1958.
- [4] R. F. Griggs. "The Problem of Arctic Vegetation," J. Wash. Acad. Sci., Vol. 24, 1934, pp. 153-175.
- [5] N. Polunin. "Aspects of Arctic Botany," Am. Sci., Vol. 43, 1955, pp. 307-322.
- [6] R. F. Legget. "Permafrost Research," Arctic, Vol. 7, 1954, pp. 153-158.
- [7] R. F. Black. "Some Problems in Engineering Geology Caused by Permafrost in the Arctic Coastal Plain, Northern Alaska," Arctic, Vol. 10, 1957, pp. 230-240.
- [8] J. N. Afanasiev. "The Classification Problem in Russian Soil Science," in Russian Pedological Investigations; Acad. Sci. USSR, Leningrad, Vol. 5, 1927, pp. 1-51.
- [9] A. Von Middendorf. Sibirische Reisen, Bd. IV, Teil I. Übersicht über die Natur Nord-und Ostsibiriens, Vierte Lieferung: Die Gewächse Sibiriens, St. Petersburg, 1864, pp. 525-783.
- [10] M. Sumgin. "Conditions of Soil Formation in the Region of Ever-frozen," 2nd Intl. Soil Sci. Cong., Proc., Vol. 5, Comm. V., Moscow, 1932, pp. 34-46.
- [11] O. A. Polyntseva, E. N. Ivanova. "Complexes of the Spotty Tundra of the Khibiny Massiv and Their Evolution in Connection with the Evolution of Soil and Vegetative Covers," Acad. Sci. USSR, Trans. V. V. Dokuchaev Soil Inst., Vol. 13, 1936, (text in Russian).
- [12] D. G. Vilenskii. Soil Science, Moscow, transl. from Russian, U.S. Dept. of Commerce, Wash., D. C., 1957.
- [13] V. B. Sochava. "Tundras of the Anabar River Basin," Izv. Gosud. Geog. Obshch., Vol. 65, 1933, pp. 340-364, (Text in Russian).
- [14] B. N. Gorodkov. "Peculiarities of the Arctic Top Soil," Izv. Gosud. Geog. Obshch., Vol. 71(10), 1939, pp. 1516-1532, (Text in Russian).
- [15] M. Filatov. "Geography of the Soils of the USSR," Geografiia pochv SSSR.. Moskva, Gos. Uchebno-Pedagogicheskoe Izd-vo, 1945, (Text in Russian).
- [16] N. A. Kreida. "Soils of the Eastern European Tundra," Pochvovedenie No. 1, 1958, pp. 62-67, (Text in Russian).
- [17] N. M. Svatkov. "Soils of Wrangel Island," Pochvovedenie No. 1, 1958, pp. 80-87, (Text in Russian).
- [18] I. C. Feustel, A. Dutilly, M. S. Anderson. "Properties of Soils from North American Arctic Regions," Soil Sci., Vol. 48, 1939, pp. 183-199.
- [19] A. Leahey. "Characteristics of Soils Adjacent to the Mackenzie River in the Northwest territories of Canada," Soil Sci. Soc. Am. Proc., Vol. 12, 1947, pp. 458-461.
- [20] A. Leahey. "Factors Affecting the Extent of Arable Lands and the Nature of the Soils in the Yukon Territory," Pacific Sci. Cong., 7th Cong., Vol. 6, 1949, pp. 16-20.
- [21] J. C. F. Tedrow, J. V. Drew, D. E. Hill, L. A. Douglas. "Major Genetic Soils of the Arctic Slope of Alaska," J. Soil Sci., Vol. 9, 1958, pp. 33-45.
- [22] R. S. Sigafos, D. M. Hopkins. "Soil Instability on Slopes in Regions of Perennially-frozen Ground. Frost Action in Soils," Highway Res. Bd. Special Rept. No. 2, Natl. Res. Council Pub. 213, 1952, pp. 176-192.
- [23] J. V. Drew. "A Pedologic Study of Arctic Coastal Plain Soils Near Point Barrow, Alaska," Ph.D. thesis, Rutgers Univ., 1957.
- [24] L. A. Douglas. "A Pedologic Study of Tundra Soils from Northern Alaska," Ph.D. thesis, Rutgers Univ., 1961.
- [25] J. Brown, J. C. F. Tedrow. "Characteristics of Two Tundra Soils from the Arctic Slope of Alaska," Proc. 9th Alaskan Sci. Conf., 1958, p. 2.
- [26] L. A. Douglas, J. C. F. Tedrow. "Tundra Soils of Arctic Alaska," 7th Intl. Soil Sci. Cong. Proc., Vol. 4, 1960, pp. 291-304.
- [27] D. A. Livingston. "Pollen Analysis of a Valley Fill Near Umiat, Alaska," Am. J. Sci., Vol. 255, 1957, pp. 254-260.
- [28] W. S. Broecker, M. Ewing, B. C. Heezen. "Evidence for an Abrupt Change in Climate Close to 11,000 Years Ago," ibid., Vol. 258, 1960, pp. 429-448.
- [29] C. Emiliani. "Pleistocene Temperatures," J. Geol., Vol. 63, 1955, pp. 538-578.
- [30] E. S. Deevey, R. F. Flint. "Postglacial Hypsithermal Interval," Science, Vol. 125, 1957, pp. 182-184.
- [31] M. Ewing, W. L. Donn. "Pleistocene Climate Changes," Geology of the Arctic, Vol. 2, 1961, G. O. Raasch (ed.), Univ. Toronto Press, pp. 931-941.
- [32] M. S. Bryan. "Interglacial Pollen Spectra from Greenland," Danmarks Geologiske Undersøgelse 11, Roekke, No. 80, København, 1954, pp. 65-72.
- [33] V. A. Sheludiakova. "The Vegetation of the Indigirka River Basin," Sovetskaia Botanika (4-5), 1938, pp. 42-79, (Text in Russian).
- [34] V. A. Obruchev. "Past Glaciation and Quaternary History of the Chukotsk District," Izvest. Akad. Nauk USSR, 1939, pp. 129-146.
- [35] E. deK. Leffingwell. "Ground Ice-Wedges, the Dominant Form of Ground-ice on the North Coast of Alaska," J. Geol., Vol. 23, 1915, pp. 635-654.
- [36] S. Taber. "Perennially Frozen Ground in Alaska: Its Origin and History," Geol. Soc. Am. Bull., Vol. 54, 1943, pp. 1433-1548.
- [37] R. S. Sigafos. "Soil Instability in Tundra Vegetation," Ohio J. Sci., Vol. 51, 1951, pp. 281-298.
- [38] W. S. Benninghoff. "Interaction of Vegetation and Soil

Frost Phenomena," Arctic, Vol. 5, 1952, pp. 34-44.

[39] J. R. Mackay. "A Subsurface Organic Layer Associated with Permafrost in the Western Arctic," Dept. of Mines and Technical Surveys, Geographic Paper No. 18, Ottawa, 1958.

[40] J. C. F. Tedrow, J. E. Cantlon. "Concepts of Soil Formation and Classification in Arctic Regions," Arctic, Vol. 11, 1958, pp. 166-179.

[41] J. C. F. Tedrow. "Morphological Evidence of Frost Action in Arctic Soils," Biuletyn Peryglacjalny, Vol. 11, 1962.

[42] R. F. Black. "Permafrost - A Review," Geol. Soc. Am. Bull., Vol. 65, 1954, pp. 839-856.

[43] P. J. Williams. "Direct Recording of Solifluction Movements," Am. J. Sci., Vol. 255, 1957, pp. 705-714.

[44] P. J. Williams. "An Investigation into Processes Occurring in Solifluction," ibid., Vol. 257, 1959, pp. 481-490.

[45] A. Rapp, S. Rudberg. "Recent Periglacial Phenomena in Sweden," Biuletyn Peryglacjalny, Vol. 8, 1960, pp. 143-154.

[46] A. E. Corte. "Experimental Formation of Sorted Patterns in Gravel Overlying a Melting Ice Surface," ibid., Vol. 8, 1960, pp. 66-72.

[47] A. L. Washburn. "Instrumentation for Mass-wasting and Patterned-ground Studies in Northeast Greenland," ibid., Vol. 8, 1960, pp. 59-64.

[48] A. H. Lachenbruch. "Mechanics of Thermal and Contraction Cracks and Ice-wedge Polygons in Permafrost," Geol. Soc. Am. Spec. Paper No. 70, 1962.

[49] J. V. Drew, J. C. F. Tedrow, R. E. Shanks, J. J. Koranda. "Rate and Depth of Thaw in Arctic Soils," Trans. Am. Geophys. Union 39, 1958, pp. 697-701.

[50] B. F. Petrov. "Soils of the Altai-Sayan Region," Proc. Dokuchaev, Soil Inst. Acad. Sci. USSR, Vol. 35, 1952, (Text in Russian).

[51] J. C. F. Tedrow, D. E. Hill. "Arctic Brown Soil," Soil Sci., Vol. 80, 1955, pp. 265-275.

[52] N. A. Karavaeva. "High Mountainous Soils of Eastern Sayan," Pochvovedenie No. 4, 1958, pp. 61-66, (Text in Russian).

[53] T. S. Mikhailov. "Soil Studies in Northern Alaska," Pochvovedenie No. 2, 1961, pp. 103-108, (Text in Russian).

[54] D. E. Hill, J. C. F. Tedrow. "Weathering and Soil Formation in the Arctic Environment," Am. J. Sci., Vol. 259, 1961, pp. 84-101.

[55] J. Brown, J. C. F. Tedrow. "Soils of the Northern Brooks Range, Alaska 4: Well-Drained Soils of the Glaciated Valleys," Soil Sci., Vol. 97, 1964, pp. 187-195.

[56] J. R. Mather, C. W. Thornthwaite. Microclimatic Investigations at Point Barrow, Alaska, 1957-1958, Drexel Inst. Tech., Lab. of Climatology, Centerton, N. J., 11(2), 1958.

[57] J. V. Drew, J. C. F. Tedrow. "Pedology of an Arctic

Brown Profile near Point Barrow, Alaska," Soil Sci. Soc. Am. Proc. 21, 1957, pp. 336-339.

[58] F. C. Ugolini, J. C. F. Tedrow, C. L. Grant. "Soils of the Northern Brooks Range, Alaska: 2. Soils Derived from Black Shale," Soil Sci., Vol. 95, 1963, pp. 115-123.

[59] M. A. Toikka. "Comparison of Shungite Soils with the Main Soil Types of USSR," Sci. Notes Petrozawodsk Univ., Biol. Sci., Vol. 7, 1957, pp. 117-137, (Text in Russian).

[60] F. C. Ugolini, J. C. F. Tedrow. "Soils of the Northern Brooks Range, Alaska: 3. Rendzina of the Arctic," Soil Sci., Vol. 96, 1963, pp. 121-127.

[61] I. P. Gerasimov. "Soil Map of the World," Priroda, No. 10, 1956, pp. 5-13, (Text in Russian).

[62] W. L. Kubiena. The Soils of Europe, T. Murby, London, 1953.

[63] J. Smith. "Some Moving Soils of Spitsbergen," J. Soil Sci., Vol. 7, 1956, pp. 10-21.

[64] N. J. McMillan. "Soils of the Queen Elizabeth Islands (Canadian Arctic)," J. Soil Sci., Vol. 11, 1960, pp. 131-139.

[65] J. C. F. Tedrow, H. Harries. "Tundra Soil in Relation to Vegetation, Permafrost and Glaciation," Oikos, Vol. 11, 1960, pp. 237-249.

[66] M. A. Glazovskaia. "Biological Factors of Weathering in High Mountains," Priroda, No. 12, 1952, pp. 106-110, (Text in Russian).

[67] J. C. F. Tedrow, J. Brown. "Soils of the Northern Brooks Range, Alaska: Weakening of the Soil Forming Potential at High Arctic Altitudes," Soil Sci., Vol. 93, 1962, pp. 254-261.

[68] M. E. Britton. "A Tundra Landscape," Research Rev., Office of Naval Research, Washington, D. C., Jan. 1958, pp. 4-13.

[69] J. V. Drew, J. C. F. Tedrow. "Arctic Soil Classification and Patterned Ground," Arctic, Vol. 15, 1962, pp. 109-116.

[70] J. Brown. "Soils of the Northern Brooks Range, Alaska," Ph.D. thesis, Rutgers Univ., 1962.

[71] I. P. Gerasimov. (Soil Map 1:4,000,000), Dokuchaev Inst. Soils, Acad. Sci., USSR, 1954, (Text in Russian).

[72] E. N. Ivanova, et al. "Soil and Geographical Regions of the USSR," ibid., USSR, 1962, p. 422, (Text in Russian).

[73] Atlas of Canada, Dept. of Mines and Tech. Surveys, Sheet No. 35, Ottawa, 1957.

[74] C. E. Kellogg, I. J. Nygard. "Exploratory Study of the Principal Soil Groups of Alaska," U.S.D.A. Agr. Monograph No. 7, 1951.

[75] B. Johannesson. The Soils of Iceland, Univ. Res. Inst., Reykjavik, 1960.

[76] F. S. Nowosad, A. Leahey. "Soils of the Arctic and Sub-arctic Regions of Canada," Agr. Inst. Rev., 15, 1960, pp. 48-50.

SOIL INVESTIGATIONS IN THE LOWER WRIGHT VALLEY, ANTARCTICA

F. C. UGOLINI, Rutgers University

Recent investigations [1, 2, 3] in ice-free areas of Antarctica show that soil-forming processes are active and soils are produced. In this continent soil genesis is more directly related to climate than to other factors of soil formation. Compiled meteorological data [4] indicate that Antarctica receives only a small amount of precipitation throughout the year, and that aridity conditions tend to prevail.

Antarctica is considered, climatologically speaking, a desert, or more precisely as Markov [5] has defined it, a cold desert. In a cold desert environment, soil formation is strongly affected by the paucity of water and by predominant low temperatures. Since only liquid water can perform the transfer of soluble products of weathering, the presence or absence of moisture movement in a liquid state through the soil profile may establish whether some soils are being formed today or are relics reflecting conditions no longer existing.

Irrespective of their dynamic or static status, these soils are unique in that they are formed under a system virtually devoid of humus and under almost continuous freezing temperatures. Because of these conditions, it becomes necessary before discussing antarctic soils to interpret in a new light some of the pedological and cryopedological concepts held for temperate and arctic latitudes. Thus, any definition of soil makes mandatory the presence of an organic cover on the mineral layers. Antarctic soils then, lacking this organic layer, will not fulfill this definition. In spite of the absence of a surficial organic horizon, these soils acquire megascopic features and chemical properties to the extent that their appurtenances at the realm of soils become justified. Due to the cold environment under which these soils are formed, a substantial portion of the soil profile retains below freezing temperatures even during the summer months. To be exact, this portion should



Fig. 1. Typical ahumic soil profile from Wright Valley, Antarctica

be considered permafrost. For this study, however, the word soil used throughout this article is applied to that portion of surficial deposits, independently of its temperature, that rests on an ice-cemented layer or on material unaffected by pedological processes.

In a recent study [3], antarctic soils were grouped tentatively under the heading "soils of the cold desert" and further subdivided into: Ahumic soils, evaporite soils, preranker soils, ornithogenic soils, regosols, and lithosols.

Ahumic soils (Fig. 1), so designated for the striking absence of a visible layer of organic debris, should be considered the zonal soils of Antarctica belonging to the desert type of soil formation. However, in view of the salinity displaced by some of these soils, one may question whether saline soils are to be considered zonal soils. Ahumic soils and lithosols are the most widespread soils of ice-free areas of McMurdo Sound and possibly of the whole continent.

The processes operating on these ahumic soils are mainly two: Salinization and oxidation—the former being responsible for accumulation of salts, and the latter for the rusty red color of the soil. Progressive development of the soil is marked by an intensification of both processes. As Nikiforoff [6] states, the development of normal desert soils is the result of upward capillary movement of moisture with consequent formation of a desert crust, and the concentration of products of mineral alteration below the surface. A similar process is taking place in soils of ice-free areas of Antarctica. Here, too, the transfer and accumulation of salts take place within the soil profile through a mechanism of upward water migration. Salinization of these soils can thus be considered a normal pedological process for the region. An upward movement of water has been suggested by Nichols [4] to explain efflorescence at and below the ground surface in Wright Valley (Antarctica).

The Area

The east-west oriented Wright Valley (77° 25' S. 162° 41' E. and 77° 33' S. 160° 42' E.) is one of the conspicuous ice-free areas of McMurdo Sound, Antarctica. Some 70 miles from McMurdo Station, Wright Valley is free from ice for about 30 miles and has a maximum width of less than three miles. The Onyx River, mainly alimented by melted water of Lower Wright Glacier and alpine glaciers, flows for only a few weeks during the summer and empties its water into Lake Vanda.

The east end of the valley, barred by Lower Wright Glacier where our soil studies were centered, consists of a broad expanse generously covered with moraines.

Geology

McKelvey and Webb [7], in a recent geological investigation of Wright Valley, distinguish a basement complex of folded and metamorphosed Pre-Cambrian sediments with intrusions of granitic plutons and microdiorite and granodiorite. On the pene-

plained basement, the Beacon Sandstone Group of sediments were deposited during the Devonian to mid-Mesozoic time. Both the basement complex and the Beacon Sandstone were intruded by Ferrar Dolorite sills and dykes. Volcanic activity in Wright Valley during the quaternary is reported by Nichols [4].

Glacial Geology

Nichols [8] recognized four glaciations of which three, the Pectan, the Loop, and the Trilogy, moved from McMurdo Sound westward, and one, the oldest unnamed, from the Polar Plateau eastward. The youngest of these glaciations, the Trilogy, whose moraines occupy the broad valley in front of Lower Wright Glacier, was further subdivided into three stages. Independent work of Bull, et al [9] includes the Trilogy and the Loop Glaciations of Nichols in a single episode called the Third Glaciation. Bull, et al [9] mention that moraines younger than the Third Glaciation, as yet unmapped, occur near Lower Wright Glacier. Nichols [8] indicates that the Trilogy Glaciation took place about 7000 years ago. Field observations in Lower Wright Valley showed a close association between soil development and the relative age of glacial deposits of the Trilogy Glaciation. In view of this association, the chronology suggested by Nichols was adopted to delineate soil boundaries.

Climate

The continent of Antarctica experiences one of the most severe climates on earth. Temperatures in the order of minus 30° C are recorded at the South Pole (90°S.) during summer months. At McMurdo Station (77° 5' S. and 166° 39' E.) temperatures are higher because of the lower latitude, altitude, and the presence of an open sea during February and March; still no month of the year displays a mean temperature above freezing. Table I shows precipitation in areas adjacent to McMurdo Sound is exclusively in the solid state. Table II shows the amount of precipitation at McMurdo Station.

Table I. Mean Monthly Temperatures (°C) at McMurdo Station^a

	Oct.	Nov.	Dec.	Jan.	Feb.
1956	-19.1	- 8.2	-2.0
1957	-19.7	- 7.8	-2.6	-3.1	- 8.1
1958	-18.8	- 8.6	-5.7	-2.6	- 5.9
1959	-24.1	-11.1	-2.7	-2.8	- 9.8
1960	-16.7	-10.1	-4.4	-1.9	-11.0
1961	-6.1	- 8.6

^aData from Climatology of McMurdo Sound, U. S. Navy Weather Bur. Research Facility, Norfolk, Va.

Table II. Precipitation at NAF, McMurdo Sound^a

Year	In. of Water Equiv.
1957	6.38
1958	2.29 ^b
1959	3.29
1960	5.29
1961	6.26
1962	3.56

^aUnpublished data collected by U. S. Navy and supplied by the U. S. Weather Bur. Blowing snow mixed with falling snow makes some of these data not completely reliable.

^bEight months only.

Snowfall in the valley during the summer is light and tends to dissipate very quickly due to sublimation and mechanical removal by wind. Melting is very limited and melted water does not penetrate more than 3 to 5 cm of soil. Consistent winds blow along the east-west trend of the valley. Relative humidity measurements for only a few days during the summer indicate fluctuations between 70% at night and 35% during the day.

Only scattered data are available for the eastern end of Wright Valley, as the following table indicates.

Table III. Air Temperature and Relative Humidity From Lower Wright Valley (0.5 Miles from the Lower Wright Glacier)

Date	Temp., °C		RH, %	
	Max.	Min.	Max.	Min.
7 Nov.	-7.0	- 8.0	70	30
8 Nov.	-5.5	-11.0	65	32
22 Dec.	1.5	- 7.0	53	25
19 Jan.	0.0	- 5.0	70	30

Biotic Element

The biotic element is very meager in ice-free areas of McMurdo Sound [10]. Mosses, while present near sea level at Marble and Gneiss Points, are absent on the floor of Wright Valley. Lichens were found along the north wall of this valley at an elevation of 4600 ft. This altitude may coincide with the snow line of the region. During the warmest part of the season, melted water at the edge of a frozen lake in front of the Lower Wright Glacier harbors blooming communities of algae. Near the shores, on the moist ground, mites live under stones. From a preliminary survey on the microbiological status of the valley, Boyd reports (personal communications) a very low count compared with areas in Ross Island.

Soils

Soils described in this paper were collected from the moraines belonging to the three stages of the Triology Glaciation [13]. Profile 7, some 5 miles from the present ice cliff of Lower Wright Glacier, derives from the oldest stage. Profiles 4 and 34, respectively 2 and 0.5 miles from Lower Wright Glacier, are from the intermediate stage but represent different chronologies—profile 4 is relatively older than profile 34. Profile 33 was obtained from the youngest moraines of the Triology Glaciation immediately in front of Lower Wright Glacier. A brief description of these profiles follows:

Profile 7 - 1230 ft, asl (above sea level)

4-0 mc - Desert pavement containing ventifacts.
 0-26 cm - Dry, sandy light yellowish brown (2.5 Y6/4 in Munsell Soil Color Charts, Munsell Color Co., Baltimore) horizon with a rather uniform sandy texture. Cobbles in upper part of this horizon appear well weathered with a crust of salts in the lower part.
 26-40 cm - Dry, with no color differentiation from the previous horizon, sandy in texture with no salt under surface of cobbles. Ice-cemented layer at 78 cm (Dec. 25, 1962). A pebble count of this profile gives 80% granitic rocks and 20% dolorite and aphanitic dolorite (dolorite from the chill zone).

Profile 4 - 1100 ft, asl

3-0 cm - Desert pavement.
 0-44 cm - Dry, sandy with light brownish gray (2.5Y6/2) color. Below 14 cm it becomes progressively firm; at a depth of 24 cm an indurated layer is found. This layer has pale olive color (5Y6/3). Ice-cemented layer at 44 cm (Dec. 24, 1962). Pebble count: 75% granitic rocks, 25% dolorite and aphanitic dolorite.

Profile 34 - 1100 ft, asl

0-2 cm - Desert pavement.
 0-37 cm - Rather featureless horizon: dry, sandy, light yellowish brown (2.5Y6/4) with an indurated layer below 15 cm. Ice-cemented layer at 37 cm (Dec. 26, 1962). Pebble count: 60% granitic rocks, 40% dolorite and mica feldspar schist.

Profile 33 - 1200 ft, asl

No desert pavement.
 0-5 cm - Mainly a loose sandy and pebbly layer, light gray (2.5Y7/2). Ice-cemented layer at 5 cm (Dec. 26, 1962).

Pebble count: 75% granite, 25% mica feldspar schist with low percentage of dolorite.

FIELD AND EXPERIMENTAL METHODS

Exploratory soil studies of ice-free areas of McMurdo Sound were made from 1961 to 1963. Soil temperatures and microclimatological data were collected using a telethermometer equipped with thermistor probes and mercury thermometers cased in a thermoscreen. Relative humidity was measured with a hairhygrometer and with a psychrometer. Samples for moisture content were collected at the maximum and minimum of the diurnal temperature cycle. On the fraction less than 2 mm, the following analyses were performed: Mechanical [11], free iron oxides [12], chlorides [13], and sulfates.

Electrical conductivity and pH measurements were also made on a 1-to-1 soil-water extract. Leached and unleached samples of profile 34 were exposed to atmospheres of known relative humidity to evaluate relative hygroscopic coefficients.

Deficiency of water and low temperatures are the limiting factors for soil formation in Antarctica. Consequently, studies of water movements become of great interest in a pedogenetic study. To shed some light on the soil water regime, a simple experiment was set up.

A glass vial 5.5 cm high and with an internal diameter of 2.3 cm was filled with soil from the lower horizon (30 to 37 cm) of profile 34. Previously this soil was brought to a moisture level of 1% as found in the field. The vial was sealed and placed on a hot plate in a cold room where the hot end was kept at 40° C and the cold one at 10° C. The moving boundary at the interface between dry and wet soil could be followed as moisture progressively migrated. At the end of the experiment, conductivity measurements were made on portions of soil obtained from the cold, the hot, and an intermediate point of the soil column. This experiment was devised for qualitative information only.

FIELD AND LABORATORY RESULTS

Soil temperatures—Fig. 2 shows soil temperatures distribution for Nov. 8, Dec. 22, and Jan. 19, 1963-'64. In examining these soils temperatures one must remember that the natural setting consists of bare ground from snow, with dry and coarse textured soils. Consequently, the soil surface will tend to heat and cool rather rapidly. Progressive warming of the season is reflected in soil temperature and in daily fluctuations of the different soil depths. Regardless of time of season, daily fluctuations tend to decrease in amplitude with depth; at the level of the ice-cemented layer fluctuations are almost negligible. Maximum soil temperatures at the surface tend to occur during the early afternoon; at depths of 12 to 22 cm the maximum is reached after a lag of a few hours. Unreported data show that a concomitance between maximum air temperature and maximum soil temperature is not always reached. It seems, as already reported by other authors, that near surface soil temperatures depend more on solar radiation than on air temperature.

Soil temperature gradients recorded during the season were 0.5° C per cm for Nov. 8, 0.6° C per cm for Dec. 22, and 0.4° C per cm for Jan. 19.

Laboratory Studies

The effect of salts on water-holding capacity is evident from Table IV where soil moistures for natural and desalted soils exposed at different relative humidity levels are presented.

Table IV. Hygroscopic Coefficients (%) of Soil Profile 34, Wright Valley (< 2 mm)

Depth, cm	RH, 98.2%		RH, 50.0%	
	natural	desalted	natural	desalted
2-6	4.04	2.43	0.61	0.20
6-15	3.49	1.39	0.40	0.15
15-25	2.11	1.32	0.27	0.10
25-30	2.03	1.45	0.27	0.10
30-37	1.03	0.78	0.27	0.07

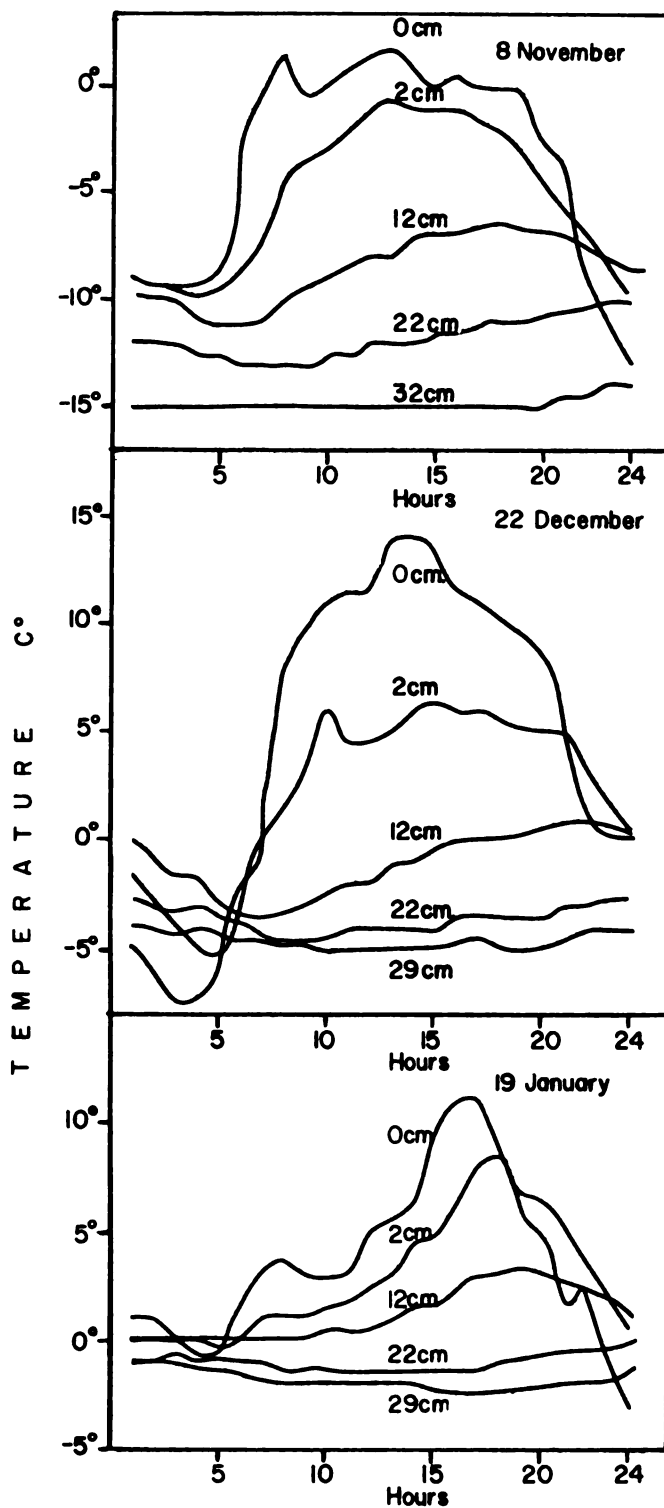

Fig. 2. Daily fluctuations of soil temperatures in profile 34

Mechanical analysis (Table V) shows that coarse textures tend to prevail in all four profiles. Clay content is, in general, rather low and tends to increase as the age of glacial deposits increases. Lack of mineralogical data prevents further speculation with regard to this trend. The amount of clay within each soil profile behaves erratically, reflecting more depositional features than pedological ones.

Table V. Mechanical composition of soil profiles 33, 34, 4, and 7, Wright Valley (< 2 mm)

Profile No.	Depth, cm	Sand, 2.0-0.05 mm	Silt, 0.05-0.002 mm	Clay, <0.002 mm
33	0-3	99.3	0.3	0.4
	3-5	99.2	0.5	0.3
34	2-6	96.5	4.9	1.6
	6-15	97.3	2.0	0.7
	15-25	93.9	5.5	0.6
	25-30	94.7	4.7	0.6
	30-37	90.5	8.5	1.0
4	2-8	89.2	7.2	3.6
	8-14	90.9	5.5	3.6
	14-20	92.8	5.5	1.7
	20-24	88.8	8.5	2.7
	24-28	77.8	18.3	3.9
	28-38	79.8	12.9	7.3
7	38-45	84.6	9.4	6.0
	2-17	73.3	23.7	3.0
	17-27	77.2	20.2	2.6
	27-40	69.7	27.2	3.1

Conductivity readings expressed in millimhos (Table IV) are strikingly high for the soils derived from the early stage of the Trilogy Glaciation compared with those of the late episode. These readings are comparable only if sampling has proceeded in similar well drained sites with the same exposures and with the same lithology. Irrespective of the age of the deposits, conductivity values are always high at the soil surface. Chlorides as well as the percentage of free iron oxides also reflect this condition. The soil reaction is always alkaline, with higher pH values near the surface.

Table VI. Partial chemical data of soil profiles 33, 34, 4, and 7, Wright Valley (< 2 mm)

Profile No.	Depth, cm	pH	Electrical Conductivity, Mmhos/cm	Cl, mg/liter	SO ₄ mg/liter	Free Iron Oxides, %
33	0-3	7.8	0.20	60.0	104.6	0.22
	3-5	7.8	0.07	106.0	81.5	0.20
34	2-6	8.8	3.03	1 060.0	197.4	0.38
	6-15	7.6	2.15	633.7	287.8	0.20
	15-25	7.5	1.45	286.2	172.7	0.23
	25-30	7.1	1.26	438.7	106.9	0.16
	30-37	7.5	0.91	235.0	90.5	0.21
4	2-8	7.7	9.25	3 146.8	492.7	0.44
	8-14	7.4	2.56	559.4	394.7	0.48
	14-20	7.5	1.09	889.1	855.3	0.49
	20-24	7.5	0.74	129.8	803.7	0.54
	24-28	7.4	3.44	1 135.5	427.7	0.54
	28-38	8.5	3.44	1 145.5	488.3	0.46
7	38-46	7.1	2.63	792.5	394.7	0.44
	2-17	7.4	12.50	4 384.2	450.6	0.44
	17-27	7.1	9.00	3 080.4	450.2	0.42
	27-40	7.2	2.20	625.3	285.2	0.38

DISCUSSION

Under the desertic environment now existing in Antarctica, only restricted areas escape the prevailing drought of the continent. Exceptions to these dry conditions are limited areas adjacent to glaciers, where for a few weeks at the height of summer melted water saturates the ground and allows a free circulation of water in the soil.

A special case of moisture availability is the thin veneer of drift that rests on glacier ice. Here the thickness of the drift controls the melting of the ice below, and hence the quantity of water available for moistening the soil. While a more de-

tailed discussion will be presented on this problem, interest at the moment is focused on the majority of the soils, the ones not provided with an ample water supply.

Profile 34 exemplifies one of these conditions. In spite of the arid environment, moisture fluctuations during a 24-hour cycle (Fig. 2) are indicative of the dynamic aspect of soil moisture. Several mechanisms can invoke these moisture variations, namely temperature gradient, evaporation, and condensation. Moisture movements in soils and porous materials under the influence of a temperature gradient have been the object of numerous investigations [14 to 19]. Experimental work [15, 18] has shown that in a closed soil system subjected to a temperature gradient, soil water largely in a vapor phase tends to move from the hot to the cold end of the system. Depletion of moisture at the hot end and its accumulation at the cold end creates a moisture gradient which induces a return flow of liquid water toward the hot front.

The distribution of soil water at maximum and minimum of the diurnal temperature cycle in Fig. 2 suggests that to an extent a similar mechanism may be involved. Moisture accumulation in the lower part of the soil profile (cold end) and a saline layer at the warm end (soil surface) could be interpreted as the result of downward movements of water vapor and upper migration of liquid water during the short summer. While theoretically this is possible, and while there is ample field and analytical evidence that liquid water has moved upward, there are no direct proofs that this process can still take place. The meager quantities of water recorded and the salinity of the soil are limiting factors for such processes.

At night, since that part of the valley is in shade, cooling is rapid. The soil surface becomes another cold front in addition to the ice-cemented layer. A warm zone exists below the surface. The zone is the site where diametrically opposite vapor flow may start. The ascending component, while penetrating the cold soil, is apt to lose its moisture by condensation. Condensation, coupled with a reduction of evaporation, tends to prevent a rapid loss of water. Consequently, moisture accumulates at the surface, as shown in Fig. 3.

As previously mentioned, moisture migration studies under the influence of a thermal gradient have been made in closed systems. In an open system, such as soil, temperature gradients may not be entirely responsible for maintaining a moisture gradient across the soil profile. A similar gradient can be obtained just by evaporation at the soil surface. Evaporation at the surface is illustrated in Fig. 4, where fluctuations of ascending moisture during the day are evident.

A moisture gradient in the soil profile generated and maintained by the combined effects of temperature and evaporation should impose a predominantly ascending trend to the soil moisture. As far as soil formation is concerned, however, the fact to establish is whether, due to the paucity of soil moisture, water migration occurs mainly in a liquid or in a vapor phase. A prevalent vapor phase will strongly impede further development of the soil. A combined liquid and vapor phase will still permit, even if at low magnitude, a continuation of soil formation.

An analysis of literature shows that movement of liquid water may occur at a very low moisture range. Richard and Weaver [20] report that water in sand still moves at a tension of 15 atmos. Migration of liquid water in sand at a moisture level of 0.5 and 1.0% was detected by Wheeting [21]. Smith [17] indicates that moisture movements due to temperature gradient are confined to funicular water. The optimum is reached when the relative humidity in the soil is about 75 to 99%. Migration ceases near moisture equivalent.

An adverse factor for this migration is low temperature, which tends to increase the viscosity of water. In the moisture range present in profile 34, water is mainly held as a thin film around the soil particles, and it is unlikely that it would be frozen. Lovell [22] has demonstrated that substantial portions of water remain unfrozen at temperatures as cold as -25°C . This is especially true at low moisture ranges where the freezing point depression is greatly controlled by suction.

A simple experiment previously described indicates that under the impact of a thermal gradient, liquid soil moisture

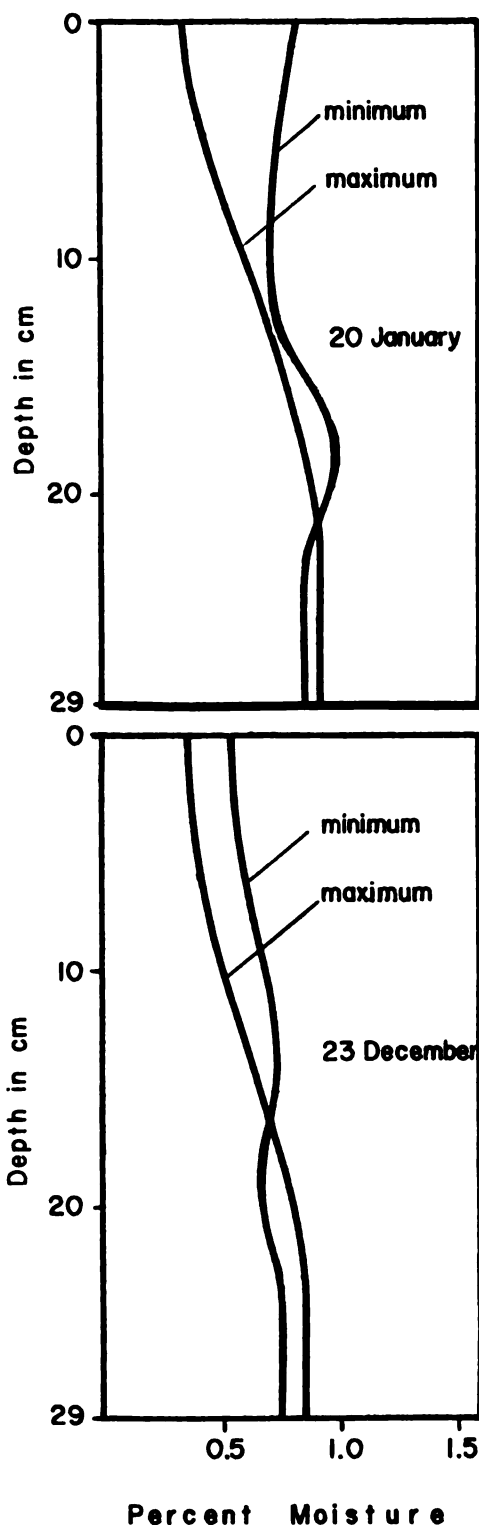

Fig. 3. Diurnal soil moisture in profile 34

moved toward the warm side—as evidenced by an increase in salt content at this end. The original moisture content of the soil was 1%, the same amount as recorded in the lower part of profile 34. This migration took place with a continuous temperature gradient ten times greater than the one recorded in the field. Rollin et al [16] and Trejo [19] report that, while the magnitude of a temperature gradient affects the flow and distribution of moisture, it does not alter, within certain limits, the qualitative nature of the process.

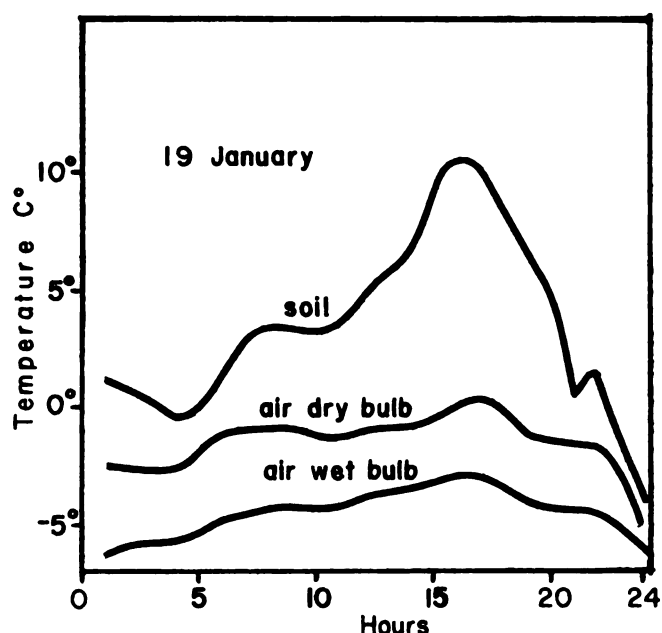

Fig. 4. Daily temperature fluctuations at the surface and at 10 cm above the soil in profile 34

The presence of a salt enriched layer near the surface of profile 34 may play, as Wheeting has shown, an additional role in attracting water toward the surface. On the other hand, the same salt concentration may also act as a barrier for moisture migration. On the basis of all the information collected, one cannot establish conclusively whether or not liquid water migration can still flow at the present. If liquid migration should take place, it would be limited to the lower part of the profile below the saline layer. These conclusions are also valid for profiles 4 and 7 which, together with profile 34, are derived from areas of very limited moisture.

An entirely different situation with regard to water availability is offered by profile 33. This profile, consisting of a thin layer of drift resting on the ice of the Lower Wright Glacier, although far from displaying the morphology of a normal soil profile, contains the incipient features common to ahumic soils of the region. What makes this soil unique, however, is the abundance of water. Moisture measurements for December and January reveal conditions approximating saturation, while a few hundred yards away on the moraines of the intermediate stage of the Trilogy Glaciation an extremely dry environment exists. Upward movement of capillary water takes place under the influence of a sharp moisture gradient maintained by a constant evaporation of the surface. Of the incoming solar radiation that strikes this veneer of drift, only a portion is left to melt the ice; the rest is used in providing energy for evaporation and loss by the outgoing radiations.

As the thickness of this layer increases, the rate of ablation decreases until ablation ceases, and the ice is preserved from direct melting [23]. This is exemplified by the ice-cored moraines of the intermediate stage (Trilogy Glaciation) where the ice-cemented layer has receded below the point where, under the present climate, no further melting can occur. Moisture transfer from this point can only take place through sublimation of the ice-cemented layer which, unless replenished, will tend to deplete with time. In well drained sites, however, the net balance is negative; the ice-cemented layer loses more water than it gains. Consequently, early glaciated areas should display a thicker soil layer. Field observations along a transit starting from the younger to the older moraines of the Trilogy Glaciation show clearly that depth to the ice-cemented layer tends to increase from 15 to 78 cm. Measurements were taken on comparable positions with regard to slope and exposure; tops of knobs were chosen where snow does not tend to accumulate.

Soil Genesis

Soil distribution along a transit from old to young glacial deposits of the Trilogy Glaciation has shown that soil formation and age of deposits go hand-in-hand. While the nature of the processes remains virtually the same, older soils show an accentuation in soil development and in soluble constituents. The progressive enrichment of products of decomposition in the profile is evident from partial chemical analysis. Soluble salts such as NaCl, CaSO₄, and MgSO₄, as identified by X-ray analysis, are major constituents affected by water migration. Since leaching is at a very low level, these products tend to persist in the soil.

Chemical weathering, often discarded or considered negligible for polar regions, appears more and more evident in the course of recent studies in Antarctica. Glazovskaia [1], Markov [5], and Gibson [24] have discussed weathering in Antarctica and all agree that the liberation of some soluble salts is a direct result of contemporaneous chemical alteration. Weathering alone, however, cannot account for the extensive concentration of salts. Chlorides, a predominant form of salts in Lower Wright Valley, are commonly reported in arid regions and in evaporite sediments. Their origin may be polygenic inasmuch as past volcanic activities and airborne salts from the ocean may have contributed to their accumulation in the valley. The occurrence of chlorides in other areas of Antarctica, lacking evidence of volcanic activities and far from an open sea, suggests that the chlorides were probably derived from weathering of local rocks. For the sulfates, Nichols [4] suggested a reaction between sulfuric acid produced from oxidation of pyrite and cations supplied by minerals present in the soil.

Soil development on the Trilogy moraines is closely related to the glacial history of Lower Wright Glacier. When ice stood some 5 to 6 miles west of the present position, conditions in front of the glacier were not very different from now. If a climate similar to the present one is postulated, then the soils in front of the glacier were, as they are now, well supplied with water. During this period, therefore, because of prevailing upward water migration, salts and other soluble material were translocated to the surface. This active stage in water migration would tend to repeat itself along the valley as the ice progressively retreated. Soil formation followed the retreating ice front and continued until liquid water could still move in the medium. Vapor movements upon condensation can provide moisture for hydration but cannot actuate ionic transfer. In the course of time intermittent mild seasons may have produced a temporary increase in water supply through additional snow melting or local seepage. This would reactivate the processes that had become dormant or had come to a halt. Due to the high solubility of the compounds present in the soil, a minor augment in the water regime will affect greatly the mobility of these salts. Since aerobic conditions prevail, the substratum is gradually oxidized and reddish colors are common in older conditions. Salts, and to a certain degree free iron oxides, may then be used as criteria for soil development.

CONCLUSIONS

Soil formation in glaciated areas of Lower Wright Valley takes place under very arid conditions. Only limited areas next to the glacier, or where the glacier ice or ice-cemented layer is near the surface, may enjoy a relatively moist regime. Soluble salts tend to accumulate at the surface as a result of upward water migration. Well-drained sites not resupplied with water from melted snow show a depletion of the ice-cemented layer with time. Consequently, the solum tends to become thicker. Salt accumulation and degree of oxidation, together with the thickness of the soil, may be used as criteria for soil development. Some of the soils in the area probably are no longer forming, some are active only below the haliferous layer, and some are entirely active. Only a study of water regime can establish at what stage a soil may be. Intermittent or cyclic warming periods may provide additional moisture and reactivate processes that have ceased. Among the soils examined, how-

ever, it seems that the processes occurring on the active soils are not qualitatively different from the ones which occurred in the past.

ACKNOWLEDGMENTS

Appreciation is expressed to B. Csejtey, Jr., of Princeton University for field assistance, to V. Havens of Rutgers University for suggestions on meteorological interpretation, to R. B. Alderfer of Rutgers University for his help in soil moisture movements, to J. C. F. Tedrow for his critical review of the manuscript, to W. S. Weyant, U. S. Weather Bureau, for supplying meteorological data, and to the U. S. Navy "Deep Freeze 62 and 63" for logistic support.

REFERENCES

- [1] M. A. Glazovskaia. "Weathering and Primary Soil Formation in Antarctica," Scientific Paper of the Inst., Moscow Univ., Faculty of Geog., No. 1, 1958, pp. 63-76, (Text in Russian).
- [2] J. D. McCraw. "Soils of the Ross Dependency, Antarctica," New Zealand Soc. Soil Sci. Proc., Vol. 4, 1960, pp. 30-35.
- [3] J. C. F. Tedrow, F. C. Ugolini. "Antarctic Soils," unpublished monograph.
- [4] R. L. Nichols. "Geologic Features Demonstrating Aridity of McMurdo Sound Area, Antarctica," Am. J. Sci., Vol. 261, 1963, pp. 20-31.
- [5] K. K. Markov. "Some Facts Concerning Periglacial Phenomena in Antarctica," Herald of Moscow Univ., Geog. No. 1, 1956, pp. 139-148, (Text in Russian).
- [6] C. C. Nikiforoff. "General Trends of the Desert Type of Soil Formation," Soil Sci., Vol. 43, 1937, pp. 105-131.
- [7] B. C. McKelvey, P. N. Webb. "Geological Investigations in Southern Victoria Land, Antarctica, Part 3 - Geology of Wright Valley," New Zealand J. Geol. Geophys. 5, 1962, pp. 143-162.
- [8] R. L. Nichols. "Multiple Glaciation in the Wright Valley, McMurdo Sound, Antarctica," 10th Pacific Sci. Congr. Pacific Sci. Assoc., Abstr. Symp. Papers, Honolulu, 1961, p. 317.
- [9] C. Bull, B. C. McKelvey, P. N. Webb. "Quaternary Glaciations in Southern Victoria Land, Antarctica," J. Glaciology, Vol. 4, 1962, pp. 63-78.
- [10] G. A. Llano. "The Terrestrial Life of the Antarctic," Sci. Am., Vol. 207, 1962, pp. 213-230.
- [11] V. J. Kilmer, L. T. Alexander. "Methods of Making Mechanical Analyses of Soils," Soil Sci., Vol. 68, 1949, pp. 15-24.
- [12] V. J. Kilmer. "The Estimation of Free Iron Oxides in Soils," Soil Sci. Soc. Am. Proc., Vol. 24, 1960, pp. 420-421.
- [13] Diagnosis and Improvement of Saline and Alkali Soils, U. S. Dept. Agr. Handbook 60, L. A. Richards, ed., Gov. Printing Office, Washington, D. C., 1954.
- [14] G. J. Bouyoucos. "Effect of Temperature on Thermo-Movement of Water Vapor and Capillary Moisture in Soils," J. Agr. Research, Vol. 5, 1915, pp. 141-172.
- [15] C. G. Gurr, T. J. Marshall, J. T. Hutton. "Movement of Water in Soil Due to a Temperature Gradient," Soil Sci. Vol. 74, 1952, pp. 335-345.
- [16] R. L. Rollin, M. G. Spangler, Don Kirkham. "Movement of Soil Moisture Under a Thermal Gradient," Highway Res. Board Proc., Vol. 33, 1954, pp. 492-508.
- [17] W. O. Smith. "Thermal Transfer of Moisture in Soils," Trans. Am. Geophys. Union, Vol. 24, 1943, pp. 511-523.
- [18] S. A. Taylor, L. Cavazza. "Movement of Soil Moisture in Response to Temperature Gradients," Soil Sci. Soc. Am. Proc., Vol. 18, 1954, pp. 351-358.
- [19] J. H. Trejo. "Water Movement in Soils Under Thermic Potentials," master thesis, Princeton Univ., 1945.
- [20] L. A. Richard, L. R. Weaver. "Moisture Retention by Some Irrigated Soils as Related to Soil-Moisture Tension," J. Agr. Research, Vol. 69, 1944, pp. 215-235.
- [21] L. C. Wheating. "Certain Relationships Between Added Salts and the Moisture of Soils," Soil Sci., Vol. 19, 1925, pp. 287-299.
- [22] C. W. Lovell. "Temperature Effects on Phase Composition on Strength of Partially Frozen Soils," U. S. Highway Res. Board, Bull. 168, 1957, pp. 74-95.
- [23] G. Ostrem. "Ice Melting Under a Thin Layer of Moraine, and the Existence of Ice Cores in Moraine Ridges," Geog. Annaler, Vol. 41, 1959, pp. 228-230.
- [24] G. W. Gibson. "Geological Investigations in Southern Victoria Land, Antarctica," Part 8, New Zealand J. Geol. Geophys., Vol. 5, 1962, pp. 361-374.

CONTRACTION THEORY OF ICE-WEDGE POLYGONS: A QUALITATIVE DISCUSSION

ARTHUR H. LACHENBRUCH, Geophysicist, U.S. Geological Survey, Menlo Park, Calif.

The upper ten meters or so of permafrost often contains vertical vein-like masses of foliated ice that intersect one another to form a honeycomb structure with a mesh commonly on the order of a few ten's of meters. The veins of ice are called "ice-wedges" (Fig. 1). Differential thawing of surficial material sometimes etches out troughs on the surface above ice-wedges. Such troughs delineate, on the ground surface, the trace of the ice-wedge honeycomb. When this surface pattern is obvious it is referred to as "ice-wedge polygons" (Figs. 2, 3, 4). ("Polygon" referred to ground patterns generally means a closed, roughly equidimensional, figure bounded by several sides, some or all of which may be curved).

Ice-wedge polygon patterns closely resemble patterns formed by cracks in drying mud, a phenomenon to which they are related in a fundamental way. The size of polygons, and hence the spacing of ice-wedges, varies from a few meters to more than 100 m, and the depth of wedges varies from a meter or so to more than 10 m. Wedges may be one centimeter to several meters wide at the top and they commonly taper downward.

As ice-wedge polygons are the most conspicuous surface feature over tens of thousands of square miles of arctic terrain, they have been widely discussed by arctic travelers with

backgrounds in many disciplines and are the subject of an extensive literature. During the last decade there has been an increasing interest in ice-wedges on the part of Pleistocene geologists with the growing realization that they can yield much information about past climatic and geomorphic events [1, 2, 3, 4]. Surprisingly, the subject has received very little attention from American engineers in spite of the fact that differential thawing of ice-wedge polygons is one of the most conspicuous causes for failure of structures, roadways, and airfields in the Arctic (Fig. 5).

Many hypotheses for the origin of ice-wedge polygons have been advanced. Historical accounts and detailed discussions in the English language can be found in comprehensive works by Leffingwell [5, 6], Black [7, 8, 9] and Washburn [10]. One hypothesis, the so-called thermal contraction theory, seems to have overwhelming evidence in its favor and is subscribed to in one form or another in most of the recent work [2, 7, 8, 9, 11 to 16]. It was first set forth clearly by Leffingwell [5, 6] whose discussion is summarized [14] as follows:

During the arctic winter, vertical fractures several millimeters wide and a few meters deep (Fig. 6A) are known to form in frozen tundra—a process generally accompanied by loud reports. They are assumed to be the result of tension caused by thermal contraction of the tundra surface. In early spring it is supposed that water from melting snow freezes in these cracks and, with accumulating hoarfrost, produces a vertical ice vein that penetrates permafrost (Fig. 6B). Horizontal compression caused by reexpansion of permafrost during the following summer results in the upturning of permafrost strata by plastic deformation. In the winter that follows, renewed thermal tension supposedly reopens the vertical ice-cemented crack which is presumed to be a zone of weakness. Another increment of ice is added when spring meltwater enters the renewed crack and freezes. Such a cycle acting over centuries, it is argued, would produce vertical wedge-shaped ice masses (Fig. 6C and D). The polygonal configuration is generally thought to be a natural consequence of a contraction origin.

Such a qualitative hypothesis poses many questions, the foremost of which is, "Will it work?"; i. e., are these processes compatible with thermal and mechanical properties and thermal regime of the terrain in which they are supposed to occur? In an attempt to answer this question and to gain a



Fig. 1. Intersection of three ice-wedges exposed on an undercut bank of Elson Lagoon near Barrow, Alaska (photo by Gordon W. Greene)

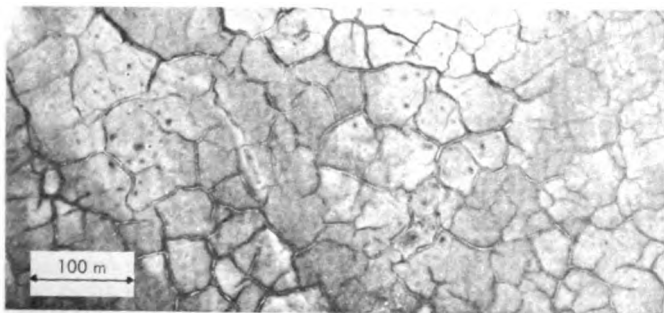

Fig. 2. Irregular random orthogonal ice-wedge polygons in a recently drained lake bed, Northern Alaska



Fig. 3. Regular random orthogonal ice-wedge polygons in Northern Alaska

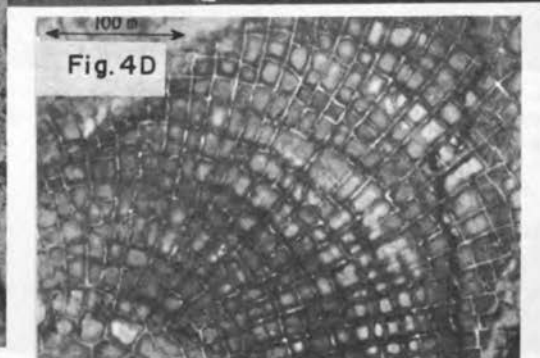
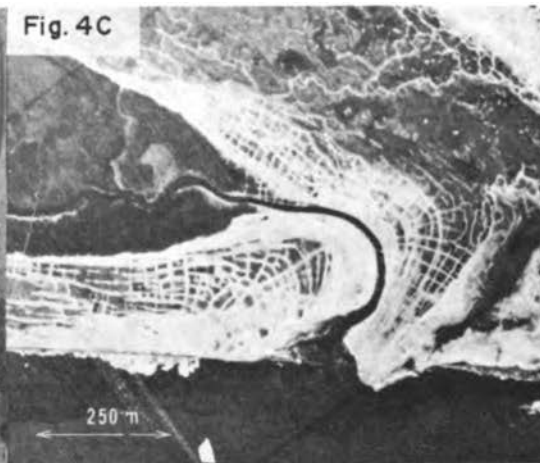
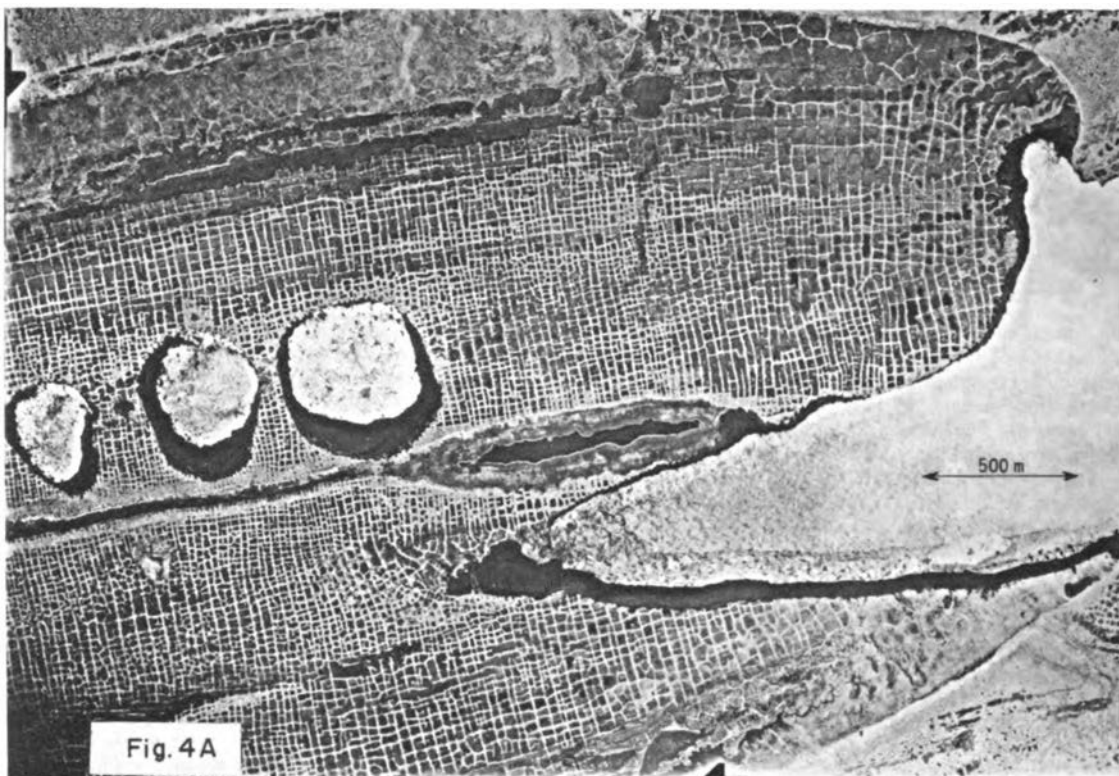

Fig. 4. Oriented orthogonal ice-wedge polygons associated with regressing shorelines in Northern Alaska. **A.** Rectangular pattern generated long ago by the draining of large lake basin, limits of which are seen in upper left, upper right, and lower right. That small lakes (containing ice) are growing can be ascertained by their discordant relation to pattern. **B.** Pattern generated on slip-off slopes by migrating meanders. **C.** Recession of bluffs bordering Arctic Ocean (bottom) is causing lake (remnant in left center) to drain. Oriented orthogonal system developing where slope is steep enough to give slow regression. **D.** Radial pattern caused by regression of estuarine shoreline toward lower left



Fig. 5. Roadway destroyed by thawing of ice-wedge tops at Umiat, Alaska. Gravel fill was not thick enough to replace insulating effect of the organic mat which it destroyed (photo by Gordon W. Greene)

better understanding of the mechanisms involved, the theory was investigated from the physics viewpoint insofar as existing data warranted [14, 17]. The present paper contains a qualitative discussion and elaboration of some of the findings.

SOURCE OF THE STRESS

In the Arctic, temperatures at the earth's surface fluctuate on the order of 25°C about the mean through the combined effects of changing seasons, and shorter period random and diurnal changes. More than 90% of this fluctuation is confined to the surficial 10 m; at a depth of 20 m temperatures remain steady and always within a few hundredths of a degree of their mean annual value [18]. When temperatures fall in winter, surficial layers "try" to contract but they are constrained by the stable underlayers. Thus, surface layers are stretched in a sense, although no observable displacements occur. This invisible stretching is best visualized by imagining the ground to be made of horizontal thin lubricated plates which are dissected by vertical cuts. As surficial layers cool the plates would contract causing the cuts to widen. The thermal stretching ("thermal strain") is that which would be caused by forcing closing of the cuts.

Thus, horizontal thermal strain is easily calculated as the product of the expansion coefficient and the change in temperature from its initial value. (Thermal strain is generally greater where the ice content is high, as the expansion coefficient of ice is about five times that of most silicates). It is the stress produced by this stretching, however, not the strain, that determines whether cracking occurs. To determine stress from a complete knowledge of strain, it is necessary to know how the two are related, (the "deformation law"), for the medium of interest.

Because little is known about the relationship between stress and strain for various permafrost materials, it is not possible to make a direct stress calculation from a knowledge of the temperature (and hence the strain) with confidence. An alternative approach to the stress problem is to look for a deformation law that will do the job required by the contraction crack theory, and if one is found, to see whether or not it is excluded by the fragmentary laboratory evidence [19, 20].

For example, permafrost materials seem to behave elastically in response to the rapid deformation associated with the transmission of sound waves. If we assume that they also behave elastically in response to the slower natural thermal deformations, the stress would simply be proportional to the amount that the temperature drops from some reference temperature (taken to be the mean annual value). Then using the elastic constants determined from sound transmissions, we

find that stresses on the order of the tensile strength would develop in ice-saturated frozen ground when the temperature dropped only 2° or 3°C, and general cracking would occur early in the fall. Furthermore, mid-winter thermal stresses would be an order of magnitude greater than the strength, and open cracks should occur everywhere with a horizontal spacing no greater than crack depths [14]. As these things do not generally happen, simple elastic behavior must be excluded. Alternatively, if laboratory tests were to reveal elastic behavior, the contraction crack theory would have to be judged incompetent and discarded.

If a viscous deformation law is assumed, the stress would not be proportional to the amount that the temperature drops, as in the elastic case, but to the rate at which it drops. (The net effect of the viscous flow is to cause vertical thinning as the ground is stretched by horizontal tension.) Then if the viscosity is adjusted to give the required stress at the ground surface, stresses at the top of permafrost are unreasonably low, for field evidence suggests that some cracks initiate there (as explained in the next section).

Thus the analysis of these simple models suggests that stress is not simply proportional to either amount of cooling or rate of cooling, but that it depends upon them in a nonlinear way. Glaciologists, experimenting with polycrystalline ice under similar stress regimes, have also found nonlinear behavior [21, 22, 23, 24]. They commonly describe their results by a "power law" wherein stress is proportional to a fractional power of the rate of deformation.

Using such a relation with the experimentally determined parameters for polycrystalline ice leads to a thermal stress regime in permafrost consistent with the observed temperature regime and the mechanical requirements of the contraction theory of ice-wedge polygons [14]. In these relations, the parameter playing the role analogous to viscosity, increases sharply with decreasing temperature, with the result that much

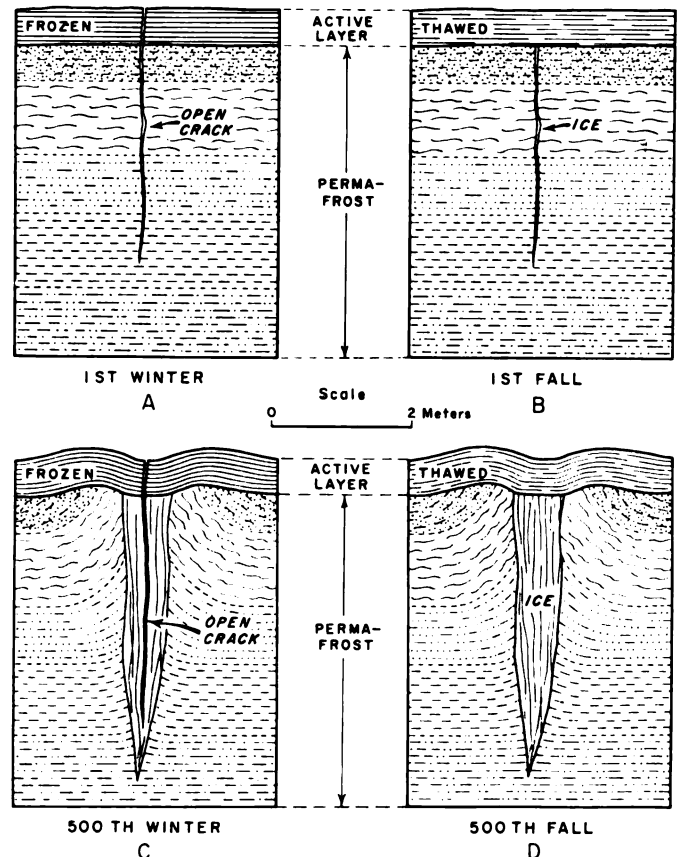

Fig. 6. Schematic representation of the evolution of an ice-wedge according to the contraction-crack theory

greater tension is developed at a given cooling rate when it is occurring at a lower temperature (i.e., the material is less plastic at low temperature).

Although the power-law behavior is not inconsistent with available experimental results, many other rheological models equally consistent with them would also meet the restrictions imposed by the contraction theory. Thus additional laboratory work on the deformation of the great variety of materials called "permafrost" is needed to refine our knowledge of naturally occurring thermal stress.

ORIGIN OF THE CRACKS

From the discussion of thermal stress, it seems clear that both low temperature and rapid cooling rates favor large stresses, and, as both of these quantities attain greater extremes at the ground surface than at depth, the greatest thermal tensions probably develop at ground surface. It would therefore seem natural to infer that recurring contraction cracks that give rise to ice-wedges must initiate at the ground surface. This inference, however, leads to a paradox, because many, if not most, ice-wedges have no surface expression; they are overlain by 15 to 100 cm of relatively homogeneous active-layer material which is thawed and recemented annually. Hence, there seems to be no good reason why cracks initiated at the ground surface should recur over buried ice-wedges. Where wedges are overlain by troughs, the situation is even more puzzling, as the insulating effect of snow accumulating in the troughs would tend to make the troughs low stress regions and actually discourage crack initiation over ice-wedges.

It therefore seems likely that the recurring cracks that cause the growth of most ice-wedges, initiate in the tops of ice-wedges beneath the active layer. In such cases wedge ice must be so much weaker than the frozen active layer sediments that it cracks first in spite of the fact that it is subject to less stress. Laboratory results suggest that wedge ice is indeed weaker than most ice cemented sediment, but more measurements are needed [pp. 8, 9, ref. 14]. If the active layer should have little or no strength (e.g., where it is dry soil), recurrent local cracking from the top of permafrost to form wedges is still to be expected as long as the permafrost itself is stronger than the wedge ice. Where the frozen active layer is only slightly stronger than wedge ice, or the permafrost is no stronger, it is unlikely that cracks would recur systematically to form well defined ice-wedge polygons.

It would seem from the above discussion that criteria for the cracking of ice-wedges (i.e., for the activity or dormancy of ice-wedge polygons) are most easily formulated in terms of conditions at the top of permafrost, not those at the ground surface. For example, if permafrost has the mechanical properties of polycrystalline ice, and wedge ice has a tensile strength of 3 to 5 bars, then ice-wedge growth might be expected where minimum winter temperatures are below about -15 to -20°C at the top of permafrost, because cooling rates common at the top of permafrost could lead to the necessary stress at such temperatures [14]. (It is worth noting that thermal conditions at the top of permafrost are much more uniform from place to place than those at a given depth, say 10 cm, as the effects of variation from place to place of climate and thermal properties of the surficial material are to some extent compensated by the varying thickness of the active layer [25]).

Although the recurring cracks that cause growth of ice-wedges evidently initiate near the top of permafrost, the original cracks that start ice-wedges and determine their locations probably initiate at the ground surface. Both kinds of cracking must occur where new wedges are forming and old ones are growing (e.g., the Alaskan arctic slope).

MECHANICS OF FRACTURE—CRACK DEPTH

Up to this point it has been tacitly assumed that a crack will initiate in a given medium if and when the tensile stress exceeds some critical value—the "tensile strength." However, for an understanding of the cracks that lead to ice-wedges in

permafrost, it is necessary to consider the mechanics of fracture in more detail. For this purpose, we shall use the theory of fracture developed by Griffith [26, 27] for brittle media and extended by Irwin [28, 29, 30] and by Orowan [31] to materials that undergo local plastic deformation under stresses attending fracture.

It takes energy to lengthen a crack, first to overcome the forces of cohesion to produce new surfaces, and second, in a brittle-plastic medium, to do the work of plastic deformation in the region of elevated stress near the crack tip. But when a tension crack lengthens, it relieves some of the tension that produced it, and, hence, strain energy is released from the medium. This is the source of energy required for crack extension. Thus, a crack will lengthen if, and only if, by so doing it releases at least as much (strain) energy as it consumes near the crack tip.

In a medium under uniform tension, the amount of strain energy (G) released with the creation of a new square centimeter of crack surface increases with the length of the crack and the magnitude of the tension. As the applied tension is increased in a brittle-plastic medium, a value of (G) is reached at which small flaws start to grow and coalesce to form minute cracks. The growing cracks release progressively more strain energy by virtue of their increased length, but at the same time, the size of the plastic zone near the tip grows, and, hence, so does the rate of energy consumption. If the rate of energy consumption overtakes the rate of energy release, crack growth stops, and it will not start again until the applied stress is increased further. Such a process is called "stable" cracking, because it is self-arresting [32].

As cracks continue to lengthen stably in a brittle-plastic medium, the increase in plastic-zone size becomes relatively less important, and ultimately a crack length is reached at which the rate of energy release is growing faster than the rate of energy consumption with increasing crack length. At this point the crack will extend with no further increase in applied stress, and "unstable" fast fracture begins. The applied stress at which small cracks commonly attain this critical length in a uniformly stressed specimen of reasonable size is called the "tensile strength." It can be identified with a critical value of the rate of strain energy release (or consumption) per square centimeter which Irwin [28, 29] denotes by G_c . The higher the value of G_c for a medium, the greater its resistance to fracture. If the rate of energy release (G) for a given crack is less than G_c , propagation, if it occurs, will be slow and stable; if it is greater, excess energy is available to accelerate crack extension to cause fast fracture.

Very likely most cracks that cause ice-wedge growth initiate in flaws along the vertical foliation near the top of the wedge. They probably propagate upward through the highly stressed active layer to the surface, attaining large values of G that permit them to extend unstably downward through the wedge often to depths of several meters. It is known from the sounds and earth tremors associated with ice-wedge cracks that they propagate unstably [6].

At what depth does the crack stop? If the medium were uniformly stressed and homogeneous, G would continue to increase and the crack would deepen until it broke the medium (in this case the earth) into two or more pieces. The permafrost is, of course, not uniformly stressed because the thermal tension is confined to the surficial few meters; at depth, the stress is dominated by compression resulting from the weight of overlying material. As the crack grows downward from the surficial tensile zone into regions of slight tension and ultimately into regions of compression, the rate at which it releases strain energy diminishes progressively. The crack can be expected to stop at that depth at which the rate of energy release ceases to exceed the rate of energy consumption near the crack tip; or approximately at the depth at which G falls to G_c .

If the variation of stress with depth is known, it is possible to calculate G for a crack of any depth and, hence, to estimate crack depth in a medium of known G_c . As G_c has not been measured for permafrost materials (estimates for pure ice have been made by Gold [33]), it is necessary to estimate its

value, or alternatively to bracket the estimate of crack depth by assuming reasonable upper and lower limits to G_C . A safe upper limit to crack depth can always be obtained by finding the depth at which G falls to zero (as G_C must always be greater than zero).

Calculations based on measured temperatures and "power-law" deformation lead to theoretical values of crack depth consistent with those observed in northern Alaska [14].

It is commonly assumed that a tension crack will not penetrate deeper than the ambient tension, but will stop at the neutral horizon. (If this were true it would not be possible to split firewood.) Actually, a tension crack can continue to release deformation energy long after it penetrates the ambient compressional stress field, and most ice-wedges probably extend much deeper than the tension to which they owe their growth.

It is worth noting that the criterion for crack propagation $G > G_C$, implies that a crack can arrest either if G falls to G_C or if G_C "rises" to G as the crack deepens. Thus, in a stratified medium, cracks which are propagating unstably might suddenly arrest after entering a more plastic stratum (i.e., one with greater G_C). Many ice-wedges terminate abruptly just below stratification boundaries.

SPACING OF THE CRACKS—POLYGON SIZE

The spacing of the tension cracks that determine the loci of ice-wedges (those that initiate at ground surface) is probably determined by two quite independent factors: (1) Variation in strength of surficial materials from place to place, and (2) width of the zone of stress relief surrounding individual cracks.

Since all cracks can be visualized as initiating at zones of weakness or "flaws," the strength of a material depends upon the size and distribution of the flaws within it. The larger the flaw the lower its strength, i.e., the lower the applied stress under which it will grow unstably to cause fracture. Large flaws are generally less common than small ones, and in most media the flaws can be visualized as occupying a continuous frequency distribution ranging from large, very widely spaced (rare) flaws to small, closely spaced (common) ones. Thus, large samples tend to be weaker than small ones as they are more likely to contain a large flaw. Tensile strengths reported from laboratory tests are a measure of the strength of the largest flaws that are common in samples of the particular size used. Typical measurements of the "size effect" on fracture strength of brittle media yield strength reductions on the order of 20 to 50% when sample size is increased by a factor of 100 [30]. Thus if a 10 cm sample of the surficial material has a tensile strength of 20 bars, we might find that the weakest part of the tundra surface over a 10 m distance has a strength of 10 bars; over 1000 m distance, a strength of 5 bars, and so on.

As the surficial thermal stress builds up in early winter in a region devoid of ice-wedges, say a newly drained lake basin, the strength will be exceeded first at the largest flaws. Cracks spreading from these flaws will trace sinuous courses across the tundra, generally following zones of weakness. They will be widely spaced because large flaws are rare, and spacing will be irregular because such flaws are distributed randomly, in general. Each crack will relieve surficial thermal stress in its neighborhood and, hence, will be bordered by a "zone of stress relief," which, theoretical calculations suggest, will be significant to horizontal distances of a few crack depths [17] (distances on the order of 5 to 50 m in northern Alaska) [14].

A second parallel crack is unlikely to form in these zones of stress relief, a factor that would tend to keep the cracks from becoming very closely spaced. However, as long as the existing cracks have an average spacing that is large relative to the width of these zones, only a small portion of the surface will have experienced stress relief from cracking. (Strictly speaking, arbitrarily small amounts of stress relief are achieved at arbitrarily large distances from a crack [14, 17]. It is useful in qualitative discussions, however, to define the "width of the zone of stress relief" as the width of the band in

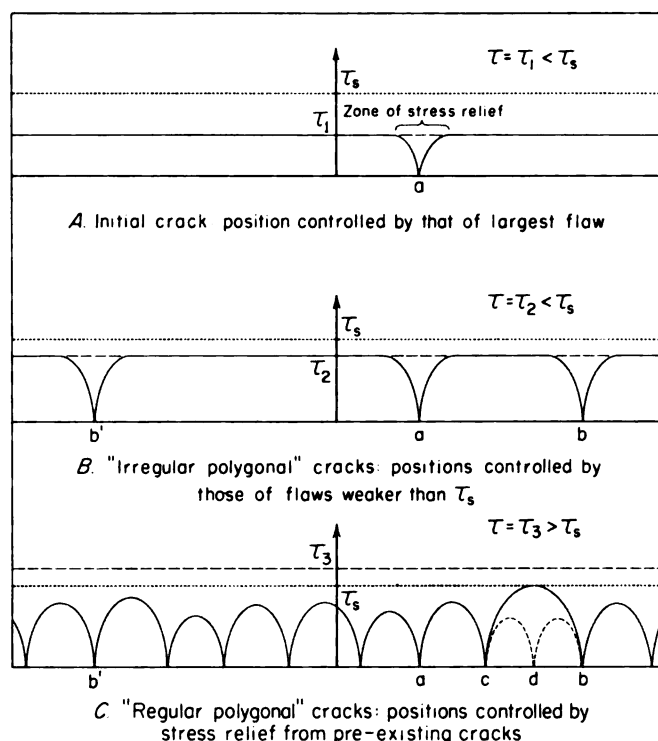

Fig. 7. Variation of stress over the surface during the evolution of contraction-crack polygons, τ is the thermal stress that would exist on an unfractured surface, and τ_s is the small-sample strength

which the stress relief is at least a few per cent of the stress that would obtain on the unfractured surface. In quantitative discussions, the functional dependence of stress on distance can be introduced.)

Further cracking under increasing thermal tension will continue to be dominated by the positions of randomly distributed flaws (Figs. 7A and B). At this stage the crack spacing would be so irregular that most observers would be reluctant to call the resulting pattern "polygonal." Crack patterns in this stage are sometimes seen in the basins of recently drained lakes in permafrost terrain (Fig. 2).

As the thermal tension continues to increase (first with the progressing season, and later with the occurrence of unusually cold years), progressively "smaller samples" of the tundra surface fracture, and a progressively larger portion of the surface is subject to stress relief from existing cracks. When thermal tension exceeds the strength of samples that are small relative to the width of zone of stress relief, hereafter called "small-sample strength," every point on the surface is subject to stress relief from at least one crack (Fig. 7C). Small-sample strength, as used here, is the strength of a sample which is small enough that the variation of stress within it, if it is in the zone of stress relief, can be considered negligible [26]. In general, the wider the zone of stress relief, the smaller the variations of stress with distance and the larger the "small sample."

At this stage the control of crack spacing has passed from the distribution of flaws to the distribution of stress relief from pre-existing cracks. The spacing of neighboring parallel cracks cannot be large relative to the width of the zone of stress relief, for otherwise a third crack would form between them. The spacing cannot be small relative to this width because of the rapid fall-off of stress near each crack (Fig. 7C). Actually on this simple model the crack spacing might be expected to vary by a factor of two, as shown by the following example; Suppose the small-sample strength (τ_s , Fig. 7) were 90% of the maximum thermal tension developed (τ_3 , Fig. 7C).

The greatest crack spacing possible is that for which two neighboring cracks each give 5% stress relief to the point midway between them (distance \underline{cb} , Fig. 7C). If they were slightly farther apart than this, or if the midpoint contained an unusual flaw, a subdividing crack would form (at \underline{d} , Fig. 7C) and the new system would represent the closest spacing permissible (distance \underline{cd} , Fig. 7C). Many details complicate this simple picture, but it is often found that systems of ice-wedge polygons that are considered "regular" have polygon diameters that vary by a factor of about two.

Thus, it would seem that rather regular crack spacing can be expected if the ratio of the small-sample strength to the surficial thermal stress (τ_s/τ) is less than unity. If it is greater than unity, polygons, if they occur, will tend to have irregular spacing in general. It is clear from Fig. 7C that, other things being equal, polygon size decreases with this ratio. For example, if in the previous illustration the ratio had been 0.5 (instead of 0.9), the crack spacing would be reduced substantially, because adjacent cracks would then have to give at least 25% stress relief (instead of 5%) to the point midway between them. Inasmuch as the stress falls off rapidly near a crack, the spacing becomes progressively less sensitive to this ratio as the thermal stress gets larger. Drier materials generally have lower expansion coefficients and, hence, smaller thermal strains and strain rates and lower thermal stress (τ) under a given thermal regime. They, therefore, tend to contain larger polygons unless the ice content is so low that the strength (τ_s) is reduced appreciably.

Considerations of the ratio of small-sample strength to thermal stress are not sufficient for a quantitative discussion of crack spacing. Once we have established from this ratio that neighboring cracks must each give at least $n\%$ stress relief to the point midway between them, we must then determine how far away from a crack $n\%$ stress relief is achieved, i.e., we must calculate the variation of stress within the stress relief zone. This was found to depend upon crack depth and the distribution of stress with depth, and, immediately after cracking, at least, is independent of the elastic parameters in a homogeneous medium. In general, for a given depth distribution of thermal stress, the deeper the crack the wider its zone of stress relief; and for a given crack depth, the deeper the penetration of tension the wider the zone of stress relief. Thus other things being equal, shallower cracks, and surficial concentration of thermal tension would be associated with smaller polygons. The use of temperatures measured in Alaskan permafrost, a "power-law model" to calculate thermal stress, and an estimated value of (G_C) to calculate crack depth, lead to computed stress relief compatible with observed polygonal dimensions [14].

CONFIGURATION OF THE CRACKS—POLYGONAL PATTERNS

In the discussion of crack spacing, it has been tacitly assumed that cracks are all parallel, as this simplifies the concepts and results in no significant alteration of the conclusions. We know, however, that the traces of the cracks on the ground surface form closed figures (polygons), and that the cracks are by no means mutually parallel. We consider now what determines the configuration seen on the surface.

Where the ground surface is homogeneous and previously uncracked, tensile stress in the surface is, in a general sense, isotropic (i.e., north-south tension is equal to east-west tension). Although tension cracks generally propagate perpendicular to the direction of greatest tension, no such direction exists in this case, and the course of a new crack is governed by randomly distributed zones of weakness and perhaps local stress concentrations. Such cracks follow a random, often sinuous, course in much the same way as a trickle of water would find its way across a relatively flat surface. After the crack has formed, however, the isotropy of the surficial tension is destroyed in a band surrounding the crack—its zone of stress relief. For where the crack trends north-south, the east-west component of tension is relieved much more than the north-south component within this zone. The anisotropy is greatest at the crack wall where east-west

tension falls to zero, while for a straight crack, the north-south tension persists at roughly three-fourths of its pre-cracking value [14]. Where the crack curves, the tangential component is somewhat greater on the convex side and somewhat less on the concave side. Thus, within the zone of stress relief of a crack the horizontal tension is anisotropic; it is least in the direction perpendicular to the crack, greatest in the direction parallel to the crack, and the tension parallel to the crack attains maxima on the convex sides of bends.

If a second crack, propagating across the surface in a random way, should enter the zone of stress relief of the first, the second crack would tend to alter its path in such a way that it trended perpendicular to the greatest tension, and, hence, would tend to intersect the first crack at right angles. Where the cracks are curved at the intersection, their tangents form right angles, i.e., the intersections, are "orthogonal." The convex sides of bends in the primary crack are favored as sites of orthogonal intersection because the residual tensions are greater there. The process of progressive subdivision of the surface under increasing stress could lead to a crack pattern in which orthogonal intersections predominate, for each crack must traverse the (anisotropic) zone of stress relief of the crack it intersects. As the first cracks are not oriented directionally, neither are the later ones; the pattern could be described as "random orthogonal polygons." Most of the contraction crack patterns seen in permafrost, mud, concrete, paint, ceramic glazes, and so on, appear to be of this type.

Polygons that form under a surficial thermal stress less than the small-sample strength (Fig. 5B) tend to have a crack spacing that is large relative to the width of the stress relief zone. Hence, much of each crack propagates in an isotropic, or weakly anisotropic, stress field where it is easily deflected into a sinuous course by randomly distributed flaws. Such polygons tend to have sinuous sides (as well as the irregular spacing discussed in the last section), i.e., sides whose radius of curvature is not large relative to the polygon diameters. It is useful to call them "irregular random orthogonal polygons."

Subdividing cracks that form after the thermal stress exceeds the small-sample strength (Fig. 7C) propagate entirely within the zone of stress relief of existing cracks, and, hence, their courses tend to be "smooth" because they are controlled primarily by anisotropy of the local stress field. Thus, their radius of curvature tends to be large relative to polygon diameters, and their spacing tends to vary by no more than a factor of about two. These patterns will be called "regular random orthogonal polygons." This qualitative distinction between regular and irregular random orthogonal polygons has proved useful in explaining occurrences of distinctly different contraction crack patterns. (It can be formulated quantitatively and applied to intermediate forms when our knowledge of the size effect on fracture of the pertinent materials warrants it).

Ice-wedge polygons on newly exposed surfaces are generally of the "irregular" type, presumably because they are dominated by the first-forming cracks (those that formed under a stress less than the small-sample strength) (Fig. 2). Most shallow desiccation cracks in mud and concrete form "irregular random orthogonal polygons," presumably because of the great small-sample strength resulting from large individual grains and other inhomogeneities.

In later stages of growth, ice-wedge polygons generally tend toward the "regular" pattern as they subdivide; and zones of stress relief are superimposed (Fig. 3). Thermal cracks in ceramic glazes and desiccation cracks in homogeneous silts and uniform fine grained concrete tend toward the regular random orthogonal type, presumably because very little cracking occurs before the small-sample strength is exceeded (i.e., the size effect on fracture strength is small).

Dostovalov attributes the orthogonality of ice-wedge polygons to secondary stress set up by cooling of the crack walls through air circulation. It is worth noting here that lack of air circulation in minute contraction cracks in ceramic glazes does not prevent formation of remarkably persistent orthogonal patterns.

Not all ice-wedge polygons are of the random type. In

some places, particularly at higher latitudes, the cracks bounding the polygons form throughgoing systems that persist for 10's or 100's of polygon diameters (Fig. 4). The intersections are orthogonal and the polygons are generally four-sided. When cracks are straight, they form two mutually orthogonal parallel systems to give the surface the appearance of a checker-board (Fig. 4A). Where cracks are curved, the orthogonality is preserved and the pattern calls to mind orthogonal curvilinear coordinate systems of geometry (Fig. 4B, 4C, 4D). These occurrences are so striking that they challenge the curiosity of the most casual observer. It is surprising that such a conspicuous feature seems to have a rather subtle explanation.

Where the temperature is not uniform over the surface, the horizontal tensile stress is not in general isotropic [p. 47, ref. 14]. Thus, if the near-surface temperature varies in the east-west direction and not in the north-south direction, as near a north-south trending lake shore, the components of tension in the two directions at any point will not in general be equal. At high latitudes in winter, the greatest departures from thermal uniformity occur beneath the edges of bodies of water. There the ice freezes to the bottom which subsequently becomes very cold; but the cooling lags behind that of the emergent surface by weeks or months depending on water depth, and, hence, distance from shore [34]. These peripheral shallow zones, which are underlain by permafrost at high latitudes, can, therefore, be expected to have anisotropic thermal stress in winter.

As lakes drain or river channels shift slowly, the first cracking of the newly exposed sediments would occur in this anisotropic border. If the direction of greatest tension is the one parallel to the shoreline, the first-forming cracks will be perpendicular to the shoreline. If the reverse situation obtains, the first cracks will be parallel to the shore. (Which one occurs evidently depends upon the configuration of the temperature field and the distance from shore of initial cracking within the border zone).

Stress relief by the first cracks causes the second cracks to form orthogonal to them as the thermal stress increases. Inasmuch as the first set is oriented, the second is also. Thus, a slowly regressing shoreline tends to leave in its wake an oriented orthogonal polygon system with one set of cracks (wedges) parallel to the old shoreline and the second perpendicular to it (Fig. 4). If the regression is fast (several polygon diameters per year), no such orientation would be expected.

Oriented orthogonal polygons are also caused by anisotropy of strength in terrain underlain by steeply dipping shales in Northern Alaska, by systematic topographic relief, and possibly by gravitational effects on slopes; but the most conspicuous occurrences seem to be those associated with old shoreline positions.

Not all contraction-crack polygon systems in nature are orthogonal. Non-orthogonal systems (often enthusiastically described as regular hexagons) sometimes form in response to thermal stress in cooling lavas, and they might, also, occur locally in permafrost. They are believed to be formed by successive branching of rapidly propagating cracks in brittle media in which the size effect on fracture strength is negligible [14].

ICE-WEDGES AND THE COMPLETE SEASONAL CYCLE

We have considered only the winter stress regime and the factors that control the position of cracks, because they are of primary importance in explaining the distribution of the ice-wedges that ultimately occupy the sites of these cracks. There are stress conditions and related problems at other times of the year.

Evidently thermal contraction in fall and winter can build up tension approaching the general strength, and then open up cracks. Since the horizontal thermal strain depends on the departure of the temperature from its mean annual value, it seems intuitively reasonable that thermal expansion in spring and summer would close these cracks and build up compressive stresses equal in magnitude to the winter tensions. This would

be true if it were not for the following factors: (1) Open cracks are commonly filled or partially filled in the spring with water which promptly turns to ice; (2) the material is systematically different during the compression cycle than it is during the tension cycle because its temperature is higher, and hence, it is more plastic; and (3) the stress and the vertical strain do not depend on the temperature and rate of temperature change in a linear way, and hence, they do not, in general, average out to zero through a complete seasonal cycle. Thus, an increment in its stress-free state might become longer and thinner or shorter and thicker during a complete seasonal cycle.

Some interesting long-range effects might be associated with factors 2 and 3, but they are probably less important than the first factor and very difficult to discuss in our present state of ignorance.

When spring melting commences at the ground surface, the surficial layers have already begun to expand and are probably in compression, but the cracks are evidently held open by residual tension in the colder layers at depth. Melt water draining into the cracks would freeze quickly because the spring temperatures in permafrost are far below the freezing temperature. If the crack is completely filled with water, the rapid horizontal strain resulting from expansion on freezing will cause substantial horizontal compression in the neighborhood of the wedge. This stress enhancement will fall off with distance from the wedge much as the stress relief does with distance from a crack. Maximum compression in summer is likely to occur in and around the wedge, because subsequent thermal expansion will add uniformly to the compression throughout each layer. The compression is relieved by a vertical thickening and shearing of the wedge and surrounding material; and this evidently accounts for the observed upturning of permafrost beds adjacent to ice-wedges [5, 6].

If the permafrost material which is extruded into the active layer has a finite shear strength when thawed, during subsequent summers it will accumulate to form ridges bounding the ice-wedge troughs. The resulting low-centered, or more properly raised-edge, polygons are found in relatively nonfluid media such as sands, long-fibered peats, and some silts. If the material forced from the permafrost is fluid when thawed, no ridges can be formed, and the polygonal pattern might be completely obscured by flowage of the active layer, or it might be delineated only by a depression over the ice-wedge and form high-center polygons.

This term is applied, also, to polygons in which the troughs have been deepened by erosion and peripheral ridges, if they ever were present, have been destroyed. Whether ridges ever form depends on properties of the surficial material and whether they are destroyed depends upon subsequent surface events [8]. The classification, high centered-low centered polygon, is genetically ambiguous and perhaps unnecessarily superficial. As mechanical processes that control polygonal microrelief operate at the edges, not the centers of polygons, a classification describing the edges seems more natural. The author has found it useful to use the terms "trough pattern," "ridge-and-trough pattern," "deep-trough pattern," "ridge-and-deep-trough pattern," and so on, to refer to them.

It is sometimes stated or implied that the expansion of freezing water in the seasonal crack forces the ground apart, thus causing the upturning of permafrost beds adjacent to ice-wedges. Although this process is probably effective in localizing stresses that cause upturning, the horizontal displacement caused by freezing (about 10% of the crack width) is smaller by an order of magnitude than that caused by re-expansion of the ground (enough to close the crack and more). Thus, the upturning of material is probably due primarily to adjustment attending reexpansion of the permafrost.

ICE-WEDGES AND THE ENVIRONMENT

How ice-wedge polygons modify their environment is the other side of the story [2, 8, 11, 13, 16, 35, 36].

Thermal effects of surface water channeled into troughs above ice-wedges tend to accentuate the troughs and thus to define the early phases of a drainage course. In this unique

erosion process no solids are removed as such. Wedge ice is just "slipped out from under the vegetation rug" by transfer of heat from the running water into and through the active layer. In later stages partial and complete removal of ice-wedges by thermal erosion cause beaded drainage and slow running streams too deep to ford but often narrow enough to jump.

Surface water seeping into partially sealed fractures in large wedges often follows the wedges, thawing large flat-floored caverns—sometimes large enough for a man to enter. By late summer, regions of substantial local relief are sometimes underlain by intricate systems of subsurface streams flowing through these intra-permafrost caverns in ice-wedges. Where the subsurface streams emerge at banks, collapse of the ice-wedge cavern roofs leaves deep gulleys. Such gulleys working headward along ice-wedge courses commonly drain large lakes that are otherwise unrelated to the surface drainage systems. In the fall the caverns are sometimes sealed by refreezing.

Where the expansion of the ground causes peripheral ridges adjacent to ice-wedges, surface drainage is often obstructed as each polygon is a potential pond [8, 16]. In some cases absorption of solar radiation by the polygonal ponds causes degradation of the permafrost and the formation of thaw lakes.

By late summer when the active layer material over ice-wedges is thawed, it often flows along the smooth upper surface of the wedge. Where the topography is strongly convex, e.g., near the brink of a bank or crest of a ridge, the divergent flow causes thinning of the ice-wedges' insulating cover and, consequently, thawing of the wedge tops and deepening of the troughs. In subsequent years, active layer material flows radially from the polygonal highlands into the deepening troughs, where it is carried away by the reticulate solifluction drainage system underlain by wedge ice. Stability is achieved when the topographic convexity is ultimately replaced by a gentle slope or the polygons are reduced to isolated mounds too well drained to participate in further flow.

These degradational processes, which are related in one way or another to the formation and deterioration of ice-wedge polygons, can have a profound effect on the ecology of the surface, primarily through their effects on local drainage [11, 35, 4]. Thus, the interpolygonal troughs, the peripheral ridges, and the intrapolygonal areas each commonly support plant communities of different composition. The contrasting appearance of these communities, more than the microrelief, delineates the polygonal patterns at the surface. As the local habitats are modified by the processes described, a corresponding succession of plant assemblages results, and the events are sometimes recorded in the stratigraphic section. As individual plant communities have very different bulk thermal and mechanical properties, such a succession can, itself, modify the processes of melting and flow that shape the surface.

Old ice-wedges can extend to much greater depths than the cracks responsible for their growth, simply by keeping pace with the aggrading surface in areas of rapid sedimentation. Wedges more than 50 m deep have been explained in this way by Shumsky et al [2]. Even when no sediment is introduced from an external source, the surface is aggraded from the displacement of material by growing ice-wedges. When the period of wedge growth lasts for many thousands of years, the widening wedges can occupy most [2] or even all [Ref. 6, plate XXXII] of the upper permafrost. In this case, the upward extrusion of permafrost attending summer reexpansion all occurs within wedge ice. It is clear that in such advanced stages of growth the ice-wedge-polygon concept breaks down as the width of the ice-wedges approaches polygonal dimensions. (Such a condition was observed by the author on the Shaviovik River in northern Alaska. Ice-wedges averaging 15 m in width occupied about 90% of the surficial permafrost. One wedge contained two contemporary contraction cracks 14 m apart).

As the surface is modified by processes associated with ice-wedge polygons, distribution of thermal stress is also modified. Where thermal stress is reduced locally by insulating effects of snow in deep interpolygonal troughs, cracking

might initiate in the more highly stressed polygon center. In subsequent years cracking will recur at the new site, and the adjacent pre-existing wedge, or wedges, will be deactivated and buried by normal aggradation of the surface.

Deactivation and burial can be caused, also, by climatic change or by some processes discussed above. The specific cause can often be identified where good exposures are available. The upturned beds adjacent to deeply buried inactive wedges commonly meet the overlying perennially frozen strata in a sharp angular unconformity. As this horizon marks the boundary between the permafrost and the active layer at the time of deactivation, the unconformity does not represent a depositional hiatus. It is just a preservation of the unconformity commonly caused at the top of permafrost by the thawing off and horizontal refreezing of the ends of the upturned strata [6]. Where removal of a wedge top by surface drainage results in deactivation and burial, the unconformity is not present. Masses of clear ice or sediment-laden lenses within ice-wedges are usually explained easily as refrozen subterranean drainage channels.

When new cracks develop in response to changing conditions at the surface, they sometimes intersect buried wedges which they evidently tend to follow as a zone of weakness. The old wedges are rejuvenated locally and a "compound wedge" (i.e., a wedge growing out of a wedge) develops with further growth. Compound wedges also can be formed by intermittent sedimentation [2].

Additional manifestations of the processes described can be observed in endless ramifications making it almost useless to try to catalog them. An awareness, however, of the processes caused by and processes that cause ice-wedges is necessary to understand what is seen in the stratigraphic sections and what is taking place on the surface today in many polar environments.

ACKNOWLEDGMENTS

This is part of a study of geothermal problems in permafrost carried out by the U.S. Geological Survey and supported in part by the Office of Naval Research and its Arctic Research Laboratory at Point Barrow and the Air Force Cambridge Research Center. I thank my colleagues D. F. Barnes and D. M. Hopkins for their helpful comments.

REFERENCES

- [1] D. M. Hopkins, F. S. MacNeal, E. B. Leopold. "The Coastal Plain at Nome, Alaska: A Late Cenozoic Type Section for the Bering Strait Region," *Proc. 21st Intl. Geol. Congr.*, Copenhagen, pt. 4, 1960, pp. 46-57.
- [2] P. A. Shumsky, P. F. Shvetzov, B. N. Dostovalov. "Ice Veins," *Special Application of Engineering Geology in Reconnaissance of Underground Veins in the Regions of Their Occurrence*, Acad. Sci. USSR, Moscow and Leningrad, 1955.
- [3] R. S. Waters. "Involution and Ice-Wedges in Devon," *Nature*, Vol. 189, No. 4762, 1961, pp. 389-390.
- [4] I. L. Wiggins. "The Distribution of Vascular Plants on Polygonal Ground near Point Barrow, Alaska," *Dudley Herbarium Nat. Hist. Museum Contr.*, Stanford Univ., Vol. 4, 1951, pp. 41-56.
- [5] E. DeK. Leffingwell. "Ground-Ice Wedges: the Dominant Form Ground-Ice on the North Coast of Alaska," *J. Geol.*, Vol. 23, 1915, pp. 635-654.
- [6] E. DeK. Leffingwell. "The Canning River Region, Northern Alaska," *U.S. Geol. Survey Prof. Paper 109*.
- [7] R. F. Black. "Growth of Ice-Wedge Polygons in Permafrost Near Barrow, Alaska," *Geol. Soc. Am. Bull.*, Vol. 63, 1952.
- [8] R. F. Black. "Polygonal Patterns and Ground Conditions from Aerial Photographs," *Photogrammetric Engr.*, Vol. 18, No. 1, 1952, pp. 123-134.
- [9] R. F. Black. "Permafrost—a Review," *Geol. Soc. Am. Bull.*, Vol. 65, No. 9, 1954, pp. 839-855.
- [10] A. L. Washburn. "Classification of Patterned Ground and Review of Suggested Origins," *ibid.*, Vol. 67, No. 7, 1956, pp. 823-865.

- [11] M. E. Britton. "Vegetation of the Arctic Tundra," 18th Ann. Biol. Coll. Proc., Oreg. State Coll., Corvallis, 1957, pp. 26-61.
- [12] B. N. Dostovalov. "Izmenenie Obshchego rykylykh gornykh porod pri promerzanii i obrazovanie morozoboynykh treshchin," Materialy po laboratornym issledovaniyam merzlykh gruntov, Sbornik 3, Akad. Nauk SSSR, 1957, pp. 41-51.
- [13] D. M. Hopkins, T. N. V. Karlstrom et al. "Permafrost and Ground Water in Alaska," U. S. Geol. Survey Prof. Paper 624-F, 1955, pp. 113-146.
- [14] A. H. Lachenbruch. "Mechanics of Thermal Contraction Cracks and Ice-Wedge Polygons in Permafrost," Geol. Soc. Am. Spec. Paper 70, 1962.
- [15] T. L. Péwé. "Sand-Wedge Polygons (Tessellations) in the McMurdo Sound Region, Antarctica—Progress Report," Am. J. Sci., Vol. 257, 1959, pp. 545-552.
- [16] A. I. Popov. "Materialy k osnovam ucheniya o merzlykh zonakh zemnoi kory," Inst. Merzlotovedeniya, Acad. Nauk SSSR, No. 2, 1955, pp. 5-25.
- [17] A. H. Lachenbruch. "Depth and Spacing of Tension Cracks," J. Geophys. Research, Vol. 66, No. 12, 1961, pp. 4273-4291.
- [18] A. H. Lachenbruch, M. C. Brewer, G. W. Greene, B. V. Marshall. "Temperature in Permafrost," Temperature—its Measurement and Control in Science and Industry, Reinhold Publishing Corp., New York, Vol. 3, pt. 1, 1962, pp. 791-803.
- [19] Frost Effects Laboratory, U. S. Army Corps of Engineers. "Investigation of Description, Classification, and Strength Properties of Frozen Soils," SIPRE Rept. 8, Vol. 2, 1952.
- [20] N. A. Tsytoich, M. I. Sumgin. "Principles of the Mechanics of Frozen Ground 1937," U. S. Army, SIPRE Transl. 19, 1959.
- [21] J. W. Glen. "The Creep of Polycrystalline Ice," Royal Soc. Proc. London, A, Vol. 228, 1955, pp. 519-538.
- [22] J. W. Glen. "The Mechanical Properties of Ice, I. The Plastic Properties of Ice," Adv. Physics, Vol. 7, No. 26, 1958, pp. 254-265.
- [23] J. F. Nye. "The Flow Law of Ice from Measurements in Glacier Tunnels, Laboratory Experiments and the Jungfraujoch Borehole Experiment," Royal Soc. Proc. London, A, Vol. 219, 1953, pp. 477-489.
- [24] S. Steinmann. "Experimentelle Untersuchungen zur Plastizität von Eis," Beiträge zur Geologie der Schweiz Hydrologie, No. 10, 1959.
- [25] A. H. Lachenbruch. "Periodic Heat Flow in a Stratified Medium with Application to Permafrost Problems," U. S. Geol. Survey Bull. 1083-A, 1959, pp. 1-36.
- [26] A. A. Griffith. "The Phenomena of Rupture and Flow in Solids," Royal Soc. London, Phil. Transl., A, Vol. 221, 1921, pp. 163-198.
- [27] A. A. Griffith. "Theory of Rupture," 1st Intl. Congr. Appl. Mech. Delft, The Netherlands, 1924, pp. 55-63.
- [28] G. R. Irwin. "Fracture," in S. Flugge, Handbuch der Physik, Springer, Berlin, Vol. 6, 1958.
- [29] G. R. Irwin. "The Crack-Extension Force for a Crack at a Free Surface Boundary," Naval Research Lab. Rept. 5120, 1958.
- [30] G. R. Irwin. "Effects of Size and Shape on Fracture," Am. Soc. Testing Mat. Spec. Tech. Rept. 283, 1961, pp. 118-128.
- [31] E. Orowan. "Fundamentals of Brittle Behavior in Metals," MIT SYMP. Fatigue Fracture Metals, John Wiley & Sons, New York, 1950.
- [32] ASTM Committee on Fracture Testing of High-strength Metallic Materials. "The Slow Growth and Rapid Propagation of Cracks," Materials Research and Standards, Vol. 1, No. 5, 1961, pp. 389-393.
- [33] I. W. Gold. "Crack Formation in Ice Plates by Thermal Shock," Can. J. Phys., Vol. 41, No. 10, 1963, pp. 1712-1728.
- [34] M. C. Brewer. "The Thermal Regime of an Arctic Lake," Am. Geophys. Union Trans., Vol. 39, No. 1, 1958, pp. 278-284.
- [35] J. V. Drew, J. C. F. Tedrow. "Arctic Soil Classification and Patterned Ground," Arctic, Vol. 15, No. 2, 1962, pp. 109-116.
- [36] T. L. Péwé. "Effect of Permafrost on Cultivated Fields, Fairbanks Area, Alaska," U. S. Geol. Survey Bull. 989-F, 1954, pp. 315-351.

PINGOS IN CANADA

J. ROSS MACKAY, University of British Columbia

The Eskimo word, pingo, commonly used in the western Arctic of Canada to refer to a hummock or hillock [1], is now generally accepted as the English technical term for an intrapermafrost ice-cored hill. The word and spelling were proposed by Porsild [2] in 1938. The Russian equivalent is bulgunniakh. A few writers employ hydrolaccolith and pingo interchangeably, but this is undesirable, because a genetic connotation is involved. Hydrolaccolith also describes some seasonal mounds, whereas pingos are perennial. Other definitions, such as "hill or mountain completely covered by an ice sheet but revealing its presence by surface indications" [3], may be misleading or completely inaccurate. As Müller [4] has stressed, pingos are intrapermafrost ice-cored mounds quite different from seasonal frost blisters, winter icing mounds in the active layer, peat hummocks, and methane domed mounds.

The first reference to a pingo in Canada is the entry, August 15, 1852, in Capt. John Franklin's diary [5] in which he described hummocks (pingos) on the low alluvial islands of the Mackenzie Delta. John Richardson, who examined pingos in 1826 and in 1848, proposed the first theory of their origin by suggesting that "they have received their conical form from washing of high tides during the occasional inundations of the lowlands by the sea" [6]. However, Richardson's casual observation on pingos was more in the nature of a passing remark than a reasoned theory.

Porsild was first to describe pingos in Canada in detail.

He distinguished two types: An open-system type, already described by Leffingwell in Alaska, formed on sloping ground by hydraulic pressure, and a closed-system type characteristic of Mackenzie pingos. In 1954, Gussow [7] suggested that Mackenzie pingos were the result of a geostatic load on a buried remnant of a Pleistocene ice sheet, but the theory seems untenable [8]. In 1959, Müller [4] gave greater precision to Porsild's classification, designating them as the open-system (East Greenland) type and the closed-system (Mackenzie) type. The author [9] has discussed the closed-system type, partly from a theoretical basis.

DISTRIBUTION

About 1500 pingos have been identified in Canada, the vast majority from air photo interpretation. With minor exceptions, all known closed-system pingos in Fig. 1 are shown individually by dots or by numbers in the Mackenzie Delta area. The solid triangles probably represent open-system groups, but the identification of type is uncertain. Although a few small pingo fields may await discovery, probably few large pingos have escaped detection, particularly in the tundra. The most favorable regions for discoveries are the tundra forest and boreal forest of the Yukon and Northwest Territories.

As pingo ice-cores are perennial features, they can persist only in terrain where the ice-core is enclosed in permafrost,

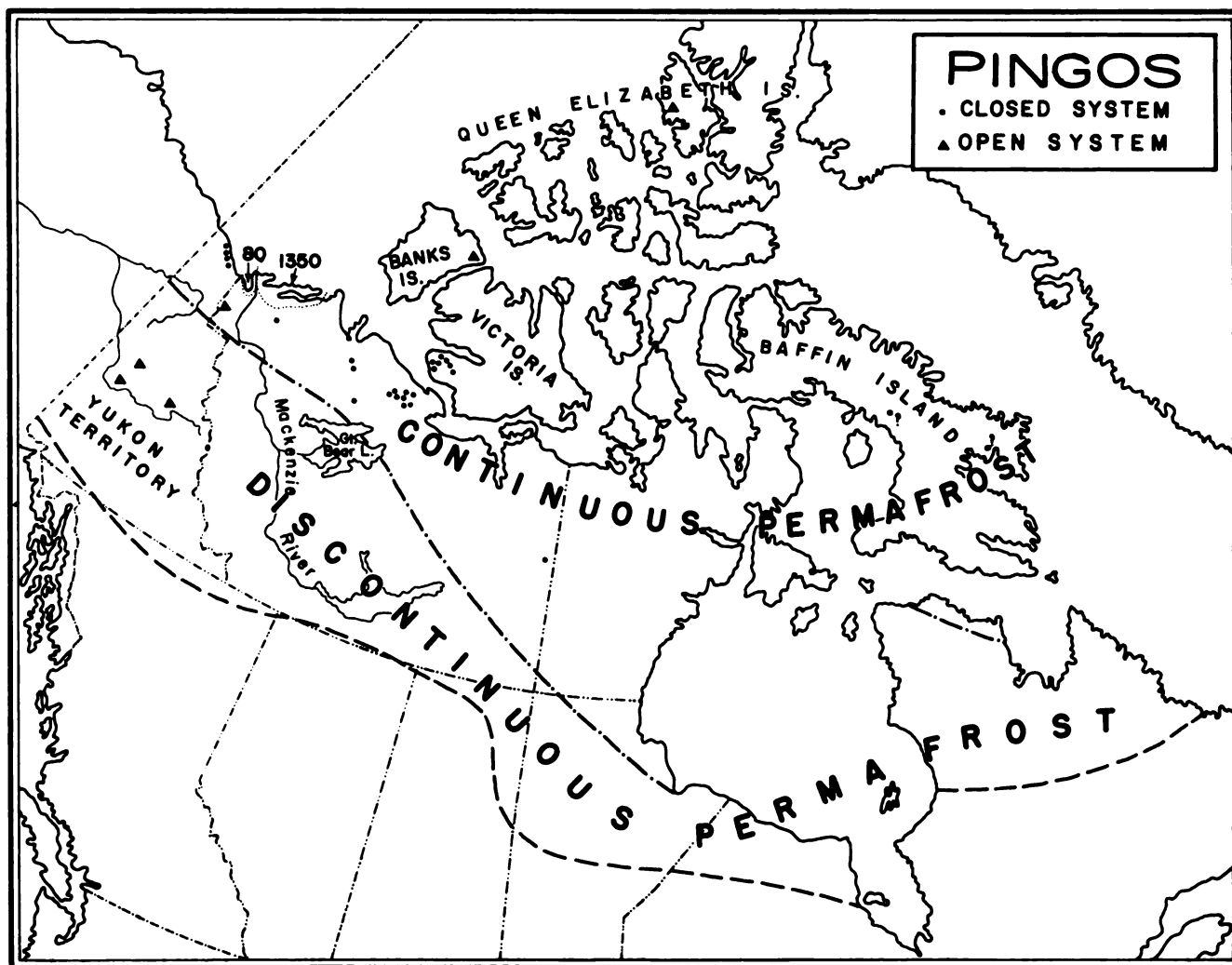

Fig. 1. Distribution of pingos in Canada. Permafrost boundaries after Brown [10]

whether regionally continuous or discontinuous (Fig. 1). Nearly all closed-system pingos are in continuous permafrost over 200 ft thick. Scattered pingo groups, tentatively identified as the open-system type, have been reported in areas of discontinuous permafrost.

Most pingos are restricted to thick alluvial, deltaic, or glaciofluvial sands with negligible fractions of coarser or finer grain sizes. The typical sands are not "frost susceptible," lacking sufficient fines to produce either frost heave or thick tabular ice sheets; therefore, hundreds of thousands of square miles of the Canadian Shield and Arctic islands have no pingos, although thermally suitable, because they are too hilly or rocky, or are veneered with too thin, coarse, or fine grained soil for pingo formation. Under favorable conditions, however, pingos can grow in other types of material, such as bedrock [11].

No pingos have yet been reported from the Queen Elizabeth Island group [2], except for brief mention of one of recent formation [13], although there are many perennial ice-cored peat mounds a few feet high, for example, on Cornwallis Island. Several pingo-like hills occur on Baffin Island [14], and there are pingos on Wollaston Peninsula, Victoria Island [15]; but Prince of Wales and Somerset Islands probably have no pingos [12]. Collapsed open-system pingos have been identified on northeastern Banks Island [16], although a photograph suggests the possibility that they might be collapsed high-centered tundra polygons.

There are a few pingos in Pleistocene and Recent alluvial deposits along the Yukon coast where both closed and open

system types seem to occur. Porsild [17] has described a group of closed-system pingos at Macmillan Pass on the Yukon-Northwest Territories border. In central Yukon one definite and two possible occurrences of pingos are reported and at least one of the pingos may be of the open-system type [18]. Other small mounds, possibly pingos, lie between the valley wall and floor in the Klondike Plateau. They may be open-system pingos. Several pingo-like features on the eastern slopes of the Richardson Mountains are probably open-system pingos [19].

The greatest concentration of pingos, about 1350 (Fig. 1), lies to the northeast of the Mackenzie Delta [20]. The pingos are in an area of Pleistocene sands and silts veneered with drift; contrary to some published reports, they are not in alluvium of the modern delta [21]. These pingos range up to 150 ft in height and 2000 ft in diameter. The highest pingos have medium diameters of about 500 to 700 ft. Pingos are nearly always close to the center of a depression which contains a shallow lake or the remains of one. Probably 99% of these pingos are of the closed-system type.

A second group of about 80 pingos (Fig. 1) occurs in the distal part of the Mackenzie Delta on islands below storm level [22]. These pingos rarely exceed 25 ft in height; a few are long esker-like ridges which attain a length of 2000 ft. These pingos are very much smaller than those of the above mentioned large group and show little direct association with lake basins. They are of the closed-system type.

A solitary pingo at the foot of Parry Peninsula was described nearly 60 years ago as a mud volcano [1]. North of

Great Bear Lake, there are several groups of pingos [23] and some are in floodplains or outwash. The outer surface of one is of dolomite of Lower Paleozoic age. An isolated pingo by the Thelon River northeast of Great Slave Lake has been described by Craig [11].

ORIGIN OF PINGOS

Pingos have originated from the arching of an impervious sheet of permanently frozen ground forced up by the intrusion of water under pressure. The pingo ice-core is the frozen "pool" of injected water. For this reason, Russian terminology refers to pingo ice as "injected ice" in contrast to other types, such as segregated, vein, cave, and buried ice. In open-system pingos the hydraulic head creates the water pressure; in closed-system pingos, hydrostatic pressure originates through the expulsion of excess pore water from the freezing of a confined body of saturated soil.

Open-System Pingos

Open-system pingos are, in a genetic sense, hydrolaccoliths formed by the injection and freezing of water. The movement of ground water in a permafrost region is either above the permafrost (suprapermafrost), within (intrapermafrost), or below (subpermafrost). In regions of continuous permafrost, intrapermafrost ground water usually flows in open gravels, or possibly in taliks representing a past climatic change. However, thick continuous permafrost has little intrapermafrost water, especially in sand and finer sediments. Subpermafrost flow is atypical of continuous permafrost areas, partly because intake sources are few. Consequently, open-system pingos are confined mainly to localities where: Relief provides an hydraulic gradient; discontinuous permafrost permits entrance of surface waters into the ground; granular materials allow ground water flow, and an impervious yielding permafrost layer can be arched to form a pingo. Such favorable areas are found toward the southern limit of permafrost along valley slopes, valley bottoms, and the coarse fill of braided rivers.

Open-system pingos are most likely to form where a permafrost cover grows, *ab initio*, over unfrozen material to impound groundwater. This may be brought about by a geomorphic change, such as the draining of a lake, a channel shift in a braided river, or the freezing of slumped debris. The newly formed cover must be sufficiently thin to yield under hydraulic pressure but also thick and impervious enough to retain a "pool" of water.

Closed-System Pingos

A closed system develops where a volume of saturated soil becomes completely confined by impervious material so that expelled pore water cannot escape. The confining impervious material may be frozen ground, fine grained soil, rock, or underlying saturated sediments with no escape for pore water under pressure. Initiation of a closed system requires the downward aggradation of permafrost to seal over the site of pingo growth and nourishment. In a region of otherwise continuous permafrost, aggradation in surficial material takes place under two main conditions where: (1) Unfrozen soils are exposed to low mean annual temperatures by the loss of their heat source, which is usually a shallow lake; and (2) new land is built, e.g., a deltaic island.

Every water body, river, lake, sea, serves as a heat source in a permafrost area. If the water body is deeper than the maximum thickness of winter ice, then its subjacent bottom sediments beneath its open pool are perennially unfrozen. In this discussion, the distinction between a shallow and deep lake (or other water body) is arbitrarily based on the size of the winter unfrozen pool. If the lake is deeper than the maximum winter ice thickness over much of the lake bottom, the lake is defined as "deep;" otherwise it is "shallow."

Equilibrium or steady-state conditions are assumed to exist prior to the temperature disturbance which creates a pingo. Under steady-state conditions the depth to permafrost beneath

the lake is dependent upon the undisturbed ground temperature, geothermal heat, and lake properties; but the depth is independent of the physical constants of the ground [9, 24].

A small deep lake will maintain beneath it a basin-shaped volume of perennially unfrozen ground resting upon permafrost. Freezing of the lake bottom, either by drainage with exposure to air temperatures or by shoaling sufficient to permit severe winter freezing of the bottom, will result in the downward aggradation of permafrost to initiate a closed system. Single pingos tend to develop in such basins, because both the small volume of confined unfrozen ground and the small size of the lake basin can nourish only one pingo.

A large deep lake may have an hourglass shaped perennially unfrozen central core, the permafrost surface plunging steeply lakeward and then recurving at depth under the lake shore. A closed system usually develops by drainage through lowering of the outlet or bank recession along a coast or river. Unless drainage is reasonably complete, several unfrozen winter pools may persist, an impervious lid cannot form, and a closed system is impossible. Large deep lakes are unfavorable sites for pingo growth.

A small shallow lake can have no more than a thin zone of perennially unfrozen ground beneath it. Reduction in depth, by any cause, readily initiates the growth of a permafrost cover. However, the volume of unfrozen ground in the closed system is rarely great enough to grow even a small pingo.

A large shallow lake will have a gradual drop in the upper permafrost surface toward the lake center, because of winter freezing of the shallower areas for the longest period. The presence, or absence, of a completely unfrozen zone beneath the lake will depend upon factors such as ground and lake temperatures, size, shape, and depth. Large shallow lakes usually become shoal through infilling by sedimentation, accumulation of organic matter, climatic changes, and drainage. These are ideal sites for pingo growth, because only a slight reduction in depth is required to freeze the bottom sediments. If there are several deeper spots in a lake, so that an uneven permafrost seal of irregular thickness forms, several pingos, or a multicored pingo, often develop. Most closed-system pingos have originated in shallow lake basins.

Pingos of New Land

The only extensive area where pingos are growing in newly built land is that of the distal part of the modern Mackenzie Delta to which the following discussion is directed. In the process of offshore sedimentation, shoals gradually become built into islands so that new land is exposed to air temperatures. Consequently, aggradation of permafrost occurs except where lakes and channels act as heat sources. Thus, transient rather than steady-state conditions apply to the alluvial islands. In the gradual process of sedimentation, a channel only 200 feet wide and 4 feet deep in the center might have enough thermal capacity to prevent freezing of the immediate subjacent bottom sediments (Fig. 2).

Eventually, permafrost may gradually extend itself beneath such an unfrozen area, given present mean annual ground temperatures of -5°C or lower. In the progress of downward penetration of the freezing plane, fine grained impervious sediments may also be encountered; therefore, a closed system may easily develop from a channel shift or by sedimentation. Thereafter, the formation of the pingo is similar to that of other closed-system pingos with the following differences: The pingos under discussion are smaller, being rarely over 25 feet high, because the parent water bodies are smaller; many are ridges like eskers because they grow in channels; sedimentation may mask the association between pingos and lake basin or channel, and the pingos are much younger.

Pore Water

Laboratory and field experiments show that excess pore water, under certain conditions, is expelled before an advancing freezing plane [25]. The minimum permeability required for excess pore water to be squeezed out has been estimated at

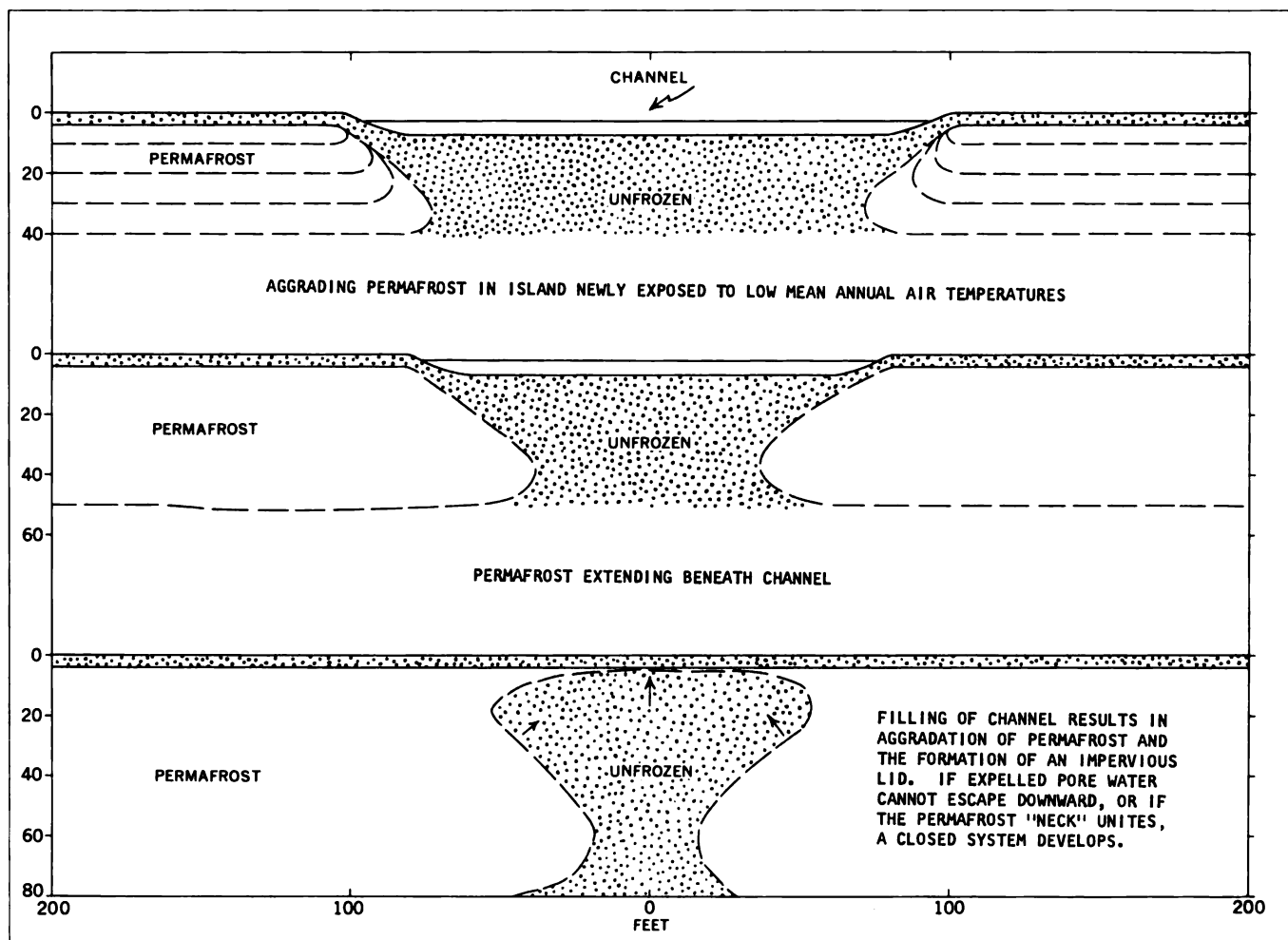

Fig. 2. Schematic development of a closed-system, young alluvial island, Mackenzie Delta

several inches per day; the pressure developed at -22°C has reached 2000 atmos. [26]. As the static weight of the highest pingo hardly exceeds 10 atmos. in the center, adequate water pressures seem available to lift a thin frozen layer over an injected "pool." Thus, the expulsion of pore water in a closed system provides the pressure equivalent to that of the hydraulic head in an open system. Expulsion of pore water cannot take place if there is extensive ice segregation and this is one reason why fine grained soils are unfavorable for pingo growth.

Under ideal conditions, the volume of expelled pore water may approach one-tenth the volume of ice in the ground, but it can be much less; therefore, the volume of a pingo ice-core provides a clue to the initial volume of unfrozen sediment.

SHAPE OF ICE-CORE

The shapes of the ice-cores can be inferred from several types of information. Only one completely sectioned pingo showing the ice body (Fig. 3) is known to the writer, although there are numerous examples of sectioned pingos with the ice body either buried by slumping, partially exposed, or melted out. The ice-core in Fig. 3 appears as a white lens. The overburden of brownish sand is about 3 to 5 ft thick. The original height of the pingo was about 20 to 30 ft, the section in the photograph being the highest part of the uneroded two-fifths of the pingo.

Information on ice-cores has also been obtained from drill records [4, 27] and the depressions formed by collapse of

pingos. The typical pingo ice-core appears to resemble the gross pingo outer shape but it has steeper sides. The bottom of the ice-core is believed to be rather flat, although evidence is extremely fragmentary. As the average overburden thickness is estimated at one-third to one-half the pingo height, the bottom of the ice-core may lie roughly an equal amount below that of the flat adjacent terrain.

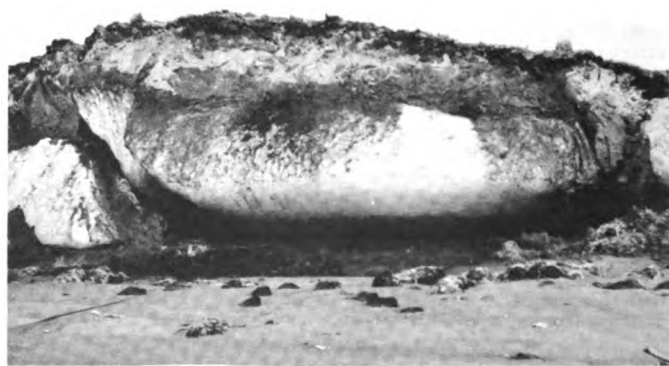

Fig. 3. Wave-cut pingo at McKinley Bay, $69^{\circ} 59' 30'' \text{ N}$, $131^{\circ} 01' 40'' \text{ W}$ (Photo by J. R. Mackay courtesy of Geographical Branch, Dept. of Mines and Technical Surveys, Ottawa, Canada)

The shape of the pingo and its ice-core, whether conical, ellipsoidal, hemispherical, gently domed, or ridge-like, is governed primarily by:

- (a) The three-dimensional shape of the permafrost seal when pingo heaving commences;
- (b) The bending strength of the still frozen cover;
- (c) The rate of aggradation of permafrost;
- (d) The size, shape, volume, and composition of the unfrozen material;
- (e) The rate of expulsion of pore water.

In general, the three-dimensional shape of the permafrost cover, where the pingo grows, probably resembles a double-concave lens. The upper concave surface corresponds to the lake bottom floor with the greatest depth near the center. The upper permafrost surface would coincide with the lake bottom except for minor irregularities of the active layer. The lower permafrost surface would likely be concave downward because aggrading permafrost would have had a longer time to penetrate in shallower areas than in deeper parts of a gradually shrinking lake. As water pressure builds up in a closed system, or flow of water is blocked in an open system, the place of easiest pressure relief would then be in the center of the double-concave lens of permafrost where the thickness is least. Here the pingo probably grows.

If the bending strength of the stiff frozen cover permits, the lake bottom is arched in the thinnest part. It is suggested that a strongly double-concave permafrost lens will tend to produce a small high pingo, whereas one with slight concavity will result in a bulge. Once expelled pore water begins to dome up permafrost, the concavity of the lower permafrost surface should be accentuated because the penetration of permafrost would be delayed at the site of ice formation through retardation by latent heat effects.

PINGO ICE

Pingo ice tends to be pure and transparent with very little included matter. It contrasts with the thick, tabular, "dirty" horizontal ice sheets which may be present in the same general area. The crystallographic aspect of pingo ice has been little studied. Grain sizes are relatively large. Müller found the mean crystal diameter of several Mackenzie Delta pingos to be 1.5 to 2.7 cm [4]. Mackay [8] found crystals up to 4 cm in one pingo. Crystals up to 16 cm in diameter have been observed in Russia [26].

Pingo ice may be layered. Whether this represents seasonal freezing effects is unknown, but the phenomenon has been reported by several observers. Locally, the ice has many bubbles, often in nearly continuous strings which may indicate the direction of crystallization being normal to the cooling plane. Insufficient fabric analyses are available to permit any general statement on crystal orientation.

AGE OF PINGOS

Most of the large, closed-system Mackenzie Delta pingos (Fig. 1) are at least hundreds, if not several thousand years old. Although the Eskimo names for some pingos suggest growth, as "the one that is growing" or "the poor thing that is getting to be a pingo" [2], so far as the author is aware no reliable historic accounts are available on pingo growth. The ages of these pingos may be estimated in several ways. The vegetation cover and soil humus attest to an age of hundreds of years. Broad ice-wedges of large tundra polygons may penetrate into pingo ice; as the rate of growth may be only one to three feet per thousand years [28], large wedges five or more feet across point to ages of several thousand years.

On the flanks of many pingos, peat of high-centered tundra polygons may feather out, showing that most of the peat has accumulated since the pingo has formed. Two radiocarbon dates for the Mackenzie Delta area suggest a growth rate of 1 to 1-1/2 feet per thousand years [29]. On this rough basis, many of the larger pingos are at least several thousand years old.

Indirect estimates of the age of closed-system pingos can also be based upon the relation between the volume of the ice-core, the volume of unfrozen sediment required to supply expelled pore water to form the ice-core, and the rapidity of downward aggradation of permafrost. For example, the size of the ice-core of 135-foot-high Ibyuk pingo near Tuktoyaktuk, NWT., is probably about 200,000 cu yd. If this represented a 10% volume expansion of freezing water in sand with 25 to 30% porosity, nearly 10,000,000 cu yd of unfrozen sand would be required. If the shape of the unfrozen sand were conical, any realistic estimate would give a depth in the center in excess of 100 ft. To this must be added 45 ft, the thickness of the overburden above the ice-core. A freezing of 150 ft of saturated soil and the "pool" would probably take well over a hundred, if not hundreds of years.

Many of the larger closed-system pingos may have commenced growth in the past few thousand years following the postglacial thermal maximum. Müller [30] placed the age of a pingo near Tuktoyaktuk at a maximum of from 7000 to 10,000 years and of another at about 4000 years. To the east, Craig [11] has described a pingo whose age may date back to the marked cooling of climate following the postglacial thermal maximum.

Closed-system pingos of the low islands of the Mackenzie Delta are young. Older pingos date back at least several hundred years. However, some pingos appear to be growing today but few reach full development, as they frequently are eroded by storm waves. The ages of the Yukon Territory pingos have not been estimated.

ACKNOWLEDGMENTS

The author thanks the following persons for making unpublished information available: J. G. Fyles, (pingos on Wollaston Peninsula, Victoria Island); O. L. Hughes, (pingos in central Yukon Territory); A. E. Porsild, (pingo, northeast Banks Island), and R. Thorsteinsson, (observations on Banks, Prince of Wales and Somerset Islands, and the Queen Elizabeth group).

REFERENCES

- [1] R. M. Anderson. "Report on the Natural History Collections of the Expedition," in V. Stefansson, My Life with the Eskimo, McMillan Co., New York, 1951, p. 439.
- [2] A. E. Porsild. "Earth Mounds in Unglaciated Arctic Northwestern America," Geog. Rev., Vol. 28, 1938, pp. 46-58.
- [3] Glossary of Geology and Related Sciences, Am. Geol. Inst., Washington, D.C., 1957, p. 221.
- [4] F. Müller. "Beobachtungen Über Pingos," Medd. om Grönland, Vol. 153, No. 3, 1959.
- [5] J. Franklin. Diary of 1825, (MS. 248) Scott Polar Research Inst., Cambridge, England.
- [6] J. Richardson. Journal of a Boat Voyage Through Rupert's Land and the Arctic Sea, in Search of the Discovery Ships under the Command of Sir John Franklin, Vol. 1, London, Longman, Brown, Green & Longmans, 1851.
- [7] W. C. Gussow. "Piercement Domes in Canadian Arctic," Bull. Am. Soc. Petroleum Geol., Vol. 38, 1954, pp. 2225-2226.
- [8] J. R. Mackay. The Anderson River Map-Area, NWT. Geog. Branch, Mem. 5, Ottawa, 1958, pp. 54-55.
- [9] J. R. Mackay. "Pingos of the Pleistocene Mackenzie Delta Area," Geog. Bull., No. 18, 1962, pp. 21-63.
- [10] R. J. E. Brown. "The Distribution of Permafrost and Its Relation to Air Temperature in Canada and the U.S.S.R.," Arctic, Vol. 13, 1960, pp. 163-177.
- [11] B. G. Craig. "Pingo in the Thelon Valley, Northwest Territories," Geol. Soc. Am. Bull., Vol. 70, 1959, pp. 509-510.
- [12] R. Thorsteinsson, Priv. comm.
- [13] B. Robitaille. Jacobsen - McGill Arctic Research Expedition to Axel Heiberg Island, Queen Elizabeth Islands, Prelim. Rept. 1959-1960, McGill Univ., Montreal, 1961, p. 176.
- [14] F. Müller. "Beobachtungen Über Pingos," Medd. om Grönland, Vol. 153, No. 3, 1959, pp. 106-107
- [15] A. L. Washburn. "Patterned Ground," Rev. Canadienne

- Geog., Vol. 4, 1950, p. 46; also J. G. Fyles, priv. comm.
- [16] A. E. Porsild. Vascular Plants of the Western Canadian Arctic Archipelago, Natl. Mus. Canada, Bull., No. 135, 1955, Ottawa, pp. 200-201.
- [17] A. E. Porsild. Alpine Flora of the East Slope of Mackenzie Mountains, Northwest Territories, Natl. Mus. Canada, Bull., No. 101, Ottawa, 1945, pp. 10-11.
- [18] O. L. Hughes. Priv. comm.
- [19] J. K. Fraser. "Physiographic Notes on Features in the Mackenzie Delta Area," Canadian Geog., No. 8, 1956, pp. 18-23.
- [20] J. K. Stager. "Progress Report on the Analysis of the Characteristics and Distribution of Pingos East of Mackenzie Delta," Canadian Geog., No. 7, 1956, pp. 13-20.
- [21] J. R. Mackay. "Mackenzie Deltas—a Progress Report," Canadian Geog., No. 7, 1956, pp. 1-12.
- [22] J. R. Mackay. Mackenzie Delta Area, 1963, Ottawa, Geog. Branch, Mem. 8, pp. 88-94.
- [23] B. G. Craig. "Surficial Geology of North-central District of Mackenzie, Northwest Territories," Geol. Surv. Canada, Paper 60-18, 1960; see also [9] pp. 54-55.
- [24] A. H. Lachenbruch. "Three-dimensional Heat Conduction in Permafrost Beneath Heated Buildings," U. S. Geol. Surv. Bull. 1052B, 1957.
- [25] V. G. Petrov. "An Attempt to Determine the Pressure of Ground Water in Pingos" (text in Russian), Trudy Komissii po Izucheniyu Vechnoy Merzloty, Tom. 2, 1934, pp. 59-72; K. P. Kosmachev. "Balgunniakhi" Priroda, Vol. 42, 1953, pp. 111-112 (text in Russian).
- [26] Foundations of Geocryology. Permafrost Institute named in honor of V. A. Obruchev. Akad. Nauk SSSR, Vol. 2, Moscow, 1959 (text in Russian).
- [27] J. A. Pihlainen, R. J. E. Brown, R. F. Legget. "Pingo in the Mackenzie Delta, Northwest Territories, Canada," Geol. Soc. Am. Bull., Vol. 67, 1956, pp. 1119-1122.
- [28] R. F. Black. "Growth of Ice-wedge Polygons in Permafrost near Barrow, Alaska," Geol. Soc. Am. Bull., Vol. 63, 1952, pp. 1235-1236.
- [29] J. R. Mackay. "Origin of the Pingos of the Pleistocene Mackenzie Delta Area," Proc. 1st Canadian Conf. Permafrost, Natl. Research Council, Ottawa, Mem. 76, 1963, pp. 79-82.
- [30] F. Müller. "Analysis of Some Stratigraphic Observations and Radio-carbon Dates from Two Pingos in the Mackenzie Delta Area, NWT.," Arctic, Vol. 15, 1962, pp. 278-288.

ICE-WEDGES IN ALASKA—CLASSIFICATION, DISTRIBUTION, AND CLIMATIC SIGNIFICANCE

TROY L. PÉWÉ, University of Alaska and U. S. Geological Survey College, Alaska

Ice-wedges, large masses of foliated ground ice in permafrost, are currently widespread in polar and subpolar regions and were formerly extensively distributed in many regions of temperate latitudes. Their former existence in middle latitudes has long been known [1], and many inferences have been made concerning their past distribution and climatic significance. The origin of ice-wedges has been debated for many years, but only recently have they been carefully examined [2].

To interpret the meaning of former ice-wedges in now temperate latitudes, it is necessary to study existing ice-wedges. Although in some areas of Alaska they have been studied intensively, this represents the first summary of their distribution. Only reconnaissance information is available for most of the state. Also, this summary must of necessity be based on concepts not entirely proven; therefore, conclusions are tentative. Ice-wedge distribution in the USSR has been summarized by Shumskiy, Schvetzov, and Dostovalov [3].

CLASSIFICATION OF ICE IN THE GROUND

Ice in the ground originated in several ways, and it is necessary to outline briefly the general types to understand more clearly the position of the foliated ground ice masses or ice-wedges. Ice in the ground can be grouped into six classes: (1) Pore ice, (2) segregated or "Taber" ice, (3) foliated or ice-wedge ice, (4) pingo ice, (5) buried ice, and (6) ice in caves, shafts, or other openings.

Pore ice is defined as ice filling or partially filling pore spaces in the ground. It is formed by freezing pore water in situ with no addition of water. The ground contains no more water in the solid state than the ground could hold if the water were in the liquid state. Black [4] terms frozen ground with such ice as under-saturated or saturated.

Segregated or Taber ice is described as ice seams, lenses, or layers generally 1 to 100 mm thick that grew in the ground by drawing in water as the ground became frozen. Taber [5 to 10] was a pioneer in demonstrating this phenomenon although Beskow [11] did active work in this field at about the same time. While the principle of bringing water to a growing ice crystal is generally accepted, there is not complete agreement as to the mechanics of the processes [12 to 15].

Segregated ice has been referred to by various terms, such as ice seams, ice segregations, ice gneiss [16], sirloin-type

ice [17], and others. To simplify the terminology the author has long used the term Taber ice in the field and in the classroom for ice segregations in the ground and suggests that it is an euphonious, short, and appropriate term to use when referring to ice of this type. (The term was originally suggested to the author by A. H. Lachenbruch, U. S. Geological Survey.) Pore ice and Taber ice occur both in seasonally frozen ground and in permafrost. Black [4] refers to permafrost composed of this type of ice as being supersaturated because it contains more water in the solid state than the ground could possibly hold if water were in the liquid state.

Foliated ground ice [18] or wedge ice is the term given to large masses of ice which grow in thermal contraction cracks in permafrost. A more complete description of this type of ice is given later in this paper.

Pingo ice is clear or relatively clear ice that occurs in more or less horizontal or lens-shaped masses 50 to 100 m in diameter and up to 50 m thick in permafrost. It evidently originates from ground water under hydrostatic pressure [19].

Buried ice in permafrost includes buried sea, lake, and river ice and snow. Buried glacial ice blocks in a permafrost climate would also fall into this category.

Ice formed by freezing water in openings in the ground such as caves, shafts, and gullies constitute a separate type of ground ice.

FOLIATED GROUND ICE OR ICE-WEDGES

The most conspicuous and controversial type of ground ice is that of the large ice-wedges or masses characterized by parallel or subparallel foliation structures. Foliation planes are marked by films of organic or inorganic matter, air bubbles, and boundary surfaces between ice layers of different composition. The term foliation used to describe this ice has no genetic implication; this usage follows the generally accepted meaning of the term as applied to metamorphic rocks. The term wedge ice is not used because the shape of the ice mass is not always a wedge.

Most foliated ice masses occur as wedge-shaped, vertical, or inclined sheets or dikes 1 cm to 3 m wide and 1 to 10 m high when seen in transverse cross section (Fig. 1). Some masses, when seen on the face of frozen cliffs, may appear as horizontal bodies a few centimeters to 3 m in thickness and 0.5 to

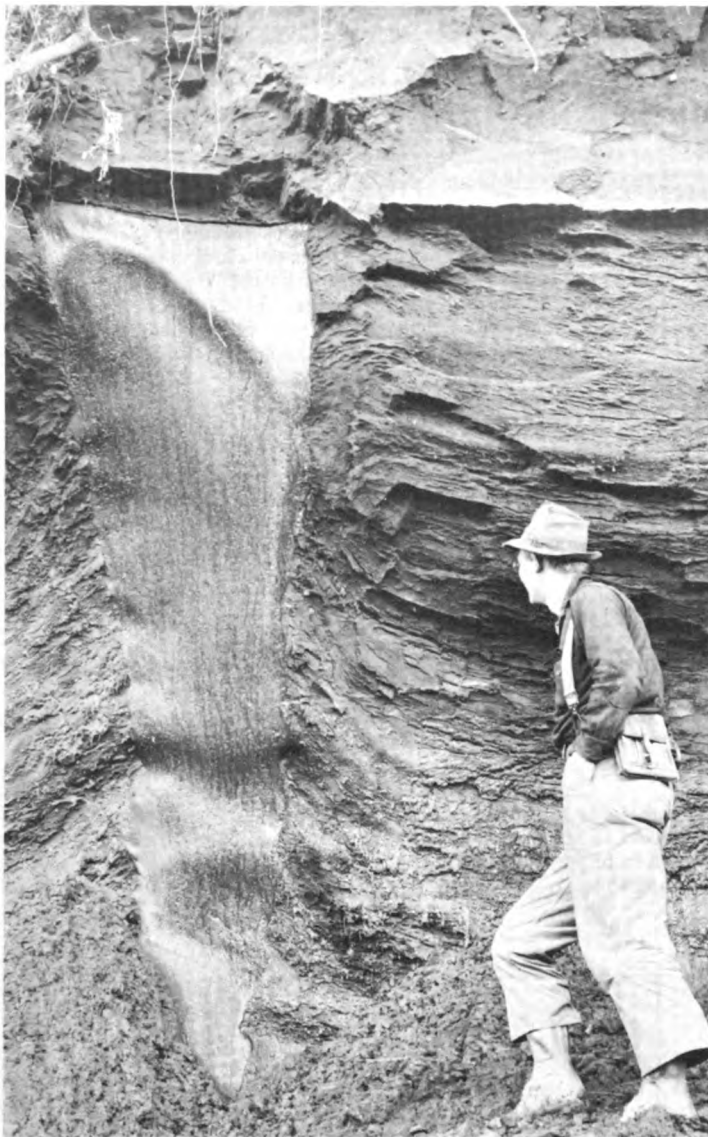

Fig. 1. Inactive ice-wedge in organic rich perennially frozen silt exposed in placer gold mining operations on Wilbur Creek near Livengood, Alaska (Photograph by T. L. Péwé, September 19, 1949)

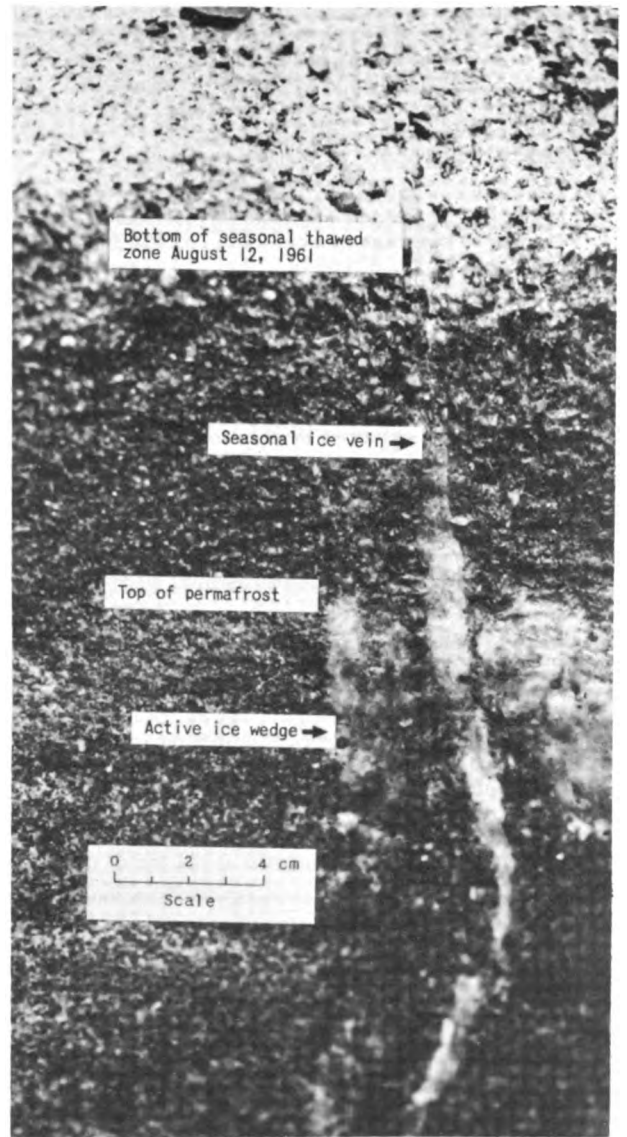

Fig. 2. Small active ice-wedge in gravel at Point Barrow Spit, Alaska (Photograph by T. L. Péwé, August 12, 1961)

15 m long. The true nature of the form of ice-wedges can be seen only in three dimensions. Ice-wedges are parts of a polygonal network of ice enclosing polygons or cells of frozen ground 3 to 30 m or more in diameter.

Ice crystals in ice-wedges range in size from less than 1 mm to more than 100 mm and are mostly equidimensional. They are anhedral or subhedral with smooth borders. Many ice-wedges contain sharp walled veins 1 to 5 mm wide of younger clear ice parallel to the foliation. These extend to the top of ice-wedges, or even into the frozen ground above ice-wedges (Fig. 2).

The most striking field relationship between the vertically foliated ice masses and the enclosing sediments is the almost universal appearance of upturning of the strata adjacent to the wedge. The upturning may effect the sediments 0.5 to 3 m on either side of the wedge, being greatest at the top of the wedge.

The network of foliated ice in the ground generally causes a microrelief pattern on the surface of the ground, generally called polygonal ground, tundra polygons. Troughs which delineate polygons are generally underlain by ice-wedges

1 to 2 m wide at the top. Polygons 2 to 30 m in diameter are not to be confused with small scale polygons or patterned ground produced by frost sorting [20, 21].

Polygons may be low centered or high centered. Upturning of strata adjacent to the ice-wedge may make a ridge of ground on the surface on each side of the wedge [22, Fig. 25 and plate 29b], thus enclosing the polygons. Such polygons are lower in the center and are called low-center polygons or raised-edge polygons [2, plate 1, Fig. 3]. They are erroneously termed by some, "depressed center" polygons. Low-center or raised-edge polygons indicate that ice-wedges are actually growing and that sediments are being actively upturned. If erosion, deposition, or thawing is more prevalent than the up-pushing of the sediments along the side of the wedge, or, if the material being pushed up cannot maintain itself in a low ridge, the low ridges will be absent, and there may be either no polygons at the surface or the polygons may be higher in the center than troughs over the ice-wedges that enclose them. Such polygons are called high-center polygons, erroneously termed "raised center" polygons by some.

The origin of large ground ice masses in perennially frozen

ground of North America has been discussed in print since Kotzebue recorded ground ice at a spot now termed Elephant's Point in Eschscholtz Bay of Seward Peninsula [23]. The origin of ground ice was discussed earlier in Siberia [22]. The general theory for the origin of ice-wedges now accepted is the thermal contraction theory of Leffingwell [22, 24]. This was succinctly summarized by Lachenbruch [2]:

During the Arctic winter, vertical fractures on the order of one-tenth of an inch wide and several feet deep are known to form in the frozen tundra—this process is generally accompanied by loud reports. They are assumed to be the result of tension caused by thermal contraction of the tundra. In early spring it is supposed that water from the melting snow freezes in these cracks and, with accumulating hoarfrost produces a vertical vein of ice that penetrates permafrost. Horizontal compression caused by re-expansion of the permafrost during the following summer results in the upturning of permafrost by plastic deformation. In the winter that follows, renewed thermal tension supposedly reopens the vertical ice-cemented crack which is presumed to be a zone of weakness. Another increment of ice is added when the spring melt water enters the renewed crack and freezes. Such a cycle, it is argued, acting over centuries, would produce the vertical wedge-shaped mass of ice.

The polygonal configuration is generally thought to be a natural consequence of contraction origin.

Most workers familiar with the problem in the field support this hypothesis [2, 3, 4, 18, 20, 21, 22, 24 to 33]. Taber [16] and Erwin Schenk (oral communication) do not agree with this hypothesis.

Horizontal tension is set up in the ground by its tendency to contract upon cooling. Lachenbruch [2] deduces that the first crack is initiated at the ground surface, but that cracking in subsequent winters is initiated at the top of the ice-wedge:

Stress at the wedge top evidently exceeds the strength of wedge ice before the greater stress at the ground surface exceeds the (presumably) greater strength of the surface materials. Thus, the crack would initiate at the top of a wedge and propagate upward through the active layer to the surface and downward through the wedge into permafrost.

For the maximum annual thermal tension at the top of the permafrost to be of the same order of magnitude as the strength of foliated ground ice, the ground must cool at a certain rate for a certain period of time during a winter cold snap. Lachenbruch (oral communication, 1962) states that although the relations that determine whether an ice-wedge cracks are extremely complex, a single simple criterion that takes account of many of the factors is the minimum winter temperature at the top of the permafrost. He suggests that when its value is below -15° to -20°C , the active cracking of ice-wedges might be expected in many permafrost materials.

CLASSIFICATION OF ICE-WEDGES

Ice-wedges may be classified in many ways, such as origin, size, shape, and age. The following classification is based on their degree of activity and history, and permits aerial mapping and geographical subdivision of the types in a general way: (1) active ice-wedges, (2) inactive ice-wedges, and (3) fossil ice-wedges.

There is a complete gradation from active to inactive to fossil ice-wedges, both in position on the scale and in aerial distribution.

Active Ice-Wedges

Active ice-wedges are defined as those which are actively growing. The wedge may not crack every year, but during many or most years cracking does occur and an increment of ice is added.

Active ice-wedges are different from other ice-wedges in that open cracks 1 to 15 mm wide may exist and extend to the surface in the winter; even in the summer the vegetation mat

on the surface can be parted along this contraction crack [34]. Actively growing ice-wedges in summer may have an ice vein extending from the ice-wedge upward to the base of the thawed zone (Fig. 2). (See also [35, Fig. 3]).

Low-center (raised-edge) polygons are well developed and ubiquitous. Such microtopography is widespread in polar areas of actively growing ice-wedges and sand-wedges [28, 36]. High-center polygons also may be present.

The area of active ice-wedges in Alaska appears to roughly coincide with the continuous permafrost zone (Fig. 3) and is, in a general way, restricted to northern and northwestern Alaska. In this area active cracking into ice-wedges has been observed more often than elsewhere in Alaska; low-center polygons are widespread and well developed; the meager thermal data available indicate that the temperature of the ground at the top of permafrost is about -15°C or colder. This area is limited almost entirely to tundra. Active ice-wedges occur in silt, sand, and gravel.

From north to south in Alaska a decreasing number of wedges crack frequently. The line dividing the zones of active and inactive ice-wedges is arbitrarily placed at the position where low-center or raised-edge polygons are uncommon and where it is thought most wedges do not frequently crack. When more data become available concerning the temperature at the top of the permafrost, perhaps this arbitrary line may be more accurately placed.

The area of active wedges in Alaska outlined in Fig. 3 has the most rigorous climate of the state. The mean annual air temperature ranges from about -6°C or -8°C on the south to -12°C at Barrow on the north (Fig. 4). The mean annual degree ($^{\circ}\text{C}$) days of freezing range from 2800 to 5400 (Fig. 5).

Winters are very cold and summers are cloudy and cool. Both rainfall and snowfall are light—about 20 cm annual rainfall and less than 140 cm of snow annually. Snowfall is light and accumulation is thin enough to permit great cooling of the ground, especially since much snow is blown by the winds to provide an uneven ground cover and packed by drifting to

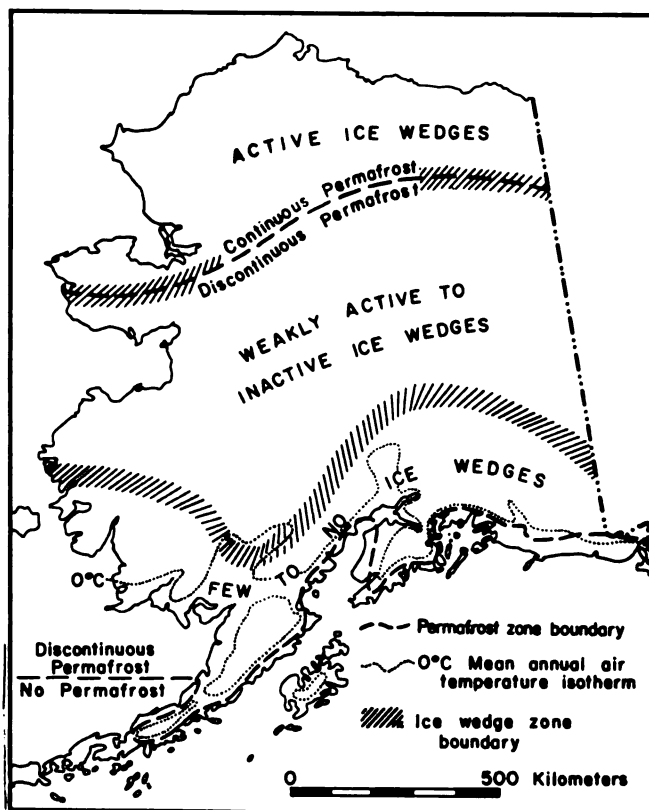

Fig. 3. Distribution of ice-wedges and permafrost in Alaska (Compiled by T. L. Péwé)

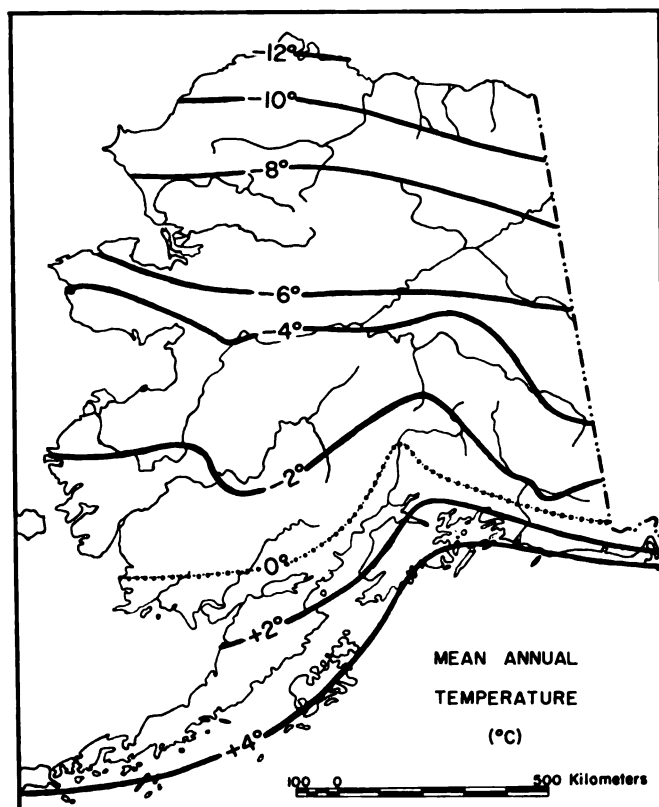

Fig. 4. Mean annual air temperature ($^{\circ}\text{C}$) isotherms in Alaska

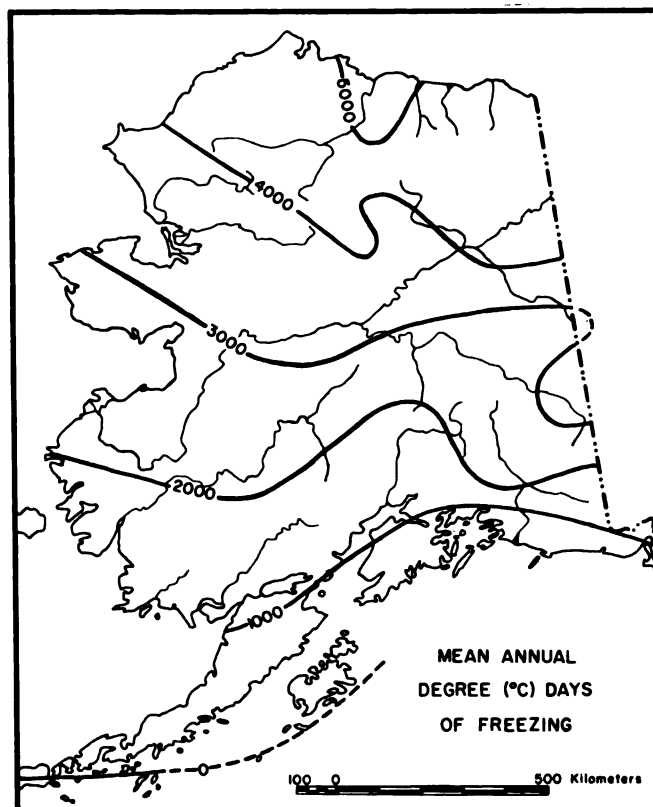

Fig. 5. Degree ($^{\circ}\text{C}$) days of freezing in Alaska taken from monthly mean temperature data

(Compiled by L. Mayo, U.S. Geological Survey. Effect of topography is not considered)

provide better heat transfer.

Permafrost in the area of active ice-wedges is classed as continuous and is actively forming. It is up to 405 m thick [37] and has a temperature of -5°C or colder at the level of zero amplitude (depth of 20 to 30 m). The coldest permafrost measured in Alaska is -10.6°C near Barrow [37]. Minimum temperature of the ground in winter at the top of the permafrost table (top of the ice-wedge) ranges from about -15°C on the south, -11° to -14°C near Kotzebue; (estimated from incomplete data from Cold Regions Research and Engineering Laboratory [CRREL], 1963, U.S. Army Corps of Engineers, Hanover, N.H.) to about -30°C in the far north near Barrow [2]. Temperature at the top of the permafrost table at Ogotoruk Creek near Point Hope is about -18° to -20°C based on a two-year record (oral communication, A. H. Lachenbruch, Nov. 20, 1962).

Inactive Ice-Wedges

Inactive ice-wedges are defined as those which are no longer growing. The wedge does not crack in winter and therefore no new ice is added. There is, of course, a gradation between active ice-wedges and inactive ice-wedges represented by those wedges which crack rarely. In this paper, wedges which crack rarely will be grouped with the inactive wedges. Inactive ice-wedges have no ice seam or crack extending from the wedge upward to the surface in the spring. The wedge top may be flat (Fig. 1), especially if thawing has lowered the upper surface of the wedge at some time in the past. Low-center or raised-edge polygons are absent or rare, but high-center polygons are common.

The area of inactive ice-wedges in Alaska lies south of the Brooks Range and central and western Seward Peninsula; the northern boundary of the zone roughly coincides with the discontinuous-continuous permafrost line (Fig. 3). The area extends south to the Alaska Range and almost to the lower Kuskokwim drainage (Fig. 3). Few data are available to per-

mit the placing of even a broad line indicating the southern border of inactive ice-wedges in the Yukon-Kuskokwim Delta area. Inactive ice-wedges in Alaska have been described only from frozen silt [16, 18, 38, 39, 40]; none are known to exist entirely in sand or gravel.

In the area of inactive ice-wedges outlined in Fig. 3, the mean annual air temperature ranges from about -2°C on the south to about -6° to 8°C on the north (Fig. 4). The degree ($^{\circ}\text{C}$) days of freezing range from 1700 to 4000 (Fig. 5). The climate is maritime on the west and continental in central and eastern Alaska. Snowfall ranges from 100 to 200 cm.

Permafrost in the area of inactive ice-wedges is classed as discontinuous, and it is forming only in favorable localities. It is generally 30 to 100 m thick, but thickness of 120 to 180 m are reported from near Bethel (Péwé and Hopkins, unpublished data). Temperature of permafrost at the level of zero amplitude ranges from -0.5°C near Fairbanks to an estimated value of about -4°C at the northern boundary. Minimum winter temperatures at the top of permafrost are -3.3°C (temperature data for the cold winter of 1961-1962, from F. Kitze, oral communication, CRREL, Fairbanks, Alaska) near Fairbanks, -4°C at Northway (temperature data from CRREL, U.S. Army Corps of Engineers, Hanover, N.H., 1963), estimated to be -3° to -6°C in the Copper River Basin based on a 4- to 6-year record (A. H. Lachenbruch, oral communication, Nov. 20, 1962) and suggested to be -10° to -15°C near the northern border of the zone. Such ground temperatures probably rarely permit thermal cracking of the ice-wedges; therefore, no or little ice is added to existing ice-wedges and they can be considered dormant, relic, or inactive.

The climate is such that thermal contraction cracks may occur under favorable conditions in seasonally frozen ground, especially in areas where snow is blown away or artificially packed or removed, such as in roads and pathways in the Fairbanks area.

In this zone the permafrost of some areas of permeable

sand and gravel has been thawed by heat supplied from moving ground water. Ice-wedges formerly existing in such sediments, therefore, are no longer present.

Permafrost Zone With No Ice-Wedges

South of the zone of inactive ice-wedges in Alaska there lies a zone of discontinuous permafrost that contains few, if any, ice-wedges. This area lies south of the Alaska Range and includes the Copper River Basin, the middle Susitna River valley, the Bristol Bay lowland (E. H. Müller, written communication, March 8, 1963), and perhaps the southern part of the Yukon-Kuskokwim Delta (Fig. 3). Permafrost in this area is discontinuous or sporadic and probably has a temperature at or near 0°C at the level of zero amplitude. The mean annual air temperature of the area is about 0° to -3°C (Fig. 4). The degree (°C) days of freezing range from 500 to 2800.

Ice-wedges are not growing in this zone now. Perhaps they did not form in most of this zone during the Wisconsin Glaciation because during all or part of Wisconsin time most of the zone was under massive glaciers or pro-glacial lakes [41]. After withdrawal of the ice or lakes, permafrost has formed locally but the climate evidently has not been rigorous enough for the formation of many ice-wedges. Areas outside of glacial advances of late Wisconsin age may have had ice-wedges but many or all of the wedges have now melted.

Fossil Ice-Wedges

Fossil ice-wedges are defined as sedimentary structures formed as a result of an ice-wedge melting and the space formerly occupied by it being subsequently filled with some type of sediment. Many terms have been used to describe these features besides fossil ice-wedge: Ice-wedge pseudomorph, ice-wedge fill, ice-wedge cast [42], fente de glace remplie [43], frost-wedge [44], and others. They also have been erroneously termed "ice-wedges" by Johnsson [45, 46], Filipiak [47], and Galloway [48].

Fossil ice-wedges are generally described as wedge-shaped fillings of sediments, and a voluminous literature exists, mainly in Europe. Much confusion exists concerning true and false fossil ice-wedges as well as their paleoclimatic significance. The filling is derived from both the sediment on the sides and from the overlying material. The fill generally has a bimodal mechanical analysis curve (Church, Péwé, and Andresen, in press) if the fossil ice-wedges are in gravel, but may also be unimodal or multimodal. The fill is not always wedge shaped but may be very irregular (Fig. 6).

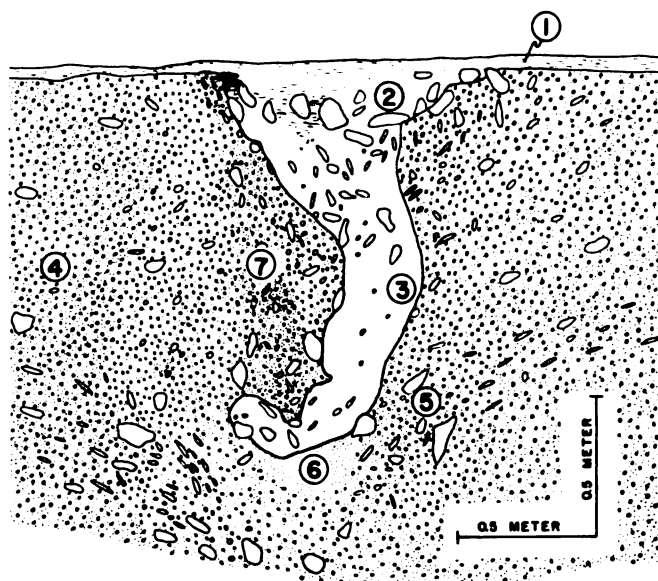

Fig. 6. Fossil ice-wedge in outwash gravel of Wisconsin age, 50 km south of Big Delta, Alaska (From Church, Péwé, and Andresen, in press)

Fossil ice-wedges have been described from all over the world, but few have been described from Alaska. Hopkins, MacNeil, and Leopold [49] illustrate three small fossil ice-wedges after ice-wedges of Wisconsin age in silt from the Nome area. A down melting of the tops of ice-wedges of Wisconsin age in silt of the Fairbanks area have formed downwarps of sediment 1 to 10 ft over the ice [27]. Fossil ice-wedges of Illinoian age are present in silt in the Fairbanks area but are not reflected on the surface. Fossil ice-wedges ranging in age from Sangamon to Recent are extensively developed in the Kotzebue Sound region, especially on the Baldwin Peninsula, but also have no surficial expression. Some well developed fossil ice-wedges after ice-wedges of Wisconsin age are known in Alaska in permeable sand and gravel. The most thoroughly studied of such fossil ice-wedges occur in outwash gravel of Wisconsin age south of Big Delta in Central Alaska (Fig. 6) (Church, Péwé, and Andresen, in press). The gravel in this area is now thawed except for isolated deep-lying relics of permafrost.

Fossil ice-wedges may be reflected by a poorly to well developed polygonal ground pattern [50, 51, 52], an inheritance of the ice-wedge microrelief polygon pattern. The pattern is similar to ice-wedge polygons except that it is less well preserved and not associated with beaded drainage, thaw gullies with angular courses, thaw lakes, or pingos. Excellent polygonal ground occurs with fossil ice-wedges 50 km south of Big Delta, Alaska. Such wedges may also be present in alluvial gravel; polygonal patterns similar to those of the Big Delta area are present in the upper Delta River Valley, Wood River, lower Black River Valley, the Bristol Bay area, and the northern Seward Peninsula.

Fossil ice-wedges originate when ice-wedges melt. Melting of the wedge occurs when permafrost thaws, generally from the top down, commonly in response to a warming of mean annual air temperatures to a level of above 0°C.

It appears that in areas of permeable sand and gravel having active ground water circulation, permafrost and ice-wedges may disappear with subsequent formation of fossil ice-wedges when the mean annual air temperature is at or above 0°C for a shorter time than in areas where ice-wedges are in perennially frozen silt. In central Alaska few ice-wedges in perennially frozen silt have been completely thawed, but many that existed in permeable gravel are gone, and the voids are filled with sediment.

REFERENCES

- [1] W. Soergel. "Diluviale Eiskeile," Zeitschr. Deut. Geol. Ges., Vol. 88, No. 3, 1936, pp. 223-247.
- [2] A. H. Lachenbruch. "Mechanics of Thermal Contraction Cracks and Ice-Wedge Polygons in Permafrost," Geol. Soc. Am. Spec. Paper 70, 1962.
- [3] P. A. Shumskiy, P. F. Schvetzov, B. N. Dostovalov. "Ice Veins," Special Applications of Engineering Geology in Reconnaissance of Underground Ice Veins in the Regions of Their Occurrence, Moscow and Leningrad, Acad. Sci., USSR, 1955, pp. 12-32.
- [4] R. F. Black. "Permafrost—a Review," Geol. Soc. Am. Bull., Vol. 65, No. 9, 1954, pp. 839-855.
- [5] Stephen Taber. "The Growth of Crystals Under External Pressure," Am. J. Sci., 4th ser., Vol. 41, 1916, pp. 532-556.
- [6] Stephen Taber. "Pressure Phenomena Accompanying the Growth of Crystals," Proc. Natl. Acad. Sci., Vol. 3, 1917, pp. 279-302.
- [7] Stephen Taber. "Ice Forming in Clay Soils Will Lift Surface Weights," Eng. News-Record, Vol. 80, 1918, pp. 262-263.
- [8] Stephen Taber. "Surface Heaving Caused by Segregation of Water Forming Ice Crystals," ibid., Vol. 81, 1918, pp. 683-684.
- [9] Stephen Taber. "Frost Heaving," J. Geol., Vol. 37, No. 5, 1929, pp. 428-461.
- [10] Stephen Taber. "The Mechanics of Frost Heaving," ibid., Vol. 38, No. 4, 1930, pp. 303-317.
- [11] G. Beskow. "Soil Freezing and Frost Heaving with Special Application to Roads and Railroads," Swedish Geol. Soc. Ser. C. No. 375, 1935, (English transl. Osterberg,

- Northwestern Univ.) 1947.
- [12] H. F. Winterkorn. "The Condition of Water in Porous Systems," Soil Sci., Vol. 56, 1943, pp. 109-115.
- [13] A. R. Jumikis. The Frost Penetration Problem in Highway Engineering, New Brunswick, N.J., Rutgers Univ. Press, 1955.
- [14] K. A. Jackson, Bruce Chalmers. "Study of Ice Formation in Soils," U.S. Army Corps Engineers Tech. Rept. No. 65, 1956.
- [15] L. A. Cass, R. D. Miller. "Role of the Electric Double Layer in the Mechanism of Frost Heavings," U.S. Army SIPRE Research Rept. 49, 1959.
- [16] Stephen Taber. "Perennially Frozen Ground in Alaska: Its Origin and History," Geol. Soc. Am. Bull., Vol. 54, No. 10, 1943, pp. 1433-1548.
- [17] Akira Higashi. "Experimental Study of Frost Heaving," U.S. Army SIPRE Research Rept. 45, 1958.
- [18] T. L. Péwé. "Permafrost and Its Effect on Life in the North," Arctic Biology, Oregon State Coll., Corvallis, 1957, pp. 12-25.
- [19] F. Müller. "Beobachtungen Über Pingos," Medd. om Grönland, Vol. 153, No. 3, 1959.
- [20] R. F. Black. "Growth of Ice-Wedge Polygons in Permafrost Near Barrow, Alaska," Abst., Geol. Soc. Am. Bull., Vol. 63, No. 12, pt. 2, 1952, p. 1235.
- [21] A. L. Washburn. "Classification of Patterned Ground and Review of Suggested Origins," ibid., Vol. 67, No. 7, 1956, pp. 823-865.
- [22] E. de K. Leffingwell. "The Canning River Region, Northern Alaska," U.S. Geol. Survey Prof. Paper 109, 1919.
- [23] Otto von Kotzebue. A Voyage of Discovery into the South Sea and Behring's Straits for the Purpose of Exploring a Northeast Passage, English transl., 3 Vol., London, 1821.
- [24] E. de K. Leffingwell. "Ground-Ice Wedges: The Dominant Form of Ground Ice in the North Coast of Alaska," J. Geol., Vol. 23, 1915, pp. 635-654.
- [25] Alexander Bunge. "Naturhistorische Beobachtungen und Fahrten im Lena Delta," St. Petersburg Bull., Acad. Im. Sci., Vol. 29, 1884, pp. 422-476.
- [26] Alexander Bunge. "Einige Wrote zue Bodeneisfrage," Verh. russ-K. min. Gesellsch St. Petersburg., 2d. ser., Vol. 40, 1902, pp. 203-209.
- [27] T. L. Péwé. Geomorphology of the Fairbanks Area, Alaska, Stanford Univ., Stanford, Calif., Ph.D. thesis, 1952.
- [28] T. L. Péwé. "Sand-Wedge Polygons (Tessellations) in the McMurdo Sound Region, Antarctica—a Progress Report," Am. J. Sci., Vol. 257, No. 8, 1959, pp. 545-552.
- [29] A. I. Popov. "Materialy k Osnovam Ucheniya o Merzlykh Zonakh Zemnoi Kory," Inst. merzlotovedeniya, Akad. Nauk., USSR, No. 2, 1955, pp. 5-55.
- [30] D. M. Hopkins, T. N. V. Karlstrom, et al. "Permafrost and Groundwater in Alaska," U.S. Geol. Survey Prof. Paper 264-F, 1955, pp. 113-146.
- [31] M. E. Britton. "Vegetation of the Arctic Tundra," Arctic Biology, Oregon State Coll., Corvallis, 1957, pp. 26-61.
- [32] A. H. Lachenbruch. "Periodic Heat Flow in a Stratified Medium with Application to Permafrost Problems," U.S. Geol. Survey Bull. 1083-A, 1959, pp. 1-36.
- [33] A. H. Lachenbruch. "Depth and Spacing of Tension Cracks," J. Geophys. Research, Vol. 66, No. 12, 1961, pp. 4273-4292.
- [34] R. M. Chapman, E. G. Sable. "Geology of the Utukok-Corwin Region, Northwestern Alaska," U.S. Geol. Survey Prof. Paper 303-C, 1960, pp. 47-167.
- [35] T. L. Péwé, R. E. Church. "Age of the Spit at Barrow, Alaska," Geol. Soc. Am. Bull., Vol. 73, No. 10, 1962, pp. 1287-1292.
- [36] T. L. Péwé, R. E. Church. "Age of Moraines in Victoria Land, Antarctica," J. Glaciol., Vol. 4, No. 31, 1962, pp. 93-100.
- [37] M. C. Brewer. "Some Results of Geothermal Investigations of Permafrost in Northern Alaska," Am. Geophys. Union Trans., Vol. 39, No. 1, 1958, pp. 19-26.
- [38] T. L. Péwé. "Terrain and Permafrost, Galena Air Base, Alaska," U.S. Geol. Survey, Permafrost Program Progr. Rept. No. 7, 1948.
- [39] T. L. Péwé. "Geology of the Fairbanks D-2 Quadrangle, Alaska," U.S. Geol. Survey Geol. Map GQ-110, scale 1:63,360, 1958.
- [40] T. L. Péwé. "Ice Wedges in Permafrost, Lower Yukon River Area, Galena, Alaska," Biuletyn Peryglacjalny, No. 11, 1962, pp. 65-76.
- [41] T. N. V. Karlstrom. "Surficial Deposits of Alaska," Art. 154, U.S. Geol. Survey Prof. Paper 400-B, 1960, pp. B333-B335.
- [42] H. E. Wright. "Late Pleistocene Climate of Europe—a Review," Geol. Soc. Am. Bull., Vol. 72, No. 6, 1961, pp. 933-984.
- [43] L. E. Hamelin, P. Clibbon. "Bilingual Periglacial Vocabulary," Cahiers de geog. de Quebec, Vol. 6, 1962, pp. 3-28.
- [44] J. Sekyra. "Periglacial Phenomena," Inst. Geol., 1961, INQUA Symp. Warsaw, Poland, 1961, pp. 99-108.
- [45] Gunnar Johnsson. "True and False Ice-Wedges in Southern Sweden," Stockholm, Geogr. Ann., Vol. 41, No. 1, 1959, pp. 15-33.
- [46] Gunnar Johnsson. "Periglacial Phenomena in Southern Sweden," Geogr. Ann., Vol. 44, No. 3-4, 1962, pp. 378-404.
- [47] A. Filipiak. "Ice Wedges in Podzomcze," Biuletyn Peryglacjalny, No. 7, 1960, pp. 39-47; English text trans. by T. Dmochowska, pp. 155-157; Russian text trans. by M. O. Olexnovechal, pp. 259-261.
- [48] R. W. Galloway. "Ice-Wedges and Involutions in Scotland," Biuletyn Peryglacjalny, No. 10, 1961, pp. 169-193.
- [49] D. M. Hopkins, F. S. MacNeil, E. B. Leopold. "The Coastal Plain at Nome, Alaska—a Late Cenozoic Type Section for the Bering Strait Region," 21st Proc. Intern. Geol. Congr. Copenhagen, pt. 4, 1960, pp. 46-57.
- [50] G. W. Dimbleby. "Pleistocene Ice-Wedges in Northeast Yorkshire," J. Soil Sci., Vol. 3, 1952, pp. 1-19.
- [51] L. R. Wilson. "Polygonal Structures in the Soil of Central Iowa," Oklahoma Geol. Survey, Vol. 18, No. 1, 1958, pp. 4-6.
- [52] F. W. Shotton. "Large Scale Patterned Ground in the Valley of the Worcestershire Avon," Geol. Magazine (Great Britain), Vol. 97, No. 5, 1960, pp. 404-408.

ORIGIN OF ICE-WEDGES

ERWIN SCHENK, Giessen, West Germany

Ice-wedges are a dominant and characteristic feature of tundra areas with permafrost. In general they are connected with tundra polygons. The origin of ice-wedges, therefore, cannot be considered without the origin of tundra polygons. Ice-wedges form their border as massive ground ice, as a filling of deep, narrow or broad cracks.

Frost patterned ground tundra polygons and ice-wedges occur in perennially frozen wet soils of the arctic and sub-arctic areas. In the boreal forest zone (taiga) they are found as a relic of permafrost, producing negative morphological features as broad ditches surrounding mounds [1]. In the Pleistocene periglacial area their fossil structures are filled with sand, loam, and other materials of the overburden.

Single occurrence of fossil or Recent ice-wedges does not seem to be rare and they are often bound to sandy layers, whereas most ice-wedges occur in clay and silt soils that often, especially in the upper layer, have an enormous content of organic materials.

The organic detritus favors a very high water content of the ground and is increased by seasonal and daily frost activity in the upper layers of permafrost. In dry soils one never sees tundra polygons and ice-wedges.

These circumstances compel one to classify ground with polygons and ice-wedges as wet soils of the Arctic and sub-Arctic. This must be emphasized because of the dominant role of water content of soil in the origin by frost of patterned ground soil structures and, especially, patterned ground [2, 3]. The tundra polygons are bordered everywhere by deep reaching ice-wedges sometimes forming a mesh of triangles, quadrangles, pentagons, and hexagons. Their diameters and areas measured from aerial photographs are about 150 m for the largest forms, 50 m for the middle, and 15 to 20 m for the small structures. Polygons with shorter diameters lead to special structures which are found in the active frost layer of the surface.

The angles of the polygons and surrounding ice-wedges that cut the ground into sections, as well as the diameter of the polygons and their relation to one another, constitute essential and fundamental data. Statistical investigation of aerial photographs in the Arctic Research Laboratory, at Barrow, Alaska for 1957 and 1959 reflects the ratio of about 1 to 3 for surficial dimensions. This indicates a genetic factor for the development of the polygons, i. e., the strain that forms the cracks and their directions.

Furthermore, by aerial photographs of the arctic coastal plain in Alaska, Siberia, and Taimyr Peninsula [4], I could determine that quadrangle forms occur only on slightly inclined surfaces along lakes and seashores, while pentagons and hexagons definitely predominate in horizontal plains. The cracks of the quadrangle structures are formed by one system of cracks parallel and another one perpendicular to the beach, i. e., in a radial direction from the basin, the lake, or the slope. This indicates that the strain forming the cracks by frost effect is influenced here by the inclinations of the freezing layer—by gravity.

Strain such as contraction tension always develops a triple radial star, the center of which is the corner of three hexagons as they are known from cooling basalt or drying clay and from frost experiments (Fig. 1) at Barrow in 1959. In homogeneous material the points for developing triple rays are regularly distributed; therefore, regular hexagons and pentagons are developed over vast areas. Such rays, when penetrating into the depth, also develop forks. This has been shown by photos and films [5] taken of the freezing ground.

In the interior of such hexagons, new strain points for a triple radial star are created by further contraction tension. The developing of cracks leads to smaller and still smaller hexagons and polygons because of the crossing of the rays in the ratio already mentioned. One should imagine that this



Fig. 1. In the center of the sample, as well as in the outer part, triple stars originate at single points; their prolongations cross and form polygons

process works in nature as the films show. From a zone of highest tension a ray or a crack runs through the field and splits at angles of about 120° . Then both rays so formed run through the field and split with the same angle, thus giving rise to zigzag patterns, hexagons, and pentagons—both in horizontal as well as in vertical directions. This mesh of cracks filled with ice can be seen in the soil layers on a large or small scale.

Middendorf [6] and later Bunge [7] comprehensively described the strange meshes of ice veins, layers, and lenses of permafrost in Siberia. Middendorf, digging to a depth of more than 100 m, also observed that the thick horizontal ice layers (more than 1.5 m thick) were connected by broad vertical veins. He also described ditches filled with mud in summer on the upper ends of the ice-wedges and elevated and vaulted border zones of the soil along the ditches, thus emphasizing the deeper interior central part of the polygons. Here mounds were often developed as he described and his descriptions are so comprehensive that hardly any new morphological facts have been stated since that time. Even the problems of their origin [6 to 9] were not solved since the thermal contraction theory was discussed [10 to 18]. Taber [18] pointed out serious objections, not exactly refuted, which were confirmed [2]. Schenk [3] explained the frost phenomena, including ice-wedges, by hydration and dehydration of soil particles and ice crystals; these basic processes in the freezing and thawing soils cannot be ignored if one intends to understand the origin of frost structures. These processes also control the morphogenetic features coupled with ice-wedges.

MORPHOGENETIC DEVELOPMENT

Features that enrich the flat arctic landscape of tundra polygons and ice-wedges are known [6 to 9]; but the relation between ice-wedges, bordering walls, and mounds is not well understood.

We have to differentiate among four stages of morphological development [19]:

1. Polygons with horizontal surfaces cut the upper end of ice-wedges so that one cannot recognize them in the flat tundra. Occasionally one can see this in the bottom of lakes

that are drained and dried out. It takes years until subsoil ice-wedges are contoured by damper zones with somewhat greener vegetation among the neighboring surroundings.

2. The damp condition of these zones is due to the melting ice-wedges in the subsoil. Owing to the draining of the melt water, flat ditches develop first; ditches with open water and mud develop later. This water initiates the vaulting of the edges of the polygons, for when frost penetrates much water is transported by "frost suction" into the bordering freezing soil. Frost penetration is held up by this process until all the water is consumed. The soil temperature measurements made [20] under natural conditions prove this excellently. The zero-level curtain lies a few centimeters deep for some weeks at the beginning of the frost period. This very small interval of temperature, from above to below zero and lasting a long period of time, is one main factor in the formation of frost structures and patterned ground in general. This has been proved by experiments as reported in the literature.

The slightly vaulted border of the ice-wedge somewhat increases the thickness of the active layer. Its moisture content, especially, increases from year to year because of the draining and erosion of the ditches which then accumulate more water. This in turn increases the vaulting of the border zones so that walls up to a height of some decimeters or more surround the polygons along the ice-wedges which can nowhere be seen in the mud of the ditches. The ditches become larger than the ice-wedges and can be seen everywhere when ice-wedges are cut off vertically on steep bluffs.

Elevation of the borders of the polygons, therefore, cannot be explained by expansion of the formerly contracted soil layers but simply by normal frost action in soil oversaturated by water from the ditches. Thus, one can understand this type of low-center polygon.

Any one feature of further development of the ice-wedges themselves within these processes was not observed, although hundreds of ice-wedges and open cracks in the soil were investigated.

3. In the low centers of such polygons, water and mud with organic material is accumulated. They become swampy. In consequence of the very high water content in the low center, frost activity is now increased. Thus mounds develop to more than one meter. Their diameters are also growing from year to year because the surrounding swampy rings and coins between the central mound and vaulted border along the ice-wedges supply both areas. Thus the high-center polygon is developed.

Although many cracks are often observed all over the vaulted mound by the growing of ice-lenses in their interior, we can again recognize nothing which might initiate the growing or enlarging of existing ice-wedges.

4. By progressive development of mounds in the center of the polygons and in their vaulted border zones, a multiple palsen-like mound is produced through the improved possibili-

ties for water accumulation. Sometimes large ice lenses, ice layers, and veins are formed in their interior. Thus the original polygon structure is covered and is hardly recognizable. We should classify such a field as an excessively cryoturbated, ice-wedge polygon. (A very instructive field of this kind was seen by many geologists in the Arctic Research Laboratory at Barrow).

In consequence of the formation of mounds, many open cracks cut and cross their tops and slopes or surround them like circles. They are only features of the upheaval of the active frost layer, however, and not of cracks that open to increase the breadth of an ice-wedge.

In these processes of upheaval and vaulting the active frost layer does not become deeper. It remains constantly thick, but its moisture accumulation in summer favors growth of the ice-core. This ice-core rarely consists of clear ice but of crumbs which are completely enveloped by ice (Fig. 2) which evaporated at the natural surface. The water content of such soils is from 50 to 85% of the weight as determined from drilled soil samples at Barrow, 1959.

Collapse Structures of Ice-Wedges

At this point collapse structures should be mentioned because of the importance of open hollows and cracks. Along the bluffs at seas and rivers in Alaska one can occasionally observe that the ice in the wedges has melted or evaporated without collapse of the walls of the polygons. One then finds no indication that an accumulation of snow results in forming something like ice-wedges.

Furthermore, erosion along ice-wedges often forms palsen-like small and large hills. Sometimes it is difficult to differentiate between them and real mounds. They are relics of polygons themselves.

Single Open Cracks

Finally, we have to consider single cracks and nets of cracks which originate by draining and drying of the active layer. This process is dehydration, not by frost, but by wind and sun causing evaporation from the soil. Cracks may also originate by earth movement through sliding or even recent tectonic stress and by thermal contraction in winter. I observed such cracks in 1957. In 1959, when I saw them again, they were still open and not filled with ice. I have never observed nets of open cracks or polygonal systems of thin ice veins that might have originated in very recent times in the interior field of large polygons; nor have I seen them in the grass tundra, in recently dried lake bottoms, or in aerial photographs—although I looked for them very intensively.

The filling out of open cracks with water may, of course, happen; but this process, observed by many authors, cannot be the general origin of polygons with ice-wedges.

Observing the origin of open cracks at low temperatures in winter and their filling out with water in spring, Bunge [7, 8] and Leffingwell [9] developed the theory of thermal contraction for the origin of ice-wedges. This theory was confirmed by many authors, even mathematically [16]. Indeed, thermal contraction may work and must work; but if it causes polygonal nets with ice-wedges to develop, then ice-wedges would also develop in homogeneous frozen ground, as in sand and gravel layers which have been completely filled with ground water. But here they are lacking. There, where we see single cracks filled with ice, they may originate in a manner we do not recognize. There are some other serious objections. Other processes are predominant in the freezing soil before thermal contraction begins to have effect. To learn the development of ice-wedges, one should first describe the essential features of the ice-wedge itself.

Vertical Structures in Ice-Wedges

Several descriptions of ice-wedges [7, 8, 9, 11] are comprehensive and still valid. One striking feature, however, does not seem to have been emphasized enough; the difference between the ice of the deep reaching ice-wedge itself and the

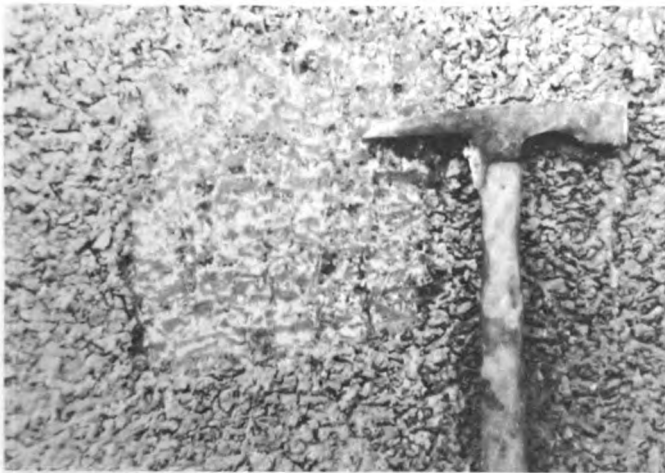

Fig. 2. Typical structure of the ice of a lens in the interior of a palsen-like mound in the border zone of a polygon

ice of its upper zone. The thickness of the ice-wedges has apparently also been overestimated in both Alaska and Siberia.

My own observations confirm Popov's work [22] that the very long walls of ice along the seashore and other bluffs are nothing but free walls of thin ice-wedges. Their thickness is seldom more than a meter. Often they are bent and only partly exposed; they appear to be ice-lenses. Transversal cuttings along a slope likewise deceive by false thickness. The frozen water of broad channels on the top of the ice-wedge blends with the ice-wedge underneath and appears as enlarged upper ends, particularly when they are covered by mud. These features should be carefully observed and described because such studies are lacking in the literature. In each case one must examine how and when the ice originated and what structure it has. Some ice-wedges originate today, but most are very old ones without any indication of present enlargement.

The ice of the uppermost end of the wedges is often dark or brownish; soil particles are enclosed and air bubbles are irregularly distributed. Clear ice of the veins and wedges is much different from ice belonging to the ditches. The ice of the wedges always has a special regular pattern: Rows of air bubbles alternate with rows of soil particles. Both rows are arranged in vertical directions, parallel to the soil wall of the neighboring polygons, i. e., the walls of the crack. Weathering produces slightly ribbed surfaces by the very small cavities in which air was enclosed. The air content of the ice is very high, 50 to 180 cu cm per liter by measurement and chemical analyses [8, 23, 24]. It is so high that its origin from snow and foaming water which rushed into the cracks was discussed. Black [14], who studied the fabrics of ice, supports the idea that melt water filled open cracks to form ice-wedges. He also mentioned hoar ice [25], fed by the water content of the air due to vapor pressure, which should close the crack.

We shall see that all this cannot explain structures of ice-wedges because even the structure itself contests such an explanation. Rows of air bubbles and soil particles tracing the contours of the walls can never develop in such an extremely regular way by an accumulation of snow or water or by hoar ice.

TRANSVERSAL STRUCTURES OF ICE-WEDGES

The filling up of open cracks with melt water as well as by hoar ice is disputed by the following points: (a) Transversal structure of the ice-wedge, (b) splitting of sections away from the walls, (c) mineral content of the ice corresponding to the layering of the walls, and (d) chemical constitution of the ice water.

The photograph (Fig. 3) taken in 1959 at the bluff near Barrow shows a dark shadow going upward from left to right. It is caused by frozen black soil particles which were transported with the development and growth of the ice-wedge. They were derived from neighboring layers of silt with coal



Fig. 3. Transversal structure of an ice-wedge (dark shadow)

particles and were deformed by frost pressure during the development of the ice-wedge. Several of such transversal shadows, one above the other, are often recognized.

The investigation of the soil particles and mineral composition of such shadow zones characterized by clay, silt, sand, coal, peat, etc., prove their connection with the corresponding layers on both sides of the ice-wedge. The soil particles and air bubbles were taken from the layers and brought 5 to 15 mm from the walls during the freezing processes and annual repetition of this process may lead to the row formation. Exactly along the boundary of ice and layers one observes air bubbles, mainly elongated, forming the first vertical row of the pattern. The next row consists of soil particles, then air bubbles again, etc. Ice crystals only slightly elongated are also recognizable perpendicular to the walls. These show their original position, while most of the rest are moved and rotated by secondary pressure.

Occasionally, slices and small sections are split away or completely cut off from the walls and held by the ice at some distance. Water appears to have been squeezed out of the layers of the fissure walls, taking with it soil particles and slices of the layers. Air was enclosed in the ice as it froze; the squeezed-out water, therefore, must have frozen as it left the pores of the soil layers. The air must have been derived from the soil, for it is also found in the small veins and cavities which for a certainty had connection with the exterior. Ice of this kind in vertical veins as well as in horizontal ice layers is completely enclosed by soil layers.

One concludes that water in the form of ice-wedges and layers can never be water which previously rushed into and filled an open crack. Where this is the case, all soil particles would have been mixed and many air bubbles would have been absorbed by soil particles. They would not be so clearly separated from particles and arranged in such rigid order.

Further argument results from consideration of the water structure itself. One can recognize, without chemical analysis, clear ice and slightly brownish-colored ice. On thawing, these types of ice give clear and red-brownish water, colored by iron oxides and humus acids. It is not difficult to determine that this colored water comes from peat layers, especially from the mud of the upper layers.

Iron hydroxide is often enriched in the form of a band some centimeters broad in soil layers parallel to and a short distance from the boundary between wall and ice-wedge. This means that concentration of the solution increased with the freezing process of the water when it was to be pulled out of the soil to form the ice-wedge. Solutions, on freezing above the eutectic point, are known to produce pure water and salts.

These observations show that ice-wedges originate and grow like a vein. They do not originate in the deposition of crystals of ice on the surfaces of an open crack, but by growth of needle-like crystals of ice leaving the pores of fissure walls.

Hoar Ice

To understand the mechanism of ice-wedge development, two kinds of hoar ice should be considered: One is derived from the moisture content of the air; the other, from the water content of solid porous materials.

The first, for example, forms the white frost on trees and grass when they suffer a period of frost and their cold surfaces contact warm air with relatively high water content. A condensation process then takes place. A very small ice crystal is formed as the basis for further crystal growing.

The origin of thin ice skins is due to the same freezing effect under similar weather conditions on surfaces with temperatures below zero—for example, on roads and windows. In the same way one can observe the origin of thin ice sheets, and no possibility is seen for the development of air bubbles within the ice.

Processes like these seem possible on the surface walls of open cracks. However, in this way, the surfaces are covered over with an ice crust and it is impossible for soil particles of the covered layers to penetrate the ice to form ordered rows,

alternating with rows of air bubbles. This process, therefore, can not account for the origin of ice-wedges.

The other form of hoar ice mentioned produces long, thin needles growing perpendicularly to the surfaces of porous materials, such as soil and rotted wood. In this case the needles rise up from the material. On a glacier in Spitsbergen I was able to observe and photograph their development on cryoconite particles which were suspended in the melt water in holes of the glacier surface. When the water in the small hollows froze and as the particles reached the surface level, ice needles grew in a few minutes. At the same time the particles reached the surface, the needles developed from the water content of the small balls and particles themselves. The needle crystals grew between the glacier ice and the contact point with the ball while the surface of the latter quickly froze. There is, therefore, no doubt that the water for the formation of these crystals came out of the interior through one or several pores.

This kind of hoar ice pipkrake (kammeis) occurs in vast areas which have cold climates. In Iceland I could observe this growing out of very porous tuff with high water content at the beginning of a frost period. The ice needles were so densely grown that they heaved up a thin frozen surface layer of soil more than 10 to 20 cm in height. With interruption of the freezing process, the growing of the ice needles also stopped. It began again when the temperature was lowered; then a new sheet of the frozen surface of the soil was heaved up, thus indicating the periods of frost effect.

Growth of ice needles can be reproduced in an icebox by maintaining frost temperatures a little below zero.

Open cracks, having ice needles of the above type, can occasionally be found when digging in permafrost. They prove that the ice is growing out of porous soil. Needles formed by condensation of the water content of air occur to a negligible degree. Therefore, vapor pressure and moisture content of the air are not necessarily important to the formation of permafrost and ice-wedges, although it will favor the water movement in the freezing soil. Most important, however, is the fact that the ice crystals grow by water movement through the pores of the soil in a direction perpendicular to the cooling surface of the fissure. This process explains the rows of soil particles and the arrangement of air bubbles enclosed between ice crystals and soil particles.

Development of Ice Veins and Wedges

Hoar ice appears to differ a great deal from the compact ice of ice-wedges which is composed of thick and coarse grain ice crystals. The significant difference is the formation process of the ice. We have to imagine that fissures which were filled with ice originate in a very early stage of the development of permafrost. To begin with they have only a width of some millimeters. They enlarge with frost penetration which is connected with increased drying due to water movement to the frost front at the surface as well as on the vertical walls of the fissure.

The fissures fill immediately with freezing water which comes out of the pores under the pressure of the freezing soil (developed by increasing water volume) and due to the action of hydration forces (dipole) of the first ice crystals. The water emerges rapidly, as one can observe from experiments in an icebox. As a result of pressure in the interior of the freezing soil layers, the water is supercooled. As soon as it reaches the surface of the soil at the openings of pores and enters the open fissure, where the pressure is diminished, it freezes, forming needles. Their elongation is prevented by needles from the opposite wall; but the water movement caused by frost pressure and suction continues. Thus new water surrounds a primary needle and grows together with it.

Growth of thick ice crystals is favored by the pressure in the filled fissure. Because of the effect of this pressure, one can never obtain the same results for fabric studies [14]. The pressure in the fissure and freezing soil is clearly indicated by deformation of the neighboring soil layers. These are sometimes elevated, depressed, thickened, or stretched (Fig. 3).

One always observes these tortuous layers in contact with horizontal and winding ice layers and lenses and these should be recorded as general features of cryoturbation on a small and large scale. Ice-wedges are an essential part of these layers in the Arctic. Experiments show that water movement begins as soon as frost touches the soil surface. Owing to decrease in volume by water loss underneath the freezing zone, vertical fissures developed, then filled with the water squeezed out under pressure and frost suction. It freezes on entering the fissure.

The second stage is the development, at the frost front, of horizontal ice layers and ice-lenses. They become thicker, the more water the soil layer contains and the more slowly the frost penetrates the soil.

During a third stage, the vertical ice fissures already formed are connected by the horizontal ice layers. Thus the network of heterogeneous frost soil and permafrost is developed in clay, silt, and similar soils—in contrast to the homogeneous frost in sand, gravel, etc. These facts are known from many investigators [10, 11, 26, 27, 28].

Hydration Processes and Initiation of Ice-Wedges

To understand these features and processes in freezing soils, and also the development of permafrost with ice-wedges, it is necessary to repeat material from the author's former papers [2, 3]. Since that time many experiments by others have confirmed the theory of hydration processes in freezing soil, although the results were not interpreted according to these basic processes.

During hydration the adsorptive and osmotic water of the soil particles is pulled toward the ice crystals by attraction forces, according to Coulomb and Van der Waal. This dehydrates soil particles. The water is used to build up the crystals, the dipole of which is more than 40 times stronger than that of liquid water.

By this movement of water to the frost front, the deeper lying layers of soil are dried out. In this way dehydration causes contraction of the soil. Vertical fissures must then originate and fill with water from the soil layers in the form of hoar ice like crystals, (this being fundamental to the behavior of water in soils), and not with water from precipitation or melt water. The cryoturbation is more intensive, the finer the soil particles the higher the water content, and the longer frost temperatures affect the soil [2, 26]. Contraction by dehydration of the soil through frost action is effected, therefore, long before and is almost completed when thermal contraction sets in.

It is also proved by the zero curtain in the freezing soil [20]. Theoretical thermal contraction takes place when the enlargement of volume, according to the metamorphosis of water into ice, is completed. But this transformation takes more time than the sinking down of the zero degree level of temperature. This means that even a frozen soil suffers an expansion tension. Thermal contraction, therefore, takes place only at a later stage. This happens where permafrost already exists, although we saw that the development of ice-wedges took place together with that of permafrost. Hence, permafrost, ice veins, ice-wedges, and tundra polygons are related by their development process. They are the result of deep reaching and slow frost penetration into thick wet soils of the Arctic—cryoturbation in the most intensive form.

A last point on the origin of ice-wedges is that many have observed in permafrost the formation of single open cracks together with loud reports. The development of a system of cracks similar to the mesh of ice-wedges has never been reported—although we have hundreds of observers in North America, Europe, and Asia living in permafrost areas and although these investigations have been proceeding for more than 120 years. We have, therefore, no reason to look for an explanation of ice-wedge systems and tundra polygons by thermal contraction.

Nevertheless, after dehydration of the freezing soil and development of permafrost, thermal contraction may produce thermal contraction cracks as described [15].

DISCUSSION

JERRY BROWN, U. S. Army CRREL, Hanover, N. H.—The paper under discussion essentially states that ice-wedges are the result of moisture segregation during development of permafrost, and which for some reason resulted in the predominance of vertically distributed ice masses. It is impossible in this brief discussion to refute all the arguments advanced. Toward this end, the interested reader is referred particularly to the conference paper by Lachenbruch and a recent paper by Black (*Annales de Géographie*, 1963, pp. 257-271). These two investigators provide the theory, data, and detailed observations required for at least the partial substantiation of the contraction theory of ice-wedge polygons.

The following points are inconsistent with the views advanced by Schenk:

1. Ice-wedges do form in relatively dry gravel in permafrost (Péwé), and are not restricted to wet soils.
2. The vast majority of high-centered polygons are present as a result of differential thaw along drainage gradients (Britton), and not as a result of the growth of palsen-like mounds.
3. Contrary to the author's statement, surface cracks have been reported to conform with the mesh of the underlying wedges (Black).

In the Point Barrow area, much of the near-surface permafrost, both between and immediately adjacent to ice-wedges, is supersaturated. In some areas of high-centered polygons perhaps 50% of this ground is composed of massive, vertically foliated ice. If all the water presently found in the ice-wedges originated in the unfrozen sediment, the original moisture content would have been greatly in excess of known saturation values. If moisture migration occurred, the principal direction of ice foliation should be horizontal, parallel to the cooling front. This is not the case. For these reasons alone, it seems likely that much of the ice-wedge water was derived over a period of years from an external source after the ground was initially frozen.

In Brown's paper, it was suggested that some lateral additions of sediment at depth are made to the growing ice-wedge. This was based upon the meager fossil record and the increase downward of ions in the ice found in only one wedge. Schenk's theory demands a many-fold increase in this process of lateral incorporation of sediment as the ice-wedge grows. The magnitude of this implied process cannot be deduced from the chemical composition of the ice-wedges. Again, it should be reiterated that the ionic compositions in the ice-wedge ice, even at maximum depths, seldom exceed that found in surface ponds and lakes. If substantial water and sediment were extracted from these marine deposits to form the ice-wedges, the conductivity of the ice would be many fold greater than observed.

Based upon the above, the most realistic explanation for the growth of ice-wedges in northern Alaska is that most of the water in ice-wedges was, and is presently being derived areally, from relatively pure seasonal melt water or water vapor.

Closure—1. According to international classification of soils of the arctic region (arkt. Nassböden) form a pedological group of arctic soils, the character of which is developed by moisture content (see, for example, papers of Tedrow, Kubiens, Mückenhausen, and the Atlas for Agriculture of the USSR). "Relatively dry" is no definition. Frost structures are developed in dry soils neither in nature nor in experiments. Moisture is the condition *sine qua non* for the origin of frost structures we observe everywhere in the world (see Schenk, 1955). Other possibilities for the occurrence of ice-wedge-like forms such as the occasional occurrence of ice in cracks developed by sliding, evaporation, drying, thermal contraction, tectonic movements, etc., do not concern the discussion of ice-wedge polygons of the tundra area.

Péwé, and also Black (in the discussion) mentioned ice-wedges in gravel, but they described neither their content of clay minerals nor their thickness; nor did they demonstrate

that ice-wedges were not caused by dehydration of the soil. Interbedded thin sand and gravel layers and gravel beds overlying thick beds of clay or peat, etc., are, of course, dissected by the ice-wedges, but they end as soon as they reach thick gravel beds. Neither the very thick perennially frozen gravel beds of the gold mines of Alaska, nor the refrigerated gravel masses washed out, nor the gravel beds in permafrost areas of Pleistocene, show any polygonal ice-wedge structures.

2. The high-centered polygons described by Britton are well known to me, and I described them in 1957. They do not concern the type of high-centered polygons of Bunge and Leffingwell, but they are the result of the collapse of polygons (of a different kind) by erosion along the ice-wedges. They do not form the vast majority (except at Barrow, Alaska) but are restricted to the neighborhood of lake shores, creeks, rivers, etc.

3. **Cracks**—In 1957 Péwé and Brewer showed me the cracks which Black had observed and where he had made measurements with iron stakes. I saw them again in 1959. These cracks, indeed, often conform with the mesh of underlying wedges. All these cracks were not thermal contraction cracks, but developed by frost heaving caused by the dehydration processes in the active frost layer with the formation of secondary ice veins and lenses in the border zone and interior of mounds.

4. **Supersaturation**—It is a fundamental fault to conclude that it cannot be because it is not allowed to be and to ignore the natural law of dipole forces and crystal formation—and even the primitive observation of slippery and slumpy ground when frozen soil is thawing! Moisture migration not only occurs, but is the most important process for the development of ice in layers and veins. This is stated by numberless measurements. I showed the movie which demonstrated how this migrating water filled out the cracks formed by dehydration of soil through the dipole forces of ice crystals. Water in the frozen ground derived partly from soil particles and partly from a water reservoir, (in deep-lying beds of sand and gravel).

The present moisture content of permafrost, therefore, never represents the original moisture content of sediments. The occasional enormous thickness of ice-wedges, which Black also mentioned, is no argument against dehydration but proof of this origin because the vertical foliation corresponds to the vertical cooling front along the wall of the fissure. Moreover, laccoliths in the interior of pingos between beds of clay material are much thicker.

5. **Incorporation of sediment**—Lateral incorporation of particles and sections of sediment when the ice-wedge is growing is not a theory but a general fact resulting from countless observations. They will be confirmed by observers who did not recognize this to date and will look for it now when observing beds of tuff, peat, sand, coal, etc., at Fairbanks, Barrow, Aklavik, Tuktoyatuk, Kuskokwim, Cool River, Kotzebue, Nome, etc. The particles of the neighboring layers of an ice-wedge cross the ice-wedge in a corresponding zone, as I showed in one picture of the paper presented here.

6. **Chemical composition of ice-wedges**—Ground water in arctic areas is generally a solution with low ion content. When freezing, this solution behaves as a eutecticum. Therefore, no "mixed" crystals (Mischkristalle) can develop. In consequence, the ice crystals in an ice-wedge must be pure water. The ions were pushed out and concentrated in the rest solution until their concentration was high enough to form crystals. Meanwhile, the freezing point of the solution, its vapor pressure, etc., changes correspondingly.

The result of these processes is sometimes the reddish brown border of ice-wedges and ice layers formed by iron minerals. Some salt crystals may also be poorly enclosed between ice crystals under certain conditions. Furthermore, we cannot expect that the usual chemical analysis will reveal new aspects of ice-wedges and ice formation. Misleading ideas can result if one does not consider this behavior of freezing water. Another thing is to investigate the water molecule itself or other ones. Demonstrating the general

existence of tritium and other radioactive fallout since 1954 in the ice of ice-wedges would prove that precipitation rushed into open cracks of wedges. This would be a simple and brilliant way to make my theory worthless. I am sure that nearly all ice of wedges is very old.

I mentioned a difference in the chemical character of ice-wedge water. I observed it where ice-wedges crossed thick peat layers. The water of this ice was light brownish (while other ice water was clear) caused by enclosed organic particles or by humic acid iron. Samples of these were analyzed by U. S. Geological Survey in Palmer, Alaska.

7. Insisting that ice-wedge water comes from melt water, precipitation, etc., according to that simple explanation of 100 years ago means ignoring modern physicochemical results. Applying mathematical methods cannot prove thermal contraction. To test this theory, one must assume that migration and dehydration take place first and produce features which belong to the true geological suppositions for mathematical treatment.

REFERENCES

- [1] T. L. Péwé. "Effects of Permafrost on Cultivated Fields, Fairbanks Area, Alaska," U. S. Geol. Surv. Bull. 989-f, 1954, pp. 315-351; "Geologic Map of the Fairbanks D-2 Quadrangle, Alaska," U. S. Geol. Survey, 1958.
- [2] E. Schenk. Die Mechanik der periglazialen Strukturböden; Abh. hess. L.-Amt Boden-forsch., 13, Wiesbaden, 1955.
- [3] E. Schenk. "Die periglazialen Strukturbodenbildungen als Folgen der Hydratationsvorgänge im Boden," Eiszeitalter und Gegenwart, Band 6, Öhringen/Württ., 1955.
- [4] L. Weickmann. "Beobachtungen von Strukturböden während der Polarfahrt des Grafen Zeppelin," Ber. Sach. Akad. d. Wiss. Math.-Phys. Kl., 84, Leipzig, 1932.
- [5] W. Czeratzki. "Bodenstrukturbildung und Frost," (Film C 724/1956) Inst. f. wiss. Film Göttingen, Göttingen, 1957.
- [6] A. T. v. Middendorf. Reise in den äussersten Norden und Osten Sibiriens, Petersburg, 1864 to 1867.
- [7] A. v. Bunge. "Naturhistorische Beobachtungen und Fahrten im Lena-Delta," Acad. Sci. St. Petersburg Bull. 29, 1884; "Einige Worte zur Bodeneisfrage," Russ. K. Mineral. Gesellsch. Verhdl., 2, Serie, 40, 1902.
- [8] A. v. Bunge, E. Toll. "Berichte über die von der Kais. Akademie der Wissenschaften ausgerüstete Expedition nach den Neusibirischen Inseln und dem Janaland," Beitr. z. Kenntnis d. Russ. Reiches 3, F. 3.
- [9] E. de K. Leffingwell. "Ground-ice wedges: The Dominant Form of Ground-Ice on the North Coast of Alaska," J. Geol., Vol. 33, 1915, pp. 635-654; "The Canning River Region," U. S. Geol. Survey Prof. Paper 109, 1919.
- [10] Stephen Taber. "Perennially Frozen Ground in Alaska—its Origin and History," Geol. Soc. Am. Bull., Vol. 54, 1943, pp. 1433-1548.
- [11] Gunnar Beskow. "Soil Freezing and Frost Heaving with Special Application to Roads and Railroads," Swedish Geol. Soc., 1935, Ser. C, No. 375 English transl. plus suppl. by Osterberg, Northwestern Univ.
- [12] Carl Troll. "Strukturböden, Solifluktion und Frostklimat der Erde," Geol. Rundsch., Bd. 34, 1944, pp. 545-694.
- [13] Alfred Dückler. "Über die Entstehung von Frostspalten," Schr. Naturwiss. Ver. Schleswig-Holstein, Bd. 25, 1951, pp. 58-64.
- [14] R. F. Black. "Fabrics of Ice-Wedges," Ph.D. thesis, Johns Hopkins Univ., 1953.
- [15] Troy L. Péwé. "Sand-wedge Polygons (Tessellations) in the McMurdo Sound Region, Antarctica - A Progress Report," Am. J. Sci., Vol. 257, 1959.
- [16] Arthur L. Lachenbruch. "Depth and Spacing of Tension Cracks," J. Geophys. Research, Vol. 66, No. 12, 1961.
- [17] B. Frenzel. "Die Vegetations- und Landschaftszonen Nord-Europas während der letzten Eiszeit und während der postglazialen Wärmezeit, I. Teil, Allgemeine Grundlagen"; Akad. Wiss. u. d. Lit., Abhdl. Math.-Naturwiss. Kl., Jahrg. 1959, Nr. 13, Wiesbaden, 1960.
- [18] Stephen Taber. "Perennially Frozen Ground in Alaska—its Origin and History," Geol. Soc. Am. Bull., Vol. 54, 1943, pp. 1433-1548.
- [19] E. Schenk. "Protokoll über das bodenkundliche Kolloquium am 16.1.1958," Institut f. Bodenkunde Universität Bonn; "Development and Collapse of the Structures of Perennial Frozen Ground" in print: (Proc. INQUA Warszawa 1961).
- [20] Max C. Brewer. "Some Results of Geothermal Investigations of Permafrost in Northern Alaska," Trans. Am. Geophys. Union, Vol. 39, No. 1, 1958.
- [21] K. E. v. Baer. "Expédition à Novaia-Zemlia et en Laponnie," Acad. Sci. St. Petersburg Bull. 11. H. 8-12 1837/38; X, 1866, S. 274.
- [22] A. I. Popov. "Origin and Evolution of Fossil Ice," Materialy K Osnovam Uchenia o Merzlykh Zonakh Zemnoi Kory, Vol. 2, 1955, pp. 5-24.
- [23] O. Herz. "Rapport du chef de l'expédition de l'Académie Impériale des Sciences à la rivièrè Bérésowka pour chercher un corps de mammoth," Bull. de l'Acad. Imp. Acad. Sci. St. Peterburg Bull., V sér., Tome XVI.
- [24] I. P. Tolmatschow. "Bodeneis vom Fluss Beresowka (Nord-Ost Sibiriens)," Russian-K. Min. Gesell., 2nd ser., Band 20, 1902, pp. 415-452.
- [25] R. F. Black. Discussion notes [19] (INQUA Warszawa).
- [26] A. Dückler. "Der Einfluss von Salzlösungen auf das Gefrieren von Böden," Strasse, Bodenmechanik und neuzeitlicher Strassenbau, 3. Folge, Bd. 17, Berlin 1939, pp. 63-82.
- [27] Simon Johansson. "Die Festigkeit der Bodenarten bei verschiedenem Wassergehalt, nebst einem Vorschlag zu einer Klassifikation," Sver. Geol. Undersokn. Arsbok 7, 1913, Ser. C, No. 256, Stockholm, 1914.
- [28] W. Czeratzki. "Zur Wirkung des Frostes auf die Struktur des Bodens," Zeitschr. Pflanzenernahrung, Düngung, Bodenkunde 72, 1956.
- [29] Troy L. Péwé. "Geomorphologie of the Fairbanks Area, Alaska," Ph.D. thesis, Stanford Univ., 1952.

DISTRIBUTION AND AGE OF PINGOS OF INTERIOR ALASKA

G. WILLIAM HOLMES and HELEN L. FOSTER, U.S. Geological Survey, Washington, D.C.
DAVID M. HOPKINS, U.S. Geological Survey, Menlo Park, Calif.

This paper is intended to serve as a basis for future detailed morphological, cryological, botanical, microclimatological, and thermal investigations. It is based chiefly on studies in two areas: Manley Hot Springs area in the lower Tanana Valley (Fig. 1), investigated by Hopkins, and upper Tanana Valley and adjacent parts of the Yukon-Tanana upland, investigated by Foster and Holmes.

Serious speculation about the origin of pingos dates from Leffingwell [2] early in this century, and current ideas held about these features were introduced about 25 years ago by Porsild [3]. The latter noted that pingos in northwestern North America are found on both sloping and level ground. Mounds on sloping ground occur in sandy or other pervious soils. Pingos found here are sparse, small, of various shapes, commonly ruptured at the top, and apparently formed by hydraulic pressure of moving ground water. Mounds on level ground, especially in the Mackenzie River Delta area, are large, abundant, and usually found in old lake basins. Presumably, this type was formed by local upheaval of the overburden by encroaching and freezing of confined ground water. This might occur in lakes that become too shallow to prevent formation of permafrost. Recent studies [4] in Greenland and the Northwest Territories supplied detailed evidence for two types described by Porsild; Müller termed these the open-system and closed-system pingos, respectively. He showed that very few pingos had been reported from the boreal or sub-arctic forest zone, except for a few in central Siberia and western Alaska.

REPRESENTATIVE PINGOS

Pingos of interior Alaska are conical, elliptical, oval, or irregular mounds and are found singly or in clusters. They range from 10 to 100 ft in height and from 25 to 1200 ft in diameter. Thus their maximum size is less than, but roughly average to pingos on arctic tundra [4, 5]. Some pingos of interior Alaska are smooth mounds with undisturbed vegetation and no micro-relief, but most have one or more features such as trenches, slumped sides, mounds, craters, ponds, or springs—indicating disturbance or collapse. Microrelief features readily identify pingos and distinguish them from landslide blocks, bedrock knobs, mud volcanos, or thaw lakes.

Fig. 2. shows a symmetrical pingo in a typical setting near the edge of a silt-filled valley in the upper Tanana area (lat. 63° 55' N; long. 144° 33' W). It is covered by a mature stand of aspen, birch, and spruce, and is surrounded by scrubby muskeg vegetation. A nearly symmetrical cratered pingo in the upper Tanana area (lat. 63° 45' N; long. 144° 12' W) is shown in Figs. 3 and 4. It has a mature birch forest on its flanks, a circular pond in the crater, and muskeg vegetation on the valley floor around it. Figs. 5 and 6 show pingos in the lower Tanana area near Manley Hot Springs. The Pioneer Creek pingo (lat. 65° 15' N; long. 150° 05' W; Fig. 5) is probably more typical of those of interior Alaska than the foregoing examples. Located on the side of a hill, it has a marked asymmetric profile, a large drained crater, and springs near the summit of the pingo. The McKinley Creek (lat. 65° 09' N; long. 150° 20' W; Fig. 6) pingo is an unusually broad, low mound, with vegetation concentrically zoned, grading inward from wet-ground plants around its margin to a birch-willow-heath assemblage on its well-drained summit.

DISTRIBUTION AND ENVIRONMENT

Regional Distribution and Density

Pingos are found throughout interior Alaska—in the Kateel River, Hughes, Ruby, Tanana, Kantishna, Livengood, Fairbanks,

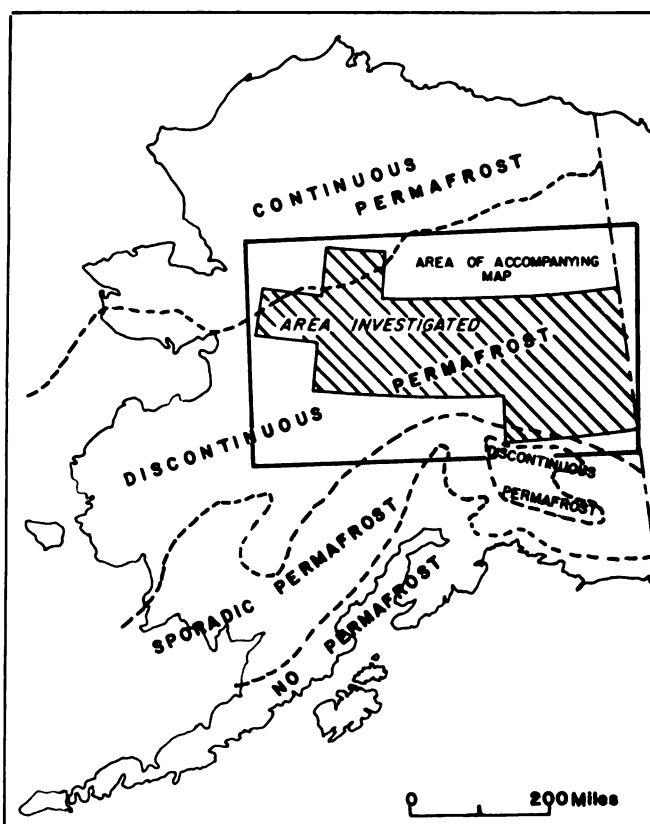

Fig. 1A. Areas in the lower and upper Tanana Valleys and parts of the Yukon-Tanana upland where the authors carried on the investigations

Circle, Big Delta, Mt. Hayes, Charley River, and Tanacross (1: 250,000-scale topographic quadrangles, Fig. 1). Systematic inventories of pingos based on ground traverses, aerial reconnaissances, and aerial photographs, have resulted in identifying about 45 pingos in the 6000 sq miles encompassed by the Charley River quadrangle, about 150 pingos in the 8300 sq miles encompassed by the Tanacross quadrangle and the eastern third of the Mt. Hayes quadrangle (Fig. 7), and about 50 pingos in the 500 sq miles encompassed by the Manley Hot Springs area. Probably some pingos have gone unnoticed in each of these areas. Fig. 7 shows that the pingos are not uniformly distributed; some areas have as many as 10 pingos per 100 sq miles, but others have few or no pingos. Pingo density is much greater in some arctic tundra regions of continuous permafrost. Densities as great as 100 pingos per 100 sq miles are reported in parts of the Mackenzie River Delta areas [5].

Climatic Setting

Interior Alaska has long, cold winters and short, warm summers. Mean annual temperatures at different stations range from 22° to 28°F. Annual precipitation is low, ranging from 10 to 15 in.; more than half of it falls as rain during summer months [6].

Climates of the arctic tundra regions of the pingos studied differ chiefly in their shorter and cooler summers, lower mean annual temperatures, and less precipitation [6, 7].

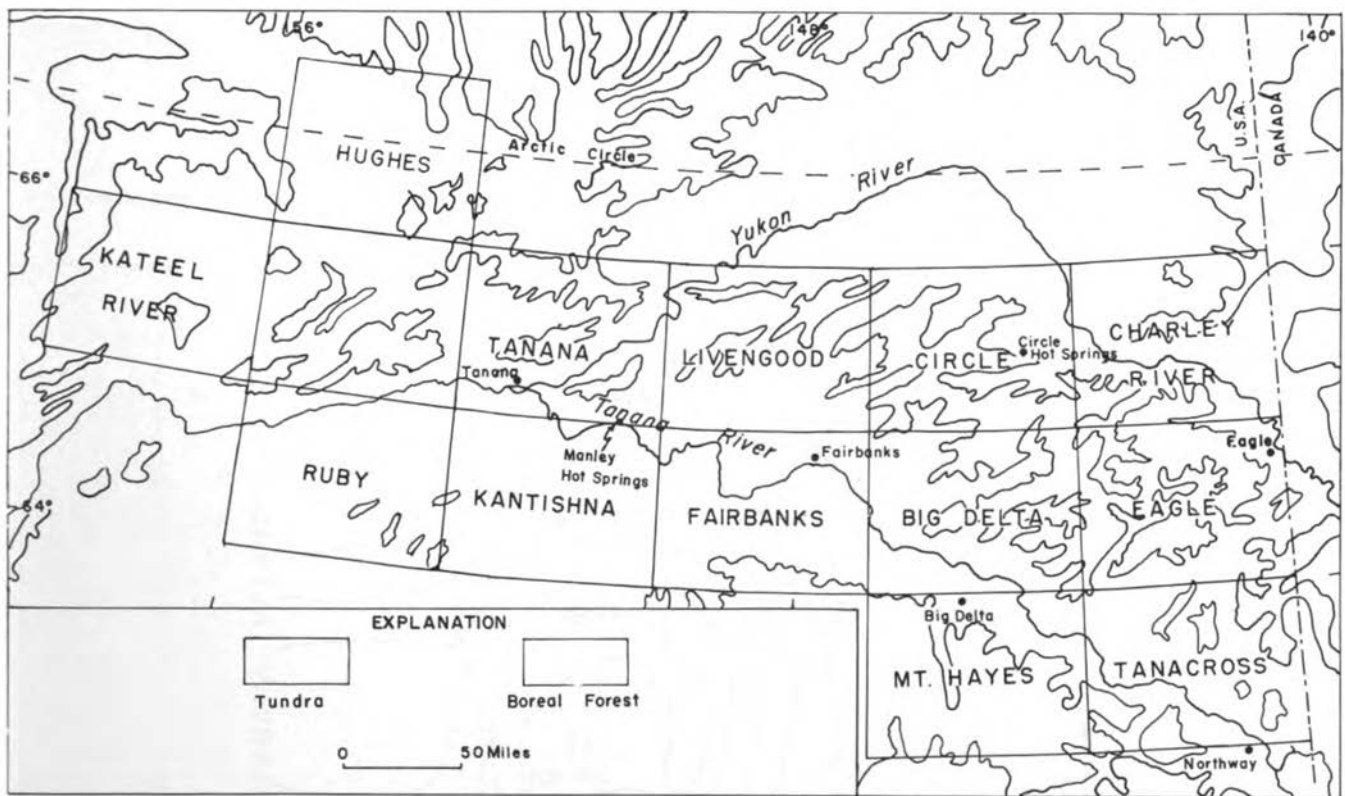

Modified from Sigafos

Fig. 1B. The areas investigated in relation to pingos in interior Alaska



Fig. 2. A symmetrical pingo near edge of a silt-filled valley



Fig. 3. A cratered pingo in the upper Tanana area

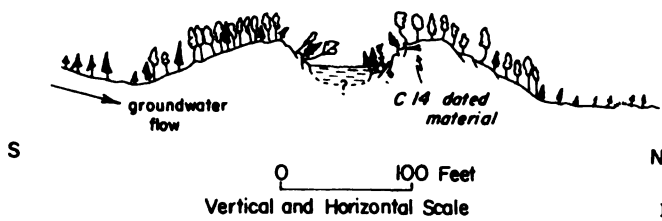

Fig. 4. A birch forest on the flank of this cratered pingo

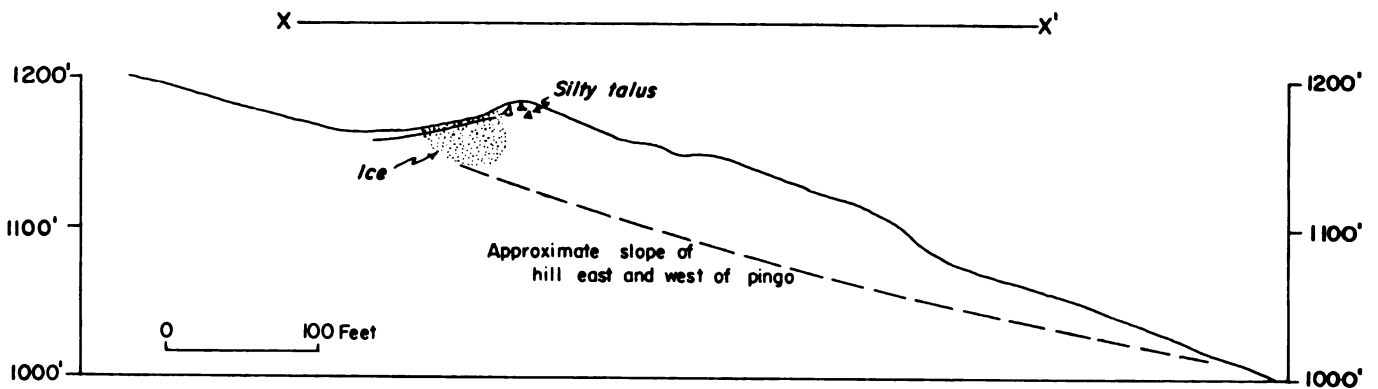
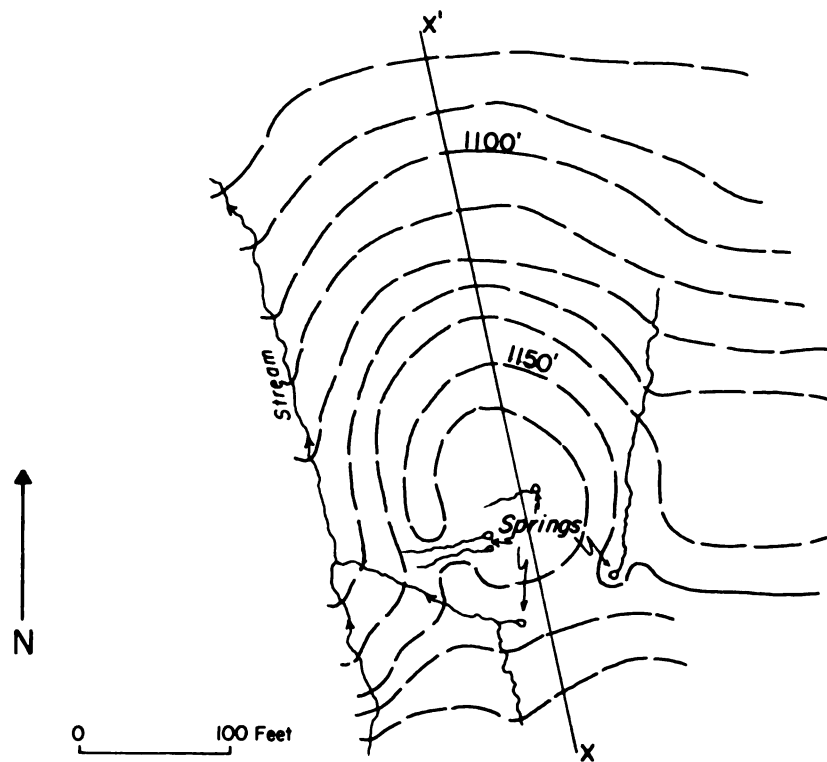

Fig. 5. Asymmetric profiles of a Pioneer Creek pingo

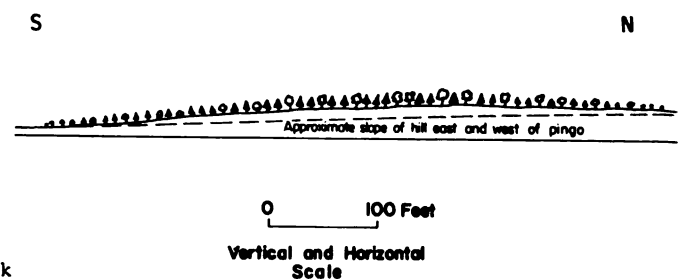

Fig. 6. Pingo near McKinley Creek

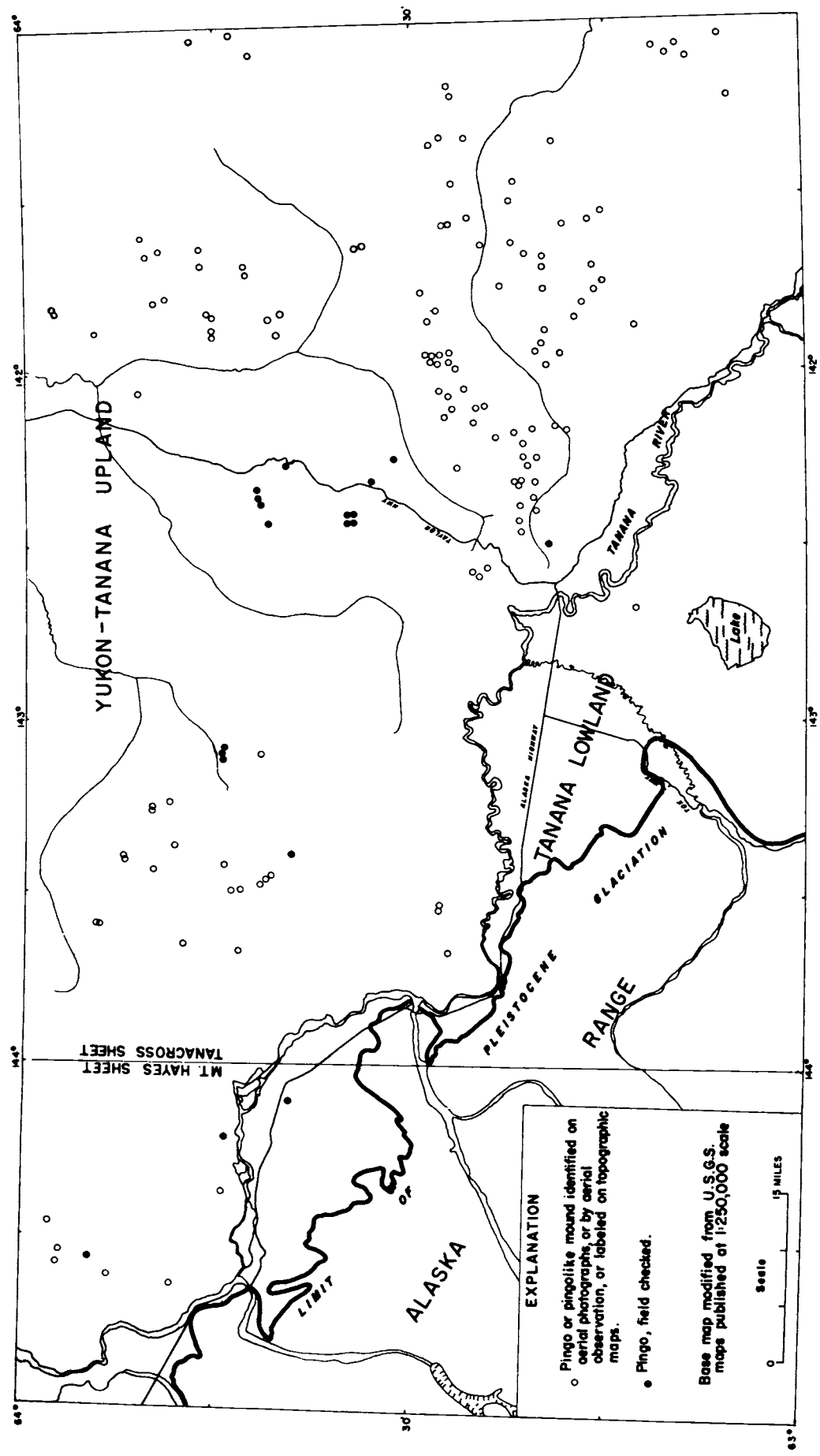

Fig. 7. Distribution of pingos

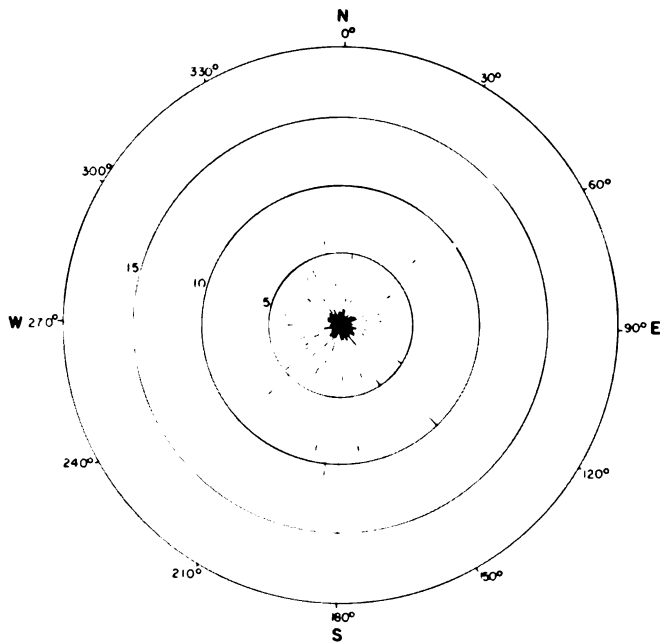

Fig. 8. Downslope direction measurements

Vegetation

The plant cover of interior Alaska includes broad areas of boreal or interior spruce and birch forest, which is a discontinuous zone interrupted by tundra on the higher hills and mountains (Fig. 1). More detailed maps show the boreal forest interrupted in low areas by patches of shrubby muskeg vegetation and treeless bogs. No pingos were reported from upland tundra on hill or mountain summits here, but many exist on muskegs and bogs within the boreal forest. Of 170 pingos whose vegetational environment is known, 61% are in forested areas, 34% in areas of shrubby muskeg vegetation, and 5% in treeless bogs.

Geology

Pingos are found in areas underlain by complex and deformed Paleozoic and Mesozoic sedimentary rocks, by the Precambrian Birch Creek Schist, by Mesozoic granitic rocks, and by Mesozoic and Tertiary volcanic rocks. They exist on valley slopes and floors covered with Pleistocene and Recent unconsolidated deposits, including colluvium, valley alluvium (ranging in grain size from silt to gravel), alluvial fan deposits, loess, organic silt, and weathered bedrock. Although no pingos were observed in areas of glacial till or outwash, they might be found in areas of glacial drift.

Slope and Drainage Requirements

Virtually all pingos studied here lie on gentle to moderate hill slopes or on nearly flat valley floors. None were observed in drained or shallow lake basins, although these are abundant on the floor of the upper Tanana Valley. Downslope direction measurements of nearly 250 pingos show a slightly preferred orientation toward the south and southeast (Fig. 8) and secondary preferences for east- and north-facing slopes. When these orientations are examined in their geological setting, two environments appear: (a) Near the lower end of long, gently inclined slip-off slopes, oriented either toward the west, east, or south; and (b) just below the base of steep, north-facing bluffs (Fig. 9).

Pingos on gentle slip-off slopes are usually found in clusters roughly aligned parallel to contours. Some pingos are found astride minor surface drainage lines, but most appear to be independent of surface drainage. The latter are confined to slopes thickly mantled with perennially frozen silt, and probably mark sites where ground water confined in underlying unfrozen gravel gains enough hydrostatic pressure to break through the overburden of frozen silt.

Pingos on the steep north-facing slopes are also found in clusters, commonly as groups of mutually interfering pingos of different ages. Most north slope pingos lie downslope from mouths of ravines believed to lie along north-trending, shear-zones in bedrock; this suggests that they are localized by ground water emerging from fault zones.

Fig. 9. Geological layers of a pingo

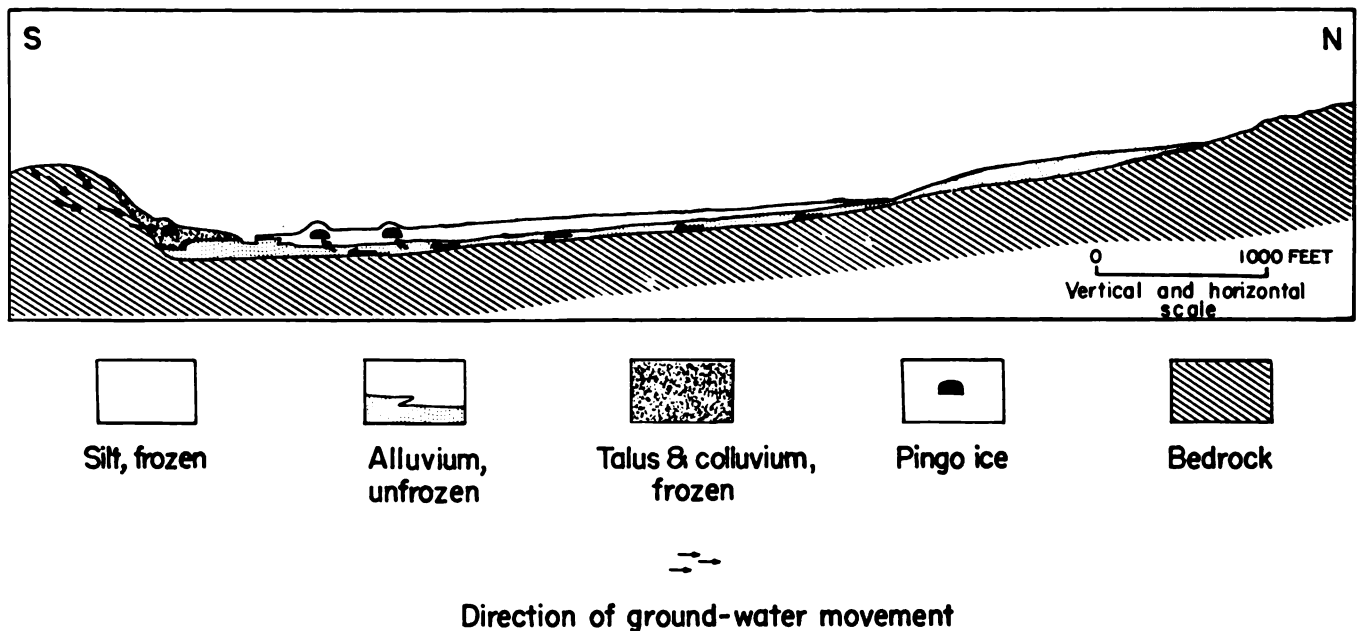

AGE OF PINGOS

Individual pingos of interior Alaska differ widely in age; all studied are more than 10 years old, and probably none is more than 7000 years old.

None of the pingos observed were formed within the last decade. For example, many in the Manley Hot Springs area were photographed in 1951 and again in 1959. None had changed in characteristics detectable on aerial photographs during the intervening period. Since some of the seemingly youngest pingos appear on both sets of photos, probably most of these pingos developed before 1951.

Many pingos developed in poorly drained areas; local drainage conditions have generally improved because of arching above surrounding terrain. One or two pingos, perhaps only a few decades old, bear vegetation still responding to the improved drainage; this response holds true with most pingos. Several are supporting trees more than a century old that were unable to begin growing until pingos had been formed; still older generations of trees are represented by rotting stumps and fallen logs. Pingos bearing evidence of two generations of forests cannot be less than two centuries old, and most are probably much older.

Weak, youthful appearing soil profiles developed in surficial mantles indicate an upper age limit. Most pingos have developed where soil is saturated throughout the thawing season, so that, presumably, a half-bog or tundra soil was present before surficial material was arched by development of the pingo. Some gently sloping and poorly drained pingos still have such a soil. The higher, steeper pingos, however, are well drained and their silt cover is remarkably dry; a forest-brown soil or a podzol should be developing in these sites. However, silt on the high, well-drained pingos shows only a weak, poorly developed soil profile, consisting of a 3- to 6-in. zone of weak oxidation grading into grey or olive unoxidized silt. The soil profile on these pingos represents a much shorter time span than the much thicker profile developed on loess of Wisconsin age on well-drained slopes. None of the pingos showing this weak soil profile can be more than a few thousand years old.

The possible age of one pingo in the upper Tanana Valley is limited by the radiocarbon age of wood incorporated in the alluvial sediments that were arched when the pingo was formed. A fragment of spruce wood buried 2.5 ft deep in the mantle of the pingo north of Dot Lake (Fig. 3) has a radiocarbon age of 7010 ± 150 years [8]. The wood consists of detrital material deposited with the silt prior to pingo formation; thus, this pingo must be less than 7000 years old.

Investigators of pingos in northern Canada arrive at slightly different conclusions; though most pingos there are clearly of Recent age, they are thought to have formed during the cooling that followed the hypsithermal interval. Craig [9] establishes a maximum age of about 5500 years for a pingo in the Thelon River Valley, lying in a tundra region of the continuous permafrost zone. The date was obtained from organic material in laminated silt 1.5 to 4.5 ft from the upper surface of the pingo. Organic material included pollen indicating forest vegetation; Craig infers that the pingo formed because of the same climatic change which caused the forest's return to present tundra vegetation.

Radiocarbon datings of organic material [10] from the upper strata of two Mackenzie Delta pingos near Tuktoyaktuk, NWT, indicate a maximum age of $12,000 \pm 300$ years for the Ibyuk pingo and 6800 ± 200 years for the Sityok pingo. Müller believes that the updoming of the Ibyuk pingo occurred no later than 7000 to 10,000 years ago, and that the Sityok pingo probably formed about 4000 years ago, or at roughly the same time the climate began to cool after the hypsithermal interval. Hence, there is rough agreement in maximum age for at least four pingos in northwestern North America.

Mackay [11], on the basis of evidence from vegetation types, humus thickness, widths of ice-wedges, peat accumulation, and cliff recession, also believes that the closed-system pingos of the Mackenzie Delta area are a few thousand years old.

CONCLUSIONS

Closed-system pingos have not been recognized in interior Alaska and probably are not present there. Thus far they have been reported only from areas of continuous permafrost having mean annual air temperatures of 12° to 22° F. Within these areas, they are confined specifically by certain hydrological and edaphic conditions, as shown by Müller; these conditions are most commonly met in shallow or drained lake basins.

Open-system pingos are abundant in the discontinuous permafrost zone of interior Alaska in areas having mean annual air temperatures of 22° to 28° F; they are rare in the continuous permafrost zone, but have been reported in east Greenland where the mean annual air temperature is about 14° F. Within interior Alaska, open-system pingos are confined to areas where the following hydrologic and edaphic conditions exist: (a) A thick layer of unconsolidated sediments mantling a sloping surface; ground perennially frozen to depths of the order of 100 ft; (b) an aquifer present beneath the perennially frozen sediments through which ground water flows to the pingo site.

Open-system pingos of central Alaska are of diverse ages; new ones have formed continuously during the last several thousand years. Thus, they did not result from any known single recent climatic fluctuation in central Alaska.

Although no pingos of Pleistocene age are known, they could have formed in periglacial interior Alaska. Open-system pingos, and possibly also closed-system pingos, pass through a sequence of developmental and degenerative stages, eventually becoming lakes with uneven, raised shores. Possibly some of the hundreds of small lakes in the valleys of the Yukon-Tanana upland, sometimes regarded as thaw lakes, may be very old pingo craters.

ACKNOWLEDGMENTS

Much supplementary information was contributed by persons in or associated with the U. S. Geological Survey. The authors are grateful to George Corchary and Arthur Fernald, who supplied information on the upper Tanana Valley; Florence Weber, Troy Péwé, and Robert Chapman, who furnished data on the Fairbanks, Big Delta, Livengood, Kantishna River, and Tanana areas; Reynald Isto and Arthur Gervais, who provided locations of pingos from widely scattered parts of interior Alaska; and Daniel Krinsley, who supplied data on the Circle area.

REFERENCES

- [1] Robert S. Sigafos. "Vegetation of Northwestern North America, as an Aid in Interpretation of Geologic Data," *U.S. Geol. Survey Bull.* 1061-E, 1958, pl. 9.
- [2] E. deK. Leffingwell. "The Canning River Region, Northern Alaska," *U.S. Geol. Survey Prof. Paper* 109, 1919.
- [3] A. E. Porsild. "Earth Mounds in Unglaciated Arctic Northwestern America," *Geog. Rev.*, Vol. 28, 1938, pp. 46-58.
- [4] Fritz Müller. "Beobachtungen über pingos," *Medd. om Grönland*, Bd. 183, No. 3, 1959.
- [5] J. Ross Mackay. "Pingos of the Pleistocene Mackenzie Delta Areas," *Geog. Bull.*, No. 18, 1962, p. 26.
- [6] U.S. Weather Bureau. "Climatic Summary of Alaska: Supplement for 1922 Through 1952," 1958.
- [7] Fritz Müller. *Op.cit.*, pp. 58, 96.
- [8] R. Nydal. Spec. T-303, Norwegian Inst. Tech., Trondheim, 1961, priv. comm.
- [9] B. G. Craig. "Pingo in the Thelon Valley, Northwest Territories," *Geol. Soc. Am. Bull.*, Vol. 70, 1959, pp. 509-510.
- [10] Fritz Müller. "Analysis of Some Stratigraphic Observations and Radiocarbon Dates from Two Pingos in the Mackenzie Delta Area, NWT," *Arctic*, Vol. 15, 1962, pp. 278-288.
- [11] J. Ross Mackay. *Op.cit.*, pp. 58-60.

Publication authorized by Director, U. S. Geological Survey.

ICE-WEDGE CHEMISTRY AND RELATED FROZEN GROUND PROCESSES, BARROW, ALASKA

JERRY BROWN, U. S. Cold Region Research and Engineering Laboratory, Hanover, N. H.

The chemical regime of ice-wedges is a potential tool for further elucidating the complex mechanism of ice-wedge genesis. Vertical and horizontal variations in the ionic concentrations of an ice-wedge reflect differences in the amount and type of included materials and the nature of the nourishing water supply. It is conceivable that changes in the chemical regime of the seasonally thawed soil, during the millennia of ice-wedge growth, may be observed indirectly in the chemical variation of underlying ice.

Chemical data were gathered from ice-wedges and associated soils in the Barrow area, northern Alaska. Hypotheses are formulated to explain the stratigraphic record of the sample site and the mechanisms by which the chemical compositions of the ice developed.

SITE DESCRIPTION

The site of this study, a ridge elevation of 8.3 m between Barrow Village and Voth Creek, (lat. 71°17'53" N; long. 156°42'29" W), is located at the northern extremity of the Arctic Coastal Plain. Microrelief is composed of high-centered polygons and thermokarst ponds. The perennially frozen sediment is predominantly sands and silts, with seasonally thawed soil seldom exceeding 0.5 m in thickness. There is a conspicuous zone of buried organic matter at a depth of 0.4 to 1.2 m below the surface. Fig. 1 illustrates surface microrelief, approximate location of subsurface ice and stratigraphic units, and sample locations.

Wedge I (sections 1A and 1B) is an active surface wedge developed under a soil cover 0.6 m thick; it occupies the trough surrounding the raised polygons. Wedge II is a narrow, fissure or vein-like ice body. Its irregularly shaped upper

surface is located near the base of the buried organic zone at 1.3 m. Wedge III is at a depth of 3 m below a zone of high ice mineral sediments. The sediment immediately above wedge III contains small masses of woody peat. Ice-wedge IV is located at a depth of 3 m in the center of a high-centered polygon 15 m south of the principal site. Its origin is probably similar to that of wedge III. Vertical foliation [1] is distinct in all wedge sections. Considerable variation in the amount and type of organic and mineral is found in residues recovered from the thawed ice-wedge ice.

Geologic and pedologic literature contains information pertinent to the Barrow area and this paper [1 to 11].

METHODS

Access holes 0.8 m in diameter were augered to depths of 6 m in frozen ground. Vertical samples were obtained at 0.3-m intervals by chipping downward along nearly parallel sets of foliations. Horizontal samples were obtained with a modified 3-in. SIPRE ice corer. Samples weighing approximately 500 g were collected in polyethylene containers and thawed; the supernatants were analyzed chemically. The residue was dried, weighed, wet sieved, and examined microscopically.

Specific conductance was determined by procedures of the U. S. Geological Survey, Ca plus Mg determinations were by EDTA titration, Na and K were determined by flame photometry using a Li internal standard, and Cl was determined by mercuric nitrate titration. Soil solutions were extracted from thawed soil under vacuum at the field moisture content. Determination of moisture content was based on oven-dried weight, 105°C, and mechanical analysis was by conventional hydrometer and sieving methods.

In the laboratory, frozen soils were placed in known volumes of deionized water, and conductance was determined on the supernatant to establish the relationship of conductance to concentration (g/liter) of different residues. Radiocarbon dates of peat buried in the frozen soil and of organic residue recovered from the buried ice were determined by Isotopes, Inc. Buried peat samples were pretreated with NaOH and HCl to reduce errors from contamination by soluble organic constituents and carbonates. However, the small quantity of the ice-residue sample permitted only HCl pretreatment.

RESULTS

Chemical

Fig. 2 presents a partial chemical analysis of five vertical sections of ice-wedges. In the surface wedge (sections 1A and 1B), all ionic components increase with depth, approximately 10-fold in 1A and 5-fold in 1B. In wedge II, where each sample represents the entire cross section of the wedge, only minor fluctuations occur with depth, and concentrations are approximately one-half those found in wedge I at comparable depths. Ionic concentrations in the upper portion of wedge III are comparable to those in the basal section of 1B, but do not show an over-all increase with depth. Average equivalent Na/Cl values for individual sections range from 0.55 to 0.67, with no significant change for depth. Concentrations of potassium, not presented, range from 0.01 to 0.1 meq/liter (Milliequivalents per liter) and showed more scatter than the other ions.

Table I presents a partial chemical analysis of soil samples from above and adjacent to the ice sections. Concentration of soluble salts increases with depth. Na/Cl values vary widely between 0.25 and 1.2. Specific conductance of spring melt water is a fourth to a half that of summer surface water.

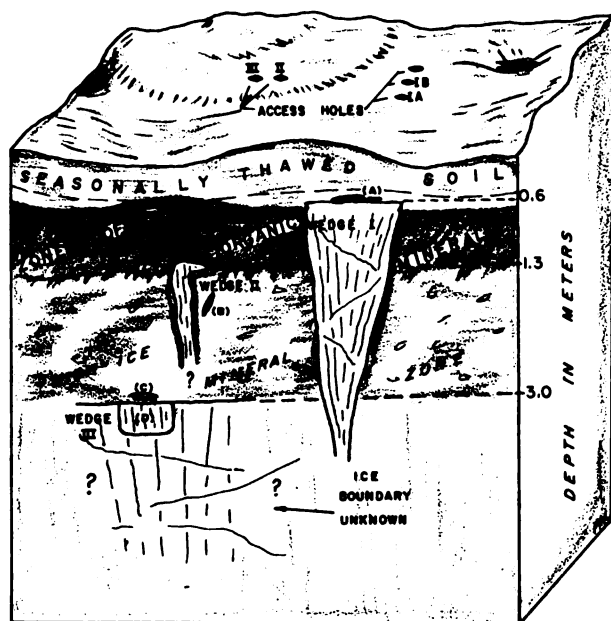

■ BURIED PEAT - RADIOCARBON DATED
[A] DESIGNATION OF RADIOCARBON SAMPLE

RADIOCARBON DATES ARE: (A), 1775 ± 120 (I-699)
(B), 9550 ± 240 (I-700); (C), 10,525 ± 280 (I-701); (D), 8200 ± 300 (I-992)

Fig. 1. Block diagram of sample site, Barrow, Alaska

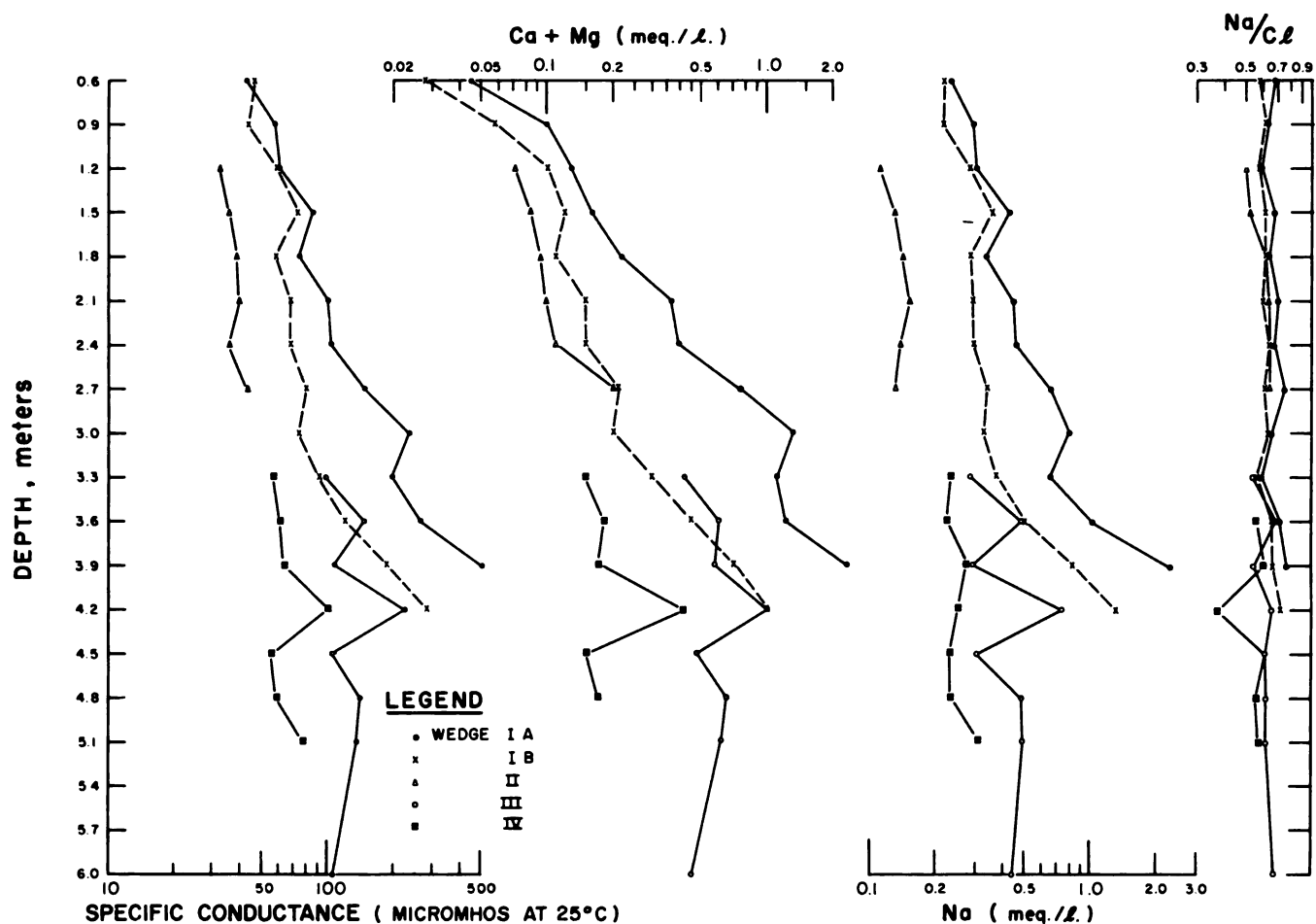

Fig. 2. Chemical composition of vertical sections of ice-wedges

Table I. Chemical composition of associated soil and surface waters, Barrow, Alaska

Section	Depth (m)	Moisture (%)	Associated Soil ^a					Na/Cl
			Specific conductance (micromhos)	Ca and Mg (meq./liter)	Na	K	Cl	
IA	0.6	70	470	1.7	0.98	0.15	2.8	0.35
II	0.9	121	610	2.9	0.55	0.21	0.68	0.81
II	1.2	156	300	---	0.43	0.11	0.36	1.2
II	1.5	92	820	4.3	1.1	0.23	2.2	0.50
II	1.8	80	970	5.7	1.5	0.25	3.7	0.41
II	2.1	94	880	5.4	1.4	0.22	3.4	0.41
IV ^b	3.0	120	3 900	26.0	8.1	0.35	32.0	0.25
IA	3.6	210	5 900	31.0	41.0	1.7	43.0	0.95
IB	3.9	145	7 300	43.0	48.0	1.6	59.0	0.82
IV ^b	6.0	88	12 200	63.0	52.0	1.0	124.0	0.42

Samples	Specific conductance (micromhos)	Surface Waters			Na/Cl
		Ca and Mg	Na (meq./liter)	Cl	
Ponds ^c	140-170	0.78-0.90	0.47-0.65	0.71-1.1	0.56-0.66
Meltwaters ^d	30-75	---	---	---	---

^a Analyses on soil solution extracted from thawed soil at natural moisture contents. See reference [9] for discussion on conversions of moisture and conductance data.

^b Section IV and hole 35 [9] are the same sample hole.

^c Four ponds sampled late August within 100 m of site (Fig. 1).

^d Values for samples adjacent to above ponds, sampled early June.

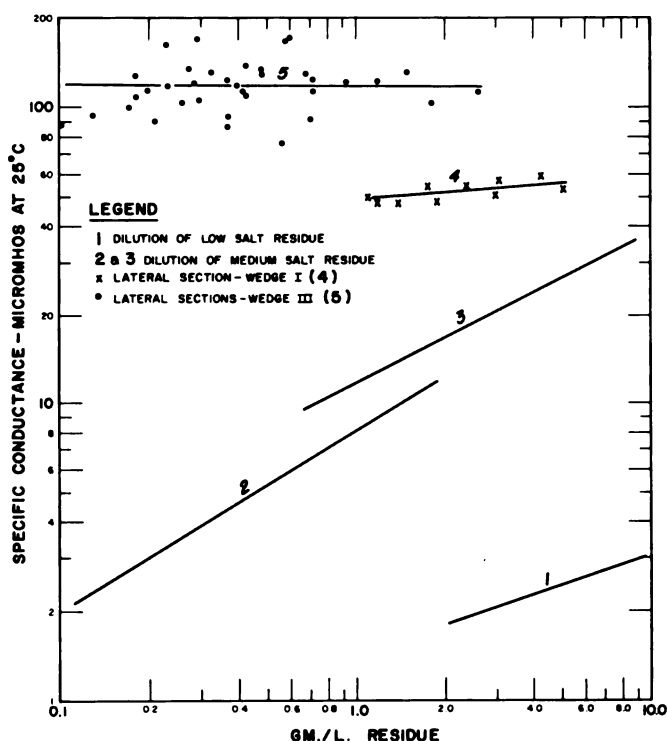

Fig. 3. Relationships of residues and conductance

Fig. 3 demonstrates the relationships between residue and conductance for laboratory and field samples. Dilutions in deionized water of a medium salt residue are represented by curves 2 and 3; that of a low salt residue (derived from above wedge I) is represented by curve 1. There is a 5- to 10-fold difference between these two soil residues. Curve 4 represents the residue-conductance relationship for the ice recovered from a horizontal core 1-m long in wedge I at a depth of 1 m. A 5-fold increase in the amount of residue increased the conductance by only several micromhos, a similar relationship was observed in the laboratory dilutions. The scatter in points around curve 5 represents sample variations from horizontal sections up to 5 m long to wedge III at a depth of approximately 4.5 m. The residue was predominantly organic. No correlation exists between amount of residue and conductance of thawed ice in these horizontal sections.

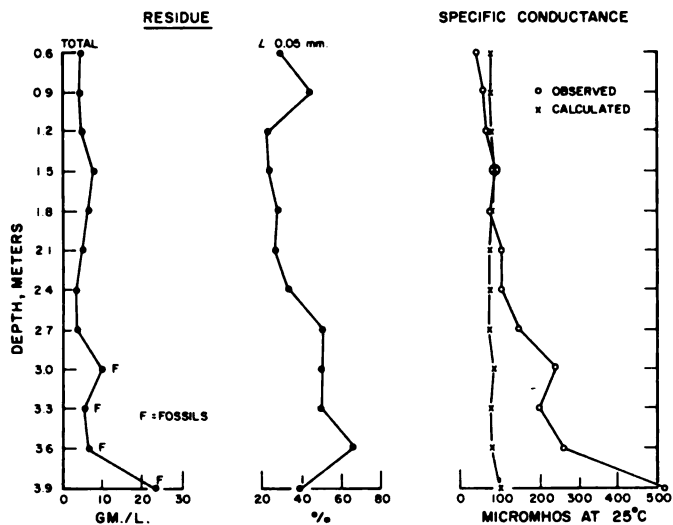

Fig. 4. Analyses of residue and conductance for section 1A

The influence of residue upon conductance is further examined in Fig. 4 for section 1A. The observed conductance is plotted linearly. In order to evaluate the effect of an assumed chemically constant residue or soil upon total conductance, recalculated values are obtained by using amount of residue (Fig. 4), curves 2 and 3 (Fig. 3), and a value of 50 micromhos for a residue-free ice. The calculation assumes that contribution of diluted residue plus conductance of residue-free ice equals total conductance of the thawed ice-wedge. Observed and calculated conductances coincide for the upper portion of the wedge, with the observed values increasing in the lower sections.

Stratigraphy

Radiocarbon dates of buried peat and organic residue from wedge III are presented in Fig. 1. An additional sample, which yielded an age of $14,000 \pm 500$ years (I - 1171), has since been dated. The organic residue is from the same ice mass (wedge III) and is located 4 m from sample D (I - 992). Examination of the buried peat samples for pollen [12] indicated a significant abundance of alder in the youngest peat (A), and little or no alder in the two older peats (B and C). All three peat samples were dominated by grass pollen. Approximately 50% of the mineral soil overlaying wedges I and II is composed of particles less than 0.05 mm in diameter. The fraction of the organic-mineral residue less than 0.05 mm (wet sieve analysis) ranges from 6 to 67%. The plot for section 1A of the less than 0.05 mm residue shows a slight increase with depth (Fig. 4).

DISCUSSION

Chemical

The contraction theory of ice-wedge growth implies that water and residue are added from above the surface of the expanding ice-wedge, with an additional accumulation of ice in the contraction crack as hoarfrost [1, 2, 6, 7, 13, 14]. The principal source of this surface water is the spring melt of snow, which generally has a conductance of less than 75 micromhos. Most of the organic residue originates from the vegetated surface of the polygon trough, although some is probably derived from the buried peat zone. Mineral and organic materials either drop into the contraction crevice during winter or are washed in with spring melt water. Therefore, chemical composition of ice-wedge ice is predominantly a function of water supply and residue.

The data from sections 1A and 1B suggest an apparent disparity with the above discussion. The 5- to 10-fold increase in the ionic contents with depth should not occur if the water and residue are derived from a surface water source and from soil of relatively constant composition. These increases are not accompanied by proportional increases in the residues as indicated by the calculated values (Fig. 4). Microscopic examination of the residue revealed ostracods and other fossils in the lower portion, or apex zone, of both sections (1A and 1B). Fossils are not abundant in the overlying sediment, nor were any recovered from residue in the upper portion of wedge I.

This evidence, plus the fact that salinity of the sediment increases with depth (Table I and [9]), strongly suggest that fossiliferous sediments are incorporated from the sides into the lower portion of some ice-wedges.

Possible mechanisms for this incorporation or accretion of sediment include addition of adjacent strata by folding into the expanding wedge or simply by the growth of the wedge into the adjacent sediment. In addition, fractures may form along or traverse the lateral wedge-sediment interface, thereby incorporating sediment from the side into the wedge. Incorporation of some residue and highly mineralized water or ice into basal sections of wedges may also occur locally under pressure, although no field evidence of this was observed.

In addition to these methods of lateral accretion at depth to the wedge, residues from the surface, such as leaves, also penetrate the deeper portion of the contraction cracks. The

relatively uniform salt contents of wedges III and IV suggest a more conventional mechanism of crack filling from above the wedge. These data imply that several types of residue incorporation are present, perhaps even in the same wedge.

Ionic concentrations in the top meter of surface wedges are comparatively low. The wider crack near the surface is filled with more water per unit residue than is the narrower and lower portion of the crack; consequently, dilution is greater near the surface. Gorham [15] proposed to explain variability of salt concentration in an ice crevice by the selective removal of intercrystalline brine during melting. However, it seems unlikely that leaching or ionic diffusion occur in the ice-wedge environment to any degree, particularly at these low ionic concentrations. Differential accumulation of hoarfrost ice would be purer than surface water.

Wedges II and III contain similar quantities of organic and mineral residue, with a predominance of the former. Ionic concentrations of wedge III are 2 to 3 times greater than those of wedge II. However, it would be speculative at this point to relate these differences to changes in concentration of surface water and/or soil residue with time. Chemical composition of present day surface waters in the Barrow area is usually at least several times that of ice-wedge ice, with a large areal variation [16 to 18]. Comparable Na/Cl values of surface water and ice-wedge ice suggest a similar type of water supply throughout periods of wedge growth—surface water in contact with a marine environment and sediment.

Limited horizontal sampling was conducted to test the hypotheses that changes in the chemical regime of overlying soil may be reflected in the lateral chemical distribution of an ice-wedge. The 1-m section, nearly perpendicular to the axis of wedge I, showed only minor fluctuations in conductance. Similarly, lateral sections at right angles through wedge III showed no trend with an assumed unidirectional growth. Without further detailed sampling, it is not possible to relate chemical regime of the ice-wedges to the changing chemical regime of the surface soil, a process implied by Manil [19].

Stratigraphy

It should be emphasized that the site location represents a topographic high and was selected to avoid the lithologic discontinuities associated with the reworked sediments of the thaw-lake cycle [4, 9, 11]. Based upon moisture and density values of the sediments overlying wedge III ([9] hole 34 and unpublished data of O'Sullivan & Brown), approximately 40% settlement would occur if the perennially frozen overburden thawed to the present surface of wedge III. Assuming that the top three meters of the sample site (Fig. 1) are composed of 50% massive ground ice, a uniform settlement of the polygon complex could conceivably result in an overburden of approximately 1 m.

The following tentative sequence of events, (partially the result of discussions between John B. O'Sullivan and the author), is postulated to explain the stratigraphic record of the site:

1. Formation of wedge III under a predominantly organic surface.
2. Thaw of frozen ground and truncation of wedge III to its present position.
3. Freeze back of the saturated overburden with a resulting increase in ground volume during a colder period.
4. Growth of wedges I and II with deposition of approximately 0.4 m of mineral soil by cryopedologic processes [5] or sedimentary processes over wedge II. Wedge II probably became inactive shortly after this surface deposition.

The radiocarbon dates of the peats cannot be used to correlate the above sequence with an absolute time scale, since the individual date represents a composite or average age of the peaty material and does not in any way disclose the time or circumstances of its burial. However, lack of alder pollen in these two older peats suggests that they were buried prior to the alder maximum or hypsithermal interval [5, 20, 21] and that the higher-alder peat was associated with more recent

cryopedologic processes. This youngest peat (1775 ± 120 years), if assumed correlative with ice-wedge growth [10], places the formation of wedge I within the estimate of 2500 years made by Black [3] for a nearby high-centered polygon site.

Organic residues from wedge III contained pale green to yellowish fragments of mosses, partially decomposed leaves, and lemming pellets, indicative of a polygon-trough environment. The residues were recovered from blocks of ice containing approximately ten vertical increments each. The average ages of approximately 8200 and 14,000 years may be reasonably reliable dates for the growth of those particular portions of the wedge.

The three radiocarbon dates of buried peat bear a similarity to those presented by Hopkins et al. [22] for the Nome area. There, a deep thawing of perennially frozen ground occurred about 10,000 years ago. Assuming that truncation of wedge III postdated the emplacement of the 8200 and 14,000-year residues and that truncation was caused by deep thawing, the deep thaws at Nome and Barrow do not correlate. Rather, the proposed deep thaw at Barrow would more likely correlate with the hypsithermal interval as suggested for the North Slope [20, 21]. However, reliability of the residue dates requires further substantiation through additional sampling. Correlation of this importance should not depend on such limited sampling.

ACKNOWLEDGMENTS

This investigation was conducted under Project 3.3B, Frozen Ground Investigations, Barrow, Alaska, U.S. Army CRREL, Hanover, N. H. Appreciation is extended to Robert Lewellen, Paul Sellmann, and Gerald McEnroe, USA CRREL, for their assistance in the laboratory and field; to John B. O'Sullivan for his cooperation in the joint 1962 field program and subsequent discussions and exchange of data; to Paul A. Colinvaux for pollen analyses, and finally, to Office of Naval Research and Arctic Research Laboratory for its logistical support at Barrow, Alaska.

REFERENCES

- [1] T. L. Péwé. "Ice-Wedges in Alaska: Classification, Distribution, and Climatic Significance," in this volume.
- [2] R. F. Black. "Growth of Ice-wedge Polygons in Permafrost near Barrow, Alaska," *abst., Geol. Soc. Am. Bull.*, Vol. 63, 1952, pp. 1235-1236.
- [3] R. F. Black. "Ice-Wedges and Permafrost of the Arctic Coastal Plain of Alaska," Unpub. ms., 1954.
- [4] M. E. Britton. "Vegetation of the Arctic Tundra," *Arctic Biol.*, Oregon State Coll., Corvallis, 1957, pp. 26-61.
- [5] L. A. Douglas, J. C. F. Tedrow. "Tundra Soils of Arctic Alaska," *7th Intl. Soil Sci. Cong. Trans.*, Vol. 4, 1960, pp. 291-304.
- [6] A. H. Lachenbruch. "Mechanics of Thermal Contraction Cracks and Ice-Wedge Polygons in Permafrost," *Geol. Soc. Am. Spec. Paper* 70, 1962.
- [7] E. de K. Leffingwell. "The Canning River Region, Northern Alaska," *U.S. Geol. Survey Prof. Paper* 109, 1919.
- [8] J. B. O'Sullivan. "Quaternary Geology of the Arctic Coastal Plain, Northern Alaska," Ph.D. thesis, Iowa State Univ., 1961.
- [9] J. B. O'Sullivan. "Geochemistry of Permafrost, Barrow, Alaska," in this volume.
- [10] T. L. Péwé, R. E. Church. "Age of the Spit at Barrow, Alaska," *Geol. Soc. Am. Bull.*, Vol. 73, 1962, pp. 1287-1292.
- [11] P. V. Sellmann, Jerry Brown. "Near-surface Lithology of the Barrow, Alaska Area. A Preliminary Report," *abst. AAAS, Alaska Div.*, Anchorage, Alaska, August, 1963.
- [12] Paul A. Colinvaux, The Queen's University, Belfast, N. Ireland, 1963, priv. comm.
- [13] A. E. Corte. "Relationship Between Four Ground Patterns, Structure of the Active Layer, and Type and Distribution of Ice in the Permafrost," *U.S. Army CRREL Res. Rept.* 88, 1962.
- [14] P. A. Shumskiy. "Ground Ice," *Osnovy geokriologii*

- (*merzlotovedeni*), Chap. 9, Pt. 1, 1959, pp. 274-327, (English transl.).
- [15] Eville Gorham. "The Salt Content of Some Ice Samples from Nordaustlandet (North East Land), Svalbard," *J. Glaciol.*, Vol. 3, 1958, pp. 181-186.
- [16] W. L. Boyd, J. W. Boyd. "Water Supply Problems at Point Barrow," *J. Am. Water Works Assoc.*, Vol. 51, 1959, pp. 890-896.
- [17] Jerry Brown, C. L. Grant, F. C. Ugolini, J. C. F. Tedrow. "Mineral Composition of Some Drainage Waters from Arctic Alaska," *J. Geophys. Res.*, Vol. 67, 1962, pp. 2447-2453.
- [18] U.S. Geol. Survey (Unpublished records and subject to revision), Sample Numbers: 882, 896, 897, 898, 1776, 1777,

- Palmer, Alaska.
- [19] G. Manil. "Observations on the Filling of Fissures with Ice," *Biuletyn Peryglacjalny No. 9*, 1960, pp. 127-134 (Text in French).
- [20] D. A. Livingstone. "Pollen Analysis of a Valley Fill near Umiat, Alaska," *Am. J. Sci.*, Vol. 255, 1957, pp. 254-260.
- [21] S. C. Porter. "Late Pleistocene Glacial Chronology of Northcentral Brooks Range, Alaska," *Am. J. Sci.*, (in press).
- [22] D. M. Hopkins, F. S. MacNeil, E. B. Leopold. "The Coastal Plain at Nome, Alaska: A Late Cenozoic Type Section for the Bering Strait Region," *21st Intl. Geol. Cong.*, Copenhagen, Pt. 4, Sec. 4, Proc., 1960, pp. 46-57.

PERMAFROST OF EURASIA

I. J. BARANOV, Obnuchev Permafrost Research Institute, Moscow
V. A. KUDRYAVTSEV, Moscow State University

The configuration of the permafrost region is determined by the high latitudinal position (North European part of the USSR); high latitudinal position, increased continental nature, and elevation (Siberia), and the elevation of the locality (Central Asia).

PERMAFROST ZONES

According to the differences in the conditions of development of perennially frozen strata, the permafrost region can be divided into latitudinal geocryological zones which differ in features of occurrence, distribution, capacity, structure, and temperature of the permafrost and also the type and nature of the distribution of accompanying cryogenous physico-geological formations. In the USSR, division of the permafrost region into the following geocryological zones has been adopted:

Zone I Insular distribution of permafrost, complicated by its large mass, tied to the southern mountain systems. In boundaries of this zone the thickness of frozen strata varies up to 50 m, with localities exceeding 200 m. Temperature of the rocks is as low as -1.0°C . This zone occupies about 25% of the total area of the permafrost region.

Zone II Large mass distribution of permafrost. Thickness of the frozen strata reaches 200 m. Temperature of the rocks is as low as -3.0°C . This zone is about 15% of the permafrost area.

Zone III Continuous distribution of permafrost with infrequent thawed rocks. Thickness of the frozen strata reaches 300 m. Temperature of the rocks is as low as -5.0°C . This zone is 20% of the permafrost area.

Zone IV Geographically continuous distribution of permafrost. Thickness of the frozen strata reaches 700 m, and temperature of the rocks is as low as -10.0°C . This zone is about 40% of the permafrost area.

Distribution, thickness, and temperature of permafrost conform in complexity to the diversity of natural conditions (relief, geological structure, composition of rocks, occurrence and circulation of underground water, etc.); therefore, the geocryological characteristics cited above are average ones.

The difference in the composition of mountain rocks, the genesis of frozen strata, and their cryogenous structure are determined by the composition, age, and genesis of the rocks and conditions of cooling.

Epigenetic frozen strata are distributed within boundaries of territories that are complicated by rocks older than the Quaternary period. The polygenetic strata are tied only to lower forms of the topography, in whose boundaries occurred a synchronous process of accumulation and freezing of porous deposits. Within the boundaries of the young alluvial plains, polygenetic frozen strata dominate; these are characterized by particularly great ice formations, specified, in general, by

the presence of enormous polygonal systems of ice-wedges. For southern zones, thawing of ice-wedges is characteristic; in central zones the wedges are buried, and there is some development of epigenetic ice-wedges; in southern zones the formation of syngenetic wedges under bottom-land conditions and epigenetic wedges for the older forms of accumulative topography are characteristic.

The processes of seasonal heaving are characteristic of zones I and II and generally in mountain regions within their boundaries. To the north these processes weaken as the depth of seasonal thawing of soils diminishes.

Thermokarst processes due to the thawing of epigenetic ice-wedges occur in the limits of zones II and III; they are practically nonexistent in zone I. In northern regions thermokarst effects are associated with syngenetic ice-wedges. Solifluction effects and the formation of polygonal cryogenous structures are developed primarily in zones III and IV. Ice formation is most typical of the folded-mountain regions.

The greatest dynamism of frozen strata is characteristic of zones I and II where it is associated not only with the change in the temperature regime of frozen strata but also with their thawing and new formation.

In zones III and IV the dynamics of frozen strata is reduced, in general, to changes in temperature regime based on the destruction of natural conditions.

The first scientific boundary of permafrost in the USSR was established by the founder of permafrostology in the USSR, M. I. Sumgin, in 1927 [1] and more precisely in 1937. Later, this boundary underwent further corrections by V. P. Tumel (1945), V. A. Kudryavtsev (1949), and I. J. Baranov (1952).

At present, the southern boundary of permafrost in the USSR occurs as follows: In the far northwest of the country, permafrost occurs on the Kolsky Peninsula, covering its northern part. Farther to the east, the southern permafrost boundary begins at the base of the Kanin Peninsula and extends almost in a latitudinal direction to the western slope of the Urals, passing approximately through the settlement of Ust-Vorkuta. At an elevation of 1000 to 1200 m in the Urals, this boundary goes southward almost to 60° N lat. On the West Siberian plain, the permafrost southern boundary passes almost along 62° N lat. Near Turukhansk it crosses the Yenisei River and descends steeply southward along the valley of this river with some deviation to the east.

In the south, permafrost occurs in the high mountainous regions of the Saians and the Altai. Farther to the east, this boundary moves from the USSR to China and Mongolia; only in the Far East near Shimanovskaya railway station does it again enter the territory of the USSR and then continue along the Amur River bank to its estuary. East of the lower Amur, isolated permafrost areas occur in the Sikhota-Alin mountains and in Sakhalin. In Kamchatka, permafrost occupies the northern part and descends southward in the shape of a tongue

to the central part of the peninsula on high elevations of the middle range.

Permafrost area in the USSR occupies about 10.7 million sq km, or 47.5% of its territory. One must remember that at present the southern boundary of permafrost is not considered to be a line separating the territory of permafrost from that of nonfrozen rocks. The permafrost southern boundary is understood to be a broad zone of mutual transition and penetration of these two provinces. The middle of this zone may be considered as the axis of perennial oscillations of the permafrost southern boundary. Usually this middle line is assumed to be the southern permafrost boundary for a given interval of time, but the actual boundary oscillates and moves periodically northward and southward during a particular interval of time. This definition of the permafrost southern boundary includes both the area of continuous permafrost and the isolated areas of permafrost. Not included in this definition are the small thin permafrost "islands" which periodically arise and disappear and are atypical, but are explained by local geographic and geologic conditions.

Both the formation of permafrost islands south of the permafrost southern boundary and formation of unfrozen areas within the continuous permafrost territory are possible.

These oscillations of the permafrost southern boundary result in permanent changes of the permafrost area, but during short intervals of time the magnitude of these changes is comparatively small. Calculations show that the permafrost area, in spite of continuous changes, remains relatively near its average value for a given interval of time and alters not more than 120,000 sq km, or 1.1% of the whole area per year.

The permafrost area in the USSR is usually subdivided into five permafrost-temperature zones: (1) from 0° to -1°C; (2) from -1° to -3°C; (3) from -3° to -5°C; (4) from -5° to -10°C; (5) lower than -10°C. Since the area of the fifth zone is not great and its boundaries are not sufficiently established, zones 4 and 5 are considered together in this report. The first temperature zone occupies about 20% of the whole permafrost area; the second, 15%; the third, 25%; the fourth and fifth, 40%.

The characteristic feature of the first temperature zone is that it forms the peripheral part of the permafrost territory. Here the mean annual temperature of the rocks in the depth of zero annual amplitude keeps usually between 0° and -1°C; therefore, minor changes of geologic and geographic conditions are sufficient to turn this temperature into a positive one, which results in partial thawing of the permafrost.

It is natural that within this zone permafrost occurs sporadically, as separate permafrost islands. The quantity of these islands, their dimensions and the ratio of their area to that of the surrounding unfrozen rocks, increase northward from the 0°C geoisotherm to the -1°C geoisotherm. Thin and small permafrost islands in the south of this zone, having a temperature near 0°C, gradually pass into islands of thicker and more stable permafrost in the north at the -1°C geoisotherm. The first zone represents the northern part of the transition zone where the permafrost region passes into that of seasonal frost.

In the first zone the processes, depending on the microalterations of geologic-geographic conditions, are of considerable importance. Such processes are usually local and are observed in small areas. On colder and thicker permafrost layers in the far north such processes result in some change in the temperature regime of the permafrost upper layer and without disturbing its continuity, but in the first zone they frequently produce the entire thawing of the permafrost.

All azonal permafrost-temperature regions, including large and medium river valleys, regions of volcanic activity, and settled areas within the first zone often have no permafrost, but its development here is possible with favorable conditions. In the first temperature zone, the thickness of permafrost layers ranges from 0 m to 50-80 m, with a maximum of 100-120 m. In this zone the permafrost beds are usually of Holocene age. Permafrost in the southern part of this zone arose after the thermal maximum. There is a possibility of

discovering relic permafrost beds at some depth.

In the second zone the interval of the temperature change is twice as great as in the first zone (from -1° to -3°C). It is essential that the upper temperature limit here is not the limit temperature of permafrost existence, -0°C, but -1°C, which secures a certain reserve of permafrost stability. Insignificant changes of geologic and geographic conditions, resulting in a 1° temperature increase, do not stop permafrost development but only bring it to the critical temperature.

In the second zone, only considerable influences of geologic and geographic factors may sometimes bring about thawing of permafrost. The temperature, -3°C, is not sufficiently low to save the permafrost from thawing entirely or from the warming influence of some factors.

These considerations lead to conclusions about the character of permafrost in the second zone. The permafrost here is not sporadic but is represented by small areas separated by unfrozen zones on taliks. In the first zone we cannot state any principal difference between its southern and northern parts (near geoisotherms of -0° and -1°C), since the whole zone is characterized by the island form of permafrost; in the second zone its northern and southern parts must be distinguished as subzones.

In the southern subzone, temperature between -1° and -2°C, elements of the first zone are rather frequent, while between the geoisotherms -2° and -3°C permafrost islands are rare, permafrost massifs, separated by unfrozen stripes, are dominant. Even almost continuous permafrost with separate taliks occurs in mountainous regions.

Thus, if the alternation of seasonally frozen ground and permafrost is typical of the first zone, permafrost is typical of the second zone and particularly for its northern part, where the seasonally frozen ground is associated with the areas of perennial taliks and the layer of seasonal thawing predominates over the layer of seasonal freezing. Permafrost thickness in the second zone usually changes from 30-50 m to 150-200 m and more—the relics of more ancient permafrost layers of greater thickness being usual here.

The temperature range from -3° to -5°C in the third zone differs considerably from the critical temperature for the existence of permafrost; therefore, the taliks develop here only under the influence of strong factors. Permafrost in the third zone is chiefly continuous. Taliks are usually due to hydrogeological factors. Surface and underground waters are able to neutralize conditions facilitating permafrost development, the stability of which is increased by its great thickness reaching and even exceeding 250-300 m. Permafrost of such thickness can disappear only under the influence of a constant factor producing a total thermal effect raising the temperature by more than 5°C.

All the local geologic-geographic changes resulting in a small rise of temperature cannot cause complete thawing to create taliks; such changes can produce only incomplete thawing or pseudo-taliks. To form a pseudo-talik in permafrost having a temperature of about -5°C, a change of geologic-geographic conditions securing a rise to 7° to 8°C is necessary. Therefore, they occur in the valleys of big rivers with large alluvial streams, as well as near outlets of thermal springs, usually along tectonic fractures.

Permafrost occurrence in the third zone is relatively constant and stable, and pseudo-taliks are more typical of it than for zone II. The range of temperature variations in the third zone is much greater than in the previous zones. While in the first and second zones relatively small temperature changes produce local taliks, in the third zone a temperature rise of 3° to 5°C does not disturb the permafrost continuity. Therefore, this zone is the region of great temperature changes and is, according to V. F. Tumel's expression—"the zone of sharp temperature contrasts." Permafrost thickness in this zone changes from 100 to 150 m to 250 to 300 m.

The fourth and fifth zones differ from the previous three zones by a very low temperature (lower than -5°C). The minimum temperature in the fifth zone is -13.6°C on Oimyakon plateau at Yakutia, in the region of the Cold Pole. Calcula-

tions show that this peculiar pole of permafrost cold is located within the Chersky Range, where at absolute elevations of 3000 to 3200 m the permafrost temperature at the depth of the zero annual amplitude is about -17° to -21° C.

Permafrost in the fourth and fifth zones is very stable and continuous. Through-taliks here are almost absent, except in small areas where the influence of surface and ground water is great. Through-taliks occur near the outlets of thermal springs under big rivers and deep and broad lakes. Pseudo-taliks are possible under small rivers and lakes. Within these zones the permafrost thickness reaches 600 to 800 m.

Peculiar changes of permafrost layers in connection with big river bed movements are usual in these zones. Side displacement of the river bed results in the thawing of the permafrost upper layer. When the speed of the river bed displacement is great, the permafrost under it has no time to thaw entirely because of the great thermal inertia of deep permafrost beds. During the spit, shoal formation, and reverse river displacements the permafrost rises again and undergoes a very complicated course of development. Thus, it may occur under deep parts of the river bed and be absent under shallow ones. When permafrost is investigated in the lower part of a big Siberian river, it is necessary to take into account the history of the river valley and to consider the permafrost temperature conditions only in this connection. Thermal inertia of permafrost layers 500 to 800 m thick is reckoned to reach thousands and tens of thousands of years; therefore, the history of a river valley must be considered for the same interval of time.

STRUCTURE OF PERMAFROST LAYERS

The cryogenous structure of permafrost in the USSR is heterogeneous, depending on many factors and conditions (lithologic and granulometric composition, interconnection of lithogenesis and freezing processes, the rate of freezing, properties of the strata, etc.). Each factor and condition is essential and important.

With respect to the processes of rock formation the permafrost may be metachronous, synchronous, and polychronous. In the first case, epigenetic permafrost layers are formed; in the second, syngenetic permafrost beds, and in the third, polygenetic permafrost layers of mixed genesis. Each of these permafrost genetic types is established according to its cryolithologic features or by correlation of time and conditions of rock genesis with the time of its perennial freezing.

Epigenetic Type of Permafrost

This type occurs in the whole permafrost area and is fundamental. Permafrost layers of this type were formed during the whole of the cooling epoch from rocks of different composition, properties, and age. These layers have heterogeneous cryogenous structure. Fundamental features of epigenetic permafrost layers are determined by the specific conditions of their origin. Their chief cryogenous feature is connected with the fact that in the beginning of perennial freezing the rocks were already in existence, and their freezing was directed downward—the layer of seasonal temperature oscillations being somewhat stable. The perennial freezing did not bring any special features to lithogenesis; the seasonal freezing somewhat influenced only the lithogenesis of separate modifications of disintegrated deposits.

Perennial freezing in connection with crystallization of mobile water affected some rock properties through the development of hidden cracking, widening of open fissures, aggregation of fine grained particles, etc.

In homogeneous deposits a regular change of cryogenous structure from the surface downward is observed to the depth of the primary position of the annual temperature variation layer. Upper permafrost layers display macrostructural secondary elements (ice-wedges) superimposed on the primary structure (lamellar, cellular, etc.).

Stratification with breaks is produced by a definite succes-

sion in the ice-lens development. Distance between lenses increases with depth. The same is observed below the seasonal temperature variation layer, caused by specific processes and rate of freezing. In homogeneous marine deposits lamellar and polygonal structures are observed.

In heterogeneous disintegrated frozen deposits the cryogenous structure is more complicated. In the alternating sand and sandy-clay horizons, each has its own structure: The frozen sandy layers are monolithic and the sand-clay layers are laminated.

The structure of relatively dense young Tertiary and Mesozoic rocks is generally heterogeneous. The argillaceous horizons have flaky, laminated, and cellular structures; sandstones and coal are cellular, depending on the depth of their bedding. The cryogenous structure of dense rocks (sedimentary, metamorphic, and igneous) depends on the character and degree of jointing, and its distribution in area and depth; it also depends on the presence of free ground water (saturation zone), or infiltrated and condensed water (aeration zone).

In addition, these features of the epigenetic permafrost layers also have other specific qualities because the composition and properties of rocks, as well as the conditions of their freezing, may be quite different. Relic cryogenous structures can be traced in epigenetic permafrost layers which have undergone repeated freezing and thawing.

Epigenetic permafrost is always included as a part of the polygenetic permafrost forming its basal lower part. In isolated regions where brine occurs, the zone of cooling has one or two horizons of permafrost and a zone of low-temperature unfrozen rock.

Syngenetic Type of Permafrost

Only the upper horizons of the permafrost are formed syngenetically (if there were no marine transgressions or thermokarst and other lakes). A syngenetic horizon develops with synchronous deposition and freezing of sediments accumulated as the result of erosive, diluvial, abrasive, glacial, and other processes. Therefore, the age of syngenetic permafrost horizons is not older than Quaternary. This is the chief difference between syngenetic and epigenetic types of permafrost. A syngenetic horizon is a necessary element of a polygenetic permafrost layer; it is usually formed either simultaneously with development of the epigenetic part or afterward and above it.

The syngenetic horizon develops by the periodic deposition of sediments and growth of the layer upward, (differently from the development of an epigenetic layer). In addition, the freezing of sediments successively included into the permafrost layer develops in two directions because of the transfer of heat into the frozen layer (northern and partially southern regions) or because of the transfer of heat through the soil surfaces as in the epigenetic type (southern regions). This results in a completely different cryogenous structural development in these strata. The variety of lithological composition, the properties of sediments and conditions of their deposition, result in different textural-genetic features of these permafrost layers.

Proper textural-genetic features of syngenetic horizons are: Interlayers in the form of extensive sheets (northern alluvial modifications); ice-lenses, impregnations, and scales (southern modifications); big lenses and blocks of buried and injected ice (mountainous regions).

Southern and northern modifications of syngenetic permafrost layers, formed in similar geologic and geomorphologic conditions, have a different cryogenous structure because of different texturally-genetic ice inclusions and particularly because of ice-wedges. Syngenetic horizons occur less frequently than epigenetic ones. They reach the greatest thickness and continuity in the northern alluvial plains.

Polygenetic Permafrost Type

The frozen layers of this type develop from both epigenetic and syngenetic horizons. Polygenetic permafrost layers

develop according to different thermodynamic conditions; in the same way their elements are subdivided into northern and southern modifications. Their development is beyond the scope of this report. Polygenetic permafrost occurs with syngenetic less frequently than with epigenetic layers, but both occur in plains and in mountainous regions.

SECONDARY PHENOMENA

Seasonal freezing and permafrost layers are the two main types of cryogenous formations, having different composition and cryogenous structure. There are other, very different types that accompany, and are partially due to, the existence of permafrost layers. Such types develop under the same thermodynamic conditions as the permafrost layers. They create secondary elements of the permafrost cryogenous structure or a special group of forms, which affect the processes of freezing and thawing and the development of primary cryogenous structures during repeated freezing.

Such accessory cryogenous forms develop in layers of seasonal freezing and thawing and in the upper horizons of the permafrost layer which formerly were subjected to seasonal variations of temperature.

Cryogenous phenomena have specific zonal, regional, and local features; also, type and species differences. Occurrence of these phenomena depends on the variation of natural conditions, particularly on climate, topography and the stages of its development, composition, texture, structure and properties of disintegrated deposits, etc. The periods and stages of their development are different and depend on natural conditions.

The most frequent types of cryogenous phenomena include frost fissures. These precede the development of many secondary elements of permafrost structure and cause many other types of cryogenous phenomena in the layers of seasonal freezing and thawing, which in their turn are predecessors of postcryogenous forms. Frost cracking takes place when horizontal contraction and tension develops in freezing rock and results in fractures of the frozen layer and of underlying unfrozen layers.

In fissures primary elements of cryogenous structure are formed—blind ice-wedges and lenses. In fissures reaching the surface, secondary elements of cryogenous structure are formed—ice or ice-soil-wedges (special structural formations). Ice-wedges in their initial stages are always epigenetic with the permafrost layers. In one case, in northern regions with a severe climate on alluvial plains and in river valleys, ice-wedges develop concurrently with syngenetic permafrost. In the other case, in the north and middle regions of the permafrost area, ice-wedges are always synchronous—but are asynchronous with epigenetic permafrost layers.

In southern permafrost regions, ice-wedges are formed either under the above conditions, or they are relics. In northern regions, epigenetic wedges are formed on syngenetic ones within the boundaries of polygenetic frozen layers, or where epigenetic layers form in taliks under thermokarst depressions. The micropolygonal systems of frost, or frost-contraction fissures, result in the appearance of systems of polygonal blocks, which affect conditions of heat and moisture exchange in the layer of seasonal freezing and thawing. The presence of fissures and blocks causes development of several kinds of cryogenous phenomena. The most frequent are: Spot-medallions, stone polygons and stripes, small-mounds, and parallel beds, etc.

Spot-medallions, (fine-centered sorted rings covered by peat), are usually formed on top or in the boundaries of micropolygonal blocks. The motion of water-saturated soil and its frost sorting play a large part in their development. Spots are typical for the northern plains and mountain tundra.

Small mounds represent an independent topographic form. They also develop on a base of micropolygonal blocks and cause an evolutionary change in the areas between spot-medallions (transformation of closed soil systems into semi-closed ones) because of changes in the seasonal freezing conditions. The first modification by small mounds occurs

everywhere. The second one accompanies spot-medallions in the zone of diminished activity (the southern tundra).

Stone polygons and stripes are typical of stony plains, high mountain river valleys, and the zone of mountain tundra. They are produced by frost sorting of gravel and pebbles containing argillaceous soils in conditions of frost cracking.

The parallel-steps pattern is usual in the zone of mountainous tundra and in mountainous regions. This relief is caused by many processes developing on a base of the micropolygonal cracking of soils: Formation of spots, frost sorting of soils, and solifluction.

A separate group of surface cryogenous phenomena is represented by seasonal and perennial icings of surface streams and ground water. The icings occur frequently in continental regions; in the zones of oceanic influence they are less frequent because of the lowland character of rivers and thick snow cover. Perennial icing is observed in northern mountainous regions and in high mountain regions in the southern part of the permafrost territory and also beyond its boundaries.

Seasonal and perennial frost-heaving mounds represent an independent cryogenous phenomenon, though such a classification is somewhat conventional. Frost-heaving mounds, as well as any cryogenous heaving, arise as the result of seasonal and perennial freezing, accompanied by development of a cryogenous structure. The lenses of segregation and injection ice represent primary textural-genetic forms, arising either in specific conditions of repeated water supply and its migration to the freezing surface, or in conditions of hydrodynamic water pressure in a closed freezing talik.

Interlayer ice-lenses in frozen layers at different depths are analogous to the mound forms. Mounds with a water supply from outside are most developed in the mountainous continental regions where ground water flow is continuous. These mounds occur locally, usually in the southern permafrost territory. Mound formations (heaving areas) that develop because of differentiation of the soil mass are most frequent on the plains (chiefly in regions of oceanic influence). The mounds are connected with peat-bog deposits and—in continental regions—with the freezing of taliks under thermokarst depressions.

Postcryogenous formations develop during seasonal and perennial thawing of disintegrated deposits. The preceding cryogenous phenomena are a kind that promote the growth of postcryogenous forms. The main postcryogenous phenomena include thermokarst depressions (subsidence) of disintegrated deposits connected with the soil densification—due to thawing of big ice masses or accumulations of segregated ice, solifluction, and slides on slopes.

Thermokarst forms, from thawing of polygonal ice-wedges, occur zonally; they include local systems of depressions and polygonal systems of mounds. They occur in the whole permafrost territory and beyond its boundaries, but very irregularly. Thermokarst forms, developed on the base of local frost-heaving, occur chiefly in the mountainous continental regions of the southern and middle permafrost region.

Evolution of upper permafrost layers (caused by thawing of structural ice) results in several kinds of postcryogenous phenomena: Soil-wedges, pseudomorphs on ice-wedges, and relic polygonal mound topography of the "baijarkh" type (hillocks of uniform height and regular arrangement that occur around thermokarst lakes).

Soil-wedges are formed in place of relatively small ice-wedges by soil displacement of ice inclusions with further dissection of the soil-wedges by seasonal ice veins (in southern permafrost areas).

The pseudomorphs on ice-wedges are formed by ice thawing and further replacement by fluid and sliding soil. Subaqueous ice thawing produces the enveloping soil textures in the upper parts of pseudomorphs.

Relic polygonal (baijarkh) topography in the north is formed in areas of thick syngenetic permafrost layers including big ice-wedges. These forms are associated with slope edges and are due to ice thawing and preservation of polygonal block remnants.

Solifluction forms display certain latitudinal zonality in the northern regions; their elevation is typical of all the mountainous regions. They are most active in regions of oceanic influence because their development depends on soil moisture conditions and on processes that precede cryogenous structure

development and soil seasonal thawing.

REFERENCE

[1] M. I. Sumgin. "Permafrost Within the Boundaries of the USSR," Acad. Sci. USSR, Moscow, 1927.

POLYGONAL SYSTEMS OF ICE-WEDGES AND CONDITIONS OF THEIR DEVELOPMENT

B. N. DOSTOVALOV AND A. I. POPOV, Moscow State University

Polygonal ice-wedges occur in argillaceous rocks and peats in the Arctic and sub-Arctic. They sometimes constitute more than 50% of the upper 30 m of rock. They often lend specific features to landscape and display a complicated texture and shape, which reveal physical, mechanical, thermal and surrounding conditions, and history of their formation.

Large masses of underground ice have been considered in literature from different points of view for more than a century, beginning with A. E. Figurin (1823). However, the processes of their development remained vague and open to discussion until 1949-1950. During these and later years it was proved that the dominant part of underground ice masses is represented by polygonal systems of ice-wedges, formed basically by repeated frost cracking and cementation of fissures with ice [1, 2, 3].

ICE-WEDGE MORPHOLOGY AND OCCURRENCE

The chief masses of underground ice occur on alluvial plains composed of silt-peat river and lake sediments. Ice-wedges usually have a wedge-like cross section and are characterized by a vertically striped ice structure. The ice-wedges reach their greatest thickness and vertical dimensions on ancient alluvial surfaces, but they also occur on contemporary flood plains and low terraces. Ice-wedges join at right angles and form polygonal, chiefly tetragonal, nets of patterned ground that cover great areas in valleys of the northern rivers.

LAWS OF TEMPERATURE CRACKING AND ICE-WEDGE CYCLE

B. N. Dostovalov determined approximately the temperature stresses in a solid body defined by horizontal and vertical surfaces and cooled from above. This breaking stress (τ_B) is given by

$$\tau_B = 1/2 \alpha G x (\Delta t / \Delta z) \quad (1)$$

where G is shear modulus; α is coefficient of thermal expansion (contraction); x is distance from the free vertical surface to the fissure parallel to it; and $\Delta t / \Delta z$ is vertical temperature gradient. Equation (1) leads to the following conclusions:

1. The free vertical surface predetermines the direction in which fissures form, and the homogeneous solid under this condition is broken by a system of parallel fissures into a system of parallel stripes.

2. Since the temperature gradient vector is perpendicular to isothermal surfaces and the latter are parallel to the free horizontal and vertical surfaces of the massif, the system of stripes made by the system of parallel fissures is broken by cross fissures, perpendicular to the former ones, into a system of rectangular prisms.

3. Breaking stress (τ_B) is proportional to the product of linear dimension and temperature gradient; therefore, at small gradients the rock mass breaks into large rectangles and then, when the gradients increase, these rectangles are successively broken by fissures of consecutive orders into smaller and smaller bodies (Fig. 1).

4. When fissures join to form a base and a perpendicular, the base is formed earlier by a longer fissure of lower order—and the perpendicular, by a shorter fissure of higher order—cracking.

5. In heterogeneous frozen rocks with varying α and G ,

fissures must be curved and nonparallel to each other but the perpendicularity of their conjunction holds.

6. Lithologically different rocks with different physical and mechanical characteristics α and G must be broken by fissures into systems of bodies of different dimensions.

7. Besides two systems of mutually perpendicular vertical fissures separating rectangular prisms, the latter must be broken by horizontal fissures into a system of rhomboidal bodies.

Since ice-wedges grow in permafrost only when the latter cracks and is cemented by ice, it is possible to state the following necessary conditions: (a) Temperature fissures must penetrate into permafrost. (b) Filling and cementation of fissures by ice must be possible. (c) Frost cracking and cementation of rock by ice must recur periodically in the same places. (d) The rock must be a sufficiently large solid mass. (e) Processes of thawing must not be stronger than the processes of freezing. In the absence of even one of these conditions, underground ice-wedges do not develop.

Frost cracking begins for the first time in winter on the areas just exposed following regression of ponded water and thereafter repeats periodically. In spring and summer a layer of sediments is deposited on the polygons defined by the fissures. During the summer temperature rise in the layer affected by seasonal variations, the soil expands and winter tension is replaced by summer compression. At the beginning of the next winter freezing, the layer of summer thawing also becomes a continuous massif, and after sufficient decrease in temperature, the layer contracts and cracks again.

A single cracking and filling of fissures by ice constitutes an elementary cycle of ice-wedge development, the latter being the sum of periodically formed elementary veins.

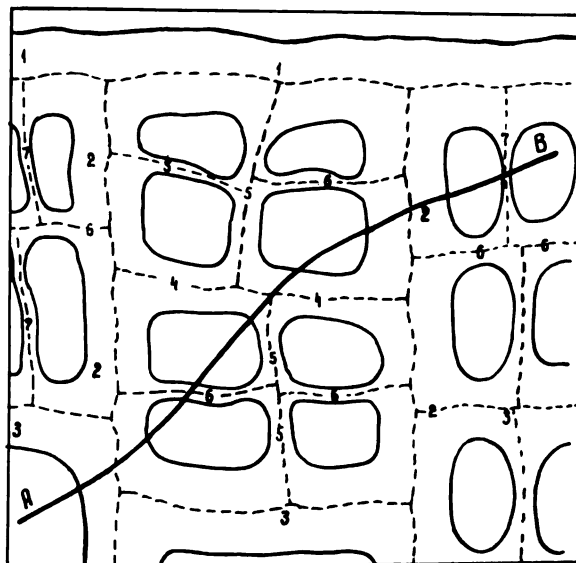

Fig. 1. Diagram shows successive frozen soil frost cracks and difference in thickness of ice-wedges; order of occurrence of fissures (1 to 7) gives the ice-wedge its thickness. Section AB approximates the wedge ice exposure shown in Fig. 4

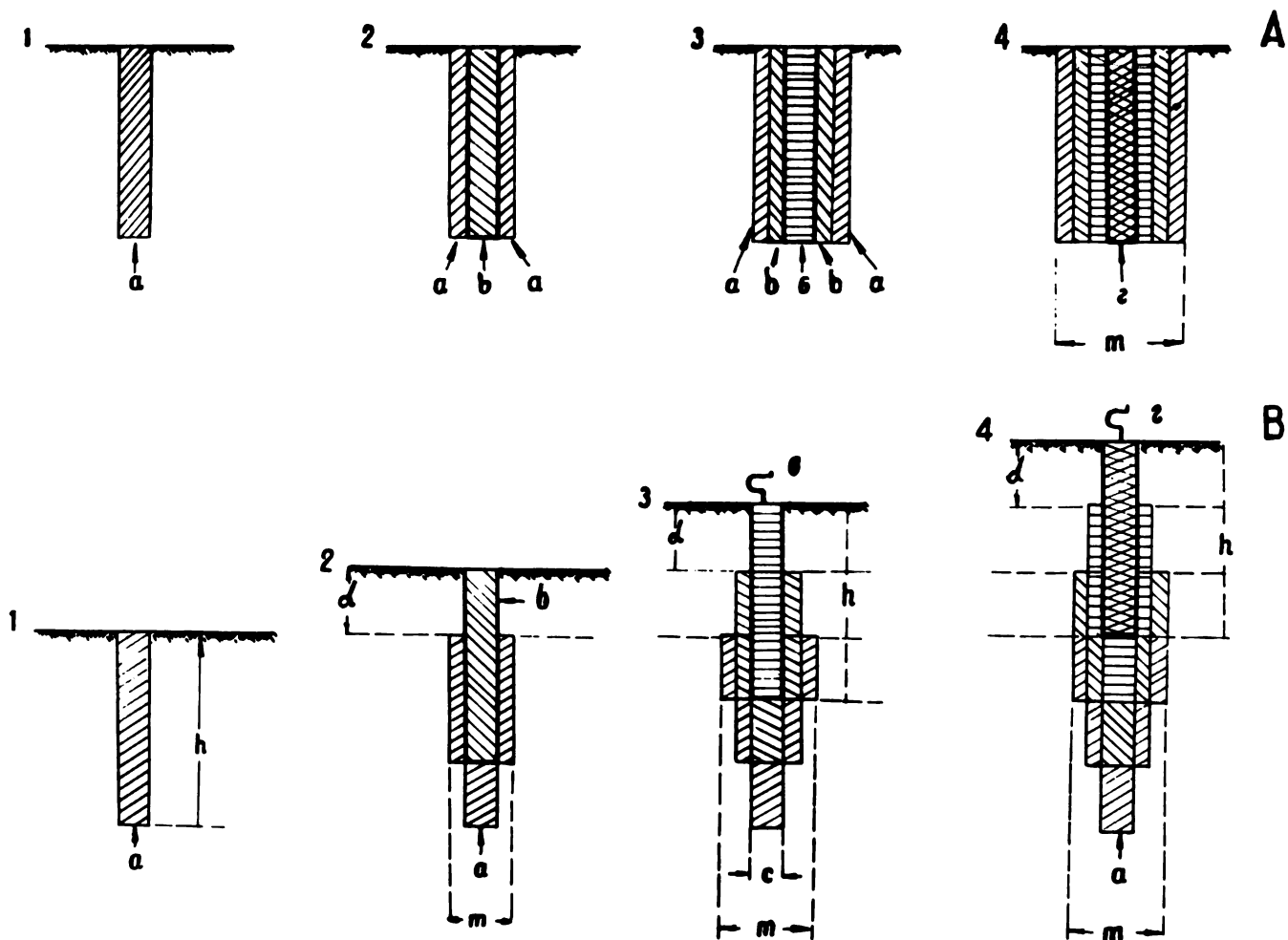

Fig. 2. Diagram of epigenetic (A) and syngenetic (B) growth of ice-wedges

It is very important that the probability of repeated cracking is smaller the higher the order of fissure generation. In relatively warm winters the temperature gradients are small, and only fissures of low orders are formed; in cold winters (with great relative temperature) minimum temperature gradients are high, and cracking reaches higher orders of fissure generation (Fig. 1). Therefore, the thickness of ice-wedges growing simultaneously, but formed by fissures of a different order of generation, must be smaller the higher the order of fissures by which they are formed (Fig. 1).

EFFECT OF SEDIMENTATION ON ICE-WEDGE DEVELOPMENT

After the first cracking of rock and cementation of fissures by ice, further growth of an ice-wedge and the shape of its cross section depend on the ratio of the depth of cracking (h), width of repeated fissures (c), and the rate of sediment accumulation (d).

Let us consider two extreme cases (Fig. 2): (A) Sediments that do not accumulate (epigenetic development), and (B) sediments that accumulate very rapidly (syngenetic development). In this scheme, for simplicity, the layer of summer thawing is not considered, and it is assumed that the cross section of the fissure is rectangular and that cracking always occurs along the central axial plane of the wedge to the same depth (h).

In case A (Fig. 2), where 1, 2, 3, and 4 are elementary veins formed during successive yearly cycles, the ice-wedge grows only in width, the latter being equal to the sum of the widths of elementary veins. Ultimately the vein becomes a broad wedge. The vertical dimension of this wedge is determined by the depth of cracking; its length depends on the

length of fissures along the surface, and its horizontal thickness (m) is equal to the sum of thicknesses of elementary veins making the ice-wedge. In case A the growing ice veins wedge the ground more and more, and the compressive stress increases. The fissures become narrower and narrower and ultimately wedge growth stops.

In case B, representing an ice-wedge growth simultaneous with rapid accumulation of sediments, Fig. 2B (1, 2, 3, and 4), shows elementary veins forming during four successive elementary cycles. In Fig. 2, \bar{h} is the mean depth of fissures; \bar{c} is mean width of fissures; \bar{d} is thickness of sediment deposited during one cycle, or the rate of sedimentation; \bar{m} is total horizontal thickness of the ice-wedge. Considering successive cycles (1, 2, 3, and 4) we see that growth in width of the ice-wedge in Fig. 2B stops after the third cycle or after h/\bar{d} cycles. This scheme also shows that the wedge grows vertically only. In cases of slower sedimentation rates, the limit of ice-wedge thickness increases and is reached after a greater number of cycles; but in all cases, if sedimentation occurs and depth of cracking is limited, growth of the ice-wedge width is also limited—this is a general law.

This law is expressed by

$$m = \frac{\bar{h}\bar{c}}{\bar{d}} \tag{2}$$

where $\bar{c} = \frac{1}{2} c$ and c is the width of fissure at the surface.

Since growth of the ice-wedge width is limited, the compressive stress developing during its growth is also limited. The elementary veins rise higher and higher as time goes on and stop increasing the compressive stress in the lower horizons.

In (2) all the involved magnitudes are assumed to be constant. In reality they change depending on the variation of surrounding conditions, but the chief conclusion is that the ice-wedge thickness (m) is inversely proportional to the sedimentation rate (d).

The elementary cycle of ice-wedge development just described does not embrace all details of this process and does not explain all the morphologic features. Thick syngenetic ice-wedges as well as the elementary vertical veins also include horizontal layers of ice. These inclusions represent elements of frontal growth, and their importance increases with the horizontal thickness of the ice-wedges.

Stresses arising and developing with cooling of frozen soils produce, in addition to vertical fissures, horizontal fissures which apparently pass between the upper surface of the ice-wedges and the overlying soils. In spring, water fills these horizontal cavities and freezes, forming lenses of ice above the ice-wedges.

Uplifted edges or "wings" of the layer which is torn asunder are fixed in a somewhat warped position. This process is repeated during a number of years until the limit deformation of soil inside the polygons is reached. This forms upward-protruding ice-wedges surrounded on the surface by small moldings enveloping the polygons. Horizontal elementary ice layers included in the ice-wedges are periodically and permanently cut by vertical fissures in which vertical elementary ice veins are formed. This latter process presses the layers of soil in polygons and results in still greater deepening of their inner downwarplings. This downwarping controls the bedding of accumulating sediments and character of the smooth curving from the polygon center to its edges.

The polygonal depressions become reservoirs of water and bogs covered by abundant bog vegetation that collect silt, detritus from flood water, and peat. This complex accumulation of sediments, more intense inside the polygons than on their edges, fills the depressions rather quickly. Therefore, the difference in elevation of polygon surfaces and their edges decreases and finally disappears.

If further sedimentation, after filling of the depressions by silt and then by peat, does not occur, vertical and lateral growth of the ice-wedges is stopped. Therefore, the normal (one-stage) section of the soil block inside four ice-wedges, whose development was stopped, is always closed with a layer of peat. If sedimentation continues, the plane surface of the polygon is covered by a layer of flood-plain silt, poor in vegetation remnants, because the conditions favoring peat accumulation have disappeared. This layer of silt undergoes the frost cracking and deformation described above, and the period of ice-wedge development including the elements of frontal growth is repeated.

The process of ice-wedge development described is observed everywhere in favorable surrounding conditions, though there are natural deviations caused by erosion, thawing, and other secondary processes.

It is sufficient that the sedimentation, during some intervals of time, lags somewhat behind the upward growth of ice-wedges and therefore delays their further development.

For the continuation of ice-wedge development it is necessary that sedimentation have time to fill the polygon depressions. The lenses of silt and peat successively and regularly alternating in the soil blocks between the ice-wedges represent the development of the whole systems in the conditions described. Therefore, ice-wedges of great dimensions can develop only in flood plains with well expressed sedimentation.

In syngenetic ice-wedge growth over a long time, composition or mechanical properties of frozen soil and the temperature conditions on the surface determining the cracking may change. The chief factors affecting development of ice-wedges are surface temperature and sedimentation.

Analysis as to how changes of these factors influence development of ice-wedges results in these conclusions:

Horizontal thickness and growth depend on the generation order of fissures by which they are formed (Figs. 1 and 3); the

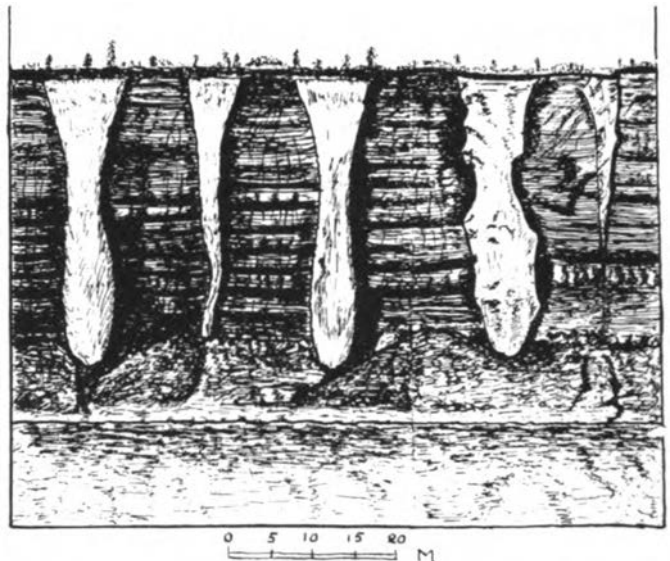

Fig. 3. Parts of ice-wedges exposed on the Yana River, approximately corresponding to the section along line AB in Fig. 1.

number of fissure orders depends on the sharpness of the minimum temperatures. Therefore, during syngenetic ice-wedge growth in a cooling climate, the net of fissures must become finer and finer due to generation of fissures of higher and higher orders, the latter being obliged to arise in more and more elevated horizons. During a warming of the climate this process reverses (Fig. 4).

Fig. 4 shows schematically the mode of syngenetic ice-wedge formation in two colder periods on a background of a comparatively moderate cold climate. Numbers on the ice-wedges indicate the order in which fissures and corresponding wedges are formed. During mild winters only fissures 1 and 2 are formed; therefore, only wedges 1 and 2 develop. When winters get colder, fissures and corresponding wedges 3 and 4 arise successively. When winters get warmer, first fissures and wedges 4 disappear; then fissures and wedges 3, and only fissures and wedges 1 and 2 continue to develop. Thus, change of temperature gradients with time explains the growth

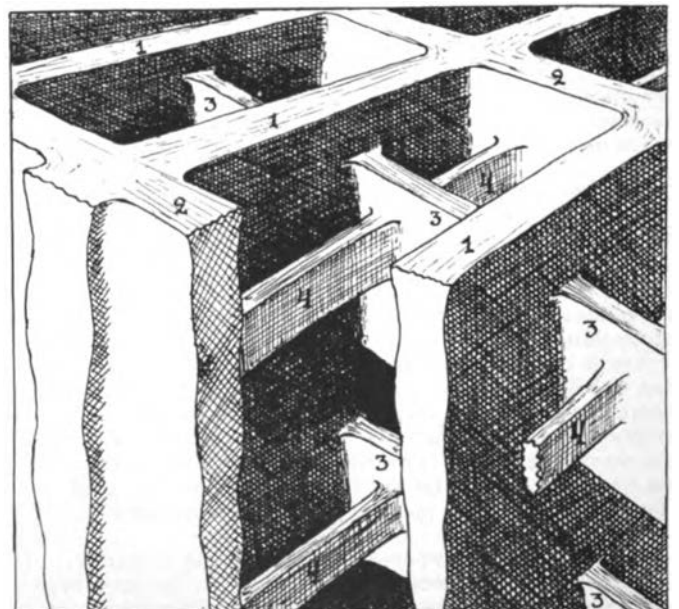

Fig. 4. Schematic growth of ice-wedges, formed in fissures of various orders (1-4) depending on periodic changes of temperature gradient

of ice-wedges in different horizons—all other conditions being equal.

The alterations in sedimentation rate change the growth of ice-wedges in width (2) and the summer compressive stresses in the cracking soil mass. When the rate of sedimentation (d) decreases, the width of the main ice-wedges, formed by fissures of the first and second orders, increases; compressive stresses in the soil mass increase and the appearance of fissures of successive orders becomes more difficult the higher their order. Cooling must first relieve and take away the compressive stresses, and only then can it create the tensile stress necessary for cracking. On the contrary, when the sedimentation rate increases, the main wedges become thinner, the compressive stress in the soil decreases, and the appearance of fissures of higher orders becomes easier. Thus, decrease of the sedimentation rate and increase of temperature gradient act upon the fissures and ice-wedge growth inversely to each other.

Relationships discussed above are applied to the exposure at Mus-Khaya on the Yana River, represented in Fig. 3 and by the succession of wedges along line AB in Fig. 1.

The swellings of the first, third, and fourth wedges (Fig. 3) in their lower parts correspond to thinner parts of the second and fifth wedges. In the middle of the section, the first, third, and fourth wedges become thinner, while the second and fifth wedges become thicker; finally, in the upper parts all five wedges grow thicker and end at the same level.

These correlations of wedge widths are explained on the basis of the above discussions as follows:

First, third, and fourth wedges in Fig. 3 were formed correspondingly by fissures of the second, fourth, and second order of generation: They were relatively main ones and their width determined the compressive stress regime in the soil mass. The second wedge was formed by fissures of the sixth order and the fifth wedge by fissures of the seventh order (Fig. 1, section AB).

During growth of the lower parts of the wedges the mean temperature gradients remained constant and the sedimentation rate decreased, causing the swelling of the main wedges and making the appearance of fissures of higher orders more difficult due to the increase of compressive stress. Therefore, swellings in the lower parts of the main wedges correspond to the thinner part of the second wedge (formed by fissures of the sixth order) and to the almost entire absence of the fifth wedge (formed by fissures of the seventh order).

During growth in the middle of the wedges, the sedimentation rate increased, the main wedges became thinner, the compressive stress became weaker, and at the same temperature gradients the possibility of cracking increased. Therefore, the middle of the second wedge, formed by fissures of the sixth order, became thicker; and growth and thickening of the fifth wedge, formed by fissures of the seventh order, became

possible.

During growth of upper parts of the wedges the rate of sedimentation decreased and the main wedges became thicker, increasing the compressive stresses. In this case, the second and fifth wedges should become thinner (as in their lower parts), but evidently the climate became colder and temperature gradients increased. This offset the decrease of sedimentation rate and allowed the second and fifth wedges to grow upward and even to become thicker.

In the case of sufficient decrease of the sedimentation rate (resulting in swelling of the wedges and greater compression of soil) even fissures of the first and second orders evidently become so narrow that wedge growth actually stops. Since sediments continue to accumulate, though slowly, the lower surface of the thawing layer separates from the upper surface of the wedges and the latter becomes "fossil ice."

Sharp increase of upper wedge width indicates morphologically that its development has ceased.

CONCLUSIONS

Underground ice-wedges result from alternating and repeating contrary processes: Winter-spring accumulation of ice, and of summer-autumn thawing. Shape and texture of ice-wedges reveal the environmental conditions on which their development depends.

Ice-wedges develop simultaneously with accumulation of sediments on alluvial plains under conditions of severe cold climate and thin snow cover.

Vertical dimensions of syngenetic wedges depend on the regime of sedimentation and on the thickness of sediments; therefore, they indicate the direction and character of epirogenic movements of the alluvial plains. Thus, the thickness and shape of the ice-wedges are important diagnostic palaeoclimate and geotectonic features.

Having established that the thick fossil ice on the northern plains of Siberia is wedge-ice and not of firm or glacier origin, we agree with A. A. Bunge's conclusion that the most important evidence in favor of the ancient glaciation of Siberia must be rejected.

REFERENCES

- [1] B. N. Dostovalov. "The Developmental Laws of Tetragonal Systems of Ice and Soil Veins in Dispersed Strata," Periglatsial'nye iavleniia na territorii SSSR, Moscow State Univ. Publ. House, 1960.
- [2] A. I. Popov. "Lithogenous Features of Alluvial Plains under Severe Climatic Conditions," Bull. Acad. Sci. USSR, Geogr. Ser., No. 2, 1953.
- [3] P. A. Shumskii. Osnovy strukturnogo ledovedeniia, Moscow, Acad. Sci. USSR, 1955.

THEORY OF THE DEVELOPMENT OF FROZEN ROCK MASSES

V. A. KUDRYAVTSEV, Moscow State University

More than 30 years ago, M. I. Sumgin put forward a theory of permafrost degradation in which permafrost is regarded not as eternal and static but as once formed and later continuously changing.

The origin of permafrost was associated with climatic changes on the earth's surface in response to the general development of the earth during the Quaternary period.

In particular, Sumgin associated the origin of permafrost with the colder climate. He assumed that during the post-glacial period the climate became continuously warmer and, therefore, the permafrost either thawed or the temperature of the permafrost rose continuously. Sumgin [1] considered this process the decrease of "cold" stored in permafrost and proposed that it be called "permafrost degradation."

To support his statements Sumgin cited many facts indicating the rise of temperature in upper layers of the lithosphere during the last period and pointed out actual cases of permafrost thawing. He outlined the following evidence of permafrost degradation:

- (a) Ground temperature curves having a temperature gradient changing its sign with depth;
- (b) a break between the seasonally frozen soil layer and the permafrost layer that comprises a layer of unfrozen strata;
- (c) the northward displacement of the southern permafrost boundary with time;
- (d) the formation and development of thermokarst caused by the thawing of underground ice; and
- (e) discoveries of fossil cold-resistant fauna and flora in southern regions, indicating a colder climate in the past.

Later permafrost investigators sought new facts supporting Sumgin's theory. In many regions the degradation process was observed but a reverse process was also noted—the accumulation of frozen layers and decrease of their temperature.

Such conflicting data caused a dispute among investigators. Contrary to Sumgin's theory, S. T. Parkhomenko, and P. I. Koloskov, N. P. Kapterev and others insisted that permafrost results from contemporary climate. This dispute was unresolved until the post-war period. The quantity of field data collected to date suggests a resolution of the differences. Essential details of this approach follow.

Permafrost develops because of the heat exchange between lithosphere and atmosphere; this is a thermophysical phenomenon. This heat exchange occurs, however, in a particular geologic and geographic environment. Permafrost layers closely interact with this environment, and this is true because heat exchange between lithosphere and atmosphere depends in many respects on the character of geologic and, chiefly, geographic conditions. Therefore, permafrost must develop within the general development of its geologic and geographic environment, and by physical and thermodynamic laws.

The foregoing statement outlines a new approach to the study of permafrost, its formation, and development. From this view permafrost development is affected by the following aspects of geologic and geographic environment:

- (a) Character of general geologic structures—bedding, structure, and texture of rocks, and their thermal conditions with depth.
- (b) Neotectonic movements and general progress of rock formation—the genetic processes of sedimentation and erosion.
- (c) Processes in rock masses—diagenesis, exo- and endothermal processes, and weathering.
- (d) Processes of moisture exchange between lithosphere and atmosphere, character of hydrogeologic structures, and circulation, regime, and chemical composition of underground waters.

- (e) Geomorphological development and other surface processes—including topographic formation, surface water activity, and influence of vegetation, soils, climate, and man's economic activity.

Permafrost layers differ greatly in thickness, composition, occurrence, and continuity of existence. Seasonally frozen soils exist for several days or months; thick permafrost layers exist for geologic intervals of time. One cannot study them in the same manner, but general laws of development apply in both cases. Therefore, our aim is to establish general laws of permafrost formation and development and specific laws for these two kinds of frozen strata.

There is a marked difference in their development. For example, the influence of microrelief or swamps on formation of thick permafrost layers is insignificant as the influence of geologic structures at great depths and of geothermal gradient on the depth of seasonal freezing and thawing of soils. Therefore, it is necessary to outline the factors determining the development of known kinds of frozen strata and to study them carefully.

A clear concept of the time rate of the thermophysical processes is very important. For example, the temperature of frozen strata at a depth of 10 to 20 m is frequently studied and related to the age of the surface relief and of the rocks themselves, while the temperature regime at these depths depends on contemporary processes not older than two to three decades. There are frequent efforts to determine the thickness of permafrost layers using their temperature at a depth of 10 to 20 m and the temperature gradient, while the thermal inertia of these two characteristics differs by several orders of magnitude.

One cannot analyze and compare the thicknesses of frozen strata without considering their composition and ice content. Thus, when permafrost development is analyzed in relation to certain geologic or geographic processes, a clear concept of the relationship of the rate of these processes to rate of heat exchange is necessary.

Factors that determine permafrost development change with time and at different rates. For example, regional geologic structures are practically unchanged during the entire existence of permafrost. Their influence is constant. This is also true of geothermal gradient and hydrogeologic structures at great depths and so on. However, geographic processes on the earth's surface and even geotectonic movements and sedimentation develop rapidly enough to influence the development of thick permafrost layers.

All external processes that change the conditions on the earth's surface are rapid enough to essentially determine variations of heat exchange between lithosphere and atmosphere. Most internal processes in the series of strata develop much more slowly.

Relative to heat exchange all processes which alter the earth's surface, i.e., which change boundary conditions on the upper surface of the permafrost layer, may be divided into three main groups:

- (a) Processes causing periodic fluctuations of the heat exchange of rocks, with the earth's surface unaltered;
- (b) Processes causing monotonic alteration of heat exchange which either increase or decrease rock temperature, with the earth's surface unaltered; and
- (c) The first two processes combined with sedimentation and erosion.

Principles of frozen ground formation in these three cases differ; in an actual case, rock development and the related temperature field depend on the rates of these processes. Periodic alteration of heat exchange leads to formation of frozen layers and their temperature fields, depending on three parameters: Mean rock temperature during the period of temperature oscillation; temperature amplitude on the upper sur-

face of the permafrost layer, and the period of the temperature oscillations.

Observed and established heat exchange fluctuations, depending on different causes, are very numerous. These oscillations penetrate to different depths depending on their periods. They have continuously changed the thickness, composition, and temperature regime of frozen layers both near the earth's surface and at different depths.

When fluctuation of heat exchange in rocks is monotonic (neotectonic processes, marine transgressions and regressions, glaciation and its boundary changes, etc.), laws of permafrost formation sometimes differ from those with frequent thermal oscillations. Monotonic change recedes to very slow oscillations over a very long period. The rate of change of the temperature field and permafrost thickness variations then depend on the rate of change of the upper boundary conditions.

At a sudden change in the heat transfer in rocks in one direction (draining of reservoirs, cutting of forests, extensive plowing, etc.), the laws of permafrost development differ sharply from those with periodic oscillations of heat exchange. Here the dynamic balance between temperature field and permafrost thickness is sharply disturbed, and the latter begins to change in accordance with new upper boundary conditions. Usually this process develops very rapidly in comparison with temperature and permafrost thickness changes connected with long fluctuating heat exchanges in rocks near the surface. For example, a frozen layer 30 m thick may take 10,000 years during long periodic oscillations and take 700 years with a sudden change of thermal conditions. The same applies to the temperature fields of frozen layers.

With periodic heat exchange variations, the thickness of a permafrost layer depends also on composition, particularly on water and ice content. Permafrost thickness is always smaller in water-saturated, disintegrated rocks than in dry igneous rocks. At sudden alteration of heat exchange in rocks near the earth's surface, the composition and water content of rocks are less important and modify permafrost thickness only through the coefficient of thermal conductivity.

It is also important in periodic heat exchange in rocks near the earth's surface that principles of damping of oscillations with depth will determine the distribution of ice with depth in epigenetic permafrost. Maximum ice content (which decreases with depth) is associated with the upper horizons of the permafrost. Numerous examples support this. With sudden variations in heat exchange, such a regular ice distribution is absent. Thus, an increase of ice content with depth is observed if, during freezing, sufficient water is supplied to the frontal surface of freezing. Freezing rate decreases as the freezing front descends.

Accumulation of sediments and erosion may substantially alter the temperature field and permafrost thickness only when the rate of these processes and their continuity are commensurate with the period of heat exchange on the earth's surface. Therefore, the processes of sedimentation and erosion are more important in far northern regions where permafrost is several hundred thousand years old and of great thickness.

The chief specific features of permafrost layers associated with sedimentation are the syngenetic character of their formation and the resulting texture and structure. The process of either increase or decrease of heat stored in the permafrost layers, i.e., the process called by Sumgin "degradation" or "aggradation" of permafrost, is a very complicated process of heat content variations in the upper layers of the lithosphere. This process is further complicated by the superposition of all the processes developing in the permafrost itself and in underlying rocks. Therefore, the very complex character of permafrost formation is evident, even without considering other aspects of this phenomenon.

It is natural that every change of geographic or geologic conditions either increases or decreases heat content in upper layers of the lithosphere. Many of these changes occur simultaneously. They combine and are mutually superimposed, and we can observe only their general total effect.

The contemporary view of permafrost development, which differs from Sumgin's theory of permafrost degradation, con-

siders that several permafrost degradation and aggradation processes develop simultaneously at the same point on the earth's surface. Therefore, one may not speak of permafrost aggradation or degradation abstractly, since neither degradation nor aggradation of permafrost can exist separately. When the many processes are analyzed, they can be divided into short, medium, and long-period changes of permafrost layers.

The development of permafrost degradation and aggradation trends should be considered in relation to a definite period of time. If permafrost is degrading, it is necessary to state for what moment of time the heat content of the frozen layers is taken for comparison with their present conditions.

The results of such a correlation differ if contemporary conditions are compared with those of 100, 1000, and 10,000 years ago. For example, in considering the postglacial period, it is evident that the present heat content in frozen layers is greater than before the Holocene epoch. But the middle of the Holocene was characterized by a thermal maximum during which the heat content of rocks was greater than it is at present. Therefore, permafrost layers now degrade in comparison with the pre-Holocene conditions; but, on the other hand, have aggraded during the last 3000 to 5000 years.

Thus, in the west Siberian plain there are actually two layers of permafrost separated by unfrozen interlayers. It is evident that the lower frozen layer is related to heat exchange in rocks during the Upper Quaternary, while the upper permafrost layer is the result of rock freezing after the thermal maximum. This theory is well supported by studies using calculations and the hydrointegrator (hydraulic analog computer).

At the same time, a 300-year temperature rise is established for this region causing a short-period degradation of permafrost. Due to this process temperature curves in permafrost, having no gradient at 50 to 100 m depths and more, are observed in a large part of the western Siberian plain.

Permafrost in this region is characterized by another interesting feature. During the Salemal and Kargin marine transgressions, this territory was covered by water. Permafrost could not develop or exist for a long time; it could develop here only after sea regression. Thus, a probable age of the permafrost is defined. Permafrost beds have different thicknesses: 380 m, 200 m, and 60 to 20 m. Considering these thicknesses, one can draw conclusions about the limits of marine transgressions and ingressions. Permafrost temperature variations (as well as permafrost composition and thickness) change at great depths more slowly than on the earth's surface. With great permafrost thicknesses this time lag is tens and hundreds of thousands of years.

Experimental models of lithosphere freezing to show oscillations of heat exchange (calculated for a period of 150,000 years) on the western Siberian plain were studied at Moscow University. The models showed that during this period the lithosphere can freeze from 120 to 250 m deep, depending on the composition and water content of rocks. The absolute age of these rocks using the ionium method was calculated to be about 280,000 years.

Thus, permafrost layers are epigenetic as proved by their structure. Permafrost layers in this region were as thick as 300 m, their age being about 300,000 to 400,000 years, i.e., more than half of the Quaternary period. Therefore, in this region, syngenetic permafrost layers are possible. The occurrence in the extreme North of permafrost layers having still greater thicknesses (600 to 700 m) indicates that they have existed for a longer time, probably during the entire Quaternary period.

Thus, variations of heat exchange on the earth's surface at the same time and at the same place with different periods, penetrate to different depths. For example, upper horizons of permafrost layers may reveal a short-period degradation while the lower horizons may undergo a long-period aggradation. Therefore, several degradation and aggradation trends of permafrost development exist at the same place at the same time, alternating with depth. The examples show how complex permafrost development is; it is impossible to consider the degradation and aggradation of permafrost without con-

sidering time, space, and the character of the medium where these processes occur.

Sumgin, in suggesting the theory of permafrost degradation, considered definite conditions. He compared the contemporary conditions of permafrost layers with those during the last period of glaciation. In such a case permafrost degradation is quite evident, but this process is considerably complicated by the superposition of many other aggradation and degradation factors. It is natural that 25 and even 15 years ago this question could not be considered so much in detail, and 25 years hence, its present treatment will be insufficient. This does not mean that Sumgin's theory of permafrost degradation is wrong or obsolete, and must be abandoned. In his history he considered a continuous development of permafrost. The next step in working out the history of permafrost development was based on this theory. When the history of the develop-

ment of permafrost was studied in a new and wider context, the issue concerning signs of permafrost degradation was correspondingly revised.

Permafrost development is closely related to geologic and paleogeographic development of the region considered and represents a part of the general history of this region's development in the Quaternary period. Any permafrost study must acknowledge such relationships. It is also necessary to work from laws of thermodynamics and physics and to relate permafrost development to actual conditions of the region in question.

REFERENCE

[1] M. I. Sumgin. *Vechnaya merzlota v predelakh SSSR*, Moscow, Akad. Sci. USSR, 1927.

UNDERGROUND ICE

P. A. SHUMSKIY, Interdepartmental Commission for Antarctic Research, Moscow
 B. I. VTYURIN, V. A. Obruchev Permafrost Research Institute, Moscow

Ice occurring in the earth's crust is called "underground ice," regardless of the specific features of its origin or forms of bedding. Ice occurs only in the very upper horizons of the lithosphere. The total volume of underground ice is roughly estimated as 0.2 to 0.5 million cu km, or less than 1% of the ice volume of the earth; nevertheless, in some places it is the chief component of the lithosphere. There are regions in northern Asia and America in which the upper part of the rock strata 20 to 30 m thick contains 50 to 80% ice. The history of the investigations into large ice masses may be subdivided into three stages forming a peculiar "closed circle."

The first information concerning underground ice was obtained in Siberia during the Great North Expedition by P. Lassinus in 1735 and Kh. P. Laptev in 1739. The origin of the theory of the formation of ice-wedges is connected with A. Ye. Figurin (1823), who first described correctly the distribution of the most frequent type of underground ice and indicated its development in frost fissures in past and present periods. This theory was supported by I. A. Lopatin and A. A. Bunge. Bunge observed the contemporary processes of ice-wedge formation in the frost fissures. He was also the first to establish the genetic connection of polygonal relief with the development of ice-wedges and their occurrence in the vast areas of tundra.

The snow-glacial hypothesis of underground ice origin was suggested by E. Toll and developed by K. T. Vollosovich, I. P. Tolmachev, and A. A. Grigoriev. Later they were supported by such investigators as V. A. Obruchev, M. M. Yermolayev, M. I. Sumgin, and V. N. Saks. At the same time other hypotheses developed: Of lake ice (A. Maddren), of buried river ice and aufeis (A. I. Gusev and others), of sea ice (A. I. Demytyev and others). Hence, the problem of the genesis of the most frequent type of underground ice became more complicated.

During the period of the dominance of the snow-glacial hypothesis, most investigators did not deny the possibility of ice-wedge formation. Only the effort to explain the origin of big underground ice masses in such a way was rejected. During this period the wedge origin of the dominant part of underground ice was supported in its entirety only by E. Leffingwell. The circle was closed with the appearance of the syngenetic theory of ice-wedge formation. The theory was suggested by the work of G. Steche and V. Zorgel and was ultimately formulated by G. Galwitz and independently by A. Popov. This theory explained the development mechanism of ice-wedges of any dimension. Further development of the theory was obtained by special investigations carried out in the Permafrost Research Institute (Academy of Sciences, USSR) under P. A. Shumskiy beginning in 1950. The theory of frost

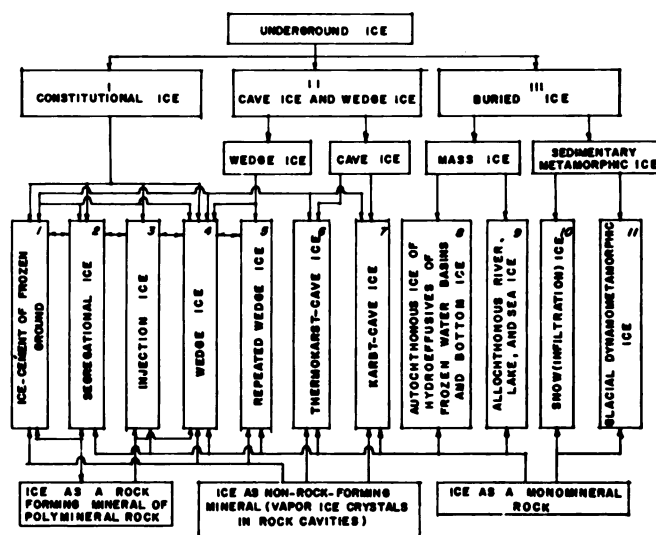

Fig. 1. Classification of underground ice

cracking and its applications to the theory of wedge ice development was successfully worked out by B. N. Dostovalov. Numerous regional investigators in the USSR (P. A. Shumskiy, B. I. Vtyurin, E. M. Tatonov, N. F. Grigoriev, and others) and in Alaska and Canada (R. F. Black, D. M. Hopkins, R. P. Sharp, A. L. Washburn, and others) contributed to the theory of the wedge origin of large underground-ice accumulations.

Questions concerning the study of the structure-forming process (segregation or injection) of ice have their own history. In recent years, attention has shifted from ice segregation mechanism and water migration, to the study of the cryogenous structure of disintegrated deposits. Hence, the "frost-facies" method of the study of permafrost was successfully developed in the USSR by E. M. Katanov, N. N. Romanovsky and others. The mechanism of the formation of ice inclusions in freezing soils was worked out earlier by I. A. Lopatin, B. Khegbomov, S. Taber, G. Beskow; currently, by A. M. Pchelintsev, F. G. Bakulin, and others. Present investigators pay more attention to injected ice which in definite conditions can also form vast layers (B. I. Vtyurin, Sh. Sh. Gassanov).

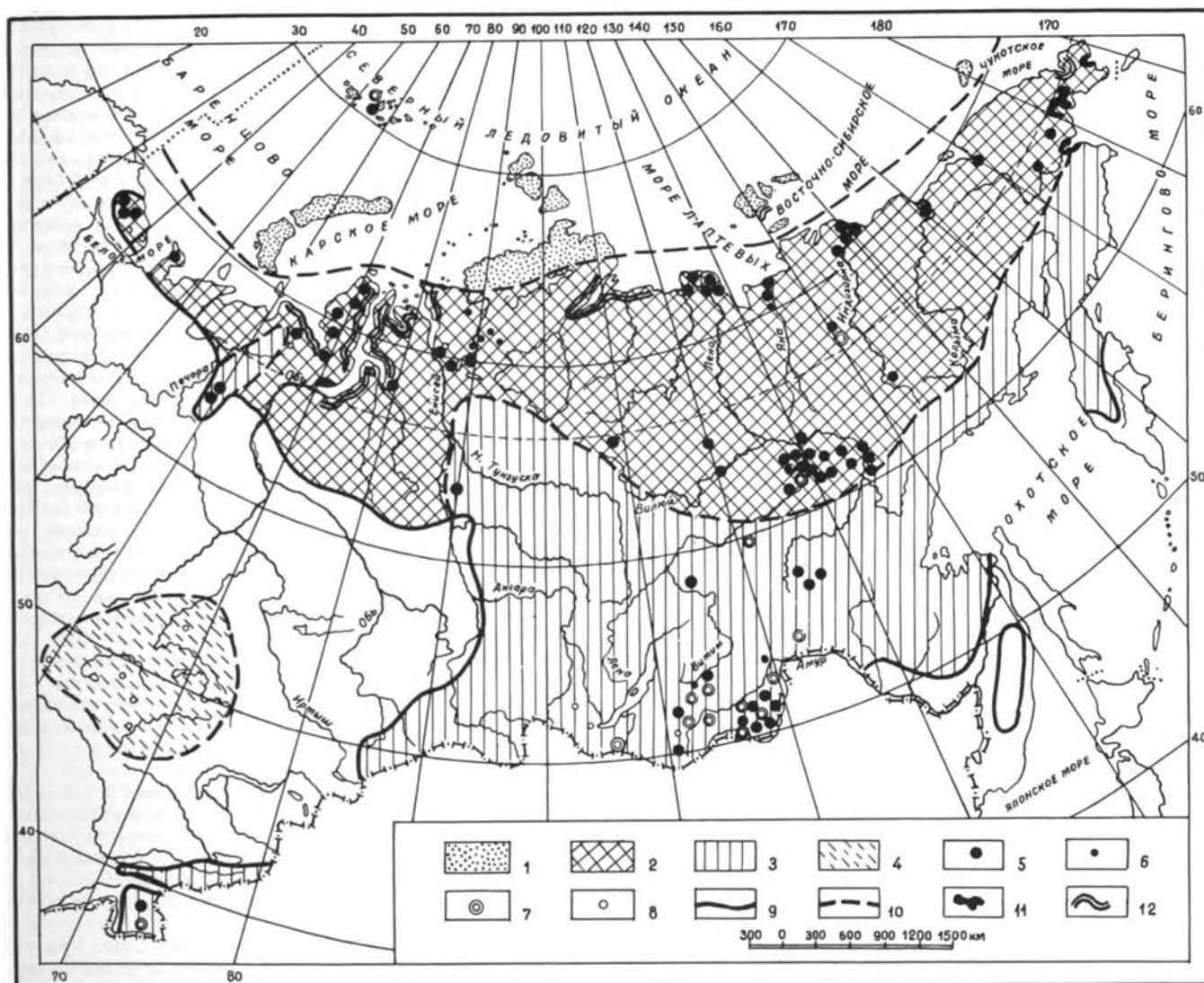

Fig. 2. Schematic map of the distribution of injection ice: (1) Arctic zone, frost-heaving mounds are rare; (2) Region of perennial (rarely seasonal) frost-heaving mounds, chiefly on freezing sublake taliks; (3) Region of perennial and seasonal heaving mounds on spring outlets; (4) Regions of separate single heaving mounds on spring outlets beyond the permafrost territory; (5) Group of perennial heaving mounds; (6) Single perennial heaving mound; (7) Group of seasonal heaving mounds; (8) Single seasonal heaving mound; (9) Southern boundary of permafrost; (10) Boundaries of regions; (11) Sills of ancient injection ice; (12) Supposed sills of ancient injection ice

CLASSIFICATION OF UNDERGROUND ICE

Various classifications exist that are constructed on different principles and generalize more or less valid concepts of the nature of underground ice.

A genetic classification was suggested by P. A. Shumskiy. Among the processes of underground ice development, he distinguishes three basic groups that produce three corresponding types of ice: (1) Freezing of wet sediment creates constitutional ice; (2) filling up of the cavities in frozen rocks results in the formation of cave-wedge ice; (3) burying of surface ice by sediments produces buried ice. These three types are divided into subtypes and species (Fig. 1). The injection ice and the true wedge ice—usually—and the cave ice—always—are epigenetic (they develop inside the enclosing rocks after the latter is formed). Buried ice is always syngenetic (formed simultaneously with the enclosing rocks and before the overlying rocks). The segregational ice and repeated-wedge ice are both epigenetic and syngenetic. Any type of ice may be contemporary or a fossil of any age.

Ice cement is the most widely distributed and the least

studied ice type in permafrost. Depending on the degree of saturation, four types of ice cement are distinguished: (1) Contact cement that is located only at contacts of the mineral particles; (2) film cement that fully envelops the surface of particles but leaves considerable amounts of the pores unfilled; (3) pore cement that fills the pores entirely; (4) basal cement that forms the main rock mass in which separated mineral particles are submerged.

Ice-cemented rock forms the massive cryrogenous rock structure. Corresponding with the four types of ice-cemented rocks are these species of cryrogenous structure: Contact-massive, film-massive, pore-massive, and basal-massive.

Segregational ice represents the result of the crystallizational differentiation taking place during the freezing of wet sediments, accompanied by water migration to the ice front. Segregational ice is an intermediate ice-cement type of underground ice. The specific feature of this type is that its formation is associated with considerable soil frost-heaving, and its thawing produces great soil settlement. Segregational ice may develop both inside the freezing rocks and on their sur-

face. In the latter case it is represented by ice efflorescence, arising because of the freezing of water and migration to the surface. They are called "ice-stalks," "spiky fiber ice," "ice grass," etc.

Inside freezing sediments segregational ice forms ice inclusions of different shapes and orientation. Parallel-to-the-surface orientation is dominant. Dimensions, shape, and situation of ice inclusions determine the character of the cryogenous structure of frozen rock. Two basic ice-inclusion structures are lamellar and cellular or latticed types. They are subdivided into lamellar-cellular, cellular-lamellar, partly lamellar, partly cellular, etc.

Segregational ice is usually pure, has almost no admixtures; its density is near that of pure ice. The texture of segregational ice is as varied as the conditions of its formation and is, evidently, related to the character of the cryogenous structure. Hypidiomorphous granular textures (with more or less distinct predominance of the main crystal axes perpendicular to the plane of the inclusion) are the most frequent.

Injection ice is formed when water intrudes under rock layers. It beds in larger masses than does the segregation ice. Sometimes it forms great sill beds several meters thick and hundreds of meters long; nevertheless, its part in the underground ice mass is quantitatively much smaller than that of ice cement or segregational ice. This is due to the sporadic occurrence of injection ice only under peculiar conditions in the layers of seasonal freezing and thawing, or near the upper boundary of the permafrost layer; in exceptional cases it occurs at a depth of several meters.

According to conditions of formation, the following types of injection ice may be distinguished:

1. Seasonal types form on the outlets of springs in zones of seasonally frozen grounds, in closed-system freezing of the seasonally thawing layer, and in above permafrost underground stream freezing.

2. Perennial types form on the outlets of underpermafrost waters, in closed sublake freezing of taliks (thawed zones), and in waterbearing horizon freezing during a deep primary epigenetic freezing of rocks. Many intermediate types of injection ice can be observed.

Injection ice differs from other underground ice types not only by the peculiar conditions of bedding and the shape of ice bodies, but also by specific structural and textural features. It is comparatively pure and has the largest grains of all underground ice species. Maximum observed diameter of inclusions of ice crystals is 90 cm. Among the inclusions, air bubbles of different shapes and dimensions are frequent. They sometimes form an indistinctly expressed stratification parallel to the overlying layer or groups of bubbles of different dimensions. The ice bodies, formed by means of many repeated injections, may include separate pebbles and even boulders frozen into ice at their upper part and uplifted during further injections and heavings.

On the surface, differentiated heaving is expressed in the form of mounds and heaving areas of different shapes and sizes. The geographic occurrence of injection ice is shown in Fig. 2.

Wedge ice represents a connecting link between the groups of constitutional ice and cave-wedge ice. Depending on the mode of formation, it is included in one group or another. The wedge ice, formed by freezing of cracked waterbearing rocks, must be referred to the group of constitutional ice, since it is formed from underground water. If water penetrates fissures from the surface and freezes in them, such ice must be referred to the group of cave-wedge ice. Wedge ice belongs to typical epigenetic formations.

Repeated-wedge ice represents a specific variety of wedge ice—the result of repeated ice formation in fissures periodically forming in about the same place many times. By its large size, repeated-wedge ice is outstanding among the underground ice modifications and is important in the development of cryogenous relief forms. At present, repeated-wedge ice is easier to study than other kinds of underground ice.

ICE-WEDGES

The mechanism of the formation of ice-wedges is as follows:

Seasonal temperature oscillations produce annual changes of volume in the upper horizon of frozen rock—contraction by cooling and expansion by heating. The cooling of a solid rock mass from the surface results in tensile stress which breaks it into separate blocks. Distance of frost fissures from each other is determined by tensile strength of the material, and increases with the rock strength. Frost fissures arise on the soil surface from the end of October to January, penetrate deeper and deeper, widen with the propagation of the cold temperature wave downward, and close during the summer rock heating. In this plan, frost fissures make a polygonal net that is more regular the more homogeneous the rock.

In winter, frost fissures are filled with hoar frost, and during the snow thaw, flood water fills them up and freezes because of the low temperature of the enclosing rocks. In every fissure a thin vertical ice layer is formed—an elementary annual vein—pressing off the frozen rock. Since ice tensile strength is much less than that of frozen rocks, cracking is periodically repeated in about the same place; therefore, the ice-wedge gradually widens. If at the same time the temperature gradients increase (which helps to deepen cracking), the vertical dimensions of the veins grow. The enclosing rocks in contact with the veins become denser, are crushed and pressed upward, and form small ridges on both sides of the frost fissure. Such is the process of epigenetic ice-wedge growth.

If new sediments accumulate simultaneously with the growth of ice-wedges, the general surface level and the permafrost upper boundary are gradually elevated and are accompanied by the growing ice-wedges. Such wedges are said to be syngenetic. They grow both in width and height, piercing all accumulating permafrost layers.

General conditions of ice-wedge development in the upper permafrost layer are as follows: (1) Appearance of frost fissures penetrating the permafrost; (2) filling up of the fissures by ice; (3) presence of sufficiently plastic or compressible frozen rocks. For deep frost cracking, sufficiently great temperature oscillations in the upper layer of rock are necessary.

Wedges grow in rocks of different genesis: bog, lake, alluvial, marine, glacial, diluvial rocks—even in a very icy coarse fragmental eluvium. They develop and occur most frequently in concordantly stratified alluvium; they occur geomorphologically in flood-plain conditions. Syngenetic ice-wedges under such conditions sometimes grow to a vertical dimension of several tens of meters and up to a width of 10 m in their upper part. Epigenetic ice-wedges have vertical dimensions of 2 to 8 m and upper widths of 0.5 to 3 m.

Repeated-wedge ice differs from other ice varieties by the abundance of admixtures that are due to the very mode of its origin (to the filling up of frost fissures by hoar frost and water). Besides autogenous salts and gases present in any mass of ice, repeated-wedge ice usually also contains xenogenic admixtures such as mineral particles brought by water, fine organic remnants, and air in the pores among the sublimation crystals. The quantity of hard mineral and organic admixtures may reach 3 to 5% of the total weight and 1.0 to 1.7% of the total ice volume. The volume of the gas-filled cavities may reach 4 to 6% of the total volume; 2 to 4% of this represents cavities filled by xenogenic gases. Veins may also contain the xenoliths of enclosing rocks. These admixtures create a specific appearance of the repeated-wedge ice permitting easy identification.

Repeated-wedge ice is poorly mineralized and from the composition of the salts corresponds to the surface-flow water. The composition of enclosed gases, due to abundance of organic remnants in the ice, differs considerably both from the atmospheric air and from the mixture of gases saturating the water. Nitrogen, argon, and other inert gases make up 94 to 98% (by volume); oxygen makes up only 0.5 to 5%; and a small quantity of biochemical gases is present, including carbonic acids, hydrogen, ammonia, and methane. The un-

usually small oxygen content is explained by the oxidation of organic remains contained in the ice.

Composition and quantity of xenogenic admixtures in the ice depend on the water regime of the earth's surface during the formation of the admixtures.

Ice heavily contaminated by mineral admixtures is dark gray or brown and has a distinct vertical stratification. The vertical layers are produced by fine (from a fraction of a millimeter to 1 to 2 mm) layers of mineral particles located along the axial planes of annual elementary ice veins due to the pushing away of inclusions by the ice crystals that grow from frost fissure walls when water freezes. This stratification is frequently irregular, curved, and intercutting; the boundaries of layers are indistinct due to the remelting of the contacts. Gas inclusions are chiefly autogenous and more or less geometric in shape. Ice, little contaminated by mineral admixtures but with many gas inclusions, has a whitish color and an indistinct vertical stratification. Mineral admixtures are scattered in it as separate nodules, and the stratification is produced by a varying content of gas inclusions in neighboring layers. The majority of gas inclusions are xenogenic and have irregularly curved or branched shapes.

With the above distinctions in composition and structure of the repeated-wedge ice, it is possible to distinguish the following basic species, between which gradual transitions are observed:

1. Repeated-wedge ice is formed in an unflooded surface (smooth plateau surfaces, plains, river and lake terraces, and high flood plains). The ice is white or light gray, cryptolamellar, finely grained with chaotic orientation of crystal optic axes; ice density is 0.875 to 0.895 g/cu cm. Mineral admixtures are very slight (a fraction of 1% by weight), vegetation remains are present, and numerous gas inclusions of irregular shape are contained (3.5 to 6% by volume).

2. Repeated-wedge ice is formed in a periodically flooded surface (flood plains, drainage zones, and depressions). The ice is gray and brownish-gray, distinctly stratified, with density 0.895 to 0.905 g/cu cm, contains considerable mineral admixtures (1 to 3% by weight), and gas inclusions (2.5 to 3.5% by volume) chiefly of regular shape; the ice texture is allotriomorphogranular. The ice is fine and medium grained (mean diameter 3 to 5 mm); the ice crystallography is chaotic.

3. Repeated-wedge ice is formed in annually flooded or permanently submerged surfaces (side stream shallows, low flood plains, and bottoms of small water reservoirs). The ice is dark gray and brownish gray to brown, distinctly stratified, with density above 0.905 g/cu cm. It contains a great amount of mineral admixtures (3 to 5% by weight), sometimes sandy (the wedges formed in the side stream shallows). Gas admixtures are scarce (2 to 2.5% by volume); their shape is chiefly regular. The ice texture is hypidiomorphogranular and allotriomorphogranular. Correspondingly, crystallographic orientation, depending chiefly on the temperature of fissure walls, may be both chaotic and more or less regular—the dominant development being obtained by those crystals whose chief axes are oriented perpendicularly to fissure walls.

The number of the annual layers in a wedge determines the minimum duration of its development in years (the time of the wedge development may be longer if the cracking does not take place every year). If the depth of the wedge upper surface is equal to the seasonal thawing layer thickness, such wedges continue to grow. A deeper bed means that the wedges have stopped growing. Ice-wedges may be buried and occur at any depth. If epigenetic ice-wedges stop their development, are buried under a layer of sediments, and then begin to develop again, two horizons of ice-wedges in different depths are formed. If wedges of the upper horizon penetrate wedges of the lower horizon, then the complicated two-, three-, and multistaged wedges are formed. The latter occur most frequently on diluvial-solifluction slopes.

The ultimate state of multistage wedge structure is represented by syngenetic ice-wedges in which every stage consists of one annual ice layer located higher than a previous one by one or several annual layers of sediments. The sy-

genetic ice-wedge differs from an epigenetic one in that part of the annual ice layers begin on a vertical or inclined contact surface rather than a horizontal one. Syngenetic wedges reach much greater dimensions than epigenetic ones and may include tens of thousands of annual ice layers. Their vertical dimensions are limited only by the thickness of syngenetic sediments and, in the regions of intense tectonic sinking, may be very great. On the Yana River ice-wedges are known with a vertical dimension of 40 to 50 m.

Ice-wedges form a polygonal net in plan. The polygon dimensions vary from several meters to 100 to 150 m, depending on the combination of natural conditions. The number of angles in a polygon varies from three to six. Sometimes in very homogeneous enclosing sediments, an exceptionally regular tetragonal net is formed.

Because frost fissures form the polygonal nets, both when they penetrate into permafrost and produce ice-wedges and when they do not reach permafrost and do not result in ice-wedges, the polygonal relief produced by the frost fissures must be called a "fissure-polygonal relief." Thus two types occurs: Seasonally fissure-polygonal microrelief (diameter of polygons from 1 to 10-15 m) and wedge-polygonal relief (diameter of polygons 10 to 150 m). In the north the latter is of a greater importance. Forms of the wedge-polygonal relief observed on the earth surface vary, depending on the stage of ice-wedge development (Table I, Fig. 3).

Surface morphology or repeated-wedge ice and other underground ice species depends on the stage of underground ice development (Table II).

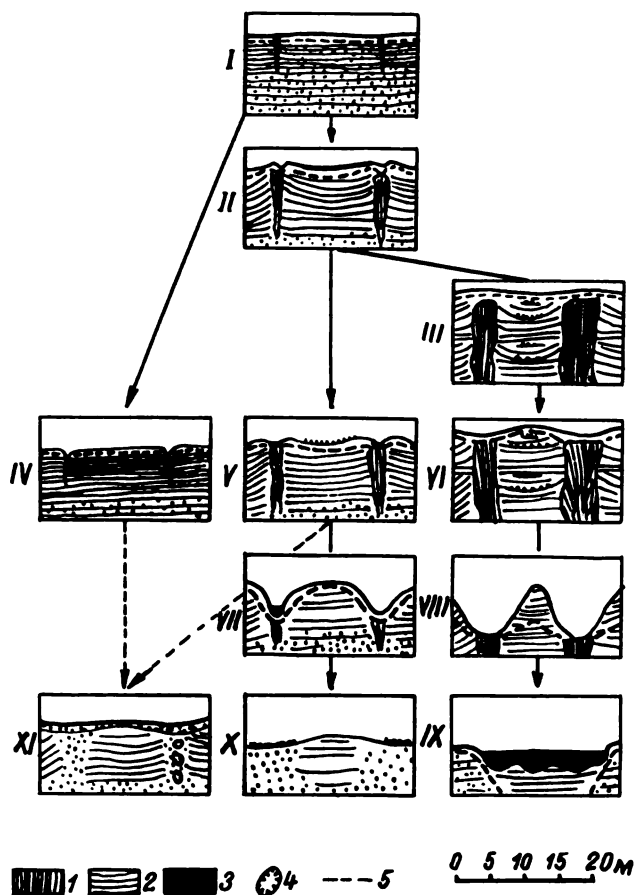

Fig. 3. Stages of development in an ice-wedge polygon: (1) Stratification in ice-wedges; (2) Stratification inside polygons; (3) Water; (4) Cavities in pseudomorphoses on ice-wedges; (5) Upper surface of permafrost (IX, thermokarst lake, not to scale)

Table I. Genetic series of wedge-polygonal relief forms

Type of Relief	Polygonal Forms
Raised edge	Initial stage: Plane without raised edges. Mature stage: Concave with raised edges and bogs in center.
Planed	Surface planation and ice-wedge state: Plane poorly expressed with overgrown bogs and without raised edges; surface without polygons.
Thermokarst	Initial destruction stage: (1) Plane, without raised edges but with narrow thawing furrows; (2) with raised edges and thawing furrows between them; (3) convex, without raised edges, rounded in plan with wide shallow thawing furrows. Mature destruction stage: (1) Convex, without raised edges, with deep thawing furrows; (2) cone-like polygon remnants of rounded shape in plan with wide deep thawing furrows ("bajarakhs"); (3) thermokarst depressions ("alasses").
Relic	Complete thawing of ice-wedges: (1) Convex, frequently rounded in plan, with pseudomorphoses or cavities replacing the ice-wedges; (2) slightly convex, rounded or elongated in plan, amid relic polygonal bogs.

Table II. Underground ice and resulting cryogenous relief forms

Type of underground ice	Relief Forms	
	Developmental stage	Destructional stage
Ice cement of basal type and segregations	Areas of pronounced frost heaving on a background of general heaving	General surface depression
Injection ice	Areas of feebly expressed heaving. Seasonal and perennial front mounds	Thermokarst depressions (lakes), cirques. Small thermokarst depressions (small lakes)
Repeated-wedge ice	Raised edge polygons	(1) Thermokarst polygons, (2) thermokarst depressions ("alasses"), (3) polygons ("mound-depressional relief")
Buried ice		Thermokarst depressions small and large, cirques, sinkholes

DISTRIBUTION

The geographic occurrence of the types of underground ice is very different. Ice cement and segregational ice are the most widespread and occur practically everywhere. Repeated-wedge ice is very widespread (Fig. 4). In this connection one must distinguish the age of repeated-wedge ice: Contemporary and fossil. Contemporary growth of repeated-wedge ice is found only in the northern permafrost territory. The more continental the climate the greater is the distance between the southern boundaries of the contemporary repeated-wedge ice and of permanently frozen ground. For example, in the middle part of the Lena, this boundary approximately coincides with the 3°C isotherm; and its distance from the permafrost southern boundary is 1000 to 2000 km. In the USSR in Europe it coincides with the -0.5 geoisotherm and is located only 100 to 150 km northward of the southern boundary of permafrost. The chief cause of such a difference evidently lies in the corresponding variations in water content in the surface layer of sediments.

The presence of pseudomorphs and of relic polygonal relief show that in glacial epochs in periglacial zones the repeated-wedge ice extended much more to the south than at present—in some places far beyond the present permafrost region.

Cave ice occurs sporadically; thermokarst-cave ice occurs rather frequently, chiefly in places where repeated-wedge ice thaws out. The peculiar feature of the karst-cave ice is its presence in any climate zone of the earth, except probably, the equator.

CRYOGENOUS RELIEF

Analysis of the scant data available on buried ice shows that except for glacier ice, covered with moraine in regions of present glaciation, there are no authentic discoveries of buried ice. Many investigators, including the authors, observed contemporary burying of snow; but as a rule this was of brief existence, being destroyed soon after its burial. The occurrence of modifications of buried ice remains an open

question, and further investigations are necessary for its answer. Information now available suggests that the part played by buried ice in the lithosphere may be insignificant.

Thus, total quantities of genetically different underground ice are inversely proportional to its concentration in the earth's crust: The more scattered the ice of a given type in the earth's crust, the greater is its total quantity; and conversely, the more it is concentrated in huge continuous masses, the smaller is its total quantity.

CONCLUSIONS

The most important types of underground ice are the scattered and widespread ice cement, segregation ice, and the types of ice forming large accumulations—repeated-wedge ice. The injection ice is less important, and least important are cave ice and buried ice. Correspondingly, the main problem of underground ice study is the study of ice cement and frozen ground texture. In the study of segregation ice the most important problem is investigation of the cryogenous structures and the laws of their formation and the further development of the cryo-structural method of study of fine-grained permafrost. Further detailed investigations of structure and texture should reveal the processes and conditions of their formation and should better explain their properties.

Study of repeated-wedge ice is important both scientifically and practically. It may become useful for genetic determination of the whole enclosing rock series in paleogeographic analysis; however, there are still many unexplained details in the mechanism of its development.

The mechanism of formation is one of the chief tasks in the study of injection ice. Understanding this problem may be important in the study of a cardinal geocryologic problem—the frost heaving of soils.

The theory of the development of underground ice is one of the most important parts of cryolithology, a new branch of geocryology. Further study of underground ice will help the development of cryolithology and of geocryology as a whole.

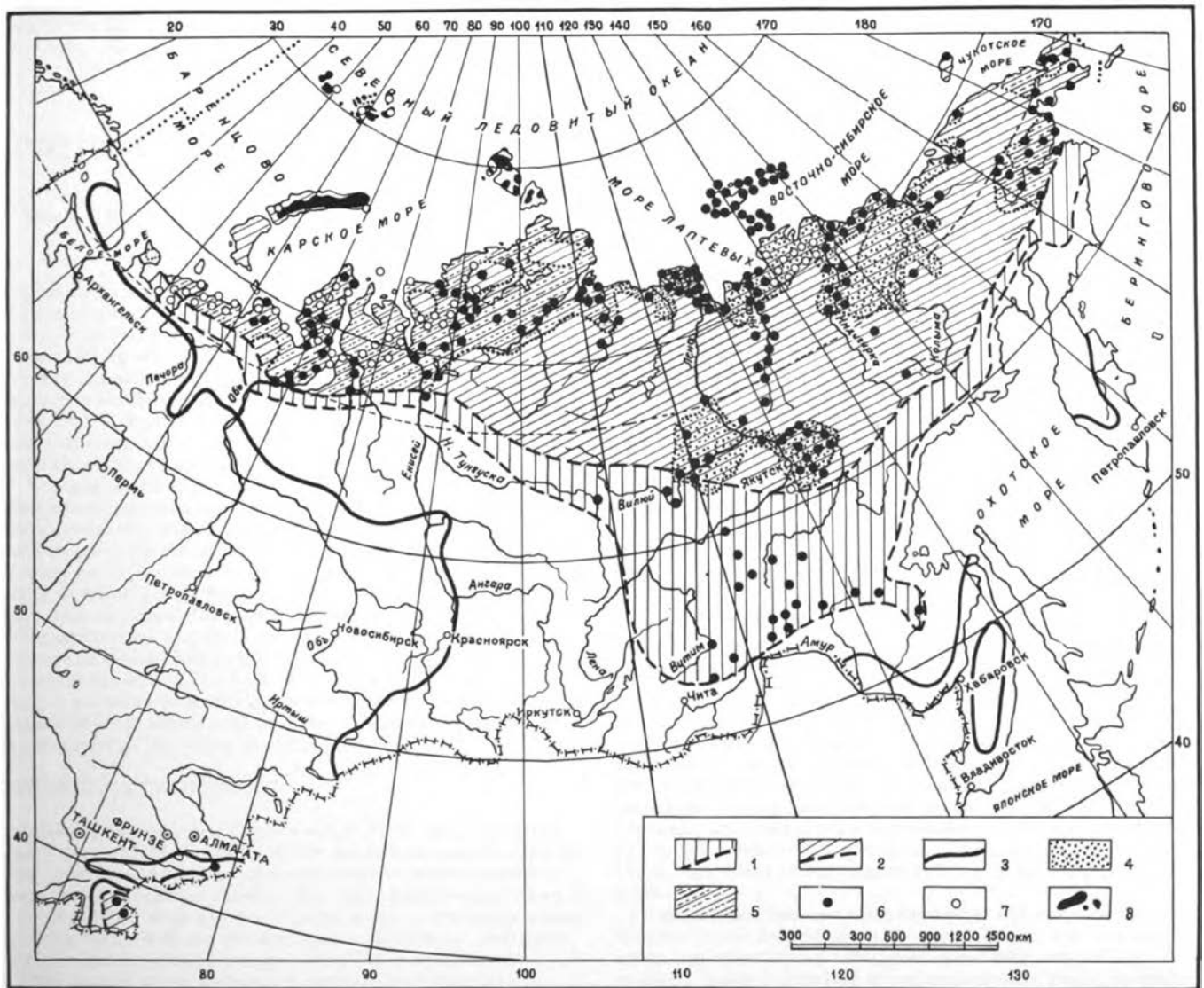

Fig. 4. Schematic map of the distribution of repeated-wedge ice: (1) Region and southern boundary of fossil type; (2) Region and southern boundary of fossil and contemporary types; (3) Southern boundary of permafrost; (4) Regions of silty wedge ice including sediment of great thickness; (5) Ice silt sediments of small thickness; (6) Wedge-ice beds according to ground data; (7) Ice-wedge polygon relief taken by airplane observation; (8) Glaciers

REFERENCES

[1] Principles of Geocryology (Permafrost Studies), Pt. I, Publ. Acad. Sci. USSR, Moscow, 1958.
 [2] P. A. Shumskiy. Outline of the History of the Investiga-

tion of Subsurface Ice, Yakutsk Book Publ., Yakutsk, 1959.
 [3] "On the Problem of the Origin of Ice-Wedges," Trans. Permafrost Research Inst., Vol. 16, Publ. Acad. Sci. USSR, Moscow, 1960.

LIMESTONE TERRAINS IN SOUTHERN ARCTIC CANADA

J. BRIAN BIRD, McGill University, Montreal

Limestone is the most common sedimentary rock in arctic Canada south of Parry Channel, where it covers about 300,000 sq km, or more than 12% of the land surface. Limestone terrains are the sites of most settlements, airfields, and military installations because of the reputed favorable engineering characteristics of terrains where there is continuous permafrost. Studies during the past 15 years have confirmed this observation generally for terrains close to sea level, but have shown also that there are great local variations.

Recognition of arctic limestone terrains from airphotos and their economic utilization for settlement purposes raises questions concerning their fundamental physical properties. In most parts of the world limestone is associated with special scenery and hydrological conditions due largely to the solubility of carbonate rocks in ground water. Geomorphologists have long recognized unique landforms in mid-latitudes where karst landscapes and their evolution were described first by Cvijic and Grund, and in the tropics where *kugel* and *turm* karst are developed [1, 2, 3, 4]. There are few geomorphological accounts of arctic limestone scenery, and it is uncertain to what extent cold climates influence the normal development of limestone landforms.

DISTRIBUTION OF LIMESTONE

The limestones of arctic Canada are of three main geological ages. The oldest occurs in narrow bands and belts of crystalline limestone in Archean metasediments in several areas of the northern Canadian Shield. They are locally conspicuous in southern Baffin Island where in some parts, particularly around Lake Harbour, they are the dominant surface rock; even here few limestone outcrops are more than 100 m wide.

The second group includes limestones and dolomites of early and late Proterozoic age. They are commonly thick bedded and gray or white in color. In the western Arctic, they occur in the Coppermine series where they are interlayered with trap rocks and diabase; in the northeast they form an important component of the rocks in northern Somerset Island and on Borden Peninsula, Baffin Island. The beds are often steeply dipping and occasionally vertical as they are in eastern Prince of Wales Island. In these circumstances, they are associated with striking hogback landforms.

Paleozoic limestones and dolomites form the third group. They were deposited in Ordovician, and in the north, Silurian seas. At one time they covered a large part, if not all the northern Canadian Shield, but today are preserved only in basins and troughs in the Shield and have been removed from intervening swells and arches. The Paleozoic limestones vary from thin bedded, flaggy, and often argillaceous formations to massive beds several meters thick. Cherty limestones, dolomite, and less commonly, shale beds, are present.

Six major basins containing Paleozoic limestones have been recognized including Hudson Bay, Foxe, Mellville, Victoria Strait, Wollaston, and Jones-Lancaster Sound basins. Typically the sediments are about 1 km deep in the center of the basins. Around the margins the transition to the Shield rocks may extend over several miles, particularly where there is deep drift and limestone outliers; elsewhere the boundary is abrupt with limestone escarpments overlooking the Shield (Fig. 1).

Limestone landscapes in arctic Canada, like those developed on most other rocks, evolved their major elements prior to the final Pleistocene glaciation. They were further

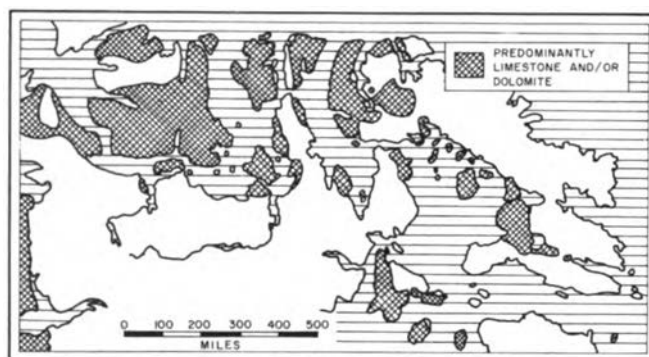

Fig. 1. Distribution of carbonate rocks in the Southern Canadian Arctic; clastic and volcanic rocks occur in a few areas; Precambrian limestone is not shown

modified during glaciation and have experienced other changes in the brief postglacial period. Limestones have been denuded more rapidly than the majority of rocks in the Arctic and today are primarily lowland rocks. For several geomorphic reasons, limestone uplands have survived around Barrow Strait and Lancaster Sound where there are extensive plateaus between 370 to 600 m above sea level [5]. Lower plateaus, 30 to 150 m, are found in the interior of many of the limestone plains.

Comparisons between the geomorphic and permafrost features of the limestone plains and plateaus, and between areas that experienced continental glaciation and others that escaped, make it possible to deduce the main characteristics of the arctic continental limestone terrains.

CHEMICAL WEATHERING

Limestone surfaces in most parts of the world are strongly affected by solution from ground and surface waters containing atmospheric carbon dioxide, soil bacteria, and decayed organic matter. The saturation equilibrium of carbon dioxide increases with decreased temperature so that at 0°C it is twice as great as at 25°C. Consequently, chemical weathering is greater in polar areas than in the tropics [6, 7, 8]. Bögl shows that the temperature-solution relationship is complex under natural conditions; the rates of limestone solution and limestone removal are not necessarily related and he believes that surface karst will develop more quickly under tropical conditions [9].

Surface karst is rare in northern Canada. Occasionally limited solution effects may be observed along joints and fissures; but solution has not proceeded quickly enough in the postglacial period of subaerial exposure, that varies from 6000 to 12,000 years above the limit of marine transgression, for the results to be conspicuous.

Fissure solution is confined to massive limestone beds where they outcrop on horizontal surfaces and form pavements. On Somerset Island these are crossed by solution-enlarged joints 7 to 15 cm deep. A more extensive pavement occurs on a low limestone plateau west of Wellington Bay, Victoria Island, that is covered with a rectangular fissure pattern. Solution fissures are not found on thin bedded limestones where mechanical weathering is the dominant process.

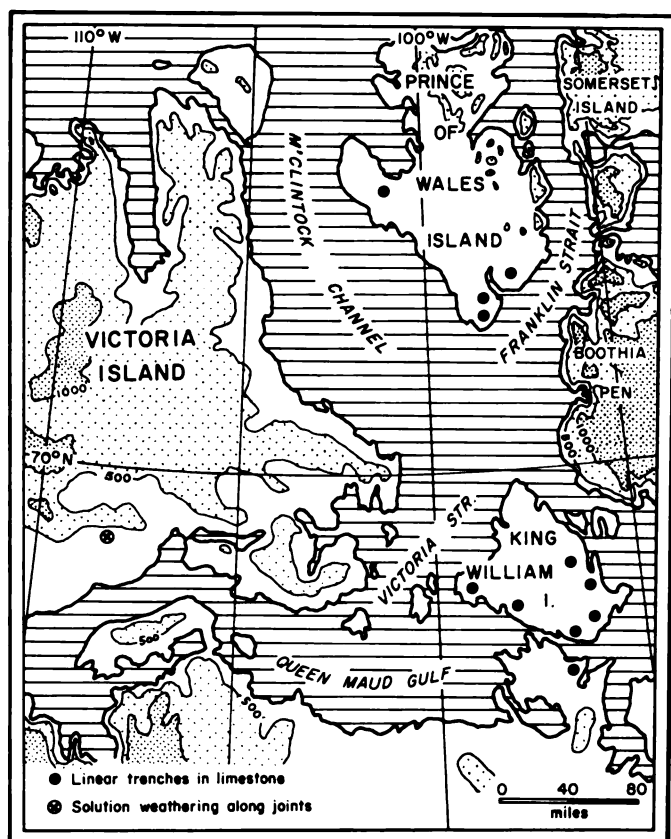

Fig. 2. Solution fissures and trenches in the Victoria Strait Basin

Large fissures occur at other points where they are associated with cambering; chemical weathering is, however, negligible. Such is the case along the limestone escarpment near Quillian Bay, Melville Peninsula, and in northeast Somerset Island.

Large trenches 5 to 20 m wide, 0.5 to 1.5 m deep and in some cases several hundred meters long, are found in limestone in the Victoria Strait Basin (Fig. 2). These trenches are partly filled with till and have been identified as preglacial solution fissures [10]. They may also be formed, however, by mechanical processes. Low ridges of shattered limestone have been observed at several localities in the Arctic including Melville Peninsula, Victoria Island, the Arctic mainland between Cape Kendall and Cape Krusenstern [11] and in North Greenland [12, 13], where they apparently develop from frost wedging along joints. If glacier ice subsequently removes the debris, the residual trenches would be comparable in dimensions to those in the Victoria Strait Basin.

Although solution by surface water in the Canadian Arctic is restricted, solution beneath snow is locally effective. Kauko has shown that the solubility of carbon dioxide in snow may be as much as 20 times as great as in water [14]. Maximum concentration is found after freezing and thawing at the snow surface [15]. Concentrated solution occurs on limestone surfaces that are snow covered during the thaw period, and this produces rough, etched rock with sharp ridges and pinnacles a few centimeters high (Fig. 3).

Solution from snow lying on bedrock is rarely a significant geomorphic process primarily because of the small number of limestone pavements; where they do occur, the results are often conspicuous. An exceptionally large area has developed near the Prince Regent coast of Brodeur Peninsula north of Port Neill where there is a corroded, naked rock zone several miles wide. Subnival solution occurs on limestone fragments but the effect is generally less evident, although close examination

often shows pitting and etching. Moisture that passes through frost-riven limestone plates dissolves calcite; this is re-deposited on the underside as travertine crystals. These crystals are widely distributed in the central and northern Canadian Arctic, but are uncommon in the south.

Under suitable conditions subnival solution may be concentrated beneath perennial snowbanks. There are indications that the nivation-type limestone hollows on Cornwallis Island [16] and elsewhere around Parry Channel may have formed in this way.

The rate of subnival solution on limestone has not been determined. Observations of strong solution effects are more numerous from the northern Canadian Arctic (where deglaciation occurred relatively early) than from the southern Arctic. The time factor should not be given undue prominence as solution effects are apparent on limestone pebbles of elevated storm ridges on both sides of Bellot Strait to within a few feet of the sea, suggesting (from the continuing crustal emergence) that under favorable conditions they will develop in one or two centuries.

The extent of surface solution from snow and, to a lesser degree, from other forms of surface moisture varies with the local environment. In southwest Southampton Island, pebbles on beach swales invariably show more solution effects than on the ridges. In lagoons the solution on pebbles is greater than either. In many cases, solution is greater with height—reflecting the longer period of exposure since emergence from the sea; but greater differences result from lithological variations in the limestone.

Many features in karst regions develop from solution by ground water. Permafrost restricts underground drainage and consequently modifies karst formation. In the subarctic where permafrost is discontinuous there may be large scale underground drainage when the limestone is jointed. Caves, large springs, and *naledi* have been described from the central Lena Basin under these conditions [17]. There are few observations from northern Canada. Brandon notes that in the Mackenzie Lowlands region of discontinuous permafrost, there is considerable ground water flow, some of which occurs along solution channels [18]. Karst features are rare. They are believed to occur in northern Alberta and may exist locally south of Great Bear Lake. No karst development is found in the Hudson Bay Lowlands, the other subarctic limestone region in Canada, probably because of the low altitude.



Fig. 3. Limestone pavement exhibits subnival solution surface and fissure widening

Underground flow under arctic conditions of continuous permafrost is rare. Corbel considers that it occurs in continental arctic limestone area [19], but little geomorphological evidence in northern Canada supports this view. In the limestone plateaus of northwest Baffin, Somerset, and Devon Islands, no springs have been observed issuing from the sides of gorges. As some of the gorges are more than 400 m deep, it is improbable that, if there is any quantity of ground water, none of it escapes as springs.

Springs are found occasionally elsewhere in limestone areas in the Canadian Arctic. On Southampton Island, several streams, the largest of which are Bursting and Unhealing Brooks in the south of the island, rise in springs that flow at least intermittently during the winter. The source of the water is probably talik in fluvio-glacial deposits and in deeply weathered limestone rather than in bedrock. Most streams are undoubtedly fed solely by surface water and dry up as soon as the spring runoff is complete; streams in limestone areas are consequently often intermittent. In the southern Arctic where vegetation on limestone is locally continuous and where lakes are numerous, there may be some surface storage contributing to stream flow; in the far north perennial snow banks similarly may provide water throughout the summer, but in many limestone areas the smaller stream channels are dry, except in the spring and after rain.

Underground drainage is commonly marked by sink holes in karst regions. The only sink holes in stream beds (swallow holes) reported from the Canadian Arctic were found on Akpatok Island where they are up to 5 m wide [20, 21]. Disappearing streams from other causes are not unknown in northern limestone areas and have been observed on Victoria, Somerset, and Southampton Islands. They result from small streams passing onto deeply weathered limestone and flowing at the bedrock-mantle interface instead of on the surface. The fact that identical phenomena are observed on felsenmeer developed on noncalcareous rocks is sufficient evidence that it is not a karst feature.

Solution hollows are not found although ponds in many limestone areas resemble them. Field inspection shows that they are forms of thermokarst: Smooth-sided ponds and lakes develop when local thawing of ground ice is followed by wave action on unconsolidated sediments.

Limestone caves are rare in the Canadian Arctic. They are found in modern cliffs near Leyson Point, Southampton Island, where they are developing by marine action. In northwest Somerset Island, rivers flowing in gorges are eroding caves on the outside of bends. In neither area is solution visible.

The conclusion is inescapable that under continental arctic conditions, in areas that were glaciated, and where there is continuous, deep permafrost, karst landscape due to chemical weathering has not developed. Where karst is found in northern subarctic areas, it may be contemporary but at least in unglacierized areas, it may also be a relic feature.

MECHANICAL WEATHERING

In dry arctic environments special landforms in limestone and other sedimentary rocks are primarily a consequence of mechanical weathering believed to be associated with frost riving. The process may commence evenly over a horizontal rock surface or may be localized initially along joints. In the latter case it leads occasionally to long, low ridges of shattered rock. The size of the fragments is linked closely with the lithology of the limestone; felsenmeer develop extremely rapidly when the rock is thin bedded and flaggy, such as is common in the central Canadian Arctic (Fig. 4).

Development is slower on thicker bedded rock and is non-existent or is restricted to flaking in massive limestone. The variety of fragments in size and shape are practically endless. Near The Points, Southampton Island, dolomitic limestone plates formed postglacially average 1 m in the long diameter; in contrast, limestone particles south of Amadjuak Lake, Baffin Island are initially 2 to 3 cm in diameter and quickly disintegrate further, and at Batty Bay in east Somerset Island, limestone plates are locally paper thin.



Fig. 4. A limestone felsenmeer north of Prince of Wales Island, 50-75 cm deep, developed in the postglacial period; sorting has occurred, and fines are concentrated in poorly defined circles

The extensive distribution of limestone felsenmeer in areas that experienced Pleistocene continental glaciation suggests rapid postglacial weathering, but this conclusion is not always easy to substantiate. Preliminary measurements on emerged pavements on the west coast of Southampton Island show that mechanical weathering on thin-bedded limestone has attained depths of 15 to 30 cm in 1000 years. At Mount Oliver, in southeast Somerset Island, weathered limestone 1.5 to 3.0 m deep has developed in postglacial time, estimated to be roughly 9000 years.

If mechanical weathering results from frost scattering as the rock temperature fluctuates near freezing point, it will progress indefinitely under arctic conditions as the annual temperature cycle is wholly below 0°C beneath the permafrost table. On a rock surface experiencing active weathering the permafrost table is at first in the bedrock below the frost-riven plates. With growth of the rock mantle, the permafrost table tends to sink as air and particularly ground water circulate in the shattered rock; an equilibrium state will be reached when the base of the weathered mantle coincides with the permafrost table. Investigations to test this deduction by determining the thermal condition of the near-surface were unsuccessful on Southampton Island in 1956, because of difficulties experienced in inserting instruments in deep limestone felsenmeer [22].

Once a deep limestone felsenmeer has formed, subsequent changes are restricted to progressive reduction of fragment size. Laboratory and field studies [23, 24] have shown that rock particles continue to disintegrate until a minimum size varying from 1 to 6 μ , depending on the rock type, is reached. The process is accelerated by frost churning that raises the larger particles to the surface. In general it follows that the older the felsenmeer the smaller the mean particle size. In the brief postglacial period reduction of the initial frost-shattered limestone has not proceeded very far. Differences in particle size distribution between limestone felsenmeer close to sea level, that formed recently as the land emerged from the sea, and those that were exposed earlier at higher levels as the ice retreated, are due to differences of lithology rather than age. Residual surface deposits on limestone that survived the last continental glaciation unmodified are not known with certainty from the Canadian Arctic.

On the limestone plateaus on both sides of Parry Channel, the surface deposit is a silt rubble containing fragments up to boulders in size. The area was glacialized, but mainly by local rather than continental ice. The preglacial weathered mantle apparently survives with little change except for the addition of occasional erratic blocks. In these plateau areas, the landscape is in striking contrast to lowland limestone areas. Slopes are long, smooth, and gentle, the bedrock being buried except for occasional rock ledges. Mass transportation is considerable but results more from rill wash on

the vegetation-free surface than from solifluction. In spring the ground frequently has the consistency of semiliquid mud and it may be impossible to cross on foot; in the summer, except after rain, it is brick-hard. The permafrost table is rarely more than 25 cm below the surface.

Limestone felsenmeer have consequently very different terrain and permafrost properties depending on the stage of development from early forms with dry surface conditions, soil stability and lowering permafrost table to a late stage of alternating wet and dry conditions, instability, and high permafrost table.

A PERIGLACIAL LIMESTONE CYCLE OF EROSION

Many arctic limestone landscapes are readily assigned to various stages of a theoretical erosion cycle. One group develops from limited uplift of an initial surface by a few tens of meters. Although this type is widely distributed in the Canadian Arctic, landscape elements resulting from glaciation and marine transgression dominate these areas. A second group has evolved on an initial surface about 400 m above sea level. This includes those areas where the scenery has developed on the Barrow



Fig. 5. Intense frost riving and talus formation in limestone of North Somerset Island led to the disappearance of the free face; surface deposit in the foreground is a till with the coarse component concentrated near the surface



Fig. 6. Changes of limestone slopes with time on Lake Amadjuak, Baffin Island; the left side of the cliff has several free faces with intervening talus; waste is being removed from the base by wave action; on the right, wave action halted about 6000 years ago, and since then deep weather and solifluction have been dominant

Upland Surface on Devon, eastern Cornwallis, northwest Baffin, Somerset, and eastern Prince of Wales Islands [5]. Far from the sea, where rejuvenation has not occurred, the initial streams flow in wide, shallow valleys inherited from the previous cycle in which the valley sides are buried with debris and the stream beds are choked with boulders.

Rapid incision begins along the coast and spreads quickly inland leading to three distinct sectors in the landscape. The upper section and the wider interfluvies are in the unchanged initial stage. In the middle section the rivers have numerous falls and rapids controlled locally by bedding planes in the limestone; the valley floor is littered with shattered and fallen rock, and the valley sides are deeply weathered with some scree. The lower section of the valley has a flat, often braided floor; the sides are steep but are rapidly modified by weathering and may be so rotten that they are impossible to climb, and it is dangerous to walk beneath them because of falling blocks. Valley sides formed partly of rock faces and partly of scree decline until the composite slope is replaced by a talus slope (Figs. 5 and 6). Once the rock face is buried, retreat of the valley side is less rapid; without a supply of fresh scree, talus fragments weather, and transportation by rock falls and talus creep is replaced by rock creep in which interstitial ice may play a significant part.

Ultimately, when the silt fraction increases, solifluction appears. Slopes continue to decline and by the solifluction stage are concave-convex with active weathering restricted to the upper slopes where the mantle is thin or absent.

Across the middle of the slope transportation is restricted to the active layer that is normally above the rock surface, and there is no denudation. In the concave sector, accumulation by rill wash and solifluction prevails. Areas with gentle to moderate slopes of this stage are found in the low hills of northern Prince of Wales Island and on the southern islands of the Queen Elizabeth Archipelago. In some parts of the Canadian Arctic, steep and even vertical slopes are retained late into the cycle. The Buttes area at the base of Borden Peninsula is a good example.

This brief examination of limestone terrains, particularly around Parry Channel where glacial influence has been small, suggests that it is possible to analyze polar limestone terrains as part of a continuing spectrum of changing slope, particle size, drainage, and permafrost conditions. Early in the sequence are ephemeral rock pavements of little relief but considerable surface runoff; later is a stage of maximum relief, coarse debris, and little surface water, and, finally, is a stage of low relief, gentle slopes, high clay and silt content in the mantle, high surface runoff and, from the engineering point of view, deteriorating permafrost conditions.

The theoretical, orderly sequence of landform evolution was disturbed in northern Canada by the Pleistocene glaciations and the associated lowland marine transgression. The former has affected all Arctic Canada although on plateaus, particularly around Parry Channel, and in the lowlands of the Queen Elizabeth Islands, modifications have been slight. The marine transgression was confined to areas below about 100 m in the northwest and 125 to 200 m elsewhere.

LIMESTONE TERRAINS

There are three main categories of arctic limestone terrains. In the first group are terrains found at all elevations that in the cyclic sense are youthful. The second group is restricted to areas invaded by the postglacial sea; the third group includes terrains developed on glacial drift.

Bare rock surfaces and felsenmeer form the first group. Extensive areas of the former are rare. In most uplands, outcrops are restricted to low limestone knobs several meters across that in many cases are shattered. Outcrops also occur in scarps and ledges and on the crests of low hills where the surficial mantle thins out. Occasionally, naked rock surfaces are more widely distributed as on the west coast of Brodeur Peninsula. In these situations the surface is often extremely rough due to chemical weathering.

True limestone felsenmeer are not common. Above the

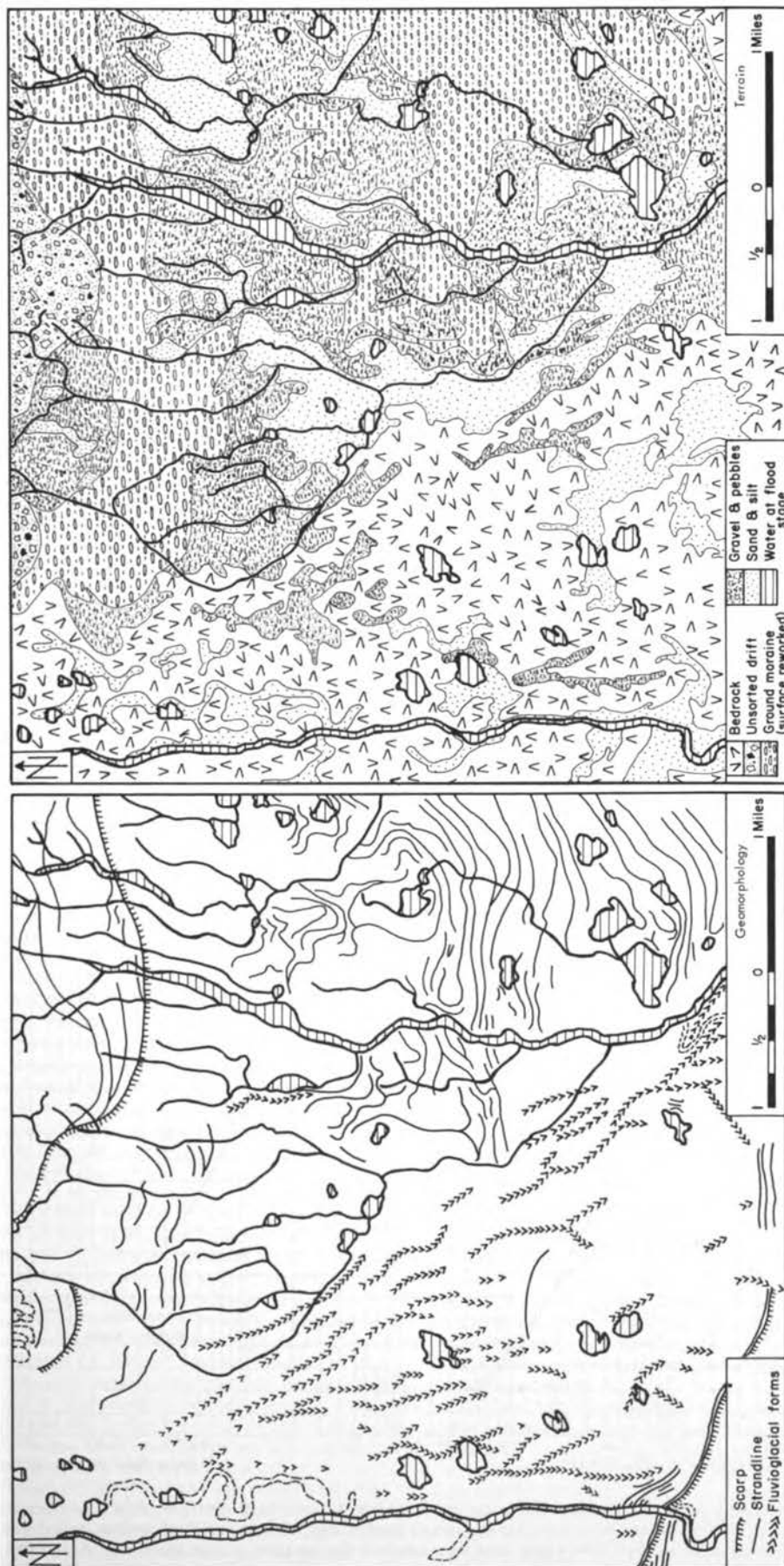

Fig. 7. Detail of geomorphology (left) and terrain (right) in the Coral Harbour Lowlands, Southampton Island. The whole area was transgressed by the postglacial sea except for two small sections in the north of the map (after Bronhofen)

marine limit this is primarily because glacial drift buries the rock surface and restricts physical weathering. At all elevations, but particularly below the marine limit, block fields that have developed from bedrock are difficult to differentiate from pseudofelsenmeer. The latter have evolved through frost shattering of boulders concentrated by frost or wave action at the surface from till. Limestone felsenmeer that contain patches of fines, often in the form of patterned ground, are rarely if ever true felsenmeer but have developed over glacial or marine clays that contain limestone boulders.

The greatest variety of terrains is found in the limestone lowlands below about 100 m where marine, glacial, and post-glacial residual deposits are intermingled (Fig. 7). The most characteristic features are marine ridges and bars constructed during the emergence of the land from the postglacial sea. On exposed slopes greater than about 3° elevated storm ridges are normally present. A favored site is on the sides of low plateaus that are widely distributed in limestone lowlands. In the majority of localities they have developed over bedrock that is rarely more than a meter below the surface. In some areas the limestone shingle has developed from weathered boulders concentrated on the surface of till or marine clays. From the surface indications, this situation is difficult to confirm unless clay plugs break through to the surface to form mud circles [25], or a natural section exists in a gorge. Whether the storm ridges are underlain by rock or clay, groundwater is often present at the base of the shingle during the summer. It may migrate downslope and can produce difficult icing conditions in underground structures.

Where the coastal slope is gentle, gravel and pebble bars form either along the shore or, in some cases, offshore. As the land rose during the postglacial period, a succession of ridges was formed, separated by depressions filled in summer by water or peat. The flatter the ground the more widely spaced are the ridges; in the extreme case where the ground is horizontal, they disappear entirely and a peat-covered plain overlying in some cases silt, and more generally limestone plates, is found. Ground ice forms at the base of the peat; arctic-type palsen with a clear-ice core and ice-wedge fissures are not uncommon. In the Koukdjuak Plain, western Baffin Island, the largest example in northern Canada, large

thaw lakes with weakly developed orientation have formed. There are many smaller limestone plains of this type including the Cape Kendall area of Southampton Island, Saputing Plain near Berlinguet Inlet, Baffin Island, and the east side of Rasumssen Basin.

In addition to marine landforms and peat-covered plains, the limestone lowlands contain more restricted areas of rock outcrops that occur in low cliffs and pavements and in some glacial deposits. When the latter are deep, they may have survived essentially unmodified through the marine phase; subsequent solifluction leads to smooth, rounded slopes. Glacial landforms become numerous far inland and toward the upper limit of marine submergence. In extreme cases limestone landscapes are dominated by glacial landforms far below the marine limit—as occurs in the drumlin fields of eastern Victoria Island and the interior of southern Prince of Wales Island.

Close to the marine limit there is a transition of terrains toward the main types that are characteristic of the zone above it. The properties and distribution of the rubble terrain, broken occasionally by scree and rock-sided gorges, have already been described. Till terrains above the marine limit often resemble rubble terrains (Fig. 8). Locally the coarser fragments, often with some weathering, are concentrated on the surface and associated with sorting patterned ground develops. The latter are typified by the Amadjuak and Nettilling Plateau surfaces in western Baffin Island with their long gentle solifluction slopes. Vegetation is absent except for scattered plant clumps. The permafrost table is high and practically all precipitation runs off the surface. The main differences from rubble terrains lie in the faint drumlinization, occasional fluvio-glacial deposits, and frequency of erratic boulders.

The main limestone terrains have, therefore, distinct characteristics that enable them to be distinguished readily on the ground and—once their complexity is recognized—on aerial photographs. Ultimately, their properties derive from the lithology, geomorphic history, and climate. They are essentially different from limestone terrains in other parts of the world, and nowhere does karst in the accepted sense of the term develop.

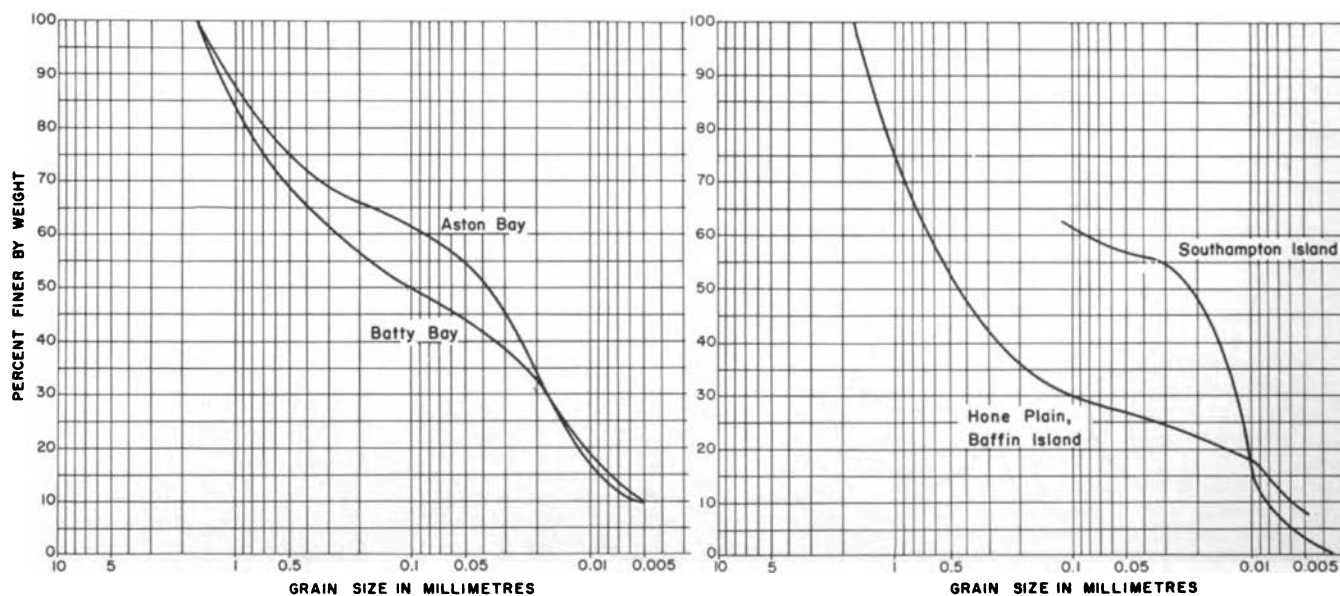

Fig. 8. Analysis of the grain size of upland limestone rubble on Somerset Island (left) and unsorted limestone till from above the marine limit (right). In all four samples the size-fraction larger than sieve 10 was removed in the field. The Hone Plain is believed to have been washed by glacial melt water and this may explain the smaller silt fraction. Southampton Island till and Somerset Island rubble are similar

REFERENCES

- [1] J. Cvijic. "Hydrographie Souterraine et Evolution Morphologique du Karst," *Rec. Trav. Inst. Géogr. Alpine*, Vol. 6, 1918, pp. 375-426.
- [2] A. Grund. "Der geographische Zyklus im Karst," *Z. Ges. Erdk. Berlin*, 1914.
- [3] H. V. Wissmann. "Der Karst der humiden heissen und sommerheissen gebiete Ostasiens," *Erdkunde*, Vol. 8, 1954, pp. 122-130.
- [4] H. Lehmann, K. Krömmelbein, W. Lötschert. "Karst-morphologie, geologische und botanische Studien in der Sierra de los Organos auf Cuba," *ibid.*, Vol. 10, 1956, pp. 185-204.
- [5] J. B. Bird. "Recent Contributions to the Physiography of Northern Canada," *Z. Geomorph.*, Vol. 3, 1959, pp. 151-174.
- [6] J. Corbel. "Vitesse de l'erosion," *ibid.*, pp. 1-28.
- [7] J. Corbel. "Morphologie périglaciaire dans l'Arctique," *Ann. Géogr.*, Vol. 70, 1961, pp. 1-24.
- [8] J. Corbel. "Erosion en terrain calcaire: vitesse d'erosion morphologie," *ibid.*, Vol. 68, 1959, pp. 97-120.
- [9] A. Bögli. "Kalklösung und Karrenbildung," *Z. Geomorph. Supp. Bd. 2*, 1960, pp. 4-21.
- [10] J. K. Fraser, W. E. S. Hennoch. "Notes on the Glaciation of King William Island and Adelaide Peninsula, NWT.," *Geog. Branch Paper 22*, 1959.
- [11] A. L. Washburn. "Classification of Patterned Ground and Review of Suggested Origins," *Geol. Soc. Am. Bull.*, Vol. 67, 1956, pp. 823-865.
- [12] W. E. Davies. "Polygonal Features on Bedrock, North Greenland," *U.S. Geol. Surv. Prof. Paper 424-D*, 1961, pp. 218-219.
- [13] W. E. Davies. "Surface Features of Permafrost in Arid Areas," *Geology of the Arctic*, Toronto, 1961, pp. 981-987.
- [14] Y. Kauko, L. Laitinen. "Die Kohlensäure-Sorption des natürlichen Schnees," *Suomen Kemistilehti*, Vol. 8B, 1935, p. 12.
- [15] J. E. Williams. "Chemical Weathering at Low Temperatures," *Geog. Rev.*, Vol. 39, 1949, pp. 129-135.
- [16] F. A. Cook, V. G. Raiche. "Simple Transverse Hollows at Resolute, NWT.," *Geog. Bull.*, No. 18, 1962, pp. 79-85.
- [17] S. S. Korzhuyev, S. S. Nikolayev. "Karst Types in Permafrost Regions and Features of Their Occurrence," (in Russian), *Izv. Akad. Nauk SSSR Ser. Geograf.*, No. 6, 1957, pp. 33-46.
- [18] L. V. Brandon. "Groundwater in the Permafrost Regions of the Yukon," North Cordillera and Mackenzie District, *Proc. 1st Can. Conf. Perm.*, 1963, pp. 131-139.
- [19] J. Corbel. "Hydrologie et morphologie des Nord-Ouest America," *Rev. Géom. Dyn.*, Vol. 8, 1957, pp. 97-112.
- [20] I. H. Cox. "The Physical Geography of Akpatok Island, in Clutterbuck, H. Akpatok Island, *Geog. J.*, Vol. 80, 1932, pp. 224-227.
- [21] N. Polunin. "The Vegetation of Akpatok Island," *Pt. I, J. Ecol.*, Vol. 22, 1934, pp. 337-395.
- [22] M. Bronhofer. "Field Investigations on Southampton Island and Around Wager Bay, NWT., Canada," *RAND Research Mem.* 1936, 1957.
- [23] I. C. McDowall. "Particle Size Reduction of Clay Minerals by Freezing and Thawing," *N.Z. J. Geol. Geoph.*, Vol. 3, 1960, pp. 337-343.
- [24] J. Dylik, T. Klatka. "Recherches microscopiques sur la désintégration périglaciaire," *Bull. Soc. Sci. Lett. Lodz Class III*, Vol. III, No. 4, 1952, pp. 1-12.
- [25] F. A. Cook. "Additional Notes on Mud Circles at Resolute Bay, NWT.," *Can. Geogr.*, No. 8, 1956, pp. 9-17.

PATTERNED GROUND IN ANTARCTICA

ROBERT F. BLACK and THOMAS E. BERG, University of Wisconsin

Patterned ground in Antarctica has been recognized for many decades and apparently is ubiquitous in most ice-free areas. Unfortunately, references in the literature to patterned ground in Antarctica are widely scattered in many languages and commonly are in publications either out of print or of very limited distribution. Moreover, one finds little standardization of terms, so the nature of the patterns is not clear in all instances. Early explorers had little time or incentive to dig into the minor patterns of the surficial rubbles when so much that was unknown surrounded them and beckoned them on; most later workers commonly are specialized in other fields and can little afford time for such phenomena. As a consequence, most references merely call attention to the presence of "soil polygons," "frost polygons," "tessellations," "soil strips," etc., and only brief observations of surface morphology permit an inference of their true classification and genesis.

This report attempts to cite the important later references to and some typical listings of patterned ground in continental Antarctica and immediately adjoining islands; it excludes the subpolar islands, except those of the Antarctic (Palmer) Peninsula. Earlier works included in bibliographies of later references are not listed for lack of space. Where possible, with reasonable certainty, original terminology of the various authors is converted to the standard of Washburn [1]. Because of the authors' interest and active research in ice-wedge and sand wedge polygons and their usefulness as age indicators, they are stressed. The field work of Black is confined to certain areas in Victoria Land; Berg has examined patterned ground in Victoria Land, at the head of the Beardmore Glacier, and at numerous localities on the Antarctic Peninsula. These studies have been financed by grants from the National Science Foundation, Office of Antarctic Programs.

CHARACTER AND DISTRIBUTION OF PATTERNED GROUND

Fig. 1 shows all locations where patterned ground has been reported. For convenience two categories of patterned ground are distinguished: (1) Nonsorted polygons, including ice-wedge and sand wedge polygons undifferentiated, and (2) sorted patterns, including circles, nets, polygons, steps, and stripes. Although nonsorted circles, nets, and steps may be seen locally, all known occurrences are so poorly defined and seemingly grade into the sorted circles, nets, and steps or into the nonsorted polygons that are better developed in the same locality that they are omitted specifically from this discussion. A special note is given under sorted patterns to some large possibly nonsorted stripes in Victoria Land. They are not shown separately in Fig. 1 because of their limited areal extent. It should be clear that most forms are gradational to others, and the classification is applied somewhat arbitrarily. Polygons in bedrock are common on bedding plane exposures of the Beacon sandstone and have surface morphology similar to those in rubbles. Rubble in addition to sand fills the wedges; they are genetically related to normal sand wedge polygons.

Of the two major groups outlined above, differentiation of the nonsorted polygons from the sorted circles, nets, and polygons is made conveniently by size. The former have diameters of many meters to tens of meters; the latter generally only centimeters to 2 or 3 m. Sorted steps and stripes are easily distinguished by form. Because of the large size and striking development of nonsorted polygons in Victoria Land, they have received more attention than other forms.

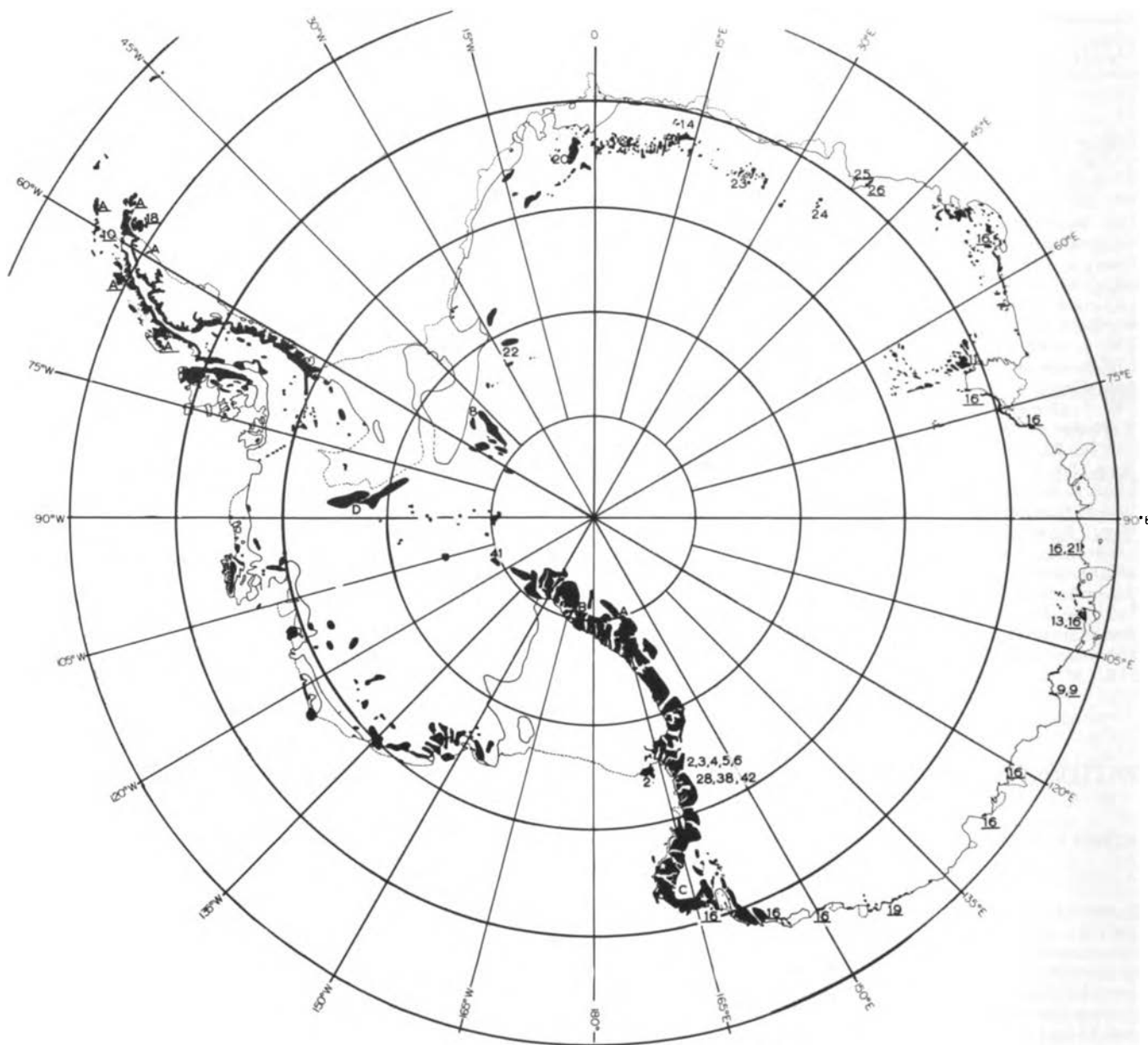

Fig. 1. Black areas on map of Antarctica represent bedrock. Patterned ground areas are shown by numbers from reference list—underlined numbers indicate sorted patterns, other numbers indicate nonsorted polygons. A, represents observations by Berg; B, represents aerial photographs; C, personal communication, Peter Bermel; D, personal communication, Robert Rutford

From Fig. 1, it is clear that most patterned ground along the outer fringe of the continent consists of sorted patterns whereas nonsorted polygons are more typical of Victoria Land and of the inland mountain ranges of the continent. The cause of this distribution is not fully understood. This and other problems are discussed later.

Information on altitudinal distribution of patterned ground in Antarctica is meager, but it warrants the generalization that no particular form is restricted to any altitude.

NONSORTED POLYGONS

Nonsorted polygons include ice-wedge and sand wedge polygons [2]. Many writers [e.g., 2 to 7] refer to their wide distribution in the ice-free lowlands of the McMurdo Sound region, and it is there that they have been most studied. Sand wedges and ice-wedges are two dominant end members between which mixtures with all proportions of sand and ice may be found locally [7]. Sand wedges characterize the

inland dry areas, whereas ice-wedges are more common along the more humid coasts and islands in the Ross Sea. Over-all, sand wedges and composites with less than 50% ice are most abundant. Nonsorted polygons result from annual fillings of thermal contraction cracks.

All such nonsorted polygons are commonly 4- to 6-sided in plan and 5 to 30 m in diameter (Fig. 2). In many places master polygons 20 to 40 m in diameter, as outlined by troughs 2 to 5 m wide and 0.3 to 1.5 m deep, are subdivided into halves, thirds, or quarters by narrower and shallower troughs. Beneath the troughs are wedge-shaped fillings of ice, sand, or mixtures of ice and sand with some stones; the apexes point downward. The fillings are in permafrost; textural variation of rubble in the permafrost and overlying active layer is abrupt to gradational. Wedges range from thin dikes a few millimeters wide to massive wedges up to 6 m wide and possibly 7 m high. Wedges 1 to 4 m wide and less than 5 m high seem most common.

It has been known for decades that ice-wedges go through

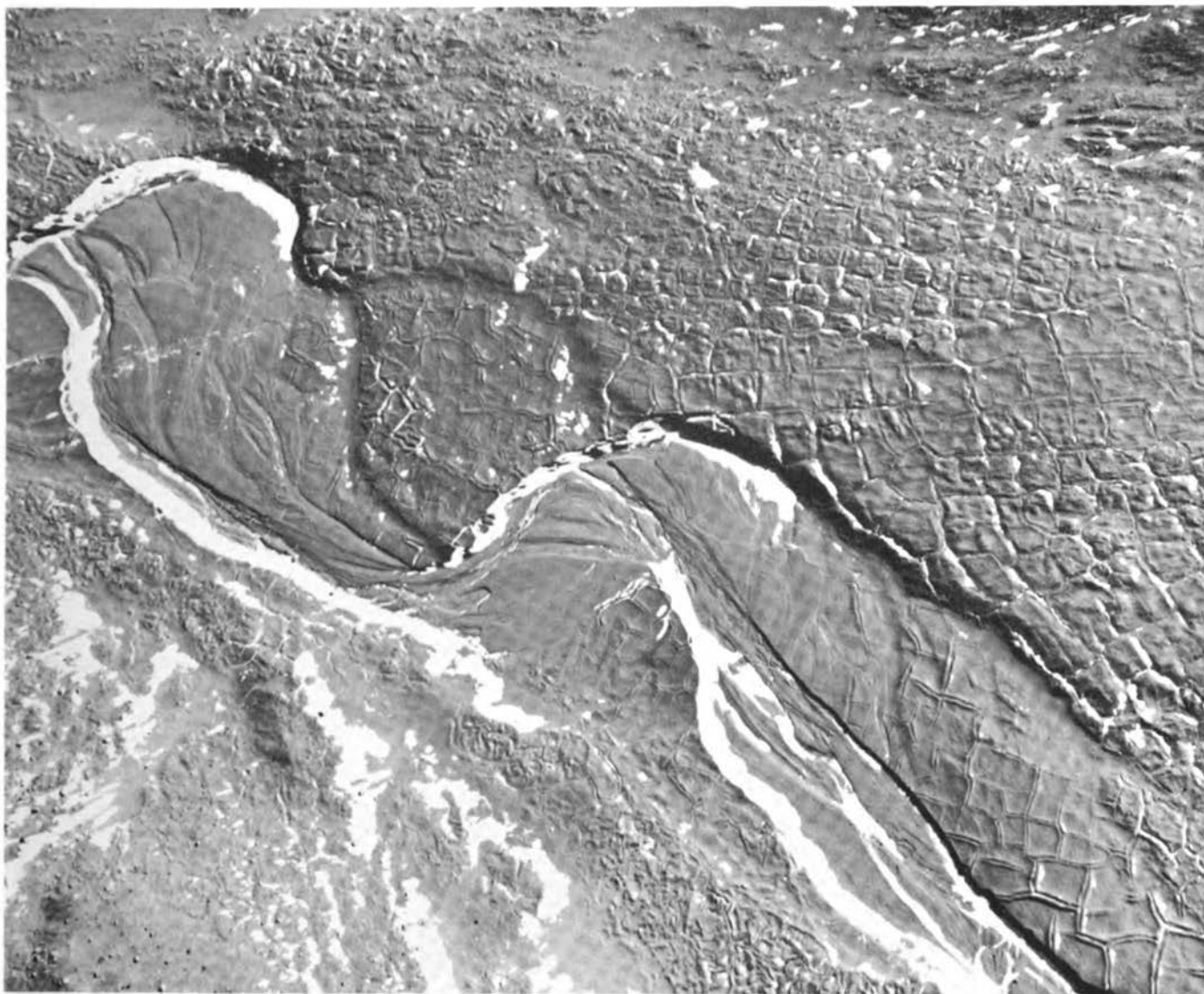

Fig. 2. Air view of nonsorted polygons in eastern Wright Valley, along and in Onyx River. Note range of surficial expression from youthful narrow troughs in the active floodplain, through the double raised rims adjacent to troughs in the older floodplain, to the older, wide troughs surrounding high centers in the older higher areas. Approximate scale in center of photo is 20 m per cm

a sequential development that permits one to interpret their age, and the same development, although more irregular, holds true for sand wedges [2, 7]. Their surficial expression at most places is a reflection of their age in the specific geomorphic setting (Fig. 2). Although generalizing is difficult, because of exceptions, most youthful wedges are expressed by narrow troughs of the same or slightly greater width than the underlying wedges (Fig. 3); old wedges commonly have troughs over them that bear only partial resemblance to the underlying wedges (Fig. 4). Centers of youthful polygons are not disturbed by the narrow wedges and commonly are flat. Centers of smaller, old polygons commonly are disturbed by growing wedges and range from flat- to high-centered. Intermediate wedges commonly are reflected by double raised rims adjacent to the sides of the underlying wedges which force material to the surface faster than erosional processes remove it. Spacing between rims may be less than, equal to, or greater than the width of the underlying wedge. Polygons with double raised rims generally have low centers. Actual surface expression varies tremendously from place to place because of (1) age of the wedges, (2) initial topography, (3) presence or absence of buried glacial ice, and (4) size distribution and moisture content of the

material in which they are found. For example, note the variety of polygons in Fig. 2 and contrast the trough in bouldery material of Fig. 4 with the sandy stream area in the first photograph.

SORTED PATTERNS

Sorted patterns, including circles, nets, polygons, steps, and stripes, are widely distributed in the active layer of ice-free areas of Antarctica and are not confined to any altitude [3, 8-26]. However, literature references to them indicate a greater abundance or better development along the outer coastal fringe of the continent. Even there, most references [e.g., 16, 21, 26] point out that the dryness of the soil or active layer and lack of vegetation prevent them from achieving the striking development so characteristic of many arctic regions. They may also go through a sequence of subdivision as in the Arctic [27]. The frost stirring that produces them is a complicated process. Most are small forms, only centimeters to 2 or 3 m in diameter for circles, polygons, or individual components of nets. They are a few centimeters to a few decimeters across for steps or stone stripes. However, stripes also may be many meters to tens of meters wide and



Fig. 3. Ground view of youthful nonsorted composite wedges, showing sand "runs" into last winter's contraction crack. Delta at northeast corner of Taylor Valley. Ice ax indicates scale

hundreds of meters long as in Victoria Land [3] (Fig. 5) and in the Prince Charles Mountains [11].

Not all sorted patterns are produced by the same processes. In the Prince Charles Mountains [11] sorted mounds of boulders and pebbles 45 to 60 cm high and 3 to 4 m from center to center are separated by strips of "finer grained materials." In the Dufek Massif [8] sorted polygons 1.5 to 3 m across have fines in elevated centers and cobbles and boulders on the sides. These elongate on hillsides into stone stripes. Sorted polygons and circles, 15 to 150 cm in diameter, are common over shallow permafrost (30 cm depth) in the South Shetland Islands [10]. Solifluction lobes result from thaw of buried ice [10]. Markov [16] shows excellent sorted polygons in his photo 6, a sorted circle in his photo 7, and well-sorted small (spacing estimated 5 to 25 cm) soil stripes in his photo 8, from Bunger Oasis and Sandefjord Bay in eastern Antarctica. Larger stripes, with spacing of 60 to 100 cm are reported from a knoll rising out of the lower Newall Glacier, Victoria Land [3]. The writers have seen locally in Victoria Land well developed sorted stripes with spacing of 20 to 200 cm and weakly developed sorted circles, nets, polygons, and steps. Berg's studies, however, indicate that the best development of sorted patterns may be expected on the Antarctic Peninsula.

An unusual occurrence of apparently nonsorted stripes in an area of reported tillite between Mawson and Mackay Glaciers,

Victoria Land, is produced apparently by wind. Wind rows of pebbles one layer thick are oriented normally to prevailing winds and are a few meters thick and several hundred meters long with separations of bare tillite several meters wide [3]. In several places in Victoria Land, the authors have seen from planes or in airphotos apparently nonsorted large stripes on steep slopes associated with large glaciers (Fig. 5). Little is known of their composition or genesis for none has been studied on the ground. They probably result from mass movements where strong winds and drifting snow modify and channel the slopes parallel to the strong winds [3, 22].

AGE AND SIGNIFICANCE OF PATTERNED GROUND

In spite of the lack of knowledge of growth rates of the various forms, patterned ground has been used by many writers as an age indicator. In the absence of quantitative data, such usage is reduced to expressions of faith. Otherwise how can we account for interpretations of age of literally decades to millenia for the same features [5, 28]? Patterned ground locally can be preserved beneath small inactive icefields [29] and perennial snowfields, but moving glacier ice would modify or destroy ice-wedge or sand wedge polygons. They cannot form beneath glaciers.

The preference of sorted patterns to lie on the outer fringe of the continent and of nonsorted polygons to dominate in



Fig. 4. Ground view of old sand wedge trough in bouldery moraine of Beacon Valley, Victoria Land. The sand wedge is 4 m wide and extends under the boulders on either side of the central sand zone (shovel marks right edge)

Victoria Land and interior mountain ranges seems clear. Generally the outer coastal fringe is more humid and is characterized by greater precipitation and greater depth of seasonal thaw than are in either Victoria Land or the interior mountain ranges. According to Berg's data, ice saturated soils contain generally 15% to 20% water by weight. However, soil moisture above about 8% in active layers, about 40 to 80 cm thick, aids sorting of unconsolidated materials, whereas lower soil moisture and thinner or thicker active layers do not. Except for the outer coastal fringe, most active layers are less than 40 cm thick. Permafrost is continuous, and seasonal temperature changes are more than ample to produce ice-wedge or sand wedge polygons in all the continent, including the coastal fringe. A paucity or lack of sand reduces or prevents sand wedge polygons; very low humidities and low moisture content (less than 3%) of the active layer in much of Victoria Land and in the interior mountain ranges favors sand wedge polygons over ice-wedge polygons and tends to reduce "frost action" that brings about sorting. According to the distribution of sorted polygons in wet areas near glacier termini, it seems likely that much more time is required to produce well developed nonsorted polygons than the sorted patterns. The latter are restricted to the active layer and seemingly need only years or decades to grow into obvious forms, whereas nonsorted polygons, except under very favorable conditions, require centuries or millenia to be

truly striking. Time, since deglaciation, may be a difficult factor to evaluate, except locally, in the light of present knowledge of the distribution and character of the various forms of patterned ground.

Theoretically ice-wedges will increase their growth rate with time as more and more ice is added to the ground, approaching a maximum rate where all the ground responds as does ice to temperature changes. Growth rates of sand wedges theoretically will diminish with time as loose sand is added to the ground, leaving small cores of ice-cemented material in the centers of polygons too small to crack under the seasonal temperature changes. All variations between may be expected as moisture content of the permafrost is changed with time. Most localities investigated to date in Victoria Land have active wedges—that is ice-wedges, sand wedges, and composite wedges are still growing today. Most wedges examined are composite, have mixtures of sand and ice, and are cemented so that contraction of permafrost permits cracking within the wedge.

Significantly, none of the wedges examined has ceased growing in width. This poses an anomalous situation with regard to the glacial chronology [30] proposed for Victoria Land. We can assume that permafrost has been present in Antarctica since deglaciation [31] except for local destruction by geothermal heat, marine inundations, ephemeral lakes and streams, and the like. No climatic change is indicated



Fig. 5. Large nonsorted stripes in Victoria Land. Nunatak in the vicinity of lat $76^{\circ}40'S$ and long $161^{\circ}30'$

throughout the Pleistocene sufficient to destroy permafrost or prevent its growth [31]. With permafrost, patterned ground would start immediately after deglaciation. Exempting local geomorphic complexities, polygons should go through their normal sequence of growth, reaching an equilibrium in the case of pure sand wedges at which growth ceases. It seems likely that a maximum width of some sand and composite wedges will be reached ultimately beyond which the width will not change even though contraction cracking and infilling of sand occurs in the center of a wedge. This point is reached when the wedge is so wide that shear and flow of material to the surface is accomplished within the wedge. Unfortunately, such mechanical deformation is not uniform from place to place or time to time; deformation is apparently dependent on rate of temperature changes which bring about closure of the crack (in other words, rate of stress), on the temperature of the material which flows or shears, on its moisture content as related to its texture, etc. Widths of 5 to 6 m may be of a general order beyond which sand wedges cannot grow even though they remain active; wedges approaching these dimensions are known. Ice-wedges theoretically can replace all unconsolidated ground with ice, but none approaching this stage is known; only very youthful ice-wedges (less than 2 m wide) have been seen in Antarctica.

The basic problem is to determine whether the areas with sand and composite wedges of maximum size have reached equilibrium or can no longer grow in width because of internal

flow and shear, thus eliminating them for dating purposes (except minimal), or whether their widths are still changing. This has not been accomplished in all instances examined to date. However, rates of growth of nonsorted polygons now being studied are known sufficiently to provide limits for the McMurdo Sound area [17, 32, 33]. Of 500 wedges measured in 1961-62 and 1963-64 at five sites, the average annual increase in width was 0.3 mm to 5 mm. Contraction is greatest where water content of permafrost is greatest, because coefficients of thermal expansion of ice are roughly five times that of rock. However, growth in sand wedges is achieved by infalling of debris into winter contraction cracks. An area of free flowing sand provides optimum material for growth—even greater than growth of ice-wedges where reversal of thermal gradients in spring moves moisture from the air and active layer into the open contraction crack. Growth of hoarfrost in contraction cracks also occurs in sand wedges in dry valleys but to a lesser degree. Presence of free running sand is required for pure sand wedges; many wedges are mixtures of sand and rubble. Strong temperature gradients and high local humidity are required for ice-wedge growth. Ice-wedges seem to grow more slowly on the average than many sand wedges, but perhaps more uniformly (about 0.5 to 1 mm per year).

Based on wedge growth of 0.3 to 1 mm per year, no locality of nonsorted polygons requires more than about 10,000 years to produce the wedges examined. Could all have developed

only since the climatic optimum dated in Antarctica between about 15,000 and 6,000 years ago [34]? If so, they are compatible with the youthfulness of lichens [35], the recent development of oases in east Antarctica [21], and the concept of deglaciation and formation of the dry valleys of Victoria Land resulting from rapidly rising sea levels beginning about 18,000 years ago rather than from climatic factors [36]. Some lateral moraines on valley sides, with dry surface zones 1.5 to 2 m thick, have no surface reflection of wedges and may be too old to date by this method.

Carbon 14 dates of mummified seal carcasses indicate ages of many centuries to several millennia [5, 37], of algae in kettles on ice-cored moraines of many millennia [5], and of marine mollusks in inland deposits of several tens of thousands of years [38]. Interpretation of these dates in support of great age for deglaciation and of a long Pleistocene glacial chronology of the dry valleys has been commonplace [5, 30, 38, 39, 40]. Such chronologies are several orders of magnitude too old according to the patterned ground. Some suggestion that the carbon 14 dates are much too old because of the different concentration of carbon 14 in Antarctic waters is offered by Broecker [5]. Further, the ancient shells even if correctly dated, provide only a date on their growth and not on the time of their transportation to their present site. This, too, presents some problems [38] that cannot be discussed here. No geomorphic event has been recognized which would suggest that patterned ground grew recently in much older glacial deposits. Patterned ground locally is being exhumed from beneath thick snow or thin inactive ice cover in accumulation basins at high elevations. Its distinctive geomorphic setting, surface morphology, and new wedge growth distinguish it from patterned ground whose growth has not been interrupted. However, wedges on the inner and outer sides of moraines of supposed pre-Wisconsin glaciations, for example, in Taylor Valley, differ only by centuries or a millennium, according to their widths and minimum measured growth rates. The authors recognize no patterns inherited from interglacial times in the large valley bottoms.

According to the patterned ground, many ice fronts in Victoria Land are as far advanced as they have been for several thousand years. Some fronts, such as Taylor Glacier in Beacon Valley, have been stable for 100 to 300 years. Others have advanced and some have retreated during the same interval. No consistent correlation of size of a glacier, or its position or altitude, has been made with stagnancy, retreat, or advance [33]. Most large glaciers have individual segments representing all three conditions, according to the marginal patterned ground and other phenomena. The general condition of equilibrium suggested by several writers [41] seems confirmed.

Patterned ground must also be correlated with other geomorphic processes and phenomena such as frost disaggregation, wind erosion and deposition, ventifacting, etc. [3, 30, 37, 41, 42], but they are beyond the scope of this discussion. In general they lack an adequate time scale or rate. One major problem, that of soil salts [16, 37, 43, 44] of calcium carbonate, mirabilite (hydrous calcium sulfate), chlorides, iodates, and others which are common and widespread in all ice-free areas of the Antarctic, needs mention. In places, deposits of those salts are cut by patterned ground, and salts also occur in wedge fillings. As large masses are found in the debris on ice-cored moraines and within the glacial ice, they must predate the ice advance involved. Active layers are today too thin and current weathering of surficial rubble too slight to provide the volume and variety of salts seen [37]. Preglacial accumulations from weathering, marine salts concentrated in different ways, and local hydrothermal emanations all seem likely sources for the initial salts [43]. No evidence of deep thaw or deep weathering is associated with the salts. They are now being moved in the active layer by capillarity [37] from water supplied by the melting of ice crystals. The ice crystals are added under strong thermal and vapor pressure gradients throughout the year [7]. The relationship of the salts to patterned ground is compatible only if old salts are being recycled.

REFERENCES

- [1] A. L. Washburn. "Classification of Patterned Ground and Review of Suggested Origins," Geol. Soc. Am. Bull., Vol. 67, 1956, pp. 823-866.
- [2] T. L. Péwé. "Sand-Wedge Polygons (Tessellations) in the McMurdo Sound Region, Antarctica—a Progress Report," Am. J. Sci., Vol. 257, 1959, pp. 545-552.
- [3] B. M. Gunn, G. Warren. Geology of Victoria Land between the Mawson and Mulock Glaciers, Antarctica, Trans-Antarctic Exped. Sci. Rept. No. 11, 1962.
- [4] B. C. McKelvey, P. N. Webb. "Geological Investigations in Southern Victoria Land, Antarctica," New Zealand J. Geol. Geophys., Vol. 5, 1962, pp. 143-162.
- [5] T. L. Péwé. "Age of Moraines in Victoria Land, Antarctica," J. Glaciol., Vol. 4, 1962, pp. 93-100.
- [6] I. G. Speden. "Post-Glacial Terraces near Cape Chocolate, McMurdo Sound, Antarctica," New Zealand J. Geol. Geophys., Vol. 3, 1960, pp. 203-217.
- [7] R. F. Black, T. E. Berg. "Hydrothermal Regimen of Patterned Ground, Victoria Land, Antarctica," Intl. Assn. Sci. Hydrology, Com. Snow and Ice, Pub. 61, 1963, pp. 121-127.
- [8] N. B. Aughenbaugh. "Preliminary Report on the Geology of the Dufek Massif," Reports of Antarctic Geological Observations, 1956-1960, IGY Glaciol. Rept. No. 4, pp. 155-193.
- [9] R. L. Cameron. Wilkes Station, 1957-1958, Ohio State Univ. Research Foundation Rept. 825-1, Pt. 3, 1959, pp. 2-27.
- [10] A. Corte, A. L. Somoza. Algunas observaciones geológicas y criopedológicas en la Antártide, II. Observaciones criopedológicas y glaciológicas en la isla Deception, Media Luna y Melchior, Inst. Antártico Argentino Publ., No. 4, 1957, pp. 63-131.
- [11] P. W. Crohn. "A Contribution to the Geology and Glaciology of the Western Part of Australian Antarctic Territory," Australia Bur. Min. Res., Geol. & Geophys., Bull No. 52, 1959.
- [12] N. F. Grigoriev. "Cryogenic Phenomena in Eastern Antarctica" (in Russian). Sov. Antarctic Expedition Rept. No. 10, 1960, pp. 321-323.
- [13] N. F. Grigoriev. Formation of the Relief and Frozen Ground of the Coastal Regions of Eastern Antarctica (in Russian). Acad. Sci. USSR, Moscow, 1962.
- [14] G. V. Konovalov. "Geomorphological Characteristics of Schirmacher Oasis and Its Neighborhood" (in Russian), Bull. Soviet Ant. Expedition, No. 37, 1962, pp. 8-13.
- [15] K. K. Markov. "Some Data on the Periglacial Phenomena in the Antarctic (preliminary report)," Accounts and Materials of the Complex Antarctic Expedition of the Academy of Sciences, USSR (in Russian), Acad. Sci. USSR, Moscow, 1956, pp. 47-54.
- [16] K. K. Markov. "Zonalité des phénomènes periglaciaires en Antarctide," Biuletyn Peryglacjalny (Lodz), No. 8, 1960, pp. 43-48.
- [17] K. K. Markov, V. I. Bardin, A. I. Orlov. Physio-geographical Description of the Coastline of Eastern Antarctica (in Russian, English Summary), Moscow Univ., Moscow, 1962.
- [18] O. Nordenskjöld, L. Mecking. The Geography of the Polar Regions, Am. Geog. Soc. Spec. Pub. No. 8, 1928.
- [19] P. Perroud. "Cryopedology," Expedition en Terre Adélie, 1950-1952, Rapports Préliminaires Expéditions Polaires Françaises, ser. sci. 20, 1952, pp. 37-38.
- [20] V. Schytt. "Blue Ice-Fields, Moraine Features and Glacier Fluctuations," Glaciology II, Nor.-Brit.-Swedish Antarctic Exped.; 1949-52, Scientific Results, Vol. 4, 1961, pp. 183-204.
- [21] P. A. Shumskiy. "Reconnaissance in the Antarctic, 1956," J. Glaciol., Vol. 3, 1957, pp. 54-61.
- [22] P. J. Stephenson. "Patterned Ground in Antarctica," ibid., 1961.
- [23] T. Van Autenboer. "Quelques aspects géographiques des Sor Rondane, Terre de la Reine Maud, Antarctique," La Géographie Gand, No. 3, 1962, pp. 93-108.
- [24] Y. Yoshida. "Preliminary Report on Geomorphological Survey of the Yamato Mountains, East Antarctica," Antarctic Record (Tokyo), No. 13, 1961, pp. 3-6.

- [25] T. Yoshikawa, H. Toya. "Report on Geomorphological Results of the Japanese Antarctic Research Expedition, 1956-1957," *ibid.*, No. 1, 1957, pp. 1-13.
- [26] T. Yoshikawa, H. Toya. "Geomorphic Features of the East Coast of Lutzow-Holm Bay, East Antarctica," *ibid.*, No. 11, 1961, pp. 40-41.
- [27] C. D. Holmes, R. B. Colton. "Patterned Ground near Dundas (Thule Air Force Base), Greenland," *Medd. Om Gronland*, Vol. 158, 1960, pp. 1-15.
- [28] W. Blake, J. Hollin. "Recent Moraines of a Lobe of the Taylor Glacier, Victoria Land, Antarctica," *J. Glaciol.*, Vol. 3, 1961.
- [29] G. Falconer. "Patterned Ground under Ice Fields," *ibid.*, Vol. 4, 1962, pp. 238-240.
- [30] T. L. Péwé. "Multiple Glaciation in the McMurdo Sound Region, Antarctica," *ibid.*, Vol. 68, 1960, pp. 498-514.
- [31] E. J. Zeller, W. C. Pearn. "Determination of Past Antarctic Climate by Thermoluminescence of Rocks," *Am. Geophys. Union Trans.*, Vol. 41, 1960, pp. 118-121.
- [32] R. F. Black, T. E. Berg. "Dating with Patterned Ground, Victoria Land, Antarctica," (Abst.) *ibid.*, Vol. 44, 1963.
- [33] R. F. Black, T. E. Berg. "Glacier Fluctuations Recorded by Patterned Ground, Victoria Land," in press, SCAR Symp. on Antarctic Geology, Capetown, South Africa, 1963; Abst., *Polar Record*, Vol. 11, 1963, pp. 752-753.
- [34] J. L. Hough. "Pleistocene Lithology of Antarctic Ocean-Bottom Sediments," *J. Geol.*, Vol. 58, 1950, pp. 254-260.
- [35] G. A. Llano. "Antarctic Plant Life," *Am. Geophys. Union Trans.*, Vol. 40, 1959, pp. 200-203.
- [36] J. T. Hollin. "On the Glacial History of Antarctica," *J. Glaciol.*, Vol. 4, 1962, pp. 173-195.
- [37] R. L. Nichols. "Geologic Features Demonstrating Aridity of McMurdo Sound Area, Antarctica," *Am. J. Sci.*, Vol. 261, 1963, pp. 20-31.
- [38] C. Bull. "Quaternary Glaciations in Southern Victoria Land, Antarctica," *J. Glaciol.*, Vol. 4, 1962, pp. 240-241.
- [39] C. Bull, B. C. McKelvey, P. N. Webb. "Quaternary Glaciations in Southern Victoria Land, Antarctica," *ibid.*, Vol. 4, 1962, pp. 63-78.
- [40] R. L. Nichols. "Multiple Glaciation in the Wright Valley, McMurdo Sound, Antarctica," *Geol. Soc. Am. Spec. Paper No. 68*, 1962, p. 240.
- [41] J. H. Mercer. "Glacier Variations in the Antarctic," *Am. Geog. Soc. Glaciological Notes*, No. 11, 1962, pp. 5-29.
- [42] A. D. Allen, G. W. Gibson. "Outline of the Geology of the Victoria Valley Region," *New Zealand J. Geol. Geophys.*, Vol. 5, 1962, pp. 234-242.
- [43] R. F. Black, T. E. Berg. "Saline Discharge from Taylor Glacier, Victoria Land, Antarctica," in press, *J. Geol.*, 1965.
- [44] G. W. Gibson. "Evaporite Salts in the Victoria Valley Region," *New Zealand J. Geol. Geophys.*, Vol. 5, 1962, pp. 361-374.

PATTERNED-GROUND RESEARCH IN CANADA

FRANK A. COOK, Department of Mines and Technical Surveys, Canada

A review of periglacial phenomena in Canada was published by the author in 1959 [1] and later expanded for the First International Symposium on Arctic Geology held in Calgary, Alberta, Canada, 1960 [2]. This paper summarizes research in Canada since that time, and the extensive references given in the previous works are not duplicated.

DEVELOPMENT OF PERIGLACIAL STUDY IN CANADA

Patterned ground and other periglacial phenomena in Canada were not investigated until the opening of the Canadian North following World War II. Improved transportation and communication facilities gave natural scientists an opportunity to conduct reconnaissance studies over vast new areas where periglacial processes were still active. Publication then of Washburn's important papers [3, 4] strongly influenced the study of periglacial phenomena in Canada, particularly that of patterned ground. Examination of active forms dominates the field, with almost no study of fossil forms. There has been practically no attempt to assess paleoclimatological conditions from fossil forms, nor apply them to problems of Pleistocene stratigraphy.

In 1956 Canada became a member of the Commission on Periglacial Geomorphology of the International Geophysical Union [5], and has been represented at all succeeding symposia of the Commission [6, 7]. A national Canadian committee was formed in 1959 [8, 9]. Committee meetings were held in Quebec, Calgary, and Ottawa [10]. The main objective is to coordinate research in the field of periglacial geomorphology in Canada, including the study of patterned ground [11, 12]. In May, 1963, the Canadian committee sponsored a symposium at the annual meeting of the Canadian Association of Geographers held at Quebec on problems of mapping in periglacial areas. Two papers [13, 14] provided much useful discussion.

Recent research includes the following studies of patterned ground: Development of field techniques (including both instrumentation and quantitative analysis of data); and the documentation of data observations with its geographical

distribution, the effects of climate and rock type, and the regional analysis and mapping of periglacial forms.

Important research agencies are the Geographical Branch of the Department of Mines and Technical Surveys and the Division of Building Research of the National Research Council, Ottawa; the Arctic Institute of North America; and the universities—chiefly the McGill University sub-Arctic Research Laboratory at Schefferville, the Centre d'études nordiques à l'Université Laval, and the University of British Columbia.

RECENT RESEARCH

Williams has done considerable work at Schefferville and elsewhere on quantitative measurements of soil movement in frozen ground phenomena, such as solifluction. This includes the development of instrumentation for determination of sub-surface soil movements [15 to 19]. Haywood [20] and Andrews [21] reported on apparatus installed at Schefferville for measurement of frost heave. It consisted of six metal posts concreted to bedrock within a leveled horizontal frame 10.5 ft square. A crosspiece was bolted to the frame every 15 ft, with holes drilled through at intervals of 1.5 ft. Then 64 vertical rods were lowered through the frame, permitting measurement of heave over the area that had a variety of cover types. Considerable differential heaving was noted. Mathews and Mackay [22] described instrumentation developed to measure the snow creep on Mount Seymour, B.C., from 1958 to 1962. Preliminary results show displacements from 2 to 3.5 ft in a single winter within the bottom 3 to 6 in. This may be important in formation of some patterned ground forms, and in the movement of loose stones from bedrock areas.

Increasing attention has been paid to climatic factors controlling the distribution of certain frozen ground phenomena. Williams [23] found that:

- (a) The development of patterned ground and solifluction requiring deep annual frost penetration depends on the proximity of the mean annual (ground) temperature to 0°C rather than on the intensity of winter cold (the mean annual

air temperature of 3°C was suggested as marking a rough limit of their development.); (b) large-scale solifluction, requiring a deep-lying, still-frozen layer in the spring is restricted to areas with somewhat lower mean annual air temperatures (1°C is suggested as an approximate limit); and (c) variations in number of fossil forms of patterned ground and solifluction are to be related to the period of time during which conditions might have existed for the essentially slow movements of material involved. Sufficient experimental evidence has been provided [24] to conclude that alternating freezing and thawing is not necessary for frost heaving in certain clays.

The importance of freeze-thaw cycles in the active layer has interested workers in patterned ground for a considerable time. Many have assumed that these cycles are numerous in periglacial regions and are very effective in sorting processes of patterned ground. The number of cycles at Resolute, NWT, were found to be surprisingly small [25, 26]. In 1960, there were only 23 ranging from 28° to 32°F, 18 ranging from 28° to 34°F, and 7 ranging from 25° to 35°F. At depths below a few centimeters, only the annual cycle was recorded. Similar results [14, 27] were reported from Isachsen on Ellesmere Island. In analyzing work by Haywood, Andrews [21] noted that the annual frost cycle was the only significant cycle at Schefferville. The whole concept of mechanical weathering of the mantle due to frequent oscillations around the freezing point needs revising. It should be emphasized that in the Canadian Arctic, there are no cycles, apart from the annual cycle, at depths below a few centimeters, and it follows that assumptions still widely held among some geographers and geologists (that frost cycles are a vigorous process producing frost splitting at depths in arctic countries today) are not valid. St-Onge [27, 28] discussed the relationships between climate and rates of erosion of various rock types in Arctic Canada. Cook [29] observed that present methods of measuring rainfall in high arctic areas of scant rainfall fail to take into consideration the importance of trace days to geomorphic processes.

Previous inventories of periglacial phenomena, including patterned ground, were made by Cook [1, 2, 30]. In the past several years, reports have become more numerous, with a wider geographical distribution.

Among the major works have been the series of reports by the Rand Corporation, Santa Monica, prepared by the Department of Geography, McGill University. While they are broad physiographic descriptions, much data on patterned ground are included. Areas studied include north Baffin Island [31], central Baffin Island [32], southern Baffin Island [33], eastern Victoria Island [34], Great Bear area [35], Thelon River area [36], and the Quoiich River area [37].

The arctic regions of Canada continue to receive attention. Robitaille has noted patterned ground on Prince Patrick Island [38] and on Cornwallis Island [39]. Thorsteinsson [40] discussed forms on Meighen Island, and Smith [41] described soil patterns in the Lake Hazen region. References to periglacial phenomena in the north central district of Mackenzie were made by Craig [42]; and Bird [43] and Bird and Bird [44] have noted occurrences in central and southern Arctic Canada, especially in the Bathurst Inlet area, NWT.

Labrador-Ungava has received some consideration. Williams [45] has discussed the development and significance of stony earth circles in the Schefferville area. Roy [46, 47] related aspects of climate and postglacial relief at Schefferville and discussed patterned ground phenomena in Labrador-Ungava. Andrews [48, 49] compared the development of scree slopes in the English Lake district and central Labrador, and reappraised the work of Twidale [50] on "vallons de gélivation" in Labrador-Ungava. Andrews suggested that often frost action is given for the origin of many forms whose genesis was a very different process. Robitaille [51] completed a geomorphological survey of the Quebec shore of Hudson Bay, reporting on periglacial features in the area.

Hamelin [52] studied periglacial conditions in Canada; in

dealing with the aspects of process and chronology, he divided Canada into eleven periglacial provinces. The paper concludes with a glossary of new terms suggested for adoption. Hamelin and Clibbon [53] prepared a bilingual periglacial vocabulary (French-English) in an attempt to solve some existing problems in terminology.

CONCLUSIONS

Study of patterned ground in Canada is still in an early stage, having developed only since World War II. Study of active rather than fossil forms has been emphasized. Little attempt has been made to use data in paleoclimatological studies or in problems of Pleistocene stratigraphy. Most studies have been sponsored by the larger research institutions such as the Department of Mines and Technical Surveys and the National Research Council, Ottawa, the Arctic Institute of North America, and universities.

Inventory of periglacial phenomena is far from complete. Collaboration of geomorphologists with soil scientists, engineers, archaeologists, and others might be helpful. Available data on patterned ground are entirely inadequate for the mapping of regions or for correlations with climatic factors.

The concept of mechanical weathering of the mantle due to frequent freeze-thaw cycles needs revising, since results from Arctic Canada show that there are no cycles apart from the annual cycle at depths below a few centimeters.

REFERENCES

- [1] Frank A. Cook. "A Review of the Study of Periglacial Phenomena in Canada," *Geog. Bull.*, No. 13, 1959, pp. 22-53.
- [2] Frank A. Cook. "Periglacial Phenomena in Canada," *Proc. 1st Intl. Symp., Arctic Geol.*, Vol. 22, 1961, pp. 768-780.
- [3] A. L. Washburn. "Patterned Ground," *Rev. Can. Geog.*, Vol. 4, No. 3-4, 1950, pp. 5-59.
- [4] A. L. Washburn. "Classification of Patterned Ground and Review of Suggested Origins," *Geol. Soc. Am. Bull.*, Vol. 67, 1956, pp. 823-866.
- [5] L.-E. Hamelin. "La commission internationale de géomorphologie périglaciaire et le Canada," *Can. Geog.*, No. 13, 1959, pp. 14-17.
- [6] L.-E. Hamelin. "La commission de géomorphologie périglaciaire se réunit en Pologne," *Cahiers Géog. Québec*, No. 5, 1959, pp. 146-147.
- [7] L.-E. Hamelin. "La commission de périglaciaire au Maroc en 1959," *ibid.*, No. 7, 1960, pp. 212-217.
- [8] L.-E. Hamelin. Circulaire No. 1, Comité canadien commission de géomorphologie périglaciaire, Mimeo, 1960.
- [9] L.-E. Hamelin. "La commission de géomorphologie périglaciaire en 1960," Circulaire No. 2, *ibid.*
- [10] L.-E. Hamelin. "Réunion du Comité canadien du périglaciaire," *Rev. Can. Géog.*, Vol. 13, No. 3-4, 1959, pp. 211-212.
- [11] L.-E. Hamelin. "Projet de coordination des recherches périglaciaires dans l'Est canadien," *Cahiers Géog. Québec*, No. 3, 1957, pp. 141-142.
- [12] Frank A. Cook. "Geographical Branch Studies in Periglacial Geomorphology," *ibid.*, No. 7, 1960, pp. 209-212.
- [13] L.-E. Hamelin. "Geomorphological Mapping Applied to Periglacial Studies," (Annual Meeting, Can. Assoc. Geog., Québec, 1963).
- [14] Denis St-Onge. "Geomorphological Mapping," *ibid.*
- [15] P. J. Williams. "Some Investigations into Solifluction Features in Norway," *Geog. J.*, Vol. 123, pt. 1, 1957, pp. 42-58.
- [16] P. J. Williams. "Direct Recording of Solifluction Movements," *Am. J. Sci.*, Vol. 255, 1957, pp. 705-714.
- [17] P. J. Williams. "Frozen Ground Phenomena," *McGill sub-Arctic Research Lab.*, Paper No. 6, 1959, pp. 68-70.
- [18] P. J. Williams. "Solifluction Phenomena," *ibid.*, Paper No. 11, 1961, pp. 100-101.
- [19] P. J. Williams. "Quantitative Investigations of Soil Movement in Frozen Ground Phenomena," *Buletyn Periglacialny*, No. 11, 1962, pp. 353-360.

- [20] B.H.J. Haywood. "Studies in Frost-Heave Cycles at Schefferville." McGill sub-Arctic Research Lab., Paper No. 11, (ed. J. T. Andrews and E. M. Matthews), 1961, pp. 6-11.
- [21] J. T. Andrews. "Analysis of Frost-heave Data Collected by B.H.J. Haywood at Schefferville, Labrador-Ungava," Ann. Meeting Can. Assn. Geog., Québec, 1963.
- [22] W. H. Mathews, J. Ross Mackay. "Snowcreep Studies, Mount Seymour, B. C.: Preliminary Field Investigations," Geog. Bull., No. 20, 1963 (in press).
- [23] P. J. Williams. "Climatic Factors Controlling the Distribution of Certain Ground Phenomena," Geog. Ann., Vol. 43, No. 3-4, 1961, pp. 339-347.
- [24] E. Penner. "Alternate Freezing and Thawing Not a Requirement for Frost Heaving in Soils," Can. J. Soil Sci., Vol. 41, 1961, pp. 160-163.
- [25] Frank A. Cook. "Periglacial Geomorphological Investigations at Resolute, 1959," Arctic, Vol. 13, No. 2, 1960, pp. 132-134.
- [26] Frank A. Cook, V. G. Raiche. "Freeze-thaw Cycles at Resolute, NWT.," Geog. Bull., No. 18, 1962, pp. 64-78.
- [27] Denis St-Onge. "La géomorphologie L'île Ellef Ringnes, T.N-O." D.S. thesis, Univ. Louvain, 1963.
- [28] Denis St-Onge. "A Note on Erosion in Gypsum under Periglacial Conditions," Rev. Can. Géog., No. 3-4, 1959, pp. 155-162.
- [29] Frank A. Cook. "Rainfall Measurements at Resolute, NWT.," ibid., Vol. 14, No. 1-4, 1961, pp. 45-50.
- [30] Frank A. Cook. "Selected Bibliography on Periglacial Phenomena in Canada," Department of Mines and Technical Surveys, Geographical Branch, Biblio. Ser., No. 24, 1960.
- [31] Rand Corp. Rept., Santa Monica (by McGill Univ.), "Physical Environment of Northern Baffin Island and Adjacent Areas, NWT.," 1963.
- [32] Rand Corp. Rept., "Physiographic Conditions of Central Baffin Island and Adjacent Areas, NWT.," 1963.
- [33] Rand Corp. Rept., "Physical Environment of Southern Baffin Island, NWT.," 1963.
- [34] Rand Corp. Rept., "Physiographic Conditions of Eastern Victoria Island and Adjacent Areas, NWT.," 1963.
- [35] Rand Corp. Rept., "Physical Environment of the Great Bear River Area, NWT.," 1963.
- [36] Rand Corp. Rept., "Physical Environment of the Thelon River Area, NWT.," 1963.
- [37] Rand Corp. Rept., "Physical Environment of the Quoiich River Area, NWT.," 1963.
- [38] Benoit Robitaille. "A Geomorphological Map of the Mould Bay Area, Prince Patrick Island, NWT.," Can. Geog., No. 15, 1960, pp. 39-43.
- [39] Benoit Robitaille. "Géomorphologie du sud-est L'île Cornwallis, T.N-O.," Cahiers Geog. Québec, No. 8, 1960, pp. 359-365.
- [40] R. Thornsteinsson. "The History and Geology of Meighen Island, Arctic Archipelago," Geol. Survey Can., Bull. 75, 1961.
- [41] D. I. Smith. "The Geomorphology of the Lake Hazen Region, NWT.," McGill Univ., Misc. Papers, No. 2, 1961.
- [42] B. G. Craig. "Surficial Geology of North-central District of Mackenzie, NWT., Canada," Geol. Survey Can., Paper 60-18, 1960.
- [43] J. Brian Bird. "Scenery of Central and Southern Arctic Canada," Can. Geog., No. 15, 1960, pp. 1-11.
- [44] J. Brian Bird, M. B. Bird. "Bathurst Inlet, NWT.," Dept. Mines Tech. Surveys, Can., Memoir No. 7, 1961.
- [45] P. J. Williams. "The Development and Significance of Stony Earth Circles," Natl. Res. Coun., Can., Res. Paper No. 91, 1960.
- [46] Camille Roy. "Aspects du climat et du relief post-glaciaire de la région de Schefferville dans le Québec-Labrador," priv. comm.
- [47] Camille Roy. "Les phénomènes périglaciaires du Labrador-Ungave Central," McGill sub-Arctic Research Lab., Res. Paper No. 11, 1961, pp. 46-53.
- [48] J. T. Andrews. "Development of Scree Slopes in the English Lake District and Central Labrador," Cahiers Géog. Québec, No. 10, 1961, pp. 217-230.
- [49] J. T. Andrews. "'Vallons de gélivation' in Central Labrador-Ungava: a Reappraisal," Can. Géog., Vol. 5, No. 4, 1951, pp. 1-9.
- [50] C. R. Twidale. "Vallons de gélivation dans le centre du Labrador," Rev. Géomorph. Dynamique, No. 1-2, 1956, pp. 18-23.
- [51] Benoit Robitaille. "Aperçu géomorphologie de la rive québécoise du détroit Hudson," Rev. Can. Géog., Vol. 13, No. 3-4, 1959, pp. 147-155.
- [52] L.-E. Hamelin. "Périglaciaire du Canada: idées nouvelles et perspectives globales," Cahiers Géog. Québec, No. 10, 1961, pp. 141-203.
- [53] L.-E. Hamelin, Peter Clibbon. "Vocabulaire périglaciaire bilingue," ibid., No. 12, 1962, pp. 201-226.

Published with the permission of the Director, Geographical Branch, Department of Mines and Technical Surveys, Ottawa.

EXPERIMENTS ON SORTING PROCESSES AND THE ORIGIN OF PATTERNED GROUND

ARTURO E. CORTE, Universidad del Sud, Bahía Blanca, Argentina

SORTING INTO DEPRESSIONS

Local variations in frost heave of soils can be expected to produce mounds and depressions which can affect sorting. Field and laboratory experiments have been performed in order to observe sorting by gravitation into depressions and from mounds caused by differential ice melt, but not all sorting processes are represented in this paper. Many references cite experiments executed in the U. S. Army laboratories of Snow, Ice, and Permafrost Research Establishment (SIPRE), and Cold Regions Research and Engineering Laboratory (CRREL).

Sorting Caused by Differential Melt of Glacier Ice

These experiments were planned to understand the origin of sorted features formed in a layer of gravel over the glacier ice [4]. This kind of sorting was studied by observing the behavior of different thicknesses of gravel overlying a melting ice surface [5]. Outdoor experiments were performed over the glacier ice in Thule, Greenland.

The slope of ice surface and thickness of gravel cover were changed in different test areas. Sorting was produced after 44 days of ice melting (Figs. 1, 2). The experimental formation of sorted nets and stripes in a layer of gravel of varying thickness on the icecap demonstrates that sorting was produced upon collapse of portions of the layer because of differential melting of the underlying ice. Concentration of coarse material in the melt stream channel cut into the ice is the result of both mechanical sorting and washing out of the finer fraction.

A test area, used as a standard of uniform thickness of gravel over a smooth ice surface, did not develop sorted nets—indicating that differences in insulation are necessary to produce sorted nets. As suggested [4], differential heat diffusivity of coarse and fine particles might cause the formation of certain sorted patterns over the ice. However, in this experiment the gravel cover was well mixed; differential melt was caused by variations in thickness of the insulating gravel. Therefore, differential heat diffusivity from point to point was believed to be negligible and, consequently, not a primary



Fig. 1. Sorted gravel found on glacier ice in Thule, Greenland



Fig. 2. Sorting produced experimentally after 44 days of melting by an uneven layer of gravel over glacier ice

factor in the formation of these experimentally produced patterns. Further experiments must determine whether the depressions in the ice under stone rings can be explained by differential heat diffusivity, by melt streams flowing more easily through coarse material, or by a combination of these processes.

The following conclusions are derived from these experiments:

1. Varying thicknesses of a layer of gravel produced differential melting of the underlying ice. Coarse particles set up in motion by collapse of the gravel cover are concentrated mechanically into depressions.
2. Sorted nets and stripes produced experimentally were similar to those occurring naturally in the gravel covering the edge of the icecap. (Figs. 1, 2). Therefore, formation of natural patterns is believed to start by differential melting under a gravel cover of nonuniform thickness.
3. Mechanical sorting from mounds formed by differential ice growth and formed into depressions by differential ice melt should be considered in the development of sorting in the freeze-thaw layer.

Sorting into Desiccation and Other Cracks

The sorting effect of rain and wind into desiccation cracks is

important because sorting is a cold climate indicator [1]. Later reports, however, show that sorting into desiccation cracks exists in areas without frost [6] and in the active layer [8].

Basic conditions for cracking were studied first, then the effect of rain and wind on sorting in the desiccation cracks [8]. The most important conclusions are:

1. The moisture content when cracking occurs increases with increase in soil thickness, but it is not affected by underlying material.

2. Area of cells made by the crack pattern has a log normal size distribution. Mean size of cells depends on thickness of soil as

$$S = ad^b$$

where (S) is mean size, (d) is thickness, and (a) and (b) are positive constants that depend on bottom material and dry density.

3. Total length of cracks decreases with increase in soil thickness as

$$L = bd^{-e}$$

where (L) is total length of cracks, (d) is thickness, and (b) and (e) are constants that depend on bottom material and dry density.

4. The number of cell sides depends also on thickness of the drying layer.

5. A soil layer on a sand bottom makes large cells.

Adhesion at the bottom is very slight because the layer of sand attached to the soil bottom rolls over the sand below.

The following are considerations with regard to sorting into desiccation cracks:

- (a) Stones located in a drying layer are loci where cracks start. This property varies with the porosity and geometry of the stones.
- (b) Wind and rain concentrate particles into desiccation cracks. The particle size carried depends on the water, wind speed, and adhesion of the particles to the soil.
- (c) For particles to concentrate into desiccation cracks, the soil should repeatedly crack in the same place. Once particles get into the cracks, cracking in the same place is more likely (Fig. 3).
- (d) For the repetition of a crack pattern, soil layer should be thoroughly wet. This happens when the soil layer is wetted by a melting snow or a temporary lake.

The degree to which a desiccation pattern from sorting by wind and rain can be affected by freezing and thawing is not known. Cross sections in perfectly sorted desiccation poly-



Fig. 3. Particles sorted into desiccation cracks near Fox River, Illinois. New cracks replace old ones, where particles are concentrated. The particles accumulated into the cracks increase from left to right, where more particles need sorting



Fig. 4. Elongated sorted desiccation cracks in the Laguna Diamante area at 3300 m above sea level at Mendoza, Argentina

Fig. 5. Cross sections through sorted desiccation cracks at Mendoza, Argentina, reveal lack of frost features (plications and involutions) below the desiccation cells



Fig. 6. Vertical sorting in the active layer at Thule, Greenland. The scale rests at 30 cm below permafrost

gons in the high Andes [7] (Fig. 4) do not show frost action effects such as plications, involutions (Fig. 5), etc., indicating that the freeze-thaw cycles are not strong enough to disturb the desiccation pattern. More work along this line is recommended. Sorting into other cracks (tension cracks, tractor cracks, and similar depressions) were also observed.

Information on sorting into thermal contraction cracks or thawing ice-wedges is lacking. Field work of this type is recommended.

SORTING BY REPEATED FREEZING AND THAWING

Of all sorting processes in nature, freeze-thaw action seems to be the most important. It is reasonable to assume that downward and lateral freeze-thaw must be the prevailing freezing and thawing directions.

Sorting by Lifting

Experiments performed by freezing and thawing from the top indicate that particles are sorted by lifting. Experiments with different shaped particles indicate that the geometry of the particle affects the rate of movement. Coarse particles move

Fig. 7. Three-dimensional section in a boulder field in the Thule area, Greenland, showing vertical sorting.



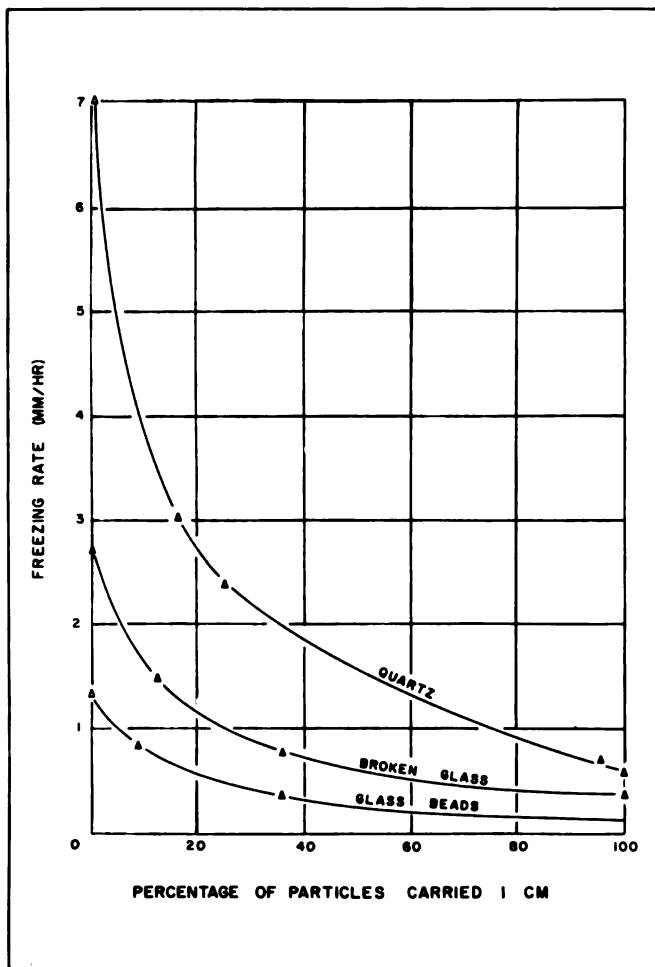

Fig. 8. Amount of particles carried 1 cm by a moving freezing plane as a function of rate of freezing

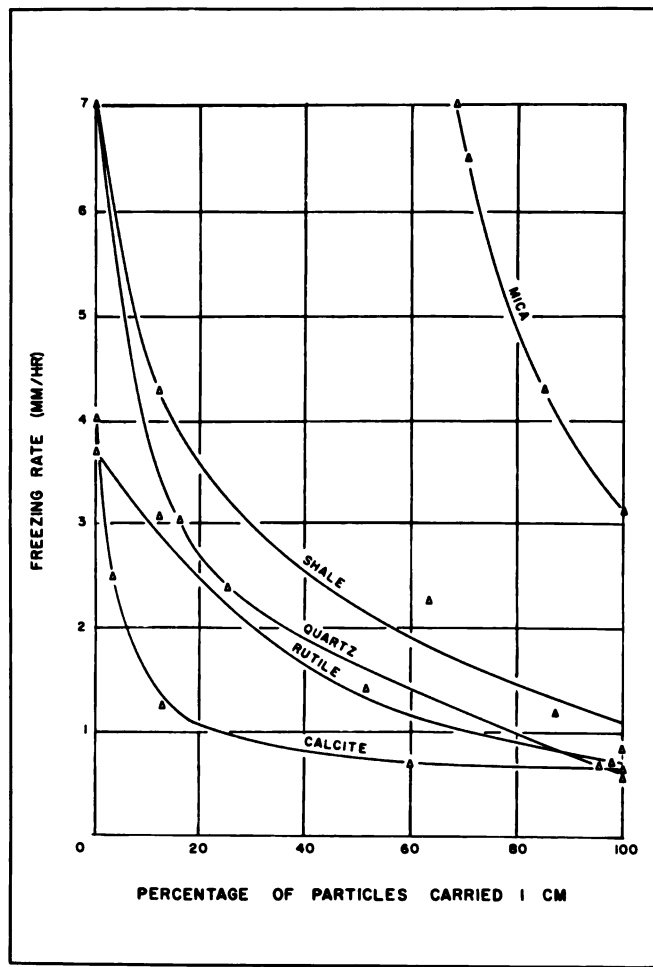

Fig. 9. Amount of different particles carried 1 cm by a moving freezing plane as a function of rate of freezing

up, fines move down, and in-between sizes show intermediate behavior. The term vertical sorting was proposed for such an arrangement [9] (Fig. 6). Boulder depressions have been reported to be characterized by vertical sorting [10] that also is observed in materials with a broad range of grain sizes and gradations. Vertical sorting occurs in well-graded materials with and without particles finer than 0.074 mm. This sorting is due to the lifting of coarse particles by ice formation and gravitation of fines into the voids left by the large particles. Another process of ice segregation (described in the next section) might also intervene. Together with vertical sorting, straight-graded samples exhibit changes in volume (a function of the heterogeneity).

Both boulder fields and boulder streams can be explained as a result of vertical sorting produced by a horizontal freeze-thaw plane (Fig. 7).

Sorting by Migration in Front of a Moving Freezing Plane

The active layer in cold regions freezes and thaws from the top downward, and in special conditions, laterally [2 to 11]. The following experiments were planned in order to observe the sorting properties of a lateral freeze-thaw plane. Laboratory experiments performed in a closed system with a vertical freeze-thaw plane demonstrated that particles migrate from the cooling side in a parabolic path, because of gravitational forces. The sorting produced is called horizontal-vertical or lateral sorting [12].

This lateral sorting is explained by a tendency of the ice to exclude particles located in the freezing front. This segregation can be demonstrated experimentally by a transparent freezing cabinet in which distilled water freezes from the

bottom upward. In this way the freezing front travels vertically, and the particles are carried against gravity.

By using different shapes of the same material [9] (Fig. 8) and different materials of varying sizes (Fig. 9), an important factor in particle migration is demonstrated—that factor is the shape of the particle or its contact area with the interface. Other important factors are particle size and rate of freezing; fine particles migrate at slow and fast rates of freezing; coarser particles migrate at slow rates of freezing. Such experiments are considered significant in explaining the origin of sorted circles which show a remarkable horizontal-vertical sorting (Figs. 10, 11) similar to that produced by lateral freeze-thaw action [12]. Probably, lateral sorting can occur in nature by migration of fine particles away from a large one if the large one freezes first and by vertical sorting where rapid changes occur in grain-size composition in short horizontal distances.

Field excavations reveal that sorted areas with lateral sorting at the surface are related to broken and contorted layers in sections, plications, involutions, etc., [13] (Fig. 12).

Mechanical Sorting by Freezing

In permafrost the active layer is reported to freeze also from the bottom upward [14]. It thaws only from the top. Laboratory experiments in freezing from the bottom and thawing from the top demonstrate that sorting is produced in a straight, graded, noncohesive sample of sand. Such sorting is called "mechanical sorting" because it is produced in the upper unfrozen part while the lower parts are being frozen.

Frost behavior of a sand sample freezing from the bottom differed greatly from that of one freezing from the top. During



Fig. 10. Surface view of sorted feature in the active layer in Thule, Greenland



Fig. 11. Feature in Fig. 10 after removal of the coarse layer near the fines, showing horizontal-vertical sorting

freezing from the top, particles beneath the freeze-thaw plane were not affected mechanically by frost action as the upper part froze. But when the freezing line advanced upward from the bottom, the ice-water interface affected all soil particles above the freezing plane, causing differential movement of particles. This mechanical "shaking" was considered responsible for the upward migration of coarse and downward migration of finer particles in the unfrozen layer.

Such mechanical sorting is so effective that a 5 mm layer of fines (particles less than 0.074 mm) was produced when the freezing plane moved up at a rate of 0.1 mm per week. As shown in previous experiments, volume changes caused by freeze-thaw action are greater at slow-freezing rates than at fast rates. Of all freezing and thawing directions, the bottom-upward type is perhaps the less important sorting process in nature.

Changes from Vertical to Horizontal-Vertical Sorting by Change in Freezing Direction

Layers vertically sorted can be changed into layers sorted in the opposite direction by lateral freezing and thawing. This change can be demonstrated by placing vertically sorted layers in aluminum pans and freezing and thawing from the sides. Vertical sorting was changed into horizontal-vertical sorting, regardless of whether the layers were dome shaped or flat (Fig. 13). This can be explained by the fact that the freezing front pushes the soil particles toward the center of the pan, forming a mound. Coarse particles in the upper layers roll from the top of the mound toward the edge of the pan, thus starting the sorting in the opposite direction. Information on the sorting effects of mounds and depressions in areas of seasonally and perennially frozen ground is not available.

CONCLUSIONS

Three types of sorting were demonstrated. The first kind is produced by wind and rain in desiccation cracks. This type is produced in cohesive soils. If such patterns are not disturbed by erosion and frost action, the features should have straight lines (Figs. 3 to 5) and in cross sections, should not show evidences of plications, involutions, etc. (Fig. 5).

The second type, which is produced by cyclic freezing and thawing, occurs in soils with a greater range of grain sizes and gradations with and without fines. This sorting produces boulder fields (Fig. 7) and sorted islands (Fig. 14). Such patterns are irregular, oval, circular, domed, or depressed (Fig. 14). If the soil is not affected by a contraction process, (thermal contraction or desiccation) the patterns should never

be linear. Cross sections show vertical and lateral sorting with broken and contorted layers, known as plications, involutions, festoons, etc. (Fig. 12).

The third type, sorting by melting, is produced by the collapse of an uneven layer of gravel over a surface of melting glacier ice. This sorting does not require freezing.

Determination of the limits of sorting by freeze-thaw will provide a better understanding of frost action. Suitable criteria for these limits will be of a benefit in engineering construction where frost action is a problem.

Observations are needed on the internal structure of sorted features in seasonal frozen soils and in areas without frost. The role of sorting from mounds and into depressions in both seasonal frost and permafrost areas needs to be investigated.

Fig. 12. Vertical section through sorted feature in Fig. 14 showing contorted layers and presence of horizontal-vertical sorting

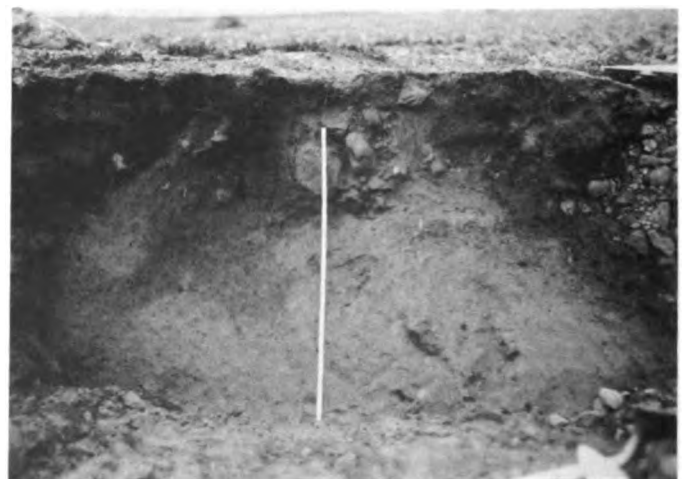

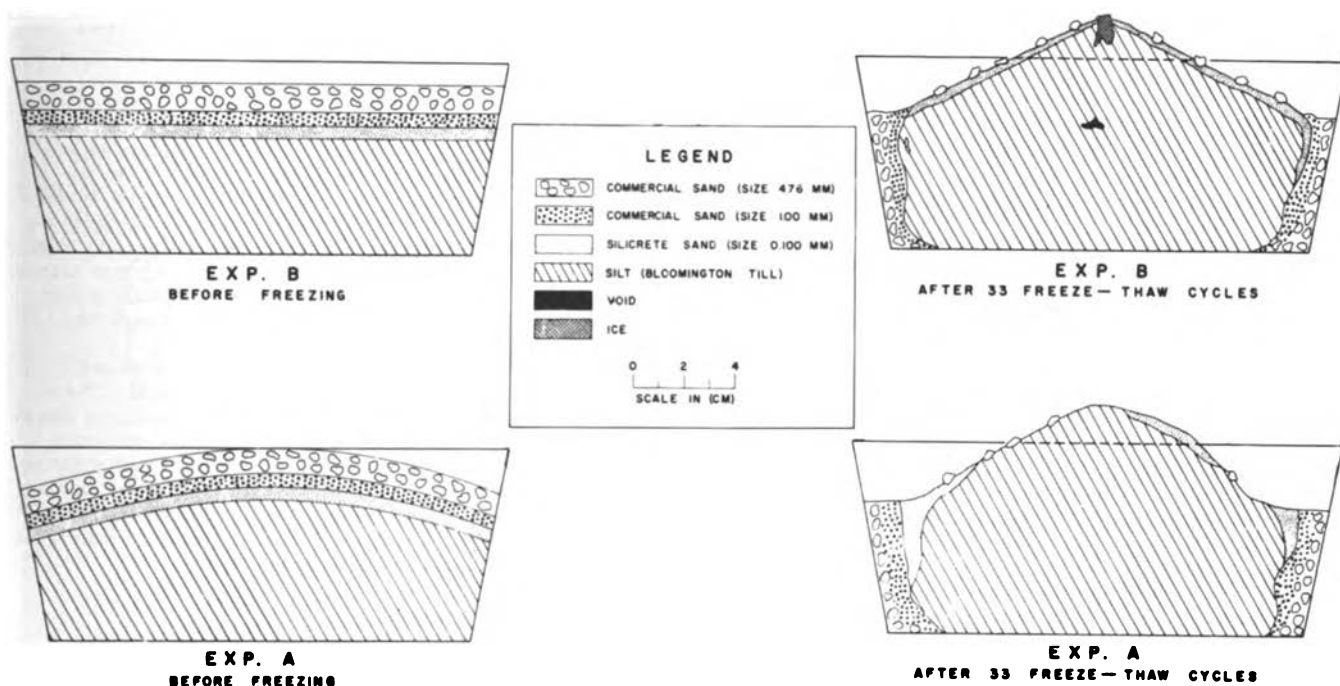

Fig. 13. Change from vertical sorting of flat and domed layers (left) into horizontal-vertical sorting (right)

Fig. 14. Air view of the active layer in Thule, Greenland. Sorted features range in size from a centimeter to many meters



REFERENCES

[1] C. Troll. "Strukturböden, Solifluktion and Frostklimate der Erde," *Geol. Rundschau* 34, 1944.
 [2] A. Cailleux, G. Taylor. *Cryopedologie, Etude des Sols Gèles*, Herman & Co., Paris, 1954.
 [3] A. L. Washburn. "Classification of Patterned Ground and Review of Suggested Origins," *Geol. Soc. Am. Bull.* 67, 1956.
 [4] A. L. Washburn. "Unusual Patterned Ground in Greenland," *Geol. Soc. Am. Bull.* 67, 1956.
 [5] A. E. Corte. "Experimental Formation of Sorted Patterns in Gravel Overlying a Melting Ice Surface," *U. S. Army SIPRE, Corps of Engineers Research Rept.* 55, 1959.
 [6] H. Alimen. "Polygones des Cailloux sur les Sols Désertiques," *Centre Natl. Recherche Sci., Action Eoliennes Phenomènes d'evaporation et d'hydrologie superficielle dans les regions arides*, Algier, 1955.
 [7] A. E. Corte. "Morfología Periglacial de la Alta Cordillera con Especial Mención del Aspecto Criopedológico," *Anal. Depto. Inv. Científicas, Univ. de Cuyo Mendoza*, 1, 2, 1955.
 [8] A. E. Corte, A. Higashi. "Experimental Research on Desiccation Cracks in Soils," *U. S. Army CRREL, Research Rept.* 66, 1960.
 [9] A. E. Corte. "The Frost Behavior of Soils," *Highway Research Board Bull.* 317, *NAS-NRC*, Washington, D.C., 1961, pp. 9-34.
 [10] G. Lundqvist. "Blocksänkors och några andra frostfenomen," *Geol. Fören. Förhand.*, Vol. 73, Pt. 3, 1951.
 [11] S. Taylor. "Studies on Patterned Ground," *Univ. of Minnesota thesis*, 1956.
 [12] A. E. Corte. "The Frost Behavior of Soils," *Highway Research Board Bull.* 331, *NAS-NRC*, Washington, D.C., 1962, pp. 46-66.
 [13] A. E. Corte. "Relationship Between Four Ground Patterns, Structure of the Active Layer, and Type and Distribution of Ice in the Permafrost," *U. S. Army CRREL, Research Rept.* 88, AD-281-707, Washington, D.C., 1962.
 [14] F. Cook. "Near Surface Soil Temperatures Measurement at Resolute Bay, Northwest Territories," *Arctic*, Vol. 5, No. 4.

INSTRUMENTS FOR MEASURING MASS-WASTING

K. R. EVERETT, Ohio State University, Columbus

Causes and effects of mass-wasting have received considerable attention during the last 100 years. Attention has been more sharply focused on mass-wasting and mass movement in the last 50 years because of the advent of extensive engineering projects, road building, and the like.

From a pure academic point of view, mass-wasting and mass movement are of particular interest when we consider the evolution of landforms, either separately, as in a single drainage, or collectively, on a regional basis. The material mantling slopes in all regions from the tropics to the arctic is in motion. The rate varies from region to region, from year to year within a region, and between any two points on a single slope.

Over the last decade, people have become interested in knowing just how fast the material involved in mass-wasting moves, how many meters in 10 years, in 100 years, etc. It is just as important, however, to know why or under what set of conditions movement occurs.

To fully understand mass-wasting and the significance of its measured rate, some understanding must be reached about the total physical, biologic, and climatic environment of the slope or region being considered.

INSTRUMENTATION

Measurement of Movement

In considering a number of devices for measuring movement, it was decided that the field instrument must have few moving parts, operate throughout a wide range of temperatures and humidities, be light and compact, and possess a high degree of sensitivity. Linear motion transducers met these qualifications. The transducer consists of a shaft which may be moved in or out of a coil or core of wire. The more turns of wire with which the shaft makes contact, the greater the resistance, and vice versa. Two models of linear motion transducers were used to investigate slope movement. Model 96125A is a short stroke spring-loaded transducer and has a shaft of corrosion-resistant steel, 9.32 cm in diameter. The shaft stroke is 12.7 mm with a total resistance of 2000 ohms \pm 5%. It is operative within a temperature range of from minus 55° to plus 71°C, and has a resolution of 0.030 mm. It has a total weight of 30.4 g without the spring. The spring was removed to permit movement with a pressure of less than 200 g.

Where movements greater than 12.7 mm were encountered, a transducer having a shaft stroke of 38.1 mm but with the same basic design was used. The total resistance of this model (8620BA) is 20,000 ohms \pm 5%, and it has a resolution of 0.046 mm. Models with shaft strokes to 153.4 mm are available; such lengths were not found to be necessary.

It was essential to calibrate each transducer prior to field installation by fully extending the shaft and recording the resistance; then the shaft was inserted in 1-mm increments and corresponding resistances were plotted. A hyperbolic curve was obtained on semilog paper showing resistance on the ordinate and movement on the abscissa. From such a curve the shaft displacement can be read for any resistance value. The resistance can be read with a standard volt-ohm meter. Although shaft displacements on the order of 0.030 to 0.046 mm can be recorded, it is not possible to read more accurately than 0.1 mm because the recording chart intervals can be interpreted only to 25 ohms. Thus the maximum potential of the device is not realized.

Soil Moisture and Soil Temperature

In order to record soil moisture and soil temperature as accurately as possible, and to obtain this information at the point of movement, Coleman soil moisture units were used. The unit in use at Cape Thompson, Alaska, as well as at

Neotoma Valley, Ohio, is Model 375 which consists of an electrode sandwich measuring 2.54 by 3.8 by 0.3 cm. Basically the unit is composed of two (1587.5 sq cm) 60-mesh Monel screens separated by, and wrapped in, 0.02-cm thick cloth of glass fiber. Two Monel contact wires lead out from the screens. A Western Electric Co. No. 7A disc-type thermistor was included. This and the screens wrapped in glass fiber are enclosed between two perforated 22-gage Monel sheets which are spotwelded together.

The electrical resistance between the screens varied in response to changes in moisture content of the soil. These units have not been found satisfactory in quantitatively measuring soil moisture, particularly in Alaska where saturated soils are common, but have proven very useful in determining the change of state and in giving qualitative information on soil moisture. Also, they necessitated modifications of the recording instrument to compensate for a resistance drift when high moisture percentages were encountered.

Field Installation

To obtain reliable readings of movement, the transducer must be fixed in its position relative to the surrounding soil. At Neotoma Valley a pit approximately 1 m in diameter was dug to bedrock. A hole 10 to 15 cm in diameter was drilled 20 to 30 cm into the bedrock with a star drill. A galvanized iron pipe 8 cm in diameter, pointed on one end and threaded on the other, was inserted into the bedrock hole and cemented in place with the cement casing extending nearly to the soil surface. The pipe also was filled with cement. The pit was not backfilled but was supported on all sides by a shelter box. A solid anchor for the transducer was thus ensured.

The transducer was connected to the pipe anchors by means of specially constructed stanchions (Fig. 1). The transducer was bolted to the mounting plate of the stanchion which was attached by a friction screw to a spindle 8 cm long. In this way the mounting plate and transducer could be moved up or down the spindle and rotated through 360 deg by simply loosening the screw. The spindle segment was attached to a middle segment (8.0 by 1.9 by 1.9 cm) by a pin joint which permitted 180-deg movement in a vertical plane. The middle segment was attached in turn to a basal segment by a similar pin joint. The basal segment was bolted to a brass plate which was sweated across a nipple 5.1 cm in diameter. By loosening the nut holding the lower segment, the entire stanchion could be rotated through 360 deg. In 1961 a simplified version on the stanchion was made by J. O. Rickley and Son, of Columbus, Ohio. This stanchion was constructed of brass. The spindle was eliminated and the pin joints were replaced by ball and socket joints which reduced the cost and increased the flexibility of the stanchion.

Movement Plate

Once a site had been selected for movement study, and prior to emplacement of the anchor, the movement plate was installed with as little disturbance to the soil as possible. The movement plates used at Neotoma Valley, Ohio, were made from 0.050-cm aluminum sheeting and had a diameter of 15 cm. Continued work in Alaska has shown that square plates from 5 to 8 cm are preferable. The plates were inserted upslope from the transducer (with one exception) and placed so the midpoint of the plate was 10 to 10.7 cm below the ground surface. Care has to be exercised when installing the plates so as not to disturb the soil upslope from the plate, and to replace any soil that had to be removed as close to its original field density as possible. Shallow roots were a complicating factor.

Once the movement plate was installed, it was connected to the transducer shaft by an aluminum rod of 0.95-cm OD.

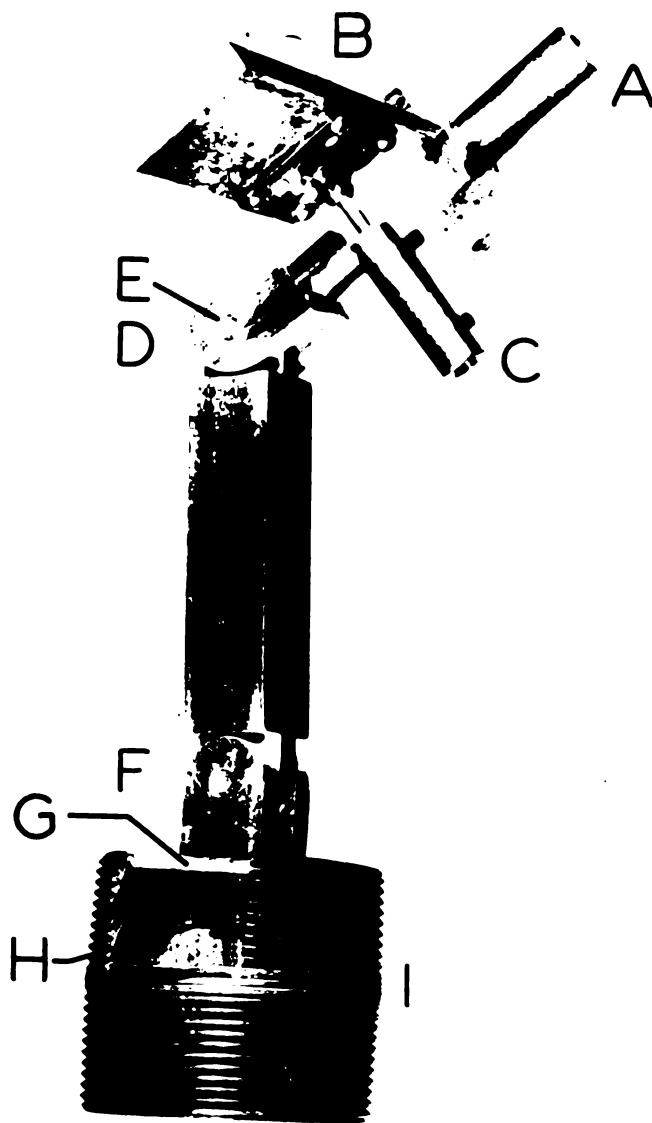

Fig. 1. Construction of stanchion to hold transducer: A, spindle; B, transducer; C, connector for transducer and movement plate shaft; D, pin point; E, friction screw; F, point joint; G, base plate; H, lock nut; I, nipple

The length of rod used was dependent upon the distance between the movement plate and the transducer. Lengths of 3 m were used in Neotoma Valley. With such long rods considerable error resulted from wind action and sagging. Rods on the order of 0.2 to 0.5 m were used in Alaska with satisfactory results. The rod was attached to the transducer shaft by a brass couple. Fig. 2 illustrates a completed measurement site.

The transducer was protected from the elements by enclosing it and its connecting terminals in a plastic cup bolted to the mounting plate.

Coleman units were placed at the position of the midpoint of the movement plate and not more than 15 cm laterally from it.

Measuring devices at each site were connected to a centrally located Wheatstone Bridge by six-conductor aerial cables that consisted of a polyethylene outer jacket surrounding an aluminum shield. Next was a layer of nonhygroscopic binder tape surrounding 12 insulated wire pairs. Conductors were of 19-gauge copper which has a resistance of 0.0241 ohm/m. Although the cable was designed for aerial

use, two years of ground use have shown no ill effects. Conductor resistance over this distance was not sufficient to require correction of the readings.

Each site (transducer and Coleman unit) was connected to the terminal board of a Wheatstone Bridge. The bridge used was a Daystrom-Weston dual range, continuously recording instrument. A low range of 0 to 10,000 ohms was designed to accommodate the transducers and the thermistors of the Coleman units. The Coleman soil moisture units recorded a high range from 1×10^4 to 1×10^6 ohms. Each machine accommodated 24 inputs which were printed at the rate of one per minute. The chart speed was set at 15 cm/hr. The machine was housed in an all-weather shelter.

A 1.5-KW generator supplied the power to run the recorder. The recorder shelter was heated by a 75-watt light bulb which maintained an inside air temperature of 15°C even when outside air temperatures were -16°C . Voltage and cycle changes as well as power failures were troublesome but were corrected by increasing the load on the generator to 80% of capacity and by removing the automatic choke on the generator.

Limits of Instrumentation

The major limitation of the movement instrumentation just described is that each unit or site is composed of a single instrument and does not record a vertical velocity profile. Other workers, notably Williams [1], have been able to record vertical velocity profiles by using different instruments.

Sources of Error

Probably the greatest single source of error lies in the rod connecting the plunger of the transducer with the movement plate. This plate is of necessity exposed to the elements, particularly the wind. If the rod is too long, (longer than 0.5 m), vibration due to wind becomes rather troublesome. With rods 0.5 m or less in length, very little difficulty is encountered. With a shorter rod the anchoring pipe must be set rather close to the point of movement. If considerable care is exercised in excavation and installation, the anchor can be installed with little disturbance to the environment.

Differential thermal expansion of the component parts of the measuring system is negligible, particularly if all movements less than 0.2 mm are disregarded.

RESULTS

Some results obtained with the instrumentation just described, over a two-year period at Cape Thompson, Alaska, are briefly



Fig. 2. Instrument emplacement in Northwestern Alaska, sites 1 to 3W. Movement is being recorded from different depths in a nonsorted mud circle

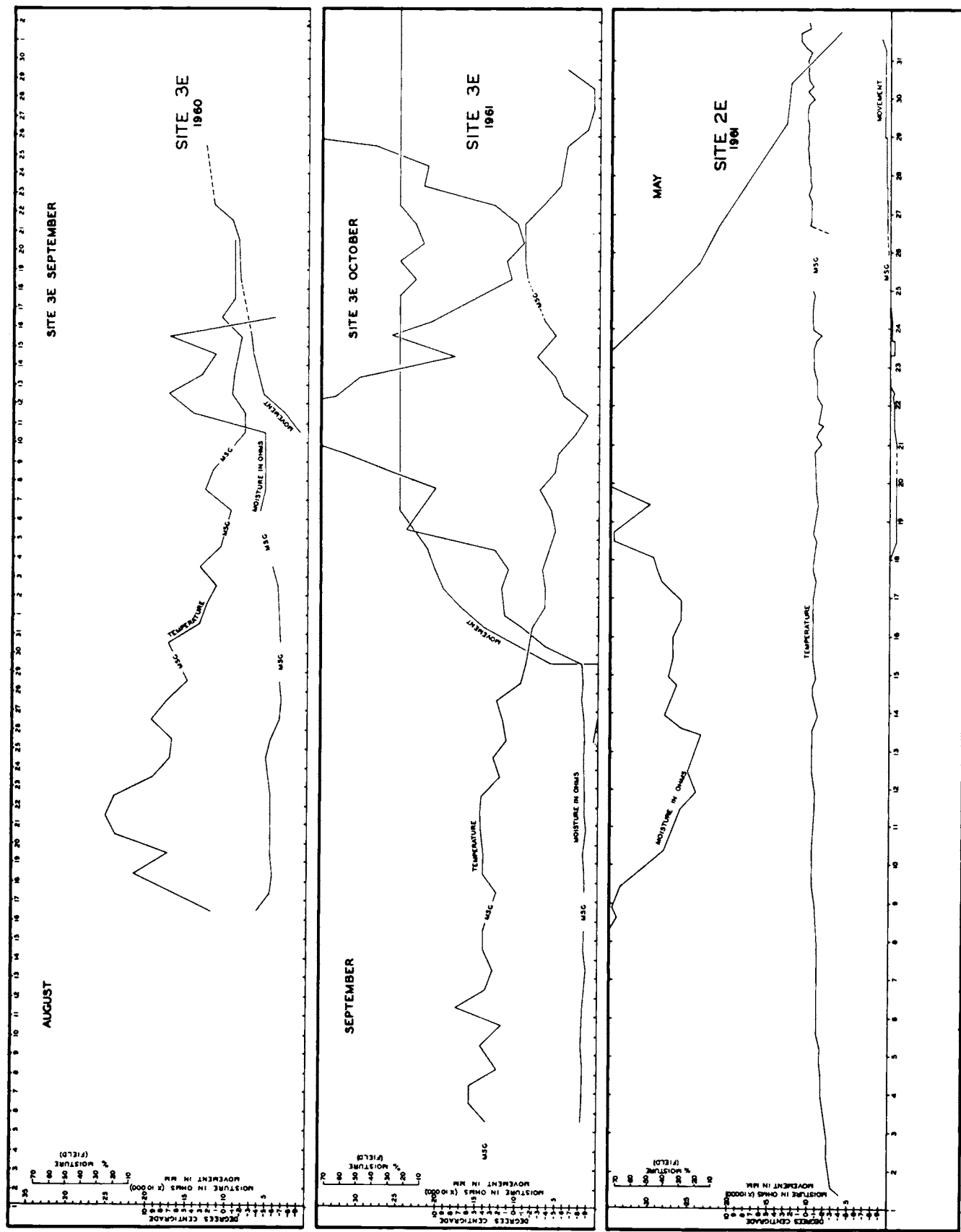

Fig. 3. Selected curves showing movement, relative soil moisture and soil temperature for sites 3E and 2E, Ogotoruk Creek, Alaska

presented for four sites [2] and pertinent data are given in Table I.

Table I. Data for four movement sites in Alaska

Site No.	Shape angle in degrees	Ground pattern	Bedrock	Soil type	Vegetation	Depth to permafrost (Aug.)
2E	32	Peat ridge	Dolomite, dolomitic limestone, and chert	Imperfectly drained Arctic Brown	<u>carex biglowii</u>	40 cm
3E	5	Non-sorted stony mud circle	Same as above	Low Humic gley	None	58 cm
1W	5	Non-sorted mud circle	Sandstone and mudstone	Low Humic gley	<u>Betula nana</u> <u>Deschampsia cespitosa</u>	45 cm
5W	7	c.f. Turf banked terrace	Same as above	Peat and imperfectly drained Arctic Brown	<u>Hierchloe alpina</u> <u>Salix phteba-phylla</u> <u>Artomisja arctica</u>	40 cm

Freezeup

Figs. 3A and B showed expansive movement (heave) at the 10 cm level in a stony nonsorted circle on the southeast-facing slope of Ogoturuk Valley, Alaska, in two successive years. The rate and amount of movement varied greatly from 1960 to 1961. This is attributed to the initial rate of freezeup and the amount of soil moisture, which were both higher in 1961 than in 1960. The type of ice (lens-ice) remained the same in both years.

The initial movement rate in 1961 was 0.5 cm/hour over the first 12 hours. In the succeeding 24-hour intervals, rates dropped to 0.2 cm/hour. Movement stopped altogether by 10 a.m., eight days after its start. On the opposing slope, site 1W, movements were recorded at the 2.5 cm level in a nonsorted mud circle. Heaving began at a rate of 0.5 cm/hour over the first 24 hours. The rate of movement increased to 0.8 cm/hour in the next 24 hours. In the third 24-hour period the rate of movement decreased sharply to 0.04 cm/hour.

The pattern of movement at site 1W and that at 3E, Fig. 3B, in 1961, is very similar. The differences, particularly in the initial rate of heave, are due to the larger moisture reservoir, finer soil texture, and lower surface load pressure at 1W.

Also of interest are the expansive-contractive movements in 3E, Fig. 3B, between October 18 and 23, 1961. These movements are related to rather deep thaw and refreeze over this period.

Thaw

Site 2E, Fig. 3C, shows movements obtained from a peat ridge adjacent to the stony circle 3E. Of particular note here is the progressive expansive (downslope) movement which began slightly before temperatures at 10 cm had reached 0°C,

and continued at an accelerating pace into June 1962.

Washburn [3] has observed similar movements associated with thaw in East Greenland and believes them to be due to creep when the liquid limit of soil has been exceeded as a result of the melting of ground ice or snow.

The expansive movement in 2E is certainly not related to any refreezing at the 10-cm depth.

Site 5W (not shown) is in a small terrace 15 to 20 cm high, separating two elongated stony circles on the northwest-facing slope. A total expansion (downslope movement) of 3 mm occurred between May 11 and 30. This movement was definitely related to saturated creep.

Movement during the summer months, i.e., from roughly July 1 to the following freezeup in early September, are slight. Movement in the nonsorted mud of stony circles was largely contractive. The contractive movement is associated with heavy rains, 25 mm or more, in a 24-hour period. Movement of peat ridges or other features composed of peat are both expansive and contractive. Some of these movements appear to be related to pronounced diurnal changes in relative humidity, and some may be related to the drying action of strong north winds.

Neotoma Valley, Ohio

The same type of instrumentation that was used in Alaska was also used in southern Ohio to measure slope movement. Movement at the 15-cm depth was very slight and erratic over the slope. Measurements indicate that movement is on the order of 0.25 mm/year. Data obtained from clay cylinders buried in the slopes show movement in the upper 8 cm of the soil may be as much as 50 mm/year. Surface displacements of 0.5 m for individual particles are common on both slopes and are affected by rill and sheet-wash.

Movements in Alaska are largely restricted to the early phases of freezeup and to the thaw period. Movements in Ohio appear to be rather evenly distributed throughout the year. However, there is some evidence that downslope movement may be greatest during the winter months when soil moisture is highest. Surficial movements in Ohio are certainly greater during the months when the tree canopy is open. It is at this time when drop impact and rill and sheet-wash are most active.

CONCLUSIONS

The instrumentation described provides a highly sensitive and accurate method for measuring movement of the material mantling slopes.

Results obtained from the Ogoturuk Creek area (Cape Thompson) Alaska and Neotoma Valley, Ohio, indicate that movements in both areas are discontinuous in space and time, dependent upon the texture of the mantle and the moisture balance and state in the mantle.

The rate of movement on the slopes of the Ogoturuk Creek is nearly 100 times that on the slopes of Neotoma Valley.

REFERENCES

- [1] P. J. Williams. "The Direct Recording of Solifluction Movements," Am. J. Sci., Vol. 255, 1957, pp. 705-715.
- [2] K. R. Everett. "Slope Movement, Neotoma Valley, Southern Ohio," Ohio State Univ., Inst. Polar Studies Rept. No. 6, 1963.
- [3] A. L. Washburn. Yale University, New Haven, Conn., 1962, priv. comm.

ORIGIN AND DEVELOPMENT OF PATTERNED GROUND IN SPITSBERGEN

ALFRED JAHN, Geographical Institute, Wrocław University, Poland

The study of patterned ground is very complex. However, the stage has been reached where satisfactory solutions are being proposed to many of the problems encountered. This has been achieved primarily by advanced experimental research in field and laboratory, augmented by a large amount of new observational data. J. Büdel [1] considers the question of the origin of patterned ground to be merely historical and geomorphological, and not geophysical (i.e., one that is possible to solve by observation and experiment). I find it impossible to accept this view. On the contrary, I believe that geomorphological experiment offers a very promising course. A series of simple tests undertaken in Spitsbergen in the years 1957-1960 produced some interesting results. The present discussion of the origin of patterned ground is based mainly on these findings [2].

There are three frost processes that lead to the origin of forms and structures of patterned ground: (1) Changes in the volume of the soil, (2) sorting, and (3) cracking. Gravitation shares in these processes since its action results in mass movements which supplement and modify frost structures.

Washburn's classification [3] of soils into sorted and non-sorted forms and into shapes (circles, nets, polygons, steps, and stripes) seems to be correct. It is not possible to draw a sharp line dividing sorted forms from nonsorted-fissure forms since both have common elements with transition forms between them.

It is the object of this paper to describe some of the principal static and dynamic characteristics of patterned ground in Spitsbergen, and then to proceed to more general conclusions pertaining to the origin of the various forms. Those features that have not been given sufficient consideration in previous analyses are emphasized.

STATIC CHARACTERISTICS

Most of the patterned ground forms in Spitsbergen are sorted circles and sorted polygons. The debris segregated from the soil comes to rest in stone borders or furrows. The central part is made of fine grains, which are often mingled with coarser elements.



Fig. 1. Concentric arrangement of material in a sorted circle. Fjord Hornsund, Spitsbergen



Fig. 3. Horizontal section 40 cm deep across a sorted circle. Distinctly concentric arrangement of material: Sandy silt in center; next, fine debris; coarse debris outside. Kongsfjord, Spitsbergen



Fig. 2. Initial phase of a sorted circle: concentrically arranged debris. Fjord Hornsund, Spitsbergen



Fig. 4. Cross section of a sorted circle, showing sorted debris. Hornsund, Spitsbergen



Fig. 5. Regular sorted circles and motometers. Hornsund, Spitsbergen



Fig. 6. Sorted circles, 10 m in diameter, on a low, marshy valley bottom. Hornsund, Spitsbergen

Contrary to prevalent views, it must be emphasized that the arrangement of material in the central part is rarely chaotic. A definite regularity has been noted in the arrangement of material in the Hornsund and Kongsfjord areas of Spitsbergen. A typical unit (Figs. 1 to 4) in a polygonal field may be described as follows: The interior is made up of sandy-clayey material; toward the border the material becomes sandy, then passes into fine debris and, finally, into boulders and blocks. As a result of segregation the elements and particles range from silty grains to blocks, the differences in diameters being enormous. The sorting process does not consist merely of separating coarse particles from fines, but involves a most subtle segregation of material according to grain size. The homogeneity of the particles, as observed in each particular layer is striking. Even debris exceeding 1 cm in diameter is sorted into distinct concentric layers. Transition lines between adjacent layers are narrow enough to be called boundaries.

These facts were established on the surface of sorted circles and polygons and also in cross sections to the bottom of the structures, which commonly terminate at a depth of about 1 m in Spitsbergen. Segregation was most conspicuous in patterned ground on the terraces of Kongsfjord where, in 1958, bulldozers cut the structures horizontally to a depth of 30-40 cm (Fig. 3).

The concentric system of homogeneous layers, so characteristic of patterned ground, has surely been derived from the system of sorted horizontal layers. Numerous transitional stages between the two systems have been observed. On top there is a layer of boulders consisting of coarse blocks; below

lies mixed debris, and still lower there are layers of fines. A perfectly sorted horizontal system represents an extreme case and is very rare, for a cryogenic process operates simultaneously with vertical sorting of material and tends to destroy the horizontal system of layers.

Stone borders of circles and polygons in Spitsbergen differ in height and form, and the differences obviously depend on two factors: The type of material being weathered and the moisture content of the ground. High borders are formed in places where the material consists of large amounts of coarse debris. Debris borders on very wet ground (i.e., ground periodically inundated by water) are much lower than in dry places. Borders display a tendency to sink in saturated muddy places, and in such places the age of the form becomes a significant factor.

Stone margins of circles and polygons in Spitsbergen are most frequently of the "floating-border" type suspended in muddy material. This holds true of both miniature patterns and macroforms. Another type of stone margin is represented by those borders where debris reaches as deep as the base of the active layer. Some forms exist that combine the two former types in that on the surface they appear as "debris floating borders" and, at the same time, they are borders of internal structure extending upward from the base. Apparently these two elements develop independently of each other.

The essentially horizontal forms of stone nets seem to indicate the factors responsible for their development. There are three types of nets: (a) Those made of stone circles or ellipses that represent a nonarranged system and occur on flat terraces (Figs. 5 and 6). (b) Nets consisting of circles or

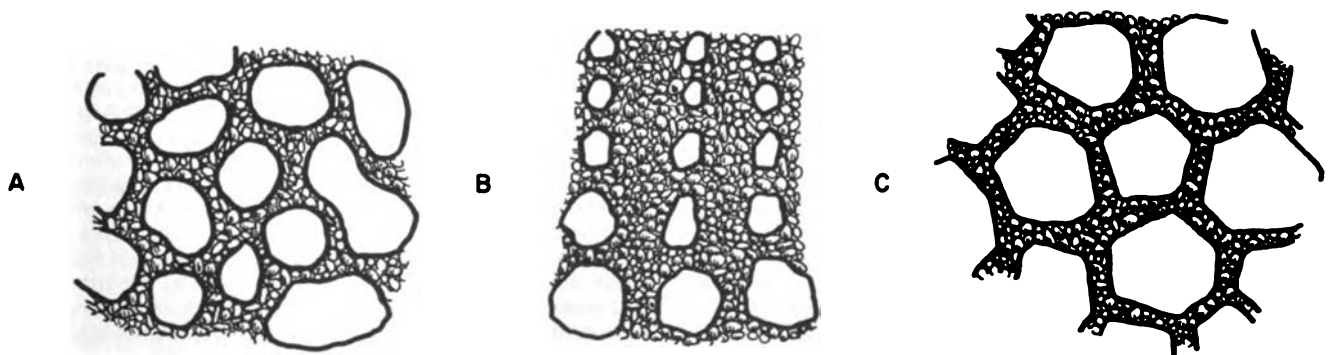

Fig. 7. Types of polygonal nets: (A) System of circles on a terrace, (B) System of ellipses on an alluvial surface, and (C) System of polygons



Fig. 8. Irregular net with muddy patches on an alluvial gravel surface. Hornsund, Spitsbergen



Fig. 9. Sorted polygons, fissure type. Hornsund, Spitsbergen

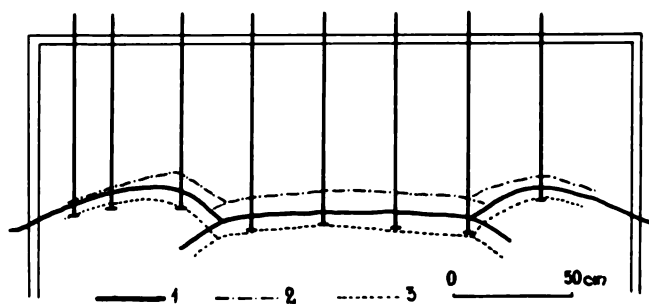

Fig. 10. A motometer of type devised by Bac, installed across a sorted circle. The position of the soil surface is indicated for autumn 1957, spring 1958, and autumn 1958

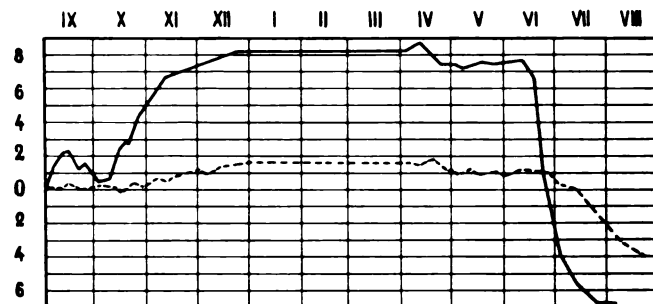

Fig. 11. Surface soil movement at center (continuous line) and within the sorted circle (interrupted line) from September 1957 until August 1958

ellipses that make up an arranged system. They are common at the bottom of large talus or on gently inclined surfaces. These circles and ellipses are debris islands, and their fan-shaped arrangement reflects the inclination of the slope (Figs. 7 and 8). The direction of these forms is determined by the flow of subsurface waters. (c) Nets that are typically polygonal, for the most part pentagonally or hexagonally arranged. These differ markedly from the two former types of nets, whose system of debris wreaths is characterized by a prevalence of curved lines. With polygonal nets, however, the straight lines of their borders are particularly significant (Fig. 9). This arrangement of nets derives from cracking, and is known in the Alps and elsewhere [4].

DYNAMIC CHARACTERISTICS

From 1957 to 1960, Spitsbergen was the site of numerous experimental investigations into the dynamics of frost phenomena, especially vertical and horizontal soil movements and upfreezing of stones.

Vertical soil movements were measured by means of motometers (Fig. 10) installed in various positions, chiefly associated with patterned ground (Fig. 5). A series of observations, beginning in autumn 1957 and ending in autumn 1958, demonstrated some salient characteristics of the movement within a selected sorted circle. The maximum annual amplitude (15.5 cm) at the surface occurs in the central part of the inner field. Stone borders participate in the movement but their amplitude of movement is considerably less.

The curve representing the annual movement is asymmetric (Fig. 11). Autumn freezing proceeds in the form of a surging wave, while summer thawing has a rapid, undisturbed course. In autumn the soil was observed to swell repeatedly because

of freezing. As a result there is a deterioration of the soil structure that contributes to a rapid upfreezing of stones and size sorting of material.

In September, following the first frosts, the following changes were observed in the patterned ground where the temperature of the ground surface fell to -7°C : The central areas were frozen to a depth of 9 cm, moisture rose to the frozen bed, and thin layers of ice were formed. The thickness of ice layers was greater on the margin, next to the furrow, than inside the central area. Ice layers passed into sheets of needle ice, the number of ice generations indicating the corresponding number of slight frosts (Fig. 12). Needle ice grew in the furrows.

Thus the autumn frost cycle causes rapid heaving of the soil surface. The freezing front operates from the soil surface and from the furrows. The central area of the form freezes both deeper and more rapidly than the furrow, and thereby causes desiccation of the furrow, whose enclosed spongy mass of needle ice acts as insulation. The clayey soil in the central area is frozen, uplifted, and separated from the furrow.

The change in volume and shape, which is contingent on freezing, may be very rapid in some places. Its rate depends on the compression of the mass due to cryostatic pressure. In Spitsbergen annual frost upthrusts as high as 40 cm were witnessed. In the course of a single winter, a clayey mass may break through the debris surface sheathing and form a rough outline of a sorted circle. Hydrological conditions are of paramount importance here. The author distinctly remembers seeing clayey columns rise from the bottom of a shallow lake in the autumn and break through newly formed lake ice.

These are evidences of spontaneous frost processes. One must beware of rash generalizations. Nevertheless the significance of these facts for elucidating the origin of patterned

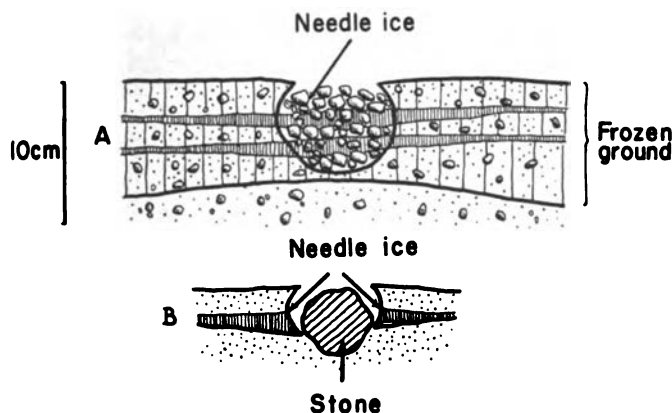

Fig. 12. Surface changes of patterned ground, due to short-term (several days) frost in Spitsbergen, September 1958



Fig. 13. Horizontal movements of the central area of a sorted circle. Wooden plates tilted outward. Vegetation cover crumpled close to the sorted circle. Hornsund, Spitsbergen



Fig. 14. Hexagonal fissure polygons. Hornsund, Spitsbergen



Fig. 15. Fresh frost crackings of "nonorthogonal" type in Spitsbergen tundra

ground is far greater than has generally been acknowledged.

Frost sorting of the soil is a rapid process. Upfreezing was measured by the upthrust of wooden stakes in the ground, and by observing specially selected stones. The experimental data show that the upfreezing "leap" averages 5-10 cm per year. Such a major upshift of stones occurs only in the soil surface layer, which does not extend deeper than 20-30 cm. Below this layer upfreezing of stone is slower.

Lateral soil movements were observed by means of wooden plates buried to a depth of 3 cm within the central, clayey area of patterned ground (Fig. 13). Following an annual freeze-thaw cycle, the plates shifted slightly sideways, or tilted outward. Without doubt, there is a tendency for the soil to flow down a convex surface. This is also corroborated by wrinkles and small folds in the lichen coating on the margin of a form (Fig. 13). The movement, however, is slow and is disproportionate to the rate of upfreezing. Frost heaving, by which we mean soil expansion perpendicular to the freezing front, is more rapid than the migration of stones at the surface.

SOME REMARKS ON THE ORIGIN OF PATTERNED GROUND

In the origin of patterned ground the essential role must be ascribed to forces caused by freezing. These forces lead to changes in soil volume and structure. It is difficult to separate the structures resulting from cracking from those that are an outcome of sorting; both processes may act simultaneously in the same place.

Many scientists now distinguish between contraction frost fissures and fissures due to drying of polar soils. Some, like Bűdel [1], are disposed to overestimate the significance of

dessiccation fissures, especially in micropolygons. Actually, the majority of the polygonal fissure systems in Spitsbergen are connected with frost action. The system of cracking depends upon local factors. Convexities in the ground foster a development of a three-axis system, "nonorthogonal" according to Lachenbruch [5], which in turn leads to pentagonal and hexagonal forms (Fig. 14). The fact that the fissures cut through the soil and the tundra turf, and even through thin rocky slabs, substantiates their origin by frost action. New fissures found in the vicinity of Hornsund, Spitsbergen, in the early spring of 1958 confirm the evolution of this phenomenon (Fig. 15).

Rapid sorting of material as the result of freeze-thaw cycles is the decisive cause of soil structures. The cycles may be daily (i.e., comprising changes within a single day or during several days), yearly, or they may extend over many years.

There is an opinion that the number of daily freeze-thaw cycles in polar regions is small. Troll [6] estimated 59 of these cycles for Spitsbergen. This view is subject to correction. It is true that air temperature oscillations around the 0°C point are infrequent. On the other hand, such temperature oscillations are far more numerous at the soil surface. Thus in 1957-1958 over 120 thermic cycles were recorded in the soil in the region of Hornsund [7].

Daily cycles operate to a depth of 20 or even 30 cm, this being the depth of autumn frosts, which commonly last several days and are then followed by a thaw. It has already been noted that daily cycles are responsible for significant changes at the soil surface. A rapid upfreezing of stones in the surface layer appears to be the main effect.

Therefore, following Czepe [7], we may distinguish three

basic layers in the soil, corresponding to different depths of freeze-thaw cycles: (a) A layer involving daily cycles—to depth 0.3 m; (b) a layer involving yearly cycles—from depth 0.3 m to about 1.0 m; and (c) a layer involving cycles extending over many years—below depth of 1 m.

The soil to a depth of 30 cm is sorted best, the sorting operating from year to year; whereas at greater depth, the process requires longer periods. The segregation results in a horizontal layering of material in the soil, with boulders concentrated at the surface. These phenomena are common in polar regions. More accurate data for North Greenland was quoted recently by Corte [8].

The effect of daily thermic cycles can be described as rapid. They have a bearing on the formation of needle ice, and also on the after effects of this phenomenon. Although thermic cycles affect chiefly the surface (i.e., micropolygons), the impact of thermic cycles on the lower layers of the soil must not be overlooked. At depth they are responsible for stresses that promote cryostatic upthrusts, which are common in Spitsbergen.

The arrangement of soil into layers due to the freeze-thaw processes, appears to be the most important effect. Coarse soil particles upfreeze faster than fine particles. Thus is formed a system of layers, sometimes having distinct borders. Hamberg's theory of upfreezing of stones [9] must, accordingly, be corrected and supplemented, for the process in question does not consist of ejection of single elements, but is a mass sorting of the soil. Corte [8] discovered this type of sorting in laboratory experiments, and the result of this research seems to be particularly relevant to polar phenomena.

If the horizontal layers of the soil are disturbed from below by upthrusting of fine-grained material, the first outline of a debris circle develops with its characteristic system of concentrically arranged layers of sorted material. Instances from Hornsund and Kongsfjord provide convincing evidence. Development of sorted circles, as outlined above, seems to explain their origin most adequately (Fig. 16).

Concentric segregation of material within the circles has also been noticed in forms resulting from thawing, which are found in ice-cored moraines [10-11]. This type of segregation appears to be exceptional. Observations from Spitsbergen indicate that lateral movement of stones on convexities is rather slow, and the concept of gravitational sorting by sliding of stones does not apply here.

The form of stone borders in sorted circles and polygons presents a separate problem. This form depends on the size and number of debris particles in the soil, and also upon the extent of swelling in the central part of the circle. Measurements taken in Spitsbergen indicate that sorted circles are subject to lateral displacements [7]. These displacements also determine the form of the circles. The central area and inside of the stone border are heaved; on the other hand, no movement has been observed in the outer part of the border. The movement of the central area pushes against the inside of the border causing the stones to slide down the steep slope. Thus, as sorted circles develop, they expand in diameter. It is plausible that the height of the circles will change, too, for an excessive accumulation of stones exerts downward

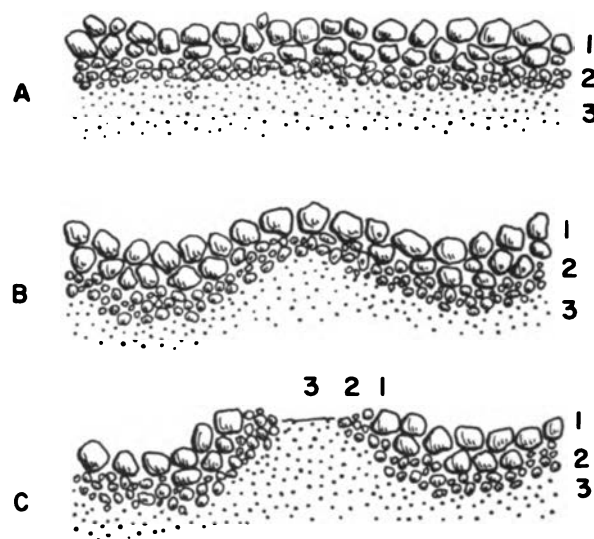

Fig. 16. The evolution of sorted circles through vertical sorting (A), internal swelling (B), and surface heaving (C). A segregated system of layers (1, 2, 3) passing from a vertical to a horizontal orientation

pressure on soft ground so that stone borders tend to sink in mud. The lateral movement of a circle is, therefore, a direct consequence of the vertical movement of the central part. The vertical movement of a border is, in turn, dependent upon its mass.

Development of circles is very closely related to hydrological conditions (Fig. 17). Laterally interrupted circles were observed to occur on low, muddy ground in valley bottoms subject to inundation. The diameter of such circles can be several meters, and their borders are low. These forms appear to be fully active.

Most regular circles with a diameter of 1 to 2 m are found above valley bottoms, commonly on terraces that in the spring are flooded for a short time only, and where the level of ground waters in summer is as deep as 40 cm. The borders are very high (up to 0.5 m) as compared with the central clayey part. Such circles are periodically active. They are subject to lateral displacements, but their borders do not sink deeply. This accounts for their stately appearance as well as freshness. The slopes of the borders are steep and asymmetric.

Still higher, on dry terraces, there are forms showing but slight activity. These forms have a vegetation cover, and stone borders have been replaced by rills and rivulets. The situation is reverse to that on the lower terraces. Miniature patterns (secondary polygons) on the surface of these forms are undoubtedly active. Such sorted polygons are exposed to intensive erosion.

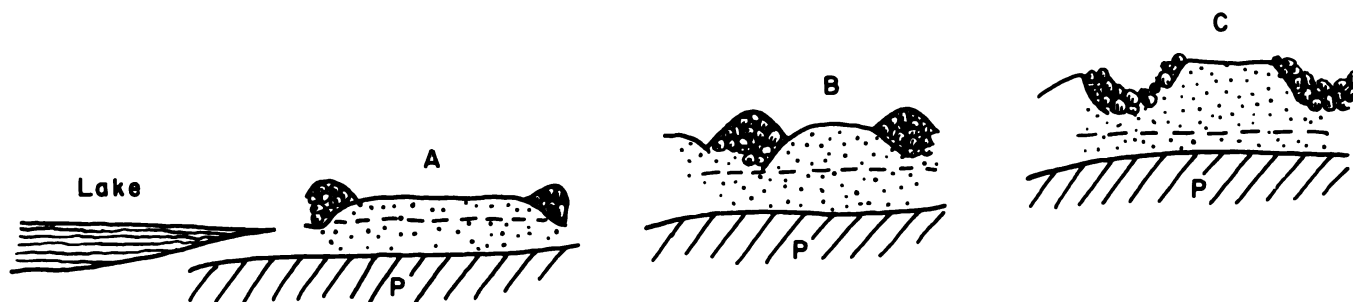

Fig. 17. The shape of sorted circles depends on their situation with respect to the lake (hydrological conditions). The schematic diagram represents a profile observed in the Hornsund fjord area. P—permafrost; interrupted line marks groundwater level

Development of polygonal forms is, therefore, related to the general morphological development of the whole area. This is hardly a direct dependence, since new forms may also arise on older, high terraces. Hydrological conditions constitute the decisive factor. The absence of activity on the upper terraces is due to the ground being dry.

Concentric belts of patterned ground, which surround the lakes, constitute a typical phenomenon. Fresh and fully active forms occur in the lowest belt adjacent to the lakes, and farther from the lakes the signs of activity become progressively less. It seems obvious that degradation of permafrost and disappearance of the lakes have caused the belts of patterned ground to grow centripetally.

Degradational activity of flowing waters must be considered one of the effective causes of deterioration of patterned ground. Many soil structures are developed on washed forms, and in places where surface waters become too abundant, patterned ground gradually decays. First the furrows, and then the whole form is destroyed.

Apart from being related to climate, the phenomenon of patterned ground is entirely dependent on local conditions, and particularly on hydrological conditions. If the climate remains constant, it is the hydrological conditions that determine whether active soils become inactive and vice versa. The author has seen instances where a new rivulet has revived patterned ground activity in places where forms had become completely inactive.

In light of what has been said above, patterned ground must be regarded as a phenomenon with wide climatic associations. Patterned ground can develop outside the confines of the high-arctic zone and is known to exist in various climatic belts. The instances of patterned ground that are found outside their typical zone have been called "azonal" [6]. In my opinion local factors are most significant here. For instance, in the forest zone of Alaska, typical patterned ground occurs only on bottoms of shallow lakes. Elsewhere vegetation prevents the development of patterned ground, although local temperature conditions are favorable. Where the vegetation cover is removed, structural forms soon appear. In the Tatra Mountains in Poland, the first outlines of patterned ground were found in places where man had destroyed the vegetation cover (i.e., through camping, sheep grazing, etc.).

Once conditions for the activity of patterned ground become propitious, rather rapid development follows. In the studies conducted so far, too much attention has been paid to dependence of patterned ground on climate, while the investigation of local conditions (which can be related to climate only indirectly) has been underestimated. For this reason, it is pointless to consider the evolution of these forms against the background of the geological or long-term climatic curve, as was done by Büdel [1]. Instead, research should aim at a more accurate knowledge of local factors, for these alone are of crucial importance. It is to be hoped that field experiment will provide a satisfactory solution to this problem.

In conclusion, I should like to emphasize again that the origin of patterned ground is very complex. It is not to be expected that these phenomena can be explained by a single, all-embracing theory, since the processes acting are by no means homogeneous. On the one hand there are periodic, rhythmical processes, and on the other hand nonperiodic, spontaneous ones.

The former group includes the sorting of material and upthrust of coarser elements to the freezing surface. Here

also belong changes in volume and shape as well as local heaving, due to annual freezing and thawing. In this sense, the concepts of Poser [12], Taber [13], and Schenk [14] are correct.

The latter group comprises mainly the factors that are related to cryostatic pressure. The process of patterned-ground development based upon this force is rather violent. Sukachëv's [15] old theory still holds true, and recent observations [16, 17] contribute supporting evidence for it.

Patterned ground develops as a result of the combined action of periodic and nonperiodic processes. The relative importance of these processes is determined by local conditions—climatic, morphological, and, chiefly, hydrological.

REFERENCES

- [1] J. Büdel. "Die Frostschnitt-Zone - Südost, Spitzbergen," *Coll. Geog.*, Bonn, Vol. 6, 1960.
- [2] Alfred Jahn. *Quantitative Analysis of Some Periglacial Processes in Spitzbergen*, Uniw. Wrocławski, Zeszyty Naukowe, Ser. B, No. 5, 1961.
- [3] A. L. Washburn. "Classification of Patterned Ground and Review of Suggested Origins," *Geol. Soc. Am. Bull.*, Vol. 67, 1956, pp. 823-866.
- [4] Gerhards Furrer. "Die Strukturformen der Alpen," *Geog. Helvetica*, Vol. 10, 1955, pp. 193-213.
- [5] A. H. Lachenbruch. *Mechanics of Thermal Contraction Cracks and Ice-wedge Polygons in Permafrost*, New York, Geol. Soc. Am. Spec., Papers, No. 70, 1962.
- [6] Carl Troll. "Strukturböden, Solifluktion und Frostklimate der Erde," *Geol. Rundschau*, Vol. 34, 1944, pp. 545-694.
- [7] Z. Czeppe. *The Yearly Course of Frost Movement in the Ground in Hornsund, Spitzbergen, 1957-1958*, Prace Inst. Geog. Uniw. Jagiell, No. 25, 1961.
- [8] A. E. Corte. "The Frost Behavior of Soils," *Laboratory and Field Data for a New Concept* (pt. 1 Vertical Sorting), U.S.A. CRREL Research Rept. 85, 1961.
- [9] Axel Hamberg. "Zur Kenntnis der Vorgänge im Erdboden beim Gefrieren und Auftauen," *Geol. Fören. Stockholm, Förr.*, Vol. 37, 1915, pp. 583-619.
- [10] A. L. Washburn. "Unusual Patterned Ground in Greenland," *Geol. Soc. Am. Bull.*, Vol. 67, 1956, pp. 807-810.
- [11] A. E. Corte. "Experimental Formation of Sorted Patterns in Gravel Overlying a Melting Ice Surface," *Biuletyn Peryglacjalny*, Lodz, No. 8, 1960, pp. 65-72.
- [12] Hans Poser. "Das Problem des Strukturbödens," *Geol. Rundschau*, Vol. 24, 1933, pp. 105-121.
- [13] Stephen Taber. "Perennially Frozen Ground in Alaska: Its Origin and History," *Geol. Soc. Am. Bull.*, Vol. 54, 1943, pp. 1433-1548.
- [14] Erwin Schenk. *Die Mechanik der Periglazialen Strukturböden: Hessischen Landesamtes für Bodenforschung*, Abh., No. 13, 1955.
- [15] V. N. Sukachëv. "K voprosu o vlianii merzloty na pochvu," *Akad. Nauk Izv.*, Ser. 6, Vol. 5, 1911, pp. 51-60.
- [16] A. L. Washburn. "Patterned Ground," *Rev. Can. Geogr.*, Vol. 4, 1950, Nos. 3-4, pp. 5-59.
- [17] J. R. Mackay. "Fissures and Mud Circles on Cornwallis Island, NWT," *Can. Geog.*, 1953, No. 3, pp. 31-37.

Photographs for Figs. 1 through 6, 8, 9, 13, 14, and 15 were taken by Alfred Jahn.

PATTERNED GROUND IN SWEDEN

JAN LUNDQVIST, Geological Survey, Sweden

This paper relates horizontal and vertical distribution of different types of patterned ground to climatic and other factors affecting frost action in the ground. The main conclusions of a paper by the author [1] concerning such features that result from frost action are included. The earlier paper and this one are based on observations made during 20 years of field work.

Patterned ground—is used as in Washburn [2] as well as an enlargement of his classification system; pattern types [1, 2] are defined. Phenomena caused by the frost effect upon solid bedrock or by landslides and other rapid mass movements are not considered.

Vertical distribution is studied by means of profiles [1] (Fig. 1). Climatic data are taken from the Atlas of Sweden (*Atlas över Sverige*, Stockholm, maps 25 to 32).

Sorted circles of two types occur: Debris islands and stone pits.

Debris islands occur throughout the Caledonian Mountain Range above the timber line and also at lower levels in scattered localities in the northern district of boulder depressions (Fig. 1).

Stone pits are shallow, a few decimeters in diameter with a floor of stones without fines, generally occurring as wet hollows in ground covered with thick vegetation. They occur mainly in the Caledonides and their surroundings and they are restricted to levels between 500 and 1000 m; that is, above or somewhat below the timber line. Rarely are stone pits observed at lower levels outside the Caledonides.

Nonsorted circles. Mud circles are the only nonsorted circles in Sweden. They become elongated mud terraces on slopes. They are found on moderate levels above and at the timber line in the Caledonides, with the possible exception of the southern part of the range.

Sorted nets exist only as intermediate forms between sorted circles and sorted polygons.

Nonsorted nets are variants of other patterns. The most distinct type, the earth hummock or knob, is similar to the peat hummocks of bogs but consists of mineral soil.

inner structure of the earth hummock shows involutions and other features typical of frost-heaved soil. Although found all over the Caledonides, they are especially common where the ground is rich in fines and has a low boulder content. They do not occur at the highest levels and apparently have a distinct vertical distribution (Fig. 1). However, they also are present at much lower levels in the rest of Sweden, far outside the district included in Fig. 2.

Sorted polygons are found almost everywhere in the Caledonides, their upper limit being determined simply by the lack of fine grained deposits. Below the timber line they occur on lake shores and other bare ground within the northern area of boulder depressions and—with small dimensions—on the islands of Öland and Gotland. The largest polygons (more than 5 m in diameter) are found chiefly in the southernmost part of the Swedish Caledonides.

Nonsorted polygons, formed by contraction, occur mainly in northern part of the Caledonides, and are generally rather small—about 1 m in diameter. Ice fillings in the polygon fractures, probably ice-wedge polygons, have been observed but it is uncertain whether the ice is permanent. It probably thaws during warm summers, leaving the structure preserved as differences within the soil.

The lower limit of these features rises from about 400 m above sea level in northernmost Sweden to 1000 m in the southern part of the Swedish Caledonides. The upper limit is determined by the lack of soil.

Sorted and nonsorted steps are most typically developed as more or less lobate terraces formed by solifluction. Other types, which are sloping-ground equivalents to mud circles and other phenomena, occur more rarely. The most common type has, in general, a bulging front where a concentration of boulders (sorted steps) sometimes occurs. The area of distribution comprises the whole of the Caledonides, from the timber line up to a limit rising from 1100 m above sea level in the north to 1400 m in the south.

Sorted stripes are found over the whole Caledonian range from the highest levels to areas far below the timber line.

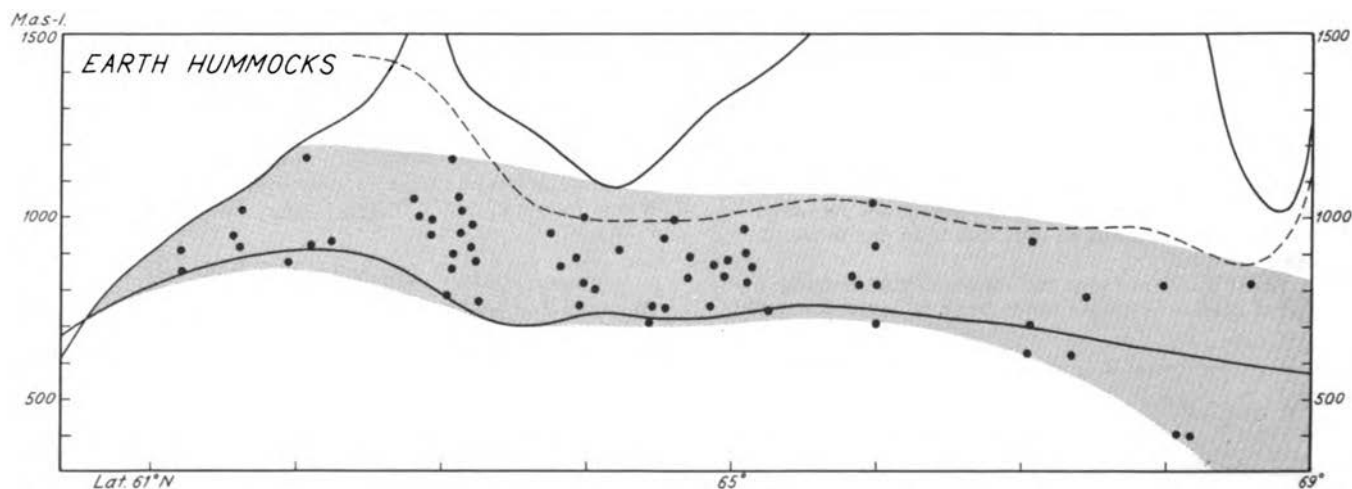

Fig. 1. Vertical distribution of earth hummocks in the Swedish Caledonides. The upper line shows the approximate upper surface of the mountain range, the lower line the approximate timber line, and the broken line the approximate lower limit of a zone with intensely frost-splintered bedrock. The zone with earth hummocks is shaded. Scattered localities with earth hummocks occur outside the range at much lower elevations

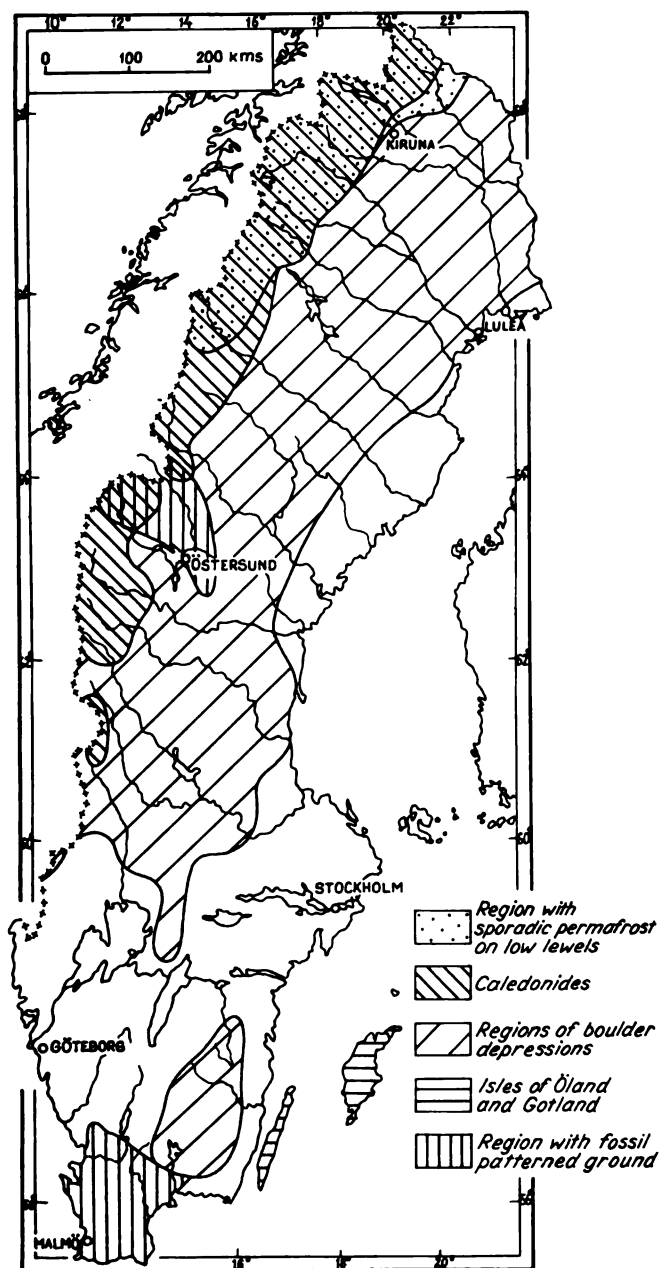

Fig. 2. Regional division of Sweden based on patterned ground

Nonsorted stripes are generally not well developed. A distinct type is stripe hummocks, probably closely related to earth hummocks though formed on sloping ground. Their distribution is unknown.

Sorted cracks are straight lines with a concentration of boulders. They exist on nearly level ground, are independent of slope, and belong to the same region, the southern part of the Swedish Caledonides, as the best developed sorted polygons.

Nonsorted cracks are a very rare boulder-free variant of the sorted cracks. Distribution and formation are unknown.

Sorted fields. Boulder fields derived from frost-splintered bedrock are found in the highest parts of the Caledonides, but the only type of sorted fields discussed here are boulder depressions. These are flat fields, situated chiefly in shallow depressions, with a surface of pure boulder material which gradually decreases in size downward [3]. Diameter of the depressions may range from a few to hundreds of meters.

No sharp limit divides the smallest boulder depressions and large stone pits.

Boulder depressions are found mainly below the timber line within two distinct areas (Fig. 2). They are also found above the timber line, often covered with water. Below the timber line they occur so far below the highest coastline that clearly they were formed in a climate at least as mild as the present. The lowest localities were still below sea level during the postglacial climatic optimum.

Nonsorted fields are structureless but clearly frost-affected ground that can be identified by determining the long axes of the stones. These are oriented in the direction of the slope instead of ice movement or related factors. Most of the structureless ground above and immediately below the timber line is of this type which is also common at lower levels. The exact distribution is unknown. In many areas the frost action probably took place soon after deglaciation.

REGIONS OF PATTERNED GROUND

A suitable division of patterned ground in Sweden is shown in Fig. 1.

Sporadic Permafrost

Permafrost occurs in the highest parts of the Caledonides. There are active glaciers as far south as lat. 63°N and here permafrost areas are small and only situated at high levels. In northernmost Sweden and in valleys in the northern part of the Caledonides, permafrost is observed also at lower levels, well below the timber line. Generally, the region is climatically enclosed by the isotherm for a mean annual temperature of -1°C or -2°C.

Frozen mineral soil is found in scattered drillings and excavations, but the most common permafrost is the palsen, hillocks with alternating layers of ice and peat in the bogs. They are found mainly in the eastern part of the northern Caledonides and some distance east of the Caledonides. The upper limit of palsen distribution is determined by the lack of peat at high levels. The lower limit rises from about 300 m above sea level in the north to 600 m in the southernmost localities.

Nonsorted polygons are characteristic of this region, but their distribution differs from that of the palsen. They are restricted to the area above the timber line and extend further south in the Caledonides than the palsen. There they occur even south of the permafrost region.

Caledonides

Patterned ground is developed best in the Caledonian Mountain Range above the timber line. All the above-mentioned types of patterned ground occur within this region, though often only at limited altitudes. They are evenly spread over the whole area—except for nonsorted polygons. The best developed large sorted polygons and the cracks seem to be most abundant in the southern part of the range.

Boulder Depressions

Sorted polygons, circles and nets, earth hummocks, and sorted stripes are also found in this region, though only in favorable positions. The first three types are found mainly on lake shores below mean water level.

Apparently a connection exists between the region in question and the highest coastline, but this does not hold true in detail. Boulder depressions occur on much lower levels.

Islands of Gotland and Öland

On these Baltic Islands small sorted polygons and nets occur despite the comparatively mild climate (mean annual temperature about 7°C).

Fossil Patterned Ground

In the southernmost part of Sweden, fossil patterned ground is observed as ice-wedge casts, involution structures, and similar phenomena. These indicate an arctic climate entirely different from the present-day mild climate. They were probably formed periglacially during the cold Older Dryas period [4] which ended in approximately 10,200 B.C. A few scattered observations in central Sweden indicate similar periglacial conditions at a later stage (probably about 6700 B.C.).

Rest of Sweden

No permanent patterned ground is known in the rest of Sweden. Earth hummocks may occur in favorable positions but their distribution is unknown.

FACTORS CONTROLLING DISTRIBUTION

Local Conditions

In detail, the possible formation of different patterns and the types developed do not seem to follow climatic lines. They are probably ruled by local factors, mainly soil composition, boulder content, gradient, vegetation, and relation to the water table. The outlines are probably determined climatically.

Soil conditions probably have little effect, since some patterns can obviously be formed even in ground with very little frost-heave susceptibility. Patterned ground can be found even in rather pure, coarse gravel. Thus some patterns, especially miniature forms, are found on glaciofluvial deltas in the Caledonides. Solifluction steps, however, seem to be best developed in fine grained soil, and tend to be more common in soil cover derived from loose, mica-rich schists than in regions with hard, more siliceous rocks [1, Fig. 2].

If boulders are not extremely numerous and large they will not present patterned-ground formation. Well developed patterns are found even on very bouldery shores and on boulder fields. Boulder frequency, however, affects the pattern formed. Some types (stone pits and sorted circles, nets, polygons, steps, and stripes) are restricted chiefly to boulder-rich ground. Other types (mud circles, earth hummocks, nonsorted polygons and steps, and others) are observed only on ground with few or no boulders.

Slope conditions affect pattern form. Symmetrical nets, polygons, and circles occur on flat ground. The steeper the slope, the more elongated the patterns; extreme forms (steps and stripes) are entirely restricted to sloping ground.

Some types (earth hummocks, mud circles, stone pits, sorted and nonsorted steps) seem to require vegetation. If this is absent, other types are formed under otherwise similar conditions. Solifluction steps and earth hummocks require some vegetation—or stone mantle—to keep the soil collected in terraces or hummocks and preserve the forms. Some types, such as mud circles, depend entirely on the vegetation in scars where they form.

The close relation between patterned ground and vegetation is especially evident in the lower parts of the Caledonides. Herbs and shrubs there are rather thick, so patterns formed by sorting processes are found mainly in shallow depressions which are usually covered by water. Autumn is almost the only time they are dry.

The water table affects pattern formation in two ways: (a) A shallow depth to the water keeps the soil moist and facilitates formation of patterns requiring movements of fines in the soil. (b) If the water table emerges at the surface most of the year it also prevents the growth of thick vegetation and thus facilitates formation of patterns requiring absence of vegetation. This is true chiefly for the area above the timber line, where fen growth is very weak. In low and sometimes in high regions, bogs develop in similar positions, and patterned ground does not form.

Vegetative protection does not consist of plants alone. The roots probably contribute to ground stability; and the vegetative cover traps snow, thus making a thicker snow cover than

on bare ground..

The above conditions were observed and used in classifying patterned ground [5, 6, 7]. They probably result in zonation of the patterned ground, which is often found in alpine and subalpine regions.

Pattern types that develop in the absence of thick vegetation are found at the highest elevation where soil exists. In favorable positions, such as lake shores, boulder fields, and the like, they may develop even below the timber line.

Pattern types that develop in a coherent vegetation cover are absent at high levels because thinning of the vegetation creates a distinct upper limit. At low levels, on the other hand, thicker vegetation protects the ground against frost action, thus setting a lower limit. In favorable localities, however, some pattern types extend to much lower elevations.

If too small an area is observed, one might falsely conclude that climatic conditions caused the zonation. For instance, a lower limit of sorted polygon distribution is often observed within small areas at some distance above the tree line. A close search, however, generally shows that sorted polygons are well developed far below the tree line.

In Sweden the most easily observed limits of most pattern types do not follow climatic form lines, such as isotherms, but climatic conditions allow the formation of most types in a much larger part of Sweden than is generally observed.

These statements are purely typological. Some complex patterns, such as sorted polygons, circles, and nets, can be formed by different processes. This, however, does not necessarily imply that all processes take place within the whole of Sweden.

Although we know little of the age of most pattern formations, we do know that some are fossil, others active. However, the altitude above sea level and occurrences on lake shores clearly show that patterns must have formed under climatic conditions at least as mild as the present, because during colder periods the areas were located below sea or lake level, and the patterns would have been destroyed by wave action or sedimentation. If the formations are older they must derive from an even milder period than the present. Further scrutiny shows that, except for fossil patterned ground in southern Sweden, all pattern types can probably be formed under present climatic conditions where they are found—even if, in certain instances, they are fossil.

The Falun region 200 km northwest of Stockholm [1, 3, 8] supplies a good example. Factory smoke has killed vegetation over a limited area. Not only boulder depressions but also sorted polygons and stripes have formed. This region is situated far from the Caledonides and at a relatively low level where such patterns are not formed generally, except on lake shores and the like.

CLIMATIC CONDITIONS

Climatically determined limits of patterned ground do not follow climatic isolines exactly, because of local factors.

The limit of the northern area of boulder depressions (Fig. 1) follows the general course of isotherms. Assuming that low temperatures are necessary for pattern formation, we find good correlation between the limit and the -5°C or -4°C isotherm for February. This temperature is necessary for the formation of boulder depressions, earth hummocks and sorted polygons, circles, nets, and stripes.

The southern area and the Baltic Islands are extrazonal [9] exceptions, caused by especially favorable conditions.

Sparse vegetation and a thin soil cover on flat bedrock offer especially good conditions for formation of some patterns. Under prevailing conditions a somewhat higher temperature is sufficient, such as -3° or -4°C (February mean temperature) in southern Sweden and -1°C on the Baltic islands.

The correlation with the mean annual temperature is poor, but the limit of the northern area corresponds roughly to the isotherm for 4°C , while the southern area is marked by the 5.5°C isotherm.

Solifluction steps are to a great extent restricted to immediately above the timber line. This is supposedly an effect

of edaphic factors, but the climate may also be restrictive. No special isotherms follow the area limits with solifluction steps, but precipitation is much greater there than in the rest of Sweden, in both winter and summer. Melting snow and direct saturation by rain water probably contribute to solifluction. Thus the lower limit of solifluction steps is determined climatically, whereas the upper limit is determined by sparse vegetation.

Nonsorted polygons, formed by contraction, have a distinct lower limit and regional distribution in the Caledonides north of lat. 63°N. The edaphic or soil conditions are the same within and without the area, so the limit must be climatic.

Polygon formation is most probably favored by low or near freezing temperatures. A low summer temperature also helps preserve ice-wedges in polygon fissures. Such an assumption agrees well with the distribution. This pattern occurs in a cold region, though not the coldest in the winter season. In spring and summer it is coldest with a May temperature of 0° or 1°C. From October to April the mean temperature is below zero and from June to September, never above 10°C. The area is also well enclosed by the isotherm of about -3°C mean annual temperature.

A thin snow cover in the winter might be important, but no relation between this and the distribution of the polygons is observed.

Possibly the formation of mud circles is climatically determined in a similar way, but insufficient knowledge about distribution precludes further discussion.

Very large, strictly angular polygons as well as linear features (cracks) seem to be restricted to the southernmost part of the Swedish Caledonides, though knowledge of distribution is incomplete. In fact, this area has the most pronounced local continental climate in Sweden, having winter temperature anomalies of -3°C. In the rest of the Caledonides the climate is more maritime, having positive winter temperature anomalies. This may have some effect on pattern formation.

Low winter and autumn temperatures combined with low precipitation may also explain pattern distribution. The mean temperature from December to February is about -10° to -12°C, and winter precipitation is equal to or less than 50 mm per month; these conditions probably favor fissure formation by frost contraction.

Palsen have a climatic distribution similar to but not coincident with that of the nonsorted polygons and other permafrost. Palsen formation requires greater winter heat loss than summer heat gain. Consequently, palsen thrive in regions of relatively low summer temperature, where maximum temperature is reached for a few days only. The length of the winter season is important since the area with palsen is well

enclosed by a subzero temperature curve for 200 to 210 days a year. Exceptions occur where the summer temperatures are especially high, as in the Kiruna region. Correlation with the mean annual temperature is not complete, but generally palsen occur where it is lower than -2° or -3°C.

Winter precipitation and snow cover thickness also affect palsen formation. Under favorable temperature conditions, palsen are absent in areas where precipitation from November to April exceeds 300 mm, or where the mean snow cover thickness exceeds 120 cm. Local exceptions occur if wind conditions result in a thinner or thicker snow cover than in surrounding areas.

CONCLUSIONS

Some limits of patterned ground and permafrost are climatically determined. Other apparent limits within Sweden, such as the restriction of some patterns to the Caledonides, are due chiefly to edaphic factors. These limits are related to the climate only because vegetation type depends on the climate. These statements refer only to areas like Sweden, a relatively broad fringe area of the Arctic. They are probably not valid in the Arctic itself or in narrow fringe areas. In the Arctic the sparse vegetation probably has less effect on patterned ground than the colder climate.

REFERENCES

- [1] Jan Lundqvist. "Patterned Ground and Related Frost Phenomena in Sweden," *Sveriges Geol. Undersökn.*, C 583, 1962, pp. 1-101.
- [2] A. L. Washburn. "Classification of Patterned Ground and Review of Suggested Origins," *Geol. Soc. Am. Bull.*, Vol. 67, 1956, pp. 823-865.
- [3] G. Lundqvist. "Blocksänkror och några andra frostfenomen," *Geol. Fören. Förhandl.*, 73, 1951, pp. 505-512.
- [4] G. Johnsson. "Periglacial Phenomena in Southern Sweden," *Geograf. Annal.*, 44, 1962, pp. 378-404.
- [5] G. Beskow. "Erdfliessen und Strukturböden der Hochgebirge im Licht der Frosthebung," *Geol. Fören. Förhandl.*, 52, 1930, pp. 622-638.
- [6] G. Lundqvist. *De svenska fjällens natur*, Stockholm, 1944.
- [7] G. Lundqvist. "The Orientation of the Block Material in Certain Species of Flow Earth," *Geograf. Annal.*, 31, 1949, pp. 335-347.
- [8] G. Lundqvist. *Falutraktens geologi och gruvbrytningens början. Falu gruvas ålder i geologisk och arkeologisk belysning*, Uppsala, 1963, pp. 5-56.
- [9] Carl Troll. "Strukturböden, Solifluktion and Frostklimate der Erde," *Geol. Rundschau*, 34, 1944, pp. 545-694.

SOLIFLUCTION AND AVALANCHES IN THE SCANDINAVIAN MOUNTAINS

ANDERS RAPP, University of Uppsala, Sweden

The cold and treeless part of the earth's surface at high latitudes or at high altitudes is called the periglacial zone. It does not include the ground covered by glaciers. During the last few decades both geomorphologists and engineers have shown increasing interest in this environment. At least three reasons explain this: (1) The periglacial zone, particularly its maritime subarctic part, probably has the most rapid denudation of all climatic zones, due mainly to frost weathering and solifluction. (2) Such periglacial processes and slope wash have probably aided the development of land forms in wide areas outside the Quaternary inland ice sheets, e.g., in central Europe and North America. (3) Periglacial processes are also of practical interest to engineering design in high latitudes or altitudes.

One very informative project on periglacial mass-wasting was the continuous recording of exogene processes acting on slopes of the Kärkevagge trough valley in northern Scandinavia [1]. The valley is situated above the forest limit on mica-schist bedrock; climate is maritime arctic; annual precipitation is about 1000 mm; latitude is 68°26'N. Permafrost is not found here. Annual recordings of the actual denudation in test areas started in 1952; some recordings have continued since 1961, by L. Annersten and L. Tjernström [2, 3].

The active exogene processes are frost and chemical weathering, rockfalls, snow avalanches, earth slides, mud-flows, talus-creep, solifluction, running water, and wind.

A more detailed discussion of these exogene processes is given [1]. Only two main processes are discussed; solifluction, which is an example of a continuous process, and snow avalanches, which are sporadic and momentary.

SOLIFLUCTION

Solifluction was originally used by J. G. Andersson [5] who defined it as the "slow flowing from higher to lower ground of masses of waste, saturated with water" and considered it a chief agent of denudation in cold climates. The term was later used in a wider sense for slow soil-flowing in temperate and tropical regions. Some authors also include rapid movements, such as obvious mudflows and slides. To avoid confusion, new terms have been proposed for the cold-climate solifluction, such as congelifluction [6], gelisolifluction [7], and gelifluction [8]. Solifluction is used in this report.

Frost action in the ground is often indicated on the surface by different types of patterned ground [3]. On horizontal ground these develop as circles, nets, and polygons; but on sloping ground they are elongated downslope or are represented by different types of steps, terraces, lobes, and stripes. Downslope movements seem to occur from minimum inclinations of about 2° to 3° [9, 10]. The transition from flat ground patterns to downslope solifluction forms is often obvious in the field. There seems to be a close relationship between frost heaving and similar cryoturbation processes on flat ground and solifluction on slopes. Most ground above the forest limit is probably affected by movements caused by frost, although there are widespread areas where no structural pattern has developed. Lundqvist says, "the only areas where the ground is not affected by frost action to any appreciable degree are probably especially well-drained regions. Such areas are coarse-grained and well-drained till, hummocky ablation moraines..., deposits of glaciofluvial or wave-washed gravel" [11].

This quotation indicates that solifluction, as well as frost heaving, is facilitated by fine grained soil, especially with a high content of silt and an abundant supply of water [12, 13, 14]. Both sorting and heaving, due to frost action, are possible in soils with particles larger than 0.07 mm, as shown in laboratory experiments by A. Corté (see article in this volume).

According to experiments by Beskow, frost-heaving depends upon the formation of ice layers parallel to the surface. Water is drawn from adjacent earth to the growing ice layer. Thus both water content and volume increase. Solifluction movements occur mainly during spring thaw but also at autumn freeze [15, 16]. The main movement is probably a viscous flow, at least in the lobes, as is shown by the flow lines of lobe S11 in Fig. 1. Detailed measurements of solifluction movement at Mestersvig, Greenland, show a clear dominance of flow, not of heave-subsidence [17].

Measurements of Solifluction Movements

In Kärkevagge, solifluction movements were recorded by annual checking of markings in downslope and transverse test lines (Fig. 1). Three types of markings were used: (1) Oil paint on boulders and cobbles (in many cases the stones move more rapidly than the ground itself, probably due to stronger frost-heaving and needle ice action). (2) Wooden stakes driven vertically 40 to 50 cm into the ground. (3) Stakes driven 15 to 20 cm into the ground. To these markings for recording surficial movement, test pillars were later added [9, 18] for checking the vertical velocity profile in the ground.

In Fig. 1 the stakes are drawn as small circles. They form two downslope lines over the talus cone onto the solifluction slope below. The interval between two stakes in each line is about 20 to 40 m. Between the two downslope lines there are several transverse lines of painted markings on stones or small stakes in the ground (Fig. 1, III).

Positions of the markings were checked with a steel tape once every summer. Measurements were started from a fixed point (FO) on the rockwall, 1.5 m above the talus top. By using two plumb bobs the accurate distance between the stakes in the downslope line was measured 30 cm above the ground. Measurements are estimated as accurate to ± 0.5 cm per measured length. Lines should be checked from fixed points in bedrock at the lower as well as the upper end of the line. This method is, however, recommended chiefly for recording movements in talus slopes, where no fixed points occur on the talus mantle. Recently a more accurate measuring method was established in a test field arranged by the author and L. Tjernström in 1962 at the Tarfala field station in the Kebnekaise mountains of northern Sweden. Straight and nearly horizontal lines are established by oil paint on the talus slopes and by oil paint, wooden pins, and test pillars on the lower till-covered slopes. Wooden pins were driven about 15 cm into the ground. Each test pillar was about 0.7 to 0.9 m long, consisting of wooden cylinders, 1.2 cm in diameter and 2 cm in length. The lines are checked by theodolite readings from fixed points in bedrock [17] combined with straightened, thin wire fastened to bedrock fixes at both endpoints. Wire straightening is checked in the theodolite. On every stone crossed by the fixed wire a line 1 to 2 cm wide is painted and located vertically from the wire by a plumb bob.

The above methods concern actual movements. An attempt to measure the total solifluction movement during the post-glacial period was made by T. Lindell in a study of ancient ice-lake shorelines at Lake Grövelsjön, Dalecarlia, central Sweden [19]. Shorelines were formed during the deglaciation, probably about 8000 years ago. Most are still distinct, horizontal lines of clean-washed boulders and show no deformations; but in the wetter parts of the slope, solifluction has moved the lines downslope about 1 to 9 m. The soil material is a wave-washed quartzitic till with only about 10 to 20% of silt and finer grains. Inclination of the slope with deformed shorelines is as high as 25 to 33°. Thus the soil is only slightly susceptible to solifluction, judging from the grain-size composition. Movements are probably fossil and of a

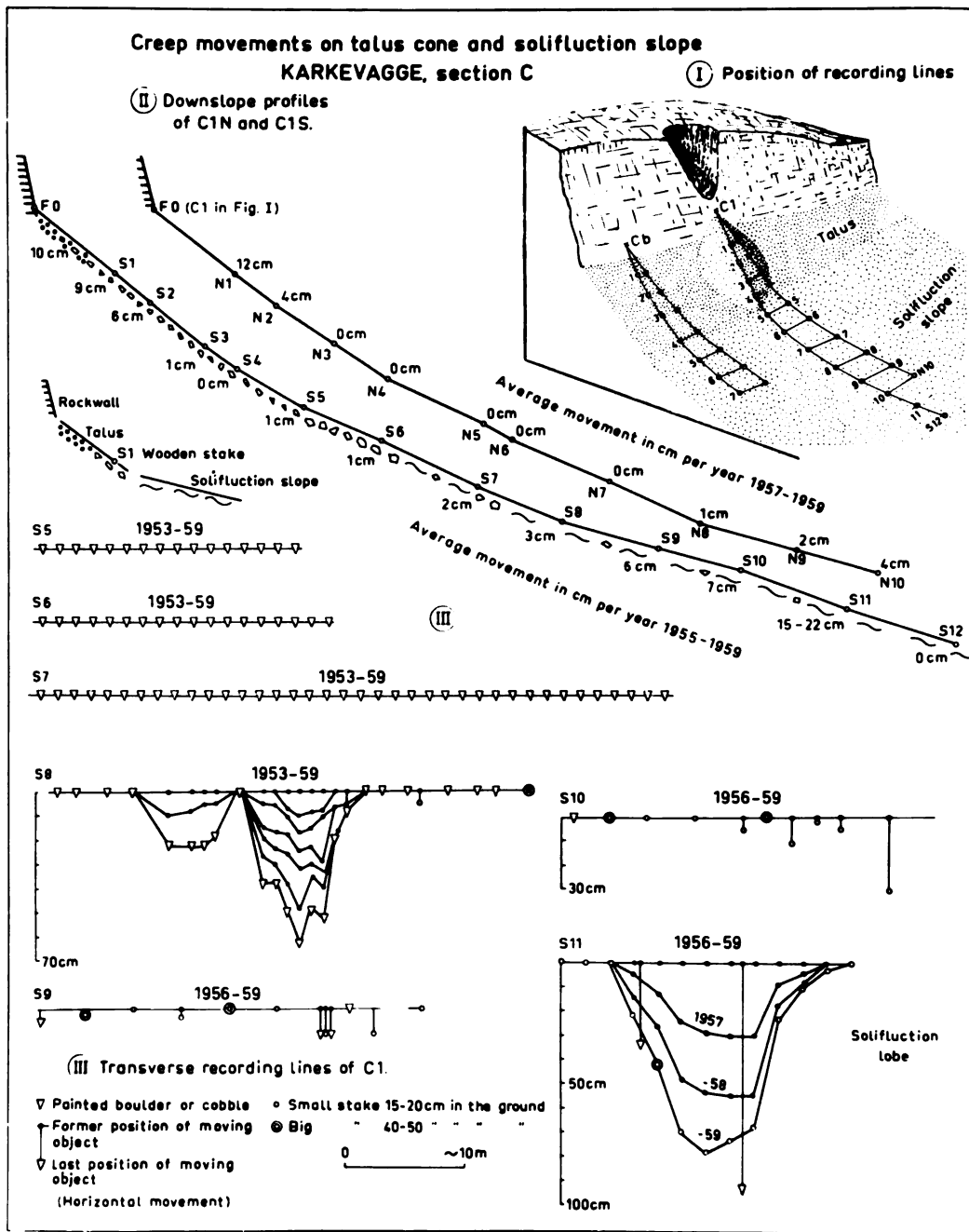

Fig. 1. Creep and solifluction movements

colder or more humid period than today, as a well developed podzol profile covers this slope now.

In the Canadian Arctic most raised shorelines are evidently undisturbed by creep and solifluction, but in some places solifluction lobes transgress raised beaches by several times the 9 m distance given above [30].

The most rapid solifluction movements recorded in Kärkevagge are from test lines C1 and Cb (Fig. 1), while recordings along the two C1 lines show almost no movement at the talus base. Stability there and somewhat downslope is confirmed by transverse lines S5 and S6 which are straight and have shown practically no deformation for nine years. Line S7 shows local movements of about 10 cm from 1959 to 1962. Lower, surficial movement is increasing 4 to 7 cm per year and has a maximum of 25 to 30 cm per year in lobe S11. Movement of such a lobe is perhaps cyclical and of short duration, but this one shows similar movements from 1956 to 1962. Here the content of silt and finer grains is as high as

30 to 40% of grains finer than 40 mm. It is very susceptible to frost-heaving and solifluction, having an abundant supply of melt water from many large snowdrifts higher on the slope. Probably, the shape of the mineral grains also facilitates solifluction; most are small mica slabs, which seem to be ideal for creep and soil flow. Consequently, solifluction here is extremely rapid. Average inclination of the slope is about 15 to 25°.

Many transverse lines show that water saturation facilitates solifluction. Generally, small depressions and other paths with much water during snow melting also show the most rapid movements.

The vertical velocity profile of moving soils is being checked with Rudberg's test pillars in and around Kärkevagge, and also in the Västerbotten mountains and at Tarfala, Kebnekaise. Some results from Rudberg's measurements in Kärkevagge and adjacent localities were reported recently [9], indicating a common depth of the moving layer of about 50 to

60 cm. Average surficial movement varies from 0 to 7.5 cm per year.

Another indication of solifluction and thickness of the affected layer is obtained by analysis of the orientation of oblong stones on sloping ground. Solifluction clearly turns stones in the direction of movement [20], and both above and below the highest marine limit, stones in Sweden commonly point downslope in the upper decimeters of till [18].

Solifluction Conclusions

The rate of actual solifluction movement on favorable sites (fine grained till, high ground water level) in Scandinavian mountains varies from 0 to 8 cm per year, in extreme cases as much as 30 cm per year, as recorded on ground inclined from 10° to 30°.

Movement is most rapid at the surface and decreases toward zero at about 50 to 60 cm depth in most cases.

Total ground movement due to solifluction and similar causes during the whole postglacial period is 1 to 9 m in late glacial shorelines at Grövelsjön, Dalecarlia, in rather coarse grained till. Most shorelines had not moved measurably.

Most solifluction recordings in Swedish mountains indicate the same magnitude as those reported from measurements by other authors [9, 10, 14, 15, 16, 17]. These studies indicate that solifluction on favorable sites causes yearly surficial movement from a few centimeters to decimeters. These values are lower than those supposed by some who have overestimated the effect of solifluction and judged from distinct surface forms.

AVALANCHES

Snow avalanches are rapidly moving masses of snow, either sliding or falling [21, 22, 23].

Although the term "avalanche" has also been used for other types of mass movements without snow, e.g., "debris avalanches" [24], I use the term only for mass movements of snow, more or less pure. White avalanches consist of clean snow, meaning that they have no erosional effect. Dirty avalanches consist of snow mixed with waste of eroded debris, plants, etc.; hence, dirty avalanches have direct geomorphic influence.

Geomorphic activity of avalanches is very important in many mountains, although often overlooked by both geomorphologists and engineers. From Table I and from the very distinct traces of avalanche erosion on the ground it is obvious that snow avalanches are a great mass-wasting agent in the higher parts of the Swedish Caledonides [1, 25] as well as in many other mountain areas.

Table I. Quantities moved per year by momentary mass movements in Kärkevagge, 1952-1960

	Tons moved (per sq km)	Ton-meters ^a
Earth slides	43	20 000
Mudflows	26	76 000
Avalanches	15	22 000
Rockfalls	9	19 500

^aVertical movement times tons equals ton-meters

The most powerful and dangerous type of avalanche is very likely the slush avalanche. Probably a close relationship exists in the mechanism of movement between these and the "slushers" or "slushflows" known from Greenland and Arctic America as debris-carrying processes [26, 27] but also as flows of clean slush on glaciers.

Slush Avalanches

Slush avalanches in Kärkevagge have all occurred in a late phase of spring, during rapid snow melting. They were released by melt water that saturated the thick snow cover on icebound thresholds in brooks or small streams. Powerful and far reaching, they consist of large masses of very wet and

heavy snow, iceblocks, water, and often include large quantities of soil and rock, eroded from their substratum. They mark the catastrophic opening of the ice- and snow-dammed brooks to the spring flood.

Rockfall debris is roughly sorted (small particles tend to be deposited high on the slope; boulders, lower down). Avalanche debris is totally mixed—finer grains, boulders, earth, and plant fragments all over the deposition tongue. Mixed debris on high boulders, covered by dirty snow before melting, is typical. Erosion marks in the ground such as pits, scratches, and parallel grooves, plowed by gliding boulders also indicate avalanche activity. Below the forest line, avalanche tracks are easy to recognize as open paths in the forest, often with bent and broken trees.

Slush avalanches have occurred in Kärkevagge. In area 1 shown in Fig. 2, each of two avalanches transported more than 200 cu m of soil and rock 500 m out onto gently sloping ground in the valley bottom. Testifying to the transporting capacity of the 1958 avalanche, one boulder, measuring 5 by 3 by 2 m with an estimated weight of 75 tons, was moved 120 m down a slope of only 5° inclination. Thus large boulders on flat alluvial fans in the high mountains of Lapland could have been deposited there by slush avalanches rather than by torrents or mudflows. Consequently, care should be taken to avoid locating roads, railways, powerlines, and houses where slush avalanches can be expected. Their large size and high density enable them to extend surprising distances on flat ground in the valley bottoms.

Tracks of these avalanches can be traced in summer surveys and, in obvious cases, from interpretation of aerial photographs. The brook course and erosional and depositional features on the lower parts of their tracks are clear proofs of sporadic and powerful avalanches on certain alluvial fans or valley bottoms.

Slush Avalanches on the Kiruna-Narvik Railway

The lists of traffic disturbances on the Kiruna-Narvik railway are mainly reports of white and dry avalanches, causing many expensive traffic delays (as at Mt. Nuolja near Abisko). They are most frequent in March. Another maximum in May is due to slush avalanches, judging from descriptions in the reports and from the topography by the two tracks of the late avalanches. One track is situated on Mt. Kaisepakte, east of Abisko, the other at Kvitur, 24 km from Narvik, both where steep brooks cross the railway line in a course of the same type as the one in Kärkevagge (section V, marked as No. 1 in Fig. 2).

In Table II some data [1] concerning the Kaisepakte and the Kvitur avalanches are quoted from the railway reports. At Kvitur a roof was built above the railway as protection against the avalanches and at Kaisepakte other artificial protection was constructed. On two occasions rails were torn off the railway bank by avalanches.

AVALANCHE CATASTROPHE

Coal has been mined at Longyearbyen, Spitsbergen, since the beginning of this century. During World War II the village of Longyearbyen was destroyed by military forces. After the war a group of houses, including the hospital, was built on a small alluvial fan, which seemed to offer safer and drier ground than the outwash plain that filled most of the valley bottom nearby. The alluvial fan is situated in front of a small tributary valley or ravine, about 2 km long from its beginning on a glacier free mountain plateau (400 m above the main valley) to its mouth with the fan and houses (Fig. 3).

Years passed without any remarkable flows or slides, but on June 11, 1953, the houses were smashed by a wet avalanche, carrying rock debris and iceblocks. The description of the event [28], the shape of the little valley and alluvial fan, and the time of the catastrophe indicate that a slush avalanche was released by snow supersaturated with melt water higher in the tributary valley. Three persons were killed and 12 injured.

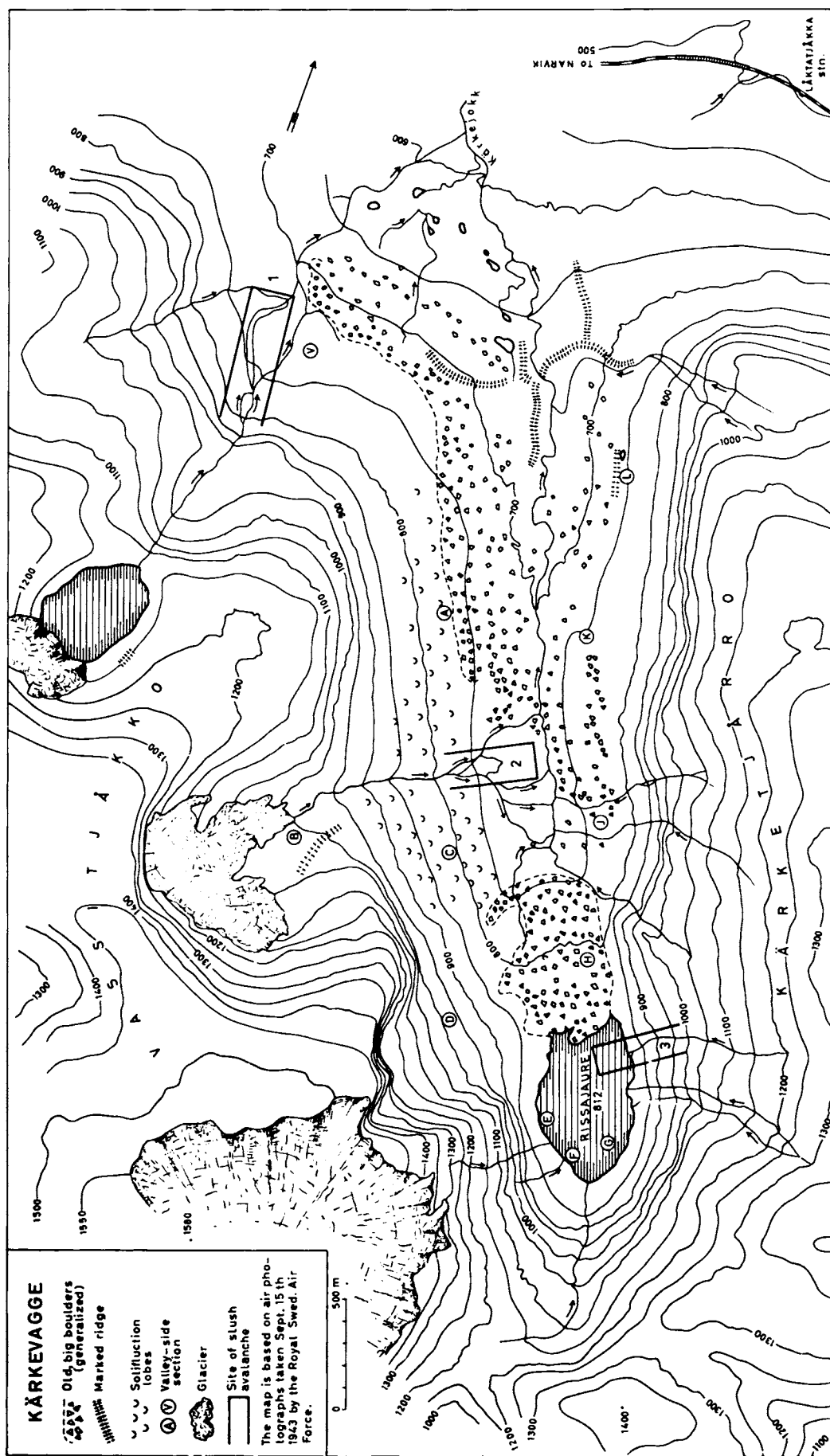

Fig. 2. Map of the valley of Kärkevagge, Lapland. Heights are in meters. The valley mouth is facing north. Note the rectangles showing sites of slush avalanches at three typical tracks. 1. Brook with large gradient from small lake of the mountain. Avalanches 1956 (June 12), 1958 (June 19-22), and 1962 (date unknown). 2. Brook with moderate gradient from small cirque glacier. Avalanches in 1953 (June 11) and 1956 (June 12)

Table II. Probable slush avalanches on the Kiruna-Narvik Railway at Mt. Kaisepakte (Nos. 1 to 5) and at Kvitur (Nos. 6 to 8)

Number	Date	Remarks
1	May 1916	Line blocked by snow, earth, and rock waste. Traffic halted one day.
2	May 25, 1929	Snow, earth, boulders, tree trunks in a mass up to 2.5 m thick and 100 m broad. Rails were torn up for 30 m. Traffic halted one day.
3	May 28, 1934	Two avalanches at 2-hour interval. Traffic halted 14 hours.
4	May 18, 1938	Small avalanche. Traffic halted 1 hour.
5	June 2, 1940	Small avalanche.
6	May 27, 1917	Rails torn up for 70 m.
7	May 5, 1919	
8	May 27, 1958	Snow, boulders, earth in a 200 m broad cover.

REFERENCES

[1] A. Rapp. "Recent Development of Mountain Slopes in Kärkevegge and Surroundings, Northern Scandinavia," *Geogr. Annaler*, Vol. 42, Nos. 2-3, Stockholm, 1961, pp. 138, 145, 169, 173, 185.

[2] L. Tjernström. "Registrering av creep-rörelser," Dept. of Geog., Uppsala, 1963, unpublished data.

[3] L. Annersten, Uppsala, Priv. comm.

[4] A. L. Washburn. "Classification of Patterned Ground and Review of Suggested Origins," *Geol. Soc. Am. Bull.*, 67, New York, 1956.

[5] J. G. Andersson. "Solifluction, a Component of Sub-aerial Denudation," *J. Geol.*, Vol. 14, Chicago, 1906, p. 95.

[6] J. Dylík. "Some Periglacial Structures in Pleistocene Deposits of Middle Poland," *Bull. Soc. Sci. et Lettres de Lodz*, Lodz, 1951.

[7] W. Czajka. "Lage- und Materialbestimmtheit von Frostmusterböden," *Kinzi-Festschrift, Schlern-Schriften* 190, Innsbruck, 1958.

[8] L. E. Hamelin. "Periglaciaire du Canada," *Coll. de Géog. de Quebec*, Vol. 10, Quebec, 1961, p. 63.

[9] S. Rudberg. "A Report on Some Field Observations Concerning Periglacial Geomorphology and Mass Movement on Slopes in Sweden," *Biul. Peryglac.*, 11, Lodz, 1962, pp. 313, 317-320.

[10] J. Büdel. "Die Frostschutt-Zone Südost-Spitzbergens," *Colloq. Geog.*, Bd 6, Bonn, 1960, p. 61.

[11] J. Lundqvist. "Patterned Ground and Related Frost Phenomena in Sweden," *Sveriges Geol. Unders.*, C:583, Stockholm, 1962, p. 64.

[12] G. Beskow. "Erdfließen und Strukturböden der Hochgebirge im Licht der Frosthhebung," *Geol. Fören. Förhandl.*, Stockholm, 52:4, 1930.

[13] P. J. Williams. "Some Investigations into Solifluction Features in Norway," *Geog. J.*, 123:1, London, 1957, p. 47.

[14] P. J. Williams. "An Investigation into Processes Occurring in Solifluction," *Am. J. Sci.*, 1959.

[15] J. Smith. "Cryoturbation Data from South Georgia," *Biul. Peryglac.*, 8, Lodz, 1960.

[16] A. Jahn. "Quantitative Analysis of some Periglacial Processes in Spitzbergen," *Nauka o. Ziemi II*, Ser. B:5, Warszawa, 1961, p. 14.

[17] A. L. Washburn. "Instrumentation for Mass-Wasting and Patterned-Ground Studies in Northeast Greenland," *Biul.*



Fig. 3. Houses shown before they were hit by a large avalanche from valley in the background. Photograph by R. Gardi from P. Haupt, Bern [29]

Peryglac., 8, Lodz, 1960, pp. 59-64; also priv. comm. in Nov. 1963.

[18] S. Rudberg. "Some Observations Concerning Mass Movements on Slopes in Sweden," *Geol. Fören. Förhandl.*, 80:1, Stockholm, 1958, pp. 116, 123.

[19] T. Lindell. "Den postglaciala deformationen av issjöstrandlinjer vid Grövelsjön," Uppsala, 1962, unpublished.

[20] G. Lundqvist. "The Orientation of the Block Material in Certain Species of Flow Earth: Glaciers and Climate," *Geogr. Annaler*, Stockholm, 1949, p. 346.

[21] "Snow Avalanches," *Agr. Handbook No. 194*, Forest Service, U.S. Dept. of Agr., Washington, 1961.

[22] A. Allix. "Avalanches," *Geog. Rev.*, 1924.

[23] R. Haefeli, M. de Quervain. "Gedanken und Anregungen zur Benennung und Einteilung von Lawinen," *Die Alpen*, Hft. März-April, Bern, 1955.

[24] C. F. S. Sharpe. *Landslides and Related Phenomena*, New York, 1938.

[25] A. Rapp. "Avalanche Boulder Tongues in Lapland," *Geogr. Annaler*, 41:1, Stockholm, 1959.

[26] L. H. Nobles. "Classification of Rapid Mass Movements," *Geol. Soc. Am. Bull.*, 70:2, 1959, p. 1652.

[27] A. L. Washburn, R. P. Goldthwait. "Slushflows," *Geol. Soc. Am. Bull.*, 69:2, 1958, p. 1657.

[28] L. Balstad. "Kvinna på Svalbard," *Frum*, Stockholm, 1956, pp. 262-266.

[29] R. Gardi. "Spitzbergen," Haupt und Katzmann, Bern/Tübingen, 1952.

[30] J. Fyles. Ottawa, priv. comm.

ORIGIN OF STRING BOGS

ERWIN SCHENK, Giessen, West Germany

String bogs are muskegs with undulating surfaces (Figs. 1 and 2). In Europe they are called aapa-moor, strangmoore (string bogs), and ringmoore (ring moor). They are widespread in the boreal, needle-tree forest zone of the northern hemisphere. Their topography is characterized by lenticular hummocks and depressions, by long and low ridges, and by long and shallow holes or ditches. Both features are covered with distinct plant communities; each is strictly confined to a definite ecological situation that is controlled by the ground water level and water supply. Peat growth and moor structure is determined mainly by the water budget. Botanists speak of minerotrophic and ombrotrophic plant associations and term them "fen" and "moss." Special differentiation was described in 1928 [1]. In the undulating muskegs or aapa-moors the differentiation of xerophytic and hydrophytic plant communities is due to ridges and depressions (Figs. 3 and 4). The question since the end of the last century has been: What causes the configurations of xerophytic and hydrophytic plants in the moors, and what causes these strange patterns in the same peatland? Sjörs [2] emphasized that "the strange patterns formed by these features are more difficult to interpret than

the features themselves are."

Most striking is the rippled surface of these moors. The distance between ridges that separate the shallow ponds and depressions may be only a few feet or many meters. The ridges cross the valley bottom nearly perpendicular to the direction of general drainage. Often they form scallops which connect one ridge with another, thus surrounding small and shallow ponds.

These moors slope so slightly, that ridges and depressions are difficult to recognize at close range. The pattern can best be seen from a plane or high point of a mountain. In former lakes and in small basins, concentric configurations of the ridges and depressions (Fig. 1) are observable.

EVOLUTION OF PROBLEMS

In 1885, Swedish botanists [3] investigated and described these strange patterns of the moors in the arctic and subarctic areas of Europe and recognized their relation to the frost climate. Svenonius [4] also interpreted them as frost phenomena. A decade or so before 1915 classic studies on this

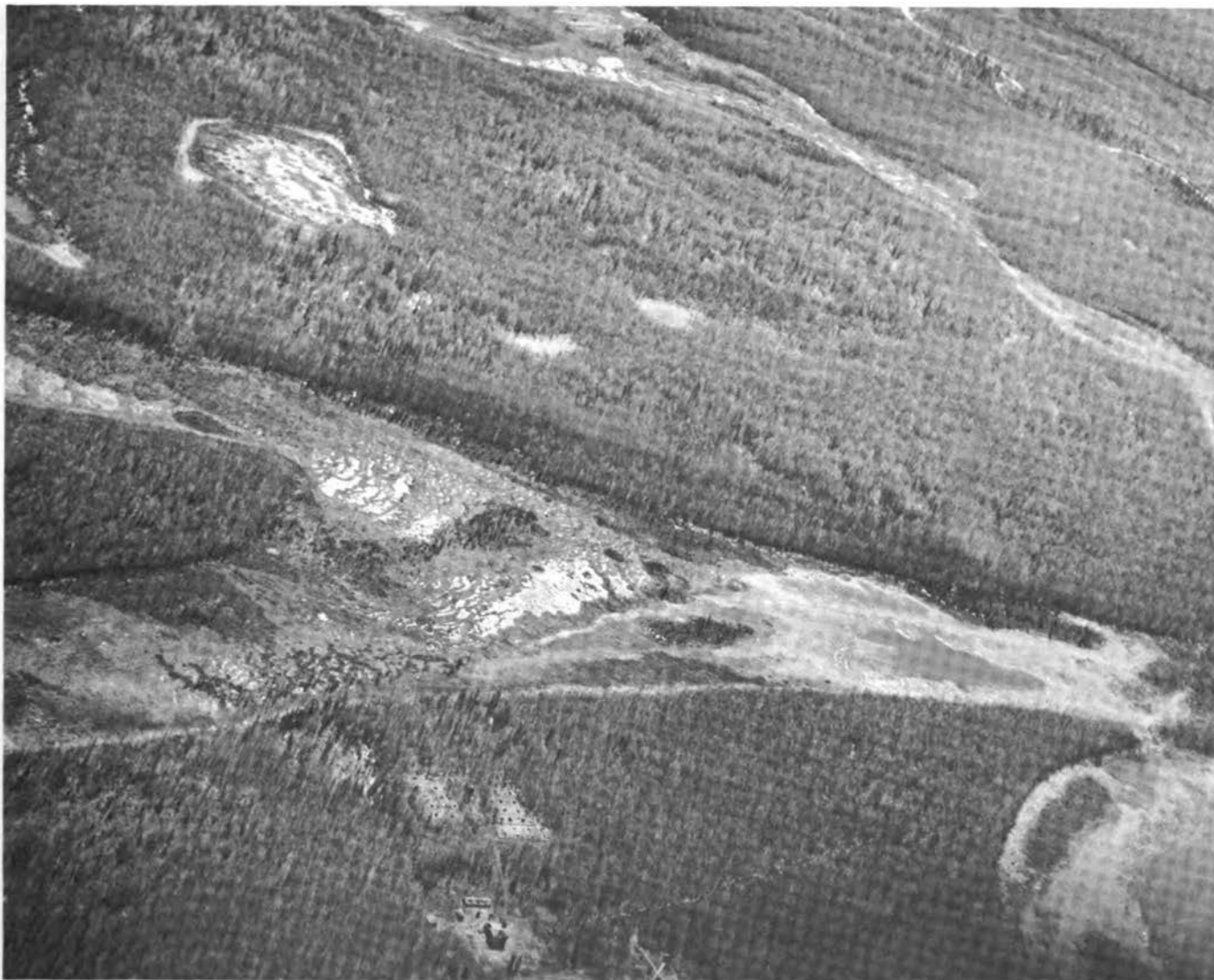

Fig. 1. Ring and string bogs at the west slope of the Talk River, Susitna Valley, about 60 miles north of Anchorage, Alaska. (Mac's Foto Service, Anchorage, Alaska, 1959)



Fig. 2. String bog in the delta area of the Susitna Valley near Anchorage, Alaska



Fig. 5. String bog recently flooded by melt water is near Pelly River, east of Whitehorse, Canada (1959)



Fig. 3. Inclined sections of an aapa-moor near Jokmökk, Lapland, Sweden, forming strings and ditches filled with water (1958)



Fig. 6. Tilted sections of a moor forming strings near Pelly River, Canada. Cracks appear like dark lines in the water; steep left side of the sections and the inclined surfaces at the right of the strings

Fig. 4. Permafrost ice-lenses in the interior of a string within an aapa-moor near Jokmökk, Lapland (1958)



Fig. 7. Border zone of a string bog near Pelly River, Canada, shows the white volcanic ash layer which is also found in the interior of the strings, thus giving a measure of the settling and tilting of the former moor surface



matter [5, 6, 7] were published. Cajander named these strange-patterned moors "aapa-moors."

Since then, we have had both the botanical and geological problems of differentiating between vegetation cover and ridge and depression development. Auer [8], who studied string bogs in Lapland, made a comprehensive explanation still valuable today. He emphasized the effect of ice thrusting; Lundqvist [9] pointed out that this does not explain the origin of strings.

Patterned bogs have a world-wide distribution in high latitudes of the northern hemisphere [10, 11]; they belong to the taiga (boreal conifer) region. A comprehensive study of Russian literature [12] provided an excellent interpretation and map of the distribution of string bogs in northern Eurasia. Other papers and maps [13, 14] show the regional distribution and relation to the area of sporadic permafrost in Scandinavia.

Observations in North America and Sweden [2, 15, 16] expanded the knowledge of string bog occurrence and appearance in the northern hemisphere. Aapa-moors also occur in the conifer forests of middle Europe [17-24]. In a Pleistocene cirque near Kniebis Mountain in the Black Forest (Schwarzwald) in southern Germany, I recognized a typical aapa-moor [25]. The relation of string bogs to the frost climate was recognized early [3, 4], but the exact mechanism of the initial formation of the strings has remained questionable. Some assume that a combination of biological and hydrological factors are mainly responsible for the formation of the strings and hollows [2, 13, 15, 26]. The growing of tussocks in rows that dam up the water [13, 14] initiates the development of strings.

Some [5, 8, 10] believe that string bog development (i.e., the strings, scallops, and depressions) is due to solifluction. Hamelin [11] agrees, although he believes other processes and conditions are also involved in their formation. Drury [15] believes that water running through the vegetation cover on the surface of the frozen moor may be a factor in developing a rib-like pattern.

SOLIFLUCTION IN STRING BOGS

The meaning of solifluction should be restricted to its original sense of the soil movement that is caused by freezing and thawing. Solifluction is that movement of the thawed soil caused by the oversaturation of the soil with water, the amount of which is increased by freezing processes [27]. The end effect is denudation and accumulation, the two basic processes that form the face of our earth.

In the string bogs, however, no flowing, sliding or rolling movement of earth or turf is observable. Neither is denudation nor accumulation observed. Also no form of solifluction-like movement in the freezing and thawing moors in the areas with moderate climate is recorded, even though the slopes here may not be as gentle as in the flat peatlands of the North. Neither in Spitsbergen, Sweden, Lapland, in the Pripjet swamps [28] nor in Iceland, Labrador, northwestern Canada and in Alaska (where I looked for it on a half year's trip in 1959) was anything like denudation or deposition observed within or in the ends of string moors (Figs. 1 to 6). The strings show no evidence of solifluction. The ridges produce no change in the development of the turf layer, but exhibit an uninterrupted growth and development of the vegetation cover from fen to moss. Very old strings are continuing to be built up without interruption [12]. A slow solifluction might have some effect [2], but this cannot explain the initial formation of strings. Slow movement forming slight waves has been observed [15] in the peat, but this is definitely not comparable with solifluction. In Lapland, a dark layer (Fig. 4) is present in the turf mass which enables observation of the deformations. In northwestern Canada and Alaska, the displacement can be recognized by the layer of volcanic ash, formed about 1400 years ago (Fig. 7) [29, 30]. Both layers indicate no solifluction. Moreover, the lack of string bogs in permafrost areas remains a question because in such areas solifluction is one of the main processes forming the landscape. Strings and scallops are very well developed on slopes by solifluction, but no string bogs are present in swampy areas (Fig. 7).

RELATION TO PERMAFROST

Boring and digging in the Lapland aapa-moors first showed that ice-lenses are present in the ridges (Fig. 4), even far south of the area of discontinuous and sporadic permafrost that Black [30] indicates in his map of permafrost distribution.

Lundqvist's map [13] also states that sporadic permafrost occurs only in the mountainous region of northern Sweden, although he found more in the south. The ice within the strings begins 20 to 30 cm beneath the surface of the sphagnum cover and zierophytic plant pattern; in places the ice ends at a depth of 60 to 100 cm at the ground water level, but does not melt in the summer. There can be no doubt that this ice is a relic of permafrost of former times and now belongs to the zone with sporadic permafrost. Such ice is described [9, 13] in Dalarna and Värmland, middle Sweden, and in string bogs that occur southward.

Others [2, 15, 31] describe permafrost features in the string bogs of North America. Near mile 120, Richardson Highway, Alaska, in the border zone of permafrost, the scallops of string bogs occur in an area with a deep active layer. Going from Anchorage north along the Susitna River, or flying along the Kuskokwim River, Yukon and Pelley Rivers, or across Labrador-Quebec, the string bogs disappear as soon as the continuous permafrost zone is reached. Frenzel's [12] map shows that the border of permafrost regions, including sporadic permafrost, coincides with or crosses the broad zone of string bogs in northern Eurasia. String bogs are also lacking in Europe and Siberia wherever continuous permafrost occurs [2, 15]. These observations suggest that the development of string bogs may be related to the melting of permafrost.

Ice-lenses in the interior of the strings (Fig. 4) have nearly flat bases but the sides and tops are vaulted. Their surfaces have the same contour as the vegetation cover. In many places their bases lie deep below the ground water level. The water level on both sides of the ridges is rarely equal. This proves the impermeability of the ridges because of their often high mud content. The ridges are asymmetric with a steep side facing downslope in the direction of general drainage, and a gentle side facing upslope (Figs. 3, 5, and 6). Sometimes fresh cracks develop parallel to the axes of the ridges. They are correlated with the developing and thawing of ice-lenses during the winter and summer, respectively. Parts of the ridge break down and form small steps. Thus, they increase the asymmetric form of the ridges by increasing their steep upslope scarp. Frequently, ridges are observed to be parts of large or small sections, the surfaces of which are turned against the general direction of drainage and ground water movement (Figs. 3 and 5). Also, it is easy to discern the dip of these sections by the depth of black layer or of volcanic ash (Fig. 7). A repetition of their layers is found by boring, showing that in places one section has moved over another. Occasionally, borders of the section are apparent in the clear water (Fig. 3). Mud beneath the turf layer, which originally had an over-all equal thickness, is generally thinned at the upslope end of the section. This thinning of the mud layers could only be caused by water movement. Thus, we can reconstruct the former profile of the section (Fig. 7). All this indicates that no solifluction occurred, but that the original turf layer was broken into sections which collapsed differently and tilted upslope against the ground water movement.

ORIGIN

Considering these facts makes it seem possible to explain the origin and further development of the string bogs. First, the processes which occurred when the moor and permafrost were developed have to be considered.

Sedimentation of mineral material in a basin was probably followed by deposition of organic mud, muck, peat, and turf as the lake or pond or valley bottom was filled. Also above the permafrost layer, the moor was continuing to develop. The vegetation cover spread over permafrost just as we see it

doing today. Thick peat and turf layers were built up over permafrost. Existing moors froze slowly and entirely to their bases on the bedrock.

The water content of the mud and peat layers is extremely high because the organic material absorbs considerable water [33]. During freezing, this (osmotic and adsorptive) water was moved to the freezing front and developed ice layers and thick ice-lenses. The underlying soil became dehydrated; when the permafrost thawed, the soil particles were so dry that beneath the neighboring soil layer, they could scarcely, and only slowly, absorb the water of the melting ice-lenses. Therefore, when the permafrost melted, these were thick layers of dry soil and pure water; and the contact zones between the water and soil were very slippery because of full hydration of the soil particles.

Permafrost thawing from below began when frost ceased to penetrate as deeply as before. Then the geothermal heat retrograded the permafrost base. The zero-degree level moved upward to the surface and reached the thick ice-lenses and layers which then melted. This water was under a high pressure because of the frozen overburden. Wherever possible it broke through and was drained off. By the sudden changes of the volume of the moors, the frozen turf layers were broken into disconnected sections, if this condition had not already been developed by (frost) action in the active layer. After runoff of the water, the frozen turf layers settled, not vertically, but tilting backward slightly because of the undercurrent of the moving ground water (Figs. 2 and 3). Turf layers moved in the direction of the general drainage, sometimes one over the other like tiles of a roof or pushing and cramping one another (Fig. 8). Their contact zones formed ridges and scallops, and the pond developed between them. These structures formed the basic pattern for all further development and differentiation of the vegetation cover of the muskegs, string bogs, or "tourbières réticulées."

SIGNIFICANCE OF AAPA-MOORS AND STRING BOGS

Not only development but also disappearance of permafrost occurs; the collapse of permafrost, which originated the string bogs, is a phenomenon of world-wide morphological importance for the face of our earth. The resulting aapa-moors are well-defined features in the Pleistocene periglacial area, which surrounds the northern hemisphere as the taiga and boreal needle-tree forest zone. Moreover, they are a time mark for a physical and biological event in Pleistocene history. They are evidence of ancient permafrost. Therefore, they open new possibilities for research.

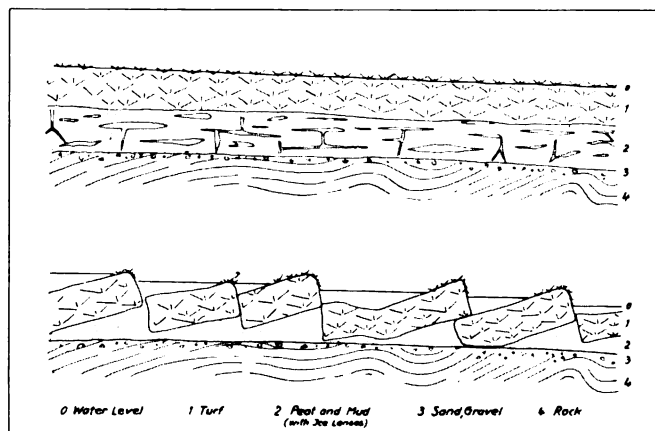

Fig. 8. Sketch of the development of string bogs; permafrost stage of an aapa-moor (muskeg) above, thawed aapa-moor (beneath) forming ribs and ditches by settling and tilting of the sections through the drainage of the melt water of the ice layers and lenses

REFERENCES

- [1] K. Rudolf, F. Firbas, H. Sigmond. "Das Koppenplanmoor im Riesengebirge (ein Beispiel für den subalpinen Moortypus in Böhmen)," Lotos, Vol. 76, 1928.
- [2] H. Sjörö. "Bogs and Fens in the Hudson Bay Lowlands," Arctic, Vol. 12, No. 1, Montreal, 1959.
- [3] Hjelt und Hult. see [10], p. 640, f.
- [4] F. B. Svenonius. "Yttrande med anledning av R. Semanders föredrag: Nagra bidrag till de central skandinaviska fjälltrakternas postglaciala geologi," Geol. Fören. i Stockholm Förhände, Vol. 26, 1904.
- [5] A. K. Cajander. "Studien über die Moore Finlands," Acta Forest Fenn., Vol. 2, Helsinki, 1913.
- [6] A. Tanttu. "Über die Entstehung der Bülden und Stränge der Moore," ibid., Vol. 4, Helsinki, 1915.
- [7] R. Semander. "Die schwedischen Torfmoore als Zuegen postglazialer Klimaschwankungen," Postglaz., Klimaänderun, Stockholm, 1910.
- [8] V. Auer. "Über die Entstehung der Stränge auf Torfmooren," Acta Forest Fenn., Vol. 12, Helsinki, 1920.
- [9] G. Lundqvist. "Beskrivning till jordartskarta över Kopparbergs län," Sveriges Geol. Unders., Ca 21, Stockholm, 1951.
- [10] C. Troll. "Strukturböden, Solifluktion und Frostklimate der Erde," Geol. Resch., Vol. 34, H. 7/8 (lit. list) Stuttgart, 1944.
- [11] L. E. Hamelin. "Les tourbières réticulées du Québec-Labrador subarctique: interprétation morphoclimatique," Cahiers Geog. Quebec, 2nd Ann., No. 3, Okt., 1957.
- [12] B. Frenzel. Die Vegetations- und Landschaftszonen Nord-Eurasiens während der letzten Eiszeit und während der postglazialen Warmezeit; I. Teil Allgemeine Grundlagen Akad. Wiss. u. Lit.; Abhdl. Mathem.-Naturwiss. Kl. Jahrg. 1959, No. 13, (Russian Lit.) Wiesbaden, 1960.
- [13] J. Lundqvist. "Patterned Ground and Related Frost Phenomena in Sweden," Sveriges Geol. Undersök., Ser. C, Avhdl., No. 583, Stockholm, 1962.
- [14] G. Lundqvist. "Beskrivning till jordartskarta över Värmlands län," ibid., Ser. Ca., No. 38, Stockholm, 1958.
- [15] W. H. Drury. Bogs, Flats and Physiographic Processes in the Upper Kuskokwim River Region, Alaska, Harv. Univ. Contrib. Gray Harb 178, New York, 1956.
- [16] E. Schenk. Vortrag im Bot. Inst. Univ. Giessen 1958, "Development and Collapse of the Structures of Perennial-frozen Ground," 6th Intern. Congr. of INQA, Warsaw, 1961.
- [17] H. Gams. "Die Geschichte der Lunzer Seen, More und Wälder," Intl. Rev. Hydrobiol. u. Hydrogr., Vol. 18.
- [18] H. Gams. Torfhugelmoore in den Zentralalpen Naturwiss. Mtsschr, "Aus der Heimat" 54, Jahrg. 1941.
- [19] Ruott. See [10].
- [20] R. Pohle. Frostboden in Asien u. Europa Peterm. Mitt. 1924 u. 1925.
- [21] E. M. Hardy. Studies of the Postglacial History of British Vegetation V., "The Shropshire and Flint Maclor Mosses," New Phytol., Vol. 38, 1939.
- [22] K. Hueck. "Zur Kenntnis der Hochmoore des Thüringer Waldes Beiträge z.," Naturdenkmalpfl., Vol. 12, 1928.
- [23] K. Hueck. "Botanische Wanderungen im Riesengebirge," Pflanzensoziol., Vol. 3, Jena, 1939.
- [24] K. Rudolf, F. Firbas. "Die Hochmoore des Erzgebirges," Beitr. Bot. Centralbl., Vol. II, 1924, pp. 41-43.
- [25] E. Schenk. "Ein Aapa-Moor im Schwarzwald," Natur und Museum, Ber. der Senckenbergischen Naturforsch. Gessellsch Frankfurt a. m.
- [26] R. Runhjarvi. "Über die regionale Einteilung der nordfinnischen Moore," Ann. Botan. Soc. "Vanamo," 31; 1960.
- [27] E. Schenk. "Solifluktion," z. Deutsch. Geol. Ges., Jahrg. 1953, Vol. 105, Hannover, 1954.
- [28] E. Schenk. Die Mechanik der periglazialen Strukturböden Abb. Hess. Landesamt Bodenforsch. 13, Wiesbaden, 1955.
- [29] S. R. Capps. "Glaciation in Alaska," U. S. Geol. Survey, No. 170 A, 1931.

[30] H. S. Bostock. "Geology of Northwest Shakwak Valley, Yukon Territory," Geol. Survey of Canada, Mem. 267. Ottawa, 1952.

[31] R. F. Black. "Permafrost, - A Review," Trans. N. Y. Acad. Sci., Ser. II, Vol. 15, New York, 1953, pp. 126-131.

[32] M. B. Porsild. "Bidrag til en skildring of Vegetation en paa Øen Disko.," Medd. Grønland, Vol. 25, 1902.

[33] E. Schenk. "Die periglazialen Strukturbödenbildungen als Folgen der Hydratationsvorgänge im Boden," Eiszeitalter und Gegenwart, Vol. 6, Ohringen Württ, 1955, pp. 170-184.

GROUND WATER OCCURRENCE IN PERMAFROST REGIONS OF ALASKA

JOHN R. WILLIAMS and ROGER M. WALLER, U. S. Geological Survey, Anchorage, Alaska

The occurrence and availability of ground water are affected by permafrost in the northern 85% of Alaska. General principles controlling its occurrence are similar to those of temperate regions, but are modified by the effect of permafrost on circulation of water, on recharge of aquifers, and on temperature and quality of water. The presence of permafrost in unconsolidated deposits or in the upper fractured zone of bedrock eliminates these zones as aquifers in many areas. The terms suprapermafrost, intrapermafrost, and subpermafrost water have been applied, respectively, to water that occurs in unfrozen permeable materials above, within, and beneath the permafrost [1 to 4].

This report is based on an extensive review of the literature [5] and on earlier studies made by the U. S. Geological Survey beginning in 1947 [1, 2, 6, 7]. Ground water conditions in the permafrost region have been investigated at Bethel [8], Kotzebue [9], Fairbanks [2, 10], at several villages in western Alaska [11 to 15], and at numerous military installations. Well data and chemical analyses of ground water have been tabulated for Fort Wainwright (formerly Ladd Air Force Base) at Fairbanks [16], for Nome [17], and for settlements along the Alaska [18], Glenn [19], and Richardson Highways [20] in eastern and south-central Alaska.

Current investigations in Alaska by the U. S. Geological Survey include measurement of discharge and sediment load of selected rivers, determination of quality of surface and ground waters, areal ground-water investigations, cooperative water-supply investigations for other government agencies, and the present study of the relation of permafrost to the occurrence of ground water. Most available subsurface data under study in connection with the permafrost project are from wells, borings, and prospect and mine shafts in the Tanana Valley. Limited additional information is available from settlements along the highways, along rivers, on the coasts, and at villages, airfields, and mining camps that are accessible only by air. Most of the permafrost region is still so sparsely populated that the initial cost of developing any but shallow ground water supplies has not usually been economically justified.

DISTRIBUTION AND ZONATION OF PERMAFROST

The southern limit of permafrost occurs along the mountains bordering the Pacific Ocean (Fig. 1). Permafrost may also be present south of this limit at higher elevations in some sections of south-coastal and southeastern Alaska.

Permafrost may be regionally zoned into the continuous permafrost zone, occupying the area draining to the Arctic Ocean, and the discontinuous permafrost zone occupying the area to the south. The continuous zone is characterized by temperatures below -5°C at a depth of 30 to 50 ft and by ground that is continuously frozen nearly everywhere to depths of as much as about 1330 ft [2, 21, 22, 27]. The discontinuous zone, including the sporadic zone of other reports [2, 21], ranges in temperature from a minimum of -5°C in the north to 0°C at the southern limit, and in thickness from about 600 ft at Bethel and in mines near McCarthy to thin, deeply-buried relict frozen layers along the southern limit. Large areas of unfrozen ground occur in the southern part of the discontinuous zone.

Local variations in the areal extent and thickness of permafrost mask regional zonation. These variations may be related to a number of factors such as type of soil or rock, vegetation, altitude, exposure, proximity to bodies of water, local differences in climate, and local history of late Quaternary erosion and deposition. Location and development of ground water supplies at least cost require detailed knowledge of local geologic conditions and of distribution of permafrost.

OCCURRENCE OF GROUND WATER

Ground water occurs in unfrozen, permeable materials above, within, and beneath permafrost. The presence of potable water in these aquifers indicates that they receive recharge from surface sources, directly or indirectly, as in temperate regions.

Suprapermafrost water is recharged directly from the surface. It is wholly or in part subject to freezing in winter where permafrost is near the surface. Beneath lakes and rivers and beneath some parts of flood plains, terraces, sunny slopes, and hilltops, unfrozen ground may be very deep, and suprapermafrost water available throughout the year. Locally, suprapermafrost water may become confined and subjected to pressure by the downward extension of seasonal frost toward the permafrost table. Increase in hydrostatic pressure is responsible for arching the ground to form certain types of frost mounds.

Suprapermafrost water supplies shallow wells in the alluvial deposits at Fairbanks [2, 10] and those drilled in coastal beaches and bars. In regions of thick, continuous permafrost, the suprapermafrost zone beneath rivers and lakes is the only supply of ground water available at reasonable cost.

Intrapermafrost water is uncommon and, if potable, is generally connected to an aquifer above or below the permafrost. In addition, lenses and layers of concentrated brine having a temperature below 0°C occur within the permafrost.

Subpermafrost water occurs in permeable, unconsolidated deposits and in fractured zones in the upper part of the bedrock. Recharge of aquifers is either from distant sources or from downward percolation of water through unfrozen zones that perforate the permafrost, principally those beneath large lakes and rivers. Widespread occurrences of brackish or saline water in bedrock beneath permafrost of the continuous zone indicates that little or no recharge is received either from the surface or from distant sources. Southward, in the discontinuous zone, circulation of water laterally and vertically is progressively less restricted, until, at the southern limit, conditions are like those of temperate regions.

Artesian conditions are created where water is confined beneath permafrost or beneath material that is less permeable than the aquifer. Subpermafrost water is commonly artesian. The water rising in the casing to within the zone of permafrost is subject to freezing if the wells are not pumped at intervals or if they are not artificially heated. Freezing of small-diameter wells is more common than freezing of large-diameter wells. Flowing artesian wells [10, 23, 24] are common on slopes in the uplands where water in alluvium or bedrock is confined beneath silt or permafrost.

Springs, surrounded by unfrozen ground, occur throughout

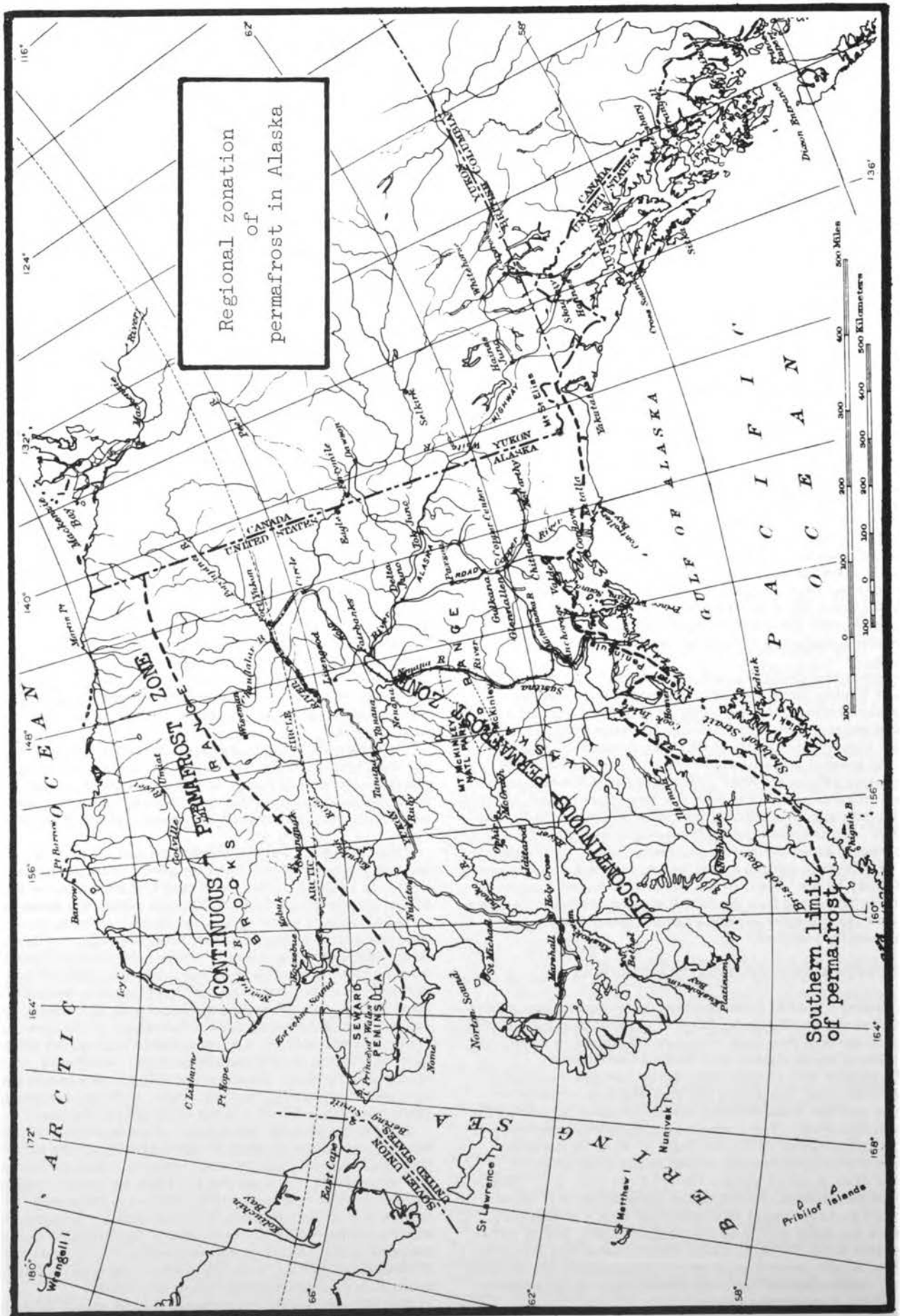

the permafrost region [25]. Many springs are fed by cold suprapermafrost water and commonly cease flowing in winter. Others fed by hot or cold subpermafrost water flow perennially.

A summary of the occurrence of ground water and its relation to permafrost in coastal-plain, alluvial, eolian, glacial and glaciolacustrine deposits and bedrock is given below.

Coastal-Plain Deposits

Unconsolidated marine and nonmarine gravel, sand, silt, clay, and peat of Quaternary age, locally associated with ground ice, compose the deposits of the coastal plains along the Arctic Ocean and Bering Sea. Within limits of Pleistocene glaciation these deposits include till, outwash, and glacio-marine deposits. In addition, offshore bars, spits, and beaches, composed of sand and gravel, border much of the coastal plain.

Within the Arctic coastal plain permafrost extends from near the surface through coastal-plain deposits, that are as much as 150 ft thick [26], and into bedrock. The base of permafrost has been measured or calculated from geothermal data to range from 600 to more than 1300 ft below the land surface. Unfrozen zones, extending in depth to as much as 400 ft, occur above permafrost beneath large rivers and lakes that are more than 7 ft deep and one-half mile in diameter [22, 27, 28, 29]. Elsewhere, the suprapermafrost zone is frozen each winter. Lakes within five miles of the coast near Barrow are brackish or have a layer of fresh water resting on salt water or on saline bottom deposits.

At Nome, which is underlain by a complex section of coastal-plain deposits consisting of frozen glacial, marine, and alluvial deposits [30], fresh water is obtained from unfrozen sediments; however, saline or brackish water is obtained from deposits bordering the coastline.

In the Yukon-Kuskokwim delta, at Bethel and to the west, unconsolidated silt, sand, gravel, and organic material of Pleistocene age extend to depths of almost 1000 ft [31] and are frozen to depths of about 350 to 600 ft. The delta deposits are entrenched by the Kuskokwim River. In a well on an island in the flood plain the ground is unfrozen, except for a thin near-surface frozen layer, to a depth of at least 197 ft [8]. A correlation between fluctuations of static level of wells drilled through permafrost of delta deposits with fluctuations in river stage suggests that permafrost may be absent in places beneath the river and that the subpermafrost aquifer is connected to, and is recharged by, the river.

Coastal-plain deposits bordering Bristol Bay are locally perennially frozen to a depth that in some places exceeds 150 ft. In other places permafrost consists of deeply-buried beds or lenses of relict permafrost [2]. Little difficulty has been experienced in obtaining potable water at depths of less than 250 ft, but salt water was encountered in the 600-ft deep flowing artesian well at Koggiung on the east shore of the bay.

In general, permafrost occurs in most of the sand and gravel deposits of offshore bars, spits, and beaches, except in areas immediately adjacent to the sea. Fresh suprapermafrost aquifers of limited extent occur in depressions in the permafrost table within or below the zone of seasonal freezing. The higher permafrost table beneath beach ridges forms a barrier that keeps salt water from advancing into these aquifers. The aquifers are normally recharged by snow melt, ponds, and by lateral infiltration from adjacent streams, but during periods of high tides that occur during severe storms they may be recharged to some extent by salt water. In many instances they are reduced in volume during winter by the downward formation of seasonal frost. These shallow aquifers are also subject to pollution.

Fresh water lakes on the spit and in the coastal plain back of the beach between Barrow and Point Barrow are underlain by saline or brackish water or by bottom sediments containing brackish or salt water. Unfrozen lenses and layers of brine are encountered locally within the permafrost [22, 27, 28, 32]. Shallow wells on the spit at Point Lay [33] to the southwest of Barrow and at Teller [6], 70 miles northwest of Nome, have become saline. Permafrost in spit gravel at Point Spencer,

near Teller, is 12.5 and 17 ft thick in two deep wells. It separates fresh suprapermafrost water from the underlying salt water [34]. Potable water at Point Hope, in northwestern Alaska, is obtained in a 4-ft well from a depression in the permafrost table [6, 11]. Kotzebue, on an offshore bar in a brackish arm (Kotzebue Sound) of the sea, is supplied, in part, from shallow wells that take water from depressions in the permafrost table [6]. Also at Kotzebue, salt water occurs below permafrost, which is 238 ft thick, and brine occurs within permafrost in an unfrozen layer at a depth of 79 to 86 ft [9]. The gravel of Gambell spit, northwestern St. Lawrence Island, yields fresh water that is apparently perched on frozen gravel [14]. The aquifer is believed recharged by the seaward flow of ground water derived by percolation from a nearby lake.

Alluvial Deposits

Alluvial deposits occupy large areas of the Yukon and Kuskokwim drainage basins and valleys of lesser streams in the discontinuous zone. They include gravel, sand, and silt that form the flood plains and terraces of valleys and outwash plains and piedmont alluvial fans fronting the mountains. The areas shown as flood-plain alluvium on geologic maps generally included low-lying, annually-flooded areas bordering the streams and numerous low terraces that are only rarely, if ever flooded. Near the uplands bordering the major valleys and in valleys within the uplands the alluvial deposits of trunk streams are overlapped and interbedded with silt of coalescent alluvial fans of tributaries. Within the continuous zone the streams are bordered by flood-plain and terrace alluvium.

Distribution of permafrost in flood-plain alluvium is variable and depends on the history of river migration across its valley and on the proximity of existing bodies of water. Permafrost in these deposits is generally absent near the southern limit of permafrost, but increases in areal extent and thickness to the north. In the discontinuous zone, permafrost is absent beneath river channels and bars, and is thin beneath low-lying willow- and poplar-covered islands, bars, and slip-off slopes along the river. Slightly higher alluvial surfaces, covered with spruce forest, are underlain by permafrost except beneath former stream channels, creeks, and oxbow lakes. Low terraces that form the oldest and highest part of the flood plain are generally covered with forest, brush, or muskeg, and are underlain by permafrost that is thicker and areally more extensive than that beneath the younger and lower parts of the flood plain. Terraces that border the flood plain are commonly underlain by frozen alluvium, but unfrozen zones are erratically distributed throughout these deposits. Within the continuous zone, most of the alluvium is frozen, even that beneath the channels and bars of present streams. However, unfrozen ground may occur to a depth of as much as 400 ft beneath beds of larger streams, such as the Colville River.

Abundant supplies of ground water are found in the discontinuous zone in flood plains and terraces of major valleys, in unfrozen, permeable alluvium below, within, and above permafrost. Within a specific area, ground water confined below permafrost rises to a static level that is approximately that of water-table wells in the suprapermafrost zone and nonpermafrost zone. The water level generally fluctuates with river stage. Recharge of ground water below permafrost is accomplished directly from the river, from lakes, and from precipitation, through unfrozen zones that perforate the permafrost. Beneath relatively thick, continuous permafrost under the older part of the flood plain, water moves freely through the permeable alluvium from the areas of recharge.

Ground water occurrence and permafrost conditions in valleys of smaller streams flowing through uplands are comparable to those of larger valleys. Water is generally available from unfrozen alluvium near or under the stream bed. In many valleys the flood plain of the major stream is bordered by coalescent fans of tributaries in which permafrost commonly occurs as a wedge-shaped mass that is thick near the flood plain but which thins toward the hills. Artesian ground water is common in permeable alluvium or bedrock beneath silt or permafrost in these fan deposits, and flowing wells occur locally [2, 10, 23].

In the discontinuous zone, the most detailed records of the occurrence of ground water in alluvial deposits is in the Fairbanks-Fort Wainwright area [2, 10, 16, 20, 23]. Here, hundreds of wells and borings penetrate permafrost in flood-plain alluvium of the Chena and Tanana Rivers that is as much as 820 ft thick [35]. Even these records, however, cannot outline in detail the complex variations that occur in the alluvium. The records show that the alluvium is unfrozen beneath the bed and unvegetated bars of the Chena River; however, beneath low-lying bars and islands covered with willows, frozen ground is present to a depth of about 20 ft. Permafrost beneath slightly higher ground, formerly covered with spruce, seldom exceeds 80 ft in thickness and is perforated by unfrozen zones beneath oxbow lakes and some former stream channels. To the south, beneath an even higher part of the flood plain extending from the southern part of the city into Fort Wainwright, permafrost is consistently thick, ranging from 140 to 265 ft. Similar conditions, but different thicknesses, occur in the flood plains and low terraces of the Kuskokwim River at Bethel [8] and McGrath [36], of the Yukon River at Galena below Ruby [37], and of the Nabesna River, tributary to the Tanana River, at Northway near the Alaska-Yukon border [18, 38].

In alluvium of the continuous zone, subsurface records are few. At Umiat on the Colville River flood plain, potable ground water was encountered in unfrozen alluvium in a seismic shot hole [39] and in at least one of six exploratory oil wells drilled near the river [40]. A shallow aquifer occurs in the bed of Ogotoruk Creek [15, 41] southeast of Point Hope in an area in which permafrost extends into bedrock to a depth of as much as 1200 ft [42]. The gravel beneath Selin Creek, an even smaller stream near Cape Lisburne, was apparently frozen beneath the stream bed, but a year-round supply was produced in an infiltration gallery in these deposits as a result of stripping away the insulating turf. This, together with circulation through the alluvium of water warmed in a reservoir, allowed the frozen ground to thaw to a depth beneath that reached by winter freezing.

Alluvium of piedmont alluvial fans and outwash plains fronting the Alaska Range in the Tanana and Kuskokwim valleys is locally perennially frozen. Disappearance of streams into alluvium and the reported absence of permafrost in many wells indicate that extensive areas of unfrozen ground occur in the coarse alluvium. In general, permafrost is relatively thin and occurs above the water table.

The presence of permafrost in alluvial fans and outwash plains in the few areas in the discontinuous zone, in which records are available, seems to have little effect on the occurrence and hydrology of ground water. At Fort Greely [2, 43], near Delta Junction in east-central Alaska, for example, in only one well does the permafrost extend below the water table which lies at a depth of 160 to 201 ft [20]. At Tok Junction, also in east-central Alaska [18], scattered bodies of permafrost are generally less than 35 ft thick, and its base lies 15 to 25 ft above the water table. At Farewell, southeast of McGrath, the water table is well below permafrost [6, 36]. At Clear, on the fan of the Nenana River, no permafrost was recorded in existing water wells. Generally, as in other climates the fans and outwash plains have a deep water table near their outer perimeter. Along the Tanana River near Delta Junction, springs flow from the terrace escarpment that marks the truncated edge of alluvial fans [2]. No records are available from similar deposits in the northern part of the discontinuous zone along the Yukon River, nor in the continuous zone.

EOLIAN DEPOSITS

Eolian silt or sand forms a mantle that is generally less than 60 ft thick on bedrock of uplands or on alluvial deposits of the major valleys. These deposits are perennially frozen at most places in the valleys, but are unfrozen in some upland areas. In valleys the alluvium beneath dune sand is generally frozen to a greater depth than that beneath adjacent younger alluvial

deposits. At Northway in eastern Alaska, permafrost is 140 ft thick beneath the dunes near the airstrip, but less than 70 ft thick [20] in nearby sections of the flood plain. At Fort Yukon in northeastern Alaska the ground is frozen to a depth of more than 320 ft beneath dunes [44], but permafrost is relatively thin or absent beneath flood-plain deposits along the Yukon River. Ground water in wells located on eolian deposits is nearly always obtained from alluvium beneath permafrost in the valleys and from bedrock in the uplands.

Glacial and Glaciolacustrine Deposits

Well data in most areas of the permafrost region that are underlain by glacial deposits are so scattered that little can be said of the distribution of permafrost and of the occurrence of ground water. However, near Glennallen, in the central Copper River Basin, a thick section of glaciolacustrine and glacial deposits underlies the former bed of a Pleistocene glacial lake. The deposits are exposed in bluffs bordering the deep valleys cut by major streams. The thickness of permafrost recorded in wells is generally between 100 and 200 ft [19, 20, 45]. Hard and saline ground water occurs at a depth of 300 to 400 ft under the former floor of the lake. The ground water supplies shallow artesian wells and springs, in local areas of entrenched river valleys, and springs and bud volcanos elsewhere on the former floor of the lake [45]. The dissolved solids content of ground water ranges from 1055 to more than 25,000 ppm (parts per million) and chlorides range from 230 to 15,400 ppm. The high salinity of this water is attributed to evaporation in the series of lakes that occupied the basin during Pleistocene time and subsequent concentration during formation of permafrost [46]. According to an alternate hypothesis [47], mineralized water originated in Upper Cretaceous and older marine sediments that are believed to underlie this part of the basin. An upper aquifer, 70 to 200 ft deep, contains potable water and lies below permafrost adjacent to and beneath Moose Creek at Glennallen and Dry Creek near Gulkana airport. This aquifer is believed to be recharged from the creeks.

Bedrock

Ground water is obtained from deep wells in metamorphic and igneous rocks either below permafrost or in sites where permafrost is locally absent. The largest concentration of these wells is on hilltops and slopes of upland north of Fairbanks, where water is obtained from schist [2, 10, 23]. On hilltops permafrost is generally absent and the water table is deep. Permafrost increases in thickness downslope, and wells on middle and lower slopes have encountered artesian water in the schist beneath the confining overburden of silt or beneath permafrost.

In the continuous zone exploratory oil wells drilled in shale, siltstone, and sandstone below permafrost have obtained yields of 15 gpm (gallons per minute) or less of water that ranges from only slightly brackish to saline. One well, Umiat No. 2 [40], drilled in these rocks beneath the Colville flood plain, obtained water during a formation test, having only 1031 ppm dissolved solids from sandstone at the depth interval of 103-345 ft, and water having 3188 ppm from the interval 1005 to 6212 ft with a static level of 730 ft. In this locality fresh water probably has recharged bedrock in an unfrozen zone beneath the river bed. Similar rocks in the Copper River Basin have failed to yield water to wells [19], but are believed by some [47] to be the source of saline springs.

Large potable springs occur in limestone in the Alaska Range and at the contact between sandstone and limestone in the Brooks Range [2, 15], but these areas have not been explored for water. The presence of fresh water springs in the Brooks Range indicates that bedrock aquifers are recharged despite the presence of continuous permafrost. Fractures and solution cavities in limestone marble and large openings in volcanic rocks on Seward Peninsula are commonly water bearing.

QUALITY OF WATER

Ground water at many localities in interior valleys has a high concentration of bicarbonate, iron, and manganese, and is below the accepted quality standards for domestic and industrial use. It has a high content of carbon dioxide and dissolved oxygen which causes corrosion problems. Salinity of ground water is a major problem in the coastal plains and in the Copper River Basin.

The temperature of ground water in permafrost regions ranges from 0°C to about 4.5°C for potable water but less than 0°C for brine that occurs within permafrost. Records taken at different times of the year from wells of differing depths and for differing permafrost conditions show that the average temperature of ground water at Anchorage is 2.8°C and at Fairbanks 1.7°C. Temperature observations in alluvial deposits at Fairbanks show that beneath the base of permafrost the increase in ground water temperature with depth is influenced by the prevailing geothermal gradient.

CONCLUSIONS

Although subsurface data are scarce and isolated, except in a few parts of the Tanana Valley, they are sufficient to indicate that ground water occurs in many geologic environments in both the continuous and discontinuous zones, either above or below the permafrost. The influence of permafrost on the occurrence and availability of ground water generally decreases southward from the continuous zone. The great variation in thickness and in areal extent of permafrost in local areas suggests that adequate geologic and hydrologic studies should be made in advance of a contemplated development, particularly at sites where expensive construction is planned. In many areas, a minor shift in location, or consideration of alternate sites, in advance of construction could do much to locate a site where a supply of ground water can be obtained at a reasonable cost. In areas of thick permafrost where yield and quality of subpermafrost water are uncertain and deep wells are costly to construct, consideration should be given to developing wells in shallow aquifers or by the construction of infiltration galleries near or under streams.

Publication of this paper was authorized by the Director, U. S. Geological Survey.

REFERENCES

- [1] D. J. Cederstrom, P. M. Johnston, Seymour Subitzky. "Occurrence and Development of Ground Water in Permafrost Regions," U.S. Geol. Survey Circ. 275, 1953.
- [2] D. M. Hopkins, T.N.V. Karlstrom, et al. "Permafrost and Ground Water in Alaska," U.S. Geol. Survey Prof. Paper 264-F, 1955, pp. 113-146.
- [3] N. I. Tolstikhin. Podzemnye vody merzloi zony litosfery, Gosgeolizdat, Moscow-Leningrad, 1941.
- [4] S. W. Muller. Permafrost or Perennially Frozen Ground and Related Engineering Problems, Ann Arbor, Mich., J. W. Edwards, Inc., 1947.
- [5] J. R. Williams. Ground Water in Permafrost Regions - an Annotated Bibliography of Publications through 1960 (with glossary of terms), U.S. Geol. Survey, open-file rept., 1963.
- [6] D. J. Cederstrom. "Summary of Ground-Water Development in Alaska, 1950," U.S. Geol. Survey Circ. 169, 1952.
- [7] D. J. Cederstrom. "Ground-Water Hydrology in Alaska," in G. O. Raasch (ed.), Geology of the Arctic (Proc. 1st Intl. Symp. on Arctic Geol.), Calgary, Alta., Canada, Jan. 11-13, 1960, Univ. Toronto Press, 1961, Vol. 2, pp. 1015-1019.
- [8] R. M. Waller. "Ground-water and Permafrost at Bethel, Alaska," Alaska Dept. Health, Water-Hydr. Data Rept. 2, 1957.
- [9] D. J. Cederstrom. "Origin of a Salt-Water Lens in Permafrost at Kotzebue, Alaska," Geol. Soc. Am. Bull., Vol. 72, 1961, pp. 1427-1431.
- [10] D. J. Cederstrom. "Ground-Water Resources of the Fairbanks Area, Alaska," U.S. Geol. Survey Water-Supply Paper 1590, 1963.

- [11] R. M. Waller. "Ground-Water Reconnaissance of Six Eskimo Villages in the Kobuk-Noatak Area, Alaska," Alaska Dept. Health, Water-Hydrological Data Rept. 4, 1958.
- [12] R. M. Waller. "Ground-Water Reconnaissance in Five Eskimo Villages in the Lower Kuskokwim-Yukon River Area, Alaska," ibid., Water-Hydr. Data Rept. 5, 1958.
- [13] R. M. Waller. "Ground-Water Reconnaissance of Koyuk and Shaktolik Villages, Alaska," ibid., Water-Hydr. Data Rept. 7, 1959.
- [14] R. M. Waller. "Water-Resources Reconnaissance of Gambell and Savoonga Villages, St. Lawrence Island, Alaska," ibid., Water-Hydr. Data Rept. 6, 1959.
- [15] R. M. Waller. "Ground-Water Conditions in the Vicinity of Project Chariot, Ogotoruk Creek, Northwestern Alaska," in Reuben Kachadoorian et al. Geologic Investigations in Support of Project Chariot in the Vicinity of Cape Thompson, Northwestern Alaska (prelim. rept.), U.S. Geol. Survey, open-file rept. (TE 1-753), 1960, pp. 72-78.
- [16] A. J. Feulner. "Data on Wells at Ladd Air Force Base, Alaska," Alaska Dept. Health, Water-Hydr. Data Rept. 13, 1960.
- [17] R. M. Waller, S. P. Mathur. "Data on Water Supplies at Nome, Alaska," Alaska Dept. Health and Welfare, Hydr. Data Rept. 17, 1962.
- [18] R. M. Waller, D. A. Tolen. "Data on Wells and Springs along the Alaska Highway (State 2), Alaska," ibid., Hydr. Data Rept. 18, 1962.
- [19] R. M. Waller, L. M. Selkregg. "Data on Wells and Springs along the Glenn Highway (State 1), Alaska," ibid., Hydr. Data Rept. 15, 1962.
- [20] R. M. Waller, D. A. Tolen. "Data on Wells and Springs along the Richardson Highway (State 4), Alaska," ibid., Hydr. Data Rept. 16, 1962.
- [21] R. F. Black. "Permafrost - a Review," Geol. Soc. Am. Bull., Vol. 65, 1954, pp. 839-856.
- [22] R. F. Black. "Some Problems in Engineering Geology Caused by Permafrost in the Arctic Coastal Plain, Northern Alaska," Arctic, Vol. 10, 1957, pp. 230-240.
- [23] T. L. Péwé. Permafrost Investigations, Fairbanks Area, Alaska, Permafrost Program Prelim. Rept., U.S. Geol. Survey in cooperation with Engineer Intelligence Div., Office of the Chief of Engineers, U.S. Army, Sept. 1948.
- [24] W. M. Jaillite. "Permafrost Research Area," Mil. Engr., Vol. 39, 1947, pp. 375-379.
- [25] G. A. Waring. Mineral Springs of Alaska (with a chapter on the chemical character of some surface waters of Alaska by R. B. Dole and A. A. Chambers), U.S. Geol. Survey Water-Supply Paper 418, 1917.
- [26] T. G. Payne, et al. Geology of the Arctic Slope of Alaska, U.S. Geol. Survey Oil and Gas Inv., OM-126, 1952.
- [27] M. C. Brewer. "Some Results of Geothermal Investigations of Permafrost in Northern Alaska," Am. Geophys. Union Trans., Vol. 39, 1958, pp. 19-26.
- [28] J. C. Reed. "Exploration of Naval Petroleum Reserve No. 4 and Adjacent Areas, Northern Alaska, 1944-1953," pt. 1, U.S. Geol. Survey Prof. Paper 301, 1958.
- [29] M. C. Brewer. "The Thermal Regime of an Arctic Lake," Am. Geophys. Union Trans., Vol. 39, 1958, pp. 278-284.
- [30] D. M. Hopkins, F. S. MacNeil, E. S. Leopold. "The Coastal Plain at Nome, Alaska: a Late Cenozoic Type Section for the Bering Strait Region," Intl. Geol. Cong., 21st Norden, 1960 Rept., pt. IV, Chronology and Climatology of the Quaternary, pp. 46-57.
- [31] Letter, Pan American Petroleum Corp., Anchorage, Alaska, to T. L. Péwé, College, Alaska, March 14, 1963.
- [32] P. H. Ray. Report of the International Polar Expedition to Point Barrow, U.S. Govt. Printing Office, Washington, D.C., 1885.
- [33] R. M. Chapman, E. G. Sable. "Geology of the Utukok-Corwin Region, Northwestern Alaska," U.S. Geol. Survey Prof. Paper 303-C, 1960, pp. 47-167.
- [34] R. F. Black. "Permafrost, Water-Supply, and Engineering Geology of Point Spencer Spit, Seward Peninsula, Alaska," Arctic, Vol. 11, 1958, pp. 103-116.

- [35] D. F. Barnes. "Gravity Low at Minto Flats, Alaska," U.S. Geol. Survey Prof. Paper 424-D, 1961, pp. D254-D257.
- [36] A. T. Fernald. "Geomorphology of the Upper Kuskokwim Region, Alaska," U.S. Geol. Survey Bull. 1071-G, 1959, pp. 191-279.
- [37] T. L. Péwé. "Terrain and Permafrost, Galena Area, Alaska," Permafrost Program Progr. Rept. 7, U.S. Geol. Survey in cooperation with Engineer Intelligence Div., Office of the Chief of Engineers, U.S. Army, 1948.
- [38] R. E. Wallace. "Terrain Analysis in the Vicinity of Northway, Alaska," Permafrost Program Progr. Rept. 3, U.S. Geol. Survey in cooperation with Engineer Intelligence Div., Office of the Chief of Engineers, U.S. Army, 1946.
- [39] R. F. Black, W. L. Barksdale. "Terrain and Permafrost, Umiat Area, Alaska," Permafrost Program Progr. Rept. 5, U.S. Geol. Survey in cooperation with Engineer Intelligence Div., Office of the Chief of Engineers, U.S. Army, 1948.
- [40] F. R. Collins. "Test Wells, Umiat Area, Alaska," U.S. Geol. Survey Prof. Paper 305-B, 1958.
- [41] R. M. Waller. "Winter Hydrology of a Small Arctic Stream," Geol. Soc. Am. Spec. Paper 68, 1961, pp. 122-123.
- [42] A. H. Lachenbruch, G. W. Greene, B. V. Marshall. "Preliminary Results of Geothermal Studies at Ogotoruk Creek, AEC Project Chariot Test Site, Northwestern Alaska," (abs.) Alaskan Sci. Conf., 11th, Anchorage, Proc., 1960, p. 167.
- [43] R. M. Waller, A. J. Feulner, F. E. Tisdell. "Ground-Water Movement in the Fort Greely Area, Alaska," Geol. Soc. Am. Spec. Paper 68.
- [44] J. R. Williams. "Geologic Reconnaissance of the Yukon Flats District, Alaska," U.S. Geol. Survey Bull. 1111-H, 1962, pp. 289-331.
- [45] D. R. Nichols. "Permafrost and Ground-Water Conditions in the Glennallen Area, Alaska," U.S. Geol. Survey open-file rept., 1956.
- [46] D. R. Nichols, L. A. Yehle. "Mud Volcanoes in the Copper River Basin, Alaska," in G. O. Raasch (ed.), in Geology of the Arctic (Proc. 1st Instl. Symp. on Arctic Geology), Calgary, Alta., Jan 11-13, 1960, Univ. Toronto Press, 1961, pp. 1063-1087.
- [47] Arthur Grantz, D. E. White, H. C. Whitehead, A. R. Tagg. "Saline Springs, Copper River Lowland, Alaska," Am. Assoc. Petrol. Geol. Bull., Vol. 46, 1962, pp. 1990-2002.

PERMAFROST AND ICE-WEDGE EFFECT ON RIVERBANK EROSION

H. J. WALKER, Louisiana State University
L. ARNBORG, University of Uppsala, Sweden

In recent years, several investigators have studied permafrost and ice-wedges as they are related to surface features in the Arctic. Most reports are concerned especially with thermo-karst, oriented lakes, pingos, ice-wedge polygons, and other forms of patterned ground. According to reports examined thus far, virtually all of the analytic work on riverbank erosion in the Arctic, and especially on the importance of permafrost and ice-wedges to such erosion, has been and is being conducted by Russian scientists.

The degree and rate of bank erosion and resultant bank form along any river vary with many factors. These include the river's stage and current velocity; direction, velocity, and persistence of wind; effectiveness of vegetation in binding bank sediments; position of the bank in relation to river flow, and the character of materials that compose the bank. Permafrost and ice-wedges are significant factors for they modify the rate of bank erosion and the form that results. Because of the nature of permafrost and ice-wedges, exposure to the sun is significant; air and water temperatures have a degree of importance they otherwise would not have.

Field work in the Colville River Delta, Alaska, presented the opportunity of observing and measuring riverbank erosion in an arctic setting. This report is a preliminary statement of these observations and measurements, especially as they relate to permafrost and ice-wedges.

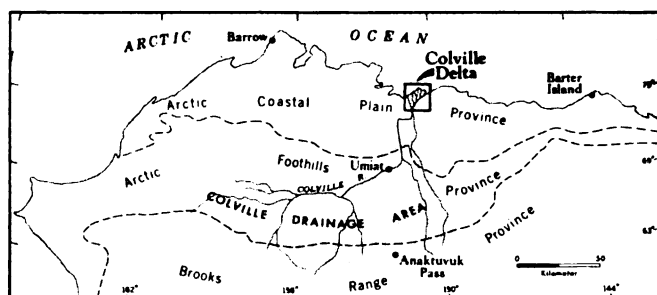

Fig. 1. Arctic Slope

PHYSICAL SETTING

The Colville River is the longest river in Alaska north of the Brooks Range and drains an area of 50,000 sq km (Fig. 1). It enters the Arctic Ocean about 250 km east of Barrow, Alaska, where it forms a roughly triangular delta over 550 sq km in area (Fig. 2). The climate of the delta is similar to that found

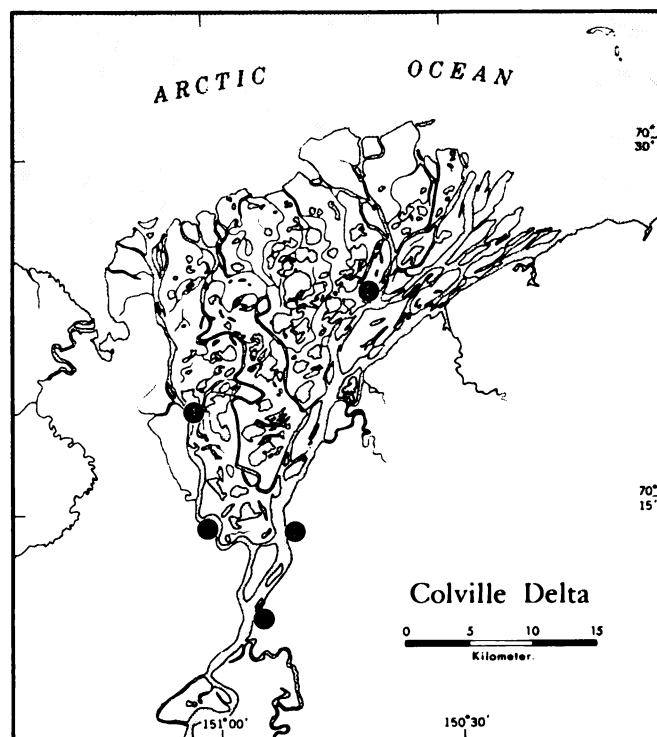

Fig. 2. Colville River Delta

along the other sections of the arctic coast of Alaska. It is characterized by low precipitation (much of which is snow), by moderately high and relatively persistent winds (south-westerly during much of the summer, northeasterly during the rest of the year), and by low temperatures.

In its subaerial portion, the delta is very heterogeneous, despite a low range of relief. Sand dunes, ice-wedge polygons, and the present distributary channels, along with numerous lakes, are the most conspicuous forms. The main channel of the Colville, through which about 80% of the river's water flows, marks the eastern edge of the delta (Fig. 2). From it, the trend of numerous sinuous distributaries is northwest to the ocean. These deltic channels cut through a variety of materials such as dense autochthonous peats; sands of dunes and former river bars; silts or clays of drained-lake bottoms and mudflats which frequently contain streaks of vegetal detritus, and gravelly sands of the Gubik Formation. All banks have ice inclusions that vary in size and quantity.

Riverbanks in the delta vary in height above mean river level from a few centimeters near the delta's front to about 10 m in the Gubik Formation and in the sand dunes near its head. Most banks, however, range in height between 2 and 4 m.

PERMAFROST

The temperature regime and the thin, hard snow cover favor not only a seasonally thick ice cover on lakes, ocean, and river but also thick permafrost and large ice-wedges in the nonaqueous portions of the delta. The upper surface of permafrost is probably more variable in the Colville Delta than in any other area of comparable size on the Coastal Plain of Alaska, because of the depression of the permafrost under the numerous deep lakes and the deep portions of the distributaries. However, these nonfrozen zones are beneath water, and have little effect on the riverbanks composed of permafrost.

The active layer is normally very thin. Measurements range from less than 15 cm in vegetated peats to about 2 m in nonvegetated sand. This latter measurement is more realistic in connection with bank recession in all nonpeat banks, for thawing occurs perpendicular to the bank face which usually has no vegetal protection.

The depth to which permafrost temperature is significantly influenced by changes in air temperature is unknown. However, for parts of the delta, changes probably differ little from those measured in a region of ice-wedge polygons near Barrow. Temperatures at a depth of 3.5 m changed by as much as 10°C (-5° to -15°C), while at 7.5 m the annual variation was about 3°C (-8° to -11°C) [1]. For riverbanks, horizontal as well as vertical change is significant.

ICE-WEDGES

Ice-wedges vary in location and size in the delta. The most extensive development is found in the zones of dense peat, the best examples being in the right bank of the main channel. Some are as wide as 6 m; their depth is not known. Ice-wedges have not been found in the sand dunes of the delta, although thin ice veins do occur (Fig. 12). Between these two extremes, all gradations in ice-wedge size are apparently present. The Gubik Formation, a Quaternary deposit of varied composition and texture, contains ice-wedges despite the fact that it is highly sandy. Although the Gubik wedges are probably older than those formed in the peat deposits, they are not as well developed.

HYDROLOGY

Five distinct periods can be recognized in the river's annual cycle. These five periods are extremely variable in duration and in importance to bank erosion. Although records for only a part of one year (May through Sept., 1962) are available, they are sufficient to point up the general nature of the river's

regime. Table I presents a summary of this annual cycle.

Table I. Annual Cycle of the Colville River

Period	Condition	Dates	Duration
1	Frozen	Oct. to May	8 months
2	Prebreakup floods	Late May to early June	2 weeks
3	Breakup	Early June	2 days
4	Postbreakup floods	Early June to mid-June	1.5 weeks
5	Summer regime	Mid-June to Oct.	3 months

The first, longest, and least significant period begins in the fall with the freezing of the river, and lasts until the melt season. For about eight months, no water is present in the liquid state at the surface. Even after ice forms on the river, water continues to flow for a few months; however, this flow is not effective in bank erosion, partly because the river is at an extremely low stage at the time the ice forms, and the flow itself is very sluggish. During all this period, except toward its very end, the banks are frozen, and, in addition, covered with snow, which protects them from wind blast.

In late spring, melt water accumulates on top of the river ice and soon begins to flow (period 2). In 1962, flow volume increased rapidly until a stage 2 m above the ice surface was reached at the head of the delta by May 29. Although the water flowing over the ice varied in depth, it reached 3 m above ice level by June 9. This level is sufficient to cover many bars and top many of the low riverbanks. In 1962, breakup (period 3) occurred in the delta between June 9 and 11. At the end of this breakup the river was cleared of ice except in a few areas where bottom ice remained. Following breakup, floodwater again began to increase in volume and velocity, and within five days attained the same absolute level that it had reached during the period of maximum preceding breakup. Although the current was strong during prebreakup flooding, it attained speeds of over 2 m per sec during the maximum postbreakup flood stage. Floodwater began to recede on June 14, and by June 20 the summer regime (period 5) had begun. This period lasts until fall freeze-up, or for about three months. During the summer of 1962, neither stage nor velocity approached those recorded during the three-week flood period accompanying breakup.

BANK EROSION—THE THERMO-EROSIONAL NICHE

Bank erosion, limited to about four months of the year in the lower Colville, is initiated with prebreakup flooding. These

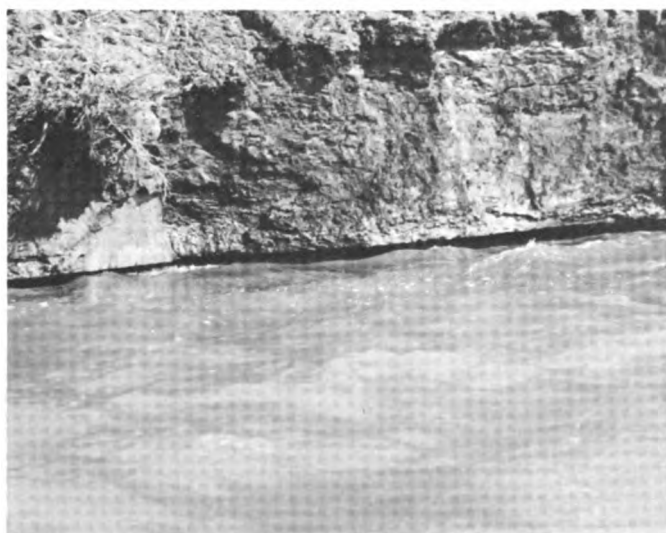

Fig. 3. Development of a thermo-erosional niche during flooding

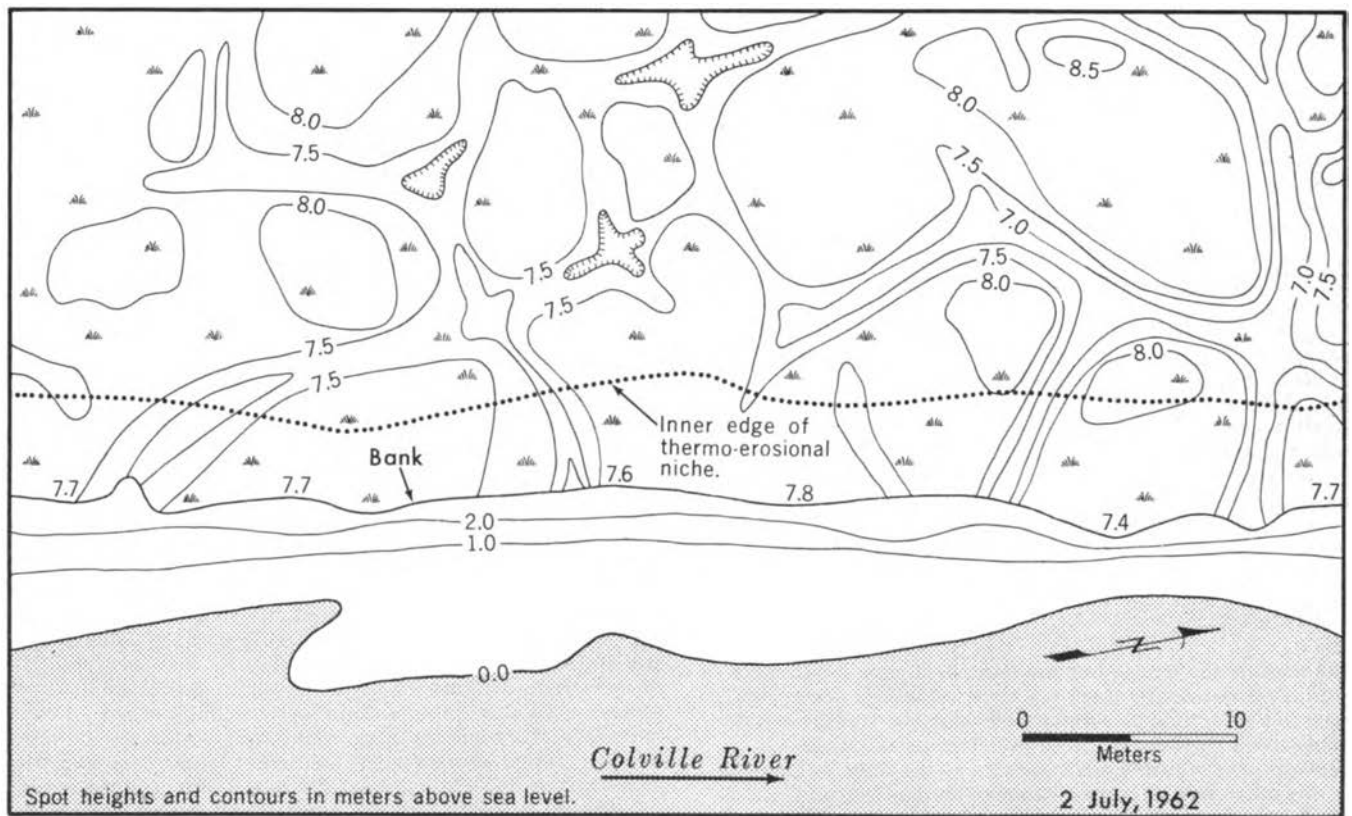

Fig. 4. Map shows depth of thermo-erosional niche in the Gubik Formation at Location 1 in Fig. 2

floodwaters, which first flow on top of the ice, undercut the snow that lies deep and compact against the high riverbanks. When contact is made with the frozen bank, thawing begins. As melt water increases in volume and the current increases in speed, undercutting of the bank is initiated.

Such undercutting (Fig. 3) results in what the Russian morphologists refer to as a thermo-erosional niche (termoerozionaja niza) [2]. This niche continues to widen and deepen as floodwaters increase in stage, velocity, and temperature. The development of the niche varies greatly with the type of material in which it is being formed. In banks lacking consolidated peat, undercutting proceeds rapidly, for consolidation of the sediment is provided only by its frozen nature. Once thawing has occurred, the materials are easily removed by the floodwaters. Undercutting in dense peat, on the other hand, proceeds much more slowly, for not only is thawing necessary, but also the bond formed by the vegetal matter must be broken before niche deepening can occur.

Undercutting initiated by prebreakup floods is continued by the floods accompanying and following breakup, but ceases as floodwaters begin to recede. In 1962, the effective period of bank undercutting for nearly all banks in the delta was not over three weeks.

BANK EROSION IN THE GUBIK FORMATION

The depth and form of thermo-erosional niches vary with bank type and with hydrodynamic conditions of the river. In the Gubik Formation, niches exposed after the floodwaters began to recede in 1962 extended as much as 8 m into the riverbank (Figs. 4, 5, and 6). This depth compares with the depths of 8 to 10 m reported for thermo-erosional niches in Siberia [3]. It is unknown how much of this depth formed in prior years. In Fig. 5, note the bottom of the ice-wedge which, because

of differential erosion, protrudes from the roof. This ice-wedge begins just south of the spot elevation 7.6 m in Fig. 4. The scale is shown by the rod 4 m long.

Although effective deepening of the niche ceases with the lowering of floodwaters, other changes continue to occur. During the time the niche is being formed and throughout the remainder of the summer, air temperature is effective in thawing the frozen bank. The thawed material sloughs from the bank and, during flooding, is carried away. Thus, bank recession continues until removal from the base of the bank is discontinued, after which time the bank assumes a more or less normal angle of repose.

As long as undercutting proceeds, removal of sediment

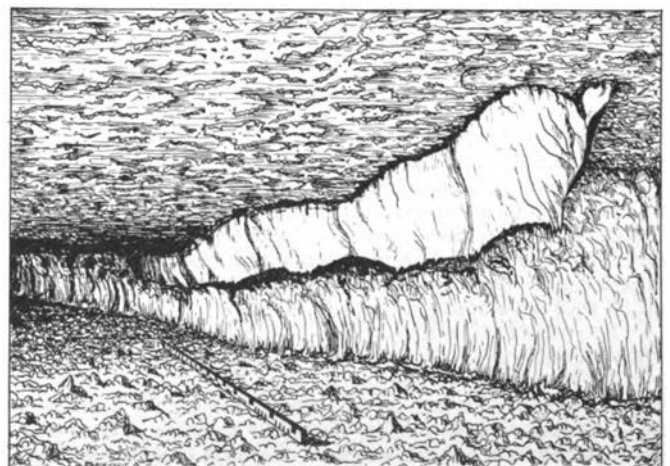

Fig. 5. Sketch of roof of the thermo-erosional niche mapped in Fig. 4

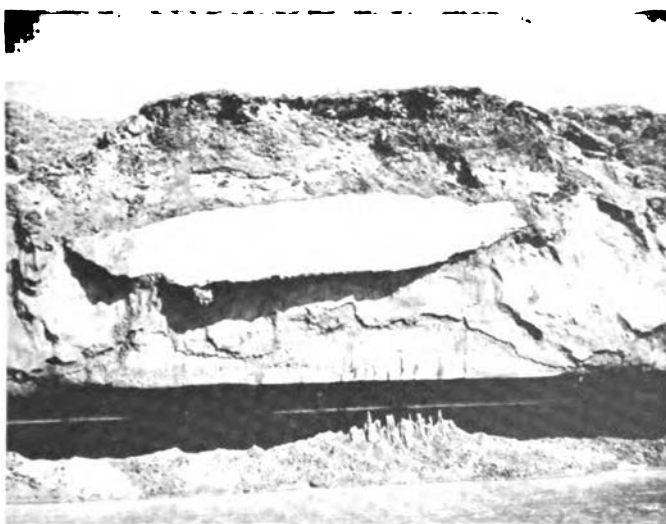

Fig. 6. A thermo-erosional niche in the Gubik Formation two days after floodwaters began to recede. Note deposits at the front of the niche

sloughed from the bank is insured. Under such conditions, the rate of bank recession is limited by the rate of thawing at the bank face. For several reasons this rate of recession is slower than the rate by which the niche is deepened. The rate of thaw is greater in the niche than on the bank face because, for any given temperature, the exchange of heat between water and a solid is more intensive than between air and the same solid [3]. Also, water temperature may average higher than air temperature during much of the flood season. Fig. 7 compares temperatures for part of 1962. River ice, schematically represented, emphasizes the relationship between air and water temperature and ice presence. In addition, the mechanical action of flowing water accounts for some preparation in the niche as well as the removal of material prepared.

After recession of the floodwaters, air temperature and gravity continue to cause changes in the niche. In the Gubik materials, the roof takes on an intricate pattern because of differential rate of thaw of the frozen sediments and enclosed ice, enclosed wedges are left like ribbons in the roof of the niche (Fig. 5).

The most important change in the niche, however, results from thawing of and sloughing from the overly steepened bank face. Sediment accumulates in front of the niche and in a few days, seals it. At the time of final sealing, the niche may be more than a meter less in depth than it was at the time

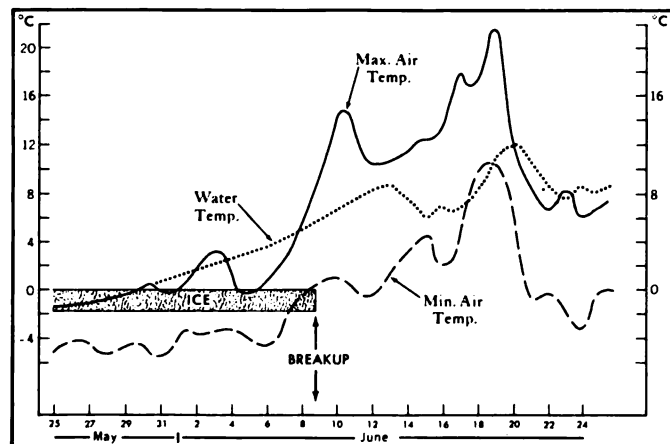

Fig. 7. Water and air temperature during prebreakup through postbreakup flooding



Fig. 8. Blocks two days after collapse. Note ice-wedges along which fracture occurred and the amount of sloughed material at the base of the vertical cliff. Location 1, Fig. 2

floodwaters began to recede.

Although bank sloughing is fairly continuous in the Gubik and other mineral banks, it apparently does not account for more than a meter's recession per year of all but some of the most vulnerable banks. Such a recession compares with that of 2 m calculated by A. J. Eardley for the frozen sand banks along the Yukon River, where summer is longer and average summer temperatures are higher [4].

Bank retreat caused by such sloughing is minor compared with that resulting from the collapse of the large hanging blocks formed by undercutting (referred to as "cornices" in Russian literature [2]). Collapse occurred at several locations in the delta in banks of various compositions and of various heights, but the most extensive collapse occurred in a section of the Gubik Formation (Fig. 8). Such block collapse in Alaska has been reported previously by numerous authors [5, 6, 7, 8] for the Yukon River; [9, 10, 11] for arctic coastal areas). The collapse reported here occurred two days after floodwaters began to recede and prior to the sealing of the thermo-erosional niche. The break occurred along an ice-wedge which averaged about 3.5 m deep and nearly paralleled the river. Before collapse, the thermo-erosional niche had been extended in places beyond the plane within which the ice-wedge occurred. Even though the wedge was not deep enough to be reached by the niche, it presented a zone of sufficient weakness to control the fracture line.

Fracture also occurred in planes perpendicular to the riverbank and again along ice-wedges. Fig. 9A shows the reconstructed bank a few days before collapse; Fig. 9B is a map of the bank made from a survey completed two weeks after collapse. The two maps show that ice-wedges not only exert an influence in the width of the collapsing bank, but also upon the length of the individual blocks.

Once such blocks break off, thawing of the permafrost proceeds rapidly from all sides. The vertical nature of the blocks results in immediate sloughing of the sediments as soon as they are thawed. The blocks are converted rapidly into pyramids, while the vertical cliff of the new bank face is changed into a steep slope (Figs. 10 and 9C). Total bank recession in this area of collapse averaged about 10 m (Figs. 11A and 11B). This amount is comparable to the third or highest degree of erosion for the sand banks of the Indigirka Delta as reported by Lomachenkov [12]. By the end of the summer, the new bank had reassumed its normal profile and the only evidence of a former collapse was the remnant piles (probably removed during the next flood season) and a slight break in the normally smooth, crescent-shaped bank crest (Fig. 10).

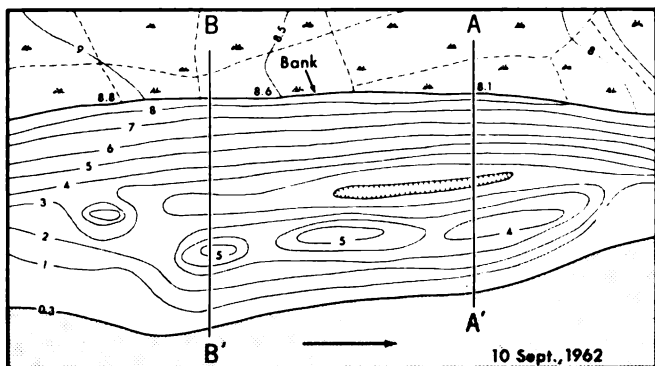
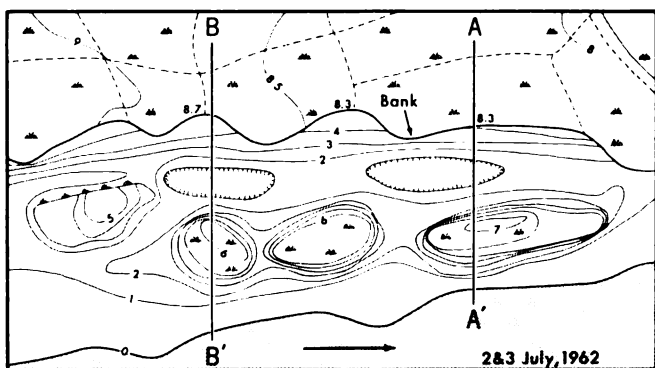
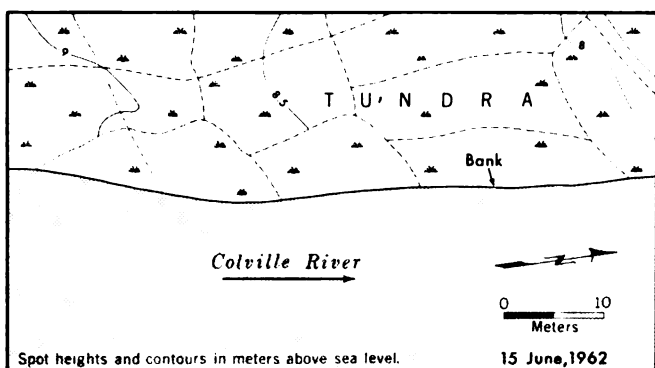

Fig. 9. Maps of the Gubik Formation showing the change in bank form occurring during the summer, 1962

- A. Bank at flood stage prior to collapse. Dashed lines represent ice-wedge positions
- B. Tundra vegetation covers the top of all blocks (compare with Fig. 8)
- C. Note smooth, slightly crescent-shaped bank crest and smoothness of the slopes of both the bank and the pyramidal piles at its base (compare with Fig. 10)

The smoothness of the bank slope reflects the fact that in highly mineralized banks, ice-wedges retreat at about the same rate as the mineral portion of the bank. The resultant bank thus presents no evidence of an enclosed ice-wedge system.

BANK EROSION IN SAND DUNES

Recession of banks made of sand dunes and the resultant bank form is very similar to that observed in the Gubik Formation. Notable differences depend on the absence of ice-wedges and on the more uniform texture of the sediments. Development



Fig. 10. Blocks of Fig. 8 after ten weeks

of the thermo-erosional niche (Fig. 12) is similar, and rapid sloughing also occurs. Spalling (Fig. 13) is more obvious than in the more variably textured Gubik Formation. Bank collapse (Fig. 14) occurs when gravity overcomes the cohesive strength of the frozen sand. Unlike in the Gubik Formation, no oriented wedges are present along which the break can occur. However, an occasional ice vein (Fig. 12) may serve as a line of weakness. The presence of tension cracks (Fig. 15) suggests that breaks result from more random planes of weakness than those provided by ice-wedges.

During low water, sand-dune banks develop an angle of repose in keeping with the texture of the dune sediments. Thus, as in the Gubik Formation, nearly all bank recession occurs during flooding.

BANK EROSION IN PEAT

Peat banks recede in a different fashion, although thermo-erosional niches are again important (Figs. 16 and 17). Because of the resistant nature of dense peat, ice-wedges erode faster than the peat itself. Rapid melting of exposed ice-wedges leaves indentations separated by polygonal blocks that appear as buttresses protruding into the river (Fig. 18). Melting of an ice-wedge, just as thawing of permafrost, proceeds more rapidly through water contact than air contact. Thus, ice-wedges also exhibit thermo-erosional niches.

Eventually, wedge recession will proceed to the point of juncture with wedges which parallel the river. Once these parallel wedges melt (Fig. 19), peat blocks having the form of the original ice-wedge polygons will be isolated. These blocks may or may not have been undercut sufficiently to have collapsed prior to the time of separation. The map (Fig. 20) shows three such blocks and presents a rather typical bank form observed in the Colville Delta.

Sealing of the thermo-erosional niche generally does not occur in such peat banks. Thawing, due to air contact, is limited to a few centimeters. As the enclosed mineral matter of this thin, thawed layer is removed, the vegetal remains form a protective layer that decreases both the rate of thaw and removal (Figs. 16 and 17). This mineral matter is of insufficient quantity to close the niche. On the other hand, the niche itself, even though open throughout the summer, is little modified. Vegetal fibers (Fig. 17) protect the roof of the niche as well as the bank from deep thawing.

TIME OF MAJOR BANK EROSION IN THE DELTA

Since bank collapse is closely correlated with the development of the thermo-erosional niche, and since development of this

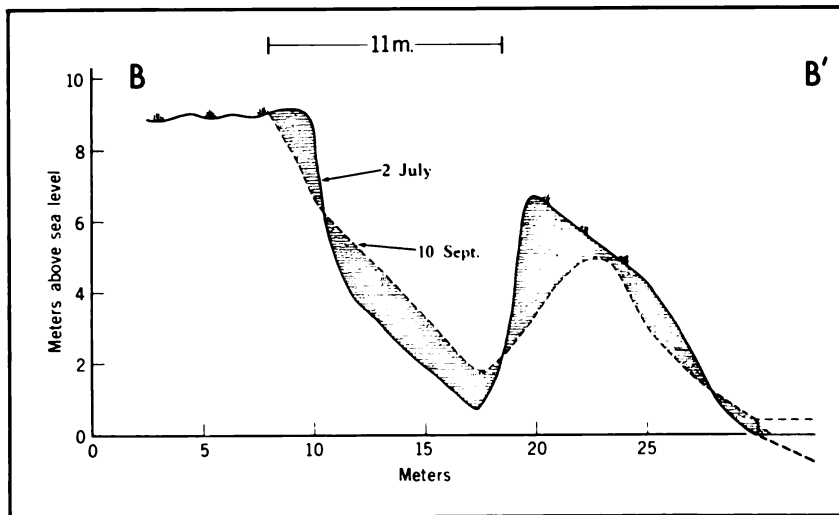
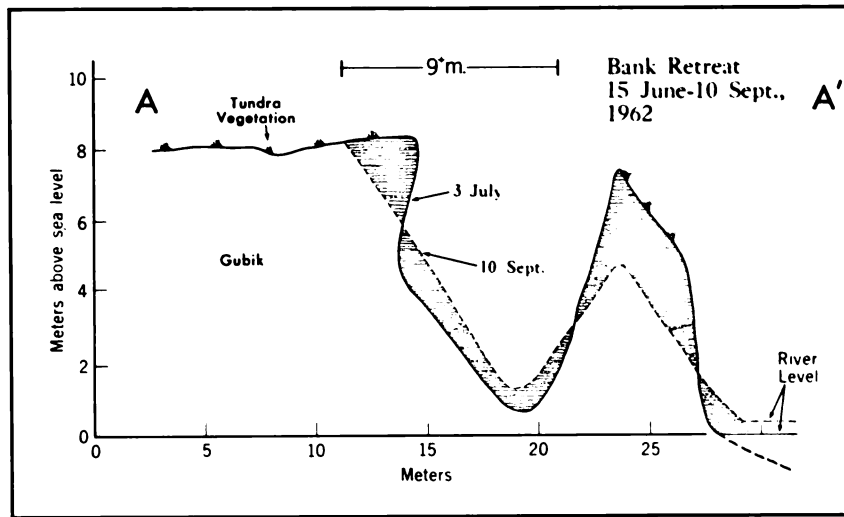

Fig. 11. Profiles at A and B of Fig. 9 show total bank recession and changes in block form

Fig. 12. Thermo-erosional niche in sand dune at Location 2 of Fig. 2. Note ice vein which stands out due to differential thawing

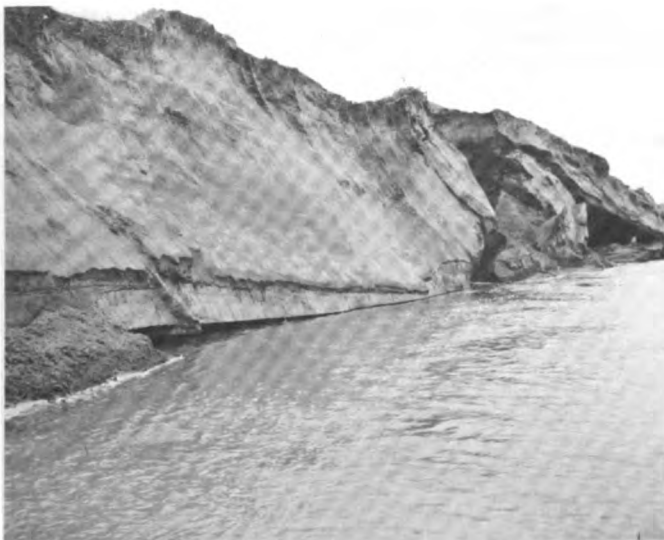

Fig. 13. Thermo-erosional niche in sand dune

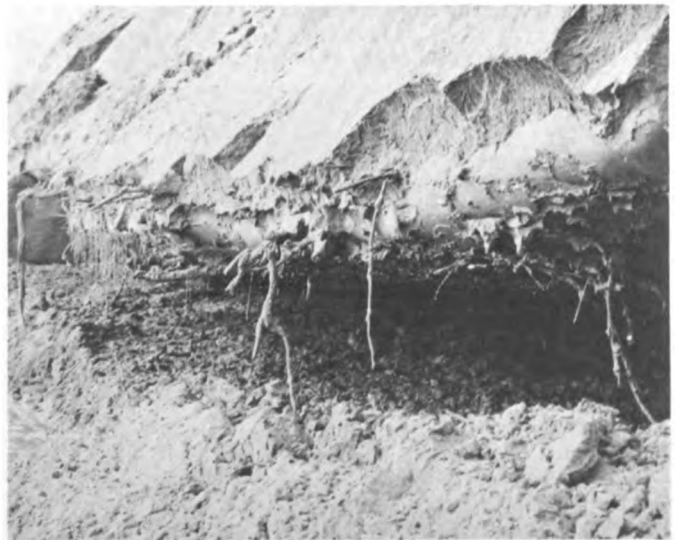



Fig. 14. Block of sand that collapsed during late summer as result of high water and wind-induced waves



Fig. 17. Closeup of undercut peat block showing vegetal fibers which protect the peat from deep thawing and abrasion



Fig. 15. Tension cracks in top of sand dune over the thermo-erosional niche in Fig. 13

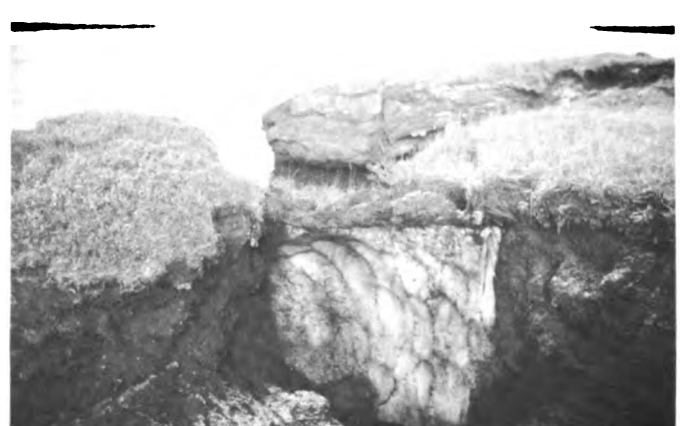

Fig. 18. Peat bank indentations represent the space formerly occupied by an ice-wedge

Fig. 16. Undercut peat block at Location 4, Fig. 2



Fig. 19. Ice-wedge in process of melting at Location 5, Fig. 2. When melting is complete, the block on the left will be isolated from the polygonal field



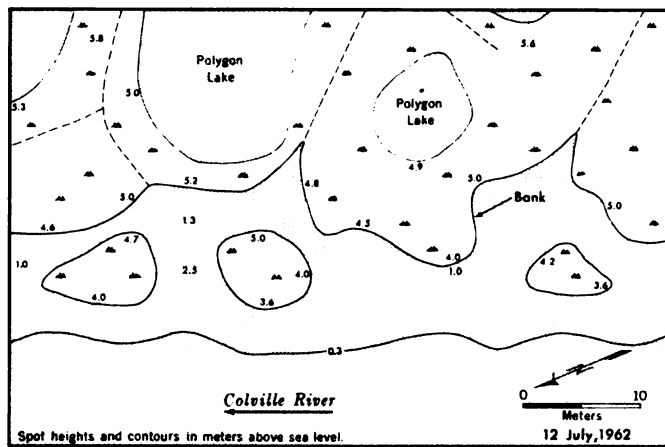

Fig. 20. Map of a section of the peat bank at Location 3, Fig. 2

niche depends almost entirely on flooding, major bank recession occurs during or shortly after flooding. The highest stages of the river are just before, during, and just after breakup, so maximum undercutting and resultant slumping almost always occur within two or three weeks. Abramov, however, noted that collapse was greatest toward the end of summer along the lower Lena River [13].

Those undercut banks in the delta that do not collapse prior to being sealed at their front will probably remain intact until their niche is reopened and deepened further. Kaplina writes that "One of the necessary conditions for the formation and preservation of deep niches, . . . is a sufficiently high resistance of the frozen rocks of the roof to breakage; the said resistance depends to a great extent on the temperature of the rocks" [3]. This resistance varies with the texture of the sediment as well as temperature. The slight temperature changes at depths and the low average permafrost temperature in the latitude of the Colville Delta allow the development and preservation of deep niches.

Under certain conditions in the Colville Delta during late June, July, and August, some renewed undercutting and slumping may occur. It is, however, associated primarily with an additional factor—wind-generated waves. The relation of wind-generated waves to bank erosion along arctic rivers has been examined by Williams [7] for the Yukon River and by Walker and Morgan [14] for the Colville River. Summer floods, dependent upon rain in the Colville's watershed, seldom if ever approach stages comparable to that experienced during breakup. However, this flooding during the summer may be sufficient to reopen the thermo-erosional niche which formed during the spring floods. Additionally, high water in summer not only depends on floods but also on the backing of sea water up the river by westerly winds. Probably such high water is seldom sufficient to cause much erosion except when accompanied by strong waves. The niche and collapsed block shown in Figs. 12, 13, and 14 were formed in late summer, after three days of high winds and high water.

An interesting observation on bank collapse is made by Stefansson, who wrote that "In winter, however, a sharp frost of sudden change in temperature often causes the earth to crack to a great depth. If one of the cracks happens to be suitably located, it cuts off the projecting bank and it may tumble upon the ice in mid-winter" [9]. In the Colville, this type of bank collapse appears to be rare, especially when compared to frequency of block collapse during flooding.

CONCLUSIONS

Permafrost and ice-wedges are two of many factors that influence the morphology and dynamics of riverbanks in the Colville Delta. Ice-wedges are important in two major ways: (1) They provide planes of weakness along which fracture is likely to occur during bank collapse, and (2) their rate of erosion is relatively rapid, especially when in banks of dense peat.

Permafrost is especially important because it affects erosion by allowing the formation of a thermo-erosional niche and the development of a cornice. The cornice is so common along the arctic rivers of Siberia that Gusev incorporated it, in its several varieties, as one of the keys in his riverbank classification [2]. Lomachenkov, using this classification, has made a 20-year prognosis of bank erosion for portions of the Indigirka Delta [12].

Lack of data for the Colville Delta prohibits such a sophisticated analysis. However, further study of the morphology and dynamics of riverbanks in the Colville Delta would probably profit by using Gusev's classification or by devising one which similarly incorporates the significant aspects of permafrost and ice-wedges along with the more common factors involved in riverbank erosion.

The field work for this study was conducted under the auspices of the Coastal Studies Institute, Louisiana State University, with financial support from the Geography Branch, Office of Naval Research, and with logistic support of the Arctic Research Laboratory at Barrow, Alaska.

REFERENCES

- [1] A. H. Lachenbruch. "Mechanics of Thermal Contraction Cracks and Ice-Wedge Polygons in Permafrost," *U. S. Geol. Survey, Spec. Paper No. 70*, 1962, p. 34.
- [2] A. I. Gusev. "On the Methods of Surveying the Banks at the Mouths of Rivers of the Polar Basin," *Trans. Inst. of Geol. of the Arctic*, Vol. 107, 1952, pp. 127-128.
- [3] T. N. Kaplina. "Some Features of Outwash of Shores Composed of Permanently Frozen Rocks," *Trans. Oceanographic Comm., Acad. Sci., USSR*, Vol. IV, 1952, pp. 114-115.
- [4] A. J. Eardley. "Yukon Channel Shifting," *Bull. Geol. Soc. Am.*, Vol. 49, 1938, p. 356.
- [5] I. C. Russell. "Notes on the Surface Geology of Alaska," *Bull. Geol. Soc. Am.*, Vol. 1, 1890.
- [6] J. E. Spurr. "Geology of the Yukon Gold District, Alaska," *U. S. Geol. Survey, 18th Ann. Rept.*, pt. 3, 1898.
- [7] J. R. Williams. "Effect of Wind-generated Waves on Migration of the Yukon River in the Yukon Flats, Alaska," *Science*, Vol. 115, No. 2283, 1952.
- [8] R. M. Waller. "Riverbank Erosion and Ground-water Conditions at Beaver, Alaska," *U. S. Geol. Survey, Open File Ser.*, 1957.
- [9] V. Stefansson. "Underground Ice in Northern Alaska," *Bull. Geol. Soc. Am.*, Vol. 42, 1910.
- [10] E. deK. Leffingwell. *The Canning River Region, Northern Alaska*, Washington, U.S. Govt. Print. Office, 1919.
- [11] E. deK. Leffingwell. "Ground-ice Wedges, the Dominant Form of Ground Ice on the North Coast of Alaska," *J. Geol.*, Vol. 23, 1915.
- [12] V. S. Lomachenkov. "The Preparation of Maps on the Morphology and Dynamics of the Banks of Low River Terraces in an Area of Permafrost," *Trans. Inst. Geol. of the Arctic*, Vol. 65, 1959, pp. 157-158.
- [13] R. V. Abramov. "Thaw-out Niches," *Priroda*, Vol. 46, No. 7, 1957, p. 112.
- [14] H. J. Walker, H. M. Morgan. "Unusual Weather and Riverbank Erosion in the Colville Delta, Alaska," *Arctic*, Vol. 17, 1964.

PERMAFROST MAP OF ALASKA

OSCAR J. FERRIANS, Jr., U. S. Geological Survey, Washington, D. C.

All available data were utilized in the compilation of a permafrost map of Alaska, which was drawn at a scale of 1 to 2,500,000. In areas where adequate data were lacking, extrapolations were made from known areas by evaluating the climatic, geologic, topographic, and botanic factors that influence the character and distribution of permafrost. Eighty-five per cent of Alaska is within the permafrost region. Outside the permafrost region a few isolated masses of permafrost occur at high altitudes and in areas of high ground insulation and low ground insolation, especially near the border of the permafrost region.

The permafrost region is separated into two major divisions: (1) Mountainous areas where summits generally exceed 3000 ft and (2) lowland and upland areas where summits generally are less than 3000 ft. In mountainous areas, bedrock is at or near the surface: Lowland and upland areas are underlain predominantly by unconsolidated deposits. The thickness, distribution, and temperature of permafrost are extremely variable in mountainous areas, whereas in the lowland and upland areas these characteristics are more uniform.

From north to south, the mountainous areas are subdivided into three map units: (1) Areas generally underlain by permafrost, (2) areas generally underlain by discontinuous permafrost, and (3) areas generally underlain by isolated masses of permafrost.

Lowland and upland areas are subdivided into six map units that can be grouped into three broad zones: (1) The northern

zone, located north of the Brooks Range in most part, is generally underlain by thick permafrost; (2) the central zone, located between the Brooks and Alaska Range but including the Copper River Basin, is generally underlain by moderately thick to thin permafrost in areas of fine grained deposits and by discontinuous permafrost or isolated masses of permafrost in areas of thick, coarse grained deposits; and (3) the southern zone, which includes the Bristol Bay area and the northwestern Susitna Lowland, is generally underlain by numerous isolated masses of permafrost in areas of fine grained deposits and is generally free of permafrost in areas of thick, coarse grained deposits. Permafrost temperature just below the zone of seasonal variation generally ranges from -5° to -11°C in the northern zone and from -1° to -5°C in the central zone; it is generally above -1°C in the southern zone. The known thickness of permafrost ranges from more than 1300 ft near Barrow in the northernmost part of the permafrost region to lenses less than a foot thick in the southernmost part.

Publication authorized by the Director, U. S. Geological Survey.

Editor's Note

The author has submitted the Permafrost Map of Alaska for publication as a U. S. Geological Survey Miscellaneous Investigations Map.

PERMAFROST IN THE RECENT EPOCH

DONALD R. NICHOLS, U. S. Geological Survey, Washington, D. C.

Permafrost, whose origin was controversial for many years, is generally considered today as the product of past ground temperatures brought into equilibrium with present negative mean annual air temperature and the geothermal gradient. For a number of years, however, many workers [1 to 6] regarded permafrost as a "legacy from the last great ice age (Pleistocene Epoch)" [7]. Others recognized that permafrost exists in some Recent sediments, but that most formed during the Pleistocene [8 to 11]. Today relic permafrost is being aggraded or degraded, depending on the local environment, while new permafrost is being generated where climatic conditions are sufficiently cold [12 to 23]. A growing volume of literature attests to the present existence of permafrost in places that were covered by late Pleistocene glaciers, seas, or lakes; much of this permafrost is of Recent origin. The following data are presented as supporting evidence that permafrost has formed in unfrozen Pleistocene and later sediments in a subarctic region that has marginal subfreezing mean temperatures.

RECENT PERMAFROST IN COPPER RIVER BASIN

The Copper River Basin in south-central Alaska occupies an area of more than 7000 sq km between $61^{\circ}30'N$ and $63^{\circ}N$ lat. During each Pleistocene glaciation, the basin was invaded by ice from the bordering mountains, damming exterior drainage; ice covered the basin floor during earlier glaciations and flowed outward through low cols. The less extensive glaciers of the last major Pleistocene glaciation entered the margins of the basin and fronted in a large proglacial lake that covered at least 5000 sq km of the basin floor and that had a maximum depth of about 300 m. Temperatures in the sediments beneath

the lake were governed by the geothermal gradient in equilibrium with the water temperature which presumably remained slightly above 0°C . Even under the bordering glaciers, significant thicknesses of permafrost probably were lacking, because the geothermal gradient was controlled by the basal temperature of the ice (around 0°C). These conditions persisted from prior to 35,000 years ago to about 9000 years ago, as shown by radiocarbon age determinations [24]. From data presented by Johnston and Brown [25], Lachenbruch [26], Werenskiold [27], and others, it appears unlikely that permafrost, if it had been present prior to or at the beginning of the last major glaciation, would have persisted or formed under the glaciers or lake bed. Thus, permafrost probably existed only in nunataks in the surrounding mountains or as pods or small masses under local high ground not covered by either ice or lake water.

The Copper River Basin presently has a subarctic continental climate with mild to warm summers and severe winters. In the lower part of the basin, at the Gulkana airfield, the mean annual temperature is -2.8°C , and the mean annual precipitation is 30 cm; the mean snowfall is about 125 cm, although there is seldom more than 60 cm of snow on the ground at any one time. Seasonal frost under these conditions may penetrate to a maximum depth of 3 to 4 m in areas of granular materials having a thin vegetation and snow cover. In most places, it probably merges with the permafrost table at 1 to 2 m below the ground surface.

Much quantitative data have been collected during the course of a cooperative permafrost program between the Alaska Road Commission (later the U. S. Bureau of Public Roads and the Alaska Department of Highways) and the U. S. Geological Survey [28]. Substantiating qualitative

information also has been obtained from excellent river bluff exposures, test pits, and general surface observations by several geologic field parties. From these data it is apparent that permafrost, generally at shallow depth, underlies all the basin, with the possible exception of lakes and river flood plains for which no data are available. Permafrost has been observed in sandy and gravelly deposits of low terraces along major rivers; ice masses as thick as 60 cm are found in silty and sandy terrace deposits of small streams deeply incised into the Pleistocene lake floor.

The thickness of permafrost, difficult to ascertain because of the limited number of well-recorded drill logs, probably is variable. Frozen silt has been observed in freshly exposed river bluffs, most of which consist of till and glaciolacustrine deposits of Wisconsin age from depths of 1 to 75 m [29]. Thermistor cables have recorded frozen ground to a maximum depth of 55 m. The minimum temperature encountered below the line of zero amplitude (15 to 18 m) in these holes was -1.0°C .

Ground ice is present in several forms throughout the basin. It appears most commonly as finely segregated ice crystals in unconsolidated deposits. Such ice generally averages between 30 to 60% of the dry weight of the soil, and locally may be much more. Thin, discontinuous ice-lenses are common along bedding planes of laminated deposits, such as lacustrine sand and silt, or as veinlets along fracture planes in bedrock. Although large masses of ground ice are found, their growth and distribution may be restricted by saline ground water in the lower parts of the basin. This ground water also may impede the downward aggradation of permafrost. Amorphous and irregular masses of ice as large as 5 m in diameter are the most common type of large ice mass; they are most likely to occur in massive deposits. Multilayered, tabular sheets of ice 60 to 90 cm thick with vertical ice "dikes" connecting some sheets [29] have been seen in well-bedded deposits at several localities. Ice-wedges, although not generally encountered, are usually small; the largest measured was up to 60 cm wide and 120 cm long vertically. A 75 m bluff on the south side of the Copper River 40 km north-east of Gakona contains all types of ice present in the basin. Some sheets of ice in the bluff contained large unfilled voids or fractures as much as 30 cm wide and 150 cm long, probably brought about by cracking of the ice during arching of the beds. The numerous thick ice sheets, fissures in the ice, and arching of the beds suggest an incipient pingo, the development of which was arrested by river erosion.

Surface manifestations of buried ground ice are relatively rare within the limits of glacial and lacustrine deposits of Wisconsin age in the Copper River Basin, but they are evident on older morainal deposits. The lower Klawasi mud volcano [30], a low conical hill east of the Copper River, was described by Frost as a pingo [31]. The interpretation of this mud volcano at 62°N lat. and another pingo-like feature at 65°N lat. as true pingos was questioned by Fritz Müller [32], because they lie considerably south of most known pingos in Alaska. However, since numerous other pingos have been found recently in central Alaska between 63°N and 65°N lat. [33], the 65°N to 75°N lat. limits of the typical pingo environment, as described by Fritz Müller [32], should be revised. Although the Lower Klawasi and other mud volcanoes in the Copper River Basin are unrelated to permafrost phenomena, it is possible that pingos may have existed in the basin during the Pleistocene and may be forming today as the incipient pingo described above. Arched or domed lacustrine beds, consistent in magnitude with known pingo forms, have been observed in deeply buried, early Pleistocene deposits in the Copper River Basin; they may be fossil pingos. Further study of existing pingos also may provide clues to climatic and permafrost conditions existing during the formation of incipient and fossil pingos.

DATING OF RECENT PERMAFROST

Permafrost in the Copper River Basin was determined by the carbon-14 method to be of Recent age at two places. In 1954,

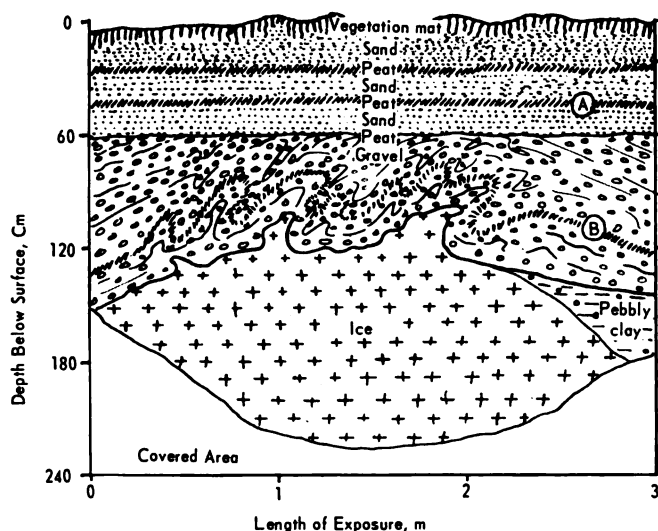

Fig. 1. Sketch of layers in an exposed bluff; radiocarbon dates were determined at A and B

in a bluff along the east side of Tolsona Creek, a contorted peat layer and several undisturbed peat beds were exposed over a large ice mass. The ice mass, more than 1 m thick and 3 m long, was largely at the top of pebbly lacustrine clay; but in a few places, it intruded upward into 60 cm of contorted medium gravel which was arched directly over the ice. In the middle of the gravel was a folded peat layer as much as 5 cm thick (Fig. 1). The gravel was unconformably overlain by 60 cm of undisturbed, horizontally-bedded, medium-grained sand which contained two peat layers, each 2.5 to 5 cm thick. The lower peat layer in the sand (A) and the peat in the gravel (B) have been dated by the U.S. Geological Survey (W-1307) as 5850 ± 320 years old [35] and (W-717) 6910 ± 250 years old [34], respectively, and thus bracket the period of ice mass growth. The frozen sediments over the clay and ice are interpreted as having been deposited by Tolsona Creek during a stage of dissection of the Wisconsin lacustrine plain. The fact that this period lies within the postglacial thermal maximum (9000 to 3000 years ago according to Ahlmann [36] and 7500 to about 4000 years ago according to Flint [37]) raises the question as to whether the date may not record a period of partial thaw of pre-existing ice rather than growth of a new mass. This interpretation would require the gravel and enclosing peat to have been deposited by Tolsona Creek directly on the ice without disturbing it; subsequent thaw of the ice and deformation of the peat would have taken place during the hiatus represented by the truncation of the gravel, and prior to deposition of the overlying sand and peat. Such an interpretation is discounted because of the arching of the contorted gravel and peat over the ice and because of the improbability of the ice mass persisting while the gravel and peat were deposited.

The Copper River bluff containing the incipient pingo section is capped by a peat bed 5 m thick, the base of which has been dated at 4610 ± 200 years old [38]. Ice-wedges near the top of the peat obviously formed after the lower part of the peat had been deposited and probably within the last 2000 years; the date cannot be used to determine the age of the ice masses in the underlying glaciolacustrine deposits.

Elsewhere in Alaska, reports have been published detailing aggradation of permafrost in Recent alluvium and other deposits, but relatively few such reports contain absolute age determinations. In the Nome area, Hopkins, MacNeil, and Leopold [39] have dated ice-wedges as forming after 8000 to 9000 years ago. In the Fairbanks area, Péwé [40] records that the upper few feet of permafrost thawed between 5000 to 6000 years ago, and since that time permafrost has reformed.

EVIDENCE OF PLEISTOCENE PERMAFROST IN THE COPPER RIVER BASIN

Permafrost probably was present in the Copper River Basin at various times during the Pleistocene. Thick permafrost and bodies of frozen ground at depth, both of which have been considered as evidence of relic Pleistocene permafrost [11, 12], have been reported in areas bordering the Copper River Basin. Bateman and McLaughlin [41] found permafrost as much as 275 m beneath steep slopes or to a depth of 150 m normal to the surface at high elevations in the Wrangell Mountains southeast of the Copper River Basin. This permafrost, encountered in the Jumbo and Bonanza mines, is many times thicker than that normally found in the basin, and may be a relic of Pleistocene permafrost preserved in a nunatak between trunk glaciers.

Taber [11] also cites the presence of "a frozen blue clay containing ice layers, one of which was 2 ft (60 cm) thick" beneath gravel and 48 ft (14.6 m) below the surface at Ernestine in the Chugach Mountains south of the basin. He felt that this occurrence was an indication of freezing when the climate was colder. Because the gravel and blue clay probably were deposited during the Wisconsin glaciation, they did not become exposed to cold air temperatures until the ice had retreated and the lake water had drained. Rather than a recent amelioration of climate, the depth to permafrost at this locality more likely results from thawing of the ground after removal of the insulating vegetation cover by forest fires, which were common during settlement of the area in the early 1900's. Interpermafrost taliks, which have been considered to represent deep thaw of the upper part of relic permafrost followed by partial regrowth during more recent cold periods [42], are not known in the Copper River Basin.

In addition to deep permafrost in the Wrangell Mountains bordering the basin and possible fossil pingo-like structures in the basin, several features recorded in the stratigraphy are indicative of the existence of permafrost throughout the Pleistocene. Wedges of sand and silt in pre-Wisconsin glaciolacustrine sediments or in organic silt are interpreted as fossil ice-wedges; bedding planes of sediments adjacent to wedges generally have an upward dip along the contact, particularly near the top of the wedge. Highly convoluted buried soil profiles occur in sand, silt, and organic deposits. Although some of these features are indicative only of strong frost stirring, slumping, iceberg drag, etc., the convoluted layer abruptly terminated at the base is evidence of permafrost. Permafrost in Recent deposits inhibits downward congluturbation in areas characterized by a shallow active zone. Because most of these features are either in deposits interpreted as interglacial or are buried by glacial deposits, they probably were formed during early or late glacial cool periods, if not during relatively warm, interglacial periods.

PERMAFROST IN OTHER AREAS

The large land areas of Alaska, the Soviet Union, Canada, and elsewhere in the Arctic and sub-Arctic that were covered by ice or water probably were free from permafrost during much of the Wisconsin glaciation. Hopkins, Karlstrom, and others [14] have stated that in Alaska "large areas insulated by ice were protected from low air temperatures at the same time that perennially frozen ground was forming to great depths in adjoining ice-free lowlands. Permafrost beneath glaciated surfaces has formed largely in periods of less cold climate during and since deglaciation and thus probably is limited to relatively shallow depths." Péwé [43] believes that changes in climate during the Pleistocene resulted in several cycles of permafrost formation and degradation in the Fairbanks area. Cressey [44] has written that "where the ice moved farthest south, in western Siberia, the limits of frozen ground are far to the north, in the tundra. In the regions east of the Yenisei River, where the ice was absent, frozen ground extends south into Mongolia.

Ice is a poor conductor and the thick glacial blanket must

have insulated the earth from abnormally low atmospheric temperatures." Obruchev [19] reports that "soil temperatures under thick glacier ice and snow cover remain near the freezing point because of the insulating effects of snow and ice and the permafrost of western Siberia probably was formed in the arid climate of the postglacial period."

Jenness also believes that much of the permafrost in Canada is of Recent origin. He states, "One thing seems certain, viz., that no permafrost can originate underneath huge masses of snow and ice; for these masses, so thick that friction and pressure tend to keep the ice on the bottom at its melting point, can do no more than serve as an insulating blanket superimposed on any frost that may already exist on the ground." [15] It is problematical, however, whether relic permafrost could persist under large ice sheets while heat from the interior of the earth is seeking equilibrium with the near-freezing temperature at the base of the ice. Jenness [15] has cited the lack of permafrost under Hudson Bay as evidence that permafrost under land surfaces covered by the seas during the last major glaciation is of Recent origin.

The permafrost map of Canada recently prepared by the National Research Council [45] indicates that much of the permafrost in Canada must be of Recent origin if permafrost did not exist under surfaces covered by Wisconsin glaciers or water. The fact that glacial and permafrost boundaries bear little direct relation and that permafrost now exists where it was prohibited during deposition of subglacial deposits does not, as was suggested by Flint [37], invalidate the theory that ice sheets act as thermal insulators. In all likelihood, glaciers did "spread over Arctic areas already underlain by permafrost" [37], but it is equally likely that permafrost was largely dissipated during the long period of ice cover and that its regrowth has taken place after retreat of the ice.

CONCLUSIONS

Permafrost formed and disappeared from the ground at least once during the Pleistocene in the Copper River Basin. Most permafrost that may have existed in the early part of Wisconsin glaciation gradually melted by upward conduction of heat from the earth's interior during the long period glaciers and lake water insulated the ground surface from low air temperatures. As the ground was exposed to the much lower mean annual temperature of the air, progressive downward freezing from the surface formed as much as 55 m or more of permafrost during the Recent Epoch. A similar history is envisioned for the ground thermal regime in other glaciated and water-covered areas in the arctic and subarctic.

Ground ice, in the Copper River Basin, although generally seen as segregated crystals and veins, also is found locally in wedges, sheets, and amorphous masses. Ice masses have been dated as 7000 to 5800 years old at one locality and less than 2000 years old at another. The relatively high mean annual temperature, general homogeneity of materials near the surface, and saline ground water may account in part for the lack of widespread patterned-ground features. The widespread distribution of permafrost, its accretion in young sediments, the lack of widespread large ice masses and patterned-ground features, and the growth of ground ice during the postglacial thermal maximum all attest to a relatively uniform growth of permafrost under the moderate climate conditions of the Recent Epoch.

REFERENCES

- [1] M. I. Sumgin. * "Permafrost" (Über die ewige Gefrorenis des Bodens), *Zeits. Ges. Erdkunde Berlin*, Nos. 1, 2, 1929, pp. 27-32, SIPRE U6683.
- [2] M. I. Sumgin. * "Permafrost Study in the Years 1933-1937," *Sovetski Sever*, Vol. 4, No. 1, 1933, pp. 47-53, SIPRE 10603.
- [3] I. P. Gerasimov, K. K. Markov. * "Glacial Period in the Territory of the USSR," *Izdatel'stvo Akad. Nauk SSSR*, Moscow-Leningrad, 1939, SIPRE U6605.
- [4] Stephen Taber. "Some Problems of Road Construction and Maintenance in Alaska," *Public Roads*, Vol. 23, No. 9, 1943,

- pp. 247-251.
- [5] R. M. Hardy. "Permanently Frozen Ground and Foundation Design, Part I," Eng. J., Vol. 29, No. 1, 1946, pp.4-7.
- [6] R. A. Hemstock. "Permafrost Problems in Oil Development in Northern Canada," Canadian Mining Metallurg. Bull., Vol. 45, No. 481, 1952, pp. 280-283.
- [7] Directorate of Eng. Development, Army Headquarters, Ottawa. "Permafrost: A Digest of Current Information," Natl. Res. Coun. Canada, Tech. Memo. 49, 1957, p. 1.
- [8] R. F. Black. "Permafrost," Applied Sedimentation, Trask, P. D., ed., John Wiley, New York, 1950, pp. 247-275.
- [9] Nestor Korol. "Agriculture in the Zone of Perpetual Frost," Science, Vol. 122, No. 3172, 1955, pp. 680-682.
- [10] S. W. Muller. "Permafrost or Permanently Frozen Ground and Related Engineering Problems," U.S. Geol. Survey Spec. Rept., Strategic Engineering Study 62, Military Intelligence Div., Office Chief Engrs., U.S. Army, 1945. Also lithoprinted Edwards Brothers, Ann Arbor, Mich., 1947, p. 10.
- [11] Stephen Taber. "Perennially Frozen Ground in Alaska: Its Origin and History," Geol. Soc. Am. Bull., Vol. 54, No. 10, 1943, pp. 1433-1548.
- [12] R. F. Black. "Permafrost—A Review," Geol. Soc. Am. Bull., Vol. 66, 1954, pp. 839-856.
- [13] G. E. Bykov.* "On the Question of Climates During the Quaternary Period of the Far East and on the History of Permanently Frozen Ground," Akad. Nauk SSSR, Compt. Rend. (Doklady), new ser., Vol. 20, No. 5, 1938, pp. 387-390, SIPRE 7385.
- [14] D. M. Hopkins, T.N.V. Karlstrom, et al. "Permafrost and Ground Water in Alaska," U.S. Geol. Survey Prof. Paper 264-F, 1955, pp. 113-146.
- [15] J. L. Jenness. "Permafrost in Canada," Arctic, Vol. 2, No. 1, 1949, pp. 13-27.
- [16] A. K. Khrgian.* "On the Temperature and the Origin of Permafrost," Meteorologiya i Gidrologiya, Vol. 1, No. 3, 1936, pp. 69-72, SIPRE U2372.
- [17] D. R. Nichols, L. A. Yehle. "Highway Construction and Maintenance Problems in Permafrost Areas," Engr. Exptl. Sta., Univ. Tenn. Bull., No. 24, 1961, pp. 19-29.
- [18] C. C. Nikiforoff. "The Perpetually Frozen Subsoil of Siberia," Soil Sci., Vol. 36, 1928, pp. 61-82.
- [19] V. A. Obruchev.* "Geomorphological, Geological, and Hydrological Problems in Siberia," Obruchev, V.A., Izbrannye raboty po geografii Azii: Gosudarstvennoe Izdatel'stvo Geograficheskoi Literatury, Moscow, Vol. 2, 1951, pp. 138-154, SIPRE 12119.
- [20] I. C. Russell. "Notes on the Surface Geology of Alaska," Geol. Soc. Am. Bull., Vol. 1, 1890, pp. 99-162.
- [21] P. S. Smith. "Areal Geology of Alaska," U.S. Geol. Survey Prof. Paper 192, 1939, pp. 70-71.
- [22] Vihjalmur Stefansson. Arctic Manual, MacMillan, New York, 1944.
- [23] S. M. Stepanitskaia.* "On the Question of Permafrost Age," Pochvovedenie, Vol. 36, No. 4, 1941, pp. 83-98, SIPRE U3843.
- [24] D. R. Nichols, L. A. Yehle. Priv. comm., 1963.
- [25] G. H. Johnston, R.J.E. Brown. "Effects of a Lake on Distribution of Permafrost in the Mackenzie River Delta," Proc. First Canadian Conf. Permafrost, 1962, Natl. Research Council Canada, Tech. Memo. 76, 1963, pp. 218-225.
- [26] A. H. Lachenbruch. "Thermal Effects of the Ocean on Permafrost," Geol. Soc. Am. Bull., Vol. 68, 1957, pp. 1515-1530.
- [27] W. Werenskiold. "The Extent of Frozen Ground under the Sea Bottom and Glacier Beds," J. Glaciol., Vol. 2, No. 13, 1953, pp. 197-200.
- [28] D. R. Nichols, J. R. Watson, Jr. "Prelim. Rept. Engineering Permafrost Studies in the Glennallen Area, Alaska," (abs.), Geol. Soc. Am. Bull., Vol. 66, 1955, p. 1706.
- [29] D. R. Nichols. "Permafrost and Ground-Water Conditions in the Glennallen Area, Alaska," U.S. Geol. Survey Open File Rept. No. 392, 1956.
- [30] D. R. Nichols, L. A. Yehle. "Mud Volcanoes in the Copper River Basin, Alaska," Geology of the Arctic, Univ. Toronto Press, Toronto, Canada, 1961, pp. 1063-1087.
- [31] R. E. Frost. "Interpretation of Permafrost Features from Airphotos," Natl. Research Council, Highway Research Board, Spec. Rept., No. 2, 1952, pp. 223-246.
- [32] Fritz Müller. "Observations on Pingos," Medd: om Grønland, Bd. 153, Nr. 3, 1959, 127 pp., transl. by D. A. Sinclair, Natl. Research Council, Canada, Tech. Transl. 1073, 1963, p. 117.
- [33] G. W. Holmes, D. M. Hopkins, H. L. Foster. "Pingos in Central Alaska," (abs.), Abstracts for 1962, Geol. Soc. Am. Spec. Paper No. 73, 1963, p. 173.
- [34] Meyer Rubin, Corrinne Alexander. "U.S. Geological Survey Radiocarbon Dates V," Am. J. Sci., Radiocarbon Supp., Vol. 2, 1960, pp. 129-185.
- [35] Meyer Rubin, Corrinne Alexander. Priv. comm. on sample W-1304, 1963.
- [36] H. W. Ahlmann. "Glacier Variations and Climatic Fluctuations," Am. Geog. Soc., Ser. 3, 1953, p. 38.
- [37] R. F. Flint. Glacial and Pleistocene Geology, John Wiley, New York, 1957, p. 377.
- [38] Meyer Rubin, H. E. Suess. "U.S. Geological Survey Radiocarbon Dates III," Science, Vol. 123, No. 3194, 1956, pp. 442-448.
- [39] D. M. Hopkins, F. S. MacNeil, E. B. Leopold. "The Coastal Plain at Nome, Alaska: A Late Cenozoic Type Section for the Bering Strait Region," Intl. Geol. Congr., 21st, Copenhagen, Rept., Pt. IV, Chronology and Climatology of the Quaternary, 1960, pp. 46-57.
- [40] T. L. Péwé. "Geology of the Fairbanks (D-2) Quadrangle, Alaska," U.S. Geol. Survey Geol. Quad. Map GQ-110, 1958.
- [41] A. M. Bateman, D. H. McLaughlin. "Geology of the Ore Deposits of Kennecott, Alaska," Econ. Geol., Vol. 15, No. 1, 1920, p. 51.
- [42] Z. M. Belorusova. "Eternal Congelation at Tazovsky Peninsula and the History of its Development in Quaternary Time," Vestnik leningradskogo universiteta, Seriya geologii i geografii, No. 12, 1963, pp. 79-89, (English summary).
- [43] T. L. Péwé. "Geomorphology of the Fairbanks Area, Alaska," thesis for Ph.D., Stanford University, Palo Alto, Calif., 1952, pp. 204-208.
- [44] G. B. Cressey. "Frozen Ground in Siberia," J. Geol., Vol. 47, 1939, pp. 472-488.
- [45] R.J.E. Brown. "The Distribution of Permafrost and its Relation to Air Temperature in Canada and the USSR," Arctic, Vol. 13, No. 3, 1960, pp. 163-177.

*Original publication not examined; Snow, Ice, and Permafrost Research Establishment (SIPRE) abstract source of reference.

EVIDENCES OF GROUND WATER FLOW IN PERMAFROST REGIONS

L. V. BRANDON, Scientific Officer, Geological Survey of Canada

In a permafrost region it is pertinent to ask what effect permafrost has on ground water and what evidence there is for ground water flow.

PERMAFROST EFFECTS

Permafrost has two effects on ground water flow: Low temperature reduces the rate of ground water flow, and frozen ground increases the number of impermeable boundaries within a ground water flow system.

Rate of Ground Water Flow

The rate of ground water discharge into streams in permafrost regions is lower than in an equivalent region under a temperate climate because of increased viscosity of water.

Darcy's law, describing the rate of flow by intergranular permeation, may be written

$$V_z = \frac{-K_o \gamma_w}{\mu} \left(\frac{dh}{dz} \right) \quad (1)$$

where V is velocity, z is distance in the direction of flow, h is the total head, where total head equals the sum of elevation and pressure head [1]. K_o is the physical permeability constant occurring in the relation

$$K = \frac{K_o \gamma_w}{\mu} \quad (2)$$

where K represents the over-all coefficient of permeability, γ_w represents unit weight of fluid, and μ is viscosity [2].

The correction for μ is significant in a subarctic climate because velocity is inversely proportional to the viscosity of the fluid which flows through the permeable medium.

Temperatures of shallow ground waters in northern latitudes range from 32° to 40°F and therefore have viscosities from 1.79 to 1.55 cp. In temperate regions where ground water temperatures may be 50° to 60°F the viscosity ranges from 1.05 to 1.30 cp.

Addition of Impermeable Boundaries

Ground water moves from a high fluid potential to a lower fluid potential under the influence of gravity. Three types of flow can be distinguished: (a) Intergranular permeation through unconsolidated materials. (b) Joint, bedding plane, and fracture flow in various rock systems. (c) Solution channel flow through enlarged conduits that have been formed by dissolution of rock in a sedimentary stratum.

Permafrost creates an impermeable boundary in ground water recharge areas by preventing infiltration. Therefore, in regions of continuous permafrost, ground water infiltration can only occur in karst rocks where solution channel flow is possible. Permafrost adds impermeable boundaries which restrict and confine flow in sands and gravels (where permeation would occur under temperate-zone temperatures) and thus limits the available area for flow. Similarly it may restrict ground water discharge in areas which are topographically discharge areas.

Permafrost, therefore, affects the hydrology of a region. Its effect on infiltration may be seen in regions of low relief in drift-covered parts of the Mackenzie District east of the Mackenzie River Delta where precipitation is low (8 to 10 in. per year). In these flat regions many lakes were formed by melt water accumulating from the active zone in small shallow and isolated flow systems. The only discharge from some lakes is by evaporation in summer. Thus, by preventing infiltration, permafrost has created a hydrologic paradox as there are myriads of small lakes in a semiarid region.

EVIDENCES OF GROUND WATER FLOW

Springs and drilled wells provide evidence for ground water flow. Three other forms of evidence are apparent in ground water discharge areas. These are base flow of rivers, variations in the chemical composition of river waters, and vegetation peculiar to an area as a consequence of ground water discharge. Resources do provide evidence of winter flow which can, in part, be attributed to ground water discharge.

Table I summarizes basin discharge data on two Yukon rivers [3] and Table II records recent winter flow records on two other rivers in the northern Yukon Territory.

These winter discharge measurements provide indications of ground water and bank storage contribution to rivers in regions of discontinuous permafrost.

Table I. Summary of river discharge data

River	Area (sq mi)	Mean Month ^a	Minimum Month ^a	Minimum ^a (per sq mi)
Stewart	12 600	14 500	950	0.07
Pelly	19 700	12 800	1 400	0.07

^a Discharge measured in cubic feet per second

Table II. Winter flow measurements

River	Discharge ^a	Date
Porcupine	644	11 Feb 1962
(at Old Crow)	701	10 Apr 1962
Peel	833	10 Feb 1962
(above Canyon Creek)	731	9 Apr 1962
	858	7 Feb 1963

^a Cubic feet per second

Variations in the Chemical Composition of River Waters

The dissolved mineral content of a river that is constantly receiving ground water varies with the total flow. This is because of the diluting effect of surface runoff waters which have a low dissolved mineral content. Dissolved mineral content and discharge are therefore inversely related. Hem [4] reports a close relation between specific conductance and total dissolved solids in water samples; consequently, specific conductance is a good indicator of total dissolved mineral content. The measurement of conductance and discharge provides a method of assessing the relation between ground water flow and surface runoff in valleys where ground water is effluent. An example of this is the Liard River which rises in an area of discontinuous permafrost in the southern Yukon Territory. A plot of discharge (y) against specific conductance (x) is shown on logarithmic scale (Fig. 1). The data are obtained from analyses made by Thomas [5]. Samples were obtained at the Liard River crossing on the Alaska Highway. The equation of discharge and conductance is found by inspection to be

$$\log y = 11.4 - 3 \log x$$

where the general form of the equation is

$$\log y = K - a \log x$$

This graph provides a method of making a preliminary over-all estimate of ground water contribution to a river. Thus, if ground waters in the region have a conductance of 500 micromhos at discharge to the river, the contribution would be 2000 cu ft per sec (Fig. 1).

Data on discharge and conductance in other rivers farther north are not yet available.

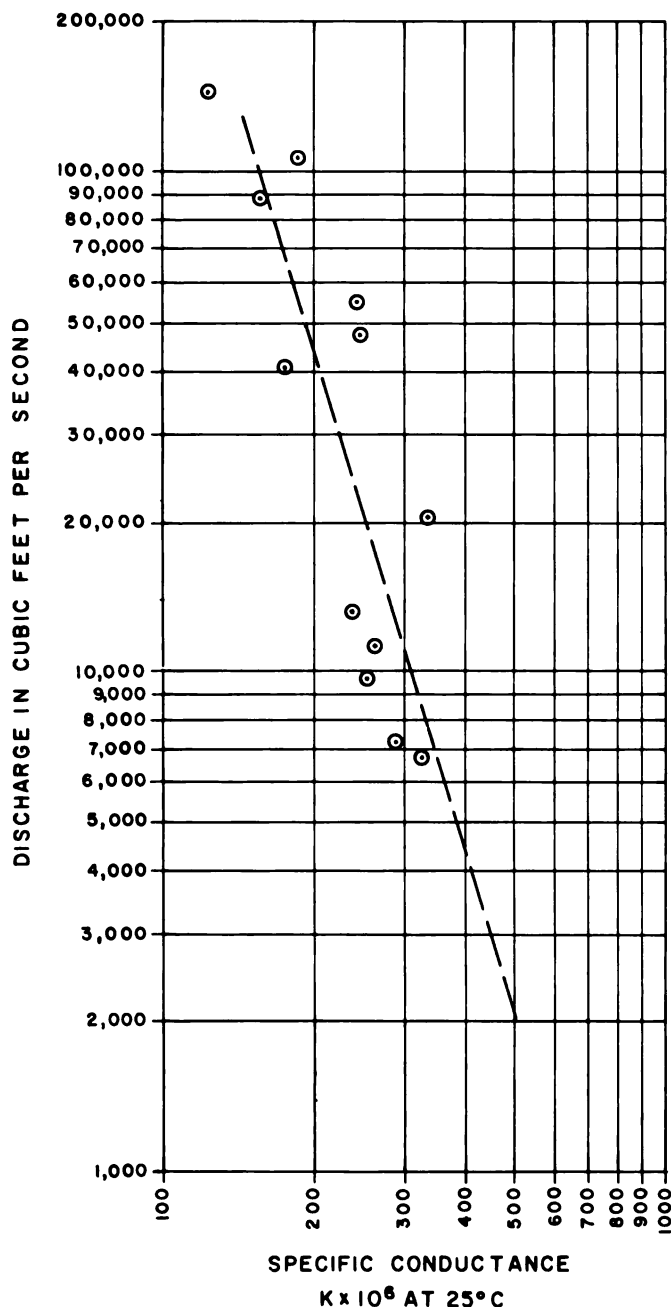

Fig. 1. Variations in discharge and specific conductance of the Liard River (1952-53) at Liard River Crossing, B. C.

Vegetation in Areas of Ground Water Discharge

Ground water acquires a high dissolved mineral content when passing through a long flow system or when flowing through sulphate rocks.

Discharge areas of highly mineralized ground water are marked by a white encrustation of salts, locally referred to as alkali or salt flats. This white encrustation is formed by evaporation of mineralized waters which have the same chemical composition as ground waters. An example of this can be

seen in the region around Lac la Martre (Mackenzie District) below Cartridge Mountains and the Horn Plateau.

A characteristic flora grows in these regions of upward ground water leakage where the highly mineralized waters and soil prevent the growth of the normal regional vegetation. Meyboom [6] described the flora and ground water flow system associated with waters of varying salinity in Saskatchewan. Similar plant associations may be found in the salt plains in the Wood Buffalo Park north of the sixtieth latitude and also in small localities in the Takhini valley of the Yukon. Raup [7] found *Salicornia europaea*, *Puccinellia Nuttalliana*, *Sueda depressa*, *Plantago oliganthos*, and *Spergularia Salina* growing around the edge of barren salt ground and salt springs. He described in detail these associations in saline meadows. In the Takhini Valley near Champagne, Day [8] found saline soils and reported the presence of *Salicornia* species and salt tolerant grasses.

Floral associations with mineralized water provide evidence of ground water discharge by upward leakage, and small springs or seepages are found where they are present. Studies by Sjörs [9] of bog and fenland vegetation may provide information on small shallow ground water flow systems when similar work in permafrost is reported.

CONCLUSION

In permafrost regions where population is small there is inevitably a lack of subsurface data to delineate the extent of permafrost.

Therefore, other field methods of assessing ground water flow have to be adopted. Information on ground water in the Canadian northwest was obtained at many settlements and from oil borings, mine shafts, and field observations of springs. Brandon [10] has used the methods outlined above to obtain more information on the extent of ground water flow where permafrost is present.

REFERENCES

[1] M. K. Hubbert. "Entrapment of Petroleum Under Hydrodynamic Conditions," *Bull. Am. Assn. Petrol. Geol.*, Vol. 37, No. 8, 1953, pp. 1954-2027.
 [2] M. Muskat. *The Flow of Homogeneous Fluids Through Porous Media*, McGraw-Hill Book Co., New York, 1937, reprinted by J. W. Edwards Publisher Inc., Ann Arbor, Mich., 1946.
 [3] Water Resources Branch, Canada Department of Northern Affairs and National Resources: papers 114 (1950-52), 118 (1952-54), 122 (1954-56), in Pacific drainage and Yukon Territory.
 [4] John D. Hem. "Study and Interpretation of the Chemical Characteristics of Natural Water," U.S. Geol. Surv., *Water Supply Paper 1473*, 1959.
 [5] J. F. J. Thomas. "Mackenzie River and Yukon River Drainage Basins in Canada," 1952-53; Canada, Mines Branch, *Water Survey Rept. No. 8*, 1957.
 [6] P. Meyboom. Patterns of Ground-Water Flow in the Prairie Profile, " *Proc. 3rd Canadian Hydrol. Symp.*, Natl. Res. Council, 1962.
 [7] H. M. Raup. "Botanical Investigations in Wood Buffalo Park," *Natl. Mus. Canada*, Bull. 74, 1935, p. 174.
 [8] J. H. Day. *Reconnaissance Soil Survey of the Takhini and Dezadeash Valleys*, Research Branch, Canada Dept. Agric., 1962, p. 78.
 [9] Hugo Sjörs. "Bogs and Fens in the Hudson Bay Lowlands," *Arctic*, Vol. 12, No. 1, 1959, pp. 3-19.
 [10] L. V. Brandon. "Ground-Water Hydrology and Water Supply in the District of Mackenzie, Yukon Territory, and Adjoining Parts of British Columbia," *Geol. Surv. Can. Bull.*

PROBLEMS OF ZONAL RELATIONSHIPS IN THE DEVELOPMENT OF PERMAFROST

I. J. BARANOV, V. A. Obruchev Permafrost Research Institute, Moscow

Geocryological zoning is a particular reflection of the over-all law of zonation in natural phenomena and formations, which depend in their development upon external (outer space) and internal (over-all planetary) causes and conditions.

Zonal phenomena are related to the earth's surface and mantle which is influenced by internal causes and conditions. This results in a matter-energy interaction of the earth's mantle: Temperature fields become parts of a single field of the earth's mantle affected by external, planetary causes and conditions.

Cryogenic phenomena develop from those peculiarities of planetary heat exchange that promote thermophysical ice formation in the earth's cryosphere, i.e., the zone where snow, ice and frozen ground are formed.

Geocryologic zoning defines peculiar features within the land boundaries of the cryosphere.

DEVELOPMENT AND ZONING OF CRYOGENIC PHENOMENA

Freezing of soils and rocks, their cementation by ice, and their physicochemical and mechanical changes are determined by two prerequisites: (1) The presence of water, (2) the possibility of its solidification into ice related to a fall in the temperature of the rocks.

The following factors determine the zoning of cryogenic phenomena.

The earth's spherical shape predetermines meridional variations in supply and consumption of solar heat across its surface. The first major factor, external insolation, shapes the temperature field of the earth's mantle and determines the development of the meridional type of planetary heat exchange in the atmosphere. The second major internal component factor shaping the temperature field of the earth's mantle (primarily the lithosphere and the hydrosphere) is the earth's internal terrestrial heat which becomes apparent through conduction and convection heat transfer. External insolation helps redistribute heat across the earth's surface but does not exclude the influence of nonuniform insolation, i.e., major differences between the equatorial belt and the polar zones. The rotation of the earth around its axis creates relative latitudinal homogeneity in insolation, which, with variations, results in latitudinal thermodynamic belts.

Influenced by planetary peculiarities, two types of cryogenic phenomena form with daily and perennial development cycles.

The heterogeneous composition of the earth's mantle determines the second type of planetary heat exchange, the intergeospheric; this complicates the influence of the meridional factor, and interferes with the effects of the earth's rotation.

The earth's elliptical movement on its axis results in another important complication and causes its seasonal dynamics. This results in seasonal cryogenic phenomena, a third type.

Vibrations of the earth's axis (precessions) probably result in still another long-period change in the temperature of the lithosphere, which may be influenced by the above causes and conditions. Thus, three types of cryogenic phenomena may develop within the thermodynamic system formed by the earth and its outer medium—the daily, seasonal, and perennial phenomena. The daily cycle type has a radiative and advective nature, subject to weather conditions and the earth's rotation; the seasonal phenomena are of a radiative nature subject to the elliptical movement of the earth with an inclined axis. Here the freezing and thawing cycle ranges from a few days to a year; perennial phenomena are of a radiative nature subject to the earth's spherical shape. Their cycle of development varies within broad limits—from two years to dozens and even hundreds of thousands of years.

Interyearlies which stand intermediate between the seasonal types and unstable perennial types form a cryogenic transition.

Effects of these causes and conditions permit development of all cryogenic formations within land boundaries. Distribution depends on certain global conditions. These conditions are extremely complex and their effects are nonuniform.

AREAL MORPHOLOGICAL STRUCTURE OF THE CRYOLITHOSPHERE

The earth's cryolithosphere is divided into Northern and Southern polar regions. Due to two thermoenergetic limits, seasonal and perennial, each is further divided into exterior zones of seasonally frozen ground and interior zones of permafrost. Zones and regions are interconnected by cryogenic phenomena, preserve unstable equilibrium, and have spatial regionally-heterogeneous boundaries determined by differences of heat exchange, material composition and morphology of the earth's surface.

The Northern region is considerably larger than the Southern, as the largest continents are subpolar in the Northern Hemisphere; its peculiarities reveal the formation and distribution of all cryogenic formations. The Northern and Southern Polar regions of cryogenic phenomena differ in that the central (polar) position in the North is occupied by the Arctic Ocean and its adjoining seas where seasonal and old ice covers are developed. Its periphery embraces continents that increase over-all cooling and are distinguished by daily, seasonal and perennial freezing of soil and rocks, and in places, formation of ice covers. The center of the Southern region is occupied by a continent, while its periphery extends mainly across oceans (where seasonal and old ice form) and extends across small sections of continents, where cryogenic phenomena in soils and rocks develop only within limited areas, due to their orography and location. Permafrost is spread across the Antarctic Continent and its islands; it is found in the Andes because of high absolute altitudes.

Let us consider the peculiarities of cryogenic phenomena within the Polar regions. As the northern region is of greater interest and its geocryological zoning is clearly defined, we shall consider its latitudinal structure. Complexity resulting from orographic interconnection of latitudinal and altitudinal zonal distribution is characterized. From equator to Poles, the following morphogenetic geocryological elements can be traced:

1. The zone of irregular radiative and advective cooling of the soil surface (subtropical deserts);
2. The subzone of sporadic seasonal soil freezing (with sections of dry frozen soils), or the first transition geocryological subzone (northern part of the subtropical zone);
3. The zone of regular seasonal freezing of the soil with islands of frozen and nonfrozen soils (Temperate Zone);
4. The subzone of regular seasonal freezing of the soil, sporadic and local transition (inter-yearly) and perennial freezing of rocks, or the second transition geocryological subzone (Temperate Zone);
5. The area of perennial freezing of rocks with islands of seasonally-frozen soils and inter-yearlies within the boundaries of perennial talik (the Temperate, sub-Arctic and Arctic Zones).

This skeletal structure reflects only the sequence of thermodynamic changes to the north (Northern Hemisphere) and reflects the spatial interconnection of cryogenic phenomena.

The Euro-Asiatic configuration in the northern region of cryogenic phenomena depends on a number of causes and conditions, among which are the following: Geographical locations, areas and orographies of the continents, conditions

of thermodynamic interaction within the "sea-land-sea" system, climate-influencing role of the continents, etc. Each condition acts in the formation and distribution of seasonally-frozen and perennially-frozen rocks. Thus, in the boundaries of the USSR, permafrost widens to the east, reaching the maximum width in the continent's interior, and becoming somewhat narrower where it adjoins the Pacific Ocean. This shape is determined by (1) the continental influence of its own thermal processes, restricting advectations of air (both cold and warm) coming from the sea and affecting the thermal regime of the adjoining seas; and (2) the orography of Southern Siberia and Central Asia, which influences the width and leads to the formation of the first outer intercontinental mountain subregion of permafrost adjoining the basic region of its distribution. This subregion includes the Altai and Saya Mountain systems within the USSR and the mountain systems of Mongolia and Northeast China. The second outer south-continental mountain subregion of permafrost embraces the highlands of Middle, Central, and Southern Asia.

All mountain regions are characterized by specific conditions of formation and distribution of permafrost; specific zonal and regional conditions also characterize each of them.

In the permafrost area within the USSR several portions may be distinguished, west to east.

In the first, the European North of the USSR, the permafrost occupies a narrow strip widening eastward as the degree of continentality increases. Within these limits permafrost is influenced chiefly by high latitudes and Arctic conditions. Permafrost does not leave the tundra of forest tundra.

The second portion is Western Siberia. Here permafrost widens eastward, oriented latitudinally. Frozen masses are traced farther south than in the first sector because of greater continentality and the arctic's cooling effect. Permafrost is spread across the arctic and southern tundras, forest tundras, and the subzone of northern taiga.

The third portion is Central Siberia. Permafrost extends predominantly across the major part and is adjoined by the first central-continental mountain subregion of its occurrence. Here permafrost extends much farther south than in Western Siberia. In the north, high latitudes combined with powerful continental influences regulate this progression. The influence of the Atlantic Ocean in the Northwestern Arctic zone gradually diminishes. The area includes the whole taiga zone and the forest-steppe subzone. Higher surface altitudes and topography influence the formation of frozen masses here.

The fourth portion includes the lowland part of Yakutia and the mountainous trans-Baikal area. The formation of frozen masses, from the arctic tundra up to the semidesert subzone, is greatly affected by continentality and high altitudes of the southern terrain. The Arctic zone especially influences the northern half of this area.

The fifth portion includes the highlands of East and North-east Siberia and the southern Far East. Here mountain and continental influences restrict the effects of the Arctic regions and the Pacific Ocean. Due to the dominance of the continent and of mountainous relief, a significant altitudinal differentiation is traced across this entire area and the mountainous trans-Baikal and South Siberian regions as well. The Pacific Ocean influences the narrow coastal section which becomes wider in the southern Far East. This results in permafrost within natural zones from the arctic tundra to the southern taiga inclusive.

GEOCRYOLOGICAL ZONES AND BELTS

Latitudinal geocryological zoning, i.e., latitudinal variations of permafrost, is traced in strict succession despite numerous differences in regional historic natural conditions.

Latitudinal geocryological zoning is best shown in lowland plains affected by oceanic influences. Alpine countries located beyond permafrost zones, most typically express altitude belt division. The interconnection of altitudinal geocryological belt division and latitudinal geocryological zoning is best described in the Alpine sections of the permafrost zone.

A geocryological zone and an altitudinal belt are a part of space within which a complex of cryogenic formations develop; rate of development corresponds primarily to thermophysical natural conditions from within.

The most important features of the permafrost subdivision into latitudinal geocryological zones are, (1) distribution of frozen rock masses (mode of occurrence, discontinuities, thickness), as well as their temperatures, and (2) formation peculiarities of frozen masses, their cryogenic structure, and complexes of accompanying cryogenic formations. Each is characterized by inherent features which enable us to delineate the permafrost to reveal its internal integrity and heterogeneity resulting from the above mentioned causes and conditions as well as from the regional peculiarities of relief, geological history, composition, rock lithogeny, hydrogeological conditions, etc.

The altitude geocryological belt division expresses itself in consequent changes of geocryological peculiarities resulting from the region's geographical position and absolute altitudes. The division connected with the mountainous relief is determined by vertical changes of heat exchange between rocks and an outer medium whose thermal regime depends somewhat on the underlying surface and its proximity to free atmosphere.

The altitudinal belt division is expressed regionally in highlands; in boundaries of low plateaus, it appears in different thermal regimes of interfluves and valleys.

This belt depends not only upon the altitude and location of the mountain system or highland, but also on some peculiarities, such as topography, altitude variations, orientation of the mountain system, its area, degree of isolation, etc.

INTERCONNECTION BETWEEN LATITUDINAL ZONES AND ALTITUDINAL BELTS

Latitudinal geocryological zonation and altitudinal belt division reflect the natural spatial (areal and altitudinal) relation between the development of permafrost masses and accompanying cryogenic formations, and the thermodynamic interaction of upper layers of the lithosphere with the outer medium.

While latitudinal zoning reflects the eccentricities of thermal interaction of the lithosphere with the environment latitudinally, the altitudinal belt division reflects the dependence on the altitude, latitude, and longitude of the area.

Latitudinal zonation is best defined within plains affected by warm oceans (the western section of permafrost in the USSR). Within its limits river valleys are warmer than interfluves. This phenomenon reflects altitudinal differentiation in heat exchange influencing formation of frozen masses.

Geocryological zones widen with a transition to higher orographic benches, noticeably increasing with the inclemency of climatic continentality, while their boundaries become less definite and their zonal interpenetration wider. Then valley floors are cooler than flat interfluves, i.e., in contrast to regions under oceanic influences. In southern and western regions of the permafrost center, the same conditions favor formation of frozen rock masses within valley floors and northern slopes. In individual highland regions differentiated variations between valleys and watersheds become a well defined division of the altitudinal geocryological belt.

This region contains two types of frozen rock formation: Valley and mountain; the latter is regionally restricted, while the former is more characteristic.

Valley floors of large rivers exist in somewhat different microclimatic, hydrogeologic and hydrologic regimes here. Hence, they are exceptions to the regularity of the valleys of medium and small rivers. Significant variations affecting permafrost formation are found in valleys of various regions because of heterogeneous continental climatic effects. Where continentality and climatic severity are relatively limited, overcooling of valley floors is less prominent than in central, southern, and eastern regions of this area.

Within the tundra and forest tundra, (i.e., influenced by Arctic seas) snow-clad valley floors cool more slowly than interfluves where the winds blow freely, because of less prominent continentality. The snow cover reveals its second nature here by protecting the rocks from heat loss in the valleys; it delays their warming during the first half of the short summer. This levels the rocks' thermal regime in watersheds and valleys but does not exclude significant variations. Within high plateaus the altitudinal microclimatic belt differentiation is reflected in comparatively small variations in the altitudes of valley floors and the surface of interfluves, and appears as an altitudinal belt only in highlands.

This division exemplifies mid-high and, especially, alpine regions that occupy a greater part of the permafrost zone in Siberia. It appears differentially, depending on altitude and geographical position of the highlands.

The altitudinal geocryological belt in highlands of the permafrost zone differs considerably from its environment. Variations occur because the belt is formed on the basis of the latitudinal zoning typical for the specific highland. For example, the altitudinal geocryological belt division of southern Siberia is formed against the background of seasonal soil freezing (Altai Mountains, Western Sayan), the zone of deep seasonal soil freezing, and islands of permafrost (East Sayan, Khamar-Daban); in the trans-Baikal area and in the Southern Far East it contrasts with the zone of insular and continuous distribution of permafrost in the Sikhote-Alin Range and in Kamchatka, with seasonally freezing soils and permafrost islands. Within the latter (intercontinental and northern) parts of the permafrost regions an altitude belt forms on a cryological zone characterized by complete coverage of frozen layers in various degrees of severity.

In a severe continental climate where a high barometric pressure stabilizes in winter, a definite air temperature inversion at a variable height is observed. As a rule temperature stratification of the air mass follows this pattern: The lower topography (plains and valleys) is filled with cooled heavy air masses, and watersheds and slopes up to the height of the average perennial inversion ceiling form the boundary. Mountain ridges, massifs, and isolated peaks higher than the inversion ceiling are influenced by the relatively free atmosphere, i.e., under a weak influence from the underlying surface.

Within the lower layer, pleasantly cool ground conditions exist in plains, valleys, and on the lower slopes; in the inversion zone an almost linear relationship exists between the gradual drop in temperature and increasing height.

Under oceanic influences the air temperature drops similarly with height. Moving north with greater local height and severe climate, the influence of the inversion zone recedes and in some places changes to a high-altitude belt; that is, the altitude belt begins to widen. In highlands of medium elevation there is a two-level cooling system: A lower layer, a dividing inversion layer, and an upper cooling layer depend-

ing on the thermal regime in the almost-free atmosphere. Thus, broad geocryological zones are linked with altitude belts (non-uniformly at some places in the permafrost region) and lead to different effects which significantly change the geocryological situation and interrupt general zonality. The greatest effect of the altitude belts on general zonality is seen in the eastern part of the permafrost region, in areas of medium elevation and in highlands; here the broad cryological background erases the zonality so greatly that its features and peculiarities appear only where plains and valleys are wide enough. Relatively small dissection of topography is unimportant.

Conditions of permafrost development can be divided into two subregions: Lowlands characterized by broad geocryological zones and smaller height; and highlands, expressed by altitude geocryological belts which mask the broad zones.

EXTRAZONALITY OF PERMAFROST

Permafrost allies with natural zones by the type of extrazonal development; it belongs to not one zone but many. Natural zones include the breadth and complexity of the effects of natural history which differ because of vegetation, top soils, ground water, and physical geology that include several cryological zones, etc. Cryogenous and other zonal effects and development have a general external origin, influencing the distribution of heat and moisture; hence, each is zonal.

Since permafrost distribution requires wider thermodynamic conditions than is needed for things, e.g., vegetation, wholly or partly restricted to the warm season, permafrost is distributed territorially in many natural zones.

Permafrost zonality within the region of its development is partly independent of natural zonality, as its characteristics depend somewhat on the interaction of natural elements.

Extrazonality is indigenous to both natural zones (in particular arctic desert, tundra and forest-tundra) and zones and subzones where it develops in favorable conditions (taiga, forest steppe, and semi-desert steppe). Definite conditions are (1) continentality in conjunction with severe climate and (2) high surface elevations. Specifically, these determine the areal extent of the permafrost and its southern limits. In this case zonal and regional conditions act at the same time to determine permafrost conditions.

Thus, a permafrost zonality is linked not only to the gradual lowering of strata temperature toward the poles which is the cause of its development, but also to favorable regional conditions (mountainous areas outside subpolar regions) or persistence (by development of continentality and its accompanying degree of severity, increase in elevation of the locality). Continentality highly influences heat and water transfer but is weakly expressed in the European part of the Soviet Union, somewhat more strongly in Western Siberia, and more so east of Yenesei where the continental influence is stronger than that of the sea, advection of moisture and masses of hot air.

FEATURES OF THE DEVELOPMENT OF FROZEN GEOMORPHOLOGY IN NORTHERN EURASIA

A. I. POPOV, M. V. Lomonosov State University, Moscow
S. P. KACHURIN, V. A. Obruchev Permafrost Research Institute
N. A. GRAVE, Siberian Branch of the Academy of Sciences, USSR

Recently, special attention has been given to those modern phenomena of frost action which make it possible to observe the course of frost action and its role in the development of typical relief forms.

Careful study of major factors acting in the frost-action lithogenesis and relief makes it possible to work out a system of genetic types of frost-action topography. The most important morphogenetic groups are:

1. Macrostructural, predetermined by frost fissures.
2. Microstructural, predetermined by desiccation cracks and subsequent differential freezing and thawing within the cracks and between them.
3. Astructural, free from cracking.

The first morphogenetic group includes large polygons (tens and hundreds of meters across) with soil and ice-wedges and peculiar eroded polygons of mountain terrace type; the second group is medallion-like microrelief including stone nets and like forms of microrelief (ranging from 10 to 20 cm to 1 to 2 m across) which correspond in cross section to so called cryoturbations; the third group includes frost mounds, solifluction, and similar forms uncontrolled by cracking.

Macrostructural formations result from action of a cracking process, that is, cracking of frozen ground of active layer and permafrost simultaneously, or of only the deep frozen winter layer not underlain by permafrost.

Traces of such cracking formed within frozen ground are preserved by summer thawing. These traces are found along the cross section of the active zone and in the surface relief in the form of cracks which are formed afterward. In permafrost, the cracks filled with ice or ground are even more evident because of the preserving action of permafrost.

Microstructural formations result from processes of cracking that interact and successively replace each other in the thawed ground when it desiccates during preliminary autumn freezing and subsequent differential seasonal freezing-thawing processes. Thus, macrostructural formations are predetermined by the process occurring mainly within the frozen ground (both active zone and permafrost), whereas microstructural formations are predetermined by processes occurring mainly within thawed ground in combination with the action of seasonal freezing (that is, within the active zone only). In cases of complete absence of deep seated permafrost that cannot be acted upon by frost-cracking, macrostructural formations can be characteristic of the active zone only. Under these circumstances, macrostructural forms and fissures (and soil wedges formed within them) usually penetrate deeper into the rocks than do the microstructural forms. Thus, both forms of major morphogenetic groups (macro- and microstructural) often coexist within the active zone, even in complete absence of deep seated permafrost, and are generally located at different levels.

Thus, the most important factor in the formation of frost-action topography in large areas is frost fissures which cause large polygonal forms to build up.

These processes acting only in the active zone play a very important role in the formation of structural microrelief. As stated, both processes often exist within the same thickness of ground and develop simultaneously.

Development of frost-action topography depends essentially on the principal trend of exogenetic development of polar, alpine, and periglacial areas; that is, it depends on whether the area undergoes accumulation of sediments, or erosion, or whether it has been free from the above major processes for a long period of time and is relatively stable.

The principal trend of exogenetic development of the area

is greatly predetermined by tectonic factors. It is a well known fact that climatic conditions alone, without any change in the trend of tectonic development, can cause or disrupt the deposition of sediments, intensify or nearly stop intensive erosion, etc.

Continuous observation shows that the greatest variations in frost-action morphology are predetermined by the character of the area (large or small) where the frost action proceeds. These are areas of (1) stable deposition and removal, (2) predominant accumulation, and (3) predominant erosion.

If frost-action forms develop when sediment accumulates, both phenomena occur syngenetically. If there is drifting of material or erosion, the development of frost-action forms is epigenetic with respect to the substratum.

FORMS OF FROST-ACTION TOPOGRAPHY IN RELATIVELY STABLE SURFACES

On weakly dissected plateaus, plains, flood-plain terraces, and ancient coastal plains with relatively stable surfaces where there is no appreciable accumulation or erosion of material, frost-action forms develop in the uppermost rock formations epigenetically.

The macrostructural forms of frost-action relief prevalent here are connected with frost cracking of frozen areas.

Morphological features of such relief forms are multifarious, and their variety depends on the facial composition of deposits, their moisture content, and the presence or absence of permafrost.

In permafrost, a network of epigenetic frost fissures develops within which, especially under a continental climate, soil but not ice-wedges develop on relatively stable surfaces. Depending on climate and lithologic conditions, soil wedges can develop within the active layer in the uppermost layers of permafrost. In places, the wedges are composed entirely of ice.

If soil wedges develop within the limits of a relatively stable surface, a system of salient polygonal blocks fringed with narrow depressions, which contain the soil wedges, results. These polygonal blocks reach a width of tens of meters, whereas the width of the depressed margins extends to several meters. This pattern develops in various soils such as loams, sands, and even gravels.

In conditions of sufficient moisture content, the edges of the polygonal blocks are frost weathered. Depressions between them become wider; thus, the topography of polygonal blocks gradually becomes the topography of reduced blocks. Characteristic of this are rounded mounds fringed with wide, flat depressions often wider than the mounds.

The pattern of polygonal and reduced blocks is most common in the western sector of polar Eurasia. Relics of this pattern are also found in the periglacial zone of the ancient glaciation of Europe.

In areas free from permafrost, or in areas where it is deep seated, deep freezing of soils and full thawing in summer in frost fissures form soil wedges only. The pattern formed under these circumstances is principally the same as above. However, because of draining action of surface water (not obstructed by the screen of permafrost), the topography is made more complicated by undermining. The interblock depressions become especially deep where the wedges intersect. The block, because of the action of water erosion on the edges, becomes more gently sloping. As a result, the topography of polygonal blocks gradually turns into the topography of closed depressions. This pattern is most common to

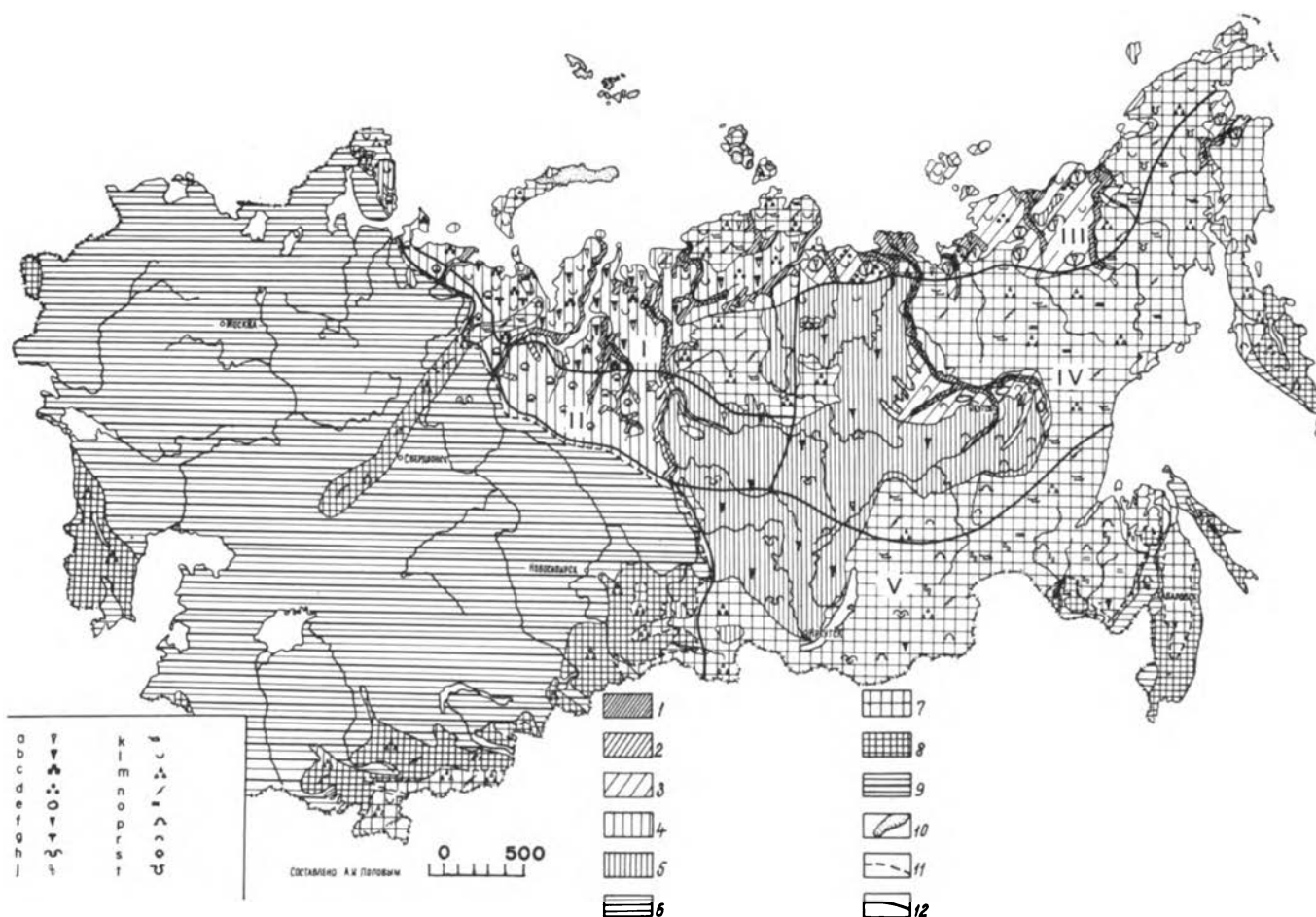

the Trans-Baikal region and to southeastern Siberia.

Specific polygonal topography develops on frozen peat bogs (in desiccating lakes and bogs with permafrost substrata). During frost cracking, ice-wedges form in the frost fissures, and epigenetic wedges form on stable surfaces. When the ice-wedges begin to thaw a topography of flat mound-like peat bogs forms. This pattern is especially widespread in the tundra zone of West Siberia, in the north European portion of the USSR, in Chukotka, and in other regions.

Frost-action topography built by cracking rarely develops on stable surfaces composed of ancient polygonal wedge ice. These areas are inert. However, on dried-out lake bottoms in areas of thermokarst, secondary polygonal topography with epigenetic wedges of ice intensively develops. Usually, these concave polygons are relative small—at times only 10 to 20 m wide.

Most completely developed and widespread on stable surfaces are microstructural forms, such as stone polygons, stone rings, spot medallions, etc. These forms originate in the development of desiccation cracks; however, the formation of large rock polygons is probably caused by frost fissures. These forms usually develop within ground composed of large rock waste mixed with fine soil. The processes of sorting the material caused by periodic freezing and thawing determine the characteristic features in the formation of those patterns. All these forms of topography are most evident in the mountainous and arctic tundra, on the surfaces of terraces and plateaus composed of dense rocks.

A structural forms of frost-action topography, (those not predetermined by frost cracking, mostly represented by frost-heaving mounds formed in relatively stable areas), often develop within desiccating and freezing lake beds and flood plains. As disintegrated forms, they are found on the more

ancient terraces of river valleys.

Frost-heaving mounds may be seasonal or perennial. They are formed by hydrostatic and hydrodynamic pressures which result within water saturated alluvial and lacustrine deposits when they freeze.

Large frost mounds are widespread in permafrost areas. Mounds containing ice cores are called hydrolaccoliths, bulgunyakh (Yakut), or pingos (Eskimo).

Extremely large pingos, reaching 40 m and more in height, exist in many areas of North Asia, central Yakutia, and Chukotka.

FROST-ACTION TOPOGRAPHY IN AREAS OF DEPOSITION

In arctic and subarctic regions, accumulation of material on the surface of certain areas (periodically flooded and dried-out flood plains, deltas, juvenile lowlands, new-forming coastal valleys, shallows, shallow lakes, and bogs) is syngenetic with frost action morphogenesis.

During frost cracking of permafrost and formation of ice and soil wedges, two main types of polygonal patterns develop on the surface.

The first type includes well defined ridged polygons of rectangular and polygonal form (when viewed in plan), concave along the diameter. This testifies to the growth of ice-wedges. These polygons, sometimes many meters wide, develop on the surface of damp, fine grained ground underlain with shallow-seated permafrost, in the regions of severe climate with little snowfall. This topography covers vast areas in arctic and subarctic lowlands.

To the second type belong the large polygonal, slightly hilly patterns formed of pebbly-sand alluvium and sand deposits in river valleys. This topography is widespread in the

Fig. 1. Schematic map of the development of frost action geomorphology in the USSR (by A. I. Popov

Key to Fig. 1

- a Polygons with ice-wedges
- b Polygons with ice-wedges complicated by thermokarst
- c Flat mound peat bogs
- d "Baidzharakhi" - (hillocks around thermokarst lakes, vestigial polygons)
- e "Alasses" - (depressions in permafrost, often associated with baidzharakhi)
- f Polygons with soil wedges
- g Vestigial polygons with soil wedges, blocks with cover of clayey silt
- h Hummocks and sinkholes
- j "Grave mounds"
- k Mountain terraces
- l Spot medallions (sorted fine centered rings covered with peat)
- m Stone nets, circles, and such forms with sorting
- n Solifluction stripes on slopes
- o Stratified soil icings ("naledi")
- p Seasonal frost mounds
- r Perennial frost mounds
- s Frost mounds resulting from the migration of water to the freezing front
- t Combined forms

Regions of Accumulating Sediments

- 1 With syngenetic freezing: Formation of permafrost and ice-produced fissuring
- 2 With unfrozen ground: Only seasonal freezing of subsoil

Regions of Comparatively Stabilized Deposition and Removal

- 3 With past and syngenetic freezing—development of permafrost, and ice-produced fissuring
- 4 With epigenetic freezing of the rocks and development of permafrost—a variable region
- 5 With epigenetic freezing of the rocks and development of permafrost—a growing region
- 6 With unfrozen ground, only seasonal freezing of subsoil

Eroded Regions

- 7 With epigenetic freezing of the rocks and development of permafrost
- 8 With unfrozen soil, only seasonal freezing of subsoil
- 9 Region, within which topographic development by frost action is absent
- 10 Glaciers
- 11 Present southern limit of permafrost
- 12 Provincial boundaries (I, II, III, IV, and V)

Arctic and in East Siberia.

In areas where there is either deep seated or no underlying permafrost, the cracks form soil, but not ice, wedges. In areas where syngenetic alluvial and fluvio-glacial deposits accumulate continually, microstructural forms of relief develop weakly.

A structural forms of topography, mainly frost mounds, develop in such areas only with favorable local hydro-geologic conditions, although there is no evidence of the growth of pingos in areas of sediment accumulation. In arctic regions where the processes of crack-polygonal pattern development on the coastal valleys, flood plains and deltas are accompanied by thermokarst processes, pingos develop on the desiccating and frozen surfaces of the bottoms of lake basins.

FROST-ACTION TOPOGRAPHY IN AREAS OF EROSION

In areas of predominant erosion, frost action occurs mainly on slopes in upland regions. This not only accompanies erosion but also is active in promoting its development.

Freezing, thawing, and frost cracking of rocks promote fragmentation and flow of material from the top to the foot of the slope where the rocks accumulate. The development of "ice stems" also helps in disintegration of slope material. During growth of ice stems, the ice raises small fragments and thus facilitates creeping of soil down the slope.

Frost cracking is also widespread in upland regions, especially on gentle slopes, but it does not develop macroforms characteristic of areas of accumulated material with relatively stable surfaces. It only predetermines the origin of different accumulation forms of relief.

All these processes bring about the formation of the so called upland terrace-like forms of topography, which vary in

their genesis, shape, and structure.

Individual groups of small terraces develop on the slopes of mountains; they are crescent- or lobe-like in shape (in plan) with well defined steps and platforms, usually with flat, sloping surfaces bearing traces of solifluction.

There are various upland terrace-like forms of topography. They include low-accumulation solifluctional terraces (from 0.5 to 10 sq m) with steps ranging from some centimeters to 1.2 m in height. They have the shape of tongues or lobes in plan. These small terraces can develop in areas beyond permafrost. Upland terraces possess well defined steps composed of coarse rocky materials and larger benches; solifluctional terraces are composed of mixed material brought down from upper portions of the slopes. Microstructural forms are wide-spread on the slopes, where they are somewhat elongated in shape compared with those occurring on stable and horizontal surfaces.

If a slope complicated with solifluctional terraces is subject to frost action fissuring, frost weathering begins along the walls of the fissures in the rocks. Then, along these widened lateral fissures, solifluctional transportation of material is intensified, and the stripes of sorted coarse rock waste appear as rocky stripes on the slopes. Thus, macrostructural forms of various upland terraces are gradually replaced by microstructural stripe forms on the slopes. The slope loses its terraced feature and levels out.

The same happens to spot medallions, stone rings, and polygons. They gradually stretch along the slope, acquiring to some extent an elongated shape, and very often transforming into stone stripes.

A structural forms of topography, such as frost mounds, develop mainly at the feet of the slopes near ground water discharge wells and on desiccating and frozen areas of river

valleys. Here they adjoin flood plains and lake basins in the mountains.

The description of this formation in relation to principal relief development (in the areas of accumulation, erosion and on stable surfaces) is to a certain extent schematic. However, the above scheme makes it possible to determine the direction of the processes in which these forms of frost action and topography develop and the characteristic features of their morphogenesis.

Of course, on the plains there may be inclined surfaces where erosion and corresponding frost-action topography develop. Similarly, in upland regions there may be relatively flat surfaces where deposits accumulate. In such localities the corresponding frost-action topography also develops.

Considerably more complicated are the features of another category of frost-action topography, which is widespread in permafrost regions. It develops both as a result of climate and purely local factors. Thermokarst does not fall into the accepted classification. Therefore, its development in both stable areas and areas of deposition and erosion are discussed separately.

The term thermokarst includes both the process of formation and the type of topography formed. It implies the slump and fall of ground because of thawing of underground ice. Thermokarst may result from climatic and geomorphological causes as well as from activity of man. The morphology of thermokarst depends upon the depth of the ice, its thickness, its form and character, the presence or absence of ground vegetation, and the composition of enclosing and overlying rocks.

Thermokarst is extremely well defined on plains and occurs mostly in areas with modern or ancient ice-wedges. The largest forms of thermokarst are lakes and depressions which remain after lakes become shallow. A typical lake is several kilometers in diameter and, depending on its development and its composition, may have a variety of plan forms ranging from lobe-like with a winding shoreline to circular or rectangular. The depth of the lakes usually does not exceed 5 or 10 m. Large thermokarst lakes and often their dried-out depressions, called "alasses" in East Siberia, are widespread in central Yakutia, and on the arctic coast of East Siberia. The oriented lakes of the Arctic continue to remain a mystery. Evidently they are associated with thermokarst of present raised-edge polygonal topography; however, the flow of water in these lakes caused by wind facilitated the formation of their coast lines and their gradual migration in one direction, which is inferred by American researchers. The above types of thermokarst are found in stable areas and in areas characteristic of material accumulation. In arctic regions of raised-edge polygonal topography, thermokarst is almost certain to develop, and both processes are connected by the general cycle of frost-action geomorphology on the surface of arctic lowlands.

Large forms of thermokarst occur also in areas of modern uplift. When the network of rivers cuts deeper into the ground and terraces emerge from their flood-plain stage, the raised-edge polygonal relief on them stops developing and becomes subject to thermokarst action. Further, the rivers, by undercutting their banks containing ice-wedges, intensify the erosion of these banks and facilitate thawing of enclosed ice.

A variety of forms of subsidence topography exists: funnels, caveins, small depressions, and "saucers." Their features characterize either the stage through which the thermokarst is passing or the thickness, depth of location, and character of underground ice distribution, which is in turn connected with its genesis. These forms occur wherever there is underground ice. They represent the thermokarst forms of topography proper, and are also forms of combined origin.

One form of combined origin is the peat mound that results from thermokarst and erosion on the surface of the polygons formed on frozen lake and bog deposits.

Forms of shore topography shaped by the action of erosion, abrasion, and thermokarst represent a special category. They include vertical ice precipices on the banks of rivers resulting from exposure of ice-wedges by river flow. Such precipices are evident mostly in the north of East Siberia, and on the

arctic coast in the lower reaches of the Jana, Indigirka, and Kolyma Rivers. On the sea coast of the Arctic around the Novosibirsk Islands and adjacent areas of the mainland, there are steep (about 80 m high) precipices composed of Pleistocene underground ice. Joined to the feet of these precipices are flat thermal terraces formed by the combined action of thermokarst and abrasion.

In some cases, underground passages, tunnels, and caves form within thick wedges of underground ice; however, these structures do not belong to the surface forms.

Thus, the most characteristic macrostructures occur in relatively stable areas, where the climate is severe. They almost always have important common features, such as weakly defined polygons and a peculiar mantle of weathering concomitant with development of polygonal systems. Identical features are common to macrostructures in areas formed by deposition action of sediments (raised-edge polygons with enclosed ice-wedges), and also to newly-formed macrostructural topography. Similar evidence is found in eroded areas (gradually eroded polygons of mountain terrace type). In this respect, microstructural formations are less significant.

Along with the general and principal likeness of macrostructural forms within the three areas under consideration (stable, with predominant accumulation of material, and erosion), there exist internal morphological differences which are caused by the specific climate in the region of their formation, but varying in time and space. In the discussion above, attention was often called to some peculiarity in the development of periglacial forms connected with a specific climate in the region at present and in ancient times.

For Holocene and modern formations of continental Eurasia which are practically indivisible, it becomes possible to establish (for stable areas and areas formed by deposition of material) only areal differences caused by climate, the history of their development, and the type of substratum. Forms of frost-action topography common to erosion areas have been studied less thoroughly; therefore, it is still impossible to establish such differences, but they are included in some provinces conditionally.

In spite of the present lack of knowledge on the problem of the development of frost-action topography, it is possible to establish within the Soviet Union the following general areas and their differences:

I. Western Arctic and sub-Arctic. This consists of the zone of tundra extending from the Kolski Peninsula to the Taimir Peninsula inclusive.

Reduced large polygons are characteristic of the relatively stable surfaces. These blocks are overlain with loam on each lithological substratum which represents a special type of weathering formed in a cold and humid climate, with prolonged spring thawing of snow (upper Pleistocene and Holocene).

Reduction of polygonal systems is determined by both physical and, to a greater extent, biochemical weathering, combined with the effect of a snow cover. Permafrost is a favorable factor.

Characteristic of areas of predominant accumulation of sediments (alluvial-flood plains, lake bogs) are large raised-edge polygons with weak syngenetic ice-wedges within muck and peat. Thawing of the ice-wedges leads to formation of so called flat mound peat bogs.

Cold but not severe continental climate, as well as a comparatively thick layer of snow, causes development of large polygons but only comparatively slow growth of ice-wedges. A relatively short period of accumulation syngenetic with frost-action morphogenesis (Holocene only) causes the small vertical thickness of the ice-wedges.

II. Southwestern sub-Arctic. This consists of a northern taiga zone extending from the Kolski peninsula to the central part of the Middle-Siberia Plateau.

Characteristic of the relatively stable surfaces are the frost-heaving of wet peat bogs (in upper Holocene following the stage of the so-called climatic optimum) and the formation of convex-mound frozen peat bogs.

In spite of the cold, the thick cover of loose snow prevents frost cracking and development of any other processes of frost

action beyond the patches of peat. In areas of accumulation of sediments (river valleys), no processes of morphogenesis caused by frost action are observed, mainly because of deep snow cover.

III. Eastern Arctic and sub-Arctic. This area consists of tundra zone extending from Anabar-Olenek Lowland to the Chukotka Peninsula.

The absence of any appreciable frost-action morphogenesis, except the intensive development of thermokarst, is characteristic of vast, relatively stable surfaces composed of syngenetic flood-plain alluvium and thick wedge ice (middle and upper Pleistocene). Large polygonal blocks are characteristic of the other substratum. Because some mother rocks decompose into their by-products, these blocks have a mantle of weathering. They are less evident here than in the west because of weaker chemical weathering, the result of the specific character of the climate.

Characteristic of areas of modern and Holocene accumulation of material (alluvial-flood plains, lake bogs) are raised-edge polygons. These polygons are large, but not as large as those in the west. They have syngenetic ice-wedges enclosed mainly within peat-muck sediments. Thawing of the ice-wedges results in the formation of so-called "baldzharakhi," and when the ice is very thick, of alasses.

A cold and severe continental climate, as well as thin and dense snow covers, help develop polygons of several generations, both large and small (60 to 10 m), and aid the vigorous growth of ice-wedges.

IV. Northeastern Siberia. This area consists of northern taiga and mountainous taiga zones extending from the central part of the Middle-Siberian Plateau and Lena-Vilui Lowland to the Kolima Mountain System, inclusive.

Characteristic of the vast, relatively stable surface of the Lena-Vilui Lowland, composed of syngenetic alluvium and thick wedge ice (middle and upper Pleistocene), are processes of thermokarst with formation of alasses. At places, large polygonal blocks are found with a weakly developed mantle of weathering as a result of the predominance of physical weathering over chemical; this predominance is attributable to little

snow cover and comparative dryness of the extremely severe continental climate.

Raised-edge polygons with wedge ice are developed in areas of modern and Holocene accumulation of material (mainly alluvial in river valleys). Such local development is due to the considerable depth of thawing which occurs in the above climatic conditions. Local evidence of frost-heaving processes (frost mounds, pingos) is the result of comparatively deep thawing.

V. Eastern Siberia and the Far East. This is an area of taiga, mountain-taiga, and steppe zone extending from the southern portion of the Middle Siberian Plateau to the east up to the Far East.

Characteristic of the relatively stable surfaces (plateau, vast inter-mountain depressions, and valleys) is the development of polygon-trench topography. This is caused by undermining. Weakly developed soil wedges result from deep freezing, frost cracking, and deep thawing (with absent or deep seated permafrost), under an extremely severe, dry climate with hot summers and almost no winter snowfall.

In areas of sediment accumulation, the frost-action morphogenesis is limited as a result of deep thawing. (Occurrence of soil wedges formed within the active layer and syngenetic sedimentation both are possible.) Due mainly to the above climatic conditions, heaving mounds and pingos are widely but locally spread.

It follows that the classification of frozen ground forms presented and their provincial distribution in the regions of northern Eurasia is at present of a general nature that could be one of the rational methods for studying processes in solving future problems and those of the paper—for example, the role of desiccation processes of soil and its frost fissuring in the formation of types of frozen ground morphology; and the problem of post-Pliocene fossil traces of frost action.

The authors consider that the paper presents a new aspect of study, very important and almost untreated, the problem of the role of the most recent and contemporary tectonic activity in the earth's crust on the development of frost geomorphology.

DISCUSSION—SESSION 3

P. I. MELNIKOV

When compiling permafrost maps it is most important to show regions of folded mountains where great influence has been exerted by tectonics, rock composition, and inversion. In most cases, the thickness of frozen ground on highlands is two or more times greater than in valleys. Various thicknesses of frozen ground shown on the map will correspond to peaks or valleys. When solving practical problems it is necessary to know the thickness of the frozen ground on highlands and in valleys. The lesser thickness of frozen ground in valleys usually is associated with the influence of underground water and its manifestations at the surface. This water can be used as a water supply.

The presence of underground water and some idea of the available water resources are indicated by ice encrustations (naledi), whose area can attain several tens of square kilo-

meters. It therefore is very important that maps of folded mountain regions show persistent ice encrustations.

In platform areas the thicknesses are better maintained and they usually are larger than in folded mountain regions. Underground water in such areas is deep sited. In these areas there are deeply buried artesian basins. Conditions for the formation of underground water (the feeding of water bearing horizons and the discharge of underground water) for these regions are very complex. Exploration of underground water has revealed the presence of great thicknesses of frozen ground. The depth at which the underground water is situated is closely associated with the thickness of frozen ground. Therefore, in the case of platform regions, it is necessary to detect anomalous regions with minimal thickness of frozen ground and show them on the map. These regions are of interest for obtaining underground water.

SESSION IV PHASE EQUILIBRIA AND TRANSITIONS

SATURATION, PHASE COMPOSITION, AND FREEZING-POINT DEPRESSION IN A RIGID SOIL MODEL

G. R. LANGE and H. L. MCKIM, U. S. Army Cold Regions Research and Engineering Laboratory (CRREL)

The fact that the phase composition of the soil water is important in controlling the physical behavior of frozen soils is beginning to gain its deserved attention. It is well established that load-bearing capacity and energy required for freezing and thawing depend on initial temperature of the soil [1-4]. These and other physical properties are temperature dependent chiefly because the amount of unfrozen water is also, in part, temperature dependent. Some exploratory experiments with natural soils have indicated that phase composition of soil water also depends strongly on the degree of saturation. This is a preliminary report of the results of some experiments with an idealized soil model. The experiments illustrate the separate and combined effects of both temperature and saturation on phase composition of soil water.

It has been shown that cores of frozen rocks and soils can be taken from any depth below the surface and shipped to a refrigerated laboratory with very little thermal disturbance [5]. Thermistor cables and bridge circuits are available that give accurate measurement of the temperature of the rock or soil from which the core was taken [6]. Since virtually undisturbed samples can now be examined in the laboratory, the next step toward a more complete understanding of permafrost is a quantitative description of the sample components.

For an undersaturated soil, these components are four in number: Mineral grains, ice, air, and liquid water. If the soil is fully saturated, air is eliminated. Measurement of the amount of these components in the sample presents no special difficulties except for differentiation between liquid and solid phases of the water. A dilatometer may be used or this may be accomplished by calorimetry, using either the method of mixtures [1] or an adiabatic calorimeter [4]. There is reason to believe that measurement of the dielectric constant and the ac resistivity can eventually be used to determine phase composition of the water. Electrical methods are especially good because of their apparent sensitivity; however, the present lack of an adequate theory of complex mixtures of dielectrics has discouraged their use.

While temperature effect on the amount of unfrozen water has often been reported, investigators generally worked with natural soils, which in our experience, yield data with considerable scatter chiefly because of difficulty of remolding samples to uniform density, both from sample to sample and throughout a single sample. The effect of degree of saturation and of pore size have not previously been thoroughly examined. Use of a rigid permeable medium such as unglazed porcelain, as a model of natural soils, eliminates the problem of density variations. This allows the variable of pore size to be held constant while investigating effects of variations in saturation and temperature, since these two remaining variables are easily and accurately adjusted at will.

EXPERIMENTAL PROCEDURE

Phase composition of the water in the unglazed porcelain was measured by the method of mixtures. Adaptation of this method to frozen soils is described by Lovell [1]. His method was used with the following modifications: (a) Temperatures were recorded continuously using thermocouples and a millivolt recorder. (b) Change in temperature of the mixture after introduction of the frozen sample was corrected for heat gains resulting from calorimetric inefficiencies, according to a method

described by King and Grover [7]. This correction method consistently gave correct values for the heat of fusion of pure ice to $\pm 1.0\%$. Calorimetric inefficiency was further reduced by filling the air space between calorimeter cup and Dewar flask with Styrofoam and insulating the entire calorimeter from the room temperature with a thick layer of Styrofoam.

The following equation, which is usually applied to the method of mixtures, was solved for x at adjusted levels of saturation and temperature.

$$x C_{pi} \Delta t_i + x H_{fi} + x C_{pw} \Delta t_w + y C_{pscw} \Delta t_{scw} + y C_{pw} \Delta t_w = (W_{cw} C_{pw} \Delta t + W_{ccs} C_{pAl} \Delta t) - (W_p C_{pp} \Delta t_p) \quad (1)$$

where

- x = wt of ice (g)
- y = wt of unfrozen water (g)
- $x + y$ = wt of original total water substance
- $x/(x + y)$ = percentage frozen
- C_{pi} = specific heat of ice (at -5.0°C , $0.496 \text{ cal/g}^\circ\text{C}$) [9]
- Δt_i = temperature change of ice ($^\circ\text{C}$) (observed value)
- H_{fi} = heat of fusion of ice (79.71 cal/g) [9]
- C_{pw} = specific heat of water ($1.00 \text{ cal/g}^\circ\text{C}$) [9]
- Δt_w = temperature change of calorimeter water ($^\circ\text{C}$) (observed value)
- C_{pscw} = specific heat supercooled water ($1.01 \text{ cal/g}^\circ\text{C}$) [9]
- Δt_{scw} = temperature change of supercooled water (observed value)
- W_{cw} = wt of calorimeter water (g) (observed value)
- Δt = temperature change of calorimeter water ($^\circ\text{C}$) (observed value)
- W_{ccs} = wt of calorimeter cup and stirrer (Al), (g)
- C_{pAl} = specific heat of Al ($0.22 \text{ cal/g}^\circ\text{C}$) (a constant of the apparatus)
- W_p = wt of dry porcelain model (g)
- C_{pp} = specific heat dry porcelain ($0.169 \text{ cal/g}^\circ\text{C}$) (observed mean of 7 determinations)
- Δt_p = temperature change of porcelain ($^\circ\text{C}$) (observed value).

Close control of the freezing temperature was achieved by use of a Styrofoam box inside a chest-type home freeze. The freezer temperature was set at approximately -17°C and was constant to within $\pm 2.0^\circ\text{C}$. Temperature inside the Styrofoam box was controlled by a thermostatic mercury switch, a small electric heating element, and a fan. Temperature was controlled to within $\pm 0.1^\circ\text{C}$.

The freezing-point depression for various saturation levels was measured by preparing samples at desired saturations in the manner described below. A thermocouple was inserted in

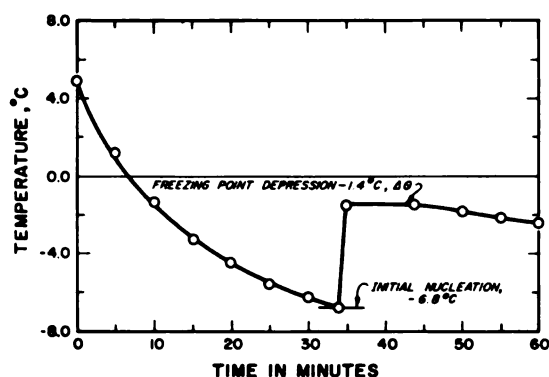

Fig. 1. Typical time vs. temperature curve for determining freezing-point depression

a small hole drilled in the porcelain block, and the sample and thermocouple were placed in the constant temperature cabinet. The freezing-point depression data reported were taken at a cabinet temperature of -9.8°C to provide a constant cooling rate. (Effect of cooling rate on freezing-point depression was negligible.) Time versus temperature curves were obtained on the millivolt recorder chart. The highest temperature reached after nucleation was used as the value of the freezing-point depression. Fig. 1 is a plot of the data from a typical freezing-point depression run. Uniformity of procedure was rigidly maintained. Only doubly distilled water (resistivity ≈ 2.0 megohm cm) was used; nucleation was carefully avoided during cooling in both calorimetric work and freezing-point depression determinations.

SAMPLE PREPARATION AND DESCRIPTION

An unglazed porcelain slab of the type made for mineralogical streak plates was used. To determine whether pore-space structure would be destroyed by repeated freezing and thawing, a small piece of the slab was subjected to 20 freeze-thaw cycles at a constant freezing temperature; the coefficient of original water saturation was adjusted to 0.92 (which results in an ice saturation of 1.0) before the beginning of each freezing cycle. The amount of unfrozen water was measured after 5, 10, 15, and 20 freezing cycles. Since the amount of unfrozen water did not vary more than the estimated experimental error (approximately $\pm 2.0\%$), it is concluded that the pore structure and size did not change during the freeze-thaw cycles. This also served as a measure of the reproducibility of the calorimetry.

To obtain an even distribution of water in pore spaces, samples were prepared by thorough saturation and slow drying to the desired saturation level. Samples were wrapped in aluminum foil to ensure a closed system. They were then immediately introduced into the constant temperature box and remained there for a period of 19 to 20 hours prior to the calorimetry. Six of the data reported below were taken after freezing from 50 to 65 hours, and they showed that no measurable amount of additional water froze after the first few hours. The small slabs of porcelain used in the experiments were cut to similar dimensions (Table I).

Table I. Dimensions and properties of porcelain samples

Sample No.	Dry Wt (g)	Bulk Vol. (cm ³)	Dry Bulk Density (g/cm ³)	Void Vol. (cm ³)	Porosity	Grain Density (g/cm ³)
2	34.81	19.34	1.80	7.48	0.387	2.94
3	35.25	19.44	1.81	7.43	0.382	2.94

At the outset, distribution of pore sizes had to be determined in order to relate the data to natural soils. An examination of a thin section by an optical microscope at 500X failed to reveal distinct grains or pore spaces. This indicated that grain sizes and pore diameters were less than 1.0μ . An inquiry to the manufacturer (Coors Porcelain Co.,

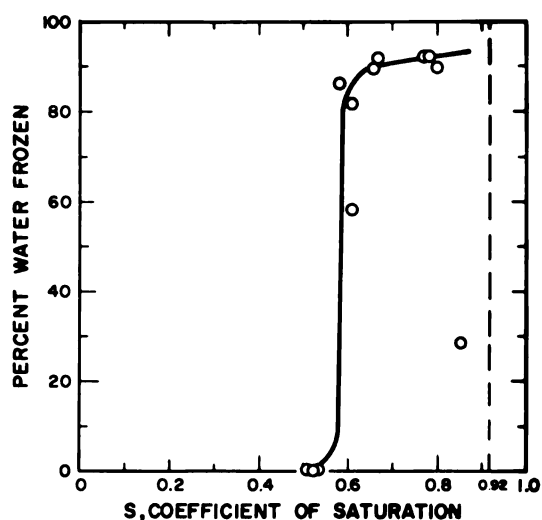

Fig. 2. Per cent water frozen vs. saturation at -4.0°C

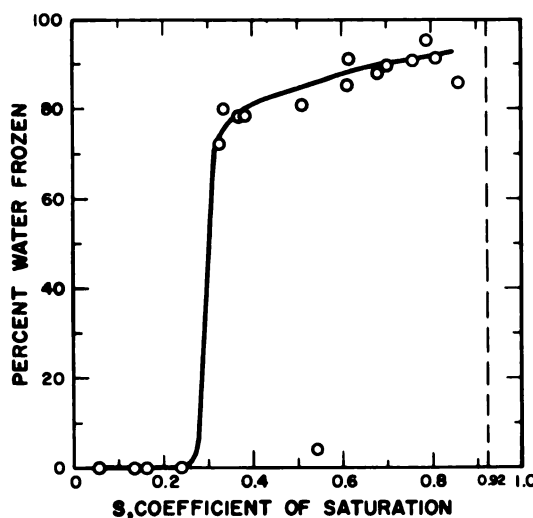

Fig. 3. Per cent water frozen vs. saturation at -5.0°C

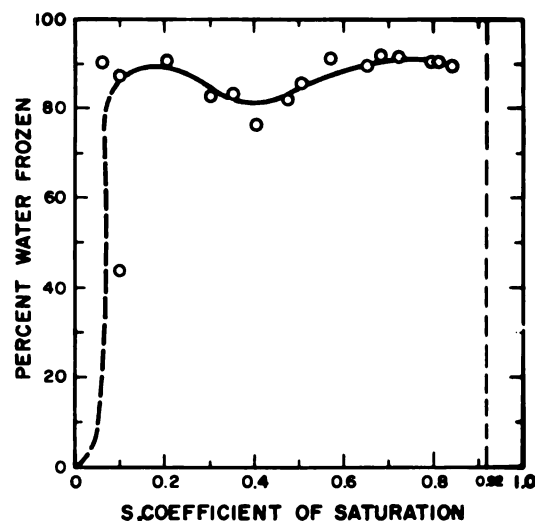

Fig. 4. Per cent water frozen vs. saturation at -7.5°C

Golden, Colo.) revealed that the pore spaces were close to, but less than, 0.5μ in diameter as measured by the bubbling pressure method. The manufacturer also felt that the pore sizes were quite uniform.

RESULTS AND DISCUSSION

Figs. 2, 3, and 4 show the percentage of original water that changed to ice for various saturation coefficients, at constant temperatures of -4.0° , -5.0° , and -7.5°C , respectively. Smoothed curves were drawn by eye. As these data were collected, it became clear that freezing occurred abruptly at a single, reproducible saturation level for each temperature. A number of determinations were run at high levels of saturation and at temperatures of -3.2° and -3.5°C and at lower levels of saturation at a temperature of -6.0°C in order to more completely define the saturation levels and temperatures required for freezing.

The effect of variations of both degree of saturation and temperature on the percentage of total water frozen is shown in Fig. 5. In this three-dimensional plot, the coefficient of saturation versus temperature was plotted as the horizontal grid and the percentage of original water frozen was plotted as elevation. Contours of equal percentage of original water frozen were then drawn at 10% intervals. The smoothed curves

of Figs. 2, 3, and 4 were also used in contouring. All of the points where data were taken are shown as small crosses.

If the coefficient of original water saturation exceeds 0.92 (density of ice), the degree of ice saturation after freezing would exceed 1.0; i.e., ice would form outside the pore-space boundaries of the sample. This effect was actually observed in preliminary experiments and so a saturation coefficient of 0.92 was taken as a boundary condition for these experiments.

In the results in Figs. 2, 3, and 4, only one of the many sets of data shows more than 92 to 93% frozen. In Fig. 5, this indicates that the plateau in the region of lower temperatures and higher saturation has relief of only 2 to 3% frozen and does not extend at any point above about 93% frozen. This nearly constant unfrozen fraction may be that water is closely bound to pore-space walls by adsorptive forces. The water that freezes abruptly on the addition of more water (increased saturation) at the critical temperature (θ_f) is considered to be the water held by meniscus forces. This water is considered to have a depressed freezing point caused by the surface tensions of the minisci, i.e., (2) below.

Depression of the freezing point ($\Delta\theta$) at a wide range of saturation levels was measured. A typical plot of time versus temperature from these experiments is shown in Fig. 1. This was done in an attempt to correlate freezing-point depression

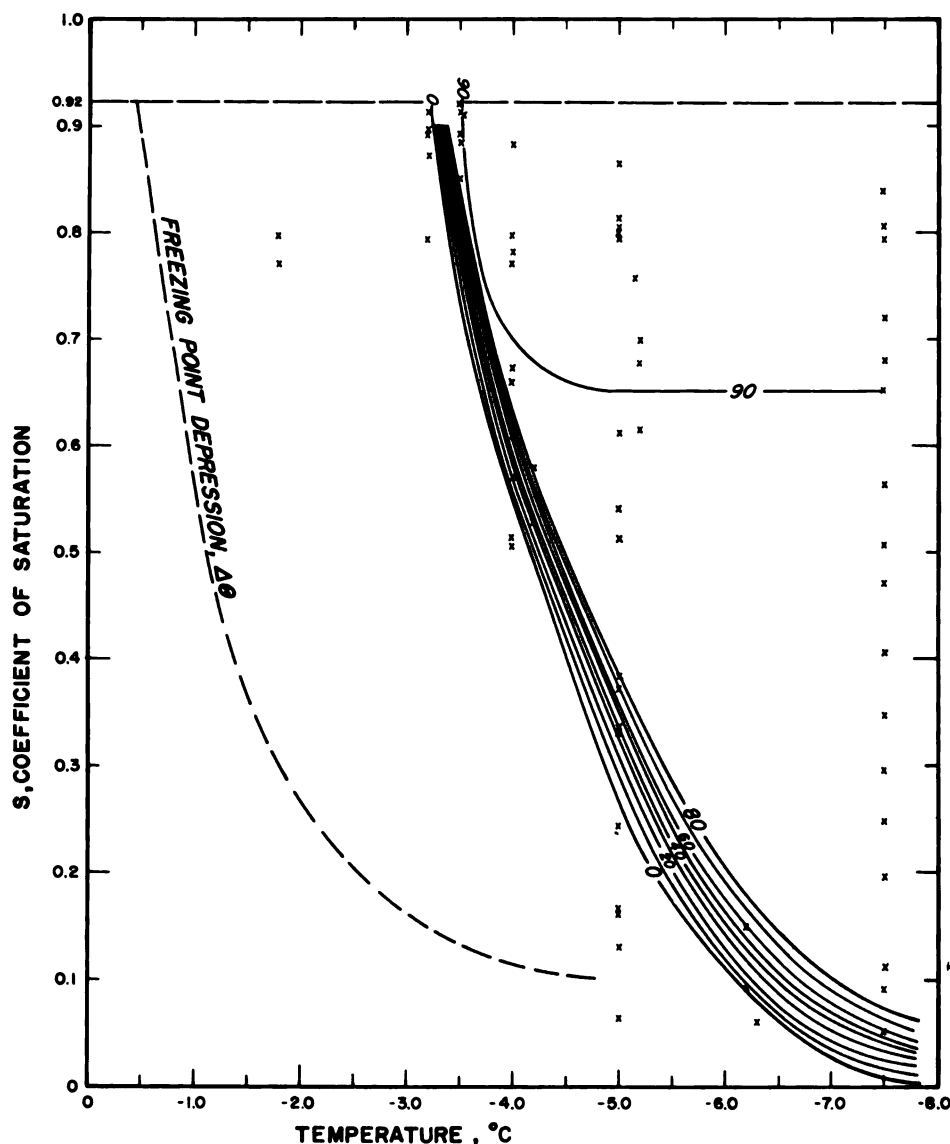

Fig. 5. Combined effect of saturation and temperature upon the per cent of original water frozen. Elevation is per cent frozen

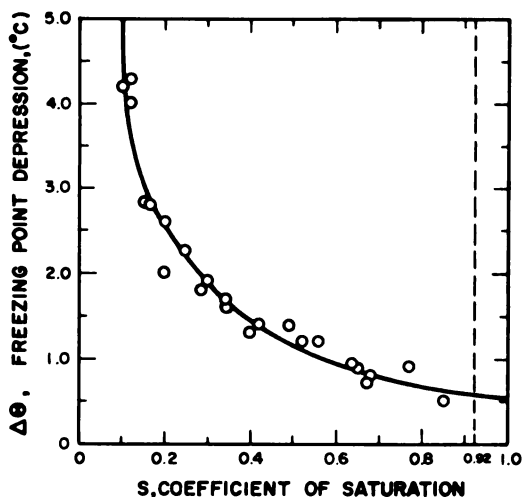

Fig. 6. Freezing-point depression

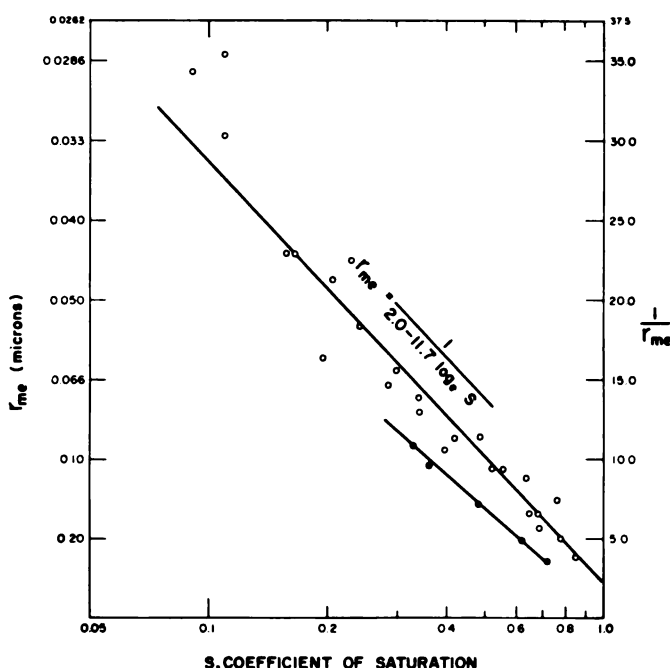

Fig. 7. Pore size vs. saturation calculated from freezing-point depression and from capillary head

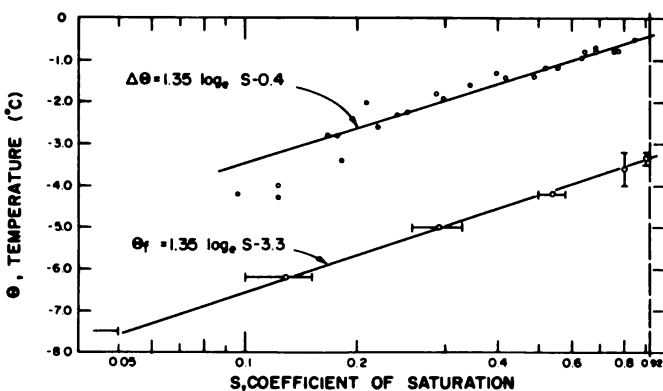

Fig. 8. Freezing-point depression and temperature of guaranteed nucleation is plotted against natural log of saturation coefficient

with the location and trend of the "freezing step" that is represented by the "cliff" of Fig. 5. These results are shown in Fig. 6 and are also plotted as a dashed line on the three-dimensional plot of Fig. 5. Temperatures of initial nucleation, as defined in Fig. 1, which ranged from -5.2° to -7.8° C, were also plotted as an overlay on Fig. 5; however, these appeared to be more or less random in this linear plot, except that they were all temperatures lower than θ_f at saturation above 0.2.

Determination of the freezing-point depression also affords a method of characterizing the pore-space geometry by use of the Gibbs-Thompson equation [8]

$$T_s - T_r = \frac{2 \sigma T_s M}{p_l Q_s r} \quad (2)$$

where T_s is normal melting point 273° K; T_r is melting point $^{\circ}$ K of a nucleus of radius r , cm; σ is interfacial energy (air-water interface at $S = 1.0 = 71.9$ erg/sq cm); Q_s is heat of fusion (3.33×10^9 erg/g); p_l is density of solid phase (0.917 erg/cu cm); and M is molecular weight of water.

A mean effective radius (r_{me}) can be calculated by evaluation of the constants (T_s), (σ), (Q_s), (p_l), and (M).

$$r_{me} = \frac{0.112}{\Delta\theta} \text{ in microns}$$

where $\Delta\theta$ is $T_s - T_r$.

Pore, or meniscus, radii calculated in this way and the reciprocal of the calculated sizes are plotted as open circles against the natural logarithm of the corresponding coefficient of saturation in Fig. 7. This is not intended as an accurate description of the pore sizes, but rather a characterization of them. The resulting straight line gives the following equation for the mean effective radius as a function of saturation.

$$r_{me} = \frac{1}{2.0 - 11.7 \log_e S} \quad (3)$$

where r_{me} is mean effective pore (or meniscus) radius, in microns and S is coefficient of saturation.

Equilibrium saturation for various capillarity potentials (or pressure heads) were measured for the porcelain model. The standard-pressure membrane apparatus and procedures were used, and mean effective radii calculated from these data are plotted as solid circles in Fig. 7. The following equation [10] was used.

$$h_c = \frac{2 \sigma_s}{r_{me} \gamma \cos \alpha} \quad (4)$$

where h_c is pressure (cm of water); σ_s is surface tension at air-water interface 71.9 dyne/cm; γ is density of water (1.00 g/cu cm); α is contact angle ($\alpha = 0$, $\cos \alpha = 1.0$); and r_{me} is mean effective pore radius (cm).

To locate the line of the cliff in Fig. 5, short lines of equal temperature or of equal saturation (as were appropriate to the existing data) were drawn, the ends of which represented the top and bottom of the cliff. These lines were then plotted against the natural logarithm of the corresponding saturation coefficient in Fig. 8. The straight line that results described the temperature (θ_f) for any given degree of saturation below which freezing of most of the water in the pore spaces of the model is virtually guaranteed after 19 to 20 hours of freezing. An equation may now be written as

$$\theta_f = \beta \log_e S - \epsilon \quad (5)$$

Using values obtained from the plot for the constants β and ϵ we obtain

$$\theta_f = 1.35 \log_e S - 3.4$$

where θ_f is temperature of guaranteed freezing ($^{\circ}$ C); β is slope constant; and ϵ is temperature intercept.

The freezing-point depression data are also plotted in Fig. 8, using the same scales. This data can be described by

$$\Delta\theta = 1.35 \log_e S - 0.4 \quad (6)$$

where $\Delta\theta$ is depression of the freezing point.

The fact that both curves have the same slope is interesting. The following explanation tentatively describes the physical relationship between $\Delta\theta$ and θ_f . As the sample is slowly cooled below 0°C , at temperatures above $\Delta\theta$, deliberate nucleation will not cause freezing; in fact, in this region, freezing cannot occur. At temperatures between $\Delta\theta$ and θ_f , freezing can occur only if nucleation is initiated by something outside of the system such as the introduction of ice crystals or possibly physical shock. As the temperature is further reduced to the range below θ_f , the system is still not stable until nucleation and freezing occur; however, in this region nucleation will be guaranteed without any outside agent if sufficient time is available. Experiments are now in progress which may describe the time dependence of θ_f .

In our model, the temperature difference between the freezing-point depression ($\Delta\theta$) and the temperature of guaranteed freezing (θ_f) appears to be constant and independent of temperature and saturation, at least in the saturation range where the ratio of the amount of capillary water to the amount of adsorbed water is large. At saturations lower than 0.15, the data appear to depart from the relationship given in (6); and during the freezing-point depression experiments, it was noticed that when nucleation occurred at temperatures higher than θ_f , this occurred only at saturations less than 0.20. It may be that in this region of low saturation ($S < 0.20$ to 0.15), enough of the total soil water is adsorbed to cause a departure from the relationships described.

CONCLUSIONS AND RECOMMENDATIONS

It is concluded that the amount of water that freezes in a frozen soil may be strongly influenced by the degree of saturation as well as temperature. The temperature history of a naturally occurring frozen soil may have bearing on its phase composition and consequently on its strength and effective specific heat. That is, it may be supercooled and may have suffered no accident of nucleation. The rate of advance of a nucleating front in a freezing soil will have bearing upon the validity of this speculation.

We suggest that investigations of phase composition of soil water should be an important part of any serious engineering or scientific investigation of frozen fine grained soils. Phase composition should be isolated as a discrete variable of strength rather than be included in the more general variables of temperature and saturation. In our opinion, if the behavior of soil water on freezing is investigated in a manner similar to the one described, a fuller understanding of several different (but related) aspects of freezing behavior may be gained.

If adiabatic calorimetry is carried out as described by Williams [4], information presented here could probably be gathered with much greater efficiency and accuracy. Further, it would seem that a method similar to the one he described may furnish a more straightforward explanation of the relationship between the freezing-point depression and the temperature of guaranteed freezing, since both stable and metastable behavior may be described with his apparatus.

ACKNOWLEDGMENTS

Discussions with the following members of the CRREL staff have furnished many of the ideas for both design of the experiments and analysis and discussion of the data: Duwayne Anderson, Andrew Assur, Geoffery Ballard, Paul Camp, Kenneth Linell, Richard McGaw, Donald Nevel, Fred Sanger, Shunsuke Takagi, and Wilford Weeks. We are happy to acknowledge their assistance and encouragement.

REFERENCES

- [1] C. W. Lovell. "Temperature Effects on Phase Composition and Strength of Partially Frozen Soil," Highway Res. Bd. Bull. 168, 1957, pp. 74-95.
- [2] Raymond Yong. "Research on Fundamental Properties and Characteristics of Frozen Soils," Soil Mechanics Ser. No. 3, McGill Univ., 1962.

- [3] N. A. Tsytoich. "Bases and Foundations on Frozen Ground," Highway Res. Bd. Spec. Rept. 58, 1958.
- [4] P. J. Williams. "Specific Heat and Unfrozen Water Content of Frozen Soils," 1st Can. Permafrost Conf., Ottawa, April 1962.
- [5] G. R. Lange. "The Use of Refrigerated Drilling Fluids for Drilling and Coring in Permafrost," Session 7 in this volume.
- [6] B. Lyle Hansen. "Instrumentation for Temperature Measurements in Permafrost," Session 7 in this volume.
- [7] A. King, H. Grover. "Temperature Correction Methods in Calorimetry," J. Appl. Phys., Vol. 12, 1941.
- [8] W. E. Garner. Crystal Growth, Disc. Faraday Soc. No. 5, 1949.
- [9] Chemical Rubber Publ. Co. Handbook of Chemistry and Physics, 38th ed., 1953.
- [10] W. T. Lambe. Soil Testing for Engineers, Wiley and Sons, 1951.

DISCUSSION

D. M. ANDERSON includes this paper in his discussion which is presented at the end of Session 4 in this volume.

R. D. MILLER—This paper poses a real challenge. It reminds us that we cannot say much, if anything, about the freezing of water in partially saturated soils. In this investigation, the authors used an apparently rigid and stable substrate, which is a step in the right direction. But who can say what really happens within this medium as water freezes? Does the water freeze in situ, or does it move toward the sites of nucleation until the pores in that region become saturated with water or ice or both? What is the configuration of the phase boundaries?

The authors are apparently confused in their use of (2). From the context, one judges that they have used the equation for the equilibrium temperature of an ice nucleus of radius (r) in water at atmospheric pressure. They should have used the interfacial energy of an ice-water phase boundary instead of that for air and water. If they use the latter, and take (r) to be the curvature of the air-water meniscus in the capillaries, then they have a freezing-point elevation case provided the air-ice interface is flat.

Now the strange thing, and this has been observed before, beginning with Schofield and his students, is that if one uses this equation to predict the magnitude (but not the sign) of the change in freezing point of water in soil as the soil is dried out, the results compare fairly well with predictions based on the desorption curve. One can rationalize this result in an unconfined specimen on grounds that ice segregates and forms in spaces that are large in comparison with those occupied by water and is therefore near atmospheric pressure. If the ice in Lange and McKim's experiments formed outside the block, this problem does not occur, and we have the analog of the experiment described in William's contribution to this conference.

Making the indicated changes in (2) and assuming that ice-water is 45 dynes/cm, the upper curve in Fig. 7 falls almost on top of the lower. This coincidence is hard to accept, however, for the excessive undercooling used by Lange and McKim in their freezing-point depression measurements means that the freezing temperatures recorded were too low, and the error increases as saturation decreases. This error arises from the fact that a finite amount of water must freeze in order to raise the temperature of the block to an equilibrium temperature. This fraction is a substantial portion of the total water over much of the range and, therefore, the residual unfrozen water content should have been plotted instead of the initial water content. Indeed, according to rough calculations, there was not enough water present in the drier specimens to raise the temperature more than half way to the "predicted" equilibrium temperature.

CLOSURE

In a discussion of Session 4, D. M. Anderson correctly pointed out that the latent heat of freezing measured in calorimetric determinations of the phase composition of soil water should be corrected for differential heat of wetting. He showed that the resulting latent heat of adsorbed soil water may be less than that normally assumed (for normal water: 79.71 cal/g).

It is clear that the heat of wetting is a phenomenon that occurs at or very near the soil water-mineral grain interface. Anderson's data for the Wyoming bentonite indicated that at water-content values of less than 10% the value of the latent heat of freezing passes through zero and at lower water-content values it becomes negative. This last, incidentally, may be taken to indicate that the remaining water (at a liquid water content of less than 10%) will not freeze at any temperature. His data further suggested that departure from the value of the latent heat of freezing of normal water occurs at a moisture content of approximately 30%. Thus, it will be of interest to calculate the thickness of the soil water film on bentonite particles at this critical value because, in terms of decreasing water content, apparently it is at this value that the soil-water film becomes thin enough for the heat of fusion of the soil water to become appreciably influenced by the adsorptive force field of the mineral grain.

Anderson assumed the specific surface of the bentonite to be 8×10^6 sq cm/g, so we may now estimate the thickness of the soil-water film at the critical moisture content:

$$\begin{aligned} &\approx \frac{0.3 \text{ cu cm}}{8 \times 10^6 \text{ sq cm}} \quad (\text{per g dry soil}) \\ &\approx 3.7 \times 10^{-8} \text{ cm} \\ &\text{or} \\ &\approx 3.75 \text{ \AA} \text{ (Angstroms)}. \end{aligned}$$

Recent measurements of the heat of wetting in water of the porcelain used in our work allow calculation of the specific surface. Data published by Puri and Murari [1] show that the specific surface of a large number of various soils measured and calculated by four different methods agree with the specific surface calculated from heat of wetting measurements to within a few per cent. The constant that they obtained is 186.8 erg/sq cm ($\approx 4.5 \times 10^{-6}$ cal/sq cm). We measured the heat of wetting of the porcelain in much the same way as the phase composition of the soil water in our original paper. We obtain a value for the oven-dry porcelain of <0.3 cal/g. Using the constant obtained from [1], we calculate a specific surface of $\approx 6.7 \times 10^4$ sq cm/g, approximately 100 times less than the bentonite.

If we take a monomolecular layer of water to be ≈ 2.8 \AA thick, we can conclude (as Anderson did) that a moisture content of 30% (≈ 3 or 4 \AA) roughly corresponds to a monomolecular layer coating all the bentonite surfaces. We are led (see curve of figure by Anderson in DISCUSSION of Session 4) to the conclusion that most of the heat of wetting is generated in the first or possibly second layer of water molecules coating the mineral grains. The work of Puri and Murari shows that the heat of adsorption is roughly independent of the character of the mineral surface and is approximately a constant energy value per unit of available mineral surface, for a wide range of soils.

We may now estimate the minimum critical moisture content below which the correction Anderson proposed should be applied to calorimetric determinations of amounts of unfrozen water in any soil or soil model for which the heat of wetting may be measured. For our porous medium:

$$\begin{aligned} \text{specific surface of porcelain} &\approx 6.7 \times 10^4 \text{ sq cm/g} \\ \text{minimum critical thickness of water film} &\approx 5.6 \times 10^{-8} \text{ cm} \\ &(\approx 5.6 \text{ \AA}) \end{aligned}$$

Therefore, the minimum critical volume (weight) of water/g of dry soil is:

$$(5.6 \times 10^{-8} \text{ cm}) (6.7 \times 10^4 \text{ sq cm}) = 3.7 \times 10^{-3} \text{ cu cm/g dry soil}$$

$$\text{or } 0.00375 \text{ g water/g dry soil}$$

$$\text{or moisture content by weight } \approx 0.4\%.$$

We presented phase-composition data based on calorimetry for saturation (S) coefficients down to 0.1 which corresponds to a moisture content (MC) of 2.1% and we commented in the original paper that the data appeared to fit out empirical relationships only down to about $S \approx 0.15$ or $MC \approx 3.2\%$.

Since it was our purpose in this paper to pose some questions rather than to answer them, we are indebted to R. D. Miller for clearly delineating these problems in his discussion. A secondary purpose of our paper was to call attention to the use of rigid models for investigations of soil-water freezing phenomena. A recent paper by Corey, Nielsen, and Biggar [2] suggests that the lack of interconnections of pore spaces in a natural sandstone makes that material, at least, a poor rigid model of a soil. However, recent electron microscopy reveals that our porcelain is only lightly sintered and pore spaces appear to be completely connected.

Professor Miller's remarks regarding the possible movement of water toward the sites of nucleation are appropriate; however, we would like to point out that the porcelain blocks were (purposely) thin slabs in order to establish a minimum thermal gradient as quickly as possible after introduction into the freezing cabinet. Until an adiabatic calorimeter which incorporates some method of heating and cooling a sample with no thermal gradient becomes available, we know of no other technique for countering this valid objection. We, of course, have no knowledge of the configuration of the phase boundaries during freezing; indeed, direct observation of freezing in pore spaces would probably furnish considerable insight into these problems.

Professor Miller's argument that we should have used the interfacial energy value for an ice-water phase boundary in the Gibbs-Thompson equation (our equation (2)) is probably correct. Further consideration of the freezing-point depression curves of time plotted against temperature (our Fig. 1) suggests that when temperature reaches the level of the freezing-point depression ($\Delta\theta$), ice is present in some of the pores and is surrounded by water.

We, too, admit to some confusion regarding the apparent paradox of the sign reversal that results when data from an experiment like ours is entered into this (Gibbs-Thompson) equation. We can only speculate that the values of one of the terms (σ) interfacial energy, (Q_s) heat of fusion, or (r) the radius, from our data should have a negative sign. Obviously, if σ has a negative value, then neither Q_s nor r may be negative, and if either Q_s or r is negative then σ cannot be negative.

Regarding the formation of ice outside the porcelain block, we were extremely careful to discard samples where this was observed. This accounts for the paucity of data at saturation levels higher than about 0.90.

It seems unlikely to us that the freezing temperatures recorded for the freezing-point depression experiments were lowered below the true equilibrium freezing temperature because long time periods (on the time versus temperature curves) of constant temperature were recorded indicating an equilibrium freezing temperature.

We are indebted to Duwayne M. Anderson for his assistance in the preparation of the first portion of this closure which relates to his discussion and to John Sayward who brought the work of Puri and Murari to our attention.

REFERENCES

- [1] B. R. Puri, K. Murari. "Studies in Surface Area Measurement of Soils: 1. Comparison of Different Methods," *Soil Sci.*, Vol. 96, 1963, pp. 331-336.
- [2] John C. Corey, D. R. Nielsen, J. W. Biggar. "Miscible Displacement in Saturated and Unsaturated Sandstone," *Soil Sci. Soc. Proc.*, Vol. 27, 1963, pp. 258-262.

PHASE EQUILIBRIA AND SOIL FREEZING

R. D. MILLER, Cornell University, Ithaca, New York

Interactions of soil and liquid water involve two kinds of interfacial phenomena. Interactions at a mineral-water interface are described as "adsorption" effects. Interactions that involve the surface of water exposed to a gaseous phase present in soil are called "capillary" effects. The combined action of adsorption and capillarity determine the configurations of the liquid phase that may exist for any given liquid water content.

Current conceptions of the process of frost-heaving may also be said to depend on adsorption and capillary phenomena. These determine the configuration of an unfrozen liquid phase in soil where the respective boundaries are with soil particles and the ice phase. Taber's classic papers on heaving postulated existence of a liquid film between soil particles and a growing ice-lens and suggested that adsorption forces were responsible [1]. Jackson and Chalmers [2] drew attention to the importance of the geometry of the ice-water interface in relation to soil pores. In alternate form, this becomes the standard capillary relationship expressed in terms of surface tension of the ice-water interface. The thermodynamics of heaving systems were completed by Everett in a definitive contribution [3].

While quantitative experimental confirmation of the present state of frost-heaving theory is meager, qualitative agreement is good; the situation is very promising. This paper reviews some aspects of the theory in order to extend it to soils that freeze without ice-lens formation and to call attention to related theory developed for unfrozen soils. If, as suggested, analogies may be drawn between these systems, a considerable body of knowledge and experimental experience may be transposed to frozen soils.

CONDITIONS AT EQUILIBRIUM

A standard text on thermodynamics [4] includes a brief discussion of equilibrium between a liquid and its vapor when the two are at different pressures. This discussion may be illustrated by (Fig. 1) a schematic drawing of a cylinder fitted with pistons at each end, and divided into two compartments, *x* and *y*, by a wall of porous material such as unglazed porcelain. In a later application, the region designated *S* will be occupied by soil, but this may be ignored for the moment. Contents of the respective chambers will be designated *X* and *Y*, respectively.

In the textbook example, *X* is liquid mercury which does not wet porcelain. If the pores in the porcelain are small, liquid mercury will not enter or pass through the wall material until the pressure (P_x) is raised to a value much higher than P_y . Mercury vapor, however, passes freely through the wall so that *Y* is pure mercury vapor at some pressure (P_y). Within limits to be mentioned below, P_x may be varied at will so long as it exceeds P_y . Ordinarily, the vapor pressure of pure mercury is determined by temperature only, but in this example it will be affected by P_x as well. Starting with $P_x = P_y$ at temperature *T*, all possible equilibrium states between liquid mercury and its vapor must satisfy the relation (Everett's equation 12):

$$V_x dP_x - V_y dP_y = \frac{\Delta H}{T} dT \quad (1)$$

where *dT* is the temperature change, ΔH is the heat of transition, *dP* is the pressure change, and *V* is the partial molal volume for the phases indicated by the subscripts.

Let the quantity ($P_x - P_y$) be represented by p_{xy} , the gauge pressure of *X* with respect to *Y*. In all subsequent applications, the system will be so arranged that p_{xy} is either zero or positive. Whenever p_{xy} is positive *Y* if it persists at all, will be metastable. In the example given,

Fig. 1. Diagram of apparatus for equilibrating two bulk phases on opposite sides of a porous wall at unequal pressures; soil is inserted where appropriate

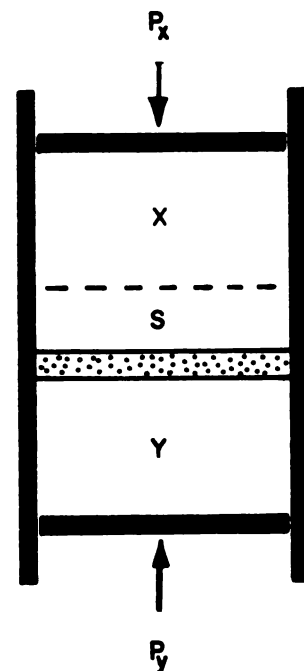

where *Y* is mercury vapor, this vapor will be supersaturated with liquid mercury at pressure P_y whenever p_{xy} is positive. If a droplet of liquid mercury is introduced into chamber *y*, the pressure inside the drop will exceed the pressure of the vapor by an amount $2\sigma_{xy}/r$ where $1/r$ is the mean curvature of the liquid-vapor interface, and σ_{xy} is the surface tension of the interface. If the droplet is spherical, *r* is the drop radius. If the pressure in the drop exceeds P_x , the drop will evanesce; if less than P_x the drop will grow, if P_x , P_y , and *T* are held constant, until the vapor phase has disappeared.

The critical size of a (spherical) drop that will neither grow nor evanesce is given by $r = 2\sigma_{xy}/p_{xy}$. As p_{xy} increases, the critical size decreases, and the probability of spontaneous nucleation of a droplet larger than critical size increases. A practical limitation to possible equilibrium states, then, depends on factors affecting nucleation of phase *X* in chamber *y*, including the magnitude of p_{xy} .

A second practical limitation is determined by the dimensions of pores connecting chambers *x* and *y*. Given the contact angle between mercury and porcelain, there is some critical interfacial curvature that will permit the interface to penetrate the wall. Once this occurs, the consequences are the same as if a supercritical droplet had been nucleated in *y*.

Within the field of equilibrium states, injection of heat at an infinitely slow rate at constant temperature and p_{xy} will cause phase *Y* to increase at the expense of *X*. This is a reversible process even though *Y* is a supersaturated vapor by the usual definition.

Water-Vapor (W-V) Case

An alternate example involves a liquid that wets the material of the porous wall, for example, water. Let *Y* be pure (liquid) water that also fills the pores of the dividing wall. Let *X* be pure water vapor formed by evaporation of water present in the wall. The situation is similar to the preceding

example except that the roles of liquid and vapor are interchanged. Noting the new significance of subscripts x and y , (1) applies to the new system without change. Whenever p_{xy} is positive, Y is again metastable, but this time the metastable phase is a superheated liquid. All that was said previously about nucleation of liquid droplets in y may now be said about nucleation of vapor bubbles in y . A like statement applies to penetration of the porous wall by the vapor-liquid interface. Injection of heat causes X to increase, and vice versa.

At a given temperature, pure water has a vapor pressure P_0 when p_{xy} is zero. If temperature is held constant, p_{xy} may be increased by reducing P_y . The relative humidity (h) of the equilibrium vapor (x) is given by

$$h = \frac{P_x}{P_0} \text{ or } h = e^{-\alpha} \quad (2)$$

where

$$\alpha = \frac{V_y}{RT} [p_{xy} - (P_0 - P_x)]$$

This equation is obtained from (1) and the ideal gas law. Note that the term in parenthesis is negligible compared to p_{xy} when P_0 is small, as near the ice point. Notice that P_y , the absolute pressure in the liquid phase Y , may be negative, with the liquid phase remaining intact through the action of internal cohesive forces and the action of adhesive forces within y to which water does not adhere serves as a nucleating site for vapor bubbles, adding another practical limitation to possible values of p_{xy} . It is known that pure water in clean glass containers can be subjected to tensile stresses of scores of bars without rupture, but experimental realization of a practical form of the apparatus of Fig. 1 depends on elimination of nucleating sites.

An equivalent system may be achieved by omitting the chamber y and sealing the porous wall. The appropriate value of p_{xy} can be calculated from (2) when h is known in chamber x .

Air-Water (A-W) Case

Another degree of freedom may be introduced by making another component a part of the equilibrium system, for example, air or any immiscible fluid. If air is present in x , it is free to dissolve in water that occupies the wall pores and to diffuse in solution into chamber y . The gaseous phase (X) referred to as "air" contains an appropriate amount of water vapor. The liquid phase (Y) contains an appropriate amount of dissolved air. As p_{xy} is made positive, Y again becomes metastable. This time it is a supersaturated solution of dissolved air. All that was said before about nucleation of vapor bubbles may now be said about nucleation of air bubbles. Equation (1) no longer applies since P_x now refers to the pressure on the air. However, (2) is still applicable.

The device known as a tensiometer is a form of the apparatus in Fig. 1. As normally used, X is the gaseous soil atmosphere. In such a device Y has been observed to become unstable as p_{xy} approaches 3/4 bar. This failure may be forestalled by frequent replacement of Y with freshly deaired water. The tension table, pressure plate, and pressure membrane apparatus are all examples of forms of Fig. 1 that are in regular laboratory use. The last two in this group are used at values of p_{xy} which produce instability of Y . This problem is circumvented by approaching equilibrium through increases in p_{xy} and by omitting chamber y . The porous wall is simply exposed to the atmosphere, and the desired value of p_{xy} imposed by increasing p_x above atmospheric pressure. By this means, values of p_{xy} up to 15 bars are imposed as a matter of routine, and values up to several score bars have been used on occasion. The validity of this technique has been checked by appropriate measurements of h , using (2), with apparent good agreement within the range where such tests are practical [5].

Ice-Water (I-W) Case

If chamber y is occupied by pure water that fills the pores of

the wall, and chamber x is occupied by ice that slides without friction along the chamber walls, then the situation closely resembles the W-V case, providing the ice is separated from the wall material by an unfrozen film with the properties inferred by Taber. When such a film is present, there can be no direct shearing stresses transmitted from the wall material to the ice-water interface. Hence the ice phase could, in principle, be replaced by any immiscible fluid, providing appropriate adjustments are made for the surface energy of the interface in each case. Pressure in the ice must be uniform and equal to P_x .

This being true, (1) applies to the I-W case in the same manner as in the W-V case. When p_{xy} is positive, Y is again metastable, and is supercooled. All that was said about nucleation of vapor bubbles in y may now be said with respect to nucleation of ice crystals in y except for the remarks about adhesion. All that was said about penetration of the porous wall by the XY interface still applies. Injection of heat will cause Y to increase at the expense of X . Extraction of heat induces the process of frost-heaving.

Soil Water Characteristic Curve

Soil scientists have used apparatus resembling Fig. 1 for many years as a means of appraising the relationship between soil water content and the affinity of soil for water [6]. Soil is placed against a porous membrane of sintered glass, filter paper, unglazed porcelain or other similar materials and so occupies the position designated by the letter S in Fig. 1. The form of the apparatus known as Haines apparatus, leaves x open to the atmosphere pressure P_0 and P_y is reduced by increments, so that p_{xy} equals $-(P - P_0)$. The quantity $(P - P_0)$ has been called pore-water pressure, and various similar names. The quantity (p_{xy}) has been called soil moisture tension and other names, the most recent being "matric suction" or more briefly, "suction." Starting with a saturated soil, p_{xy} may be increased by increments and the water release observed for each step. If p_{xy} is subsequently reduced by increments, the soil will recover water if Y is present. A plot of soil water content as a function of p_{xy} is called the soil water characteristic, and (if complete) provides data from both drying and wetting procedures. This is because the curves for wetting and drying usually do not coincide; the soil water characteristic is a hysteresis function. By a suitable sequence of wetting and drying operations one may produce a soil with water content and suction values that will plot at any point between the two limiting curves for drying (starts with a saturated sample) and wetting (starts with a dry sample).

The Haines apparatus, like the tensiometer, is limited to values of p_{xy} up to about 3/4 bar or less. In the Richards form of the apparatus, y is vented to the atmosphere and p_{xy} increased by increasing P_x . With a suitable membrane, p_{xy} may be raised to scores of bars, but this is inevitably accompanied by slow movement of air through the soil and through the membrane material.

The analogy given above between the A-W and I-W cases suggests that a soil freezing characteristic may be found that is closely related to the soil water characteristic in all respects, including hysteresis. The term "soil freezing characteristic" has been coined to signify a plot of unfrozen liquid content in a soil (in apparatus of the form of Fig. 1) as a suitable function of p_{xy} where X is ice and Y is liquid water. In practice, it may be simpler to control p_y and T and to calculate p_{xy} from (1). The relationship between the soil water characteristic and the freezing characteristic will depend on the nature of the soil involved, as explained below.

Some Ideal Soils

It is important to recognize fundamental differences in materials called soil. Two extremes will be designated SS soil and SLS soil, respectively. SS soil refers to soil in which all soil particles are in direct solid-to-solid contact, Dune sand, or a well-sorted silt are examples of SS soil. In such a soil, the particles are more or less fixed in space, being wedged

between their neighbors, and the bulk volume of a specimen of SS soil changes only with changes in the way in which the particles are fitted together. A change in water content of an SS soil is accomplished when water present in the pores is displaced by air, for example, with little or no change in bulk volume.

SLS soil refers to a soil in which the particles are always separated by a mobile liquid film. A paste of well-oriented sodium montmorillonite particles is an example of SLS soil. The particles are flat, and of uniform thickness. When well oriented, the particles tend to be equally spaced and parallel, and to be separated by liquid water in adsorbed films that may be many times thicker than the particles themselves. All of the water present lies within range of the adsorption forces active near the surfaces of soil particles. A change in water content of such a material produces a corresponding change in the bulk volume of the soil since the particles merely move closer together or farther apart; the space between remains filled with water at all times.

A typical soil encountered in the field is likely to be a composite of the two extreme types mentioned, and will be designated SLSL soil to indicate that some of the particles are in direct contact with their neighbors, while others are separated from them by a mobile liquid film.

WATER IN SS SOIL

The accepted explanation of the soil water characteristic of SS soil is given in Haines' classic paper [7]. The relationships between water content and suction, including hysteresis, are wholly explained in terms of surface tension and the geometry of the pore system.

Miller and Miller [8] published a more general treatment based on similitude that permits scaling of the soil water characteristic and a variety of transient flow problems. They adopt a concept of "similar media" and of "similar states" for similar media. An example of similar media would be a pair of soil samples in which every particle in one had a magnified counterpart in the other. Corresponding particles in each soil are in corresponding positions in the manner of corresponding sides of similar geometric figures. On a statistical basis, duplicate samples of a given soil would simulate similar media. Each medium may be assigned a microscopic characteristic length (λ) to be chosen in any convenient manner. This quantity specifies the size scale of the medium and may be, for example, the diameter of the median particle. Similar media are said to be in similar states of water content when the geometry of the air-water interfaces in the respective soils are also geometrically similar. This can be true only if the wetting angle of the liquid for the solid is the same in each soil.

For a similar media in similar states, the gauge pressure (p) in the pore water, measured with respect to the air pressure is of such a magnitude that the quantity ($\lambda p/\sigma$) is the same in each even though different liquids may be involved. The quantity ($\lambda p/\sigma$) is called the reduced pressure (p^*), and is dimensionless.

Adapting the same nomenclature and reasoning to Fig. 1 it follows that $-\lambda p_{xy}/\sigma_{xy}$, or p_{xy}^* , will be the same for similar SS soils at similar liquid water contents whether X is air, pure water vapor, or even ice! Consequently, one anticipates that the soil water characteristic and the freezing characteristic of a given SS soil will superimpose if (unfrozen) water content is plotted as a function of p_{xy}^* in each case. From (1) we obtain for SS soil frozen in the apparatus of Fig. 1

$$p_{xy}^* = \frac{\lambda}{\sigma} \left[\frac{\Delta H}{V_y T} \left(\Delta T - \frac{\Delta V \Delta P_y}{\Delta H/T} \right) \right] \quad (3)$$

where ΔT is the change equilibrium temperature accompanying a change in p_{xy} with or without a change in P_y .

WATER IN SLS SOIL

The soil water characteristic for SLS soil, or for soils that

approach the ideal SLS model, has not been fully explained. A discussion of various models and their relationship to experimental results is inappropriate here. In the ideal SLS soil, a change in water content is accompanied by a corresponding change in the bulk volume rather than by intrusion of a foreign phase into the spaces between adjacent particles. Cracks and fissures containing air (or ice) may occur, subdividing the soil mass, but the extent of the air-water interface is always small in comparison with the interface between particles and water. The water content is determined independently of these cracks and is controlled by the thickness of films adsorbed between the particles.

If an SLS soil is placed in the apparatus of Fig. 1, the water content varies as p_{xy} varies, and it is immaterial whether X is air or an inert solid block such as the piston itself, providing the presence of dissolved air has no significant effect on the adsorption phenomenon. If temperature is adjusted in accordance with (1), X may be occupied by ice. Insertion of lumps of ice into the SLS soil mass, under these conditions, will not disturb the equilibrium. Hence the (unfrozen) liquid content of the SLS soil plotted as a function of p_{xy} should be identical with the soil water characteristic.

WATER IN SLSL SOILS

According to the discussion above, the soil water characteristic and the soil freezing characteristic of an SS soil should be identical if water content is plotted as a function of p_{xy}^* , but not if plotted as a function of p_{xy} . The situation is reversed for SLS soil. If these expectations are verified by experiment, comparison of I-W and A-W curves obtained for SLSL soil, using either method of plotting, should make it possible to distinguish between water that remains unfrozen at a given temperature because of adsorption effects, and that which is prevented from freezing by geometric limitations.

WATER MOVEMENT IN FROZEN SOIL

That the conductivity of soil for water declines as water content declines is well known. The effect is most profound in SS soil; halving the water content may decrease conductivity by several orders of magnitude. These relationships are measurable [9]. Similar techniques should be applicable, in principle, to measurement of the conductivity of frozen soil for water, but the technique is obviously more demanding. Pending experimental exploration of this question, it seems reasonable to suggest that the concepts of similar media and similar flow systems [8] may be adapted to the prediction of water movement in frozen SS soil. Where transport involves significant movement in adsorbed films, however, similitude probably does not exist, since transport may be a diffusion phenomenon rather than a viscous flow.

Water movement in ideal SLS soil is extremely slow. The presence of transverse ice-lenses in such a soil would appear to impose impervious barriers to flow, but this is not necessarily true. Local melting and freezing at appropriate places would permit displacement of water across an ice-lens that did not change its shape or position, even though the ice was in motion. Flow across ice-free soil between lenses would be in the normal manner. Such a process requires simultaneous transport of latent heat. Where heat transport is not limiting, displacement flow through a frozen SLS soil ought to be just as rapid as through an unfrozen SLS soil of the same (unfrozen) water content. Indeed, the presence of a sustained temperature gradient in an SLS soil with ice-lenses should induce sustained movement of water.

STRENGTH OF FROZEN SOIL

It was suggested earlier that the ice-water interface in a frozen soil does not experience direct shearing stresses when the system is at equilibrium. If this is true then the ice phase cannot contribute directly to the static strength of soil. Of course, ice will greatly increase the resistance of soil to finite rates of strain, so that a soil that exhibits extreme

resistance to deformation by impact, or rapid loading, may creep when subjected to relatively slight stress over a long period of time.

The rate of creep should be highly temperature sensitive and should increase rapidly as the temperature approaches the ice point, even though the ice content may not change perceptibly. The mechanism visualized is not creep of the ice phase itself, though this may occur, but rather selective melting and freezing, with a displacement of water through unfrozen films from one site to the other. Although the conductivity of such films is low, the distance of movement involved is small (of the order of one particle dia.) so that the configuration of the ice phase may change at a rate that reflects the effect of temperature on film thickness.

FROST-HEAVING

Frost-heaving is probably the most troublesome practical consequence of soil freezing. Engineers are forced to rely on heaving tests performed on samples frozen under controlled conditions as indicators of probable performance of soil in the field. While these tests are useful, they are not wholly satisfactory, for it is not practical to simulate in the laboratory the range of pertinent variables that may determine actual behavior in the field. There is a continuing interest, therefore, in devising means of extrapolating the results of a few laboratory tests to any condition that might be expected in practice. The soil water characteristic may provide a basis for extending the interpretation of heaving tests or even to circumvent them in some cases.

In his paper, Everett mentions some inherent relationships that exist in the theory of heaving as it now stands, and he compares these with some experimental data [3]. He finds, for example, that an estimate of pore size for one of Penner's samples leads to a prediction of maximum heaving pressure that is near enough to the observed value to be regarded as encouraging. In his contribution to the present conference, Penner uses two soil water characteristic curves to make similar predictions, again with some success. The computations of Everett involve empirical correlations and good agreement would hardly be expected. Penner's comparison is based on fractions of Potter's flint each with an obviously narrow range of pore sizes.

Theory also predicts that overburden pressure and soil suction should be additive in their effect in arresting ice-lens formation. Penner [10] has presented data that contradict this prediction, suction being twice as effective as overburden pressure in stopping heaving. The soil involved in these experiments had a broad pore size distribution, as shown by the soil water characteristic data included with the report.

Everett mentions the importance of pore size distribution in his discussion of frost damage to building stone. Other aspects of pore size distribution may be of equal or greater importance when there is no external source of water. Everett points out that for the latter case, the ice phase may continue to grow, drawing the air-water interface into the porous material. He adds that the concave meniscus so formed lowers the pressure exerted by the ice crystals. He might have predicted that if the pores were of substantially the same size, the absolute pressure exerted by the ice crystals would fall below atmospheric (and the disruptive force would vanish) before the water pressure was low enough to allow the air-water interface to enter the stone. This is because the surface energy of the air-water interface exceeds the surface energy of the ice-water interface, according to published data. The air-water interface can be drawn into pores that are larger than those that confine the ice phase, however. When the ice pressure is atmospheric, and is confined by pores of effective radius (r_i), the smallest unfrozen pore that can yield its water to the ice phase will have an effective radius (r_a) where $r_a = (\sigma_{aw}/\sigma_{iw})r_i$. The volume of water held in pores of the requisite size can be read from the soil water characteristic. As confining pressure due to overburden or tensile strength of the porous material increases, the size of

the smallest pore that can yield water to the ice phase increases further. In the absence of pores with required size difference, the ice pressure would never exceed atmospheric, and the disruptive force that can be developed would be zero but for the volume change of water on freezing. As pore water freezes, the water displaced by freezing of water in situ may be used in lens growth at another location, or it may be exuded from the stone.

With materials of uniform pore size in mind, and the effect of relative values of surface tension of ice and water and air and water, Miller et al [11] were led to remark that the soil immediately beneath a growing ice-lens must be saturated. This conclusion does not apply, of course, to soils with a wide range of pore size distribution except, perhaps, for the pores in the first layer of particles that separate an ice-lens from unfrozen soil. Because of the repulsive action between ice and particles, the soil particles in this layer are likely to be driven together into a closer system of packing than exists in the soil mass as a whole, and the saturated layer would be a mere skin of particles in contact with the lens.

With the above in mind it is probably significant to observe that data of Penner (that seem to conflict with theory) involved specimens that were not saturated during those tests in which the suction in the unfrozen soil was a limiting factor. Complications that arise with respect to conductivity for water, the development of "skins," etc., may have confounded his results. It would be interesting to see this experiment repeated with soil having a narrow range of pore size distribution. Theory might be confirmed if this were done.

Miller et al [11] measured the equilibrium temperature of a block of ice that rested on water-saturated silt fractions. In some experiments, P_x was increased while P_y was held constant. In others, the procedure was reversed. Their results agreed well with the proposition that overburden pressure and matric suction are additive in the manner predicted by (1). Their results showed small but seemingly consistent deviations from the expected linear relationship between temperature and pressure up to the point at which ice evidently entered the pores. This was detected in some cases by minute temperature fluctuations, after which the temperature failed to respond rapidly to changes in pressure. This is reasonable since freezing of pores reduces the conductivity of soil for water and delays attainment of equilibrium in the adiabatic arrangement used in these experiments.

In the same paper, Miller et al obtained theoretical curves from premises that were implicitly identical with those of Everett, but were explicitly distorted by geometric approximations subsequently recognized as superfluous. As a result, the theoretical curves exhibited a slight curvature rather than correct linear relationship.

The author believes that the theory of frost-heaving will be adequate for soils of narrow pore size distribution, readily identifiable from their soil water characteristic curves. The theory is not yet complete as applied to soils of broad pore size distribution. The considerable knowledge available on the soil water characteristic curve will help solve problems relating to frost heaving and other aspects of frozen soils.

SOME WORK IN PROGRESS

The author is associated with research related to the matters discussed in this paper. R. Koopmans has undertaken investigations of similitude. An effort will be made to obtain the ratio (σ_{aw}/σ_{iw}) by matching soil water and soil freezing characteristic curves for SS soils. C. Dirksen is investigating heaving in closed systems; he is using parameters obtained from the soil water characteristic curve to predict the mode and magnitude of water transport in frozen and unfrozen soil in the presence of a temperature gradient. Both investigations are Ph.D. theses research being conducted in the Department of Agronomy, Cornell University, under Contract (DA-11-190-ENG-23) with CRREL, U.S. Army Materiel Command.

REFERENCES

- [1] S. Taber. "The Mechanics of Frost Heaving," J. Geol. 38, 1930, pp. 303-317.
- [2] K. Jackson, B. Chalmers. "Freezing of Liquids in Porous Media with Special Reference to Frost Heave in Soils," J. Appl. Phys. 29, 1958, pp. 1178-1181.
- [3] D. H. Everett. "The Thermodynamics of Frost Damage to Porous Solids," Trans. Faraday Soc. 57, 1961, pp. 1541-1551.
- [4] G. N. Lewis, M. Randall. Thermodynamics, McGraw-Hill, N. Y., 1923.
- [5] L. A. Richards, G. Ogata. "Psychrometric Measurements of Soil Samples Equilibrated on Pressure Membranes," Soil Sci. Soc. Amer. Proc. 25, 1961, pp. 456-459.
- [6] L. A. Richards. "Methods of Measuring Soil Moisture Tension," Soil Sci. 68, 1949, pp. 95-112.
- [7] W. B. Haines. "Studies in the Physical Properties of Soil: V. The Hysteresis Effect in Capillary Properties and the Modes of Moisture Distribution Associated Therewith," J. Agri. Sci. 20, 1930, pp. 97-116.
- [8] E. E. Miller, R. D. Miller. "Physical Theory for Capillary Flow Phenomena," J. Appl. Phys. 27, 1956, pp. 324-332.
- [9] W. R. Gardner. "Calculation of Capillary Conductivity from Pressure Plate Outflow Data," Soil Sci. Soc. Amer. Proc. 20, 1956, pp. 317-320.
- [10] E. Penner. "Pressures Developed in a Porous Granular System as a Result of Ice Segregation," Highway Res. Bd. Spec. Rept. 40, 1958, pp. 191-199.
- [11] R. D. Miller, J. H. Baker, J. H. Kolaian. "Particle Size, Overburden Pressure, Pore Water Pressure and Freezing Temperature of Ice Lenses in Soil," 7th Intern. Cong. Soil Sci. 1, 1960, pp. 122-129.

FROST-HEAVING IN SOILS

EDWARD PENNER, National Research Council, Ottawa, Canada

A literature survey shows that present interest in frost action research is focused on thermodynamic properties of the ice-water interface. This aspect of the freezing process is a fascinating field for research and much progress is being made, but there are many other equally important aspects, when ice-lensing is involved in the freezing process, that have not been investigated since the studies of Taber [1] and Beskow [2].

To draw attention to a much wider field in the problem of frost-heaving, this conference may be an appropriate occasion to summarize some work carried out since 1955 by the Division of Building Research, National Research Council of Canada. These studies have included changes in soil structure from ice segregation, characteristics of moisture flow and potentials induced, heaving pressures produced by frost action, dependence of unfrozen water content on temperature and soil type, ice proliferation rates in water and in growth retarder solutions, heat and moisture balance during ice-lensing, some observations on the structure of ice in lenses, and the freezing process in porous systems.

ICE-LENSING

The formation of ice-lenses as a major cause of frost-heaving in soils is well established, although the 10% phase change expansion also adds significantly to the total heave. In providing space for ice as the lens grows, work must be done to lift overburden and any surface surcharges. The necessary supply of water is obtained from surrounding soil or ground water, and so further work is done to establish and maintain a potential gradient in soil water. The available work by the freezing process must be divided therefore between these two processes which occur simultaneously.

Ice-lenses usually form parallel to the soil surface along an isothermal freezing plane so that the expansion and heaving pressures are always in the direction of heat flow. The lateral extent of one lens depends on the homogeneity of solid material and the uniformity of water supply and temperature gradient. The thickness of the lens, however, is a rate-dependent phenomenon that varies between soils but is always contingent on the balance between moisture supply and heat flow.

When, therefore, potential water supply is equal to or exceeds the existing heat removal rate, the lens will continue to grow at one site indefinitely. When heat removal rate temporarily exceeds moisture supply, temperature at the lower face of the ice-lens decreases; a new location for growth may be established when a more favorable water supply is encountered by the freezing front. As these events are repeated,

they result in rhythmic ice banding.

Heat removal rate can be increased to a point where a uniform distribution of ice occurs throughout the frozen soil behind a continuously penetrating frost line, but at the same time, water is being moved to the freezing zone so that heaving still occurs. Finally, in the case of a quick freeze, heaving is reduced to the 10% expansion when freezing is too rapid for the movement of soil moisture, and hence only the in situ water freezes.

STRUCTURE OF ICE IN LENSES

It is of considerable interest to note the conformation of ice-lenses. When grown in soil with a carefully controlled environment of temperature, pressure, and water supply, the structure of the lenses were not as uniform as anticipated [3]. Ice grains were elongated in the direction of heat flow, but different optical orientations were often observed in adjacent crystals. Optical orientation was determined by etching a freshly polished ice surface. Fig. 1 shows soil structure formed, ice distribution, and shape of the freezing front in an ice-lens. Fig. 2 shows the disorder of the etch pits on the horizontal face of the ice-lens. In Fig. 2 the heat flow is perpendicular to the plane of the paper. The c-axis (crystal axis), lower crystal is almost parallel to the heat flow; the upper crystal is at about a 45° angle to the heat flow. Although randomness is apparent in all lenses examined, the studies were not statistical enough to establish firmly the degree of disorder.

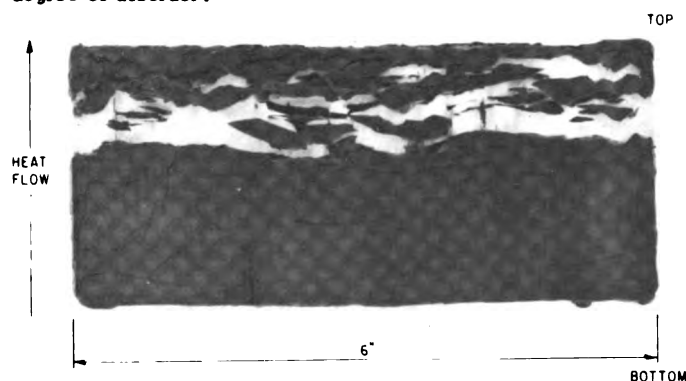

Fig. 1. Vertical slice of clay specimen after unidirectional freezing

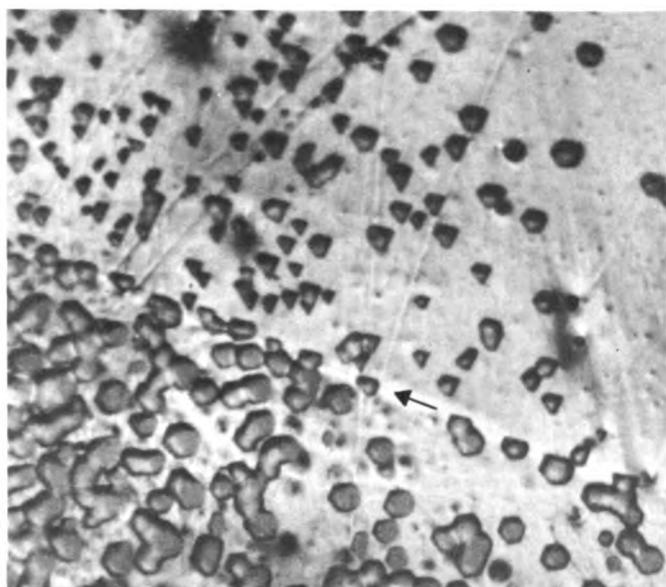

Fig. 2. Crystal boundary of ice-lens indicated by arrow

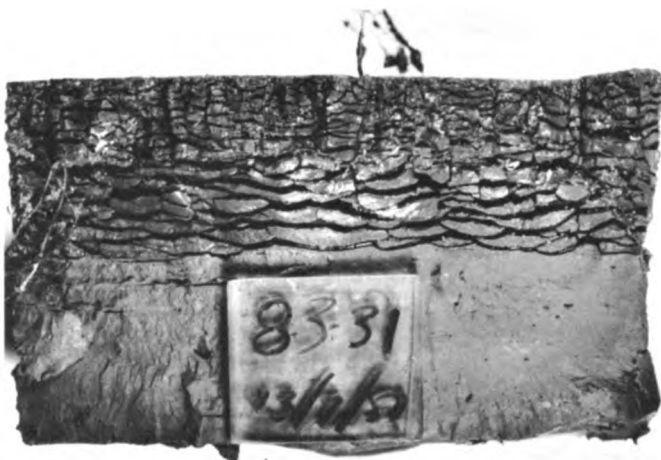

Fig. 3. Laboratory-produced ice-lensing in silty clay

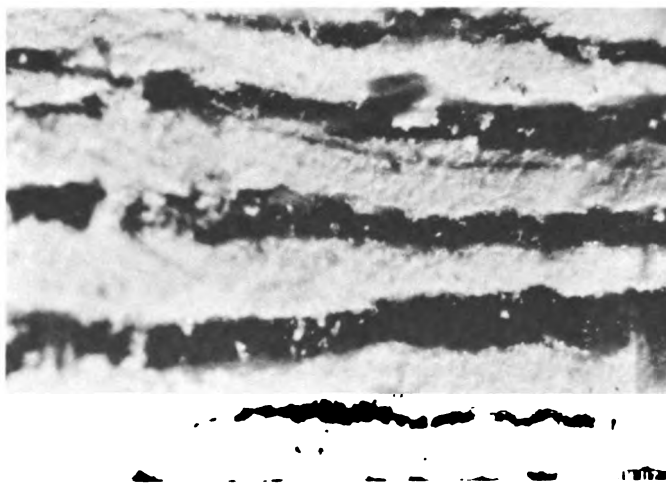

Fig. 4. Ice-lenses (dark) in silt (light)

Crystal orientation was usually different above and below the soil occluded in the ice-lens. Non-unidirectional heat flow around occluded soil, may have contributed to the randomness observed.

Growth rate of ice in a pure melt is greatest in the direction normal to the c-axis during free growth [4]. This may be responsible for the change in structure with depth of unidirectionally frozen ice starting with random nucleation at the water surface. The grains oriented with the c-axis normal to direction of heat flow gained preference at the expense of all other directions of orientation [5]. This preference was not observed in the ice formed by lensing in soil.

SOIL STRUCTURE FORMATION

There are important differences in the structure of frozen soil and in the disposition of ice and soil resulting from the ice segregation processes in different soil types [6]. The convex shapes of the lower face of occluded structures and the undulating freezing front in clays (Fig. 3) are in sharp contrast to the more uniform size of soil strata between ice-lenses common in coarser frost-susceptible soils (Fig. 4) [7]. When the frost line is advancing in clays, the shrinking process, due to local water removal by ice growth, appears to dominate the shape of the particle plucked away from the freezing front and occluded in the ice. The lower face, which is normally convex, is thought to be a result of uneven shrinking, leaving an irregular freezing front even though unidirectional heat flow conditions are carefully maintained for the sample as a whole. Suction potential developed in clays is high, but the permeability is low; this accounts for the local shrinkage and hence the kind of structure observed.

INDUCED SUCTION, HEAVING PRESSURES, AND MOISTURE FLOW

Moisture in the liquid phase can flow through constrictions between adjacent pores more easily than ice can proliferate through the same porous system in the temperature range normally encountered during soil freezing. This is the basic reason why ice crystals grow in pores. If the pores are small enough, the crystals develop into ice-lenses, although water in pores directly beneath may be below 0°C . This water would crystallize if seeded, but is not cold enough for spontaneous nucleation.

Soils have a low strength in tension and unless there are confining pressures due to overburden or superimposed surcharges, the crystal is almost free to grow within the restrictive limits of water supply assuming appropriate thermal conditions. Transfer of water from the film surrounding the soil particle to the ice crystal appears to remove the molecule from the sphere of attraction by the particle. This changes the moisture potential and sets up a suction gradient in soil water.

If induced suction is of sufficient magnitude to overcome capillary pressures, it may empty larger pores and thus the soil desaturates. This decreases the cross-sectional area of the flow path and reduces the permeability coefficient below the value for full flow. The characteristics of change in the unsaturated permeability depend on the properties of the material such as pore-size range, pore-size distribution, and nature of the solid. In view of the suction-permeability interdependence it is obviously not correct to use saturated permeability coefficients for predicting heaving rates.

Development of suction during freezing in a closed system containing Potter's flint at almost no overburden pressure is shown in Fig. 5. In the same material the development of heaving pressures was followed while the system was kept fully saturated. When heaving ceased, the suction in the soil water was zero. In both cases, the system was initially saturated and a small ice-lens was allowed to develop before the experiment was started. The importance of this is accounted for by Everett [8].

The final moisture content in the suction experiment (Fig. 5) was much below the saturated conditions maintained in the heaving pressure experiment; that is, as a suction developed, the flint samples desaturated, a phenomenon not uncommon in the field.

Thus, Fig. 5 demonstrates two methods for reducing ice-lensing to zero—of course, heaving can be stopped also by the simultaneous application of suction and overburden pressure. It is believed that forces responsible for heaving and induced suction can be accounted for by considering only the geometry of the porous material, provided it is hydrophilic in nature.

UNFROZEN WATER CONTENT OF FROZEN SOILS

Ice-lensing activity in soils is generally assumed to be restricted to the plane separating the completely unfrozen soil and the lowest ice-lens. Although this may be the plane of greatest heaving activity, since in heavier soils layers between successive lenses are frequently soft and apparently unfrozen, it lends weight to the conclusion that several ice-lenses, one above the other, may be increasing in thickness concurrently but at different temperatures. It is obvious from Fig. 6 and from similar results given elsewhere [9] that simultaneous growth of several lenses, one above the other, may be quite general since the water in natural soils freezes over a temperature range, but the simultaneous growth of several lenses is probably most pronounced in clays. During the season of heat loss from the soil—when frost-heaving occurs—the temperature in the soil increases with depth. Hence, other things being equal, the smallest unfrozen moisture content would be near the surface.

The process whereby successive ice-lenses become established has not been determined, but there are at least two possibilities: (1) "Seeding" of the new location occurs by ice proliferation through the larger pores until a stable balance of heat and moisture flow is reached; or (2) as the temperature drops at the ice-soil interface due to natural processes, spontaneous nucleation may occur ahead of the previous ice-lens in larger water filled pores leaving a layer of unfrozen soil between successive ice-lenses. It is, therefore, of some interest to look briefly at some aspects of ice proliferation in its own melt.

ICE PROLIFERATION RATES IN SOLUTION

Dentritic ice proliferation rates have been measured in pure water and various aqueous solutions [10]. The growth rate in a particular solution is not predictable, except that it is known in a general way that aqueous organic solutions are

more effective retarders of growth of ice than inorganic solutions.

Ice proliferation rates were measured in small, thin-walled glass capillaries filled with solutions of various concentration [11, 12] to study how injecting solutions into the pore water of soils affects frost-heaving. Within the heat-dissipation limits, rates were realized to be relative rather than absolute [13]. The majority of experiments were in solutions of calcium lignosulfonate, a byproduct of wood pulping by the sulfite process. The attenuation of proliferation rate is shown in Fig. 7 as a function of supercooling for water and aqueous solutions of sulfite liquor up to 50% concentration.

Although ice proliferation in these experiments was by dentritic growth and therefore not entirely similar to ice-lens growth in soil, the effectiveness of field injections with this product agrees with the results of the laboratory experiment. Some conclusions based on these results are: (1) That altering the ice growth characteristics of soil water may be a useful approach to pursue for diminishing frost-heave rates; (2) the effectiveness of the retarder is not related to its "antifreeze" characteristics since the sulphite liquor (50% concentration) lowered the freezing point by less than 3°C (this is also substantiated by freezing point and proliferation studies in both high and low molecular weight fractions in the liquor [12]); (3) the character of ice proliferation rates studied in the presence of large molecules should be extended to channels between solid particles and the pores of porous solids.

HEAT AND MOISTURE BALANCE DURING SOIL FREEZING

Simultaneous measurement of heat flow, moisture movement, and heave during freezing has been useful in identifying some of the significant factors that should determine a realistic laboratory frost susceptibility test for soils [14]. The apparatus was designed to ensure unidirectional heat flow that could be measured by heat transducers at both ends of the specimen. It has, therefore, been useful also in measuring the thermal conductivity of soils [14, 15].

The dominating influence of heat flow on the heaving rate was evident for all soils. Three distinctly different rates of heat extraction from specimens were imposed during one experiment. The response in moisture flow closely followed changes in net heat flow. Three soils, varying widely in many characteristics, responded similarly (Fig. 8). The conclusion is that it is misleading to assess frost susceptibility of different soils (for field use) in the laboratory with the same frost line penetration rate. Different soil types would not freeze at the same rate under similar climatic conditions because of differences in thermal conductivity, water supply, in situ water content, etc.

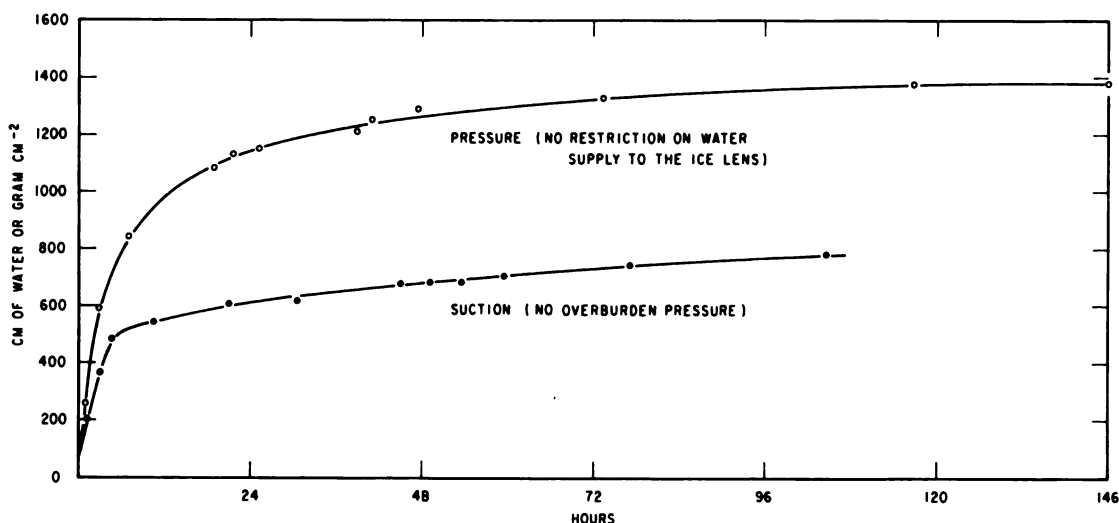

Fig. 5. Development of suction and heaving pressure in Potter's flint

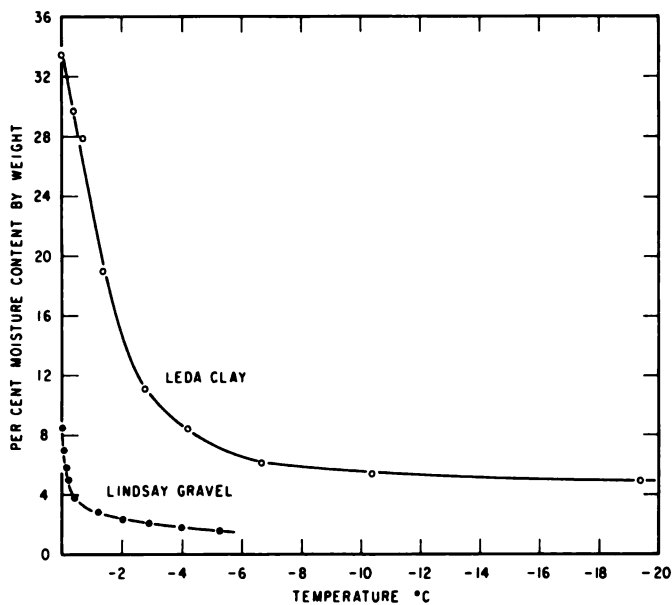

Fig. 6. Unfrozen moisture content versus temperature

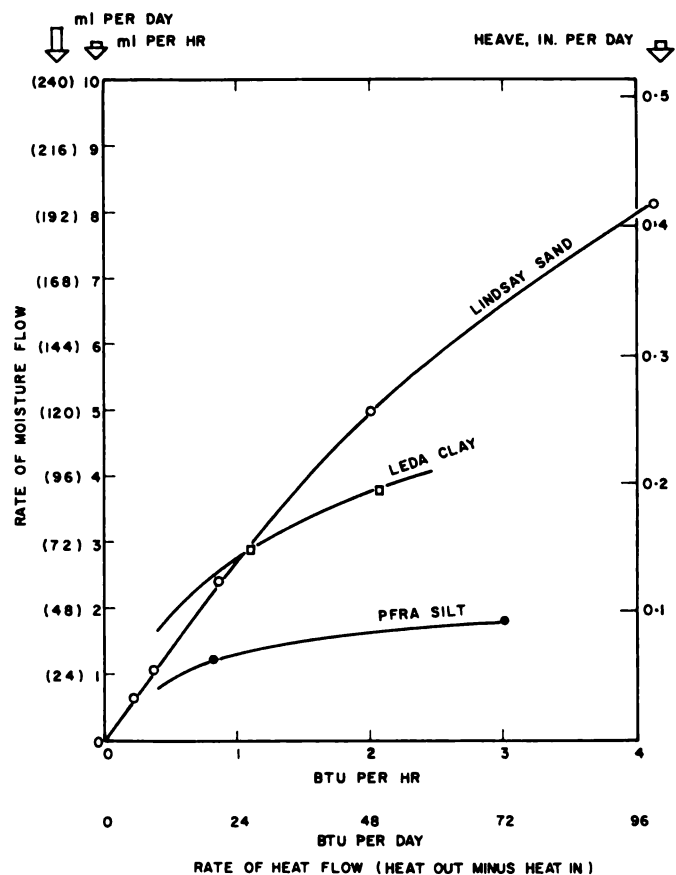

Fig. 8. Rates of moisture flow and heave versus net heat flow

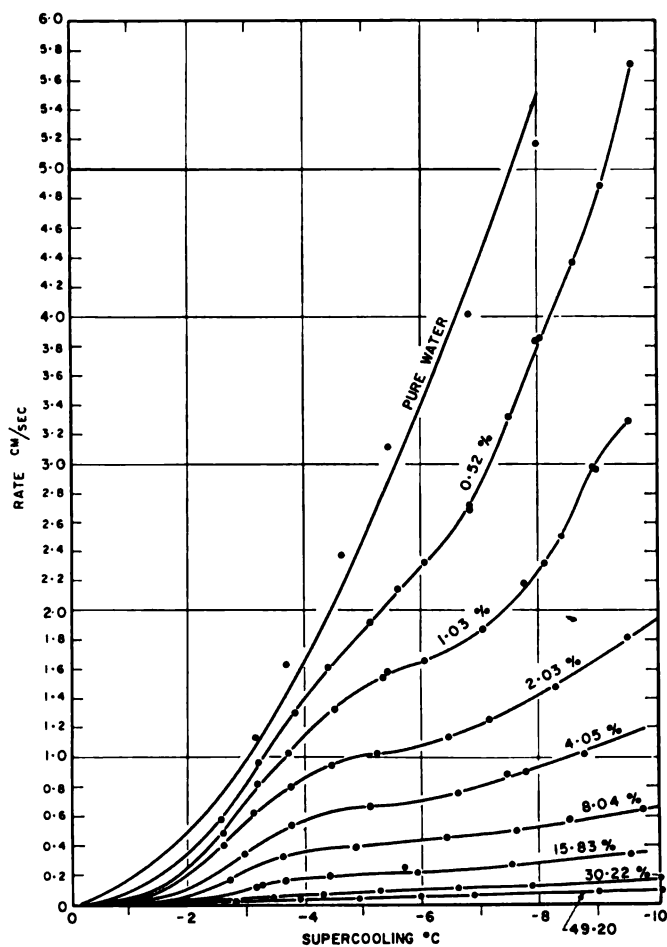

Fig. 7. Rate of linear ice crystallization versus supercooling at different concentrations of sulfite liquor

A uniform heat extraction rate consistent with the average field condition appears to be the more realistic approach for evaluating the frost susceptibility of different soils in the laboratory. Further, these experiments showed that freeze-thaw cycles are not a requirement for ice-lensing [16], as some still believe. Confusion arises from the fact that freeze-thaw cycles do have the effect of "pumping" water in successive steps to one plane in the soil. This wider separation at one plane can be particularly destructive to plant root systems.

FREEZING OF WATER IN PORES: EXPERIMENT AND THEORY

Thermodynamic properties of water freezing in pores and causing frost-heaving have been discussed at length by Gold [17], Jackson and Chalmers [18], Everett [8], and in less specific terms by the author [19, 20, 21]. There is agreement on the nature of the process, but the treatment by Everett has been generally preferable. It states the problem simply and precisely, yet it is sufficiently comprehensive to be applicable to both unconsolidated and solid porous materials. It is of interest, however, to review some of the experimental facts on which the theory is based.

Earlier work [19] established that, starting from saturation, the amount of water available for ice-lensing and the maximum suction induced in a closed soil system below the zone of freezing was a function of the state of subdivision in granular material; both were greater for a clay than for coarser soils.

Measurements of the maximum heaving pressure, suction, and combinations of these in Potter's flint [20] at various densities do not appear to satisfy completely a self consistent theory. These experiments showed that the maximum heaving pressure in a fully saturated material was greater by a factor of approximately two than the maximum suction when heaving

stopped. Such comparisons are of practical importance since soils in the field desaturate under suction as did the Potter's flint.

The active area at the ice water interface is now thought to decrease as desaturation takes place, emptying the larger pores. This may account for the suctions being lower than heaving pressures. As desaturation occurs the permeability is also greatly reduced, making equilibrium difficult to evaluate. In light of this, valid comparisons would seem to be possible only so long as the material stays fully saturated; nonetheless, in the field, desaturation cannot be avoided.

At equilibrium the rate of melting equals the freezing rate. Thus the free energy of ice equals the free energy of water at the ice water interface. It follows that the reversible condition is

$$v_i dP_i - s_i dT = v_w dP_w - s_w dT \quad (1)$$

where i and w are the ice and water phases, v is specific volume, s is specific entropy, P is pressure, and T is temperature.

Rearranging and substituting Q_f/T for $s_w - s_i$, where Q_f is the latent heat of fusion per gram and considering finite changes, the expression becomes

$$\frac{v_w \Delta P_w - v_i \Delta P_i}{\Delta T} = \frac{Q_f}{T} \quad (2)$$

Considering the freezing plane to be in a porous material [15] apparently permits three possible cases in the physical application of pressure to the two phases of atmospheric pressure: The pressure is on the ice only, thus the pressure change in water is zero and hence, $v_w \Delta P_w$ is zero; or the pressure is on the water only and the pressure change on the ice is zero and hence, $v_i \Delta P_i$ is zero; or the same pressure is applied equally to both phases, which was the case preferred previously by the author [21]. Hence,

$$\Delta P_{total} (v_w - v_i) = \frac{Q_f \Delta T}{T} \quad (3)$$

Assuming that heaving pressures resulting from ice-lensing do not influence the pressure in the water phase, then $v_w \Delta P_w$ equals zero. Combining the resultant equation with the well-known form of the Thomson equation [22] leads to Everett's relationship which gives the limiting heaving pressure in terms of pore radius.

$$\Delta P_i = \frac{2\sigma_{iw}}{r} \quad (4)$$

where r is the radius of the smallest constriction of the pore, and σ_{iw} is the interfacial energy. In the same way, in the case for zero pressure on the ice and negative pressures in the water, the limiting suction (ΔP_w is negative) is given by

$$\Delta P_w = \frac{2\sigma_{iw}}{r\rho_i v_w} = \frac{2.22 \sigma_{iw}}{r} \quad (5)$$

where ρ_i is the density for ice.

Everett has made some estimates using the author's published results for Potter's flint. Based on this, along with other substantiating evidence for porous solids, he claims the theory to be consistent with experimental results at least for heaving pressures. A large pore-size range in the material is, however, a drawback in making rigorous comparisons of heaving experiments with theory.

Pressure measurements were made during early work on frost action in a frost cell apparatus [19] on two different size fractions of Potter's flint. The predominant pore sizes were determined by water release curves (Fig. 9). Fixing the pore radius of the finer material at 1.47μ and at 25 erg/sq cm for σ_{iw} , (4) predicts a maximum heaving pressure of 350 g/sq cm , whereas the actual measurement at saturation gave 400 g/sq cm . Taking 9μ as the predominant pore radius for the coarser fraction, the predicted value is 55 as against the measured value 23 g/sq cm . More substantiating evidence is still required but these results are of the right order.

As refinements are developed in measuring pressures and suctions associated with ice-lensing in porous material, a reliable value for σ_{iw} and how it is influenced by temperature and foreign matter will be of great assistance. At present, values from 10 to 45 erg/sq cm may be found in the literature. The difference between ice-water and air-water interfacial energy accounts for the lower pressure pore entry by ice, provided that the temperature is consistent with (2).

Finally, a point by Everett [8] should be stressed regarding the difference in pressure exerted by an ice-lens and that of an ice crystal confined in a pore. The value for $1/r$ in the equations above should be replaced by $1/r - 1/R$ where r is the radius of the constriction leading from the pore and R the largest radius of the pore. After the lens is established, R is large and the term $1/R$ may be neglected. Thus, the potential heaving pressures are always greater after the lens has formed—a point to remember in the study of deterioration of porous solids by frost action, which must break in tension before an ice lens can be established.

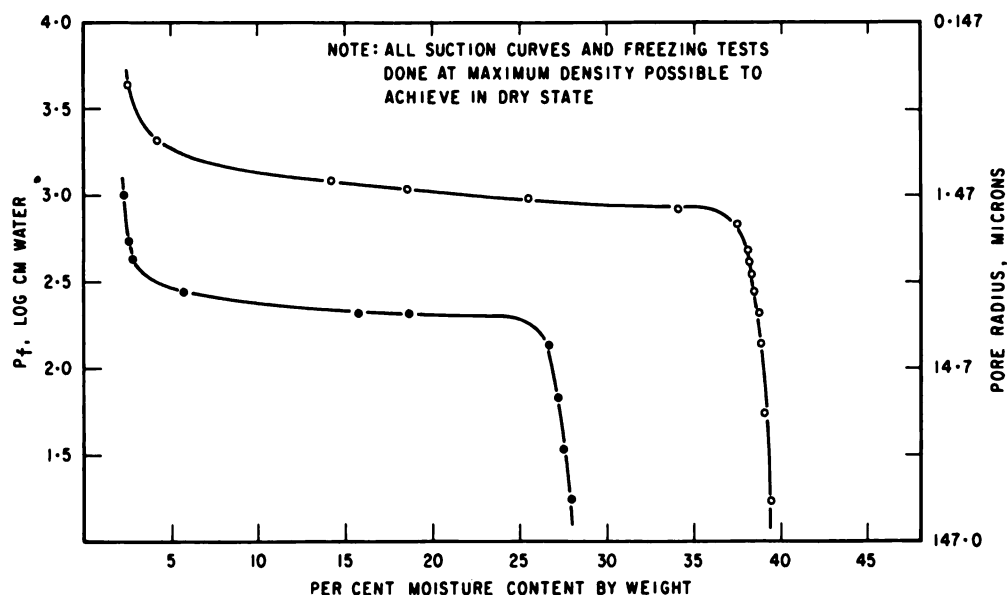

Fig. 9. Moisture release curves to determine the predominant pore radius of two fractions from Potter's flint

ACKNOWLEDGMENT

The author has been granted permission by the publishers to reprint figures (figure numbers belong to this article) from his previous articles. Figure sources are given below or keyed to the appropriate reference: Figs. 1 and 2 [3]; Fig. 3, Highway Research Board Bull. 287, p. 1, 1961; Fig. 4 [7]; Fig. 7 [11]; Fig. 8 [14].

REFERENCES

- [1] S. Taber. "Frost Heaving," J. Geol., Vol. 37, No. 5, 1924, pp. 428-461.
- [2] G. Beskow. Soil Freezing and Frost Heaving with Special Application to Roads and Railroads, 1935, Transl. J. O. Osterberg, Tech. Inst., Northwestern Univ., 1947.
- [3] E. Penner. "Ice-Grain Structure and Crystal Orientation in an Ice Lens from Leda Clay," Geol. Soc. Am. Bull., Vol. 72, No. 10, 1961, pp. 1575-1577.
- [4] W. B. Hillig. "The Kinetics of Freezing of Ice in the Direction Perpendicular to the Basal Plane," Proc. Intl. Conf. Crystal Growth, Cooperstown, N.Y., Aug. 1958, pp. 350-360.
- [5] F. G. J. Perey, E. R. Pounder. "Crystal Orientation in Ice Sheets," Can. J. Phys., Vol. 36, 1958, pp. 494-502.
- [6] W. Czeratzki, H. Frese. "Importance of Water in Formation of Soil Structure," Highway Res. Bd. Special Publ. 40, 1958, pp. 200-211.
- [7] E. Penner. "The Nature of Frost Action," Proc. Canadian Good Roads Assoc., 1957, pp. 234-243.
- [8] D. H. Everett. "The Thermodynamics of Frost Damage to Porous Solids," Trans. Faraday Soc., Sept. 1961, pp. 1541-1551.
- [9] C. W. Lovell. "Temperature Effects on Phase Composition and Strength of Partially Frozen Soil," Highway Res. Bd. Bull. 168, 1957, pp. 74-96.
- [10] G. Tammann, A. Büchner. "Die Lineare Kristallisationen—geschwindigkeit des Eises aus gewöhnlichem und schwerem Wasser," Zeit Anorg. Allgem. Chem., Band 222, 1935, pp. 12-16.
- [11] E. Penner, P. Robillard. "The Use of Waste Sulphite Liquor to Reduce Frost Heaving in Soils," Trans. Engr. Inst. Canada, Vol. 3, No. 4, Dec. 1959, pp. 107-109.
- [12] E. Penner, P. Robillard. "Ice Propagation Rates in Fractions of Sulphite Spent Liquor," Pulp and Paper Mag. Canada, Feb. 1961, pp. 2-4.
- [13] B. Chalmers, K. A. Jackson, G. T. Orrok, C. S. Lindenmeyer. "Rate of Growth of Ice Crystals in Super-cooled Water," J. Chem. Phys., Vol. 27, No. 3, Sept. 1957, p. 882.
- [14] E. Penner. "The Importance of Freezing Rate in Frost Action in Soils," Proc. Am. Soc. Testing Mat., Vol. 60, 1960, pp. 1151-1165.
- [15] E. Penner. "Thermal Conductivity of Saturated Leda Clay," Géotechnique, Vol. 1, June 1962, pp. 168-175.
- [16] E. Penner. "Alternate Freezing and Thawing Not a Requirement for Frost Heaving in Soils," Can. J. Soil Sci., Vol. 41, Aug. 1961, pp. 160-163.
- [17] L. W. Gold. "A Possible Force Mechanism Associated with the Freezing of Water in Porous Materials," Highway Res. Bd. Bull. 68, 1957, pp. 65-72.
- [18] K. A. Jackson, B. Chalmers. "Freezing of Liquids in Porous Media with Special Reference to Frost Heave in Soils," J. Appl. Phys., Vol. 24, No. 8, 1958, pp. 1178-1181.
- [19] E. Penner. "Soil Moisture Tension and Ice Segregation," Highway Res. Bd. Bull. 168, 1958, pp. 50-63.
- [20] E. Penner. "Pressures Developed in a Porous Granular System as a Result of Ice Segregation," Highway Res. Bd. Special Rept. 40, 1959, pp. 191-199.
- [21] E. Penner. "The Mechanism of Frost Heaving in Soils," Highway Res. Bd. Bull. 225, 1959, pp. 1-22.
- [22] R. C. Sill, A. D. Skapski. "Method for the Determination of the Surface Tension of Solids from their Melting Point in Thin Wedges," J. Chem. Phys., Vol. 24, No. 4, 1956, pp. 644-651.

This paper is a contribution from the Div. Bldg. Res., Natl. Res. Coun., Canada, and is published with the approval of the Director of the Division.

FUNDAMENTALS OF THE THEORY OF FROST-HEAVING

SHUNSUKE TAKAGI, U. S. Army Cold Regions Research and Engineering Laboratory

Earlier researchers of frost-heaving [1, 2] have shown that the cause of frost-heaving is the formation of ice-lenses in the soil and that a thin water layer must exist between soil particles and ice so that the ice-lens may be segregated from the soil. Existence of a thin water layer between soil particles and ice is not yet confirmed by experiment, but at present its existence is still strongly believed.

Theoretical problems following from these earlier findings are: (a) How and why does the thin water layer between soil particles and ice segregate ice-lenses from soils? (b) Where does the energy of heaving the weight on the ice-lens come from? (c) How is the pressure gradient that sucks water through accumulated soils to the freezing front set up?

Jackson and Chalmers [3] and Martin [4] have proposed that the supercooling of water is the energy source. However, their view conflicts with the generally understood fact that if a piece of ice exists in the water system the metastable state of supercooled water ceases and a stable freezing process is realized. The difference between supercooling and freezing-point depression is discussed in detail elsewhere [5].

According to classical (equilibrium) thermodynamics, the Gibbs' free energy of water is maintained at the same value during the phase change. Therefore, the work of frost-heaving cannot be provided if the whole system is at the temperature of stable freezing. This fact, however, does not necessarily lead to the introduction of supercooling as the energy source of frost-heaving. As explained later, if irreversible (or non-equilibrium) thermodynamics is used instead of classical equilibrium thermodynamics, on the presumption that the temperature and pressure gradients in the water must be considered, it is shown without difficulty that the energy source is the so-called latent heat, or, more exactly, the energy released when liquid water becomes ice.

Cass and Miller [6] have suggested that the electric double layer surrounding soil particles will explain the function of the thin water layer between soil particles and ice. However, as explained in this paper, the thin water layer exists as a result of adsorption by both soil particles and ice, even though solutes may not exist in the system. The electric double layer does not necessarily represent the actual physical situations, but is nothing more than a model to understand the mechanics of frost-heaving.

Gold [7] and Everett [8] have used the classical equilibrium thermodynamics to calculate the pressure of ice necessary to propagate ice through the pores of the soil. However, if the temperature gradient is neglected to validate the use of classical equilibrium thermodynamics, it will be almost impossible to show the effect of the temperature gradient on frost heaving [9]. It is obvious that the reasonable approach to the problem is the use of irreversible (nonequilibrium) thermodynamics instead of the classical equilibrium thermodynamics.

Ruckli developed a frost-penetration equation [10, 11], and Jumikis [12] solved it. Their approach, however, is rather empirical. An important role that is imposed on theoretical research at this stage is to provide the empirical studies with a deeper insight into the phenomena of frost-heaving.

FUNDAMENTAL PHYSICAL PROCESS OF FROST-HEAVING

Corte [13] indicated a physical phenomenon that is fundamentally important for frost-heaving. A box was filled with water (Fig. 1). The top of the box was kept warmer than 0°C while the bottom was colder than 0°C so that ice grew upward. Particles ranging in size from 0.1 to ~ 2.9 mm were placed at the surface of the ice. It was found that some of the particles

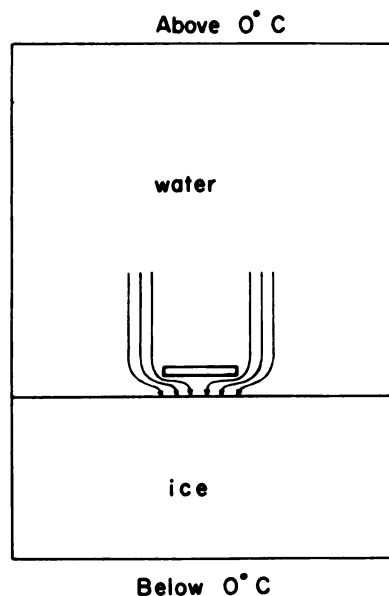

Fig. 1. Corte's experiment

were carried at the growing surface of the ice. The contact area and the rate of growth of the ice were considered as the important factors for selecting carried particles. For simplicity, the ice surface in Fig. 1 is assumed to be a horizontal plane even immediately below the floating particle.

It is recognized that a thin water film must exist between a particle and the growing surface of the ice. The thin water film is supposed to have a definite thickness determined by the chemical composition and molecular structure of the particle's surface, the temperature and temperature gradient, and probably some other unknown factors. This definite thickness must be maintained even though a part of the thin layer immediately above the ice may be frozen to ice. Thus, the thin water film is always replenished by water that comes downward circumventing the particle and becomes ice immediately beneath the particle. The existence of this thin water film has not yet been experimentally verified, but it must be assumed in order to explain the fact that a particle can stay at the growing surface of the ice without being engulfed by it.

This thin water film has an extraordinary property. Since the weight of the particle is sustained by the thin water film, it has a resistance against shearing force. Therefore Pascal's principle for hydrostatic pressure does not apply to this thin water film. This view may be supported by the following quotation from Henniker [14, p. 333]:

Deryagin [15, 16] showed directly that water is rigid in thin layers near surfaces of solids. He measured the modulus of rigidity of water in layers up to 1500 Å thick between a convex lens and a flat surface. The modulus was calculated from the damping of torsional oscillations of the convex lens. These experiments showed that films 350 Å thick had the rigidity of metallic lead, Deryagin [17].

In measuring the distance between a quartz lens and a quartz plate by means of Newton's rings, Eversole and Lahr [18] showed that a layer of rigid water existed, which supported the weight of the disk. This was based on the observation of a shift of 100 Å when water was introduced between the quartz faces. They considered that

the effect could not be due to osmotic pressure since the presence of ions in the water had no effect on film thickness. Elton [19] repeated the experiments, but concluded that any stable film must be less than 25 Å thick.

Terzaghi [20] allowed water to evaporate from between glass plates and found that evaporation stopped when the plates were 1000 Å apart. This indicated that the force in the liquid extended to at least 500 Å.

A theoretical basis for understanding this extraordinary property of the adsorbed water is explained as follows: The simplest boundary between two substances is the surface layer between air and a liquid. The rapid molecular motion in the air permits the assumption that the air is homogeneous up to the interface. In the liquid side of the interface, a heterogeneous surface layer exists. The degree of heterogeneity is greatest at the interface, gradually decreases inward, and disappears when the homogeneous free liquid is reached at a certain depth, which may be called the depth of the surface layer. The change of heterogeneity with depth in the surface layer may be expressed in terms of mechanics (Fig. 2). According to a principle of mechanics, the force on one side of a boundary is equal to the force on the other side of the boundary. Therefore, the components of stress referred to planes parallel to the boundary change continuously when the point to which the stress is referred crosses the boundary. However, the components of stress referred to planes normal to the boundary may not change continuously when the point to which the stress is referred crosses the boundary.

In Fig. 2 the force p on AA in the air side is equal to p on DD in the water side. However, according to the theory of surface tension [21], p on AB in the air side is not equal to the normal stress on CD in the water side. The pressure on CD is smaller than p , say by Δp . The difference, Δp , becomes smaller as the point under consideration goes downward, and disappears inside the homogeneous free liquid. The integration of Δp over the depth of the surface layer yields the surface tension [21]. Therefore, Pascal's principle for hydrostatic pressure does not apply to the heterogeneous liquid in the boundary layer between air and homogeneous free liquid.

The heterogeneity in the surface layer is a result of the preferential orientation of liquid molecules. In the homogeneous free liquid, the force on the molecules is uniform in all directions, and the molecules are randomly oriented. However the force pulling molecules at the surface layer into the liquid has a different value from the force pulling molecules parallel to the boundary, and the molecules in the surface layer are oriented. Therefore, a non-Pascalian state of stress must be expected in every surface layer where surface tension comes into play, not only on the liquid side of an air-liquid interface

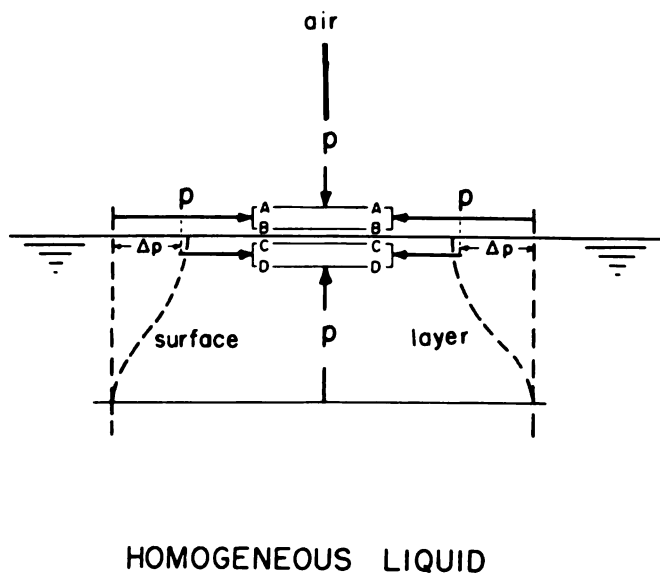

Fig. 2. Pressure deficiency in the surface layer

but also on the liquid side of a liquid-solid interface.

It is supposed that, even though soil particles do not exist, a thin water layer remains on the surface of ice, although its existence is not directly shown by experimentation [22 to 27]. The thin water layer between soil particles and ice exists as a result of adsorption, or molecular force distortion, on the surface of both the soil particles and ice.

ENERGETICS OF FROST-HEAVING

First, only the essential factors for frost-heaving will be considered. From the theoretical standpoint in this paper, the existence of soils is not essential for frost-heaving. The function of soils in frost-heaving are as follows: (1) At the freezing front, the thin layer of water that exists between soil particles and ice segregates another layer of ice. (2) The body of ice accumulated in this way above the thin layer of water is pushed upward by the successive segregation of ice from the thin layer of water. The soil beneath the thin layer of water sustains the weight of the body of ice plus the weight of soil above the ice and the weight of overburden, if any, on the ground. (3) Water percolates through pores to the freezing front.

For our mathematical analysis, consider a segment of the freezing system, as represented in Fig. 3. Suppose there exists a thin layer of soil on the fixed plane BB, which can sustain as heavy a weight as we like. The thin layer of water just above the thin layer of soil on plane BB will segregate ice if there is an appropriate supply of water from below and of cooling from above. Plane AA is at a temperature $< 0^\circ\text{C}$, space AA-BB is filled with ice, and plane CC is in water at a temperature $> 0^\circ\text{C}$ and at a pressure sufficient to keep water in space CC-BB moving upward to replace the water that in freezing moves across the fixed plane BB. Thus, the functions (2) and (3) are fulfilled without the existence of bulk soil. The function (1) performed by the thin layer of soil on plane BB may be considered as a property of the geometric plane BB. In other words, we may suppose that it is at the geometric plane BB that water from below is frozen to ice, which is successively pushed upwards.

Summarizing the results thus far, the essential factors for frost-heaving are (1) the existence of a segregating agent with the faculty of sustaining weight, (2) a water supply, and (3) a temperature gradient with adequately low temperature at the top and adequately high temperature at the bottom. All other factors related to frost-heaving are not essential because, theoretically, frost-heaving can take place without them. However, none of the three essential factors mentioned above can be neglected. If even one of them is neglected, frost-

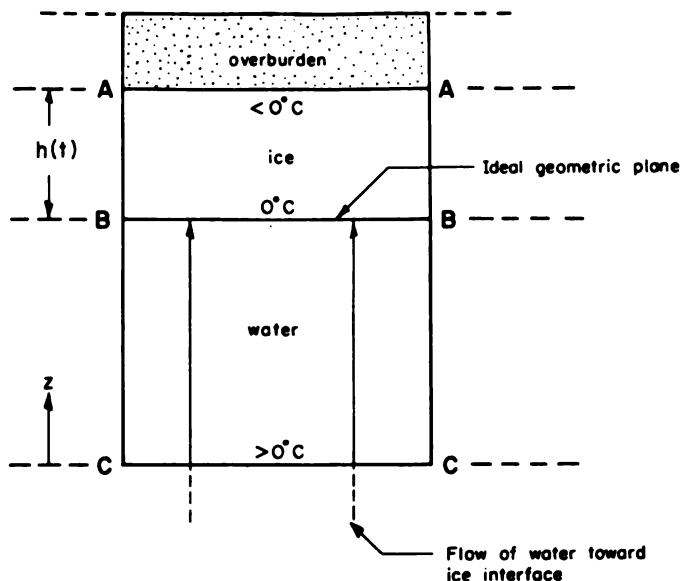

Fig. 3. Simple frost-heaving

heaving cannot take place. Therefore, instead of the classical thermodynamics where only the equithermal process is considered, the irreversible (or nonequilibrium) thermodynamics [28, 29, 30] must be used to understand the essential process in frost-heaving.

Use of the classical equilibrium thermodynamics can explain only nonessential secondary effects of frost-heaving. Even though the temperature gradient is small, it cannot be neglected to validate the use of equilibrium thermodynamics to obtain the explanation of the essential physical process of frost-heaving. This situation may be explained in another way by the following example from mathematics: When we are concerned with the measurement of length of lines, an infinitely short line segment must not be identified with a point. An infinitely short line is still a one-dimensional entity. Connection of a finite number of points cannot form a line segment however short it may be.

It is interesting that, since the ice surface in Fig. 1 (Corte's experiment) is assumed to be a horizontal plane even immediately below the floating particle, the freezing point of the thin water layer between the floating particle and the ice in Fig. 1 is 0°C. If the ice surface just below the floating particle is concave, the freezing point of the thin water layer with concave form is lower than 0°C. But this effect is still a nonessential secondary complication.

The differential equations governing the simple frost-heaving in Fig. 3 are easily formulated. The equation of continuity of water between planes BB and CC is

$$\frac{\partial \rho_w}{\partial t} = - \frac{\partial \rho_w v}{\partial z} \quad (1)$$

where ρ_w is the density of water, v the velocity of water flow, t the time, and z the coordinate directed upward. The density (ρ_w) is a function of pressure (p) and temperature (θ_w) of the water. To simplify the analysis, ρ_w is assumed to be constant. Therefore, convection does not take place. Then (1) becomes

$$\frac{\partial v}{\partial z} = 0 \quad (2)$$

Therefore, v is a function of t only

$$v = v(t) \quad (3)$$

The equation of motion of water between planes BB and CC is

$$-\rho_w g - \frac{\partial p}{\partial z} = \rho_w \left(\frac{\partial v}{\partial t} + v \frac{\partial v}{\partial z} \right) \quad (4)$$

where g is the acceleration of gravity. Use of (2) changes (4) to

$$\frac{\partial v}{\partial t} + \frac{1}{\rho_w} \frac{\partial p}{\partial z} + g = 0 \quad (5)$$

The equation for the balance of energy is

$$\rho_w \frac{du}{dt} = -p \frac{\partial v}{\partial z} - \frac{\partial J_q}{\partial z} \quad (6)$$

where u is the internal energy per unit mass of water, d/dt is the operator called the substantial time derivative [29, p. 95] defined by

$$\frac{du}{dt} = \frac{\partial u}{\partial t} + v \frac{\partial u}{\partial z} \quad (7)$$

and J_q is the flow of heat

$$J_q = -k_w \frac{\partial \theta_w}{\partial z} \quad (8)$$

in which θ_w is the temperature of water and k_w is the heat conductivity of water. By use of (2), (7), and (8), (6) becomes

$$\frac{\partial u}{\partial t} + v \frac{\partial u}{\partial z} = \frac{k_w}{\rho_w} \frac{\partial^2 \theta_w}{\partial z^2} \quad (9)$$

where k_w is assumed to be constant for simplicity. The internal energy (u) may be assumed to be a linear function of θ_w

$$u = u_0 + c\theta_w \quad (10)$$

with constant (c). Then (9) becomes

$$\frac{\partial \theta_w}{\partial t} + v \frac{\partial \theta_w}{\partial z} = \alpha_w \frac{\partial^2 \theta_w}{\partial z^2} \quad (11)$$

where α_w is the thermal diffusivity of water defined by $\alpha_w = k_w / \rho_w c$. The substantial time derivative of θ_w appears at the left-hand side of (11), because the point under consideration moves at velocity (v). In the theory of heat conduction, (11) is called the equation of heat conduction in a moving medium [31, p. 218]. However, the boundary value problem of this type of equation is not yet solved.

The ice that is located above plane BB moves upward as a whole at the velocity at which ice is formed on plane BB. Let $h(t)$ be the thickness of the ice. Then

$$\rho_i \frac{dh}{dt} = \rho_w v \quad (12)$$

where ρ_i is the density of ice. Heat conduction in this moving body of ice is governed by the equation

$$\frac{\partial \theta_i}{\partial t} + h(t) \frac{\partial \theta_i}{\partial z} = \alpha_i \frac{\partial^2 \theta_i}{\partial z^2} \quad (13)$$

where θ_i is the temperature of ice and α_i is the thermal diffusivity of ice, and $h(t)$ is the abbreviation of dh/dt . The requirement that the entropy production must be positive at any place and at any time is satisfied by the assumption that the temperature in Fig. 3 is decreasing upward.

Besides the boundary conditions of temperature that

$$\theta_i = \text{const.} < 0^\circ \text{C at AA} \quad (14)$$

$$\theta_i = \theta_w = 0^\circ \text{C at BB} \quad (15)$$

and

$$\theta_w = \text{const.} > 0^\circ \text{C at CC} \quad (16)$$

there is an equation for energy balance at the boundary BB. The energy that remains at BB as a balance of the energy coming from below and the energy going upward is equal to the work done at BB to push up the weight on BB. Let dh be the increase of h during the time interval (dt). Then

$$\left[-k_w \left(\frac{\partial \theta_w}{\partial z} \right)_B + k_i \left(\frac{\partial \theta_i}{\partial z} \right)_B \right] dt + \rho_w (v u_w) dt - \rho_i (u_i dh) = (\rho_i gh + w) dh$$

where k_i is heat conductivity of ice and w is the weight of overburden per unit area. Then, dividing dt and using (12), we have

$$-k_w \left(\frac{\partial \theta_w}{\partial z} \right)_B + k_i \left(\frac{\partial \theta_i}{\partial z} \right)_B + \rho_i \frac{dh}{dt} (u_w - u_i) = (\rho_i gh + w) \frac{dh}{dt} \quad (17)$$

From thermodynamics,

$$\left(u_w + \frac{p_0}{\rho_w} \right) - \left(u_i + \frac{p_0}{\rho_i} \right) = L \quad (18)$$

where u_i is internal energy per unit mass of ice and L is the latent heat and p_0 is the pressure at BB (Fig. 3).

By use of (18), (17) changes to

$$-k_w \left(\frac{\partial \theta_w}{\partial z} \right)_B + k_i \left(\frac{\partial \theta_i}{\partial z} \right)_B = \frac{dh}{dt} \left[(\rho_i gh + w) - \rho_i (u_w - u_i) \right] = \frac{dh}{dt} \left[\rho_i gh + w - \rho_i \left(L - \frac{p_0}{\rho_w} + \frac{p_0}{\rho_i} \right) \right]$$

Therefore using a constant (\bar{h}) defined by

$$\rho_1 g \bar{h} = \rho_1 \left(L - \frac{P_0}{\rho_w} + \frac{P_0}{\rho_1} \right) - w \quad (19)$$

we have

$$-k_w \left(\frac{\partial \theta_w}{\partial z} \right)_B + k_1 \left(\frac{\partial \theta_1}{\partial z} \right)_B = \rho_1 g (h - \bar{h}) \frac{dh}{dt} \quad (20)$$

Equation (20) may be written

$$-k_w \left(\frac{\partial \theta_w}{\partial z} \right)_B + k_1 \left(\frac{\partial \theta_1}{\partial z} \right)_B = \rho_w g (h - \bar{h}) v \quad (21)$$

by use of (12).

Differential equations (11) and (13) must be solved under the boundary conditions of (14), (15), (16), (20), and (21). Then the pressure of water necessary to keep water flowing is determined by (5). However, because of the mathematical difficulties involved in this boundary value problem, the solution is not yet obtained.

Although the solution is not yet obtained, the analysis shown above has very interesting implications. First, the latent heat L is included together with work terms, such as $\rho_1 g \bar{h}$, w , etc. Then it is evident that the latent heat, or more exactly, the energy released when water becomes ice, is the source of work in frost-heaving.

This fact may be directly shown from Fig. 4. In a certain time interval (dt), the thickness (dh_w) of water is frozen to form the thickness (dh_i) of ice. Then

$$\rho_w dh_w = \rho_1 dh_i \quad (22)$$

The thickness (dh_w and dh_i) are assumed to be infinitesimal to simplify our analysis. Temperatures at AA, B₁B₁, B₂B₂, and CC are constant. Therefore, the temperature gradients at B₁B₁ and B₂B₂ are different. However, since dh_i is infinitesimal, we may assume that the temperature gradients are the same for both cases. Then, the only difference in the two cases in Fig. 4 is the thickness of ice. Therefore the energy released in the change is calculated

$$\begin{aligned} \rho_w u_w dh_w - \rho_1 u_1 dh_i &= \rho_w dh_w (u_w - u_1) \\ &= \rho_w dh_w \left(L - \frac{P_0}{\rho_w} + \frac{P_0}{\rho_1} \right) \end{aligned}$$

where use is made of (22) and (18).

Correctly speaking, we are not considering the latent heat (L) mentioned above as the energy source of frost-heaving. The energy source of frost-heaving is the energy released during the phase change. A part of this energy is given out as work in accordance with the circumstances, and the remaining part is lost as heat. If the expansion of water to ice against atmospheric pressure is the only work necessary for the change of phase, the latter is the latent heat (L), as is clearly shown by a transformation of (18)

$$u_w - u_1 = P_0 \left(\frac{1}{\rho_1} - \frac{1}{\rho_w} \right) + L$$

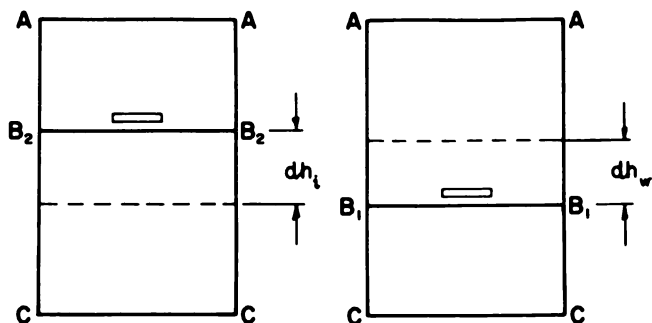

Fig. 4. An explanation of the energy source for frost heaving

If other work is necessary for the change of phase, the portion for work will increase and the portion for heat will decrease. It is quite impressive to realize that if 80 cal of energy were completely given out as work, it will heave a 34.2 km of water column by 1 cm.

In nature the situation is much more complicated than the simple frost-heaving introduced herein. For instance, water flows through pores among soil particles. At the same time heat also flows. If the soil is not saturated with water, air flow is also taking place. Such a complicated flow as described above cannot be formulated with present knowledge. If this complicated flow is formulated in the future, replace (1) and (4) with the new equations thus formulated. Then we can have a more practical solution. At present, the simple frost-heaving introduced is the only one that can be analyzed exactly. The simple frost-heaving introduced must be solved so that the effective empirical approach can be indicated.

An objective of the analysis of the boundary value problem formulated above is to determine under what conditions the solution does exist. If the solution is obtained, the percentage of L which changes to work can be determined. This release of energy during phase change in simple frost-heaving is the most efficient possible for frost-heaving, because all the resistances are eliminated in this analysis. Every complication that must be introduced to get a more practical solution will add some kind of resistance and will decrease the efficiency.

It must also be pointed out that, without knowledge of the properties of the thin water layer between soil particles and ice, even the solution of the more practical formulations obtained by introducing the existence of soils into the simple frost-heaving will not give perfect knowledge of frost-heaving. The mathematical study proposed herein will provide a framework that must be substantiated by the knowledge of the thin water film and of some other complications that will be introduced when soils are introduced into the simple frost-heaving considered. When these tasks are all achieved, we shall have perfect understanding of frost-heaving.

REFERENCES

- [1] S. Taber. "The Mechanics of Frost Heaving," *J. Geol.*, Vol. 38, 1930, pp. 303-319.
- [2] G. Beskow. *Soil Freezing and Frost Heaving with Special Application to Roads and Railroads*, (Swedish Geol. Soc., 1935) transl. by J. O. Osterberg, publ. by the Tech. Inst., Northwestern Univ.
- [3] K. A. Jackson, B. Chalmers. "Freezing of Liquids in Porous Media with Special Reference to Frost Heave in Soils," *J. Appl. Phys.*, Vol. 29, 1958, pp. 1178-1181.
- [4] R. T. Martin. "Rhythmic Ice Banding in Soil," *Highway Res. Bd. Bull.*, Vol. 218, 1959, pp. 11-23.
- [5] S. Takagi. "Theory of Equilibrium Freezing with Special Reference to Soil Water" (in this volume).
- [6] L. A. Cass, R. D. Miller. *Role of the Electric Double Layer in the Mechanism of Frost Heaving*, U. S. Army SIPRE Res. Rept. 49, 1959.
- [7] L. W. Gold. "A Possible Force Mechanism Associated with the Freezing of Water in Porous Materials," *Highway Res. Bd. Bull.*, Vol. 168, 1957, pp. 65-73.
- [8] D. H. Everett. "Thermodynamics of Frost Damage to Porous Solids," *Trans. Faraday Soc.*, 1961, pp. 1541-1551.
- [9] E. Penner. "The Importance of Freezing Rate in Frost Action in Soils," *Proc. ASTM*, Vol. 60, 1960, pp. 1151-1165.
- [10] R. Ruckli. *Der Frost im Baugrund*, Springer Verlag, Vienna, 1950.
- [11] A. R. Jumikis. *The Frost Penetration Problem in Highway Engineering*, Rutgers Univ. Press, 1955.
- [12] A. R. Jumikis. "The Method of Solution of Ruckli's Frost-Penetration Equation," *Trans. Am. Geophys. Union*, Vol. 37, 1956, pp. 181-184.

[13] A. E. Corte. "Vertical Migration of Particles in Front of a Moving Freezing Plane," J. Geophys. Research, Vol. 67, 1962, pp. 1085-1090.

[14] J. C. Henniker. "The Depth of the Surface Zone of a Liquid," Rev. Mod. Phys., Vol. 21, 1949, pp. 322-341.

[15] B. V. Deryagin. "Die Formelastizitat der dunnen Wasserschichten," Zeitscher. Physik, Vol. 84, 1933, pp. 657-670.

[16] B. V. Deryagin. "Mechanical Properties of Thin Layers of Liquids," Physik. Zeitschr. Sowjetunion, Vol. 4, 1933, pp. 431-432.

[17] B. V. Deryagin. "Range of Action of Surface Forces," Nature, Vol. 183, 1936, pp. 330-331.

[18] W. G. Eversole, P. H. Lahr. "The Thickness of the Rigid Water Film at a Quartz-water Interface from a Measurement of Newton's Rings," J. Chem. Phys., Vol. 9, 1941, pp. 686-689.

[19] G. A. H. Elton. "Electroviscosity: 1. The flow of Liquids between Surfaces in Close Proximity," Proc. Roy. Soc., London, Vol. A194, 1948, pp. 259-274.

[20] C. Terzaghi. "New Facts about Surface-Friction," Phys. Rev. (2) Vol. 16, 1920, pp. 54-61.

[21] A. Harasima. "Molecular Theory of Surface Tension," Advances in Chem. Phys., Vol. 1, 1958, pp. 203-237.

[22] W. A. Weyl. "Surface Structure of Water and Some of Its Physical and Chemical Manifestations," J. Colloid Sci., Vol. 6, 1951, pp. 389-405.

[23] U. Nakaya, A. Matsumoto. "Simple Experiment Showing the Existence of Liquid Water Film on the Ice Surfaces," ibid., Vol. 9, 1954, pp. 41-49.

[24] C. L. Hosler, D. C. Jensen, L. Goldshlak. "On the Aggregation of Ice Crystals to Form Snow," J. Meteorology, Vol. 14, 1957, pp. 415-420.

[25] H. H. G. Jellinek. "Adhesive Properties of Ice," U.S. Army SIPRE Res. Rept. 38, 1957.

[26] H. H. G. Jellinek. "Adhesive Properties of Ice," Part 2, U.S. Army SIPRE Res. Rept. 62, 1960.

[27] N. H. Fletcher. "Surface Structure of Water and Ice," Phil. Mag., Vol. 7, 1962, pp. 255-269.

[28] I. Prigogine. Introduction to Thermodynamics of Irreversible Processes, Interscience, 1961.

[29] S. R. DeGroot. Thermodynamics of Irreversible Processes, Interscience, 1951.

[30] S. R. DeGroot, P. Mazur. Non-equilibrium Thermodynamics, Interscience, 1962.

[31] H. Bateman. Partial Differential Equations of Physics, Dover, 1932.

DISCUSSIONS

(A) A. ASSUR—Takagi's theory of frost-heaving is consistent in itself, but incorporates tacitly an assumption which makes it quite different from actual frost-heaving in the ground. Takagi's (18) clearly implies that the pressure to which the ice is subjected is the same as the hydrostatic pressure of water before it is transformed into ice. This is equivalent to the assumption that the ice and overburden in Takagi's Fig. 3 is directly supported by the water. Actually, it is supported by the hydrostatic water pressure and the intergranular pressure (p_g). Under the simplifying assumption that the ice is under the hydrostatic pressure

$$p_i = w + \rho_i gh \tag{A.1}$$

we may write (Assur, 1963)

$$p_g = p_i - p_o = w + \rho_i gh - p_o \tag{A.2}$$

We assume that atmospheric pressure acts both on the overburden (or ice) and the water and cancels; therefore, in (A.2), p_o is the excess over atmospheric pressure.

As soon as (A.2) is introduced, Takagi's (21) simplifies considerably.

We obtain instead of his (19)

$$\rho_i gh^* = \rho_i L - \frac{\rho_i p_o}{\rho_w} + \rho_i gh - w \tag{A.3}$$

$$h^* = \frac{L}{g} - \frac{p_o}{g \rho_w} + h \tag{A.4}$$

$$h - h^* = -L + \frac{p_o}{\rho_w} \tag{A.5}$$

Abbreviating

$$\Delta Q = K_w \left(\frac{\partial \theta_w}{\partial z} \right)_B - K_i \left(\frac{\partial \theta_i}{\partial z} \right)_B \tag{A.6}$$

and substituting into Takagi's (21)

$$\Delta Q = \rho_w v \left(L - \frac{p_o}{\rho_w} \right) \tag{A.7}$$

$$\text{or } \rho_i \frac{dh}{dt} = \frac{\Delta Q}{L - \frac{p_o}{\rho_w}} \tag{A.8}$$

p_o/ρ_w , however, is very small compared with L.

Using the meter-kg-sec system, the latent heat for normal ice is $\approx 360,000$ erg/kg. Assuming the high value of 2 atmos or roughly 20×10^4 dyn/sq m for p_o , p_o/ρ_w becomes 20 erg/kg which is negligibly small compared with L. Equation (A.8) then reduces to

$$\rho_i \frac{dh}{dt} = \frac{\Delta Q}{L} \tag{A.9}$$

which is self-evident.

We should, however, consider Anderson's discussion in this volume which shows that the latent heat of ice freezing in soil may be considerably smaller than its customary value.

In using (A.8) or (A.9) we should consider that the mass flow of water ($\rho_w v$) equal to the left side of the equations will cease if the soil under the ice-lens will dry out. The formation of the ice-lens slows down initially, and finally frost penetration occurs instead of ice-lens formation. It should be noted that water saturation rather than density should be used in Takagi's continuity equation (1) which for real soil is not constant because of desiccation.

Takagi's differential equation reduces to a simple expression if the intergranular pressure at the plane BB is considered. His model, however, which ignores this pressure has at least an academic interest in its own right. With the original model as such, some further conclusions based on it are discussed.

Takagi correctly states that mathematical difficulties are involved in solving his basic differential equation (21) with the boundary conditions as stated. Under certain assumptions, however, simple solutions can be obtained for specific cases. Equation (A.6) gives the difference in heat flow conducted away in the ice and the heat flow supplied by conduction through the water. This effective heat loss is assumed to be constant. The ice equivalent of the overburden is

$$w^* = \frac{w}{\rho_i g} \tag{A.10a}$$

$$\text{and } L^* = L + \frac{p_o}{\rho_i} - \frac{p_o}{\rho_w} \tag{A.10b}$$

is the latent heat adjusted for the internal energy required in expanding water to ice under the pressure (p_o). The following expression results for the mass flow of water toward the freezing interface

$$\rho_w v = \frac{\Delta Q}{L^* - g(h + w^*)} \tag{A.11}$$

which simply states that the mass flow of water toward the freezing interface is equal to the heat loss divided by the latent heat adjusted for the internal energy required for expansion during the change of state and to lift ice (h) and overburden (w). Equation (A.11) has interesting implications. Theoretically, $(h + w^*)$ could be sufficiently large to make $\rho_w v = \infty$. The demand for water would be infinite.

If the ice-lens is small and the overburden high, (A.11) leads to

$$h = \frac{\Delta Q}{\rho_1 L^* - w/g} t \quad (\text{A.12})$$

If the overburden is small (near the surface) and the ice-lens thick, h cannot be disregarded versus w^* , although both can be possibly disregarded versus L^*/g . Equation (A.11) can be written as

$$\rho_1 g h \frac{dh}{dt} - \rho_1 (L^* - gw^*) \frac{dh}{dt} + \Delta Q = 0 \quad (\text{A.13})$$

Separation of variables yields upon integration

$$h = \left(\frac{L^*}{g} - w^* \right) - \sqrt{\left(\frac{L^*}{g} - w^* \right)^2 - \frac{2\Delta Q}{\rho_1 g} t} \quad (\text{A.14})$$

The choice of a minus sign between the terms is determined by the condition $h = 0$ for $t = 0$.

The temperature regime required to maintain $\Delta Q = \text{const}$ can now be calculated theoretically. It is interesting that $h = f(t)$ should be very nearly linear if

$$\frac{2\Delta Q t}{\rho_1 g} \ll \left(\frac{L^*}{g} - w^* \right)^2 \quad (\text{A.15})$$

By taking the derivative (dh/dt) of (A.14) and setting the left side of (A.16) to zero, we obtain the linear (A.12).

Equation (A.14) can be expressed in a nondimensional way as

$$\frac{h}{L^*/g - w^*} = 1 - \sqrt{1 - \frac{2}{\rho_1 L^* - w/g} \Delta Q t} \quad (\text{A.16})$$

where is shown in Fig. A.1.

In order to maintain a sense of proportion, it is necessary to develop a feeling for the magnitudes involved. Using the MKS system and assuming that p_0 is 2 atmos, we obtain in (A.10b)

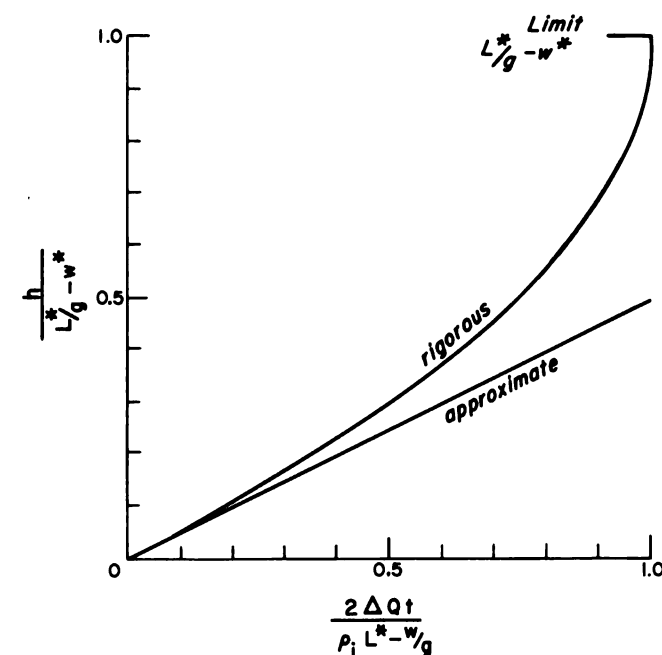

Fig. A.1. Approximate versus rigorous solution of Takagi's equation (assuming constant heat loss)

$$\frac{p_0}{\rho_1} \left(1 - \frac{\rho_1}{\rho_w} \right) \ll L \quad (\text{A.17})$$

18 erg/kg versus 360,000 erg/kg, which can be safely ignored.

The overburden (w) may be of the order

$$w = 2 \times 10^3 \text{ kg/m}^2 \approx 2 \times 10^4 \text{ dyne/m}^2$$

which can be safely ignored versus $\rho_1 g h^* \approx 3.3 \times 10^8$ in Takagi's (19). This leads to $h^* \approx 37,000$ m. The ice-lens may be as thick as 10 cm. This compared with 37 km could be ignored. Returning now to Takagi's (20) and ignoring small magnitudes, we obtain again the self-evident (A.9) as above.

Fig. A.1 shows the deviation of the exact solution from an approximate one. Since h is divided by roughly 37 km, the rigorous solution is irrelevant although correct for the model assumed. The model itself, however, should be changed as stated in the beginning of this discussion. Whether the latent heat of freezing soil water is the same as for ordinary ice remains to be investigated. Interesting surprises may be expected there.

REFERENCE

[1] A. Assur. "A Restatement of Takagi's Theory of Frost Heaving and Some Further Conclusions," USA CRREL, Informal Technical Note, Sept. 1963.

(B) D. H. EVERETT—Takagi suggests that three theoretical problems have to be solved: (1) How and why does the thin water layer between soil particles and ice segregate ice-lenses from soils? (2) Where does the energy of heaving the weight on the ice-lens come from? (3) How is the pressure gradient that sucks water through accumulated soils set up?

On the first point the author says: "The existence of a thin layer between soil particles and ice is not yet confirmed by experiment, but at present its existence is still strongly believed," and "it (the thin layer) must be assumed in order to explain the fact that a particle can stay at a growing surface of the ice without being engulfed by it."

My own view of the importance of this film is summarized in the following quotation [1]: "While diffusion in a film of this kind is necessary to provide a mechanism for the phenomenon, the thickness of this film and the pressures existing in it will be controlled by the bulk equilibrium conditions (T, p^s, p^l) and will vary spontaneously to maintain equilibrium between bulk and surface regions."

Takagi discusses briefly the existence of this layer in terms of the forces existing in the surface layer (following essentially the ideas of Bakker [2] and of Harasima [3]). In effect he emphasizes that near any boundary between phases there must be a heterogeneous region. However, in my view, he is wrong in concluding that "heterogeneity in the surface layer is a result of the preferential orientation of liquid molecules." In the case of water, no doubt molecular orientation will play its part, but the fundamental arguments concerning the nature of a liquid-solid or liquid-vapor interface can be applied equally well to a liquid consisting of spherical molecules (e.g., the noble gases) which cannot be oriented.

It is my opinion that detailed discussion of the nature of the interface between ice and a soil particle is not of immediate importance for the understanding of the frost-heaving problem. Migration of water between the bulk ice and the soil particles is indeed a necessary mechanism. But one might well describe this as a "surface diffusion" along the ice surface without necessarily invoking the existence of "liquid" between the two bulk phases. It would, of course, be interesting and useful to know more about the nature of this interface, especially if there are circumstances in which the migration becomes the rate-determining step in experiments on the rate of frost-heaving; but to pursue the semantics of the problem in the absence of a clearer physical understanding seems hardly worthwhile at the moment.

In attempting to answer the second question Takagi expresses views contrary to those put forward by several other authors, including Chalmers and myself. I believe his views are erroneous for reasons given in detail below.

Takagi begins with the statement: "From the theoretical standpoint in this paper, the existence of soils is not essential for frost-heaving." It is difficult to be sure of the meaning of this sentence. Takagi certainly says later that one of the essential factors is "the existence of a segregating agent with the faculty of sustaining weight." If he would include within this category a system of capillaries (such as used in my simplified model) then I would agree that provided the correct geometrical conditions exist at the ice-water interface, then it does not matter whether they are provided by soil or some other medium. My reading of the rest of the paper, in which no mention is made of geometrical factors, suggests however, that the author wishes to exclude the geometry of the interface as nonessential. In view of the experimental evidence that the heaving pressure is related to the particle size, and size distribution, of the soil, and because of the fundamental significance attached to these factors in a thermodynamic discussion of the phenomenon, it is difficult to accept Takagi's opinions.

This leads to the fundamental conflict which is brought to a head in Takagi's statements that "use of classical thermodynamics can explain only the nonessential secondary effects of frost-heaving," and "instead of the classical thermodynamics where only the equithermal process is considered, the irreversible (or nonequilibrium) thermodynamics must be used to understand the essential process in frost-heaving."

First we can claim that when formulated in terms of the affinity concept of De Donder [4], the basic arguments of classical thermodynamics are not in any way limited to situations in which no gradients of temperature, pressure, or chemical potential exist—although it is true that most chemical applications are concerned with systems of uniform temperature and pressure. However, the important fact is that classical thermodynamics will always give correctly the maximum work which can be obtained in the limiting conditions of a quasi-static process; any more complete treatment in terms of irreversible processes must tend to this limit as the processes occurring proceed more slowly.

The origin of the work of frost heaving seems to be most clearly brought out by my discussion in terms of a heat engine cycle in which the working stroke is the actual frost-heave. According to this analysis, in a complete cycle of operations an amount of heat equal to the latent heat of melting of ice, $\Delta_f h^\dagger$ per mole, is taken in at the normal freezing point (T_f) and frost heaving at a lower temperature ($T_f - \Delta T_f$) occurs with the production of an amount of work equal to the chemical potential difference ($\Delta_f \mu^\dagger$) between ice and water at the same pressure (1 atmos) at the temperature ($T_f - \Delta T_f$). The freezing of water at this lower temperature is accompanied by the release of an amount of latent heat ($\Delta_f h^\dagger - \Delta_f \mu^\dagger$). The fraction of the latent heat taken in at T_f which subsequently appears as work of heaving is $\Delta T_f/T_f$ as shown by the equation

$$\Delta_f \mu^\dagger = \Delta_f S^\dagger \Delta T_f = \frac{\Delta_f h^\dagger}{T_f} \Delta T_f \quad (B.1)$$

where $\Delta_f S^\dagger$ is the entropy difference between ice and water. (For simplicity, the heat capacities of ice and water are assumed to be equal so that $\Delta_f h^\dagger$ and $\Delta_f S^\dagger$ are independent of temperature: The same answer is obtained in the general case). Thus Takagi is essentially correct in saying that the latent heat of fusion provides the source of the work of heaving, although as set out his argument is obscure. He is also correct in seeing as the objective of the theory the calculation of the "percentage of the latent heat which changes to work." He is quite wrong in claiming that his theory will give the work of heaving corresponding to "the most efficient possible . . . frost-heaving, because all the resistances are eliminated in this analysis." The most efficient process must be that in which conditions depart least from thermodynamic equilibrium.

From the point of view of thermodynamics, the processes of heat and mass flow which are the particular concern of Takagi's paper are both sources of irreversibility which must reduce the work done below the maximum corresponding to a quasi-static process. If Takagi's analysis were correct, then his equations should tend towards the result obtained by classical methods as the rates of heat and mass flow tend to zero. They do not do so. Put another way, it seems difficult to see how an analysis of the conversion of heat into work under irreversible conditions can be correct without the introduction (explicitly or implicitly) of the second law of thermodynamics in some form.

A more complete analysis of the frost-heaving problem which would correspond more closely to practical circumstances could be developed from the idealized model given in my paper by taking account of the following factors: (a) Gravitational work which has to be done in raising water to the ice-lens; (b) entropy produced in the viscous flow of water through capillaries leading to the ice-lens, and (c) entropy produced in conduction of heat away from the ice-lens.

While an extended theory of this kind would be relevant to experiments on the rate of heaving and its dependence on heat and mass flux, it is unnecessary in discussing experiments, such as those of Penner, on equilibrium heaving pressures.

Further, it is necessary to comment on Takagi's rejection of the view [5, 6] that the supercooling of water is the energy source. First, Takagi rejects the term supercooling on the grounds that in the ice-lensing situation the equilibrium is stable; however, the stability of a system is not only a property of the system, but also of the possible processes considered. Thus liquid water below 0°C may be in stable equilibrium with capillary ice at the boundary of an ice-lens, but it is still in metastable equilibrium with respect to the formation of ice crystals within the bulk water—hence from this point of view it is correct to call the water supercooled. Secondly, the fact (B.1) that the fraction of the latent heat which is available as work of heaving is proportional to ΔT_f , the lowering of the equilibrium temperature between water in capillaries and the ice-lens, or the degree of supercooling of the bulk water, is an adequate justification for saying that the ability of the system to do external work arises from the supercooling.

Finally, Takagi asks his third question, but does not answer it. According to my views this pressure gradient is set up as a direct result of the pressure difference across the curved boundary between ice and water at the entrance to capillary spaces. If the ice-lens is subjected to a pressure less than the heaving pressure, then the pressure in the water at the ice-lens surface is reduced and causes water to flow to the lens face.

REFERENCES

- [1] D. H. Everett. "The Thermodynamics of Frost Damage to Porous Solids," *Trans. Faraday Soc.*, Vol. 57, 1961, p. 1541.
- [2] Bakker, *Theorie de la couche capillaire plane des corps purs*, Paris, 1911.
- [3] Harasima. "Molecular Theory of Surface Tension," *Adv. Chem. Phys.*, Vol. 1, 1958, p. 203.
- [4] Prigogine, Defay. *Chemical Thermodynamics* (trans. Everett), Longmans, Green, 1954.
- [5] K. A. Jackson, B. Chalmers. "Freezing of Liquids in Porous Media with Special Reference to Frost Heave in Soils," *J. Appl. Phys.*, Vol. 29, 1958, p. 1178.
- [6] R. T. Martin. "Rhythmic Ice Banding in Soil," *Highway Res. Bd. Bull.*, Vol. 218, 1959, p. 11.

(C) AUTHOR'S SUPPLEMENT

The energy balance equation at plane BB in Fig. 3 in this paper is derived on the assumption that the ice formed at BB is under the same pressure as the water just below BB. This assumption, however, is not acceptable.

The correction may be made as follows by introducing a simplifying assumption that ice is under hydrostatic pressure. The pressure (p_{iB}) of ice at plane BB is

$$p_{iB} = \rho_i gh + p_A + w \quad (C.1)$$

where p_A is atmospheric pressure on AA. Rewrite (18) in the text as

$$\left(u_w + \frac{p_B}{\rho_w}\right) - \left(u_i + \frac{p_{iB}}{\rho_i}\right) = L \quad (C.2)$$

where p_B , the pressure of water just below BB, is not necessarily equal to atmospheric pressure (p_A). Use of (C.1) and (C.2) changes (17) in the text to

$$-k_i \left(\frac{\partial \theta_i}{\partial z}\right)_B + k_w \left(\frac{\partial \theta_w}{\partial z}\right)_B = \rho_i \frac{dh}{dt} \left(L - \frac{p_B}{\rho_w} + \frac{p_A}{\rho_i}\right) \quad (C.3)$$

The foregoing calculation, however, is not satisfactory because ice is usually under stress (not necessarily under hydrostatic pressure), and also because the value of L defined by (C.2) is not known. A more satisfactory calculation treating ice as an elastic material is shown below. It results in exactly the same formula as (C.3) for the energy balance equation at BB, and also shows that the freezing point of the ice at plane BB is depressed by the weights of ice and overburden on plane BB.

It is recognized in this analysis that plane BB in Fig. 3 in the text (which by hypothesis can sustain any weight on it) introduces the effect in the actual soil; that is, in terms of soil mechanics, the water that enters an ice-lens is under pore water pressure, but the ice formed is under intergranular stress plus pore water pressure. The "heaving pressure" is equal to the excess represented by the intergranular stress. The energy of frost-heaving is the energy necessary for transforming the level of stress, and is supplied by the energy released during the phase change. The analysis based on the above recognition shows that a lowering of freezing temperature is an important factor for determining the amount of energy that causes frost-heaving.

The starting point for the thermodynamic treatment of the classical theory of elasticity [1, p. 220; 2, p. 76] is

$$dU_i = T dS_i + V_i \sigma_{\lambda\mu} d\epsilon_{\lambda\mu} \quad (C.4)$$

where U_i , S_i , and V_i are, respectively, internal energy, entropy, and volume per infinitely small mass (dM) of the elastic ice under consideration, T is the absolute temperature, and $\sigma_{\lambda\mu}$ and $\epsilon_{\lambda\mu}$ are, respectively, components of stress tensor (positive for tension) and components of strain tensor (positive for expansion) referred, for simplicity, to rectangular Cartesian coordinates represented by suffixes λ, μ . The summation convention in tensor analysis is observed; therefore

$$\sigma_{ij} d\epsilon_{ij} = \sigma_x d\epsilon_x + \sigma_y d\epsilon_y + \sigma_z d\epsilon_z + 2\tau_{xy} d\gamma_{xy} + 2\tau_{yz} d\gamma_{yz} + 2\tau_{zx} d\gamma_{zx} \quad (C.5)$$

Thermodynamic treatment of the classical theory of elasticity demands specification of the state of no strain, where $\epsilon_{\lambda\mu} = 0$. The state of no strain is defined to be the state of ice in thermal equilibrium with the water vapor without the existence of air under given temperature (T) and ice-saturation vapor pressure (p_i^0) [3]. The definition prescribes that the stress

$$\left(\sigma_{\lambda\mu} - p_i^0 \delta_{\lambda\mu}\right)$$

must be used instead of the actual stress ($\sigma_{\lambda\mu}$) to write the stress-strain relationship

$$\sigma_x = 2G \left(\epsilon_x + \frac{3\nu}{1-2\nu} \bar{\epsilon}\right) + p_i^0, \text{ etc.} \quad (C.6)$$

$$\tau_{xy} = G\gamma_{xy}, \text{ etc.} \quad (C.7)$$

where $\delta_{\lambda\mu}$ is the Kronecker delta, G is the shear modulus,

ν is Poisson's ratio, and

$$\bar{\epsilon} = \frac{1}{3} (\epsilon_x + \epsilon_y + \epsilon_z) \quad (C.8)$$

Another indispensable assumption is that $\epsilon_{\lambda\mu}$ is negligible as compared with one. Therefore, V_i is almost a constant under change of stress. In the following, V_i is assumed to be a constant, say V_i^{00} , not only under change of stress, but also under change of temperature

$$V_i \approx V_i^{00} \quad (C.9)$$

The latter assumption may be accepted if only a small change of temperature is considered.

The system that is analyzed on these assumptions will be called classical elastic ice. If the assumptions cannot be accepted, use of the classical theory of elasticity must be abandoned, and the theory for large elastic deformation [4], which is not yet completed for thermodynamical use, must be considered.

Assume that the hydrostatic pressure ($-p_i^0 \delta_{\lambda\mu}$) is changed to $\sigma_{\lambda\mu} - p_i^0 \delta_{\lambda\mu}$. Let U_i^0 and S_i^0 be quantities for the state of no strain; then (C.4) is integrated under the condition of constant T and under the foregoing assumptions to

$$U_i - U_i^0 = T(S_i - S_i^0) + V_i \Psi \quad (C.10)$$

where

$$d\Psi = \sigma_{\lambda\mu} d\epsilon_{\lambda\mu} \quad (C.11)$$

Equation (C.11) is integrated by use of the stress-strain relationship (C.6), (C.7), and (C.8) to

$$\Psi = G \left(\epsilon_x^2 + \epsilon_y^2 + \epsilon_z^2 + \frac{9\nu}{1-2\nu} \bar{\epsilon}^2\right) + G(\gamma_{xy}^2 + \gamma_{yz}^2 + \gamma_{zx}^2) + 3p_i^0 \bar{\epsilon} \quad (C.12)$$

Equation (C.12) shows that Ψ is positive if the last term, $3p_i^0 \bar{\epsilon}$, which is usually negligible, is not a large negative number. The positivity of Ψ for both expansion and compression is a result of choosing the state of no strain to be the state of least stress that can possibly be attained.

Using again the foregoing stress-strain relationship transforms (C.12) to

$$\Psi = \frac{1}{2} \sigma_{\lambda\mu} \epsilon_{\lambda\mu} + \frac{3}{2} p_i^0 \bar{\epsilon} \quad (C.13)$$

Use of another form of the stress-strain relationship

$$\epsilon_x = \frac{1}{E} \left[\sigma_x = \nu(\sigma_y + \sigma_z) - (1-2\nu)p_i^0\right], \text{ etc.} \quad (C.14)$$

and

$$\gamma_{xy} = \frac{1}{G} \tau_{xy}, \text{ etc.} \quad (C.15)$$

transforms (C.13) to

$$\Psi = \frac{1}{2E} (\sigma_x^2 + \sigma_y^2 + \sigma_z^2) - \frac{\nu}{E} (\sigma_x \sigma_y + \sigma_y \sigma_z + \sigma_z \sigma_x) + \frac{1}{G} (\tau_{xy}^2 + \tau_{yz}^2 + \tau_{zx}^2) - \frac{1}{2K} (p_i^0)^2 \quad (C.16)$$

where E is Young's modulus and K is bulk modulus.

When ice is under hydrostatic pressure (p), Ψ for this case, say $\Psi(p)$, is determined by use of (C.16)

$$\Psi(p) = \frac{1}{2K} [p^2 - (p_i^0)^2] \quad (C.17)$$

In Fig. 3 in the text, ice does not deform in the horizontal directions and it may be assumed that $\epsilon_x = 0$ and $\epsilon_y = 0$ from which σ_x and σ_y are determined

$$\sigma_x = \sigma_y = \frac{\nu}{1-\nu} \sigma_z \quad (C.18)$$

where

$$\sigma_z = -\rho_i gh - w - p_A \quad (C.19)$$

Substituting (C.18) in (C.16), Ψ for this case, say $\Psi(\sigma_{\lambda\mu})$, is determined

$$\Psi(\sigma_{\lambda\mu}) = \frac{1-\nu-2\nu^2}{2E(1-\nu)} \sigma_z^2 - \frac{1}{2K} (p_i^0)^2 \quad (C.20)$$

According to Dorsey [5], E and ν are, respectively, almost equal to

$$E = 9.6 \times 10^4 \text{ kg-wt/cm} \quad (C.21)$$

and

$$\nu = 0.365; \quad (C.22)$$

then

$$\frac{1-\nu-2\nu^2}{2E(1-\nu)} = 6.03 \times 10^{-6} \frac{\text{cm}^2}{\text{kg-wt}} \quad (C.23)$$

$$\frac{1}{2K} = \frac{3(1-2\nu)}{2E} = 4.2 \times 10^{-6} \frac{\text{cm}^2}{\text{kg-wt}} \quad (C.24)$$

and

$$\frac{1}{G} = \frac{2(1+\nu)}{E} = 2.84 \times 10^{-5} \frac{\text{cm}^2}{\text{kg-wt}} \quad (C.25)$$

Equation (C.10) may be simplified to

$$U_i \approx F_i^0 + S_i T + V_i^{00} \Psi \quad (C.26)$$

by writing (F is the Helmholtz free energy)

$$F_i^0 = U_i^0 - S_i^0 T = \text{a function of } T \text{ only} \quad (C.27)$$

Approximation (C.9) is used in obtaining (C.26). Totally differentiating (C.26) and comparing the result with (C.4) yields

$$S_i \approx S_i^0(T) = \text{a function of } T \text{ only} \quad (C.28)$$

use of which changes (C.26) to

$$U_i \approx U_i^0 + \Psi V_i^{00} \quad (C.29)$$

It is assumed in the following that the volume of water does not change with changes of both pressure and temperature

$$V_w = V_w^{00} = \text{const} \quad (C.30)$$

This assumption may be introduced because water is assumed in the text to be an incompressible perfect fluid that has a constant density even under change of temperature. Thermodynamic consequences of this assumption are found by use of the formula

$$dU_w = T dS_w \quad (C.31)$$

which becomes under the condition of constant T

$$dF_w = 0$$

This is integrated to

$$F_w = F_w^0(T) = \text{a function of } T \text{ only} \quad (C.32)$$

Therefore

$$S_w = S_w^0(T) = \text{a function of } T \text{ only} \quad (C.33)$$

and

$$U_w = U_w^0(T) = \text{a function of } T \text{ only} \quad (C.34)$$

According to Dorsey [5], the isothermal compressibility,

$$-\frac{1}{V} \left(\frac{\partial V}{\partial p} \right)_T, \text{ of water at } 0^\circ\text{C and 1 to 10 atmos is } 5.03 \times 10^{-5}$$

per atmos and that of ice at 0°C and 1 atmos is 3.75×10^{-5} per atmos; the thermal expansion,

$$\frac{1}{V} \left(\frac{\partial V}{\partial T} \right)_p \text{ of water at } 0^\circ\text{C and 1 atmos is } -5.9 \times 10^{-5} \text{ per } ^\circ\text{C}$$

and that of ice at 1 atmos (independent of temperature) is 12.2×10^{-5} per $^\circ\text{C}$. Both are of the same order of magnitude as for water and ice. For ice, the assumption of constant volume cannot be a basis for the thermodynamic analysis, because the relation imposed on $\epsilon_{\lambda\mu}$ by the assumption is not considered. For ice, constant volume is an approximation.

The condition for thermal equilibrium between normal water and stressed ice is found [13] with reference to Fig. C.1. Using $F = U - ST$ instead of U . Then, from thermodynamics

$$dF = dW - SdT \quad (C.35)$$

where dW is the work done on the system from the outside, and dF is the change of F during the process. For an equilibrium process, (C.35) becomes

$$dF = dW \quad (C.36)$$

Assume that the water of mass (dM) is frozen in an equilibrium, reversible process. In Fig. C.1, water can reach the ice surface only through the porous piston at the top of the inner container, of which the side and the bottom are assumed to be impermeable to both heat and water and also to be rigid. In this case,

$$dW = -p_B (\bar{V}_i - \bar{V}_w) dM + \sigma_z' \bar{V}_i dM \quad (C.37)$$

where σ_z' is the external stress (positive for tension) added on the porous piston so that

$$\sigma_z' - p_B = \sigma_z \quad (C.38)$$

\bar{V}_i and \bar{V}_w are specific volumes of ice and water, respectively, and p_B is the pressure of water. Substitution of the relation

$$dF = (\bar{F}_i - \bar{F}_w) dM \quad (C.39)$$

and of (C.37) in (C.36) yields

$$\bar{F}_w(p_B, T_B) + p_B \bar{V}_w = \bar{F}_i(\sigma_{\lambda\mu}', T_B) + p_B \bar{V}_i - \sigma_z' \bar{V}_i \quad (C.40)$$

where \bar{F}_i and \bar{F}_w are the partial specific Helmholtz free energies of ice and water, respectively, $\bar{F}_i = \bar{U}_i - \bar{S}_i T$ by definition. T_B is the temperature of the system in Fig. 4 but may be interpreted as the temperature at plane BB in Fig. 3 in the text, because the thermodynamic system considered is essentially the same. Quantities with suffix "i" are those for the surface ice in direct contact with water through the porous

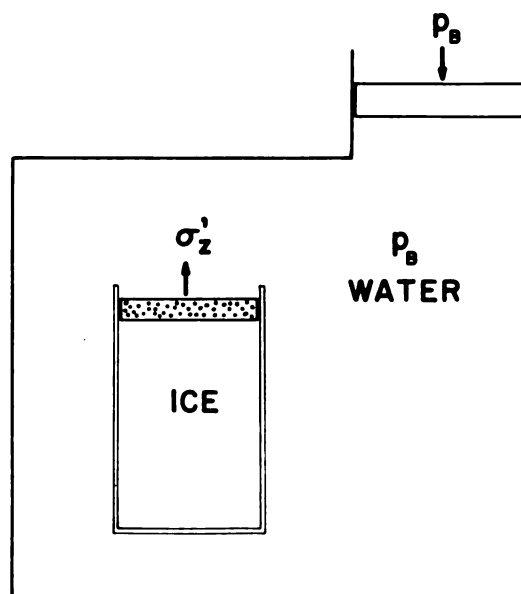

Fig. C.1. Thermal equilibrium between water and stressed ice

piston. Quantities in parentheses denote the independent variables upon which the variable immediately preceding the parentheses depend. Bars on quantities signify that respective quantities are partial specific. The conventions introduced here will be observed henceforth. Equation (C.40) determines the thermal equilibrium between water and stressed ice under the condition prescribed in reference to Fig. C.1. For a particular case where T_B and $\sigma_{\lambda\mu}$ becomes $T_O K = 0^\circ C$ and $p_A = 1$ atmos, respectively, then (C.40) becomes

$$\bar{F}_w(p_A, T_O) + p_A \bar{V}_w = \bar{F}_i(p_A, T_O) + p_A \bar{V}_i \quad (C.41)$$

which shows the well-established equality of the partial specific Gibbs' free energies.

The relation between $\bar{F}_i(\sigma_{\lambda\mu}, T_B)$ and $\bar{F}_i(p_A, T_O)$ is found by use of (C.35)

$$\begin{aligned} & \bar{F}_i(\sigma_{\lambda\mu}, T_B) - \bar{F}_i(p_A, T_O) \\ &= \bar{V}_i [\Psi(\sigma_{\lambda\mu}) - \Psi(p_A)] - \bar{S}_i^o(T_O)(T_B - T_O) \end{aligned} \quad (C.42)$$

where $\Psi(p_A)$ is obtained by putting $p = p_A$ in (C.17). Similarly,

$$\bar{F}_w(p_B, T_B) - \bar{F}_w(p_A, T_O) = -\bar{S}_w^o(T_O)(T_B - T_O) \quad (C.43)$$

where the relation (C.32) is considered. Subtract (C.41) from (C.40), and substitute (C.42) and (C.43); then

$$\begin{aligned} L(T_O) \frac{1}{T_O}(T_O - T_B) &= \left(gh + \frac{w}{\rho_1}\right) + \bar{V}_i [\Psi(\sigma_{\lambda\mu}) - \Psi(p_A)] \\ &+ \frac{1}{\rho_w}(p_A - p_B) \end{aligned} \quad (C.44)$$

where use is made of (C.38) and (C.19), and the relation,

$$T_O [\bar{S}_w^o(T_O) - \bar{S}_i^o(T_O)] = L(T_O) \quad (C.45)$$

where $L(T_O)$ is the heat of freezing water to ice at the triple point in the air.

Numerical calculation of (C.44), taking only the first term on the right side, shows a freezing-point depression, $T_O - T_B$, of approximately $0.00803^\circ C$ at the bottom of a body of ice 1 m thick and extended infinitely in horizontal directions without any surcharge on the top. Effects of Ψ and pressure are usually negligible as compared with the σ_z effect.

The water below plane BB in Fig. 3 of the text is supercooled because of the assumptions made for the mathematical analysis. The soil water in the actual system, however, is not supercooled but has a lowered freezing point. If the freezing point of the free water in pores is higher than the temperature of the freezing front (T_B in the ideal case), water is frozen before it reaches the freezing front and segregation of ice-lens from the thin water film cannot take place.

From thermodynamics, the heat $L(T_B)$ of freezing the water of p_B and T_B to the ice of $\sigma_{\lambda\mu}$ and T_B is

$$L(T_B) = T_B [\bar{S}_w(T_B) - \bar{S}_i(T_B)] \quad (C.46)$$

$L(T_B)$ is a function of (T_B) only. Use of (C.46) transforms (C.40) to

$$\begin{aligned} & \bar{U}_w(p_B, T_B) - \bar{U}_i(\sigma_{\lambda\mu}, T_B) \\ &= L(T_B) + \left(gh + \frac{w}{\rho_1}\right) + \left(\frac{p_A}{\rho_1} - \frac{p_B}{\rho_w}\right) \end{aligned} \quad (C.47)$$

Equation (C.47) shows that the energy of frost-heaving is supplied by the energy released during the phase change. Since (C.47) is equivalent to (C.40), (C.44) may be interpreted as an energy balance equation expressed in comparison with the quantities at the triple point in the air. Then it may be said that the energy of frost-heaving is caused by the freezing-point depression, $T_O - T_B$, because the energy, $gh + w/\rho_1$, is a part of $L(T_O) 1/T_O(T_O - T_B)$.

Depression of T_B by $0.00803^\circ C$ produces the energy of heaving ice 1 m thick. If 80 cal of energy were completely given out as work, it would heave a 34.2 km water column 1 cm. Only a portion, $0.00803/273.16 = 0.0000294$, of 80 cal is used to heave the weight equivalent to the ice 1 m thick.

The foregoing interpretation substantiates the view of Jackson and Chalmers [6] and Martin [7]. They have proposed that supercooling of water is the energy source. However, supercooling should not be confused with freezing-point depression [8, 9]. It is more logical to consider that soil water has a lowered freezing point than to consider that soil water is supercooled. If a piece of ice emerges in supercooled water, supercooling (metastable state) ceases in a short time and stable freezing is realized. It is true that, when water flows at a considerable velocity, supercooling can exist upstream from the ice, as shown in the formation of anchor ice [10]. This effect, however, will be negligible in soil where the flow of water is usually very slow. With this modification, their concept is substantially correct, as found in the analysis of this paper.

Substitution of (C.47) in (17) in the text, which is under the present notation,

$$\begin{aligned} & -k_i \left(\frac{\partial \theta_i}{\partial z}\right)_B + k_w \left(\frac{\partial \theta_w}{\partial z}\right)_B \\ &= \rho_1 \frac{dh}{dt} \left[\bar{U}_w(p_B, T_B) - \bar{U}_i(\sigma_{\lambda\mu}, T_B) - \left(gh + \frac{w}{\rho_1}\right) \right] \end{aligned}$$

yields

$$-k_i \left(\frac{\partial \theta_i}{\partial z}\right)_B + k_w \left(\frac{\partial \theta_w}{\partial z}\right)_B = \rho_1 \frac{dh}{dt} \left[L(T_B) + \left(\frac{p_A}{\rho_1} - \frac{p_B}{\rho_w}\right) \right] \quad (C.48)$$

Equation (C.48) is the correct boundary conditions that must be used instead of (20) or (21) in the text.

Yosida [3] carries out a similar analysis for other boundary conditions, where, for example, the porous piston at the top of the ice in Fig. C.1 is changed to an impermeable piston, and the impermeable wall on the lateral side of the ice is changed to a wall permeable to both water and heat. The freezing point depression thus obtained is different from the one in (C.42). His analysis demonstrates that the stress in ice cannot be in any way identified with hydrostatic pressure. The reason for the satisfactory result (C.3) under the assumption of hydrostatic pressure on ice is that, under the specified boundary conditions, the stress on the lateral side of ice in Fig. C.1 does no work.

Existence of excess pressure and freezing point depression in an ice-lens conforms with the concepts suggested by Everett [11], Miller [12], and Chalmers and Jackson [13], although the method of introduction is quite different. This existence is necessary because liquid water under pore water pressure becomes ice under intergranular stress plus pore water pressure. Their introduction, however, is by way of surface tension between ice and liquid water, which is very unreliable for the reasons given below.

A quotation from Herring [14, p. 24] reads: "... only very small particles have any hope of equilibration of shape, since for large particles the number of elementary transport processes which have to take place to achieve an appreciable change of shape is so huge compared with the lowering of $\int \gamma dA$ which results that the rate of equilibrium becomes negligible. Moreover, the equilibrium of a small particle with a large volume of its vapor or solution is always unstable with respect to changes of size, and, if rapid changes of size are occurring, the shape may be determined by details of the kinetics of growth or dissolution rather than by the minimum of $\int \gamma dA$" In his notation, γ is the surface tension, and A is the surface area.

To be more specific, consider an ice sphere suspended in the air. If a small drop of water comes in contact with the ice sphere, it will freeze at the point of contact. In order for the ice sphere to grow to a larger sphere, other water drops must successively contact other points on the sphere. Because

solid molecules do not have the mobility that liquid molecules have, the effect of surface tension is concealed by kinetic phenomena, that is, mass transfer and heat transfer.

Contrary to Herring, ice water interfaces of small radius are not usually spherical. Chalmers and Jackson [13] attempted to measure radii of curvature of ice water interfaces in small capillaries. Some interfaces were very irregular, some could not even be detected. The same results are also described by Hori [15]. In formation of ice crystals in water, many forms of crystal growth are observed, such as needle forms, feather-like forms, disk crystals, and stellar crystals [16]. It is possible that a similar process will also take place in soil. Spherical ice water interfaces of large radius of curvature, where small irregularities are not conspicuous, can be observed; but these occur only when the rate of growth is so small that kinetic effects are not manifest.

It may, moreover, be added that ice in soil is under intergranular stress, and never under pressure. Therefore the Kelvin formula cannot be used exactly.

REFERENCES

- [1] H. G. Callen. Thermodynamics, Wiley, 1960.
- [2] H. Jeffreys. Cartesian Tensors, Cambridge, 1961.
- [3] Z. Yosida. "A Thermodynamical Theory about the Vapor Pressure and the Melting Point of Ice under Elastic Strain," (in Japanese, with English resume), Low Temperature Sci., Inst. Low Temperature Sci., Hokkaido Univ., Ser. A. 20, 1962, pp. 1-27.
- [4] A. E. Green, J. E. Adkins. Large Elastic Deformation, Oxford, 1960.
- [5] N. E. Dorsey. Properties of Ordinary Water-Substance, Reinhold, 1940.
- [6] K. A. Jackson, B. Chalmers. "Freezing of Liquids in Porous Media with Special Reference to Frost Heave in Soils," J. Appl. Phys., Vol. 29, 1958, pp. 1178-1181.
- [7] R. T. Martin. "Rhythmic Ice Banding in Soil," Highway Research Board Bull., Vol. 218, 1959, pp. 11023.
- [8] S. Takagi. "Theory of Freezing-Point Depression of Soil Water, and a Note on the Extra-Thermodynamics of Soil Moisture," Soil Sci., Vol. 88, 1959, pp. 25-31.
- [9] S. Takagi. "Theory of Freezing-Point Depression with Special Reference to Soil Water," Session 4 of this volume.
- [10] V. Altberg. "Twenty Years of Work in the Domain of Underwater Ice Formation (1915-1935)," Intl. Union Geophysics Assn. Sci. Hydrology Bull. No. 23, 1936, pp. 373-407.
- [11] D. H. Everett. "Thermodynamics of Frost Damage to Porous Solids," Trans. Faraday Soc., 1961, pp. 1541-1551.
- [12] R. D. Miller. "Phase Equilibria and Soil Freezing," Session 4 of this volume.
- [13] B. Chalmers, K. A. Jackson. Final Report to Contract DA19-016, Eng. Corps 5745, 1963.
- [14] C. Herring. "The Use of Classical Macroscopic Concepts in Surface-Energy Problems," Structure and Properties of Solid Surfaces, ed. by R. Gomer and C. S. Smith, Univ. of Chicago Press, 1953.
- [15] T. Hori. "Mizu no hakumaku no kareikyaku to johatsu I," On the Supercooling and Evaporation of Thin Water Films, Low Temperature Sci., Inst. Low Temperature Sci., Hokkaido Univ., Ser. A., Vol. 15, 1956, pp. 33-42, U.S. Army SIPRE Transl. 62, 1960.
- [16] K. Arakawa, K. Higuchi. "Studies on the Freezing of Water (1)," J. Fac. Sci., Hokkaido Univ., Japan, Ser. 2, 1952, No. 3, pp. 201-208.

(D) D. H. EVERETT—Reply to Author's Supplement—In discussing his own paper Takagi corrects a number of statements and brings his view much more nearly into agreement with those expressed by Chalmers, Miller, and Everett. One aspect of his revised theory does, however, call for comment. In deriving his equations, he uses the model system shown in his Fig. C.1 in which ice and water are separated by a piston that is supposed to be permeable to water but not to ice. He suggests that he is thus able to introduce stress into the ice without using surface tension effects. The object of this

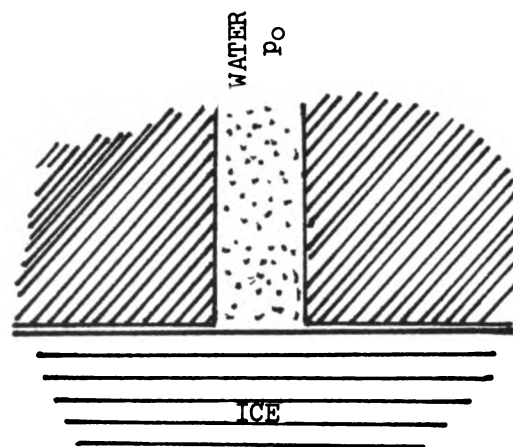

Fig. D.1. Configuration of ice and water at the mouth of a pore leading into a porous piston

comment is to suggest that surface tension effects are in fact essential to the operation of a piston permeable only to water; consequently, although Takagi does not introduce surface tension effects explicitly, they are implicit in his model.

Consider the situation at the mouth of a pore leading into the porous piston (Fig. D.1) and suppose that the interface between ice and water at the mouth of the pore is planar. The ice in direct contact with the material of the piston is subjected to stress, but that in contact with water must be subjected to the same pressure (p_0) as the water. The chemical potential of the ice surface in contact with water is thus that of ice at a pressure (p_0). But the water is supercooled, and therefore this ice surface cannot be in equilibrium with water at the same pressure. Therefore water will tend to freeze on the ice surface, and to form a small crystal within the capillary. The chemical potential of this crystal will be higher than that of ice at a pressure (p_0); if the capillary is of an appropriate size this chemical potential may be high enough to prevent continued propagation of ice through the capillary.

Although in my treatment of the problem I assumed, for simplicity, a hemispherical interface between ice and water, this is by no means necessary; very small crystals of other shapes have a higher chemical potential than bulk crystals (at least across some faces) and will tend to enlarge themselves until they fill the available space. Provided we agree to attribute the higher chemical potential of finely divided crystals to some kind of surface tension effect, then the action of a piston permeable to water but not to ice must be a surface tension phenomenon essentially.

Having said this, one must agree that the thermodynamic theory is an equilibrium theory, and that under certain conditions transport phenomena (heat and water flow, and crystal growth) may well play a significant role in determining the details of the process of frost-heaving. But any complete theory must be able to predict the way in which the crystal habit of ice depends on such factors as the pressure and temperature gradients in the neighborhood of the growing crystal; only under conditions where the rate of growth is small can one expect the thermodynamic theory to hold exactly.

(E) CLOSURE

The author would like to express his appreciation for the discussions of his frost-heave paper, especially for R. D. Miller's comment made prior to the conference. [See note at end of this article.] This comment enabled the author to make an important correction, mentioned in the author's discussion. However, most of Miller's comment, and also those of the other panel members of Session 4, made during the conference, indicated misunderstandings of the implications of the theory.

First, one of the corrections of the text necessitated by the author's supplement should be noted. In the author's supplement, the energy balance at the freezing front is formulated by use of equilibrium thermodynamics compromised with the classical theory of elasticity. Nonequilibrium thermodynamics is not used in analyzing the equilibrium condition at the freezing front, which is simulated in Fig. C.1.

Nonequilibrium thermodynamics, however, is used in order to formulate simultaneous flow of water and heat. The formulation in this paper does not follow the formalism adopted in textbooks of nonequilibrium thermodynamics. The system adopted for analysis in the text is so simple that one may make direct use of a basic principle of nonequilibrium thermodynamics: That three balance equations (balance of mass, balance of force, and balance of energy) should be considered simultaneously for the formulation. If the system of analysis is made more complicated by adopting more actual situations, an elaborate use of nonequilibrium thermodynamics may become necessary.

The author agrees with Miller that "the migration of water toward a growing ice-lens is not dependent upon a temperature gradient and a concurrent transport of heat (other than latent heat) in the same direction." The heat transfer, however, is dependent on the flow of water. Water discharges a part of its internal energy as it cools—a kind of heat transfer, called convection, which is dependent on the temperature gradient and the velocity of water flow.

Miller misunderstands the meaning of Pascal's principle. Pascal's principle states that water in a static state cannot withstand shearing force, but is not a "statement of the uniformity of specific potential energy of water throughout a body of water at rest in earth's gravitational field." Pascal's principle is not related to a gravitational field. Moreover, the Newtonian property of a liquid is customarily defined as viscosity.

With these corrections, Miller's comment with regard to non-Pascalian property may probably best be understood as follows: If, in Corte's experiment, the adsorption force of a floating particle creates an appropriate distribution of hydrostatic pressure inside the body of water that exists just below the particle, the particle will continue to float; in other words, the concept of shearing force may not be invoked to explain the floating of a particle. The author will not discuss this view. Instead, he will explain his own concept from a different angle.

The floating of a particle on the ice surface in Corte's experiment may be likened to the floating of a needle on the air-water interface. The latter is explained as an effect of surface tension. According to the theory of surface tension, the water at the air-water surface is a non-Pascalian water; that is, an extraordinary water that has a resistance to shearing force. The only difference in the explanations is that disintegration of surface tension, as explained in the paper under discussion, must be considered in order to explain the floating or a particle in Corte's experiment, while the integrated effect of surface tension may be used to explain the floating of a needle.

The existence of rigidity does not preclude the mobility of the water in the film that is necessary to explain Corte's experiment. The thin water film may be assumed to be a viscoelastic material, which has fluidity. The elasticity modulus and viscosity of the thin water film as a visco-elastic material, however, change with distance from the ice water boundary and solid water boundary because of the heterogeneous nature of the film. Water molecules in the immediate vicinity of solid walls may not move, but water molecules approximately half way between the ice surface and the soil particles may move.

Miller's last comment implies contradiction of the concept of intergranular stress in soil mechanics. If ice formed in soil is free of internal shearing stress because "the unfrozen film that separates the ice phase from the mineral particle does not transmit shearing stresses to the ice," a soil particle that is surrounded by adsorbed water must also be free of internal shearing stress. This contradicts the concept of intergranular stress. This paradox shows that both the unfrozen film and the adsorbed water are non-Pascalian, that is, partly a solid,

so that both ice and soil particle may have internal shearing stress.

A specification of stress is pressure. The stress of a liquid in a static state is reduced to pressure because a liquid in a static state cannot resist any shearing stress (Pascal's principle), in other words, because molecules of liquid move under any shearing stress to realize a state in which no shearing stress works on molecules. However, molecules in a solid do not move by shearing stress, therefore shearing stress is not zero in a solid. The stress in a solid is reduced to pressure only when the solid is surrounded by a liquid or a gas in a static state, by solids that are under hydrostatic pressure, or by a combination of these. Even for the special case in which pressure works in the solids, stress instead of pressure should be used to designate the state of stress inside the solid, if a change of boundary condition should bring about shearing stress that is not zero.

To the author, the statement, "ice in soil is under intergranular stress," is a fact that does not need any proof. In order to have an ice particle under hydrostatic pressure, the soil particles surrounding the ice must also be under hydrostatic pressure—an improbable presumption.

According to a specialist on ice [1], there are many reasons to believe that the surface tension of ice does not vary much with the crystallographic orientation of the exposed surface. The nonspherical shape of some ice crystals is usually formed not by surface tension but by material transportation and heat dissipation, two factors that differ in different directions.

The author welcomes Everett's discussion; he will attempt to clarify his contention about Professor Everett's concept.

The mechanism adopted [2] to explain the formation of an ice-lens is that molecules in the solid state move in accordance with the gradient of chemical potential caused in the solid by the surface tension that works on curved portions of the interface.

The same mechanism is used to explain sintering [3 to 6]. However, in sintering the process is very slow, and is not rate determining while other kinetic effects are concurrent.

Ice molecules can move in three ways: Surface diffusion, volume diffusion, and evaporation-condensation [4 to 6]. Recently Hobbs and Mason [6] showed the relative ratio of the fluxes of the three motions that increase the volume of the contact portion of two ice spheres of equal diameter that are suspended in the air under the saturation of water vapor pressure with respect to (flat) ice. If the flux of evaporation-condensation is of the order of one, the fluxes by volume diffusion and surface diffusion are each of the order of $1/2000$ at -10°C . The flow of evaporation-condensation is very slow as compared with the flow of liquid water, as one mole of water is 18 cu cm of liquid water or 22.4 liters of water vapor at 0°C and 1 atmos. Therefore, it may be concluded that flow through the vapor phase is—and also flows by volume and surface diffusion are—usually negligibly small as compared with the flow of liquid water, if they are concurrent.

There is a pronounced unbalance in the distribution of chemical potential inside a snow crystal due to its dendritic form. A snow crystal appears to grow even against the gradient of chemical potential inside it. Growth of a snow crystal is believed to be influenced most by the mechanism of extracting heat evolved on solidification of water vapor and by the mechanism of supplying water vapor [7, 8].

When a snow crystal falls out of a region that contains supersaturated water vapor, its angular edges begin to round off [9]. When snow is accumulated on the ground, and the temperature and vapor pressure around a snow crystal become almost uniform, the dendritic form transforms gradually to a granular form [10 to 12]. These transformations are an effect of surface tension that involves the mechanism adopted by Everett, as suggested by Kozima [10] and Yosida [13]. The effect does not become manifest and is not rate determining while the crystal is growing.

It may be concluded from discussions made in reference to Chalmers and Jackson [14], Hori [15], Arakawa and Higuchi

[16] in the author's supplement and also from Wylie [17] that the forms of ice crystals in water are determined mainly by the mechanism of extracting heat evolved on freezing and by the direction of supply of water molecules. A similar view is also mentioned by Mason [8]. Distribution of the chemical potential inside the solid is not balanced and is not rate determining during growth.

Similar processes may also take place in soil. The intrusion of ice into pores may be understood as follows: Soil particles conduct heat better than ice, and the intrusion of ice into pores results in the shape that allows most efficient dissipation of the heat evolved. Distribution of the chemical potential in ice may not be balanced, and is not rate determining, during the formation of ice in soil.

When a spherical ice-water interface of large radius of curvature is present, and where small irregularities are not conspicuous, the effect of surface tension may be observed. This occurs only when the rate of growth is so small that the arrangement of ice molecules due to surface tension is the main factor in determining the shape of the surface. The concept of surface tension on a solid surface is useful for explaining sintering, but is difficult to use in other cases [18, p. 6].

In a liquid, molecules are movable, and the effect of surface tension becomes manifest in most of the cases. In a solid, however, molecules do not move easily, and the effect of surface tension is not manifest in most cases.

If surface tension alone determines the shape of a solid, then the concept of surface tension is easily applied. However, if kinetic effects other than surface tension are predominant in determining the shape, correct use of this concept is very difficult. It is also very difficult to judge whether or not the shape of a solid is determined solely by surface tension.

Ice in soil is under intergranular stress, and never under pressure. Therefore, the Kelvin formula cannot be used exactly.

It is traditional to explain ice-lens formation as a process involving a thin water film between ice and soil particles. It is restated by Jackson and Chalmers [19] and is to a certain extent substantiated by Corte's experiment.

Everett states that the thin water film between ice and soil particles has an equilibrium thickness. This concept permits the following interpretation: If the part of the thin water film adjacent to an ice-lens freezes, water must be sucked into the thin water film from the adjacent pore in order to restore the equilibrium thickness. The author wonders why Everett does not extend his concept of equilibrium thickness to explain the origin of surface force. He assumes [2] that ice molecules in the curved portion of a capillary move into the body of the ice-lens under the action of surface tension, and that water molecules are sucked in to be frozen to form a new ice surface meniscus. His assumption does not conform with other phenomena of crystal growth, as explained above.

The factor causing a major difficulty in the paper under discussion might be that frost-heaving is discussed without mentioning soils. The reason for this is not explained in detail in the paper under discussion because of limited space. A detailed explanation will be given elsewhere [20].

Soils are neglected based on the recognition that soil in contact with ice functions differently than soil forming the substructure of soil in contact with ice. Soil in contact with ice segregates an ice-lens, but the substructure transports heat and water. Even when the substructure is replaced with a simpler material, such as sand or filter paper, keeping the same soil in contact with the ice-lens, the ice-lens still grows, although at a different rate.

For a simple analysis, the simplest substructure may be used, that is, pure water that contains no soil or other material.

Simplification of the substructure provides the benefit of simple analysis but also causes a drawback in that actual soil cannot be represented. The author considers this simplification as the first stage of a complete solution. The actual situation may be considered later as the second stage by considering the properties of the thin water layer in more detail

and by replacing the heat conduction and material flow in pure water and ice with the heat conduction and material flow in soils.

It is interesting to see that (C.44) in the author's supplement is essentially the same as Everett's (15) [2]. In (C.44), the first term on the right side is the work (w) in Everett's (15), and the other terms on the right side may be neglected. (The author's supplement included in this volume is a revised discussion, which Everett had not seen when he made his comment).

Equation (C.44) may be interpreted to mean that the freezing-point depression determines the part of the latent heat that causes frost-heaving. Equation (C.44) substantiates the view of Jackson and Chalmers [19] that "supercooling" provides the source of energy for frost heaving if "supercooling" is changed to "freezing-point depression."

The author believes it convenient to differentiate supercooling from freezing-point depression. Supercooling is a metastable state; if a piece of ice emerges in supercooled water, supercooling ceases in a short time and a stable freezing occurs at the freezing-point temperature. In this sense, ice and supercooled water cannot coexist, except where water flows at high velocity as in the formation of anchor ice [21].

The water just below plane BB in Fig. 3 in the paper under discussion is supercooled. This situation results from the simplification adopted for mathematical analysis. However, the actual soil water under the ice-lens is not supercooled, but has a lowered freezing point.

In his consideration of the efficiency of frost-heaving, the author applies fixed boundary conditions for heat flow and water flow in order to compare frost-heavings caused by various materials. He believes that, if the analysis is carried out, the simple frost-heaving in the paper under discussion will show the best efficiency.

The entropy production is positive in the simple frost-heaving in Fig. 3, because temperature is decreasing upward. The second law of thermodynamics is used in this form in formulating the simultaneous flow of water and heat.

The third question raised by the author in the paper under discussion is not expressly answered, as pointed out by Everett. However, the answer is obvious in the explanation of the floating of particles in Corte's experiment. The explanation was first given by Jackson and Chalmers [19].

By "classical equilibrium thermodynamics" the author means what is known as "thermodynamics" in modern terminology. He considers the affinity concept of De Donder as a pioneering work in the construction of nonequilibrium thermodynamics.

Molecular force distortion causes "the preferential orientation" of dipole molecules. This statement is not clearly made in the paper under discussion, but the author's meaning should be understood from the context.

Everett says that the operation of a piston permeable only to water (Fig. C.1 in the author's discussion) implicitly assumes the effect of surface tension. His argument on this point is difficult to understand. The porous piston is a theoretical device that allows both application of stress on the ice surface and contact of the ice surface with water. Properties of the porous piston may not be considered. What must be considered is a model that allows analysis of the thermodynamic equilibrium between the ice on plane BB and the water just below plane BB in Fig. 3 in the paper under discussion, which is a segment of a system that may be extended indefinitely in horizontal directions and does not include any capillary action. The porous piston in Fig. C.1 may be replaced with a semi-permeable membrane that passes only liquid water and nothing else. Then, obviously, capillary action does not appear in the system in Fig. C.1.

The author appreciates the discussion by A. Assur, especially his recognition of the consistency of the theory in the paper under discussion.

Assur's correction of the paper results in the same equation as (C.3) in the author's supplement, if the datum of the pressure is appropriately chosen, as shown in the beginning of the

author's supplement.

In the latter half of his comment, Assur uses the original model and transforms the equation of energy balance at the freezing front, which is corrected in the author's discussion. His discussion, as he states, has academic but little practical interest.

It is interesting to note Anderson's paper in this volume, as discussed by Assur. Anderson's view may be important in considering freezing *in situ* (frost penetration); that is, the case where soil water is frozen almost in position, engulfing soil particles. It may not be important, however, in considering freezing by segregation (ice-lens formation); that is, the case where soil water is sucked up from a distant place to reach the freezing front. Freezing *in situ* is not important for our study in the sense that it is not detrimental.

The author regrets that, because of the policy of the conference, he could not revise the paper under discussion. Discussions during the conference and at USA CRREL enabled the author to make corrections and provide better explanations; these encouraged him to completely revise the paper. Author's current concepts will be systematized in another paper [20], consolidating all the discussions, correction, and comments made by the author in this subject prior to April 1964.

REFERENCES

- [1] W. Weeks. USA CRREL, private comm.
[2] D. H. Everett. "Thermodynamics of Frost Damage to Porous Solids," *Trans. Faraday Soc.*, 1961, pp. 1541-1551.
[3] C. Herring. "Surface Tension as a Motivation for Sintering," in *Physics of Powder Metallurgy*, ed. W. E. Kingston, McGraw-Hill, 1951, pp. 143-179.
[4] W. D. Kingerey. "Regelation, Surface Diffusion, and Ice Sintering," *J. Appl. Phys.*, Vol. 31, 1960, pp. 833-838.
[5] D. Kuroiwa. "A Study of Ice Sintering," *Tellus*, Vol. 13, 1961, pp. 252-259.
[6] P. V. Hobbs, B. J. Mason. "The Sintering and Adhesion of Ice," *Phil. Mag.*, Vol. 9, 1964, pp. 181-197.
[7] J. S. Marshall, Langleben. "A Theory of Snow Crystal Habit and Growth," *J. Meteorol.*, Vol. 11, 1954, pp. 104-120.
[8] B. J. Mason. "The Growth of Ice Crystals from the Vapour, and the Melt," *Advances in Physics*, Vol. 7, 1958, pp. 235-253.
[9] M. Kumai. USA CRREL, priv. comm.
[10] Z. Yosida, K. Kozima. "Change in Shape of Snow Crystals I," *Low Temperature Sci.*, Vol. 5, 1950, pp. 75-83 (in Japanese with English resume).
[11] K. Kozima. "Change in Shape of Snow Crystals II," *ibid.*, Vol. 9, 1952, pp. 187-203 (in Japanese with English resume).
[12] K. Kozima. "Change in Shape of Snow Crystals III," *ibid.*, Vol. 9, 1952, pp. 205-214.
[13] Z. Yosida. "A Quantitative Study of Metamorphosis of Snow Crystals," *ibid.*, Ser. A., Vol. 13, 1954, pp. 833-838.
[14] B. Chalmers, K. Jackson. Final Report to Contract DA19-016, Eng. Corps 5745, 1963.
[15] T. Hori. "Mizu no hakumaku no kareikyaku to johatsu I" (On the Supercooling and Evaporation of Thin Water Films), *Low Temperature Sci.*, Inst. Low Temperature Sci., Hokkaido Univ., Ser. A., Vol. 15, 1956, pp. 33-42 (U.S. Army SIPRE Transl. 62, 1960).
[16] K. Arakawa, K. Higuchi. "Studies on the Freezing of Water (1)," *J. Fac. Sci.*, Hokkaido Univ., Ser. 2, 1952, No. 3, pp. 201-208.
[17] R. G. Wylie. "The Freezing of Supercooled Water in Glass," *Proc. Phys. Soc.*, London, Vol. 66, 1953, pp. 241-254.
[18] C. Herring. "The Use of Classical Macroscopic Concepts in Surface-Energy Problems," in *Structure and Properties of Solid Surfaces*, ed. R. Gomer and C. S. Smith, Univ. Chicago Press, 1953, pp. 5-18.
[19] K. A. Jackson, B. Chalmers. "Freezing of Liquids in Porous Media with Special Reference to Frost Heave in Soils," *J. Appl. Phys.*, Vol. 29, 1958, pp. 1178-1181.
[20] S. Takagi. *Principles of Frost Heaving*, U.S. Army CRREL, Research Rept. 140, unpublished data.
[21] V. Altberg. "Twenty Years of Work in the Domain of Underwater Ice Formation (1915-1935)," *Intl. Union Geophysics Assoc., Sci. Hydrology Bull.*, No. 23, 1936, pp. 373-407.

Editor's note: Discussion by R. D. Miller of both Takagi papers (this and the next) follows the next paper.

THEORY OF FREEZING-POINT DEPRESSION WITH SPECIAL REFERENCE TO SOIL WATER

SHUNSUKE TAKAGI, U.S. Army Cold Regions Research and Engineering Laboratory

Since Bouyoucos [1, 2] showed that some part of water in a clay-water mixture did not freeze even at -78°C , the theoretical basis for the freezing-point depression of soil water has been discussed by many authors (Edlefsen and Anderson [3]; Winterkorn [4]; Babcock and Overstreet [5, 6]; and Tsyrovich [7]). However, it is only recently that a satisfactory theoretical explanation for this phenomenon was found (Takagi [8, 9]). The explanation is now extended further to give a deeper understanding of the freezing of water. Also, the assumption adopted in the classical theory of freezing-point depression is discussed.

Although the theory of freezing-point depression of a solution is stated in almost all textbooks on thermodynamics, the freezing-point depression of other water forms, such as capillary water, adsorbed water, and soil water cannot be explained without an extension of the classical concept of thermodynamics. This is done through the use of fugacity—a more convenient concept than the abstract one of Gibbs' free energy. Fugacity may be identified with vapor pressure, thus giving a physical concept to afford deeper insight into the phenomenon. In this way, an arbitrarily large freezing-point depression of any water form is expressed in terms of vapor

pressure in equilibrium with the water form considered.

Supercooling (metastable state) should be strictly distinguished from freezing-point depression (stable state). The distinction is shown through clarification of the meaning of freezing with freezing-point depression.

TERMINOLOGY

Suppose that a bottle of water is put in a cold chamber where temperature is shown by the ordinate of E in Fig. 1. Initially, the water temperature is at A. When the water cools to B, crystallization begins; the temperature is termed temperature of initial crystallization. This temperature is determined by some unknown intrinsic properties of the water and the included contamination.

As crystallization proceeds, the mixture of ice and water becomes warmer because of the release of latent heat. At C, the stable freezing temperature is reached. Then, as long as the system is a mixture, the temperature remains constant as shown by CD. At D, the system is composed of ice only. From this point on, the system becomes cooler again as shown by DE, and asymptotically approaches the ambient temperature

- A Initial temperature of the sample.
- B Temperature of initial crystallization.
- C-D Temperature of stable freezing.
- E Ambient temperature.
- E' Ambient temperature that causes supercooling.

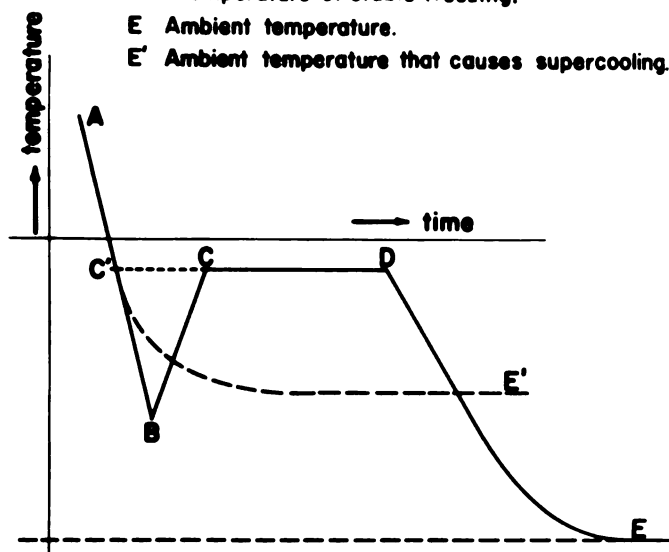

Fig. 1. Freezing process of water

indicated by E.

Locate C' on line AB so that C' has the same ordinate as C. Then the water sample between C' and B is supercooled. As soon as crystallization starts at B, the temperature of the ice water mixture rises to that of stable freezing at CD. If, on the other hand, the ambient temperature given by E' is higher than the temperature of initial crystallization B, but lower than the temperature of stable freezing CD, then the water sample is supercooled but does not start to freeze. E must be lower than B for initial crystallization. For crystallization to start in the supercooled water, the initial crystallization temperature must be raised by an adequate change in the appropriate intrinsic water properties and/or included contamination.

Even though a water sample reaches the initial crystallization temperature, latent heat may flow from the sample so rapidly that the system cannot reach the stable freezing temperature. This is the case with small quantities of water. If the quantity is sufficiently large, however, the inside of the sample will become warm enough to maintain the stable freezing temperature.

The stable freezing must be clearly differentiated from the supercooling. At the stable freezing temperature (CD, Fig. 1), water and ice can be in thermodynamic equilibrium if the experiment is performed adequately. In the experiment mentioned (Fig. 1), heat is flowing from the sample during the time interval corresponding to CD. However, if the ambient temperature is suddenly raised during this interval to temperature CD, then the same proportion of ice and water will be maintained indefinitely. The system is then in thermodynamic equilibrium.

The supercooled water (at E', Fig. 1) also can maintain the same status indefinitely, if isolated from any disturbance from outside the sample. But this status is metastable and is not in thermodynamic equilibrium because even a small disturbance of the sample can cause initial crystallization as a result of changes in some intrinsic properties of the water and/or contamination.

In the case of soil water, the water status is not the same throughout the system. The capillary water is free water under the influence only of the menisci. As explained later, the stable freezing temperature is the highest in this portion of the system. In the layer of adsorbed water surrounding a soil particle, the stable freezing temperature will decrease from the outside toward the soil particle surface. In other words,

capillary water freezes first, and then the adsorbed water freezes gradually from the outside of the adsorbed water layer inward toward the surfaces of the soil particles. Therefore, the portion representing the stable freezing process of soil water (CD, Fig. 1) is not horizontal but slopes to the right (Beskow [10], Fig. 22; Haley [11], Fig. 9; Linell and Kapler [12], Fig. 4; Swinzow [13]).

THEORY OF DETERMINING THE STABLE FREEZING TEMPERATURE

It is well known that, as compared with pure water, an aqueous solution shows a depression of stable freezing temperature. However, it is not so well recognized that capillary water, water adsorbed on a solid material, and some other water forms also show depressions of stable freezing temperature. A theoretical basis is presented by which all these phenomena are explained.

The essence of the theory of freezing-point determination in classical thermodynamics is: When two phases of a substance are in phase equilibrium, the Gibbs' free energies per unit mass of the two phases must be equal. The functional forms of the Gibbs' free energies of the two phases are different, but in phase equilibrium they have the same numerical value. When one or both of the phases are multi-component, the Gibbs' free energies per unit mass in the theorem should be replaced by the chemical potentials of each component. Let G(1) and G(2) be the Gibbs' free energies of phases 1 and 2, respectively, and let $\mu_i^{(\nu)}$ be the chemical potential of the *i*th component in the ν th phase ($\nu = 1, 2$). Then, for each phase (ν)

$$G^{(\nu)} = \sum_i \mu_i^{(\nu)} m_i^{(\nu)} \quad (1)$$

where $m_i^{(\nu)}$ is the mass of the *i*th component in the ν th phase, and the summation is made with regard to the components. The thermodynamic theorem for the equilibrium of the multicomponent system of two phases is then

$$\mu_i^{(1)} = \mu_i^{(2)} \quad (2)$$

for all components (*i*).

First, suppose a space is filled with both the liquid and solid phases of a substance and with no other substances. Then, the vapor phase of the same substance cannot exist in equilibrium except where the system is at the triple point. However, if it may be assumed that the vapor is an ideal gas, the vapor pressure at which the vapor has the same value of Gibbs' free energy per unit mass as the liquid or solid phase is easily calculated. The vapor pressure thus determined may be used instead of the abstract Gibbs' free energy concept to obtain a more lucid understanding of phase equilibrium. However, the vapor pressure must not be confused with the actual vapor pressure. In chemistry, the vapor pressure thus defined is called fugacity (or escaping tendency) [14]. This usage is followed to avoid confusion. Fugacity is a substitute for Gibbs' free energy per unit mass, or chemical potential, and may be identified with the actual vapor pressure when the vapor, considered ideal, is in equilibrium with the existing liquid or solid phase.

If one or both of the phases are multicomponent, it is easy, assuming the vapor phase to be a mixture of ideal gases, to calculate the vapor pressure of a component substance at which its vapor, if brought into direct contact with another phase, will have the same chemical potential as the component substance in this other phase. The vapor pressure thus determined is equal to fugacity. This approach is possible even though the vapor phase may not actually exist in the system. The fugacity of a component of the multicomponent system is thus defined.

For example, let us consider an aqueous solution, the water in the meniscus of a capillary, the water adsorbed on a solid material, or combinations of these such as an aqueous solution in the meniscus of a capillary or an aqueous solution adsorbed on a solid material. It is assumed that all these

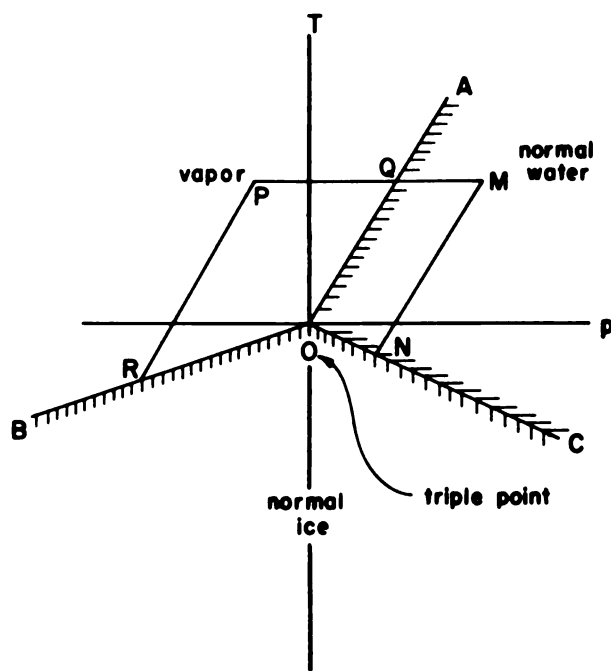

Fig. 2. Schematic representation of the phase diagram of water

liquids are in equilibrium with water vapor of equal vapor pressure. Then, from the thermodynamic theorem stated above, all water forms in these liquids have the same amount of Gibbs' free energy per unit mass, or chemical potential, and, therefore, the same amount of fugacity. The use of fugacity has an advantage over the use of the Gibbs' free energy per unit mass, or chemical potential, in the theory of freezing-point determination developed below.

Fig. 2 shows schematically the phase diagram of water. The abscissa may be either vapor pressure or fugacity. Now there may be a wider application of the phase diagram concept. The portion of the abscissa where the fugacity is negative is not considered.

Consider the forms of water in a meniscus, water in an aqueous solution, water adsorbed on a solid material, and combinations of these. It is known that vapor pressures, or fugacities, of these special water forms are smaller than the saturated vapor pressure at the same temperature. A point, such as P, representing the equilibrium of these special water forms must be located to the left of point Q on line OA, the normal-liquid/vapor boundary (Fig. 2).

The water may not be in direct contact with water vapor, because fugacity is considered instead of vapor pressure. Moreover, the liquid phase may not be uniform, since the point-to-point distribution of fugacity may be considered in the liquid phase. For instance, the liquid phase may be adsorbed water on a solid where the adsorption force increases inward toward the solid surface. It is known that the thinner the adsorbed layer the smaller the water-vapor pressure that is in thermodynamic equilibrium with the liquid water at the adsorbed-layer surface. It may be assumed, on this basis, that fugacity decreases from the outside of the adsorbed layers inward toward the solid surface (Appendix 1).

Suppose that the water represented by P is cooled. Then it will move from P along a curve PR, a locus of the cooling process, and will eventually reach OB, the water vapor/normal-ice boundary. An important assumption in the classical theory of freezing-point determination is that ice formed from any water form is the same as normal ice. Then R is the freezing point of the water specified, i.e., where it is in equilibrium with normal ice. This assumption implies that the ice formed has the same thermodynamic properties in all cases. The possibility that in some cases surface properties

or crystal dislocation enter significantly is neglected. This fact will be evident in the discussion section.

Thus, a locus of the cooling process is important for freezing-point determination. In the case of an aqueous solution, it is assumed that water fugacity is determined only by water concentration without reference to any other condition. Therefore, the locus PR of cooling an aqueous solution may be determined on the condition that the water concentration in the solution is constant. When the changes of p and T are small, the locus PR determined on this assumption is a straight line parallel to OA (Appendix 2). As a part of the water turns to ice in the aqueous solution, the water concentration decreases; the water fugacity in the aqueous solution then becomes smaller, and the stable freezing temperature decreases gradually. Thus, the portion corresponding to CD (Fig. 1) in the freezing curve of aqueous solutions slopes to the right. It is interesting to note that, to formulate the freezing-point depression of a solution in the neighborhood of a triple point, "Chemistry Made Simple," Hess [15] uses a graphical method that is essentially the same as the method here but made simpler by introducing empirical data.

In the case of adsorbed water, the locus PR may be determined on the condition that the ratio of the adsorbed-water fugacities and the saturated water vapor is constant. Then, if the change of p and T is small, PR is again parallel to OA (Appendix 2). It is now clear that the equilibrium freezing temperature of the adsorbed water decreases from the outside toward the solid surface, because the adsorbed-water fugacity decreases from the outside.

However, in some liquid water forms, the freezing process is very complicated, and cannot be described. For instance, in the case of soil water, the water fugacity is dependent on the geometry of the accumulation of soil particles and ice because of the existence of menisci and adsorbed layers. The capillary water will freeze first. Then, because of expansion during the freezing process, soil particles will move and will not be in the original position. Moreover, the existence of ice will change the fugacity value because of the existence of surface tension of ice. For such water forms, the stable freezing temperature of the water represented by P cannot be correctly described.

A water drop has a vapor pressure higher than the saturation value for bulk water. Therefore, the point representing the phase equilibrium of a water drop is to the right of Q, say at M (Fig. 2). If it may be assumed that the radius of the water drop is constant while the water drop is cooled, then the cooling process MN can be located. If the assumption in the classical theory of freezing-point determination is fulfilled, N, at which the locus MN meets OC, is the stable freezing point. Then, the temperature of stable freezing of a water drop is also depressed, although the amount of depression is very small, as may be derived by a method similar to that used by Takagi [8, 9]. However, because of the small volume of the water drop, the latent heat evolved during the phase change is not usually sufficient to raise the stable, freezing temperature. Thus, the portion corresponding to CD (Fig. 1) cannot usually be realized in the freezing process of water drops.

It is well-known that any vapor becomes ideal as it is rarefied. In the temperature range of concern here, the assumption of ideality for water vapor is sufficiently correct as shown in Table 1. When the pressure is smaller than the saturation value, the discrepancy becomes smaller than those indicated.

LARGE DEPRESSION OF STABLE FREEZING TEMPERATURE

The cooling process in which p/p_0 is kept constant, p being smaller than p_0 , is considered. Then, when the assumption in the classical theory of freezing-point determination is fulfilled, a water sample will start to freeze at the temperature where $p = p_1$, in which p_1 is the ice-saturation pressure of water vapor (i.e., the water-vapor pressure in thermodynamic equilibrium with the flat surface of ice). The restriction that

in the cooling process p/p_0 is kept constant is not important. If this requirement is not met in a cooling process, we should consider a neighborhood of the stable freezing temperature where the requirement is sufficiently fulfilled.

Washburn [16] derived a formula for p_i/p_w , where p_w , the water-saturation pressure of water vapor (i.e., the water-vapor pressure in thermodynamic equilibrium with the flat surface of supercooled water) is used instead of p_0 . The relation between the freezing-point depression terms and p/p_0 determined by use of Washburn's formula (Fig. 3) is

$$\log \frac{p}{p_0} = -\frac{1.1489 \Delta T}{273.1 - \Delta T} + 1.330 \times 10^{-5} (\Delta T)^2 + 0.9084 \times 10^{-7} (\Delta T)^3 \quad (3)$$

The first term in the right hand side of (3) is given by the formulation in the classical theory of freezing-point determination, as shown by Takagi [8, 9].

Washburn's derivation is based on the empirical formulas of c_w and c_i , the specific heat at constant pressure of supercooled water and ice, respectively. The formula of c_w is determined using the data of Barnes and Cooke obtained at only three points: 5°, 0°, and -5°C. The formula for c_i is the one obtained by Dickinson and Osborne, which is known to be valid between 0° and -40°C. (The value 0.5952 in the formula of c_i in Washburn's paper is a misprint. Cf. Dorsey [17], pp. 479 and 562.) Even though Washburn's formula is an extrapolation, it agrees well with the empirical data. When he compared the values of $p_i - p_w$ calculated by his formula with the corresponding differences between directly measured values obtained by Reichsanstalt, he found that the maximum value of $(p_i - p_w)$ calculated - $(p_i - p_w)$ observed is only 0.004 mm of Hg at -16°C and decreases as 0°C is approached. According to him, the temperature measurement by Reichsanstalt was uncertain. However, an uncertainty in the temperature scale has a much smaller influence on $p_i - p_w$ than it does on p_i and p_w separately.

More recent data by use of Goff-Gratch formulation [18] indicates that the graph (Fig. 3) is sufficiently reliable between $\Delta T = 0^\circ \sim 50^\circ \text{C}$. The Goff-Gratch formula of p_w is believed to be accurate as far as $\Delta T = 50^\circ \text{C}$, but the curve for p_w/p_i obtained by use of Goff-Gratch formulas is not reasonable when extended beyond $\Delta T = 50^\circ \text{C}$.

DISCUSSION

To determine the chemical potential of water, G_w , the surface energy of liquid water must be considered when it is important,

as in the case of a water drop. The surface energy of ice is never considered because of the assumption with regard to the state of ice in the classical theory of freezing-point determination. If the surface energy of ice is considered, OB and OC (Fig. 2) may shift to other positions in the same manner as OA shifts to MN.

Precisely speaking, the body energy represents the energy in a homogeneous phase, and the surface energy must be taken as the energy in a heterogeneous phase. The homogeneous phase in a block of ice is the single crystals as component crystals of the polycrystalline structure of ice. Internal boundaries between single crystals and external boundaries exposed to other substances outside the ice are heterogeneous phases. The energy contained in a heterogeneous phase may be taken as proportional to the area of the boundaries, although the proportionality constants may be different with different boundary forms. According to this consideration, the chemical potential (μ_i) of ice is

$$\mu_i = \frac{\partial G}{\partial M} \quad (4)$$

where

$$G = \sum_i g_i m_i + \sum_s \sigma_s f_s \quad (5)$$

in which g_i and m_i are, respectively, the Gibbs' free energy per unit mass and the mass of one of the component single crystals; σ_s and f_s are, respectively, the surface energy per unit of area and the surface area of one of the boundaries; and M is the total mass of water substance contained in the ice block. Summations of the first and second terms extend to all single crystals and to all internal and external boundaries, respectively. Then μ_i changes with the size of component single crystals. Moreover, it is necessary to introduce dislocation effects in the formulation, although this introduction is still impossible with present knowledge.

It seems likely that the stable freezing temperature determined with the inclusion of surface energy and dislocation will be lower than the stable freezing temperature determined by use of only body energy. This assumption, if true, leads to the following interpretation of the assumption in the classical theory of freezing-point determination that the ice formed from any water form is the same as normal ice: The size of component single crystals is so large at the stable, freezing temperature that the effect of surface energy may be neglected in the determination.

However, in some water forms such as a small water drop and a thin layer of adsorbed water, the maximum size of single

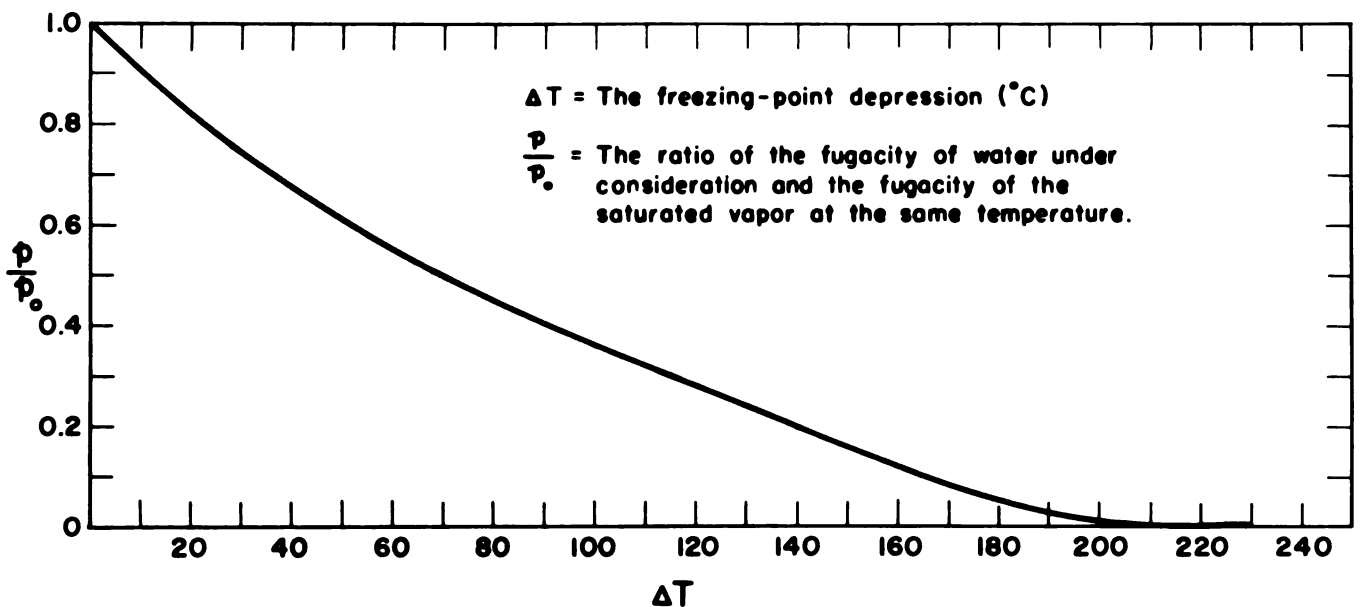

Fig. 3. The relation between ΔT and $\frac{p}{p_0}$

crystals formed in the system is limited. Then the actual stable freezing temperature will be lower than when determined by use of the classical assumption.

This discussion may be too simple to signify the actual freezing process inside the solid phase. Necessity for detailed study in connection with the freezing process is indicated.

APPENDIX 1. CHEMICAL POTENTIAL IN AN ADSORBED LAYER

Thermodynamic equilibrium in the field of potential ϕ is determined by

$$\mu + \phi = \text{const.} \quad (6)$$

where μ is the chemical potential of the considered substance. The meaning of this equation becomes clear when the gravitational field is considered. Potential ϕ changes with altitude, and equilibrium of the substance is governed by (6). The freezing point is directly determined by μ , being indirectly influenced by altitude.

In an adsorbed layer it is difficult to know whether the force of field has a potential. But for simple treatment, it may be supposed that ϕ becomes larger inward toward the solid surface. This treatment is made rigorous in the text by use of the physical meaning of fugacity.

APPENDIX 2. FREEZING LOCI IN THE NEIGHBORHOOD OF THE TRIPLE POINT

Let μ_w and p be chemical potential and fugacity of the water form under consideration, respectively, at temperature ($T^\circ\text{K}$); let G_o and p_o be chemical potential and fugacity of the water with a flat surface, respectively, at temperature ($T^\circ\text{K}$); then

$$\mu_w = G_o + \frac{RT}{M} \log_e \frac{p}{p_o} \quad (7)$$

where R is the gas constant, and M is the molecular weight of water.

Substitution of the relations

$$\log_e \frac{p}{p_o} = \log_e \left(1 - \frac{p_o - p}{p_o} \right) \approx \frac{p_o - p}{p_o} \quad (8)$$

and

$$\frac{RT}{M} \frac{1}{p_o} \approx v_o \quad (9)$$

changes (7) to

$$G_o - \mu_w \approx v_o (p_o - p) \quad (10)$$

Therefore PR or MN is almost parallel to OA in the neighborhood of the triple point (Fig. 2).

The following values were obtained from C_v in Smithsonian Meteorological Table 91 [18].

Temp., °C	$p_o v/RT$	Temp., °C	$p_o v/RT$
-50	1.0000	10	0.9992
-40	1.0000	20	0.9988
-30	0.9999	30	0.9982
-20	0.9998	40	0.9973
-10	0.9997	50	0.9962
0	0.9995	60	0.9948

REFERENCES

- [1] G. J. Bouyoucos. "A New Classification of Soil Moisture," *Soil Sci.*, Vol. 11, 1921, pp. 33-48.
- [2] G. J. Bouyoucos. "The Dilatometer Method as an Indirect Means of Determining the Wilting Point of Soils," *ibid.*, Vol. 42, 1936, pp. 217-223.
- [3] N. E. Edlefsen, A. B. C. Anderson. "Thermodynamics of Soil Moisture," *Hilgardia*, Vol. 15, 1943, pp. 31-298.
- [4] H. F. Winterkorn. "The Condition of Water in Porous Systems," *Soil Sci.*, Vol. 56, 1943, pp. 109-115.

- [5] K. L. Babcock, R. Overstreet. "Thermodynamics of Soil Moisture: A New Application," *ibid.*, Vol. 80, 1955, pp. 257-263.
- [6] K. L. Babcock, R. Overstreet. "The Extra-Thermodynamics of Soil Moisture," *ibid.*, Vol. 83, 1957, pp. 455-464.
- [7] N. A. Tsytoovich. "Bases and Foundations on Frozen Soil," 1958 (transl. *Highway Res. Bd. Spec. Rept. 58*, 1960).
- [8] S. Takagi. *Theoretical Considerations on the Thermodynamic and Kinematic Properties of the Soil Moisture*, spec. sci. rept. Fac. of Agr., Tokyo Univ. Agr. Tech., Fuchu, Tokyo, 1953 (out of print).
- [9] S. Takagi. "Theory of Freezing-Point Depression of Soil Water, and a Note on the Extra-Thermodynamics of Soil Moisture," *Soil Sci.*, Vol. 88, 1959, pp. 25-31.
- [10] G. Beskow. *Soil Freezing and Frost Heaving with Special Application to Roads and Railroads*, Swedish Geol. Soc., 1935, (transl. by J. O. Osterberg, publ. by Technol. Inst., Northwestern Univ., 1947).
- [11] J. F. Haley. "Cold-Room Studies of Frost Action in Soils, a Progress Report," *Highway Res. Bd. Bull. No. 71*, 1953, pp. 1-18.
- [12] K. A. Linell, C. W. Kaplar. "The Factor of Soil and Material Type in Frost Action," *Highway Res. Bd. Bull. No. 225*, 1959, pp. 81-128.
- [13] G. Swinow. "Laboratory Investigations of Freezing with Reference to Frozen Ground," *USA CRREL Res. Rept. 92* (unpublished data).
- [14] G. N. Lewis, M. Randall. *Thermodynamics* (2nd ed., revised by K. S. Pitzer and L. Brewer), McGraw-Hill, 1961.
- [15] F. C. Hess. *Chemistry Made Simple*, Doubleday.
- [16] E. W. Washburn. "The Vapor Pressure of Ice and of Water Below the Freezing Point," *Monthly Weather Rev.*, Vol. 52, 1924, pp. 488-490.
- [17] E. N. Dorsey. *Properties of Ordinary Water-Substance*, Reinhold, 1940.
- [18] Smithsonian Inst., *Smithsonian Meteorological Tables* (6th revised ed.), 1951.

DISCUSSIONS

AUTHOR'S SUPPLEMENT—The author feels obligated to add a supplement to this paper since realizing, after the paper was submitted to the conference, that the most important objective may not be clear: Namely, to demonstrate the limited usefulness of classical thermodynamics for the theory of freezing-point determination and also for the thermodynamics of soil moisture. The first step is, as shown in the paper, to simplify existing concepts on freezing-point determination.

Since Jackson and Chalmers have attributed the energy source of frost-heaving to the supercooling of soil water, a certain confusion seems to have resulted regarding the concepts of supercooling and freezing-point depression of soil water. The experimental distinction of the two concepts is sometimes difficult, but theoretically they are clearly differentiated. It seems that knowledge of this distinction is the first step for theoretical understanding of the frost-heaving problem.

Explanation of the theoretical distinction becomes very easy and understandable when the concept of fugacity is adopted. As shown in the text, the explanation requires only the physical concepts of vapor pressure and the use of the phase diagram.

Part of the phase diagram concept has been applied in the past to explain the change of freezing point. For the freezing-point depression of solution, the vapor-solid curve is used in the phase diagram of the liquid under consideration. For the solidification of pure liquid under pressure, the liquid-solid curve is used. In soil physics the water-ice curve, when once used to interpret the freezing-point depression of capil-

lary water, showed incorrectly that the freezing point of soil water rises as the pressure is decreased. Use of the entire concept of phase diagram is achieved only through the physical concept of fugacity.

The large freezing-point depression is first formulated in the paper by extending the above concepts. It is interesting that, as explained in the text, the freezing-point depression is dependent on the cooling process of the sample. This fact is especially remarkable for a large freezing-point depression. Although it is rather easy to plot theoretically in the phase diagram the cooling process of an aqueous solution, a water drop, and water at the meniscus of fixed radius, it is very difficult to plot theoretically the cooling process of soil water. Therefore, precisely speaking, the freezing point of soil water cannot be defined without specifying the cooling process, although it may be defined for some other water forms by such conditions as a constant concentration of solutes or a constant radius of curvature during the cooling process.

Difficulty arises in connection with the heterogeneous and non-Pascalian nature of adsorbed water. (For an explanation of the non-Pascalian state, see "Fundamentals of the Theory of Frost-Heaving" in this volume.) It is well established that even at a very low temperature a certain amount of soil water still remains unfrozen, and the lower the temperature the smaller the amount of unfrozen water. Explanation of this fact is one of the main objectives of the thermodynamics of soil moisture. However, thermodynamics of soil moisture is essentially that of homogeneous (capillary) water. PV thermodynamics does not apply to the adsorbed (non-Pascalian) water. It is possible to develop the non-PV thermodynamics, but the heterogeneity cannot be described at present even with the most advanced knowledge of theoretical physics.

An adaptation of the homogeneous PV thermodynamics to the adsorbed water has been attempted by several authors including the present writer. The physical fact leading to this adaptation is the following: The thinner the adsorbed layer, the lower the pressure of water vapor in equilibrium with the adsorbed layer. Therefore, it may be assumed that the fugacity of water becomes smaller in the adsorbed layer nearer to the solid particle.

An interpretation of this view by use of homogeneous thermodynamics is the introduction of the adsorption potential as shown in Appendix 1 of the paper. However, the adsorption potential thus introduced is quite different from the potentials familiar in physics. The force field of the adsorption potential is formed by the solid particle on which the layer is adsorbed and also by the layer that is adsorbed on the particle. The surrounding substance must be considered in the determination of the potential. This force field is restricted to the inside of the adsorbed layer, and varies with the thickness of the layer. It may be doubtful if a potential exists for such a force field.

Although the interpretation is not satisfactory, the foregoing assumption appears to be true with regard to the distribution of fugacity inside the adsorbed layer. If true, the assumption may be used from the classical theory of freezing-point determination: That the ice formed from any water form is the same as normal ice. This means that only water properties determine the freezing point, regardless of the ice properties. Then, the fugacity of the water determines the freezing point, if the cooling processes are adequately restricted. This is the view adopted in the freezing-point depression paper.

This view, however, is still debatable. The ice formed in the adsorbed layer is very small because the adsorbed water must freeze layer by layer. Then, the surface energy of an ice crystal is relatively large as compared with the volume energy. The form of ice probably must be considered to determine the freezing point. In this case, the assumption in the classical theory of freezing-point determination may not be valid.

DISCUSSION OF TAKAGI PAPERS

R. D. MILLER—Takagi's enthusiasm for his subject, and his prolific pen, produced five manuscripts where he intended to

write but one. The first two brought reactions that evoked two more before the Permafrost International Conference convened. Public and private discussions at the conference raised issues which inspired the fifth manuscript. It seems improbable that space will permit publication of the whole sequence, nor can the wide-ranging discussion be reproduced. I have chosen, therefore, to merely list some personal views that seem to me to differ from Takagi's views in one or another of his manuscripts. As a consequence, some may seem to be irrelevant to that which may actually appear as Takagi's contribution to the conference.

1. It seems to me that the choice between fugacity and free energy as the most suitable thermodynamic quantity for a discussion of freezing-point depression of soil water is entirely a matter of taste. I see no particular advantage to Takagi's choice of fugacity for this purpose. Though they appear in different form, the identical problems are encountered whatever choice is made.

2. In the limiting case, frost-heaving may be regarded as a reversible pressure-volume heat engine. It is not necessary to look to the thermodynamics of irreversible systems to understand how the work of heaving can be obtained. Water migration toward a growing ice-lens can be treated in the conventional mechanical manner. It is not dependent on a temperature gradient and a concurrent transport of heat (other than latent heat) in the same direction. Identifying "the source of energy for the work of heaving" is purely an arbitrary matter determined by the system of bookkeeping chosen.

3. At first, Takagi worked from the premise that the pressures in ice and water phases in heaving systems were equal. It is gratifying to note that he abandoned this idea in a later manuscript.

4. Pascal's principle is, in effect, a statement of the uniformity of specific potential energy of water throughout a body of a Newtonian liquid at rest in the Earth's gravitational field. The "non-Pascalian behavior" of water in the Corte experiment discussed by Takagi is referred to this model. If the principle is extended, however, so that the separate effects on potential energy due to gravity and the local adsorptive fields that are presumed to exist near soil particles are combined, it follows that there must be a perturbation in the vicinity of the particle and one may assume that the pressure field acquires a configuration that will support the particle. In this broader sense, the behavior of the water in supporting the particle can be regarded as "Pascalian" and it is not necessary to assume non-Newtonian properties—i.e., static resistance to shearing force—for the water in the film. Indeed, a model that requires rigidity of the adsorbed water in order to support the particle would seem to preclude the mobility of water in the film that is necessary to the explanation of Corte's experiment. If Pascal's principle is restricted to the effect of gravitational potential energy only, then it is necessary to speak of non-Pascalian behavior, but it is unnecessary to postulate non-Newtonian properties for the film.

5. I trust that Takagi has made corrections in his remarks about adsorption potential, as used in an appendix to his original paper on freezing-point depression. Within a particular film, fugacity must be uniform; but it may change as film thickness changes.

6. Until it is proven otherwise, it seems reasonable to suppose that an ice-lens forms in a condition of isostasy. It may be, as Takagi remarks, that small grains of ice are not likely to be spherical, but this is incidental, and is a way of saying that σ in the Gibbs' equation varies with the crystallographic orientation of the surface exposed. The point is that if the unfrozen film that separates the ice phase from the mineral particle does not transmit shearing stresses to the ice, there are sufficient degrees of freedom in film pressure, pore water pressure, interfacial curvature and surface energy to permit the ice to be free of internal shearing stresses. I regard Takagi's statement that "ice in soil is under intergranular stress, and never under pressure" to be unproven and probably incorrect so long as an unfrozen film persists between ice and the neighboring soil particles.

D. H. EVERETT—Takagi claims that the problems of water in soils "cannot be explained without an extension of the classical concept of thermodynamics. This is done through the use of fugacity..." Having defined fugacity in terms of Gibbs' free energy per unit mass, or the chemical potential, and having given the relation between fugacity and vapor pressure, the author says: "The use of fugacity has an advantage over the use of the Gibbs' free energy, or the chemical potential, in the theory of freezing-point determination developed below." In fact, this, of course, gives no deeper insight into the problem, but only changes the nomenclature.

In the first part, the author gives a clear exposition of well-known principles and then discusses the very difficult problem of the nature of "adsorbed" water near the surface of a solid. His conclusions regarding the fugacity near a surface are open to discussion, but what is more important is that, in discussing the equilibrium between adsorbed water and ice crystals, (presumably in adjacent elements of volume), the author makes the assumption not only that the ice formed is the same as normal ice, but that it is unaffected by the adsorption field. To attempt to discuss a phase equilibrium in which one phase is affected by the adsorption field, and the other is not, seems to be quite unjustified.

Takagi realizes that problems arise if it is necessary to consider the free energy of the interface between ice and water. (His discussion of the phase diagram for freezing of a water droplet is, incidentally, dealt with, together with a range of similar problems, by Defay and Prigogine, *Tension Superficielle et Adsorption*, Desoer, Liege, 1951.) He concludes that: "It seems likely that the stable freezing temperature determined with the inclusion of surface energy and dislocation will be lower than the stable freezing temperature determined by the use of only body energy. This assumption, if true,..." He gives no rigorous discussion of this problem.

It seems to me that the problems of freezing equilibria are, in principle, now solved for those cases in which the solid phase is small, the liquid-vapor interface is curved (Defay and Prigogine), or ice-lensing occurs. What is not solved is the problem of phase equilibria when both phases are considered in an adsorption field near another solid surface. This problem is relevant, for example, to the question of whether there is a liquid film between an ice-lens and a soil particle: Its solution may well require a much more detailed analysis of the thermodynamics and hydrodynamics of heterogeneous layers (e.g., following the work of Buff or of Cahn and Hilliard). The present paper does not, I think, do more than recapitulate already known ideas and discuss the physically unreal situation in which only the liquid phase is subjected to the adsorption potential.

P. F. LOW—There are two significant errors in this paper. The first is that the fugacity for a component in a mixture is defined in terms of the partial molar free energy, (\bar{F}) and not in terms of the chemical potential, (μ). This fact is shown by referring to page 205 of *Thermodynamics* by Lewis and Randall. On the same page the statement is made, "a system is in equilibrium when, and only when, the fugacity of every substance is constant throughout..." Therefore, the author is in error when he states that the fugacity of the adsorbed water varies with distance from the solid surface at equilibrium.

Gibbs defined the chemical potential in discussing systems, "uninfluenced by gravity, electricity, distortion of the solid masses, or capillary tensions." In such systems μ was shown to be the same in all phases at equilibrium. But when he discussed systems influenced by gravity, the sum $\mu + gh$ was shown to be the quantity that was constant throughout the system at equilibrium. However, the quantity \bar{F} includes any gravitational effects or effects of electricity, surfaces, etc., (pp. 242-251 in Lewis and Randall). Hence,

$$\bar{F} = \mu + \theta$$

where θ is the molar potential energy in a force field. The last equation was discussed by Low (Soil Sci. 71: 409-418, 1951). Thus, μ can change with position in a force field and

may not be constant throughout a system at equilibrium. The quantity \bar{F} does not change with position at equilibrium. And, as noted, fugacity is defined in terms of \bar{F} and not μ .

The second point is that, contrary to the statement made by the author in Appendix 1, μ does not necessarily determine the freezing point. For example, adding salt to a system will lower both \bar{F} of the water and its freezing point. But applying pressure to the system will have different effects on the two quantities: The increased pressure will increase \bar{F} , whereas, it will lower the freezing point. The familiar equation relating the relative partial molar free energy to the freezing point is valid only if the pressure is held constant.

CLOSURE—Session 4 discussions have stimulated the author to explore the implications of the theory of an earlier paper [1] and the present paper.

Fugacity was introduced by Lewis and Randall [2]. Miller follows their terminology. However, the fugacity used in the earlier [1] and also in the present paper is different from the fugacity of Lewis and Randall, when the field of external force is considered. Fugacity in this paper is called pseudofugacity to avoid confusion.

Lewis and Randall define fugacity [2, p. 154] to be equal to vapor pressure when the vapor is an ideal gas or a component of a mixture of ideal gases. This definition, however, is not observed in the case of a gravitational field [2, p. 492]. They define fugacity, f , to be constant throughout the field, which may be expressed by

$$\frac{RT}{M} \log p + gh = \frac{RT}{M} \log f \quad (A.1)$$

whereas the vapor pressure (p) of an ideal gas or of one of the components of a mixture of ideal gases, changes in a gravitational field with altitude (h)

$$\frac{RT}{M} \log p + gh = \frac{RT}{M} \log p_0 \quad (A.2)$$

in which p_0 is the vapor pressure of the component on the plane where $h = 0$, R is the gas constant, T is the absolute temperature, M is the molecular weight of the component, and g is the acceleration due to gravity.

Comparison of (A.1) and (A.2) shows that the fugacity (f) of the infinitesimal portion situated at altitude (h) is equal to p_0 but not to p , the vapor pressure of the infinitesimal portion considered.

The reason for their contradictory definition is probably that, since the system is in equilibrium under the influence of gravitation, no part of the system has any tendency to escape; therefore, fugacity (escaping tendency) must be defined to be equal throughout the system. Fugacity thus defined is not a state function except for the point where $h = 0$, because fugacity thus defined contains the location of the infinitesimal portion considered. Fugacity is useful to signify equilibrium with regard to motion, but it is inconvenient to consider thermodynamic properties, which cannot contain the location of the infinitesimal portion under consideration as an explicit variable.

The original definition, however, may be observed even in a gravitational field. When the vapor is one of the components of a mixture of ideal gases, pseudofugacity (f') is defined to be equal to vapor pressure even in a gravitational field, or, more generically even in a field of external force. When, more generally, the vapor, or any one of the components, is not an ideal gas, pseudofugacity (f') is defined by

$$\mu = \mu_\infty + \frac{RT}{M} \log \frac{f'}{p_\infty} \quad (A.3)$$

where μ is the chemical potential of the state under consideration, μ_∞ is the chemical potential of the state of which the vapor pressure (p_∞) is so small and any components that

are not ideal gases are so attenuated that the gaseous phase may be assumed as a mixture of ideal gases. The state for μ_∞ is not definite, but μ defined by (A.3) is definite. Choice of pseudofugacity seems to be the only course for extending classical thermodynamics to cover thermodynamics of adsorbed water, or, more generically, thermodynamics of a heterogeneous system, as explained in the following.

The motive for separating μ from gh [see (6) where $\phi = gh$ for a gravitational field] is that, since the location in a gravitational field has nothing to do with chemical properties, μ , the quantity responsible for chemical properties, should be separated from the effect of location, that is gh , for convenience of considering properties intrinsic to matter. However, the separation is difficult for some forces [3, p. 332], such as electric forces originating from molecules of the system under consideration. Such forces are essentially incorporated in properties intrinsic to matter.

Even for cases where μ cannot be separated from the potential of the field in which the material under consideration is situated, pseudofugacity may be defined, if the pressure of the vapor in equilibrium with a small part of the system (so small that the field force may be assumed to be constant in this part) can be defined either by an actual measurement, by a statistical calculation, or by an experiment in thought. Pseudofugacity thus defined is a state function of the infinitesimal portion in the system—condensed or gaseous, heterogeneous or homogeneous—even for the case where μ cannot be separated from ϕ . If we cannot find any operational definition of the vapor pressure, the use of pseudofugacity must be given up for it may not be a physical quantity.

It is pointed out that no proof has ever been shown of the existence of the adsorption potential ϕ in (6). Because of this reason and another that follows, use of (6) is avoided in the text; instead, the physical meaning of pseudofugacity is used. To recognize this, the derivation of (6) is examined. For simplicity, a one-component system will be considered in which temperature (T) is constant but pressure (P) is variable with location. The change of μ with the change of location r for this system is calculated

$$\begin{aligned} d\mu &= \frac{1}{\rho} dP \\ &= \frac{1}{\rho} dr \cdot \text{grad } P \\ &= dr \cdot F \end{aligned} \quad (\text{A.4})$$

where ρ is the density, a dot means scalar multiplication, and use is made of the equation of equilibrium of force

$$F - \frac{1}{\rho} \text{grad } P = 0 \quad (\text{A.5})$$

If F has a scalar potential, that is, if

$$F = - \text{grad } \phi \quad (\text{A.6})$$

(A.4) changes to

$$d\mu + d\phi = 0 \quad (\text{A.7})$$

which is (6).

It is known that some forces do not have any scalar potential. For instance, a magnetic force concurrent with an electric current has a vector potential, A , defined by

$$F = \text{rot } A$$

but does not have a scalar potential. For such forces, (A.4) cannot be reduced to (A.7). We must be prepared for a situation in which a force that does not have a scalar potential appears in the statistical treatment of a complicated system of adsorbed water, or, more generically, in considering thermodynamics of a heterogeneous system.

It should further be considered that adsorbed water around soil particles is to some extent in the state of a solid. According to the theory of surface tension, water in the air-water boundary has different principal stresses in different

directions to cause the effect of surface tension. (To the author's knowledge, [4] is the best summary on this subject. Miller's comment on this point is answered in the author's closure of another paper). In other words, the water at the air-water boundary is an extraordinary water that does not obey Pascal's principle postulated in hydrostatics. This extraordinary state is reached by molecular force distortion that leads to oriented arrangement of water molecules in the boundary layer. Because the same sort of phenomenon takes place even when air may be replaced by solid, it may be postulated that the adsorbed water around soil particles is an extraordinary water that does not obey Pascal's principle. Then, PV-thermodynamics does not apply, and the preceding derivation of (A.7) does not have any meaning.

In the case of adsorbed water around soil particles, it is difficult to find an operational definition of the pressure of the vapor hypothetically introduced in the layer. If water vapor is introduced in the system, the water molecules exposed to the vapor will rotate to have an oriented arrangement. The author does not know whether the preferential orientation thus induced on the water molecules causes a change of the chemical potentials. The water molecules outside the gas-liquid interface, however, do not rotate and their chemical potentials are equal to the chemical potential of the water vapor hypothetically introduced. If the water molecules outside the interface may be used for determining the pseudofugacity, or if the preferential orientation of water molecules does not change the chemical potentials, the pseudofugacity of the small part under consideration is defined without difficulty. If none of them can be used, the author hopes that a sophisticated operation will define the pressure of the vapor hypothetically introduced in the system. The theory developed for the adsorbed water in the paper under discussion is based on the assumption that pseudofugacity can be defined even in the adsorbed water, or, more generically, even for a heterogeneous system.

It is known that the pressure of the vapor in equilibrium with a stressed heterogeneous phase changes when the interface is rotated (Yoshida [5]). Chances are that pseudofugacity in a stressed heterogeneous system, if defined, will be expressed, not as a scalar, but as a tensor.

Pseudofugacity, if defined, is a thermodynamic property of the system considered—heterogeneous or homogeneous, liquid or solid. If the pseudofugacity of a liquid or a solid be formulated in terms of intrinsic properties of the liquid or the solid, eliminating all the quantities related to vapor, all the thermodynamic properties of the liquid or the solid will be known. Such a complete use of pseudofugacity for the adsorbed water is impossible at present because of its complicated nature; nevertheless, some information is obtained by use of the numerical equality of the pseudofugacity with the vapor pressure regarded as an ideal gas.

"It is known that the thinner the adsorbed layer the smaller the pressure of water vapor that is in thermodynamic equilibrium with the liquid water at the surface of the adsorbed layer. It may be assumed, on this basis, that the (pseudo-) fugacity decreases from the outside of the adsorbed layers inward toward the solid surfaces" is quoted from the present paper. The logic adopted here is not without flaw, but the same logic is always used for the study of the change of a property inside the adsorbed water. Note that (6) is not used here, and also that, even though the water under consideration may be the extraordinary water, this reasoning is still valid because of the numerical equality of the pseudofugacity with the vapor pressure.

Two different concepts are traditionally employed to explain the freezing-point depression of soil water. One is the concept developed in chemistry for freezing-point depression of aqueous solutions; another is the use of the solidification line in the phase diagram (line OC of Fig. 2 in the text).

Use of the latter concept has led several researchers, such as Winterkorn [6], Edlefsen and Anderson [7], and Babcock and Overstreet [8, 9], to the erroneous conclusion that the water inside a capillary, where the pressure is below atmospheric, must have a rise of freezing-point instead of a drop,

if ice separates at atmospheric pressure. The same view was also expressed by Low when he stated during the conference, as a panel member of Session 4, that pressure effect and solution effect must be treated separately because they are opposite in direction in the change of the freezing point of the system.

The freezing-point depression of soil water should be considered as a transfer of the triple point (Takagi [1]; Dufour and Defay [10, chap. X]). This concept unifies the dualism in the theory of freezing-point depression.

The line PR in Fig. 2 in the text, which is called "locus of cooling process" to avoid abstract concepts, represents a locus on which $\mu_v = \mu_w$, and the line OB in the same figure represents a locus on which $\mu_v = \mu_i$, where μ_v , μ_w , and μ_i are chemical potentials of water vapor, liquid water, and ice, respectively. The intersection of PR and OB determines the freezing point, the triple point for this water. It thus becomes clear that both the aqueous solution and the water in a capillary have a lowering of freezing point.

The physical meaning of the foregoing derivation may be explained as follows: The water as a component of aqueous solution and the water in a capillary are in the same thermodynamic state when they have an equal chemical potential. From the thermodynamic standpoint, they are both equal to a liquid water that has the same pseudofugacity as both of them. Freezing points of both of them are therefore equal.

From the theoretical standpoint, it has been unfortunate that the phase diagram of water was drawn with P and T as axes. If chemical potential is adopted instead of P as one of the axes, a deeper insight into the nature of water is provided. Further, if instead of chemical potential, pseudofugacity is chosen, the phase diagram is more useful. It may be used even for an extraordinary water that does not obey Pascal's principle; we do not yet know how to define chemical potential for this water but we can define pseudofugacity, if an appropriate operational definition is found. It may also be used to derive (3) in the present paper, a formula for the large freezing-point depression.

A water drop, which has a higher vapor pressure than the saturated pressure, has line MN in Fig. 2 in the text as a locus on which $\mu_v = \mu_w$, that is, as a "locus of cooling process." The freezing-point depression of the water at the surface of a water drop may be determined by use of locus MN in the same way as done by use of locus PR by Takagi [1], which yields

$$T_o - T = \frac{T_o}{L_{iw}} \frac{(V_i - V_w) V_w}{v_o} \frac{2\sigma_{wv}}{r} \quad (A.8)$$

where T is the freezing point of a water drop, T_o is 273°K, L_{iw} is the latent heat of freezing a unit mass of water at T_o K, V_i is the specific volume of ice at T_o K, V_w is the specific volume of water at T_o K, v_o is the specific volume of water vapor at T_o K, σ_{wv} is the surface tension of liquid water against water vapor at T_o K, and r is the radius of water drop. Due to the existence of v_o in the denominator, $T_o - T$ is so small that we may assume that the water at the surface of a water drop freezes at T_o K.

It is noted in this connection that the so-called Gibbs-Thomson equation

$$T_o - T = \frac{V_i T_o}{L_{iw}} \frac{2\sigma_{wi}}{r} \quad (A.9)$$

where σ_{wi} is the surface tension between ice and liquid water at temperature T_o K, shows the temperature (TK) of a

spherical ice particle in equilibrium with liquid water. (See Garner [11] for the terminology, Skapsky [12] for an application, and Kolaian and Low [13] for the derivation.) It is different from (A.8), which shows the freezing temperature of the outermost surface of a water drop in equilibrium with water vapor.

The treatments used in the paper under discussion and [1] for deducing the freezing-point depression are based on the assumption that the ice formed from any form of water is the same as normal ice. In other words, OB and OC in Fig. 2 in the text are assumed to remain at the same position for all cases of freezing liquid water. If this assumption cannot be maintained, the graphical method introduced in the paper under discussion is not convenient; instead, the analytical method must be used, as partly done by Dufour and Defay [10] for inclusion of σ_{wi} .

It is the author's hope that elucidation of the implications of the theory will instigate discussions with regard to methodology for understanding the nature of adsorbed water around soil particles, or, more generically, for the thermodynamics of a heterogeneous system. He also hopes that his effort to explain the theory of freezing-point depression using only physical concepts without going into abstract concepts of the thermodynamic theory may not be lost. The explanation is not only simple but also considers the heterogeneous nature of adsorbed water for which classical thermodynamics is not directly applicable.

REFERENCES

- [1] S. Takagi. "Theory of Freezing-Point Depression of Soil Water, and a Note on the Extra-thermodynamics of Soil Moisture," *Soil Sci.*, Vol. 88, 1959, pp. 25-31.
- [2] G. N. Lewis, M. Randall. *Thermodynamics* (2nd ed., revised by K. S. Pitzer and L. Brewer), McGraw-Hill, 1961.
- [3] E. A. Guggenheim. *Thermodynamics* (2nd ed.), Interscience, 1950.
- [4] J. O. Hirschfelder, C. F. Curtiss, R. B. Bird. *Molecular Theory of Gases and Liquids*, Wiley, 1964, Chap. 5.
- [5] Z. Yoshida. "A Thermodynamical Theory about the Vapor Pressure and the Melting Point of Ice under Elastic Strain" (Japanese, with English summary), *Low Temperature Sci.*, Inst. of Low Temperature Sci., Hokkaido Univ., Ser. A, 20, 1962, pp. 1-27.
- [6] H. F. Winterkorn. "The Condition of Water in Porous Systems," *Soil Sci.*, Vol. 56, 1943, pp. 109-115.
- [7] N. E. Edlefsen, A. B. C. Anderson. "Thermodynamics of Soil Moisture," *Hilgardia*, Vol. 15, 1943, pp. 31-298.
- [8] K. L. Babcock, R. Overstreet. "Thermodynamics of Soil Moisture: a New Application," *Soil Sci.*, Vol. 80, 1955, pp. 257-263.
- [9] K. L. Babcock, R. Overstreet. "The Extra-Thermodynamics of Soil Moisture," *ibid.*, Vol. 83, 1957, pp. 455-464.
- [10] L. Dufour, R. Defay. *Thermodynamics of Clouds* (Transl. by M. Smyth and A. Beer), Academic Press, 1963.
- [11] W. E. Garner. "General Introduction on Crystal Growth," *Crystal Growth*, Disc. Faraday Soc., No. 5, 1949, pp. 7-10.
- [12] A. S. Skapski. "Melting Points of Small Ice Crystals and a Capillary Theory of Maximum Undercooling of Water," *Proc. Eastern Snow Conf.*, Vol. 4, 1956, p. 53.
- [13] J. H. Kolaian, P. F. Low. "Calorimetric Determination of Unfrozen Water in Montmorillonite Pastes," *Soil Sci.*, Vol. 95, 1963, pp. 376-384.

SUCTION AND ITS EFFECTS IN UNFROZEN WATER OF FROZEN SOILS

P. J. WILLIAMS, Norwegian Geotechnical Institute, Oslo

Substantial quantities of water remain unfrozen in soils at temperatures of several degrees below 0°C [1, 2, 3]. The proportion of unfrozen water decreases as the temperature is lowered, but as much as half of the water may exist unfrozen at -1°C . This unfrozen water has been attributed [4] to the suctions or negative pore pressures that develop as a result of ice-lens growth in the soil. A negative pore pressure in a saturated soil, in the absence of external loading, results in a positive effective stress (a stress acting across the grain-to-grain contacts) equal to the negative pore pressure. An increase in effective stress causes consolidation in compressible soils.

It is therefore of interest to investigate the consolidation that should occur in a frozen soil as a result of negative pore pressures in the unfrozen part of the moisture content. Such consolidation would also confirm the existence and, to some extent, the magnitude of the negative pore pressures—and their relationship to temperature.

FREEZING EXPERIMENTS

Direct investigation of these effects is difficult because of the irregularly distributed ice-lenses in a frozen soil which, on the one hand, greatly reduce permeability, and on the other hand, increase the over-all soil volume. It is necessary to devise an experiment in which lens formation is prevented in a part of the soil large enough for subsequent study of degree of consolidation and water content.

Perspex rings 2.2 cm ID and 0.4 cm in height were made. A ring was filled with a soil sample prepared flush to the surface. Pieces of a membrane, previously soaked in water, were then placed across the faces of the ring and soil sample and pressed tightly against the perspex with a clamp arrangement (Fig. 1). A thin smear of petroleum jelly was usually placed on the perspex ring where it came in contact with the membrane. Two further pieces of the same, or sometimes different, soil were then pressed against the exposed sides of the membranes.

This assembly was slowly cooled to a chosen negative temperature. Freezing (with ice-lens formation) occurs in the exposed soil, but not in that between the membranes because of the absence of an ice nucleus. Spontaneous nucleation does not occur—initially because the sample is small and subsequently for reasons which will become apparent—and ice growth cannot occur through the membrane. The membrane is of the water-permeable type used in pressure membrane tests [5]. The membrane pores are so small that ice growth only occurs within them at temperatures of at least several degrees below 0°C .

A modified domestic-type refrigerator was used. A mercury contact thermometer switch with a relay system maintained a fairly constant temperature. To avoid desiccation and to ensure uniform temperature, the sample assemblies were placed in closed jars together with pieces of ice to start nucleation in the exposed soil. The specimens were generally maintained at the chosen temperature for three days. Tests with thermocouples indicated that the sample attained the chosen temperature from 5 to 10 hours after refrigeration.

After refrigeration, the assembly was dismantled; the water content and volume of the inner soil layer (located between the membranes) were determined. A specially constructed glass pycnometer (Fig. 2) containing paraffin was used to determine the volume. To obtain sufficient accuracy, considerable attention to temperature and other effects was necessary.

Many further tests involving determination of water content only were done over a range of 0° to -3.3°C . In all cases the

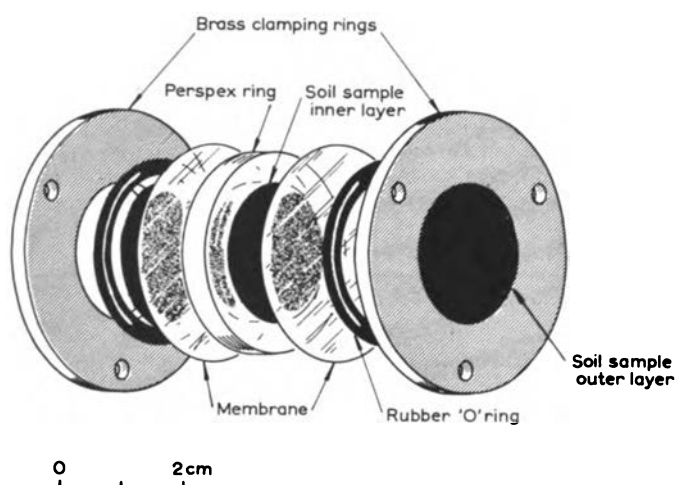

Fig. 1. Sample assembly for freezing experiments

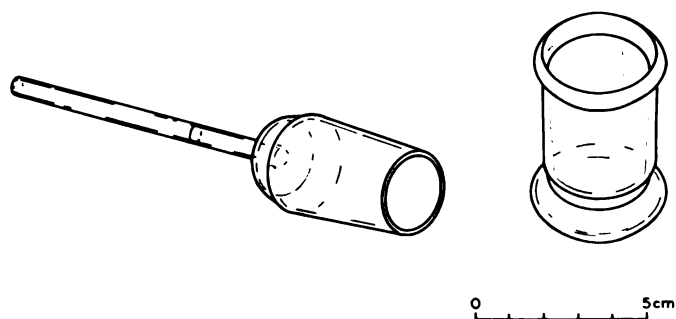

Fig. 2. Pycnometer used for dry density determinations

water content of the inner layer was substantially less than the initial water content. Preliminary tests showed that the water content of the inner layers became practically constant within three days. In one test similar soil samples placed in different parts of the refrigerator might give results differing by 1 to 2% of dry weight. This was largely due to slight temperature differences. Samples of the same soil in one bottle consistently showed similar water contents for the inner layer within 0.1 to 0.2% dry weight. When one sample was removed and the temperature then lowered for a further period, samples removed later showed lower water content. In all cases moisture content (ice and water) of the outer soil layers (Fig. 1) was increased.

VOLUME MEASUREMENTS

Results of investigations on Leda clay KNB are shown in Fig. 3. From volume determinations, dry density (weight dry material per unit volume of soil in moist condition in grams per cubic centimeter) was calculated and plotted (Fig. 3, crosses) as a function of water content. Consolidation of samples from the inner layer of the membrane assembly occurred during freezing. This is clearly shown by comparison with results of oedometer tests on similar material (Fig. 3, circles).

If the material is saturated there is a unique relationship between dry density, water content, and effective stress, for the observations shown in Fig. 3. Specific weight of the soil

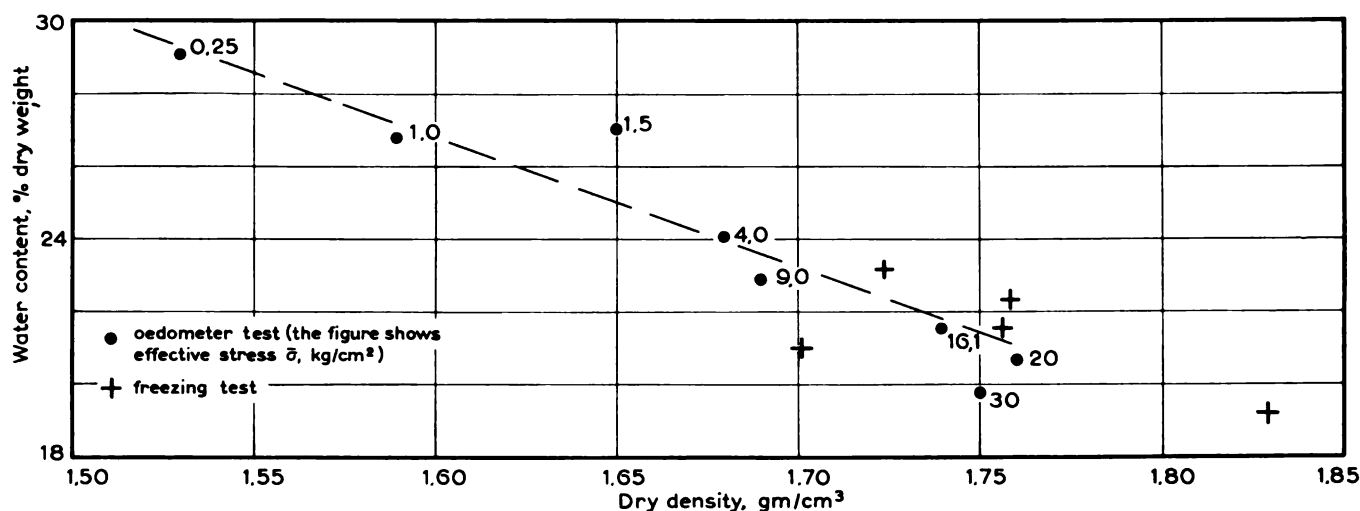

Fig. 3. Dry density as a function of moisture content

particles was found to be 2.78 g per cu cm, and from volumetric consideration, dry density and water content relationship for the saturated state was calculated (Fig. 3, dashed line). The relationship of the observed points to this line shows that the soil was saturated over the range shown.

According to the effective stress equation

$$\bar{\sigma} = \sigma - \mu \quad (1)$$

where $\bar{\sigma}$ is effective stress, σ is total stress (equals applied load in oedometer), and μ is pore water pressure, the load applied in the oedometer is equal to the effective stress (which is responsible for consolidation) after equilibrium is reached, because pore water pressure is then atmospheric (i.e., zero). The relationship between dry density (and moisture content) and effective stress is thus given by the oedometer tests. The figure for effective stress shown beside each point in Fig. 3, obtained from the oedometer tests, illustrates this relationship.

The magnitude of effective stresses to which samples from the membrane experiment have been subjected is indicated by those stresses that in oedometer tests produced a similar moisture content and dry density. In the absence of external loading (as in the membrane freezing experiment), effective stress is equal, but of opposite sign, to pore water pressure. Positive effective stress giving rise to consolidation arises from, and is numerically equal to, negative pore pressure developed by freezing.

RELATIONSHIP OF TEMPERATURE TO NEGATIVE PORE PRESSURE

As the temperature is lowered and more pore water is transferred to ice masses, negative pore pressures (and hence the effective stress) become greater. Negative pore pressure as a function of temperature cannot be determined from the few observations in Fig. 3. However, if water content of the inner layer from the membrane experiment was known as a function of temperature with sufficient accuracy, it would be possible to combine this with information in Fig. 3 to obtain values of negative pore pressure as a function of temperature. Water content of the inner (ice-free) layer, determined in many tests is shown in Fig. 4 (points and circles) as a function of temperature. In general, water content is less for lower temperatures. In addition to the two soils illustrated, tests were also made on an illitic clay from Åsrum, Norway, and a bentonite from Winnipeg, Canada. These tests also showed decreased water content of the inner layer for lower temperature. From information in Fig. 3, it should be possible to find negative pore pressure (which is numerically equal to the effective stress causing consolidation) corresponding to the different water contents of the inner layer (Fig. 4) and thus

to temperature. This direct procedure, while giving the approximate magnitude of the pore pressures, is not entirely satisfactory. Reasons for this are apparent from earlier experimental work [4] which can be used to obtain a more accurate approximation of the temperature-negative pore-pressure relationship.

INTERPRETATION OF OBSERVED WATER CONTENTS FROM CALORIMETRIC STUDIES OF FROZEN SOILS

In this earlier work, calorimetric methods were used to determine the quantity of water remaining unfrozen at various negative temperatures. Results of this type can be expressed as

$$\frac{\text{weight of water remaining unfrozen}}{\text{dry weight of soil}} \times 100$$

and then shown on Fig. 4. At least to about -1°C , water content of the inner (ice-free) layer in the membrane experiment is, within limits of experimental error, equal to water content of "normally" frozen soil (in which ice is also present). During the freezing process in the membrane experiment, water is transferred from the inner layer to the outer layers (where ice is formed) because of a pressure gradient in the water. When water content of the inner layer becomes constant, the water in both inner and outer layers would be expected to have the same negative pressure. Thus the situation of the inner soil layer, isolated by membranes, does not differ fundamentally from parts of the normally frozen soil in which ice-lenses may happen to be absent. The inner soil layer has the same (unfrozen) water content under the same negative pressure.

In the calorimetric investigations it was also found that the unfrozen water content as a function of temperature has, because of hysteresis, somewhat different values depending on whether the soil is in process of freezing or thawing (Fig. 4). In the membrane experiment, similar small differences in water content are expected depending on whether the measured temperature of the refrigerator is reached by cooling or slight warming. Temperature control of the refrigerator was such that fluctuations of $\pm 0.1^{\circ}\text{C}$ might occur and these are largely responsible for the scatter in the points shown. In addition, water content was to some extent dependent on the degree of disturbance of the sample.

This relatively small scatter in the observed points is sufficient to prevent an accurate calculation of the relationship between temperature and effective stress. Fig. 3 shows that small changes in water content are associated with very large changes in effective stress, so that it is necessary to know the water content-temperature relationship (Fig. 4) for the freezing condition with a high degree of accuracy.

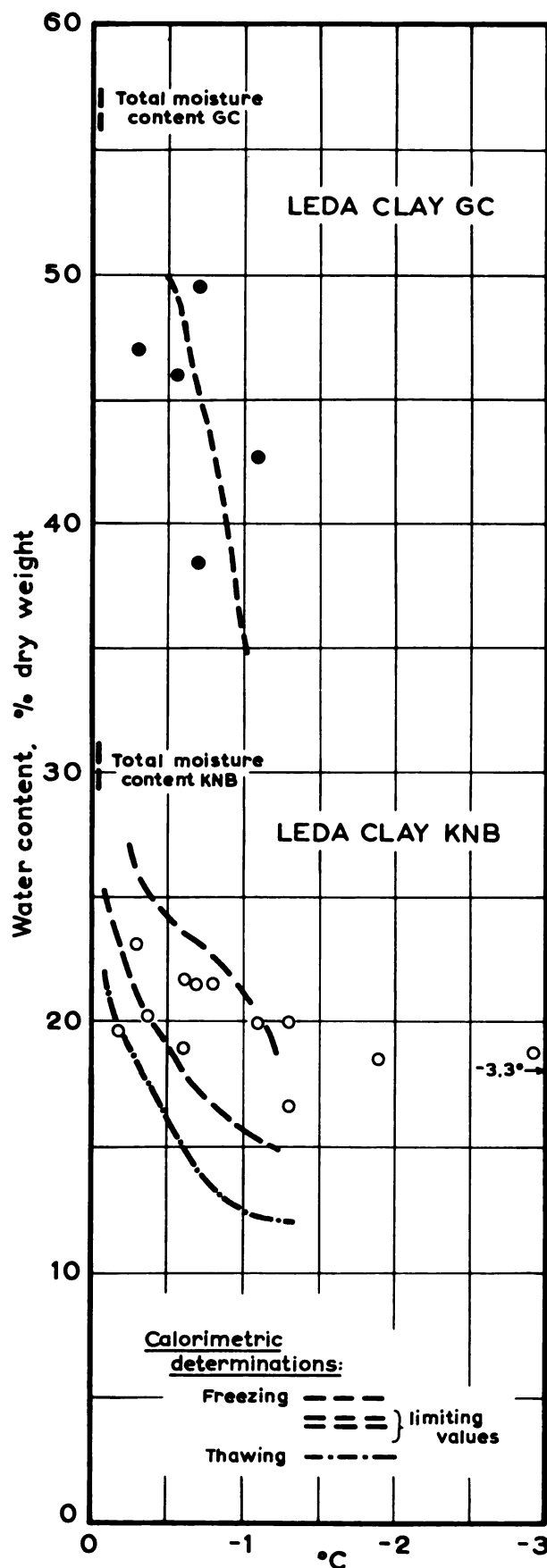

Fig. 4. Equilibrium water contents of inner layers (where ice formation did not occur)

DETERMINATION OF TEMPERATURE AND NEGATIVE PORE PRESSURE RELATIONSHIP

Pressure effects are generally accepted as mainly responsible for the presence of unfrozen water in frozen soils. Earlier work [4] provided a quantitative evaluation of these effects. Suction-water content relationships [6] were determined at room temperature for the soils investigated calorimetrically. A hypothesis was proposed that as freezing occurred and water was transferred into ice-lenses, the water remaining in the pores would be under an increasing suction (negative pore pressure). This suction could be predicted from suction-water content tests—and is probably responsible for the presence of the unfrozen water because of its effect on the freezing point of the latter. The suction predicted for each unfrozen water content was found to be related to the temperature by an equation of the type by Schofield [7]:

$$H = \frac{L}{T_{gr}} \Delta T \quad (2)$$

where

H = suction expressed as height of a column of water, cm (\approx g/sq cm); L = latent heat of freezing of water (3.336×10^9 erg/g); T = temperature, °K; ΔT = negative temperature, °C; and gr = gravity.

This relationship could only be determined following a large number of carefully controlled tests on various soils—reasoning as above. Results are summarized in Fig. 5, modified from [4]. Except for a necessary minor correction to allow for the effect of dissolved salts on freezing point, the equation is apparently valid for all soils. The equation gives the freezing-point depression of water under negative pressure, which is in contact with ice under atmospheric pressure [8]. Although it appears unlikely at first, this situation probably occurs in soils where the ice phase is in discrete lenses or masses larger than pore size, while the water lies within small pores under the influence of capillary and other effects.

TEMPERATURE AND NEGATIVE PORE PRESSURE CONCLUSIONS

Although earlier work [4] did not show directly the existence of negative pore pressures, present experiments clearly demonstrate these pressures and also confirm that their magnitude is similar to that predicted from (2). A thermodynamic equation of the type of (2) does, therefore, correctly describe the temperature-pressure relationship for water freezing in soils. On the basis of the detailed observations made in the earlier work it can then be concluded that (2) gives the best available approximation of the relationship between temperature and negative pore pressure (and thus effective stress) in unconfined samples.

APPLICABILITY OF EQUATION (2)

There is an important limitation to the present experiment in proving the range of application of (2) which remains to be discussed. This is illustrated by Fig. 6, where water content is shown as a function of effective stress for samples in oedometer and suction tests. So long as the soil is saturated, these tests give, with minor qualification, similar results. At 21% water content, the two sets of results diverge. This is the shrinkage limit, and desaturation occurs in the suction tests. In Fig. 4 this is reached in freezing to about -1°C . On freezing to lower temperatures the membrane experiments always gave water contents substantially higher than those determined calorimetrically. This is probably because when desaturation occurs, hydraulic flow is substantially reduced. Transference in the vapor phase may occur, but even after three weeks at the low temperatures, water content remained higher in the membrane experiment.

The information in Fig. 3 cannot be extrapolated to apply beyond the shrinkage limit (which in the case of Leda clay KNB is reached at about -1°C).

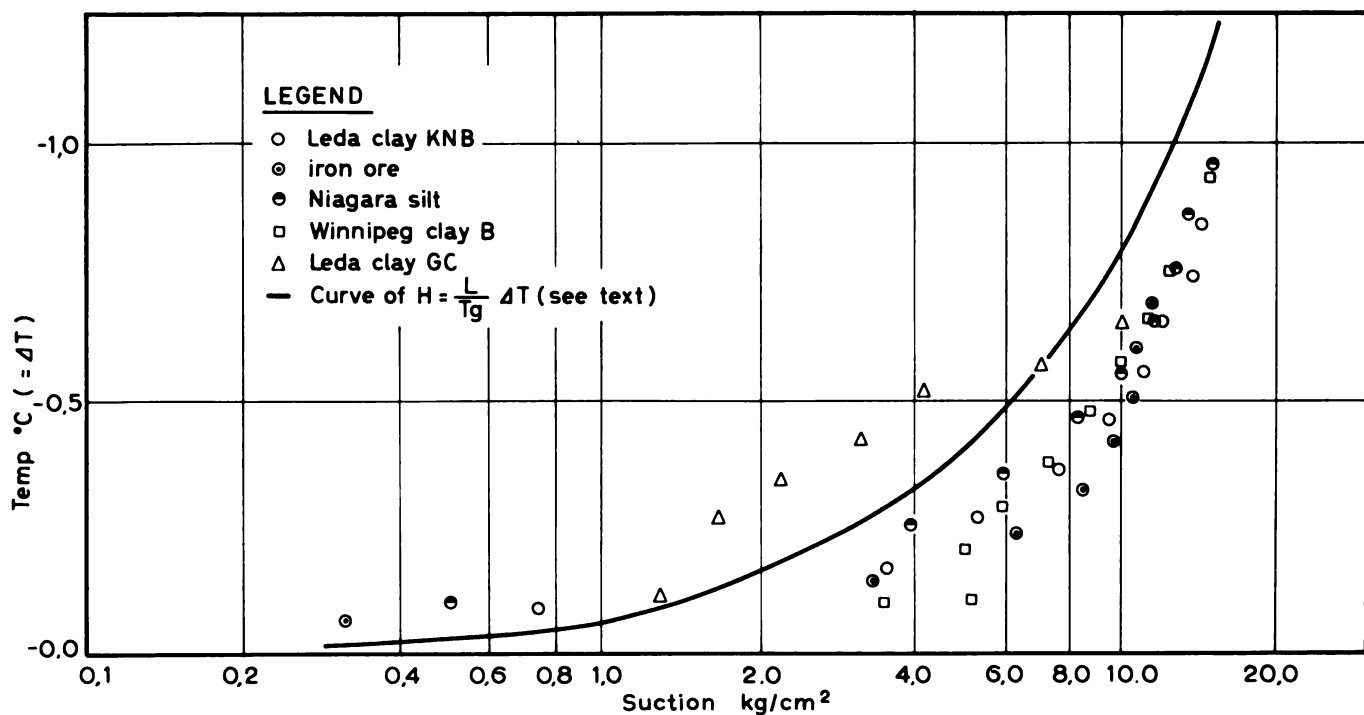

Fig. 5. Theoretical and experimental relationship between temperature and suction

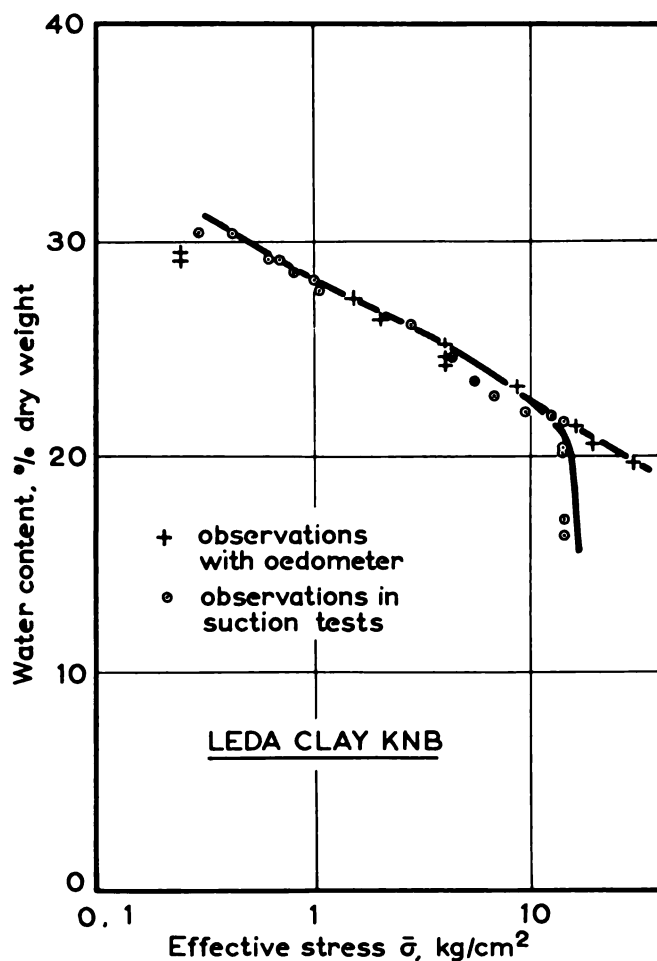

Fig. 6. Comparison of observations from suction-water content tests and from oedometer tests

PRESSURES ON THE ICE PHASE

Agreement of experimental observations with (2) implies that the pressure on the ice (at least where it is in contact with the water) is always atmospheric. Most of the ice is in bodies considerably larger than pore size, and might be supposed to carry the effective stress, especially at points of contact with soil grains (ice and grains may be separated by a bound film of water). The existence in the ice of a positive pressure greater than atmospheric is in conflict with evidence in Fig. 5, even when allowance is made for experimental errors.

Curvature of very small radii will cause increments or decrements of pressure locally within the ice [9, 10]. It is suggested that the ice surface will be concave over grains and convex into pores, with radii such that local stresses are relieved and the ice surface in contact with water is uniformly at atmospheric pressure. Work now being carried out involves freezing tests on samples under various externally applied total-stress conditions and may give further information on this point.

CONCLUSIONS

Experiments involving freezing of soil samples, with restricted ice-lens development show that water which remains unfrozen within a freezing soil has a negative pressure. This negative pore pressure gives rise to an effective stress which causes consolidation. This volume decrease will usually be obscured by ice-lens growth.

Negative pore pressure is greater at lower temperatures. Unfrozen water in saturated soil moves freely along pore pressure gradients. The experiments confirm that, for temperatures down to the level at which the shrinkage limit is reached, an equation of the type proposed by Schofield gives approximately the suction (negative pore pressure), in unconfined samples, as a function of temperature.

The effective stress developed, even at temperatures of -0.8°C to -1.0°C , causes considerable consolidation in compressible soils. This, together with discontinuities left by ice-lenses, results in a special structure in soils subjected to a freeze-thaw cycle.

ACKNOWLEDGMENTS

I am indebted to my colleagues at the Norwegian Geotechnical Institute, J. Moum and O. Ihlen Sopp, and to the Director, L. Bjerrum, for assistance and stimulating discussion.

REFERENCES

- [1] Z. A. Nersessova, N. A. Tsyrovich. "Merzlye grunty kak slozhnye mnogofaznye sistemy," Mat. po laboratornym issled. merzlykh gruntov, Akad. Nauk SSSR, Inst. Merzlot. Sb. 2, 1957, pp. 10-22.
- [2] C. W. Lovell. "Temperature Effects on Phase Composition and Strength of Partially-Frozen Soil," Highway Res. Bd. Bull. No. 168, 1957, pp. 74-95.
- [3] P. J. Williams. "Specific Heat and Unfrozen Water Content of Frozen Soils," Proc. 1st Canadian Conf. Permafrost, 1963, pp. 109-126.
- [4] P. J. Williams. "Unfrozen Water Content of Frozen Soils and Soil Moisture Suction," Geotechnique, Sept. 1964.
- [5] L. A. Richards. "Pressure Membrane Apparatus, Construction and Use," Agr. Engr., Vol. 28, 1947, pp. 451-460.
- [6] D. Croney, J. D. Coleman, P. M. Bridge. "Suction of Moisture Held in Soil and Other Porous Materials," Road Res. Tech. Paper 24, 1952 (D.S.I.R., R.R.L., Harmondsworth, Middlesex.).
- [7] R. K. Schofield. "The pF of the Water in the Soil," 3rd Intl. Cong. Soil Sci. Trans., Vol. 2, 1935, pp. 37-48.
- [8] N. E. Edlefsen, A. B. C. Anderson. "Thermodynamics of Soil Moisture," Hilgardia, Vol. 15, 1943, No. 2, pp. 119-120.
- [9] D. H. Everett. "The Thermodynamics of Frost Damage to Porous Solids," Trans. Faraday Soc., Vol. 57, 1961, Pt. 9, pp. 1541-1551.
- [10] L. W. Gold. "A Possible Force Mechanism Associated with the Freezing of Water in Porous Materials," Highway Res. Bd. Bull. No. 168, 1957, pp. 65-73.

A. Discussion

R. D. MILLER, Cornell University—This is a very interesting and significant contribution. Williams adroitly avoids the problems inherent in the use of his second equation, or seems to (cf. comments on paper by Lange and McKim), by keeping the ice phase outside the sample. This maneuver, which allows the ice-lenses to grow at atmospheric pressure, ostensibly fixes the pressure on the ice phase and excludes ice from the pores where the pressure in the ice is unknown when the water pressure is unknown. This is one of the few examples of use of the equation in a manner that reduces the uncertainties of the boundary conditions.

It is interesting to note that unfrozen water content versus temperature relationships observed under two experimental conditions diverge at the shrinkage limit, but agree down to that point. This suggests that where it was present, the membrane prevented ice entry into the pore system of the sample under conditions where entry occurred in the absence of the membrane. Consequently, some water in the sample with the membrane failed to freeze simply because nucleation of freezing was blocked by the membrane and the unfrozen water content observed was greater than that observed when the membrane was absent. This explanation obviates the need for the explanation offered by Williams, but at the same time does not invalidate his suggestion. For the above explanation to be valid, it is necessary to assume that either the membrane also blocked air entry or that the surface energy of the air-water interface exceeds that of the ice-water interface. Otherwise the water in question would have been displaced by air instead of ice, where the latter was excluded by the membrane. Either or both are probable.

B. CLOSURE—I am indebted to Miller for drawing my attention to an important point.

Is it to be expected that the water content of the layer between the membranes will be equal to the (unfrozen) water

content of "normally frozen" soils? The problem is most easily understood by considering the extent to which ice in "normally frozen" soil is localized into a few relatively large bodies or is dispersed through the pores. As temperature is lowered ice will tend to enter smaller and smaller pores. The size of the pores of the membrane is so small that it is quite certain that ice cannot grow through them except at temperatures far lower than those of interest in the present case. At some much higher temperature there will be a significant number of pores in the soil layer between the membranes which would have contained ice had the membranes not prevented this. If these particular pores are water-filled at that temperature, then the water content of the layer will be higher.

Following Everett [1] the size of pores entered by ice at a suction, u is given by

$$r = \frac{2\sigma_{iw}}{u} \quad (B.1)$$

where σ_{iw} is the interfacial energy ice/water. If u is the suction established at a given temperature (in agreement with (2)) then pores of larger radius than r , are ice filled at that temperature. From the suction-moisture content curve (Fig. 6), it appears that a large number of pores of Leda clay KNB are emptied at a suction of about 11 kg/sq cm. The size of pores drained at a given suction is given by a similar equation

$$r = \frac{2\sigma_{aw}}{u} \quad (B.2)$$

where σ_{aw} is the interfacial energy air/water. Both σ_{iw} and σ_{aw} are now quite accurately known [2]. Here we need only consider the ratio between them, that is, approximately 2 to 5 to see that pores entered by air at a suction of 11 kg/sq cm might be entered by ice at a little over 4 kg/sq cm. From (2), the latter suction occurs at about -0.4°C . In the case of the layer between the membranes such pores will be water filled at least until a suction of 11 kg/sq cm is reached. The water content for this layer might therefore be expected to diverge from calorimetrically determined water contents at this temperature. The relatively imprecise observations do not reveal this; it is also open to question whether these simple considerations may be applied to pores of the size found in clays where much of the water is bound to the particles and probably not susceptible to freezing in the usual sense.

In any case, the pressure in the water in the soil between the membranes and that outside them can be assumed equal at the termination of each test. Measurements of water content of the inner layer allow determination of effective stress developed, and thus of suction, at least until the shrinkage limit is reached.

The considerations given above are relevant to earlier [3] experimental evidence (Fig. 5), that (2) describes the relationship between temperature and suction in the water phase of frozen soils. They suggest an explanation for the tendency of experimental points (obtained using conventional suction-moisture content tests) to lie under the theoretical curve. The size of the correction that might be made to such points, on account of the difference in interfacial energies σ_{iw} and σ_{aw} is largely beyond the scope of the present discussion. It appears to be small for temperatures at which there is little entry of ice into the pores but might theoretically involve a reduction by three-fifths of the suction shown for cases where ice is widely dispersed through the pores. It is most relevant where soil pores are large, and where consequently ice entry occurs at relatively high temperatures. Another paper in this volume, by Miller, discusses the matter in further detail.

REFERENCES

- [1] D. H. Everett. "The Thermodynamics of Frost Damage to Porous Solids," Trans. Farad. Soc., Vol. 57, 1961, Pt. 9, pp. 1541-1551.
- [2] E. Hesstvedt. The Interfacial Energy Ice/Water, Norwegian Geotech. Inst., Pub. No. 56, 1964.
- [3] P. J. Williams. "Unfrozen Water Content of Frozen Soils and Soil Moisture Suction," Géotechnique, Sept. 1964.

UNFROZEN WATER IN FROZEN SOILS

Z. A. NERSEOVA and N. A. TSYTOVICH, V.A. Obruchev Permafrost Research Institute, Moscow

In interaction with hydrophilic solids, water at the interface turns into a new physicochemical state [1].

Many scientists subdivide water in dispersed systems into free water, which is not influenced by the soil surface, and bound water, which is influenced by the soil surface. In turn, bound water is subdivided into strongly bound water and weakly bound water. However, there is no common criterion for determining these categories, and in classifications of different authors, water categories often differ sharply.

Recently, proceedings from the structural properties of water at the interface with a concept called "boundary phase" [2, 3] was introduced to distinguish this special state of water. However, for the present, there is no criterion which might permit one to estimate quantitatively the content of the boundary phase in soil, and in frozen soils in particular. The most valid theoretical classification of water types in dispersed systems, based on the nature of the water relationship with the material [4], cannot be applied to frozen soils either.

Furthermore, the amount of liquid water in frozen soils is determined not only by the action of the field of force of the surfaces of the soil skeleton, but also by the content of water soluble compounds.

With regard to frozen soils, it is expedient to distinguish categories of water depending on their phase states. While analyzing possible classifications of natural waters, V. I. Vernadskiy [5] distinguished three main groups: Gaseous waters (steam), liquid waters (solutions), and solid waters (ice).

Considering that the quantity of liquid water in frozen soils depends on thermodynamic parameters determining the state of the system and on the content of water soluble compounds, the classification of water in frozen soils should be based on the aggregate (phase) state of water and on its phase transitions at negative temperatures [6]. In this case, the following main types of water contained in frozen soils may be distinguished:

1. Water in gaseous state.
2. Water which does not change its phase state with temperature and pressure alterations (strongly bound water).
3. Water of alternating phase state (freezes and thaws at a temperature below 0°C), including weakly bound water and solutions.
4. Water in solid phase (ice), i.e., free water which freezes at 0°C and does not thaw at normal pressure and negative temperature.

The peculiarities of phase transitions of water in soils are considered in detail in a special report by I. A. Tyutyunov, entitled "Phase Transformations of Water in Soils, the Nature of Its Migration and Heaving."

The first data about partially frozen and unfrozen plastic layers of soil between layers of ice dates back to the end of the 19th century [7]. According to this, the more dispersed soils contain less ice. Later, the water freezing temperature depression in soils was experimentally studied by a number of scientists. Worthwhile systematic investigations have been made by G. Bouyoucos [8, 9], G. Beskow [10], E. Yung [11], N. A. Tsytovich [12, 13, 14], and A. E. Fedosov [15]. These scientists obtained data on the unfrozen water content in various soils. In 1940, N. A. Tsytovich formulated the principle of the equilibrium state of water in frozen soils according to which "the amount, composition and properties of unfrozen water contained in frozen soils do not remain constant but change with alterations of external influences, being in a state of dynamic equilibrium with the latter" [12].

Later scientific investigations were made in the laboratory of the Permafrost Research Institute of the USSR Academy of Sciences [6, 16, 17, 18], and soils studied under natural conditions of various northern regions [19, 20] verified this

principle. Typical curves for the main types of soil were obtained which showed changes of unfrozen water content depending on negative temperatures. The analysis of this temperature relationship showed that three temperature ranges of water phase transitions in frozen soils may be distinguished [12]:

1. The range of significant phase transformations in which the change of unfrozen water amounts to 1% and more (with respect to the weight of dry soil), for a 1° change in temperature.
2. The transitional range where changes of unfrozen water range from 0.1 to 1% for 1°C .
3. The range of practically frozen state where phase transformations of water for 1° do not exceed 0.1%.

The temperature ranges of phase transformations of water conform to these categories of water in frozen soils: The water of alternating phase state corresponds to the range of significant phase transformations and to the transitional field; the water which does not change its phase state at negative temperatures corresponds to the range of practically frozen state. For the majority of nonsaline soils, the above ranges of water

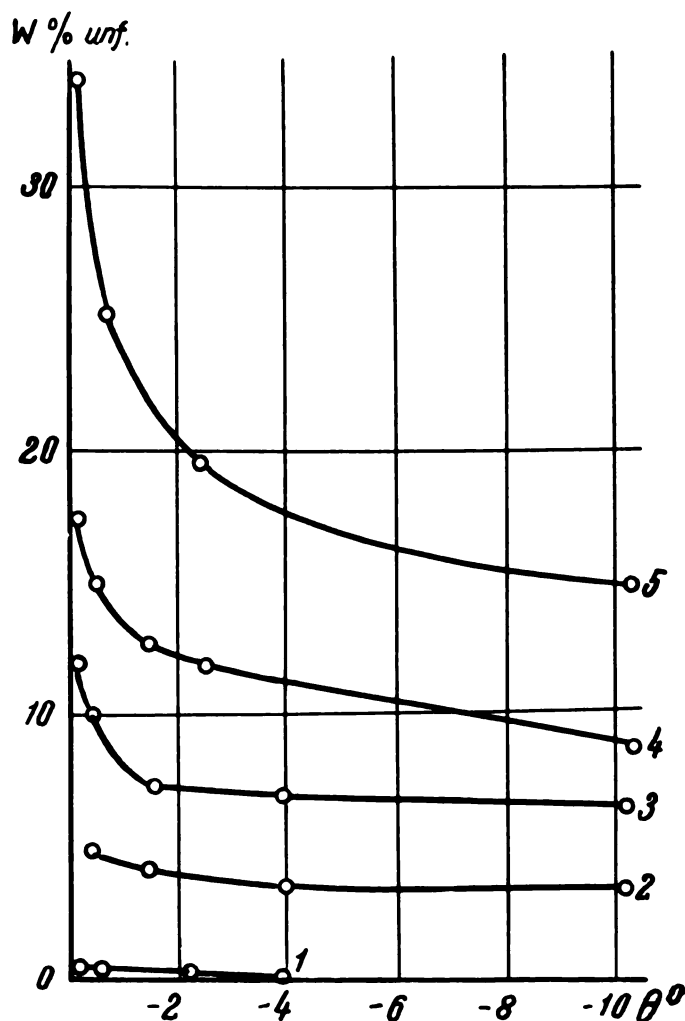

Fig. 1. Unfrozen water contents in typical nonsaline soils (1) Quartz sand, (2) Sandy loam, (3) Loam, (4) Clay, and (5) Clay containing montmorillonite

phase transformations are expressed rather distinctly: In the range of significant phase transformations, the amount of unfrozen water usually corresponds to the moisture beginning from the maximum molecular water capacity and higher; in the transitional range, the unfrozen water content corresponds to the moisture values ranging from the maximum molecular water capacity to the value of strongly bound water; in the range of practically frozen state, the amount of unfrozen water approximates the maximum hygroscopic moisture or corresponds to strongly bound water [18, 19, 21].

In most soils at a temperature below -70°C , liquid water freezes completely, and at a temperature of -193.8° , unfrozen water was not detected even in highly dispersed montmorillonitic clay [22]. (The complete freezing of water means the freezing of the water as determined by drying at 105°C).

For some typical soils, changes of unfrozen water content depending on temperature are given in Fig. 1. Mean data characterizing the content of unfrozen water in nonsaline soils are presented in Table I with accuracy sufficient for practical purposes.

Table I. Unfrozen water content in typical nonsaline soils [16]

Soil	Maximum molecular water capacity, %	Unfrozen water (with respect to dry wt of soil), %				
		-0.2° -0.5°	-1° -2°	-4.5° -5°	-9° -10°	-10°
Sand	1-7	0.5-2	0.5	0.5	0.5	0.5
Sandy loam	9-13	3-10	3-6	3-6	3-6	3-6
Clayey loam	15-23	10-20	5-15	5-10	4-8	4-8
Clay	23-35	15-25	10-20	10-15	5-10	5-10
Clay containing montmorillonite	>35	30-40	20-30	15-25	15-20	15-20

As stated by a number of investigators [11, 19, 23], as well as by detailed determinations of phase composition of water in various frozen soils made by the authors with the aid of calorimetric methods in an isothermal calorimeter specially designed for the purpose, the content of unfrozen water for the given soil does not depend on water content but is determined mainly by the value of the negative temperature.

The above mentioned law is of great practical importance. After determining, under field conditions, the negative temperature of the soil and its total water content, and after calculating in laboratory experiments the unfrozen water content for remolded specimens corresponding to this temperature, it is possible to calculate the amount of ice in the soil under natural conditions [24]. It is necessary to point out that Yong [25] states that the unfrozen water content in soils of higher moisture content is higher, which is quite natural since ice is a hydrophilic body. However, for all practical purposes, it can be assumed that the content of unfrozen water in a frozen soil is determined by the value of the negative temperature. As stated [14], the external pressure influences the unfrozen water content in frozen soils and especially in the range of significant phase transformations of water, as well as in the transitional range. Thus, for instance, it was stated that clay at a temperature of -1.7°C contained 42% unfrozen water. The same clay subjected to an external pressure of 2 kg/sq cm during freezing at the same temperature contained 58% unfrozen water. In the same way, external pressure affects the unfrozen water content in other soils, especially in fine grained soils.

In frozen soils, when the phase equilibrium of water is disturbed, various gradients arise which make unfrozen water move.

Research by I. A. Tyutyunov [26] under natural conditions and especially the experiments reported here show that if there is a temperature gradient in frozen soils (especially in the range of significant phase transformations of water), unfrozen water migrates. This migration is directed toward the cooling front where the water film is thinner because of the transition of some of the water to ice. A. A. Ananyan [27] stated that movement of unfrozen water took place under the effect of the

potential difference of an electric field in a frozen soil. The latter phenomenon may be used in practice for electro-osmotic drainage of not only unfrozen soils but also frozen ones. However, not every value of a force gradient leads to motion of unfrozen water in frozen soils, since it is necessary to overcome some initial resistance to the motion. Thus, the experiments performed for the purpose of solving a practical problem in hydraulic engineering showed that at a temperature gradient of $1^{\circ}/\text{cm}$, water did not migrate in dense Kinel clay, whereas at a gradient of $5^{\circ}/\text{cm}$, intense migration of water and heaving and softening of clay soil on the ditch bottom occurred.

Thus, migration of unfrozen water in frozen soils begins only at values of gradients which exceed some initial value. Because of the very low permeability of frozen soils, (the coefficient of permeability is of the order of 10^{-10} cm/sec) this motion proceeds rather slowly. As far as great stretches of time are concerned that are measured by months, years, centuries, and longer periods of time such as geological periods, migration of water in frozen soils may essentially affect the water distribution in frozen soils and permafrost and their ice content.

Besides external influences (temperature and pressure), the main factors determining the unfrozen water content in frozen soils are: (a) Specific surface area of the solid phases of the soil system (mineral and organomineral skeleton of soil and ice); (b) chemical and mineralogical composition of soil; (c) physicochemical characteristics, especially the nature of exchangeable cations; (d) content and composition of water soluble compounds.

As mentioned, the last item is a specific feature which permits a distinction between unfrozen water in frozen soils and bound water at a positive temperature.

The importance of the specific surface area of a mineral skeleton has been proved by experiments on determination of unfrozen water content in fractions of quartz sand of different gradations [6, 18].

In fractions of 1.0 to 0.5 mm and 0.05 to 0.01 mm, the unfrozen water content (per cent dry weight) at -0.6°C reached 0.2 to 0.3% and about 1%, respectively; whereas in a fraction of quartz sand of less than 0.001 mm, the unfrozen water content at 0.5 to 0.6°C reached 14.2%; at -1.0° equaled 6.4%, and only at -5°C decreased to 2%.

It has been proved experimentally that the phase composition of water in frozen soils depends not only on the value of their specific surface [22], i.e., their gradation, but also on their internal surface (ultraporosity).

It is apparently necessary to find methods of estimating the active surface of soils which really interact with water films. This is especially important, since the concepts of active surface and active surface centers are widely used in physics and chemistry of surfaces. This is especially true in the crystallochemical approach to the problem of unfrozen water in frozen soils [28] and in the interpretation of water phase transformations in freezing and frozen soils on the basis of water structure, translatory motions of its molecules, and the influence of the surfaces of the mineral skeleton [29, 30].

Consideration of the processes of the wetting of solid bodies by water and laws of its migration and crystallization [3, 31] also involves the concept of an active surface.

The influence on water phase composition in frozen soils of qualitative peculiarities of the soil mineral skeleton (such as mineralogical and chemical composition as well as physicochemical properties) and the nature of exchangeable cations in particular, cannot be observed in "pure form" since they are interconnected with the gradation of soils. As is known, soils containing minerals belonging to the montmorillonite group in the fine fractions are, as a rule, very fine grained. In turn, when exchangeable cations are represented by univalent ions, especially Na-ions, soils possess a large specific surface. In the presence of multivalent exchangeable cations, when irreversible coagulation of the fine fraction takes place, the specific surface of soils sharply decreases.

The quantity of unfrozen water reflects the total influence of gradation, mineralogical composition of clay fraction, and

Table II. Water properties and microaggregate composition of monomineral clays depending on nature of exchangeable cations^a

Clay	Moisture, % (dry wt)			Content of fractions, % (d, mm)						
	Max. hygroscopic	Max. molecular	Plastic limit	1.0-0.25	0.25-0.05	0.05-0.01	0.01-0.005	0.005-0.001	0.001-0.0002	<0.0002
Fe-kaolin	10.0	30.0	50.8	traces	25.8	68.2	6.0
Ca-kaolin	9.0	30.0	52.0	same	21.2	70.0	5.7	3.1
Na-kaolin	9.0	32.0	56.0	same	24.6	60.1	10.0	5.0	0.8	...
Fe-askangel'	27.4	46.0	90.0	16.6	35.9	26.9	8.8	8.4	3.4	...
Ca-askangel'	26.0	57.0	123.0	10.3	30.9	28.6	8.8	10.8	10.6	...
Na-askangel'	24.9	98.0	200.0	4.8	23.1	3.6	5.9	5.4	3.8	53.4

^aKaolinite predominates in kaolin, montmorillonite in askangel'.

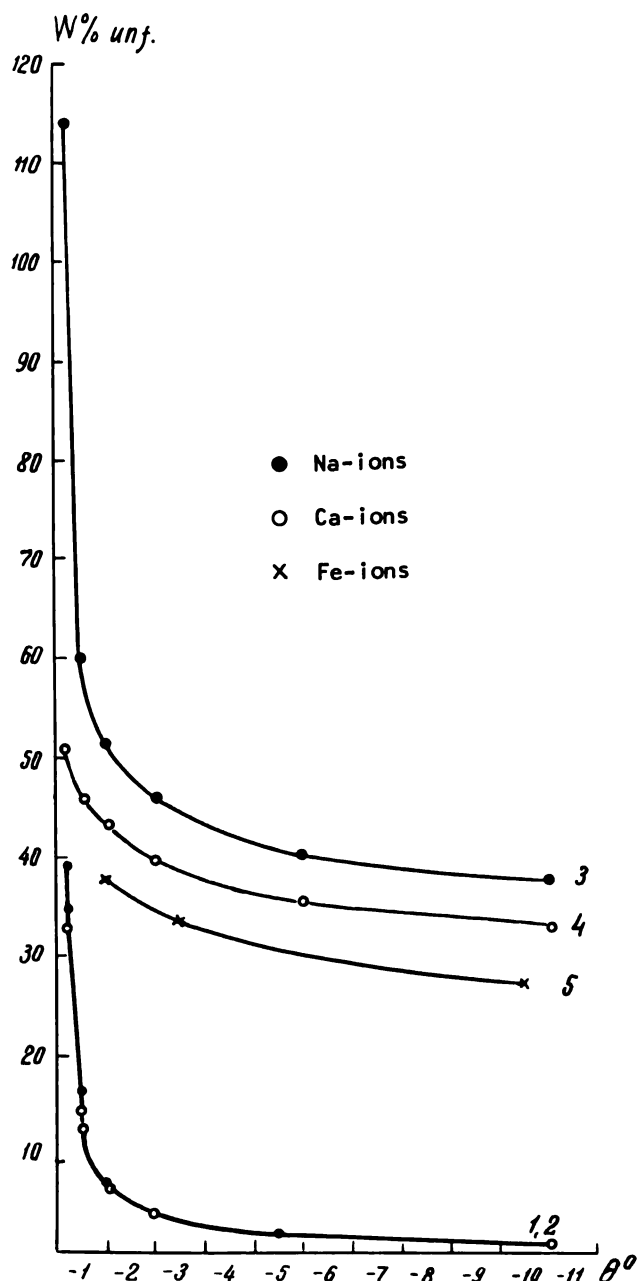

Fig. 2. Unfrozen water content in kaolinite and montmorillonite clays of various exchangeable cations

nature of exchangeable cations on the extent and energy of the soil surface. In montmorillonite, ultraporosity (internal surface of the soil) sharply increases, and the amount of unfrozen water increases as well; but the water freezing temperature decreases [22].

The importance of the nature of exchangeable cations on the water properties of soils and the binding of water is acknowledged by all investigators and has been proved by numerous experiments. The laws of water phase composition change in kaolinite and montmorillonite clays of different compositions of exchangeable cations were studied (Fig. 2). In the case of kaolinite clay, exchangeable cations do not influence the gradation and water properties materially (Table II).

The curves of changes in unfrozen water content with respect to temperature almost coincide, and only near 0°C does Na-kaolin contain more unfrozen water than Ca-kaolin.

In a montmorillonite clay, "askangel," particle size and all water properties depend to a great extent on the nature of exchangeable cations, as Table II shows. When Na-ions are in the exchange state, askangel is a very fine-grained clay containing a colloidal fraction of over 50%. For multivalent exchangeable cations (Ca and Fe), the colloidal fraction disappears, and the grain size increases sharply. This phenomenon is also reflected by the dependence of unfrozen water content on temperature in askangel with different exchangeable cations (Fig. 2).

Even in the range of a practically frozen state in specimens of Na- and Ca-askangel, the unfrozen water content differs 5 to 6%. In the range of significant phase transformations, this difference reaches from 10 to 15%; whereas at a temperature of -0.2° it reaches about 60%. Thus, a sharp decrease in grain size and, apparently, an extensive internal surface (microporosity) of Na-montmorillonite clay cause a material increase of unfrozen water content as compared with Ca-askangel at any negative temperature. In Fe-askangel, where coagulation and aggregation are expressed still more distinctly than in Ca-askangel, the unfrozen water content diminishes accordingly. Probably, for Fe-askangel, the value of the internal surface (microporosity) decreases sharply as well.

The influence of water-soluble compounds on unfrozen water in frozen soils shows directly both in a decrease of freezing temperature of the pore solution and in a diminution of the ζ-potential and the thickness of water shells on colloidal soil particles. It shows to a varying degree, depending on the amount and composition of the water-soluble compounds.

The complexity of water-phase transformations is caused, on one hand, by the fact that soils are multiphase and multi-component systems and, on the other hand, by peculiarities of structure and properties of water in the liquid phases, especially film water. Vernadskiy [5] points out: "Physico-chemical properties of water molecules are absolutely exceptional among hundreds of thousands of chemical combinations known to us." He also states: "Thus the mass of

thin water films of hair-thickness in the earth's crust is comparable at least to the mass of water in the ocean."

At present many scientists [3, 19, 29 to 34] are engaged in solving this complicated and important problem. They point out the necessity of studying water structure and the peculiarities of its properties for the purpose of interpreting the processes of binding water in soils and rocks in general, as well as freezing and thawing of water in particular.

The importance of unfrozen water in frozen soil for theoretical and applied frozen soil research is unquestionable.

Study of quantitative and qualitative laws of migration of thin water films in frozen soils and their interaction with enclosing rocks is of paramount importance in the problem of formation of the frozen zone of the lithosphere and its transformations (cryolithogenesis).

The physicochemical properties of frozen soils and ice, and the changes taking place because of temperature and external influences also directly depend on unfrozen water content in frozen soils. (See "Instability of the Mechanical Properties of Frozen Soils," in this volume.)

All thermophysical processes in freezing and frozen soils are connected to some extent with unfrozen water and its quantitative estimation.

Finally, questions on water regime and water storage in seasonally frozen soils are also closely connected with migration of water both in the period of their freezing and in the frozen state.

In the near future, it will be necessary to concentrate the efforts of scientists on solving the following important problems of phase equilibrium and phase transformations of water in soils: (1) Structure and properties of thin water films on the surface of fine grained solids and, specifically, soils; (2) Surface activity of the mineral skeleton of soils; (3) Physicochemical studies of the forces of interaction between mineral skeleton and water films; (4) Isolation and analysis of pore solutions of frozen rocks and soils; (5) Laws governing water film migration in soils at negative temperatures.

REFERENCES

- [1] D. I. Mendeleev. Osnovy khimii, Vol. 2, St. Petersburg, 1869.
- [2] B. V. Deryagin. "Sol'vatnyye sloi, kak osobye granichnyye fazy na osnove pryamykh metodov issledovaniya," Tr. Vses. konferentsii po kolloidnoy khimii (13-18 iyunya 1950), Publ. House Acad. Sci. Ukrainian SSR, Kiev, 1952.
- [3] I. A. Tyutyunov. "Protsessy izmeneniya i preobrazovaniya pochvi gornykh porod pri otritsatel'noi temperature," Acad. Sci. USSR, Moscow, 1960.
- [4] P. A. Rebinder. "Classification of the Form of Bond of Moisture to Material," Quoted from Teoriya sushki by A. V. Lykov. Moscow-Leningrad, 1950.
- [5] V. I. Vernadskiy. Istoriya mineralov zemnoy kory, Istoriya prirodnykh vod., Vol. 2, No. 1, Goskhimtekhnizdat, Leningrad, 1933.
- [6] Z. A. Nersesova. Vliyaniye obmennykh kationov na fazovyy sostav vody v merzlykh gruntakh, Materialy po laborat. issledovaniyam merzlykh gruntov, Sb. 3, Acad. Sci. USSR, Moscow, 1957.
- [7] P. J. Holmquist. "Uber mechanische Störungen und Chemische Umsetzungen in dem Bänderthon Schwedens," Bull. Geol. Inst. Univ. Uppsala, Sweden, Vol. III, 1897.
- [8] G. Bouyoucos. "Further Studies on the Freezing Point Lowering of Soils," Mich. Agri. Coll. Exptl. Station, Tech. Bull. 31, 1916.
- [9] G. Bouyoucos. "Classification and Measurement of the Different Forms of Water in Soil by Means of the Dilatometer Method," ibid., Tech Bull. 36, 1917.
- [10] G. Beskow. "Tjälbildningen och Tjällyfteingen," Sver. Geol. Unders. Ser. C, No. 375, Stockholm, 1935. English transl., Soil Freezing and Frost Heaving with Special Application to Roads and Railroads, J. O. Osterberg, Northwestern Univ., Ill. 1947.
- [11] E. Yung. "Weiterer Beitrag zur aggregierenden Einwirkung des Frostes auf den Erdboden Zeitschr," F. Pflanz, Düng, W. Bodenkunde, B 24 H 1-2, 1932.
- [12] N. A. Tsytoovich. Stroitel'stvo v usloviakh vechnoi merzloty, Acad. Sci. USSR, 1941.
- [13] N. A. Tsytoovich. "K teorii ravnovesnogo sostoianiya vody v merzlykh gruntakh," Acad. Sci. USSR, Geogr. and Geophys. Ser., Vol. 9, No. 5-6, 1945.
- [14] N. A. Tsytoovich. O nezamerzayushchei vode v rykhlykh gornykh porodakh, Acad. Sci. Geol. Ser., No. 3, 1947.
- [15] A. E. Fedosov. "Mekhanicheskie protsessy v gruntakh pri zamerzani i ottaivani," Proc. Geol. Sci., Acad. Sci. USSR, 1940.
- [16] Z. A. Nersesova. "Izmenenie l'distosti gruntov v zavisimosti ot temperatury," Dokl. AN SSSR, Vol. 75, No. 6, 1950.
- [17] Z. A. Nersesova. "O taini l'da v gruntakh pri otritsatel'noi temperatury," ibid., Vol. 79, No. 3, 1961.
- [18] Z. A. Nersesova. Fazovy sostov v gruntakh pri zamerzani i ottaivani, Materialy po laborat. issledovaniyam merzlykh gruntov, Sb. 1, Acad. Sci. USSR, Moscow, 1953.
- [19] F. G. Bakulin. L'distost' i osadki pri ottaivani mnogoletnemerzlykh chetvertichnykh otlozheniy Vorkutskogo rayona, Acad. Sci. USSR, Moscow, 1958.
- [20] I. N. Votyakov. Fiziko-mekhanicheskiye svoystva mnogoletnemerzlykh gruntov Tsentral'noy Yakutii, Acad. Sci. USSR, Moscow, 1961.
- [21] N. A. Tsytoovich. "Nekotorye obshchie voprosy metodiki issledovani fiziko-mekhanicheskikh svoystv gruntov," Material for Laboratory Studies of Frozen Soils, Section 2, Acad. Sci. USSR, Moscow, 1954.
- [22] T. A. Litvinova. Vliyaniye udel'noy poverkhnosti i ul'traporistosti merzlykh gruntov na sodержaniye v nikh nezamerzshoy vody, (author's abstract for degree, Cand. Geol. Min. Sci.) Moscow, 1961.
- [23] M. N. Gol'dshteyn. "Deformation of Subgrade and Building Foundations During Freezing and Thawing," Tr. Vses. n.-i. in-ta zh. d. transporta, [Trans. All-Union Sci. Res. Inst. Railroad Transportation], No. 16, 1948.
- [24] Osnovy Geokriologii, Vol. 1, chap. 5, Acad. Sci. USSR, Moscow, 1959.
- [25] R. Yong. "Research on Fundamental Properties and Characteristics of Frozen Soils," Proc. 1st Canadian Conf. Permafrost, Ottawa, 1963.
- [26] I. A. Tyutyunov. Migratsiya vody v torfyano-gleyevoy pochve v period zamerzaniya i zamerzshogo sostoyaniya v usloviyakh neglugbokogo zaleganiya vechnoy merzloty, Acad. Sci. USSR, Moscow, 1951.
- [27] A. A. Ananyan. "Peremeshchenie vlagi v merzlykh rykhlykh gornykh porodakh pod vliyaniem sil elektroosmosa," Kolloid. Zhur., Vol. 14, No. 2, 1957.
- [28] G. V. Boki. "Kristallokhimicheskie soobrazheniya a povedeni vody v merzlykh gruntakh," Vest. Mosk. un-ta, ser. IV, Geologiya (Herald of Moscow Univ., Ser. IV, Geol.), No. 1, 1961.
- [29] A. A. Ananyan. "Vzaimodeistvie vody v gornoi porodoi v svete predstavlenii o structure vody," Nauchn. dokl. vyssh. shkoly, Geol.-geogr. nauki, No. 2, 1959.
- [30] A. A. Ananyan. "O zhidkoi faze vody v merzlykh gornykh porodakh," Sb. Merzlotnyye issledovaniya, No. 1, Publishing House, Moscow State Univ., 1961.
- [31] I. A. Tyutyunov, Z. A. Nersesova. "Priroda migratsii vody v gruntakh pri zamerzani i osnovy fizikokhimicheskikh priemov bor'by s pucheniem," Acad. Sci. USSR, Moscow, 1963.
- [32] P. F. Low, C. W. Lovell. "The Factor of Moisture in Frost Action," Highway Res. Bull. No. 225, NAS-NRC, Washington, D.C., 1959.
- [33] A. Petit. "Untersuchungen über den Einfluss des Frostes auf die Temperaturverhältnisse der Bodon von verschiedener physikalische Berschaffenheit," Forsch. Agri. Phys., Vol. 72, 1893.
- [34] H. Winterkorn. "Mass Transport Phenomena in Moist Porous Systems as Viewed from Thermodynamics of Irreversible Processes," Highway Res. Bd., Sp. Rept. No. 40, NAS-NRC, Washington, D.C., 1958.
- [35] R. E. Grim. Clay Mineralogy, McGraw-Hill, N.Y.,

1953.

[36] N. A. Tsytovich. "Fundamentals of Frozen Ground Mechanics," Proc. 4th Intern. Conf. Soil Mechanics and Foundation Engr., Vol. 1, London, 1957.

[37] P. J. Williams. "Specific Heats and Unfrozen Water Content in Frozen Soils," Proc. 1st Canadian Conf. Permafrost, Ottawa, 1963.

DISCUSSION

R. D. MILLER—This paper is tantalizing. It deals with a broad range of phenomena and relationships of interest and significance, but the scope is so wide that only a glimpse of each item is obtained. Evaluation of the authors' thoughts in relationship to the authors' findings or vice versa is difficult. Among the items of greatest interest to this reader are the relationship of exchangeable ions to soil freezing and heaving processes and a critical initial temperature gradient for water movement in frozen soil. It is cause for regret that the

authors did not choose to present a selected subject in more detail. On the other hand, had they done so, we would not have had the benefit of the survey of their work.

CLOSURE

Professor Miller's comments regarding the article "Unfrozen Water in Frozen Soils" are valid. However, the authors, bearing in mind its limited scope and the fact that the problem of unfrozen water is being dealt with for the first time at an international conference, considered it more appropriate to discuss the general aspects of the decrease in the freezing temperature of water in soils, but not to investigate in detail other questions, each of which constitutes the topic of a separate report. The systematic study of the basic laws governing the freezing of water in soils was begun by the authors more than 20 years ago in N. A. Tsytovich's laboratory, V. A. Obruchev Permafrost Institute. Results of these investigations, beginning in 1945, have repeatedly appeared in publications of the Academy of Sciences of the USSR.

PHASE TRANSFORMATIONS OF WATER IN SOILS AND THE NATURE OF MIGRATION AND HEAVING

I. A. TYUTYUNOV, V. A. Obruchev Permafrost Research Institute, Moscow

The problem of water migration and frost-heaving in freezing soils has great scientific and practical importance. Without elucidating the nature of water redistribution and features of ice segregation in relation to physical and chemical properties of rocks, it is impossible to know the general laws of formation of the frozen zone of the lithosphere. Without studying water migration and frost-heaving of seasonally frozen soils, it is impossible to solve such problems as: Structural bond formation in dispersed systems and soil stabilization; stability of structural soils and protection of highways, railways, and airfields from frost-heaving, as well as protecting foundations of light structures from heaving.

It is impossible to consider all these problems without elucidating the physical nature of an inundation of a dispersed system, which by itself is important for solving problems in regions where building deformation is caused not by ice segregation but by soil swelling.

These ideas make it possible to work out physical and chemical principles for combating the frost-heaving of soils [1].

PHASE EQUILIBRIUM OF WATER IN UNFROZEN SOILS

When interacting with rocks and minerals, natural water essentially changes its properties. Being adsorbed on solid surfaces as a film, it is subject to compression, which is caused, Frenkel points out [2], by a transition of the thermal kinetic energy of its molecules into a potential energy of repulsion forces.

Film water is held by solids with great force—about tens and hundreds of atmospheres [3, 4, 5]. Being a quasi-crystalline body, it has geometrical and structural compressibility. Geometrical compressibility represents a result of shortening of intermolecular distance; structural compressibility is caused by a more compact packing of molecules [6]. That is, in compression, the translational motion of water molecules is substantially lowered, but total energy is not. By wetting a solid surface, the energy of its thin film increases; with microfissures it is "stored" as splitting pressure energy [7], though wetting is accompanied by the evolution of some heat.

A water-film thickness, held by the surface of a solid, depends on the magnitude of its surface energy. Also, the nearest molecules are attracted most by the surface and the

farthest ones, the least. Water, on being subjected to the maximum influence of a surface field of force, assumes special chemical and physical properties and is characterized by a different energy state than that of free water. Such water is usually called a strongly bound water; it can be estimated qualitatively by the value of the maximum hygroscopic water content. Because of special chemical and energy properties, the author proposes to call this water a boundary phase [7, 8]. The term boundary phase was introduced by B. V. Derjagin in 1950, but it had to some extent a different meaning.

Liquid wetting of a solid and vapor adsorption on its surface are conditioned by molecular forces in the broad sense of the word, the solid ("substrate") being a source of "a certain field of adsorption forces, acting on adsorbed molecules" [9]. Without such a surface field there can be no adsorption.

Any crystal has its volume electric (molecular) field which on splitting is transformed into a surface force field. The energy of the latter is half the energy with which its two crystal parts, formed by splitting, were held together. Consequently, the higher the crystal strength, the higher the surface field energy of a newly split surface will be.

The concept of surface energy can be studied through the following principles, which are very important for elucidating the physical nature of the migration process [7, 8, 9].

According to A. E. Fersman [6] ions, atoms, and molecules acting to form a solid contribute a certain proportion of energy in creating the crystal lattice. Hydration energy of ions in dilute solutions is an approximate characteristic of such an energy contribution.

Ions, forming the surface of a solid, preserve an unspent part of this energy, the surface energy [7, 8]. The higher the ion-hydration energy, the greater is the surface energy of surfaces formed by them.

Adsorption capacity and adsorption heat are determined by a surface force field energy, since the work of molecular forces arises because of a decrease in surface energy of an adsorbent [9].

Water adsorption by the surface of a solid is caused by a chemical reaction and shows as wetting of the solid by water.

According to Harkins [4] wetting is a conjunction of two processes occurring simultaneously: A destruction of internal bonds between water molecules and a formation of external

bonds of water molecules with solid surface ions. The work spent to destroy internal bonds is twice the surface energy of the fluid

$$W_d = 2\sigma_{la} \quad (1)$$

or equivalent to a liquid evaporation energy from a free surface. Thus, a water surface and its surface energy increase.

The work required to form bonds between fluid molecules and solid surface ions (atoms, molecules) is

$$W_B = \sigma_{sa} + \sigma_{la} - \sigma_{sl} \quad (2)$$

Wetting a solid surface with water can occur only when the work required to form external bonds is greater than the work required to destroy internal bonds and the difference between them is

$$W_B - W_d = \sigma_{sa} - (\sigma_{sl} + \sigma_{la}) \quad (3)$$

When the right side of (3) is zero, no new wetting surface occurs and a thermodynamic equilibrium is attained between water and solid.

In a particular case for (3), a wetting angle θ must be considered, i.e.,

$$W_B - W_d = \sigma_{sa} - (\sigma_{sl} + \sigma_{la} \cos \theta) \quad (4)$$

The water capillary elevation and water holding ability of natural soils depend on a boundary phase, since it covers the surface of mineral particles and interacts directly with free water.

Free water adsorption (volume phase) on a boundary phase resembles solid-surface wetting and is determined by

$$W_B' - W_d' = \sigma_{2,5} - (\sigma_{2,3} + \sigma_{3,5} \cos \theta') \quad (5)$$

Apparently a wetting of a boundary phase surface is not accompanied by a breaking of bonds between free water molecules; therefore, in (5)

W_B' is work used to weaken bonds between adsorbing water molecules.

W_d' is work used to form bonds between the boundary- and volume-phase molecules of water.

$\sigma_{2,5}$ is surface energy of the boundary phase on an interface with air.

$\sigma_{3,5}$ is surface energy of the volume phase (free water) on an interface with air.

$\sigma_{2,3}$ is surface energy on an interface between volume and boundary phases.

θ' is wetting angle of the boundary phase.

Undoubtedly, interaction of a boundary phase with free water is caused by an appropriate influence of a solid surface.

Adsorbed water on a boundary-phase surface undergoes some changes. This water is usually called loosely-bound water; however, it would be more correct to call it a near-boundary phase of water or an embryonic phase of ice [11] since it can be supposed that a spatial coordination of molecules in it is close to the coordination of molecules in an ice unit cell.

Interaction of various phases of the soil system is influenced by various fields, including gravity, natural electro-mechanical fields, and a temperature field.

In a gravity field, other things being equal, free or volume water drains away and a minimum is kept in a soil system.

It is known [12] that a surface energy σ of some phase depends on chemical potentials of μ_1, μ_2, μ_3 components, taking part in formation of this phase, i.e.

$$d\sigma = -\Gamma_1 d\mu_1 - \Gamma_2 d\mu_2 - \Gamma_3 d\mu_3 \dots \quad (6)$$

where $\Gamma_1, \Gamma_2, \Gamma_3$ are surface densities of the components.

If an interface between the phases is such that, for example, the excess surface density of the first and second components is zero, then

$$d\sigma = -\Gamma_3 d\mu_3 \quad (7)$$

There is a similar dependence of surface energy on an interphase electric potential expressed by

$$d\sigma = -\epsilon dV \quad (8)$$

where V is interphase electric potential and ϵ is electric capacity of the surface.

The influence of electrochemical fields on the formation and stability of a near-boundary phase as an embryonic phase of ice is especially great (Fig. 1).

In an equilibrium state of phases in the soil system

$$\sigma_{2,3} \cos \alpha = \sigma_{2,1} \cos \beta + \sigma_{3,4} \cos \gamma \quad (9)$$

where $\alpha, \beta,$ and γ are wetting angles of a boundary phase by a volume phase, of boundary phase by a near-boundary phase, and of a near-boundary phase by a volume phase.

If because of the influence of electrochemical fields, (9) is unbalanced, and

$$\sigma_{2,3} \cos \alpha < (\sigma_{2,1} \cos \beta + \sigma_{3,4} \cos \gamma) \quad (10)$$

a near-boundary phase increases in volume. When this relation exists

$$\sigma_{2,3} \cos \alpha > (\sigma_{2,1} \cos \beta + \sigma_{3,4} \cos \gamma) \quad (11)$$

a near-boundary phase decreases, being transformed into a thin film.

One should not consider the influence of a temperature field separately from other fields, excluding, of course, the beginning of water crystallization. Before the beginning of this process the temperature and electrochemical fields essentially influence a change of surface energy and can contribute to a volume increase of a near-boundary phase. When

$$\sigma_{2,3} \cos \alpha = \sigma_{2,1} \cos \beta \quad (12)$$

and

$$\sigma_{2,3} \cos \alpha < \sigma_{3,4} \cos \gamma \quad (13)$$

a near-boundary phase forms because of a volume phase. Thus, water in soil systems is essentially changed and the limit of these changes is a dynamic equilibrium.

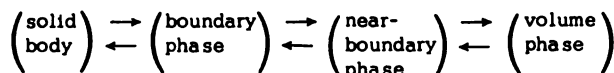

This equilibrium is a well-known relation, determined by A. F. Lebedev [3] and called, by V. I. Vernadsky, "a phase equilibrium" [13].

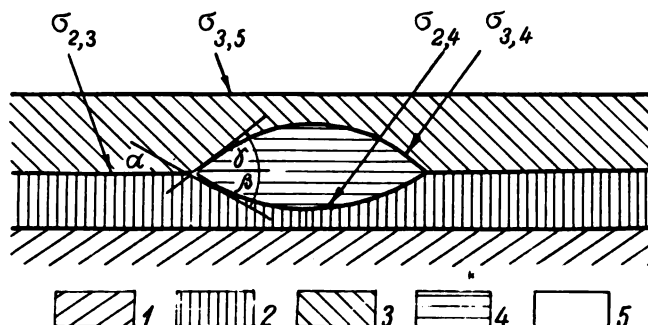
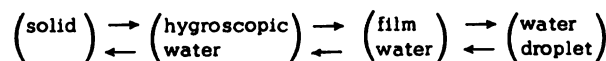

Fig. 1. Scheme of near-boundary phase formation 1 solid phase; 2 boundary phase; 3 volume phase; 4 near-boundary phase; and 5 air $\sigma_{2,3}$ surface energy on the interface of boundary-volume phases; $\sigma_{3,5}$ surface energy on the interface of air-volume phases; $\sigma_{2,4}$ surface energy on the interface of boundary-near-boundary phases; $\sigma_{3,4}$ surface energy on the interface of volume-near-boundary phases

Depending on the influence of electrochemical fields, water crystallization as affected by the temperature field may be different in time and space.

Before water freezes it must be supercooled; this is connected with the difficulty of forming and developing structural aggregates, a molecular spatial coordination that is similar to the molecular coordination of an ice unit cell. The origin of such a coordination is equivalent to a crystallochemical transformation; in pure water it is caused by hydrogen protons which are characterized by a tunnel effect [14]. As in free water, impurities appear as mineral particles and salt crystals; nucleation temperature and ice formation rate both increase, other things being equal, since impurities produce electrochemical fields that facilitate nucleation and separation of a near-boundary phase.

The role of solid particles is essentially changed as soon as they become a dispersed medium and the water becomes a dispersed phase. In these systems solid particles interact with the water collectively, forming a total force field system and, as mentioned, transform it into boundary, near-boundary, and volume phases, thus lowering the ice formation temperature. However, now it is related not to difficulty in developing a nucleus of sufficient size but with a total change of water energy conditions [15].

WATER MIGRATION IN FREEZING SOILS AND FROST-HEAVING

Water migration and frost-heaving of soils are related to ice segregation and volume increase of freezing water by 9%. However, ice formation does not always cause water migration in freezing soils and their frost-heaving.

Water redistribution in cooling soils is conditioned by their freezing rate. The lower an ambient temperature, the more water is frozen on the spot and the less frost-heaving. However, an experiment shows that sometimes intensive water redistribution and frost-heaving of soils begin only at very low temperatures. Thus, some water redistribution in freezing soils is determined by a phase equilibrium disturbance in them, and migration intensity depends on its restoration speed. Since equilibrium disturbance is caused first by transformation of the near-boundary phase into ice, the duration of an unbalanced state, besides temperature and water-content gradients, depends on gradients of other fields.

In reversible ice segregation the disturbed phase equilibrium is instantly restored as a result of direct interaction between ice and boundary phase. In all other cases some reduction of the crystallizing water surface precedes a microcrystal formation. If the formed microcrystals on their surfaces bear charges like those of the boundary phase surface, a further shift of the embryonic phase will depend on its formation rate and its stability in the formed electrochemical fields. When the rates of a near-boundary phase formation and the rate of its transformation into ice are equal, equilibrium is rapidly restored and the freezing soils, irrespective of degree of wetting and possibility of water inflow, assume a massive structure, characteristic of ice-cement.

In soil where the speed of a near-boundary phase formation exceeds the speed of its transformation into ice but is stable, equilibrium restoration occurs slowly, which causes a local water redistribution and ice segregation. In such conditions frost-heaving is usually negligible, even if there is a water inflow.

Freezing of the soil systems has a specific character when a near-boundary phase, formed rapidly, is very unstable. Instability of a near-boundary phase is caused by a continuous and apparently rapid change of this phase to an ice-segregation zone.

Thus duration of an unbalanced state of a soil system depends on a speed of spatial shift of a near-boundary phase. Any disturbance of the phase equilibrium is due to the surface energy change on the interface between the phases. The shift of a near-boundary phase is caused by a free surface energy gradient. The larger this gradient, the slower the equilibrium is restored which, in case of water inflow, causes an

accumulation of great quantities of ice and intensive soil frost-heaving.

The concepts presented here have been tested experimentally, to some extent.

Energy of wetting and the quantity of water adsorbed on the surface of a solid depend on the value of the surface energy, which is determined by the kind of surface ions [8].

Surfaces formed by multivalent ions are characterized by a large surface energy: Those formed by monovalent ions—by a comparatively small surface energy.

Methods have not yet been found for directly determining the surface energy of solids (including ice). However, the surface energy of a solid can be substantially changed by substituting another kind of surface ion having another energy level [6]. If in this substitution some of the ions produced an excess surface density, in accordance with (6) the change of surface energy is a function of the change of chemical potentials of the components on the interface. Ice surface energy can be changed both by adding a salt to the freezing water or by changing water crystallizing speed discussed below.

At the V.A. Obruchev Permafrost Research Institute, special investigations of the influence of various cations on ice segregation and frost-heaving were made. Experiments show that the saturation of soils by multivalent cations intensifies water inflow into the soil and its frost-heaving. In contrast, saturation of soils by monovalent cations

weakens those processes [1, 16]. Also, the main difference in the structure of the forming ice has been found. In soils saturated by multivalent cations water freezing begins with a generation of numerous microcrystals, which afterwards are formed under conditions of a mutually compressed growth and assume a needle-shaped form, at least in the initial development.

In soils saturated by monovalent cations ice crystals are larger in size and grow in a basal plane [17].

Ice crystal formation is accompanied by new interfaces. Further wetting of these interfaces, i.e., an added water inflow, proceeds intensively since, other things being equal, it is determined by the relation

$$(\sigma_{2,5} + \sigma_{6,5}) - (\sigma_{2,1} + \sigma_{4,5} \cos \theta_0) >> 0 \quad (14)$$

here $\sigma_{6,5}$ is a surface energy of the ice on an interface with air and θ_0 is the wetting angle of the boundary phase by a near-boundary phase.

If soil freezing occurs simultaneously with mineralogical transformations and is accompanied by new crystalline and poorly crystallized bodies, a specific surface energy of the new phases ($\sigma_{7,5}$) is part of the first term on the left of the inequality (14), i.e.

$$(\sigma_{2,5} + \sigma_{6,5} + \sigma_{7,5}) - (\sigma_{2,1} + \sigma_{4,5} \cos \theta_0) >> 0 \quad (15)$$

Experiments made it possible to assume that ice surface energy is higher in soils saturated by multivalent cations than in soils saturated by monovalent cations. Here we mean a specific surface energy that has been confirmed by laboratory investigations.

Indeed, water crystallization is accompanied by various electrical potentials differing in value and sign; here, depending on a composition of dissolved materials, the ice can be charged either positively or negatively with reference to the water [18, 19].

Highest potentials, measured sometimes by dozens of volts, occur at a high speed of water crystallization [20] and during the freezing of dilute solutions of salts with monovalent cations. This was confirmed by appropriate investigations at the V.A. Obruchev Institute. In the crystallization of dilute solutions of salts with multivalent cations there occur considerably lower potentials. The sign of the ice surface charge depends on the nature of the ions selectively absorbed by ice.

From this statement we can see that a surface energy gradient in freezing soils depends, to a great degree, on gradients of chemical and electrical fields.

At a greater soil freezing speed (when water crystallization is accompanied by considerable interphase electrical potential), a direct interface between formed ice and boundary phase is established. The surface energy of such interfaces is minimal; it is determined by the difference ($\sigma_{2,5} - \sigma_{6,5}$) and is the basis of this fact: That the moving force of the migration process is zero or even a negative value, i.e.

$$(\sigma_{2,5} - \sigma_{6,5}) - (\sigma_{2,1} + \sigma_{4,5} \cos \theta_0) \leq 0 \quad (16)$$

At a zero gradient the water is frozen in place; if the gradient is lower than zero, the water is squeezed out into warmer parts of the soil.

Monovalent cations weaken the water inflow into freezing soils. These ions decrease the surface energy of solid phases and increase the surface energy of a water near-boundary phase [1], causing minimum driving force in the migration. Here a near-boundary phase formation speed can be high, but in newly formed physical and chemical conditions the near-boundary phase is stable.

Nonheaving soils have been considered. However, any nonheaving soil can become a heaving one if physical and chemical conditions are changed. Saturation of a nonheaving soil by multivalent cations transforms it into a heaving one. During freezing of such soils intensive water inflow and maximum frost-heaving are observed, because multivalent cations increase surface energy of solid phases and decrease surface energy of a near-boundary phase. In such conditions the speed of near-boundary phase formation is high, but the near-boundary phase is unstable; this is due to the high value of the moving force of migration.

Water migration in freezing soils can be intensified if the transformation of a near-boundary phase into ice is accompanied by compaction of mineral particles in one place and formation of dehydrated surfaces of fracture at other places [10]. Fracture surfaces in freezing are formed in a certain vacuum and therefore are characterized by increased surface energy. The more such fracture surfaces are formed the longer a comparatively large gradient of a surface energy remains; and, therefore, migration proceeds more intensively.

As mentioned, frost-heaving of freezing soils is related to migration intensity. Its value is determined by the quantity of accumulated water and depends on an added moisture capacity compared with a thawed state, which is determined by the complex of "cryogenic" processes, i.e., the processes occurring at or below zero.

A water mass that is kept on a unit surface of a solid, irrespective of a gravity effect, is conditioned by the surface energy of the solid. Consequently, the water content (W_0) of a thawed soil is a function of its free surface energy.

$$W_0 = f(F_0) \quad (17)$$

where $F_0 = \sigma S_0$ and S_0 is the total surface of all mineral particles in a given volume of soil.

The increased water content (W_1) (during the freezing of this soil) depends on the total number of newly formed interfaces (S_1) that determine added free surface energy (F_1); i.e., $F_1 = \sigma_1 S_1$, where σ_1 is the total surface energy of newly formed surfaces of ice and other (cryogenic) minerals, as well as fracture surfaces.

Thus, the maximum heave value of a freezing soil (H) is given by

$$H = f(W_0 + W_1) = f(F_0 + F_1) = f(F) \quad (18)$$

When a direct interface is established between the formed ice (or other minerals), no increment of a new interface occurs and $F_1 = 0$. At the same time F_0 decreases in conformity with (16). Therefore, instead of heave, a shrinkage may be observed.

CONCLUSIONS

Soil systems form under the influence of a chemical reaction between rocks and water, because of their mutual transformation; characteristic of these systems is an equilibrium state between solid phases of the mineral part and liquid phases of the water.

Disturbance of this equilibrium causes water redistribution in a soil system. A gradient of a free surface energy is the driving force of migration.

In thawed soils the disturbance of equilibrium as a rule is negligible.

In freezing soils the disturbances are caused by a segregation of new phases that substantially change a free surface energy gradient—an intensity factor of the migration.

The duration of an unbalanced state of a soil system is a display of a capacity factor that depends on the formation and stability of a near-boundary phase.

If, under given conditions of ice segregation, the rate of a near-boundary phase formation is smaller than that of its transformation into ice, no water migration is observed; and the freezing soil not only does not heave but often contracts. When rates of formation and crystallization of this phase are equal, which is related to its stability in given conditions, soil freezing occurs without frost-heaving and contraction.

When a near-boundary phase formation rate is larger than the rate of its transformation into ice, soil freezing is accompanied by a large heave.

The immediate tasks for study of water migration and frost heaving of soils are: (a) Evolving methods for direct determination of surface energy of solids and ice and (b) elucidation of problems of the energy state of adsorbed water and its structure.

REFERENCES

- [1] I. A. Tyutyunov, Z. A. Nersesova. Priroda Migratsii vody v Gruntakh pri Promerzani i Osnovy Fiziko-Khimicheskikh Priyemov Bor'by s Pucheniyem, Moscow, Izd-vo Acad. Sci. USSR, 1963.
- [2] Ya. I. Frenkel. Kineticheskaya Teroriya Zhidkostey, Moscow-Leningrad, Izd-vo Acad. Sci. USSR, 1945.
- [3] A. F. Lebedev. "peredvizhenie vody v Pochvakh i Gruntakh," Izvestiya Donskogo C.-x Instituta, "Yedineniye" Publ. House, Rostov on-Don, 1919.
- [4] W. D. Harkins, D. T. Evening. "High Pressure Due to Adsorption and the Density and Volume Relations of Charcoal," J. Am. Chem. Soc., Vol. 23, No. 8, 1921.
- [5] W. D. Harkins. Physical Chemistry Surface Films, New York, 1962.
- [6] S. Brunauer. "Surface Energies of Solids. Solid-Gas Interface," Proc. 2nd Intl. Congr. Surface Activity, London 11, 1957.
- [7] P. A. Rebinder, L. L. Shreyner, K. F. Zhigach. Poniziteli Tverdosti v Burenii, 1944.
- [8] I. A. Tyutyunov. "Bzaimodeystvie mineral'noy chasti pochvy s vodoy," Pochvovedeniye, No. 2, 1959.
- [9] I. A. Tyutyunov. Protessy Izmeneniya i Preobrazovaniya Pochv i Gornykh Porod pri Otritsatel'noy Temperature, Izd-vo Acad. Sci. USSR, 1960.
- [10] B. V. Il'in. Priroda Adsorbtsionnykh Sil, Moscow-Leningrad, Izd-vo Acad. Sci. USSR, 1952.
- [11] A. Ye Fersman. Geokhimiya, Vol. 3, 1937.
- [12] G. Gibbs. Termodinamicheskiye Raboty, Moscow-Leningrad, Gostekhteorizdat, 1950.
- [13] V. I. Vernadskiy. Istoriya Mineralov Zemnoy Kory. Istoriya Prirodnikh Vod. No. 1, Leningrad, Goskhimtechizdat, 1933.
- [14] G. Bernal, R. Fowler. "Structure of Water and Ion Solutions," Uspekhi Fiz. Nauk, USSR, Vol. 14, No. 5, 1934.
- [15] I. A. Tyutyunov. Vvedeniye v Teoriyu Formirovaniya Merzlykh Porod, Izd-vo Acad. Sci. USSR, 1961.
- [16] Z. A. Nersesova. "Bliyanie obmennykh kationov na migratsiyu vody i pychenie gruntov pri promerzani," Issledovaniya po Fizike i Mekhanike Merzlykh Gruntov, No. 4, 1961.

- [17] O. S. Konnova. "Bliyanie obmennykh kationov na kriolennuyu texturu gornoy porody i struktury segregatsionnogo l'da," *ibid.*
- [18] E. I. Workman, S. E. Reynolds. "Electrical Phenomena Occurring During the Freezing of Dilute Aqueous Solutions and Their Possible Relationships to Thunderstorm Electricity," *Phys. Rev.*, Vol. 78, No. 3, 1950.
- [19] E. I. Workman. "On Geochemical Effects of Freezing," *Science*, Vol. 119, No. 3080, 1954.
- [20] F. I. Bayandina. "O raznosty potentsialov, voskikayushchey mezhdu tverдой i zhidkoy fazami pri zamerzani vody," *Izvest.*, Acad. Sci. USSR, *Seriya Geofizicheskaya*, No. 2, 1960.

DISCUSSION

R. D. MILLER—On the whole, I find myself sympathetic to the thoughts that inspired this paper, but prefer to think of the phenomena in a different frame of reference. I believe that the boundary phase associated with clay minerals is primarily a manifestation of a diffuse electric double layer that is fairly well described by the Gouy-Chapman model. It is not clear (to me) how much the properties of the boundary phase are determined by phenomena that cannot in turn be traced directly to the double layer electric field. An intuitive interpretation of known properties of the double layer, however, suggests that the functions of the boundary phase (or unfrozen film) in lens growth would be enhanced by monovalent exchangeable cations as opposed to divalent in the region of ice formation. On the other hand, one would anticipate that water migration through unfrozen soil toward the ice-lens would be hampered. The net effect, then, would depend upon which process was

DISCUSSION—SESSION 4

Z. A. NERSESOVA - Frozen Ground Research—The questions of phase composition and transitions of water are very important to the theory and practice of permafrost research. Most reports of this session treated the processes of water freezing in soils and the related phenomena of water migration and frost-heaving. The data and essential conclusions are very interesting. Of great importance are the qualitative soil peculiarities: The mineralogical and chemical composition of their clay-fraction, physicochemical properties. More than 30 years ago Stephen Taber pointed out and proved experimentally that the affinity to water of all solid phases of soils (including ice) was very important in the migration process. The experiments carried out in our laboratory proved that the unfrozen water content in frozen soils, the migration of water, and frost-heaving were dependent on their mineralogical and physicochemical peculiarities.

It is well-known that soils containing montmorillonite as the clay mineral are nonheaving and, in the case of kaolinite, give great frost-heaving. However, as shown experimentally, if the exchange cations are multivalent (calcium, iron), there is always intensive water migration and frost-heaving in montmorillonite clay; with monovalent exchange cations there are no such processes. In kaolinite clay with different exchange cations the dispersity and water properties are alike; but by freezing in conditions of "open system" in the case of multivalent exchange cations, there is intensive water migration, ice segregation, and frost-heaving. Monovalent cations (sodium, potassium) lead only to redistribution of the present water. It is caused by the influence of exchange cations on the surface energy of the soil skeleton. Thus the phase composition of water in frozen grounds, its transitions, and migration by freezing are essentially conditioned by the qualitative peculiarities of the mineral skeleton.

limiting in any particular case. The effect of divalent ions mentioned by Tyutyunov was to enhance heaving. I think this is an effect on the hydraulic conductivity of unfrozen soil rather than an effect on the boundary layer next to the ice-lens as Tyutyunov apparently believes. Unpublished results obtained in our laboratory by Pieter Høekstra show that substitution of exchangeable Na⁺ for Ca⁺⁺ on glass beads increases the rate of heave in an experiment of the Corte configuration, where the beads rest on an ice water interface that propagates upward.

CLOSURE

The essence of my article was to establish the possibility of regulating the moving force of water migration in freezing soil by the change in the composition of the adsorbed cations in the adsorbing complex of the soil.

Soil swelling in the last analysis is the consequence of water movement into the zone of crystallization and freezing there.

In freezing soils, water migrates until the border phase is a special water phase characterized by comparatively high surface energy. As soon as the border phase changes into the "double diffusion layer," water dissemination slowly ceases and it begins to freeze in place. Here are two examples: Highly dispersed soils of montmorillonite composition are basically characterized by particles forming a double diffusion layer. These soils, however, are nonswelling. At the same time soils of kaolinitic composition, with a negligible quantity of colloids, and a basic mass of their particles, do not form a classic double diffusion layer and represent typical swelling soils.

In other words the properties of the border phase, like the moving force of migration, cannot be deduced from the properties of the double diffusion layer of colloidal particles.

D. M. ANDERSON - Latent Heat of Freezing Soil Water—In the calorimetric determination of amounts of soil water remaining unfrozen at various temperatures, it has been widely assumed that the latent heat of freezing can be taken as that of an ordinary ice-water mixture [1 to 6]. Although Williams and Kolaian and Low adopted this assumption, they questioned some of its aspects; Williams called particular attention to the fact that soil water exists in a lower energy state than does normal water as evidenced by the evolution of heat when soils are wetted. Consider, at the freezing point, the transitions

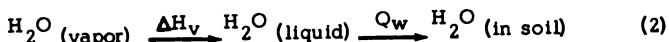
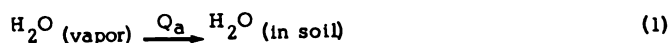

In these transitions, the subscripts denote the state of the water and the transitions may be regarded as changes in state (they may also be regarded as phase changes); ΔH_v is the latent heat of condensation, Q_a is the differential heat of adsorption, and Q_w is the differential (not the integral) heat of wetting. Here a positive sign indicates heat is evolved. If Q_a and Q_w are determined at constant pressure and in such a way that no work is done other than that due to expansion of water against atmospheric pressure, and if the initial and final states may be regarded as the same in (1) and (2), by the first law of thermodynamics Q_a may be regarded as equal to ΔH_v plus Q_w .

Consider next the freezing of soil water.

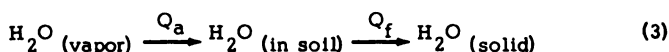

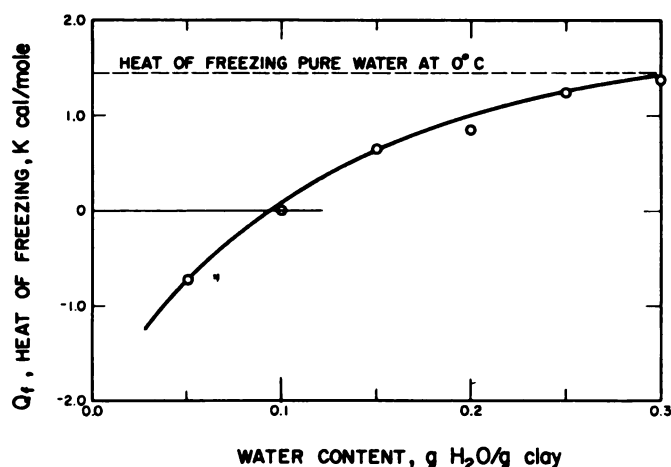
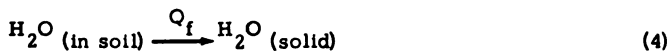
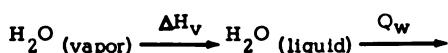
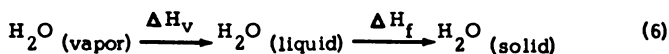
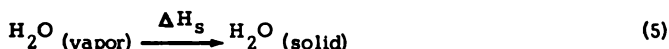

Fig. 1. Heat of freezing of water in Wyoming bentonite computed from (7) and the data of Mooney et al [7]



to be compared with



Q_f is the heat of freezing soil water, ΔH_s is the heat of condensation from the vapor to the solid state (the opposite of the heat of sublimation), and ΔH_f is the latent heat of freezing.

Assuming that soil ice has the same crystallographic structure as normal ice and that it excludes solutes and foreign substances as it freezes, so that we may regard the initial and final states of (3), (4), (5), and (6) as being the same, it follows that

$$Q_a + Q_f = \Delta H_s \quad (7)$$

$$Q_w + Q_f = \Delta H_f \quad (8)$$

Now it is well established that both Q_a and Q_w are continuous functions of the soil water content, increasing with decreasing soil water content in a roughly exponential fashion [7, 8]. This being so, it follows that Q_f must in general be smaller than ΔH_f , the difference becoming more and more pronounced at lower and lower soil water contents (or at lower unfrozen water contents).

If Q_a or Q_w is known as a function of soil water content, (7) and (8) permit one to estimate Q_f for that soil at various unfrozen water contents. This information is available for a number of soil materials. For example, from heat of desorption data for Wyoming bentonite [7] and (7), the decrease in Q_f , as the amount of unfrozen water in the clay diminishes, is shown in Fig. 1. (The differential heats of desorption were determined at about 10°C. The comparison would perhaps be more satisfying if they were available at the actual temperature of freezing; the error in this comparison, however, is certainly small.) Here negative values of Q_f mean heat must be supplied to freeze the soil water and positive values indicate that heat will be evolved on freezing. For Wyoming bentonite, the transition from negative to positive values of Q_f apparently occurs at a water content of about 10%. Assuming that this water is uniformly distributed over the enormous surface area of Wyoming bentonite

(8×10^6 sq cm/gm), this corresponds roughly to a monomolecular, interlamellar layer.

This argument clearly establishes the fact that some of the water present in Wyoming bentonite, and generally in all soils, will not freeze in the ordinary sense of the term. This finding also results from considering adsorption isotherms for water vapor on clays and soils. Mooney et al [7] report that at 0°C Wyoming bentonite with a water content of 10% has a water vapor pressure of only 1.1 mm compared to 4.5 mm mercury for ice. Obviously ice is not the most stable form for this clay-held water. Similar conclusions are reached on the basis of (8) and heat of immersion data [8, 9, 10].

The conclusion of Fig. 1 is obvious; the heat of fusion of soil water must always be somewhat lower than that of pure water; the difference, although different for every soil, becomes larger, the lower the unfrozen soil water content. Attention is thus directed to the necessity of experimentally verifying this conclusion and, if it is found to be correct, of determining the heat of fusion in representative soil water systems. Since (7) and (8) are based on the supposition that soil ice is no different than normal ice, it is important also to seek experimental verification of this assumption.

Martynov [11], on the basis of an X-ray study, indicates that this supposition is true but additional work is desirable. It may be found that the ice-water interfacial energy and the energy of clay lattice expansion and swelling need to be considered, although at present these considerations are thought to be of minor importance; in any case, they do not affect the main conclusion of the preceding argument. Meanwhile, the assumption of a constant heat of fusion equal to that of normal ice in calculating amounts of unfrozen water in soils from calorimetric data must be regarded as yielding erroneous results. Comparison of the areas under the curves in Fig. 1 indicate the probable magnitude of the error in the case of Wyoming bentonite. It is evident from Fig. 1 that conventional computation yields too much unfrozen water; the error, while negligible in some instances, becomes larger, the lower the unfrozen water content of the sample.

REFERENCES

- [1] J. H. Kolajan, P. F. Low. "Calorimetric Determination of Unfrozen Water in Montmorillonite Pastes," *Soil Sci.*, Vol. 95, 1963, pp. 376-384.
- [2] G. R. Lange, H. McKim. "Saturation, Phase Composition, and Freezing Point Depression in a Rigid Soil Model," Session 4 in this volume.
- [3] Z. A. Neresesova, N. A. Tsytovich. "The Unfrozen Water in Frozen Ground," *ibid.*
- [4] P. V. Vershinin, B. V. Derjagin, N. V. Kirilenko. "The Non-freezing Water in Soil," *Izvest. Akad. Nauk USSR, Ser. Geograf. I Geofiz.*, Vol. 13, 1949, pp. 108-114.
- [5] C. W. Lovell. "Temperature Effects on Phase Composition and Strength of Partially Frozen Soil," *Highway Res. Bd. Bull. No. 168*, 1957, pp. 74-95.
- [6] P. J. Williams. "Specific Heat and Unfrozen Water Content of Frozen Soils," *Proc. 1st Canadian Permafrost Conf. Tech. Mem. 76 NRC Ottawa*, 1963, pp. 109-126.
- [7] R. W. Mooney, A. G. Keenan, L. A. Wood. "Adsorption of Water Vapor by Montmorillonite I Heat of Desorption and Application of BET Theory," *J. Am. Chem. Soc.*, Vol. 74, 1952, pp. 1367-1371.
- [8] H. Janert. "The Application of Heat of Wetting Measurements to Soil Research," *J. Agr. Sci.*, Vol. 24, 1934, pp. 136-150.
- [9] A. C. Zettlemoyer, J. Young, J. J. Chessick. "Studies of the Surface Chemistry of the Silicate Minerals: III," *J. Phys. Chem.*, Vol. 59, 1955, pp. 962-966.
- [10] W. H. Slabaugh. "Heats of Immersion of Some Clay Systems in Aqueous Media," *ibid.*, Vol. 63, 1959, pp. 1333-1335.
- [11] G. A. Martynov. "Principles of Geocryology," pt. 1, chap. 6, *Acad. Sci. USSR*, 1959, pp. 153-192. (Tech. Trans. 1065 Natl. Res. Coun., Ottawa)

RELATION BETWEEN MEAN ANNUAL AIR AND GROUND TEMPERATURES IN THE PERMAFROST REGION OF CANADA

R. J. E. BROWN, Division of Building Research, National Research Council, Canada

Climate is basic to permafrost formation and is a most important factor influencing the existence of this phenomenon. Of all climatic factors, air temperature is the most readily measured and is most directly related to ground heat loss and heat gain. Observations in Canada and other countries indicate a broad relation between mean annual air and ground temperatures in permafrost.

Many investigators have estimated the mean annual air temperature required to produce and maintain permafrost [1]. There is, however, much disagreement on this matter. Terzaghi reported that the southern limit of permafrost coincides very roughly with the 32°F mean annual air isotherm [2]. Black reported that, because of local conditions, the mean annual air temperature required to produce or maintain permafrost varies many degrees; he suggested that it is generally between 24 and 30°F [3]. Nikiforoff in his hypothesis of the origin of permafrost suggested that the southern boundary coincides approximately with the 28.4°F isotherm [4].

In Canada, the southern limit of permafrost as presently known lies between the 25° and 30°F mean annual air isotherms except in western Quebec [5] (Fig. 1). West of Manitoba, the known limit of permafrost coincides approximately with the 30°F isotherm. In Manitoba, however, it cuts eastward from the 30° to the 35°F isotherm. In Ontario it coincides with the 25°F isotherm. In western Quebec it lies north of the 25°F isotherm from whence it extends southeastward into southwestern Labrador (and perhaps even further southward). Although observations are limited, the southern limit appears to cross the 25°F isotherm in southern Labrador and then extend northeastward between the 25° and 30°F isotherms to the Atlantic coast.

Apparently, the mean annual ground temperature differs from the mean annual air temperature by several degrees and this difference is not constant. Hence, precise prediction of permafrost distribution cannot be based solely on this factor.

Attempts have been made to relate permafrost distribution in Canada with freezing indexes [6, 7, 8] and thawing indexes [6, 7]. These indexes reflect annual fluctuations of air temperature about the freezing point and indicate the amount of heat added to and withdrawn from the ground. A station with a mean annual air temperature of 32°F will therefore have equal freezing and thawing indexes. As with mean annual air temperature, there is a broad relation between permafrost distribution and these indexes, but accurate prediction of permafrost occurrence cannot be based solely on this factor because of the influence of other climatic and terrain factors [1].

Nevertheless, a review of the literature and examination of the known southern limit of permafrost, shows some general correlation between mean air and ground temperature as indicated by the correspondence between certain isotherms and the permafrost boundary as well as by other evidence [1, 6].

INFLUENCE OF TERRAIN AND OTHER CLIMATIC FACTORS

The difference between mean annual air and ground temperature, and variations in this difference from place to place are caused by climatic factors other than air temperature in combination with surface and subsurface terrain factors. The complex energy exchange regime at the ground surface, which is influenced by these factors, is such that the mean annual

ground temperature is several degrees warmer than the mean annual air temperature. Factors which seem particularly influential are net radiation, vegetation, snow cover, and ground thermal properties that vary with time; other factors include relief slope and orientation and surface and subsurface drainage.

The difference between mean annual air and ground temperature can be explained in part by the fact that the ground surface is heated by solar radiation during the day to a much higher temperature than the air above; this excess heating more than balances the cooling of the ground surface by radiation during the night. Snow cover contributes to this situation by insulating the soil from the cold air above [9].

It is suggested that the difference between mean annual air and ground temperature would be greater in interior continental localities than in maritime locations because of the greater snowfall and accumulation in the former areas [10].

Variations in net radiation, vegetation, snow cover, and other factors contribute to observed differences in the thickness and temperature of permafrost in neighboring areas of the continuous zone having similar mean annual air temperature; they also help explain the patchy occurrence of permafrost at a particular location in the southern fringe of the permafrost region. The mean ground temperature in permafrost can vary at any given depth within a region of only a few square miles due to variations in surface cover, ground type, moisture content, geological structure, or geothermal gradient. In the discontinuous zone, variations in mean ground temperature frequently occur between the middle and edge of an individual body of permafrost.

Fluctuations in the permafrost boundary generally within confines of the 25 and 30°F mean annual air isotherms across Canada, and local variations in the permafrost within a small area, appear to be influenced by microclimatic and terrain features. Heavy snowfall in late autumn east of Hudson Bay may be responsible for the absence of permafrost at latitudes similar to those west of Hudson Bay where permafrost is widespread and late autumn snowfall is considerably less [6].

GROUND TEMPERATURE REGIME IN PERMAFROST

In permafrost, the temperature decreases steadily from the ground surface to a depth of about 50 to 100 ft [11]. Below this depth, the permafrost temperature increases steadily under the influence of heat from the earth's interior. Fluctuations in air temperature during the year produce a temperature oscillation in the ground to depths on the order of 50 ft with a time lag increasing with depth. At these depths, temperature variation is extremely small (less than 0.1°F); this is referred to as the "level of zero annual amplitude." Below this depth, influence of the annual air temperature cycle is not felt and ground temperatures change only in response to long-term changes extending over many centuries. Use of the present mean annual air temperature to predict the mean annual ground temperature at depths below the level of zero annual amplitude is complicated by the latter temperature being a reflection of both present and past climatic regimes (with possibly different mean annual air temperatures).

A change in mean annual air temperature can result, over a long time, in a significant change in the extent and thickness of permafrost. Observations from Canada, Alaska, and

the USSR show that the geothermal gradient can vary within wide limits ($1^{\circ}\text{F}/40$ ft to $1^{\circ}\text{F}/300$ ft) depending on thermal properties of soil and rock, geological structure, and other factors. In the Mackenzie River delta, Canada, W. G. Brown [12] found a geothermal gradient of $1^{\circ}\text{F}/53$ ft. Misener [13] observed a geothermal gradient of $1^{\circ}\text{F}/46$ ft at Resolute, NWT, in the Canadian Arctic archipelago. At Point Barrow, Alaska, geothermal gradients of $1^{\circ}\text{F}/42$ ft and $1^{\circ}\text{F}/53$ ft were found in an oil well [14] and beneath a small lake [15], respectively. Geothermal gradients ranging from $1^{\circ}\text{F}/72$ ft to $1^{\circ}\text{F}/324$ ft, depending on rock type, were observed in the Lena River basin, Siberia [16].

The lower values observed in North America may be attributed partly to the proximity of large bodies of water in contrast to those in the USSR which were mostly in inland watersheds. Shpolyanskaya [17] reported values in the Transbaikal region of the USSR which are of the same order of magnitude as those cited from Canada and Alaska: $1^{\circ}\text{F}/37$ ft in sedimentary rock and $1^{\circ}\text{F}/92$ ft in dense crystalline rock. Therefore, a change of 1°F , for example, in the mean annual air temperature could result over a long time in a change of 1°F in the mean annual ground temperature. This would cause a change in permafrost thickness of approximately 40 to 300 ft, depending on the geothermal gradient.

MEAN ANNUAL AIR AND GROUND TEMPERATURES IN CANADA

At present, ground temperature observations are available from 17 locations in Canada's permafrost region (Fig. 1). The latitude, longitude, height above sea level, permafrost distribution and thickness, and mean annual air temperatures of these stations are listed in Table I. Information is given also for Ottawa which is south of the permafrost region. Ground temperature values are listed in Table II.

At some of these stations the records are either of short duration, contain gaps, or are of questionable reliability due to observer error or instrument difficulties; thus, only approximate mean annual ground temperature values can be given. In some cases, the ground temperatures may not have had time to return to their original values prior to disturbance by installation procedures. In addition, an excess of drilling wash water frozen around a temperature cable in a hole would change the thermal diffusivity of the ground being measured from the surrounding undisturbed ground sufficiently to affect ground temperature observations.

DISCUSSION

Results of Observations

Most of the temperatures reported were measured under difficult field conditions and are of questionable precision so that only general relationships can be deduced. These ground-temperature measurements suggest that there is not a constant difference between them and the mean annual air temperatures. There is no instance, however, of the latter being higher than the former. Some of the ground temperature observations are either single observations or averages for only part of a year. As a result, the values vary slightly from the mean annual ground temperatures, the difference decreasing with depth to the level of zero annual amplitude where the difference should be negligible. Variations in temperature with depth are, of course, greatly influenced by the geothermal gradient, the magnitude of which varies from place to place.

In view of these factors, it is difficult to obtain a precise correlation between mean annual air and ground temperatures. Because the problem concerns variations in the ground thermal regime over a year or more, it is best to make measurements at a depth where the influence of short-term weather cycles

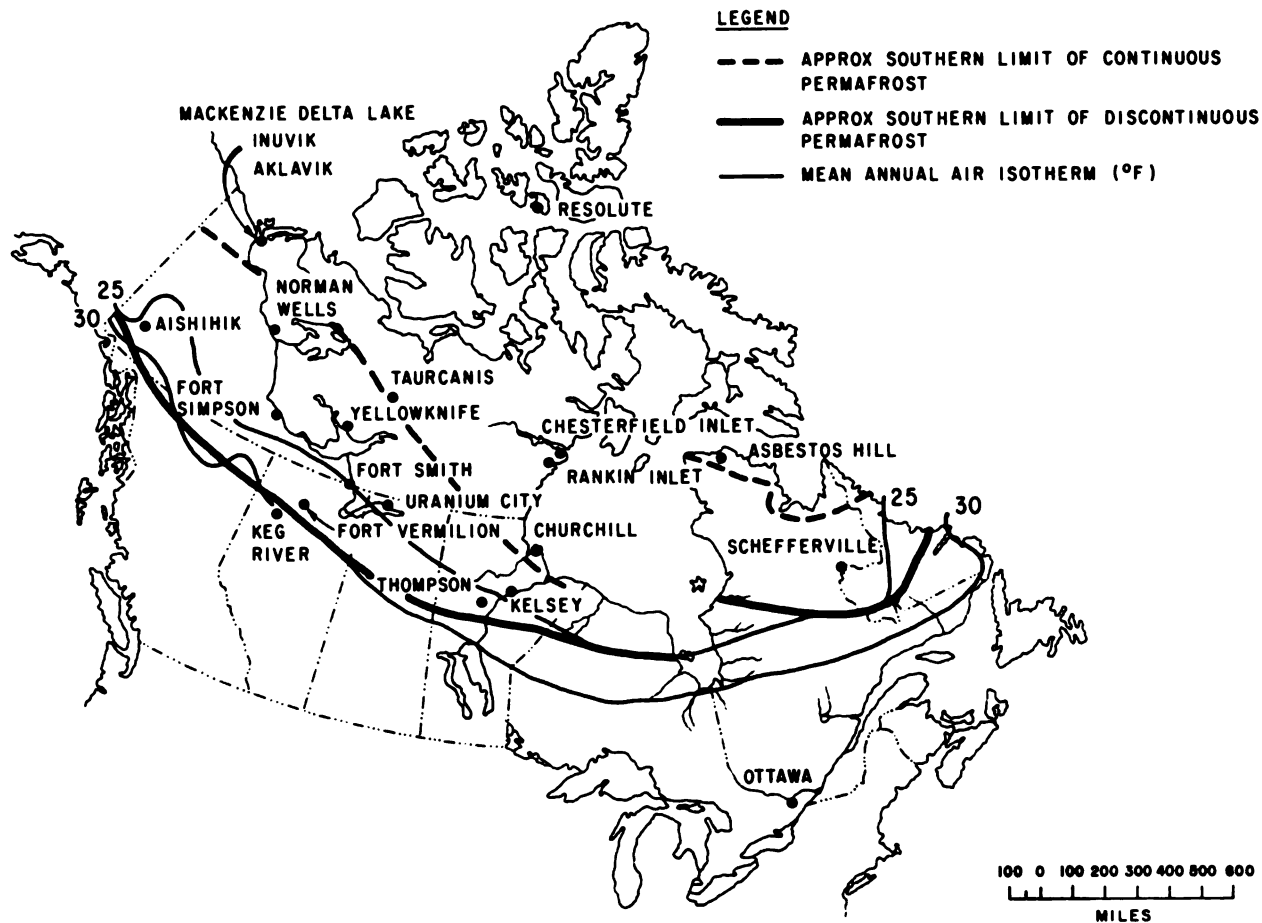

Fig. 1. Distribution of permafrost and ground temperature observation sites in Canada

will not be large (below about 2 ft). None of the ground temperature values (except Ottawa [38]) has been subjected to Fourier analysis because of the short duration of most of the observations and their uncertain accuracy. This type of analysis could be applied probably to the Fort Simpson and Fort Vermillion values.

Relation Between Air and Ground Temperatures

Air and ground temperature records show that the latter are warmer than the former by a wide range varying from about 1°F at Keg River, Alta., to 12°F at Taurcanis, NWT. Differences between mean annual air and ground temperatures are summarized in Table III.

Several factors complicate this situation: (a) Some individual ground temperature values above the level of zero annual amplitude may be higher or lower than the annual mean depending on the time of year and the depth. (b) Mean annual ground temperatures in permafrost decrease with depth from the ground surface to a depth of 50 to 100 ft and then steadily increase under the influence of the geothermal gradient. For

example, the ground temperature in the Taurcanis mine of 29°F at the 325-ft depth is probably several degrees higher than the probable temperature at the level of zero annual amplitude.

Mean annual ground surface temperatures (1 cm depth) are available at three stations. Comparison with mean annual air temperatures showed differences of 8.0°F at Ottawa, Ont., 10.4°F at Fort Simpson, NWT, and 11.6°F at Fort Vermillion, Alta.

Differences between mean annual air and ground temperatures were examined in relation to the relative continentality of their location. Maritime stations include: Asbestos Hill, Que., Churchill, Man., and Rankin Inlet and Resolute, NWT. Differences at these stations did not appear to vary significantly from those at the other stations. Undoubtedly this is due to the lack of precision in computing the differences and the variable depths at which observations were made.

As already noted, the most southerly occurrences of permafrost with temperatures between 31° and 32°G, several tens of feet thick, and not restricted to a particular type of terrain, are found at such stations as Thompson, Man., Kelsey, Man., and Uranium City, Sask. All these locations have mean

Table I.

Location	Lat. N	Long. W	Ht, asl ^a (ft)	Permafrost Zone	Permafrost Thickness, (ft) ^b	Source	Mean Ann. Air Temp., (°F)
1. Aishihik, Y.T.	61°39'	137°29'	3170	Discontinuous (Widespread)	50 to 100	[18]	24.5
2. Asbestos Hill, P.Q.	61°50'	73°45'	1650	Continuous	>930	[19]	17
3. Churchill, Man.	58°46'	94°08'	80	Continuous	100 to 200	[18] [20]	19
4. Fort Simpson, NWT.	61°52'	121°21'	415	Discontinuous (Patchy)	about 40	[18] [21]	25.0
5. Fort Smith, NWT.	60°01'	111°58'	665	None	. . .	DBR ^c	26.2
6. Fort Vermillion, Alta. (Keg River, Alta.)	58°23' 57°47'	116°03' 117°50'	950 1402	None Discontinuous	. . . about 5	[22] [23]	28.2 31
7. Inuvik, NWT. (Aklavik, NWT.)	68°18' 68°14'	133°29' 135°00'	198 30	Continuous Continuous	>300	DBR ^c	. . . 15.6
8. Kelsey, Man.	56°02'	96°32'	600	Discontinuous (Patchy)	about 30	DBR ^c	25.5
9. Mackenzie Delta Lake, NWT.	68°19'	133°50'	35	Continuous	250 to 300	[24]	15.6 (Aklavik)
10. Norman Wells, NWT.	65°18'	126°49'	240	Continuous or Discontinuous (Widespread)	150 to 200	DBR ^c [25] [26]	20.8
11. Rankin Inlet, NWT. (Chesterfield Inlet, NWT.)	62°49' 63°21'	92°05' 90°42'	. . . 13	Continuous	about 1000	[27]	. . . 11.2
12. Resolute, NWT.	74°41'	94°54'	56	Continuous	1300	[13]	2.8
13. Schefferville, P.Q.	54°49'	66°41'	1605	Discontinuous (Widespread)	>250	[28] [29]	23.9
14. Taurcanis, NWT.	64°02'	111°10'	. . .	Continuous	900	[30]	17
15. Thompson, Man.	55°36'	98°42'	700	Discontinuous (Patchy)	about 50	[31] [32]	24.9
16. Uranium City, Sask.	59°34'	108°37'	. . .	Discontinuous (Patchy)	about 30	DBR ^c	24
17. Yellowknife, NWT.	62°28'	114°27'	682	Discontinuous (Widespread)	200 to 300	[27]	22.2
18. Ottawa, Ont.	45°28'	75°38'	180	None	41.6

^aHeight above sea level

^bPermafrost thicknesses based on information reported to 1963

^cDivision of Building Research, Canada

Table II.

Location	Depth (ft)	Mean Ann. Ground Temp. (°F)	Ground Temp. (°F)	Observation Dates	Source	
1. Aishihik, Y.T.	20	28.3	. . .	1953-1959 (weekly)	DTC ^a	
2. Asbestos Hill, P. Q.	50	. . .	19.6	Average of two readings 15 Apr. '62 and 8 July '62	DBR ^b	
	100	. . .	19.6			
	200	. . .	19.6			
3. Churchill, Man.	25	. . .	27.5	July 1955	[33]	
	54	. . .	28.9			
4. Fort Simpson, NWT.	1 cm	35.4	. . .	1959-1962 (daily)	[34]	
	10 cm	34.9	. . .			
	20 cm	34.1	. . .			
	50 cm	34.6	. . .			
	100 cm	33.7	. . .			
	150 cm	33.2	. . .			
5. Fort Smith, NWT.	about 15	about 32	. . .	1950's	DBR ^b	
6. Fort Vermilion, Alta.	1 cm	39.8	. . .	1959-1962 (daily)	[34]	
	10 cm	38.9	. . .			
	20 cm	38.8	. . .			
	50 cm	38.9	. . .			
	100 cm	38.9	. . .			
	150 cm	38.9	. . .			
Keg River, Alta.	about 5	a few tenths below 32	. . .	Sept. 1963	DBR ^b	
7. Inuvik, NWT.	47	25.9	. . .	1955-1958 (weekly)	[35]	
	townsite	25	26.8	. . .	1961-1963 (weekly)	DBR ^b
		50	26.6	. . .		
		100	26.7	. . .		
	road to Hidden Lake	22	. . .	23.9	22 Sept. '62	DBR ^b
47		. . .	24.5			
97		. . .	25.4			
8. Kelsey, Man.	down to 30	30.5 to 31.5	. . .	1958-1963 (weekly)	DBR ^b	
9. Mackenzie Delta Lake, NWT.	50	. . .	25.4	6 May 1961	DBR ^b	
	75	. . .	25.9			
	100	. . .	26.5			
	150	. . .	28.0			
	200	. . .	29.2			
	surface	23.8 (calc.)	. . .			[12]
10. Norman Wells, NWT. 900 ft from river	60	. . .	28.6	1947-1948	[26]	
	100	. . .	28.6			
	180	. . .	31.7			
	200	. . .	32.0			
100 ft from river	50	. . .	26.0	1958-1962	DBR ^b	
	100	. . .	28.5			
11. Rankin Inlet, NWT.	about 100		about 15 to 17	1960	[27]	
12. Resolute, NWT.	50	10.0	. . .	1954-1957 (weekly)	[13]	
	100	8.5	. . .		[36]	
13. Schefferville, P. Q.	25	30.7	. . .	1962 (weekly)	MSRL ^c	
	50	30.2	. . .			
	100	30.3	. . .			
	140	30.6	. . .			
	190	31.7	. . .			
14. Taurcanis, NWT.	325	. . .	29	1961	[30]	
15. Thompson, Man.	down to 25	31 to 32	. . .	1961-1963 (weekly)	[31]	
16. Uranium City, Sask.	down to 30	31 to 32	. . .	1954-1957 (weekly)	DBR ^b	
17. Yellowknife, NWT.	2.3	33.0	. . .	1954-1957 (weekly)	[37]	
	4.3	32.4	. . .		DBR ^b	
	6.3	32.5	. . .			
	8.3	31.4	. . .			

Table II. (continued)

Location	Depth (ft)	Mean Ann. Ground Temp. (°F)	Ground Temp. (°F)	Observation Dates	Source
18. Ottawa, Ont.	1 cm	49.6	...	1959-1962 (daily)	[34]
	10 cm	49.0	...		
	20 cm	47.9	...		
	50 cm	48.5	...		
	100 cm	48.6	...		
	150 cm	48.6	...		

^aDepartment of Transport, Canada

^bDivision of Building Research, Canada

^cMcGill Subarctic Research Laboratory

annual air temperatures of about 24° to 25°F. An exception to this is Aishihik, Y.T., whose mean annual air temperature of 24.5°F is comparable, but the mean annual ground temperature of 28.3°F at the 20-ft depth is several degrees lower than the ground temperatures at the other three stations. However, a mean annual air temperature of, say 25°F or less, is almost certain to indicate a permafrost condition in the vicinity.

The question arises again as to what is the maximum mean annual air temperature at which permafrost can exist. Permafrost, albeit only a few feet thick, is found at Keg River, Alta., which has a mean annual air temperature of 31°F. It does not occur in the vicinity of Fort Vermillion, Alta. (28.2°F), nor at Fort Smith, NWT (26.2°F), nor even at the Experimental Farm at Fort Simpson, NWT (25.0°F). Clearly vegetation plays a dominant role in this situation. Permafrost at Keg River is confined to a few small scattered spruce-Sphagnum peat bogs. No such bogs occur in the Fort Vermillion area. Permafrost exists also in similar bogs in the fort Smith and Fort Simpson areas.

The origin of permafrost in these bogs, particularly in Keg River, could be attributed to one or more of the following causes:

- (a) It could be a remnant from the cooler climatic regime of the Pleistocene;
- (b) It could be short-lived permafrost of perhaps several decades duration which formed as a result of slightly lower air temperatures than those prevailing at present; and
- (c) It could be short lived as in the second case but formed as the result of terrain changes such as snow cover or drainage which were conducive to initiation of permafrost without a change in mean annual air temperature.

In all three cases the permafrost is protected by moss and peat cover; it would probably disappear and not re-form if this cover were removed.

Thermal Mechanisms

Mechanisms which allow formation of permafrost in these bogs are associated with variations in heat exchange at the surface of the moss and peat. When dry, peat has a low thermal conductivity, equivalent to that of snow. When wet, its thermal conductivity is greatly increased; when frozen its thermal conductivity is many times that of dry peat. During summer, a thin surface layer of dried peat having a low thermal conductivity would prevent warming of the underlying soil. During the cold part of year, the peat is saturated from the surface; when it freezes, its thermal conductivity greatly increases. Because of this the amount of heat transferred in winter from the ground to the atmosphere through the frozen ice-saturated peat is greater than the amount transmitted in the opposite direction through the surface layer of dry peat and underlying wet peat in summer. A considerable portion of heat is also required during the warm period to melt the ice and to

Table III.

Location	Mean Ann. Air Temp. (°F)	Ground Temp. (°F)	Approx. Air-Ground Difference (°F)
1. Aishihik, Y.T.	24.5	28.3 (20 ft)	4
2. Asbestos Hill, P.Q.	17	19 to 20 (50 ft to 200 ft)	2 - 3
3. Churchill, Man.	19	27.5 to 28.9 (25 ft to 54 ft)	8 - 10
4. Fort Simpson, NWT.	25.0	35.4 (surface) to 33.2 (150 cm)	8 - 10
5. Fort Smith, NWT.	26.2	About 32 (about 15 ft)	6
6. Fort Vermillion, Alta.	28.2	39.8 (surface) to 38.9 (150 cm)	10 - 11
(Keg River, Alta.)	31	A few tenths degree below 32 (about 5 ft)	1
7. Inuvik, NWT.	...	About 26 (25 ft to 100 ft)	10
(Aklavik, NWT.)	15.6		
8. Kelsey, Man.	25.5	30.5 to 31.5 (down to 30 ft)	5 - 6
9. Mackenzie Delta Lake, NWT.	15.6 (Aklavik)	23.8 (surface) to 26.5 (100 ft)	8 - 11
10. Norman Wells, NWT.	20.8	About 26 to 28.5 (50 ft to 100 ft)	5 - 8
11. Rankin Inlet, NWT. (Chesterfield Inlet, NWT.)	...	About 15 to 17 (about 100 ft)	4 - 6
12. Resolute, NWT.	2.8	10.0 (50 ft) to 8.5 (100 ft)	6 - 7
13. Schefferville, P.Q.	23.9	About 30 to 31.5 (25 ft to 190 ft)	6 - 8
14. Taurcanis, NWT.	17	29 (325 ft)	12
15. Thompson, Man.	24.9	31 to 32 (down to 25 ft)	6 - 7
16. Uranium City, Sask.	24	31 to 32 (down to 30 ft)	7 - 8
17. Yellowknife, NWT.	22.2	33.0 (2.3 ft) to 31.4 (8.3 ft)	9 - 11
18. Ottawa, Ont.	41.6	49.6 (surface) to about 48 (150 cm)	6 - 8

warm and evaporate the water. The net result is a negative imbalance of heat and conditions conducive to the formation of permafrost.

Snow Cover

The influence of snow cover on the variation between mean annual air and ground temperatures warrants separate consideration. This is illustrated by comparing mean annual air and ground temperatures at Fort Simpson, NWT; Fort Vermillion, Alta., and Ottawa, Ont., all located at Dominion Experimental Farms of the Canadian Department of Agriculture. Despite similarities in vegetation and soils, differences between mean annual air and ground surface temperatures (1 cm depth) for the period 1959 to 1962 vary among the three stations—Fort Simpson, 11.2°F; Fort Vermillion, 9.7°F; and Ottawa, 7.0°F.

Significant differences in snow cover could account for these variations. Average monthly snow cover depths for October to December when winter frost penetration is initiated are 5.9, 3.2, and 1.3 in. for Fort Simpson, Fort Vermillion, and Ottawa, respectively.

Average monthly snow cover depths for April and May when air temperatures rise above 32°F and initiate thawing of the frozen ground are 11.2, 2.9, and 0.0 in., respectively.

Therefore, the snow cover would have the greatest effect at Fort Simpson and the least at Ottawa. It is difficult to estimate, however, the net effect of the relative amounts of snow cover during the freezing and thawing periods on mean annual ground temperatures.

Snow cover reduces the amount of solar radiation received at the ground surface thus affecting the differences between mean annual air and ground temperatures. Observations are available for Fort Simpson and Ottawa, and annual amounts of radiation received at both stations have about the same effect when considered in relation to snow cover. During May to September (1959 to 1962) when the ground was free of snow, the daily average incoming solar radiation was about 470 g cal/sq cm at Ottawa and 425 g cal/sq cm at Fort Simpson—a difference of only 10%. During October to April (1959 to 1962) when the ground was snow covered at Fort Simpson and Ottawa for most of the period, solar radiation at Ottawa was about 225 g cal/sq cm and at Fort Simpson about 130 g cal/sq cm—a difference of 42%. The effect of this large difference would be practically nullified, however, by the snow cover at both sites.

CONCLUSION

It appears that an accurate prediction of mean annual ground temperature and the occurrence of permafrost at a site solely from the mean annual air temperature is subject to variations caused by other climatic and terrain factors already noted. Many more observations are required before anything more than a broad relation can be established. This is a formidable but, hopefully, not impossible task.

REFERENCES

- [1] R. F. Legget, H. B. Dickens, R. J. E. Brown. "Permafrost Investigations in Canada," Proc., 1st Intl. Symp. Arctic Geol., Vol. II (Geology of the Arctic), Univ. Toronto Press, 1961, pp. 956-969.
- [2] K. Terzaghi. "Permafrost," J. Boston Soc. Civil Engrs., Vol. 39, 1952, pp. 1-50.
- [3] R. F. Black. "Permafrost," Ann. Rept. Bd. of Regents Smithsonian, 1950, Washington, D.C., G.P.O., pp. 273-301.
- [4] C. Nikiforoff. "The Perpetually Frozen Subsoil of Siberia," Soil Sci., Vol. 26, 1928, pp. 61-78.
- [5] M. K. Thomas. Climatological Atlas of Canada, Natl. Res. Coun., Div. Bldg. Res., and Dept. Transport, Meteorol. Div., NRC 3151, 1953.
- [6] R. J. E. Brown. "Distribution of Permafrost and Its Relation to Air Temperature in Canada and the USSR," Arctic, Vol. 13, 1960, pp. 163-177.
- [7] H. A. Thompson. "Freezing and Thawing Indices in Northern Canada," Proc., 1st Canadian Conf. Permafrost,

- Natl. Res. Coun., Canada, Assoc. Comm. Soil and Snow Mech., Tech. Memo. 76, 1963, pp. 18-36.
- [8] E. B. Wilkins, W. C. Dujay. "Freezing Index Data Influencing Frost Action," Proc., 7th Canadian Soil Mech. Conf., Natl. Res. Coun., Canada, Assoc. Comm. Soil and Snow Mech., Tech. Memo. 33, 1954, pp. 36-39.
- [9] J. E. Carson. Soil Temperature and Weather Conditions, Argonne Natl. Lab., Rept. No. 6470, Argonne, Ill., 1961.
- [10] D. W. Boyd. Natl. Res. Coun., Div. Bldg. Res., Ottawa, Canada, personal comm., 1963.
- [11] R. J. E. Brown, G. H. Johnston. "Permafrost and Related Engineering Problems," (in press).
- [12] W. G. Brown, G. H. Johnston, R. J. E. Brown. "Comparison of Observed and Calculated Temperature and Permafrost Locations Under a Lake," (in press).
- [13] A. D. Misener. "Heat Flow and Depth of Permafrost at Resolute Bay, Cornwallis Island, NWT, Canada," Trans. Am. Geophys. Union, Vol. 36, 1955, pp. 1055-1060.
- [14] M. C. Brewer. "Some Results of Geothermal Investigations of Permafrost in Northern Alaska," Trans. Am. Geophys. Union, Vol. 39, 1958a, pp. 19-26.
- [15] M. C. Brewer. "The Thermal Regime of an Arctic Lake," Trans. Am. Geophys. Union, Vol. 39, 1958b, pp. 278-284.
- [16] P. I. Mel'nikov. "O zakonornostnyakh rasprostraneniya i razvitiya merzlykh pochv i gornyykh porod v basseynе R. Leny," Materialy Po Obshchemu Merzlotovedeniyu, VII Mezhdudedomstvennoye Soveshchaniye Po Merzlotovedeniyu, Ozd-vo Akad. Nauk SSSR, Moscow, 1959, pp. 91-102.
- [17] N. A. Shpolyanskaya. "O vliyaniі usloviy teploobmena poverskhnosti pochvy s atmosferoy na vechnuy merzlotu v zabaykal'e," Vestnik Moskovskogo Universiteta, No. 2, 1962, pp. 37-42.
- [18] J. L. Jenness. Dept. Mines and Res., Geog. Bur., Ottawa, Canada (Permafrost questionnaire, July 22, 1946).
- [19] J. F. McQuat, E. Neczkar, R. D. Lawrence. Asbestos Project, Asbestos Hill, Que., Engr. Field Rept. No. 2, Murray Mining Corp., Ltd., Toronto, Dec. 15, 1961.
- [20] W. A. Johnston. "Frozen Ground in the Glaciated Parts of Northern Canada," Trans. Roy. Soc. Can., Vol. XXIV, Ser. 3, Sec. 4, 1930, pp. 31-40.
- [21] J. A. Pihlainen. Fort Simpson, NWT—Engineering Site Information; Soil and Permafrost Conditions, Natl. Res. Coun., Canada, Div. Bldg. Res., Tech. Paper No. 126, NRC 6452, 1961.
- [22] C. H. Anderson. Dominion Experimental Farm, Canada Dept. of Agr., Fort Vermillion, Alta., personal comm., 1962.
- [23] R. J. E. Brown, "Permafrost Investigations on the Mackenzie Highway" (in press).
- [24] G. H. Johnston, R. J. E. Brown. "Effect of a Lake on Distribution of Permafrost in the Mackenzie River Delta," Proc., 1st Canadian Conf. Permafrost, Natl. Res. Coun., Canada, Assoc. Comm. Soil and Snow Mech., Tech. Memo 76, 1963, pp. 218-225.
- [25] G. D. Garland, D. H. Lennox. "Heat Flow in Western Canada," Geophys. J. Royal Astron. Soc., Vol. 6, 1962, pp. 245-262.
- [26] R. A. Hemstock. Permafrost at Norman Wells, NWT, Imperial Oil, Ltd., Calgary, 1953.
- [27] "Permafrost Questionnaire," Natl. Res. Coun., Canada, Assoc. Comm. Soil and Snow Mech., Note No. 5, Ottawa, Dec. 1959.
- [28] L. Annersten. "Ground Temperature Measurements in the Schefferville Area, P.Q.," Proc., 1st Canadian Conf. Permafrost, Natl. Res. Coun., Canada, Assoc. Comm. Soil and Snow Mech., Tech. Memo. 76, 1963, pp. 215-217.
- [29] J. D. Ives. A Pilot Project for Permafrost Investigations in Central Labrador-Ungava, Dept. Mines and Tech. Surveys, Geog. Paper No. 28, Ottawa, 1961.
- [30] J. D. Boulding. Mine Manager, Taurcanis Mines Ltd., NWT, personal comm., 1961.
- [31] G. H. Johnston, R. J. E. Brown, D. N. Pickersgill. "Permafrost Investigations at Thompson, Manitoba," (in press).

- [32] J. A. Pihlainen. Ottawa, personal comm., 1963.
- [33] J. R. Lange. Corps of Engineers, U.S. Army CRREL, personal comm., 1955.
- [34] J. G. Potter. Soil Temperature Periods at Eight Localities in Canada 1959-1960, Canada Dept. Agr. Res. Br. and Dept. Transport, Meteorol. Br., 1962.
- [35] J. A. Pihlainen. Inuvik, NWT, Engineering Site Information, Natl. Res. Coun., Canada, Div. Bldg. Res., Tech. Paper No. 135, NRC 6757, 1962.
- [36] F. A. Cook. "Temperatures in Permafrost at Resolute, NWT," Geog. Bull., No. 12, 1958, pp. 5-18.
- [37] S. S. Copp. C. B. Crawford, J. W. Grainge. "Protection of Utilities Against Permafrost in Northern Canada," J. Am. Water Works Assoc., Vol. 48, 1956, pp. 1155-1168.
- [38] D. C. Pearch, L. W. Gold. "Observations of Ground Temperature and Heat Flow at Ottawa, Canada," J. Geophys. Res., Vol. 64, 1959, pp. 1293-1298.
- [39] J. D. Bateman. "Permafrost at Giant Yellowknife," Trans. Roy. Soc. Canada, Vol. 43, Ser. 3, Sec. 4, 1949, pp. 7-11.
- [40] J. Chang. Ground Temperature, Milton: Harvard Univ., Blue Hill Meteorol. Observatory, Vol. 1, 1958.
- [41] C. B. Crawford, R. F. Legget. "Ground Temperature Investigations in Canada," Engr. J., Vol. 40, 1957, pp. 1-8.
- [42] A. H. Lachenbruch, et al. "Temperatures in Permafrost," Temperature-Its Measurement and Control in Science and Industry, Reinhold Corp., New York, Vol. 3, pt. 1, 1962, pp. 791-803.
- [43] R. D. Lawrence, J. A. Pihlainen. "Permafrost and Terrain Factors in a Tundra Mine Feasibility Study," Proc. 1st Canadian Conf. Permafrost, Natl. Res. Coun., Canada, Assoc. Comm. Soil and Snow Mech., Tech. Memo. 76, 1963, pp. 207-214.

THERMAL REGIME BENEATH BUILDINGS CONSTRUCTED ON PERMAFROST

E. F. LOBACZ and W. F. QUINN, U.S. Army Cold Regions Research and Engineering Laboratory

The effect on buildings of temperature changes beneath buildings constructed over permafrost is one study being conducted by U.S. Army CRREL to improve engineering design and construction criteria for arctic and subarctic areas.

When permafrost was first investigated by the U.S. Army in 1946, little factual information existed about soil thermal regime beneath buildings sited on permafrost or about correlation of structure stability with alterations in permafrost conditions. Such data were needed to better understand building performance and to develop improved foundation designs. Accordingly, 11 test buildings were constructed at Alaska Field Station, with various ground exposures and insulators, to determine the effect of selected types of foundations on ground temperatures and on vertical movement of buildings. Eight test buildings were observed for about five years and three buildings for more than 15 years.

GENERAL SITE CONDITIONS

These studies were conducted at Alaska Field Station about 2.5 miles northeast of Fairbanks. The mean annual temperature of this subarctic locale is about 26°F with yearly extremes of about 90°F and -55°F. The mean freezing and thawing indexes are about minus 5700 and plus 3300 degree-days Fahrenheit, respectively. The freezing season usually starts in early October, and the thawing season about mid-April. Total annual precipitation averages 11 in., with a recorded maximum of 17.4 in. (1948) and a minimum of 5.6 in. (1957), including the water equivalent of about 60 in. of annual snowfall.

The terrain is characterized by a comparatively smooth gentle slope of about 3% that provides good surface drainage. Geologically, the area is located in the lower colluvial slopes between valley fill and the upper colluvial slopes of a rock upland. The natural soils are principally silts to a depth of about 50 ft with frequent inclusions of peat and ice-lenses. The silty top layer rests on a relatively thick stratum of silt, silty sand, and sand-gravel mixtures to a depth of about 250 ft. This stratum is underlain by bedrock. The upper surface of permafrost was originally about 3 ft (1946) beneath the surface in this locale and since then has come to equilibrium at a depth of about 5 to 6 ft. The lower permafrost boundary is at a depth greater than 160 ft. The water table during the thawing season is about 3 ft below ground surface and fluctuates between 0 and 6 ft.

BUILDING CONSTRUCTION

Buildings 1 through 8 were 16 ft square, prefabricated, heated,

tar-paper-covered, Army stout houses with entrance vestibules, erected in the summer and fall of 1946. The buildings differed only in types of floors and foundations (Table I). Buildings 9 through 11 were 32 ft square, wood frame, heated structures erected between July and November 1947.

The general arrangement of the eleven test buildings is shown on Fig. 1.

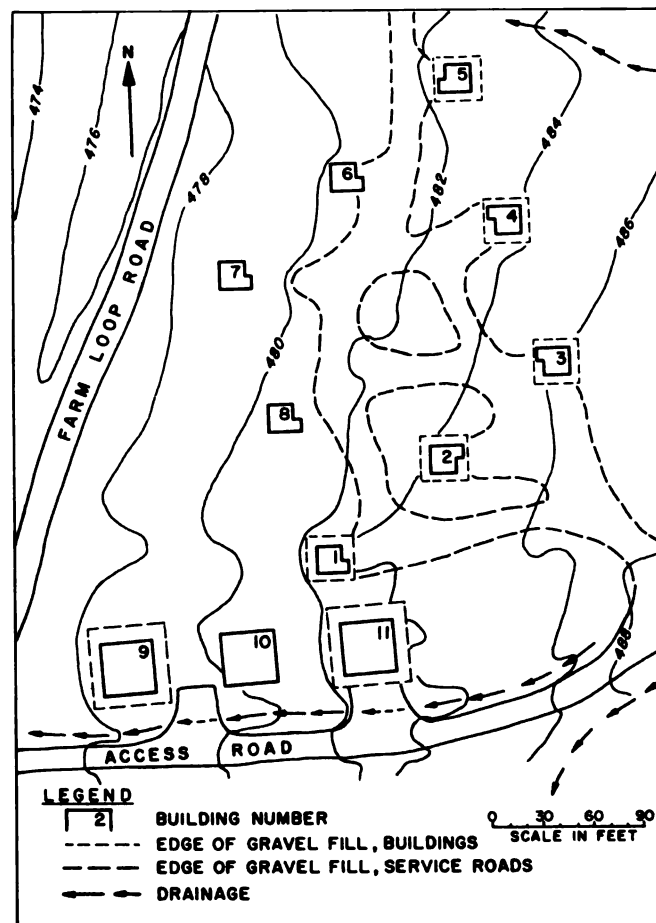

Fig. 1. Layout of test buildings

Table I. Temperature observations on eleven buildings

Bldg. No.	Type of Floor	Type of Foundation	Period of Temperature Observations
1	4-in. concrete slab	4-ft river-run gravel	14 Oct. 46 to 24 Jan. 52
2	2 by 4-in. joists, 16-in. O.C.; wood floor above and wood sheathing below. Rock wool batt insulation between joists.	4 by 4-in. mud sills on 4-ft river-run gravel	14 Oct. 46 to 24 Jan. 52
3	Same as No. 2	4 by 4-in. mud sills on 2-ft river-run gravel	4 Nov. 46 to 24 Jan. 52
4	Same as No. 2 except rock wool batts removed 2 Jan. 47	4 by 4-in. mud sills on 6-ft river-run gravel	14 Oct. 46 to 24 Jan. 52
5	Same as No. 2	4 by 4-in. mud sills on 4-ft river-run gravel and 6-in. cell concrete	14 Oct. 46 to 24 Jan. 52
6	Same as No. 2	Posts and pads, beams 2-ft above ground, no skirting	14 Oct. 46 to 13 July 51
7	Same as No. 2	Posts and pads, beams 2-ft above ground with skirting	Oct. 46 to June 51
8	Same as No. 2	4 by 4-in. mud sills on 3-in. pads on natural ground	Oct. 46 to Aug. 51
9	Double wood floor on 2 by 4-in. joists, 16-in. O.C.; rock wool insulation batts between joists	2 concrete slabs (upper 6 in., lower 9 in.) separated by 3-ft concrete piers; lower slab on 5.6 ft river-run gravel	June 48 to Feb. 58
10	Double wood floor on 2 by 8-in. joists, 16-in. O.C.; 0.5-in. insulation board beneath the joists and 3-in. vermiculite, loose fill insulation between joists	Piling in natural ground, 4-ft air space to flooring, wood skirting around air space	Jan. 48 to Apr. 58
11	18-in. concrete slab with 4 by 12 by 12-in. hollow clay tile ducts	5-ft river-run gravel	Jan. 48 to Apr. 58

INSTRUMENTATION

Changes brought about in the thermal regime beneath the buildings were measured with five thermocouple assemblies placed along a north-south line through the center of each building to an average depth of about 30 ft. These assemblies were at the building center 2 ft inside and 3 ft outside both the north and south walls. Twelve additional assemblies were installed under No. 2 to measure heat flow under and adjacent to the structure. Three assemblies were also located under grass-surfaced areas in the general locale.

Thermocouple assemblies were read initially at daily intervals and at weekly intervals after March 1947. Interior air temperatures for No. 1 through 8 were monitored periodically,

and an average value of 63.7°F is considered representative for the period of winter heating. Air temperatures were not read in No. 9, 10, and 11, but No. 9 and 10 were generally heated to 72°F; No. 11 temperatures were estimated as about 61 to 64.5°F.

THERMAL REGIME STUDIES

With erection of a structure in arctic and subarctic areas, an important change occurs in the thermal regime of the underlying soil. Such temperature change affects structure performance, particularly if the ground is subject to freeze and thaw.

Progression of seasonal freeze-thaw beneath the 11 test buildings can be divided into the following two distinct groups based on observed patterns of seasonal freeze and thaw: (1) Seasonal frost always penetrated to the permafrost table under those buildings with an air space beneath them, namely, No. 6 through 10 (an exception to this was a small pocket of residual thaw at the south edge of No. 10 caused by a unique ground-water flow condition); and (2) residual thaw zones were present under buildings without air circulation beneath the floors, No. 1 through 5 and No. 11. The residual thaw zones extended beneath gravel fills around the outside of buildings (the hollow clay tile was ineffective as an air space in the floor of No. 11). Typical patterns of seasonal freeze for these two groupings are shown on Figs. 2 and 3.

Insulated wood floors, supported on gravel foundations by mud sills, retarded flow of heat in some cases so that the gravel fill froze completely. Mud sills here are defined as 4 by 4-in. timbers placed directly on the ground surface. In most instances, seasonal frost did not penetrate under the center of the floor and only progressed a few feet in from the sides. The noninsulated concrete floor slab of No. 1 appeared to prevent frost penetration inside the edges.

Use of gravel fill under an insulated wood floor did not restrict penetration of frost to the underlying silt subsoil. Generally, frost penetrated under the building edges, but occasionally, a layer of silt froze under the entire building. Where frost penetrated the edges, it was commonly thawed by heat flow through the floor before start of the thawing season.

No important differences were noted in the seasonal freeze penetration on the north and south sides of a building except as noted for No. 10 above. Thawing started earlier and progressed faster at the south edge of a building than at the north side.

Heated structures with floor systems placed directly on 2 to 6 ft of gravel foundation fills (No. 1 through 5) caused permafrost degradation at a rate of between 0.75 to 1 ft per year beneath the building center (Fig. 4). A similar rate took place beneath No. 11 with hollow clay tile in the floor system. Cell concrete insulation in the gravel foundation fill of No. 5 had little effect in retarding thaw penetration. The permafrost table was not entirely uniform under these six buildings (Fig. 5), but curves shown on Fig. 4 are considered to give the general rate of permafrost degradation beneath

the center of the buildings. Slopes of these curves show that permafrost degradation would be expected to continue at a slightly reduced rate beyond the period of observations.

Degradation of permafrost under No. 6 through 10 was prevented or minimized with the air space incorporated under the floor to dissipate transferred heat by circulation of outside air as shown for No. 7 on Fig. 6.

No. 6, 7, and 8, supported by posts and pads or mud sills founded on natural silt soil and with circulation of air beneath the floor, underwent seasonal heave and settlement of about 0.2 to 0.4 ft with practically no progressive or net changes in displacement over several years (Fig. 7). Movement of these buildings was fairly uniform with no tilting or severe strain in the floor or walls.

The only significant effect on buildings founded on gravel fills without air spaces, No. 1 through 5, was a smaller amount of seasonal heave, but a progressive or net settlement over several years (Fig. 8). Insulated wood floors resulted in

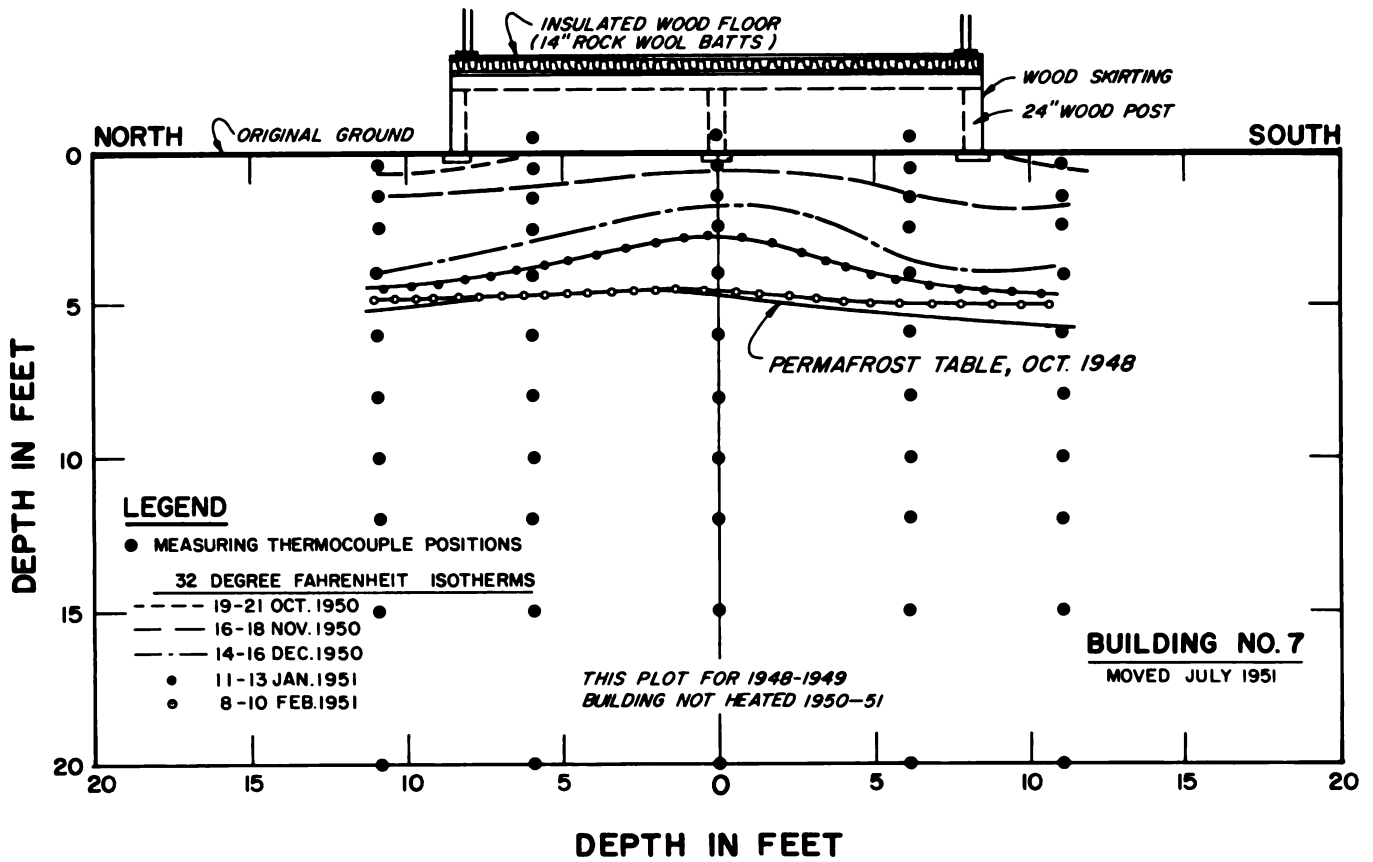

Fig. 2. Progression of seasonal freeze, No. 7

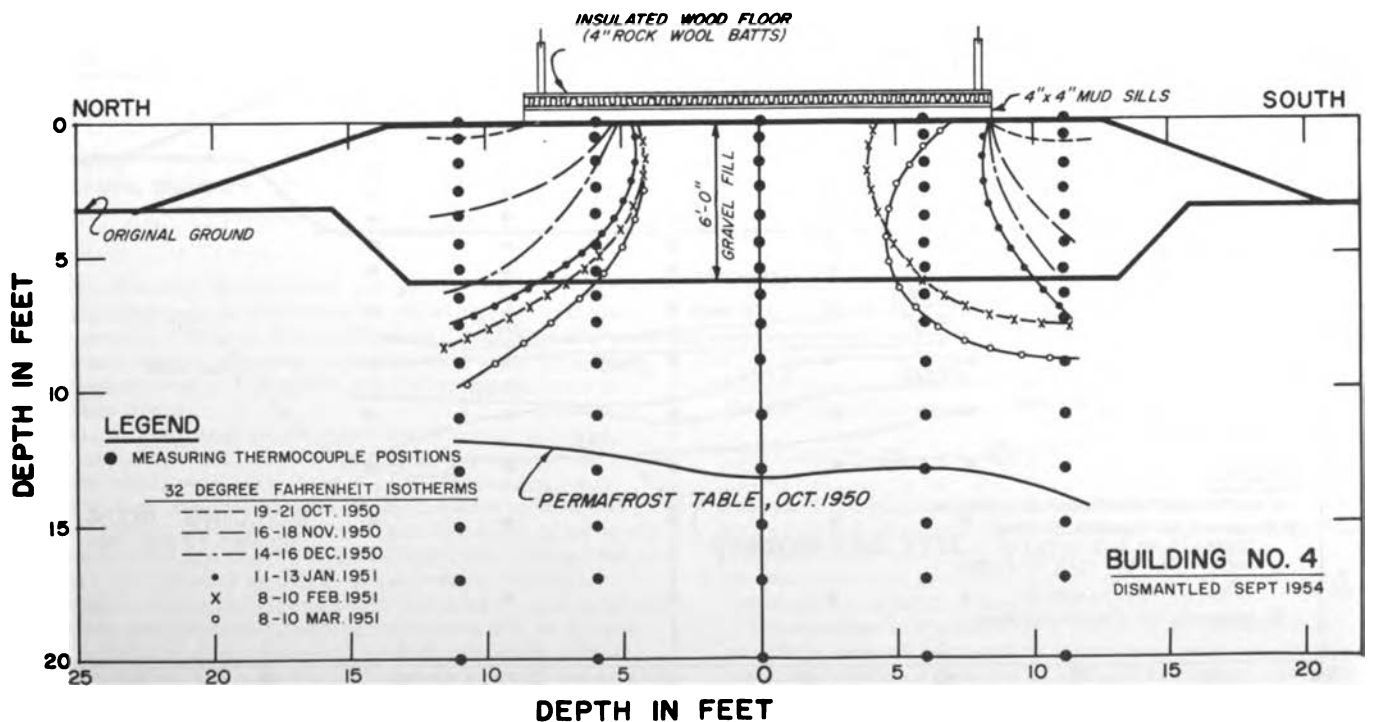

Fig. 3. Progression of seasonal freeze, No. 4

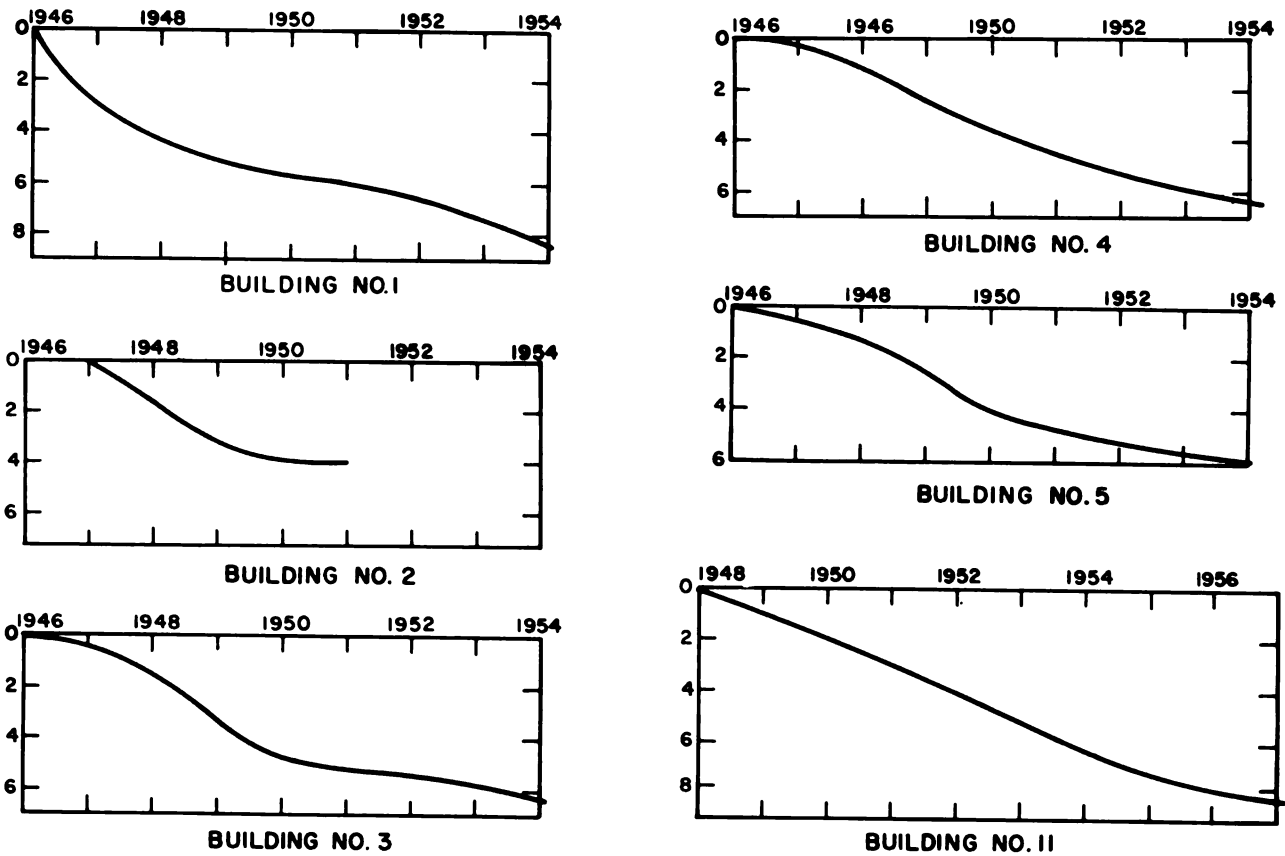

Fig. 4. Permafrost degradation beneath center of buildings on gravel fills of various thicknesses

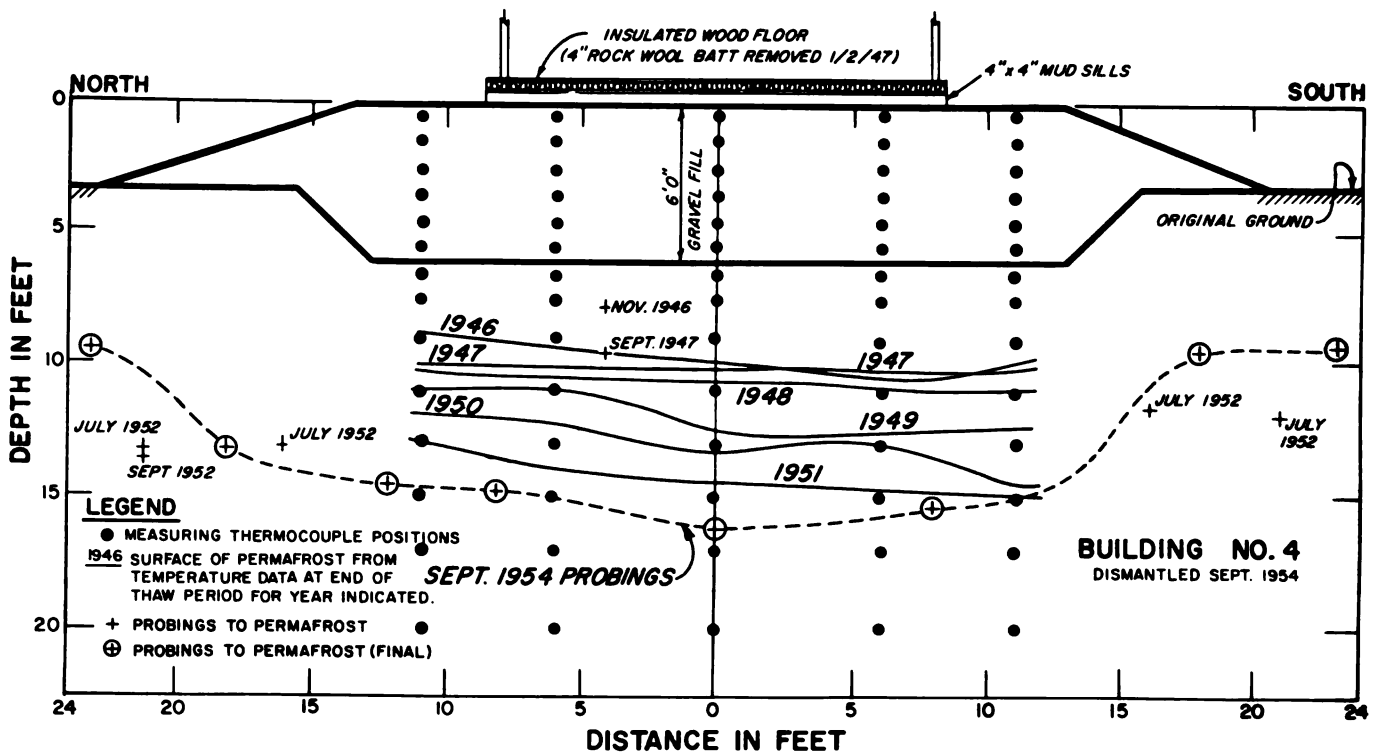

Fig. 5. Degradation of permafrost, No. 4

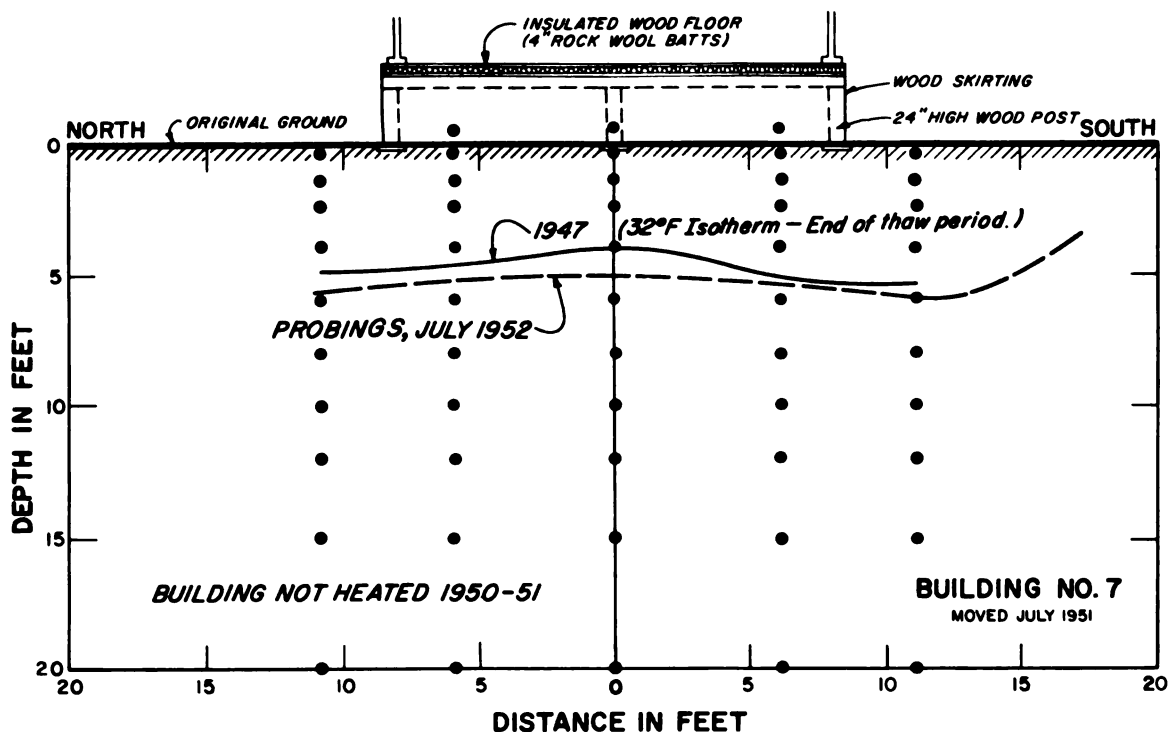

Fig. 6. Degradation of permafrost, No. 7

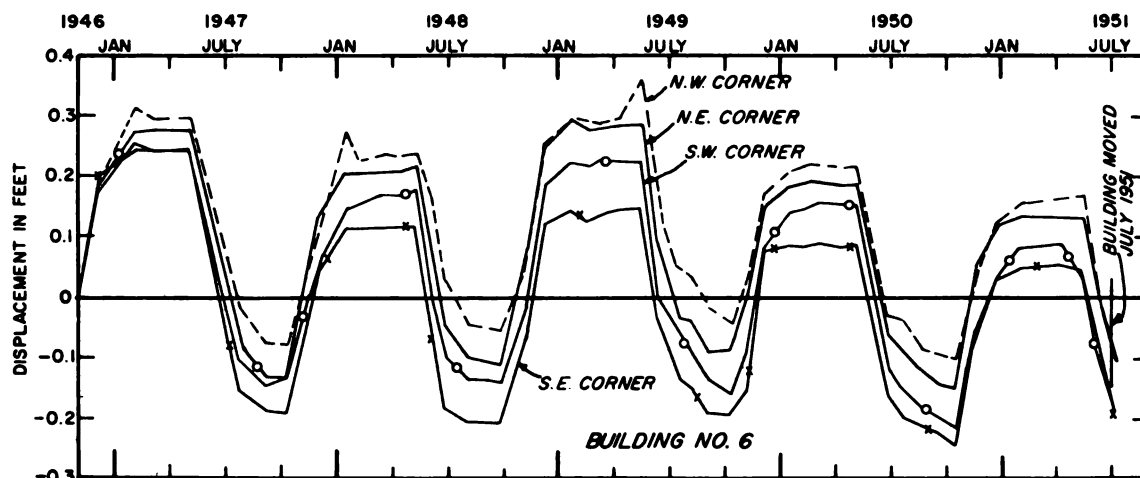

Fig. 7. Displacement of corners, No. 6

smaller amounts of settlement and tilting than uninsulated floors. Progressive settlement of gravel-fill foundations and its associated damage were more serious than the effects of seasonal heave. Buildings with insulated wood floors had smaller amounts of settlement and tilting than those with concrete floors.

No. 9, with both an air space and a gravel fill, had good stability. Seasonal heave, progressive settlement, and amount of tilt were only about 0.1 or 0.3 ft in six years. The rigid type of concrete foundation undoubtedly contributed to this excellent performance, but the combination of air space and gravel fill are also considered important factors (Fig. 9).

No. 10, founded on piles, supposedly anchored in permafrost with an air space beneath the floor, had considerable distress because of vertical movement of 1 or 2 piles. The majority of piles displaced upward only about 0.05 ft. The importance of bonding all piles to permafrost was vividly demonstrated in this instance.

No. 11 experienced minor displacements from 1946 to 1950, thereafter settled each summer, and remained essen-

tially stable in the winter. An elevation difference of 1.27 ft between the NE and SW corners was recorded in 1957, with a maximum of 2.0 ft at the SW corner. This difference increased to about 1.65 ft in 1962 when maximum displacement was about 2.4 ft, again illustrating the effectiveness of the hollow clay tile as an air space.

CONCLUSION

Building foundations with an air space between the floor and natural ground prevented permafrost degradation by dissipation of building heat through this space to the atmosphere. Seasonal freeze of the suprapermafrost occurred at a uniform rate resulting in uniform heave and subsidence.

Construction of concrete floor slabs on gravel fills over permafrost with ice segregation is not considered satisfactory because appreciable amounts of vertical settlement result from permafrost degradation.

Construction with insulated builtup wood floors on nonfrost-susceptible fills is considered slightly better than

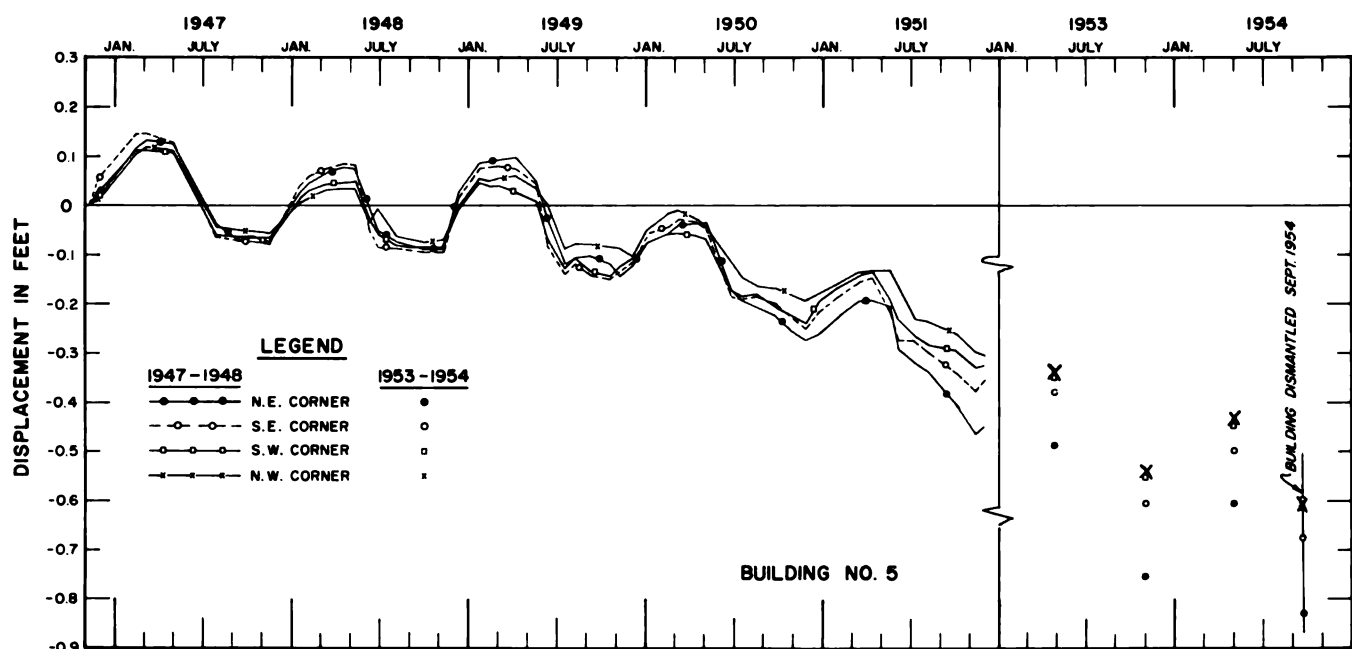

Fig. 8. Displacement of corners, No. 5

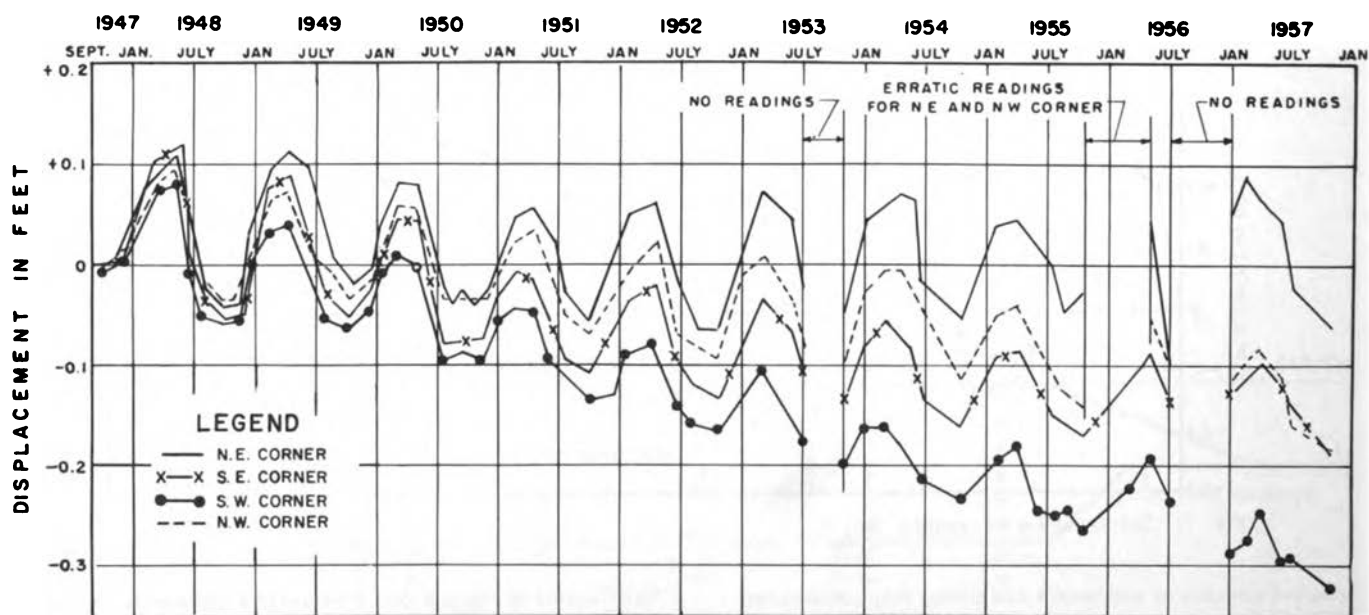

Fig. 9. Displacement of corners, No. 9

concrete slab construction because degradation of permafrost and progressive settlement are somewhat less.

Foundation construction, combining both an air space and nonfrost-susceptible fills, is considered superior to construction with air spaces only and use of slabs or insulated builtup floors placed directly on fills without provision for air circulation.

Buildings founded on piles with an air space above ground cause no appreciable degradation of permafrost. Seasonal freeze and thaw have no effect on the structure if all piles are firmly bonded in permafrost. This is considered a stable foundation design.

This foundation study was conducted in a relatively severe environmental area; that is, the area consisted of warm perma-

frost (temperature just a few degrees below freezing) and silty soil which is susceptible to the formation of ice-lenses.

ACKNOWLEDGMENTS

Substantial data for this study was furnished by personnel of the Alaska Field Station of the U. S. Army CRREL under the direction of F. F. Kitze. This investigation is part of the program being carried out by the U. S. Army CRREL for the Civil Engineering Branch, Engineering Division, Military Construction, Office, Chief of Engineers. Particular acknowledgment is given to M. S. Kersten, Professor of Civil Engineering, University of Minnesota, who was responsible for the original analysis of data.

DEGREE-DAYS AND HEAT CONDUCTION IN SOILS

F. J. SANGER, U.S. Army Cold Regions Research and Engineering Laboratory

The degree-day concept is used for computing heat conduction in soils to get approximate results for engineering purposes while more precise techniques are being evolved; simple degree-day techniques permit rapid computations, in the field if necessary.

Suppose the surface of a solid is at a temperature (T) for t days. The number of degree days then is measured by

$$\int_0^t (T - T_0) dt$$

where T_0 is a constant reference temperature. For computations in soil freezing and thawing, T_0 is usually 32°F, while T is often constant.

With fluctuating daily temperatures, the mean of the daily maximum and minimum temperatures is used for the daily average (this may mean a considerable error over a short period and in some locations having peculiar weather patterns, but it is normally acceptable). The total degree days is usually found by adding daily increments and plotting a mass curve of cumulative degree days, but data precise enough for many computations may be found by plotting monthly averages and finding the area between T_0 and the temperature-time curve.

FREEZING AND THAWING INDEXES

The total (negative) degree days for a freezing period is called a freezing index. Similarly, the total (positive) degree days for a thawing period is a thawing index; here the reference temperature (T_0) is almost always 32°F. For a varying temperature pattern the indexes are conveniently taken off the mass diagram. Absolute values of the indexes are commonly used in calculations. An air index is for a point 5 or 6 ft above the ground, while a surface index refers to the ground surface [1].

Depth of Penetration of the T_0 Isotherm in Ground Containing Water

A most useful expression in ascertaining depth of penetration of the T_0 isotherm in material containing water is the Modified Berggren equation [2]. The equation is based on a temperature step-change at the surface of a semi-infinite slab, initially at constant temperature (v_0) with respect to T_0 , the phase-change temperature. If v_s is the surface temperature ($T - T_0$) suddenly applied and retained for a time (t), X the depth of the T_0 isotherm, K the coefficient of thermal conductivity, and L the volumetric latent heat of the medium, then

$$X = \lambda \sqrt{\frac{2K v_s t}{L}} \quad (1)$$

where λ is a dimensionless coefficient that is a complex function of v_0 , v_s , L, and volumetric heat capacity (C). Analysis of ACFEL (Arctic Construction and Frost Effects Laboratory, Corps of Engineers, now incorporated in CRREL) field data showed that in natural conditions, ($v_s t$) is well represented by the freezing or thawing index I, and that the step-change theory can be applied with satisfactory precision.

If d is dry unit wt of soil; w its water content, % dry wt; i its ice content, % dry wt; c_s the specific heat of dry soil grains (0.17 near 32°F); L_s the latent heat of fusion of water-ice (144 Btu/lb); 1.0 the specific heat of water; 0.5 the specific heat of ice; suffix u unfrozen condition; suffix f frozen condition, then

$$C_u = \gamma_d \left(c_s + \frac{w}{100} \right) \quad (2)$$

$$C_f = \gamma_d \left(c_s + \frac{0.5i}{100} + \frac{w-i}{100} \right) \quad (3)$$

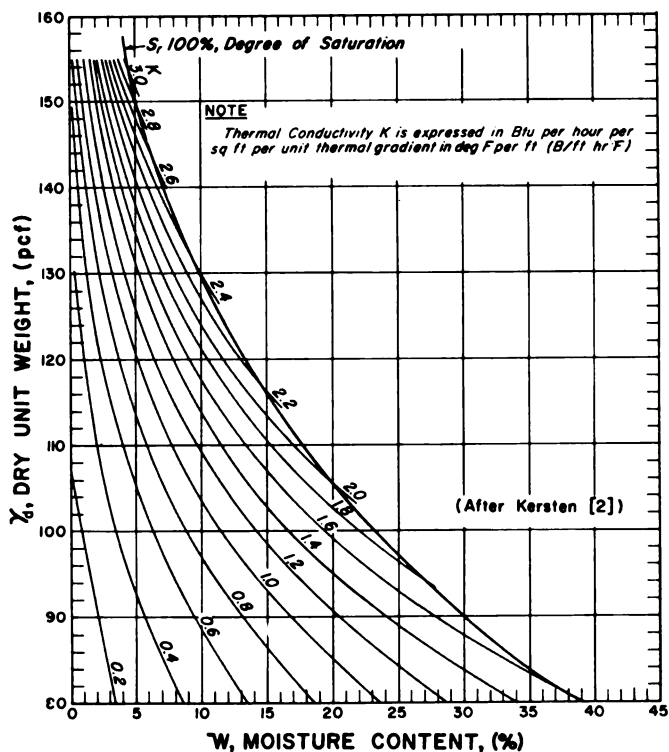

Fig. 1. Dry unit weight, water content, and coefficient of thermal conductivity. Coarse-grained soils—frozen

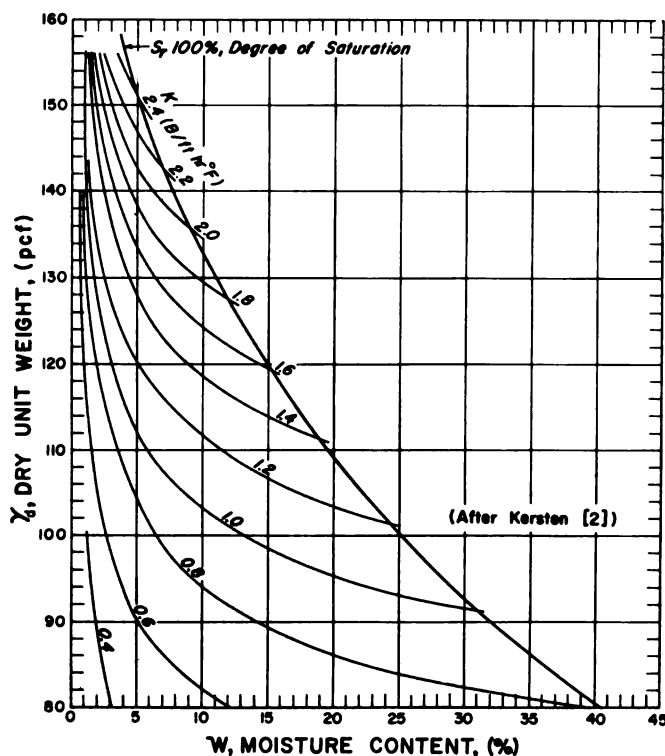

Fig. 2. Dry unit weight, water content, and coefficient of thermal conductivity. Coarse-grained soils—unfrozen

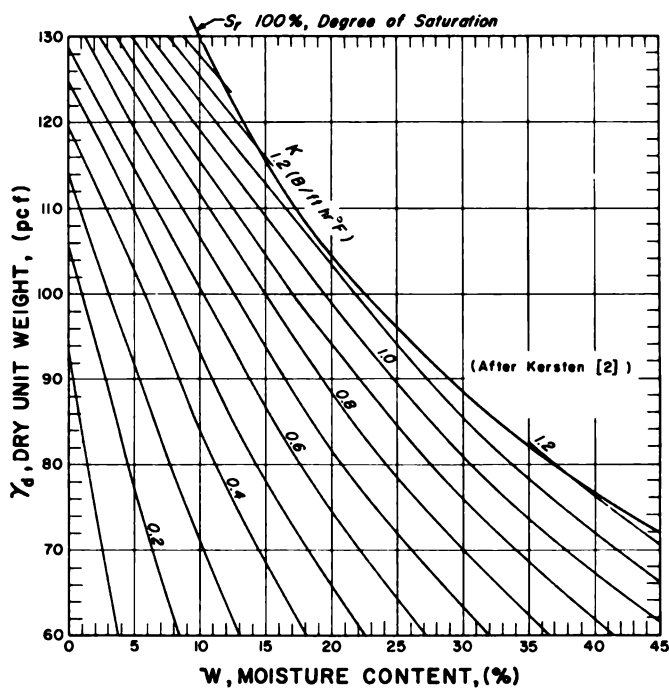

Fig. 3. Dry unit weight, water content, and coefficient of thermal conductivity. Fine-grained soils—frozen

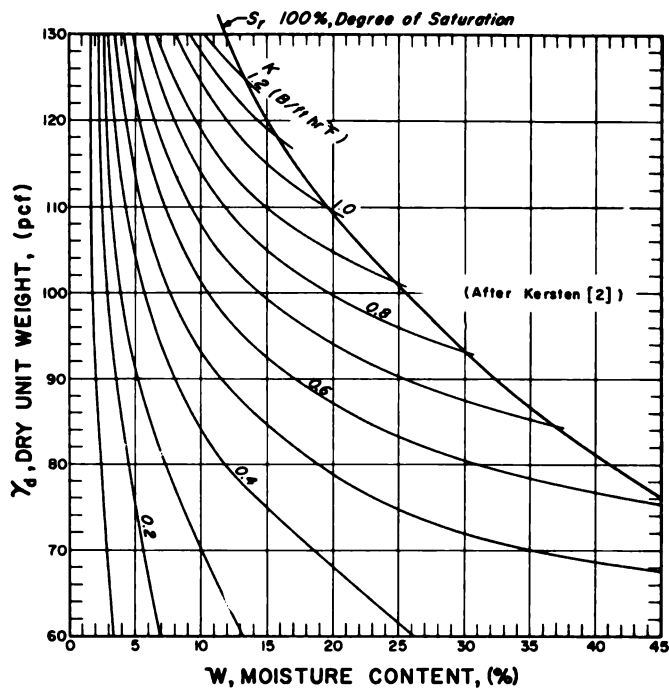

Fig. 4. Dry unit weight, water content, and coefficient of thermal conductivity. Fine-grained soils—unfrozen

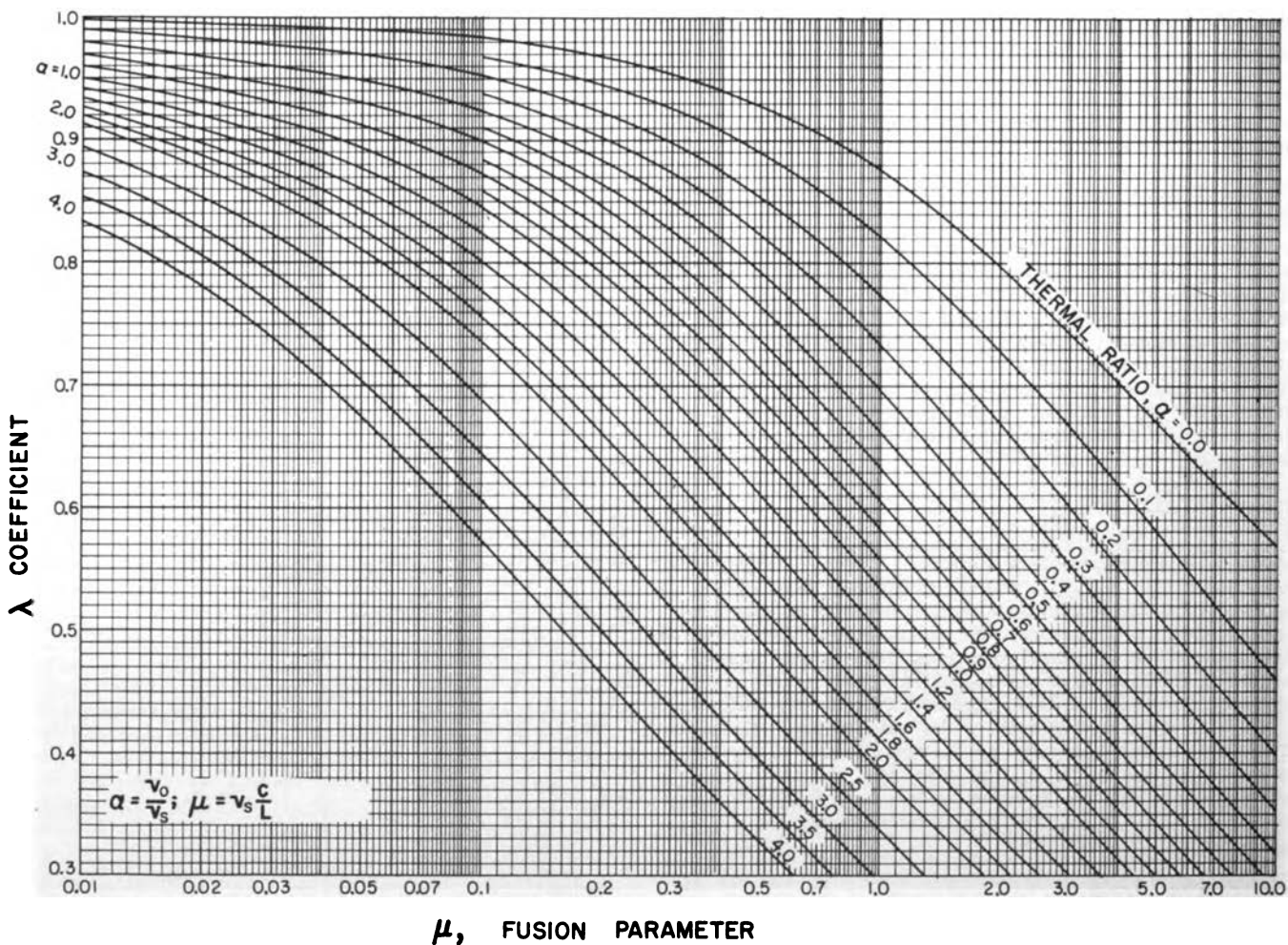

Fig. 5. Lambda coefficient with soil and temperature parameters

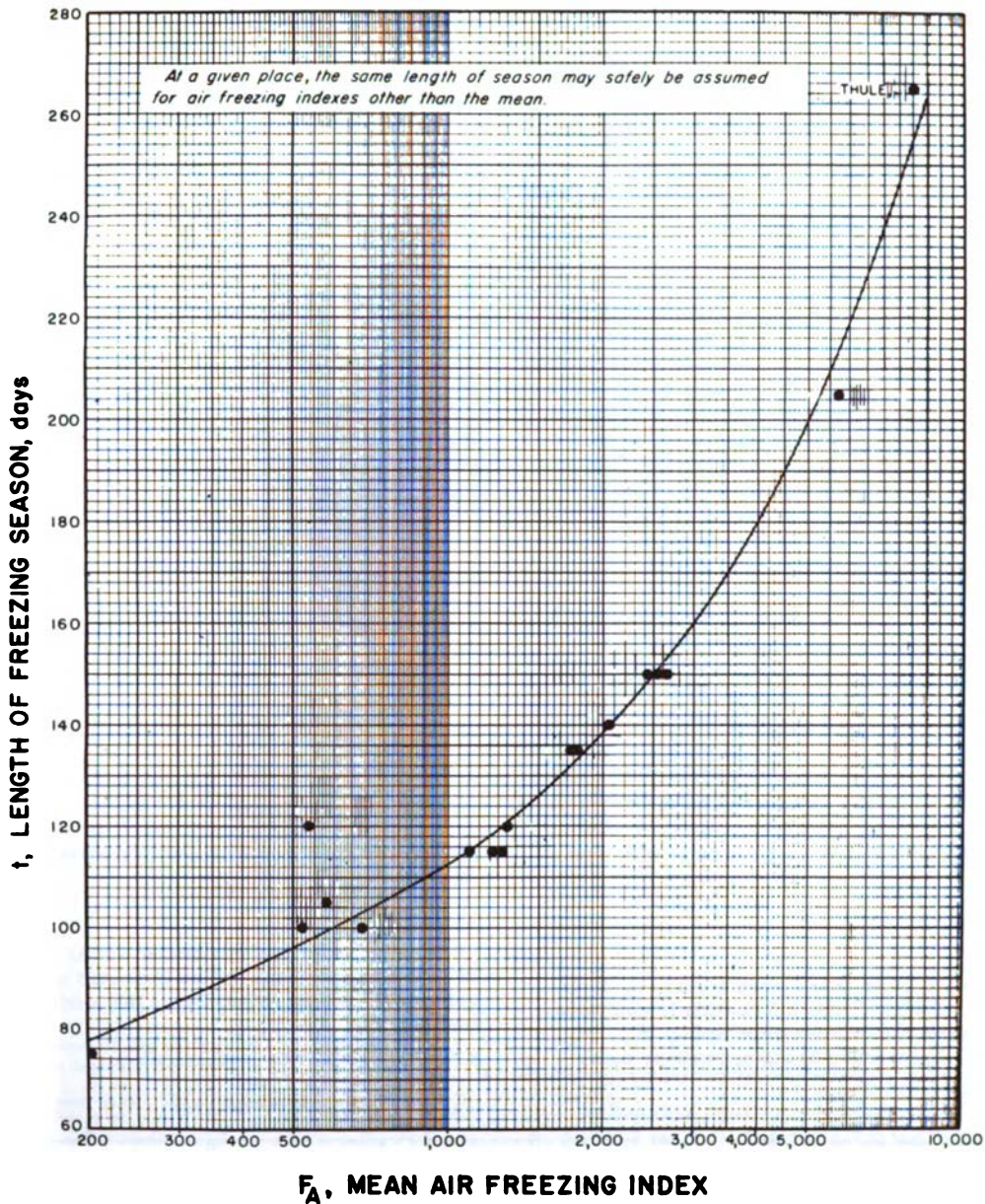

Fig. 6. Air freezing index and length of freezing season

$$L = \gamma_d \frac{1}{100} L_s \tag{4}$$

For most computations all the water can be assumed to freeze at 32°F—since tests, designs and analyses of field data have been based on this assumption. Not enough is yet known to allow for the phenomena of unfrozen water in soil at a temperature below the normal equilibrium value.

Then

$$C_f = \gamma_d \left(c_s + \frac{0.5w}{100} \right) \tag{5}$$

$$L = \gamma_d \frac{w}{100} L_s \tag{6}$$

K values are normally derived from Kersten's curves [3], although sometimes it is preferable to test the particular material.

Converting the parameters to consistent English units for soils,

$$X = \lambda \sqrt{\left(\frac{48KI}{L} \right)} \tag{7}$$

X in ft; K in Btu/ft hr °F ($K = (K_u + K_f)/2$ is adequate for most purposes); (I) in Fahrenheit degree days; L in Btu/cft; λ dimensionless, usually between 0.5 and 1.0, depending upon water content of the soil and local conditions.

Coefficient of Thermal Conductivity (K)

Soils are conveniently divided into three groups for computing K: Coarse grained (i.e., high in quartz); fine grained (low in quartz and high in other minerals), and highly organic soils. K depends also on dry unit weight, water content, and ice content. The curves used are based on laboratory tests of soils and are labeled "unfrozen" and "frozen". The amount of unfrozen water in frozen soil is immaterial if test temperatures approximate those in the problem (at much lower temperatures, only results of laboratory or field tests at proper temperatures are valid).

In the USSR, soils are similarly grouped, and tabulated values of K [4] check quite well with those used by CRREL. Figs. 1 to 4 have been drawn from [3] for convenience in computations (Tables A. I, Physical properties of sandy soils, and A. II, Physical properties of clayey soils, appear as an appendix to this paper).

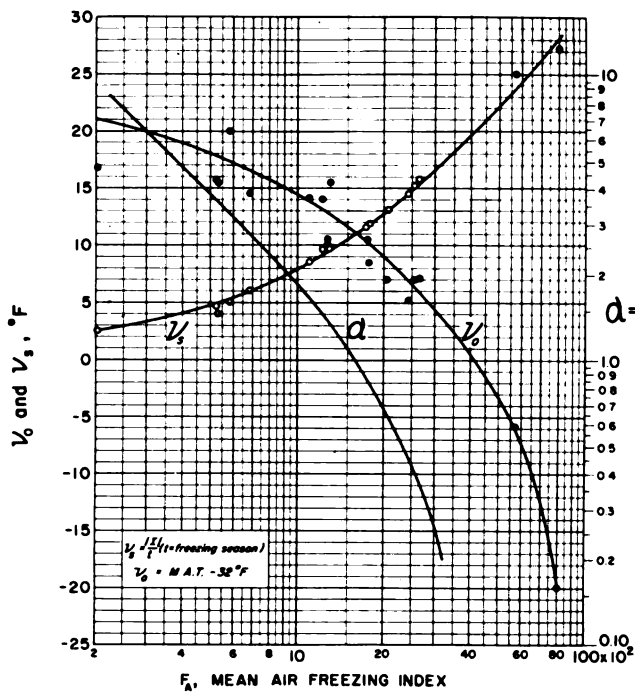

Fig. 7. Air freezing index and temperature parameters

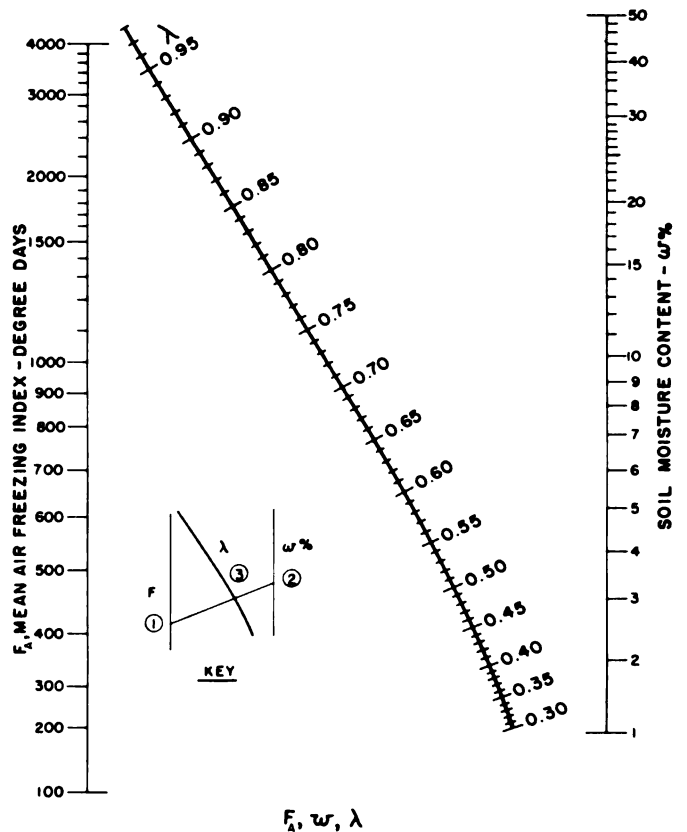

Fig. 8. Air freezing index, water content of soil, and lambda coefficient

The coefficient λ is used in computations dealing with the 32°F isotherm in ground. Curves of λ , extending slightly from the original of [2], are given for completeness (Fig. 5). Note that

$$\alpha = \frac{v_o}{v_s} \text{ and } \mu = v_s \frac{C}{L}$$

Based on ACFEL and other data I made a study of λ to simplify computations where little information is available. Figs. 6, 7, and 8 show the relationships among v_o , v_s , v_o/v_s , I , λ , and soil properties based upon these data.

Frost diffusivity is designated as M . The group $(48K/L)^{1/2}$ is a soil property that can be computed and graphed. The units of M are sq ft/deg day. The Modified Berggren equation becomes

$$X = \lambda M \sqrt{I} \tag{8}$$

NOTES

The index curves depend upon soil and weather conditions and are based on data from Northern States (ACFEL).
 Curves of soil properties were made with the aid of Kersten's Curves of thermal conductivity.
 The Modified Berggren Equation (Aldrich and Paynter) was used.

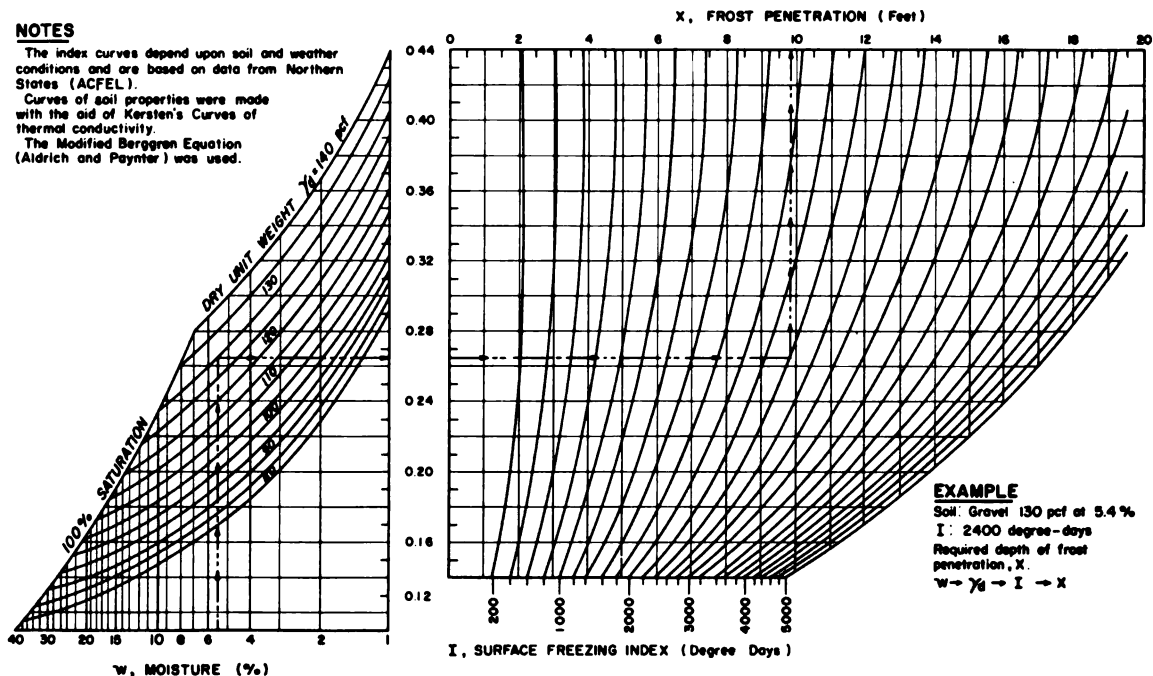

Fig. 9. Penetration of 32°F isotherm from soil properties and surface index — coarse-grained soils, freezing

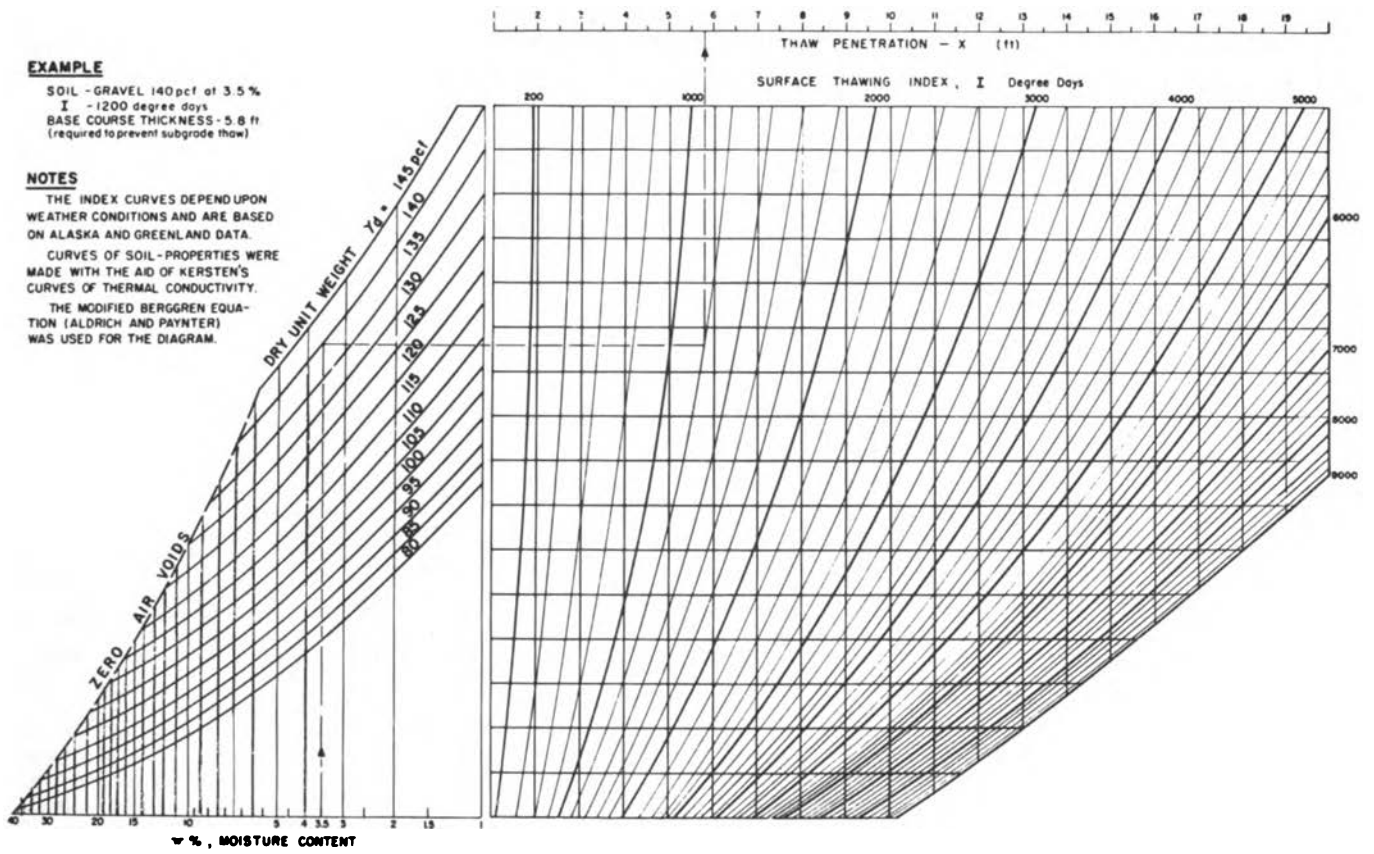

Fig. 10. Penetration of 32°F isotherm from soil properties and surface index — coarse-grained soils, thawing

NOTES:

The index curves depend upon soil and weather conditions and are based on data from Northern States.
 Curves of soil properties were made with the aid of Kersten's Curves of thermal conductivity.
 The Modified Berggren Equation (Aldrich and Paynter) was also used.

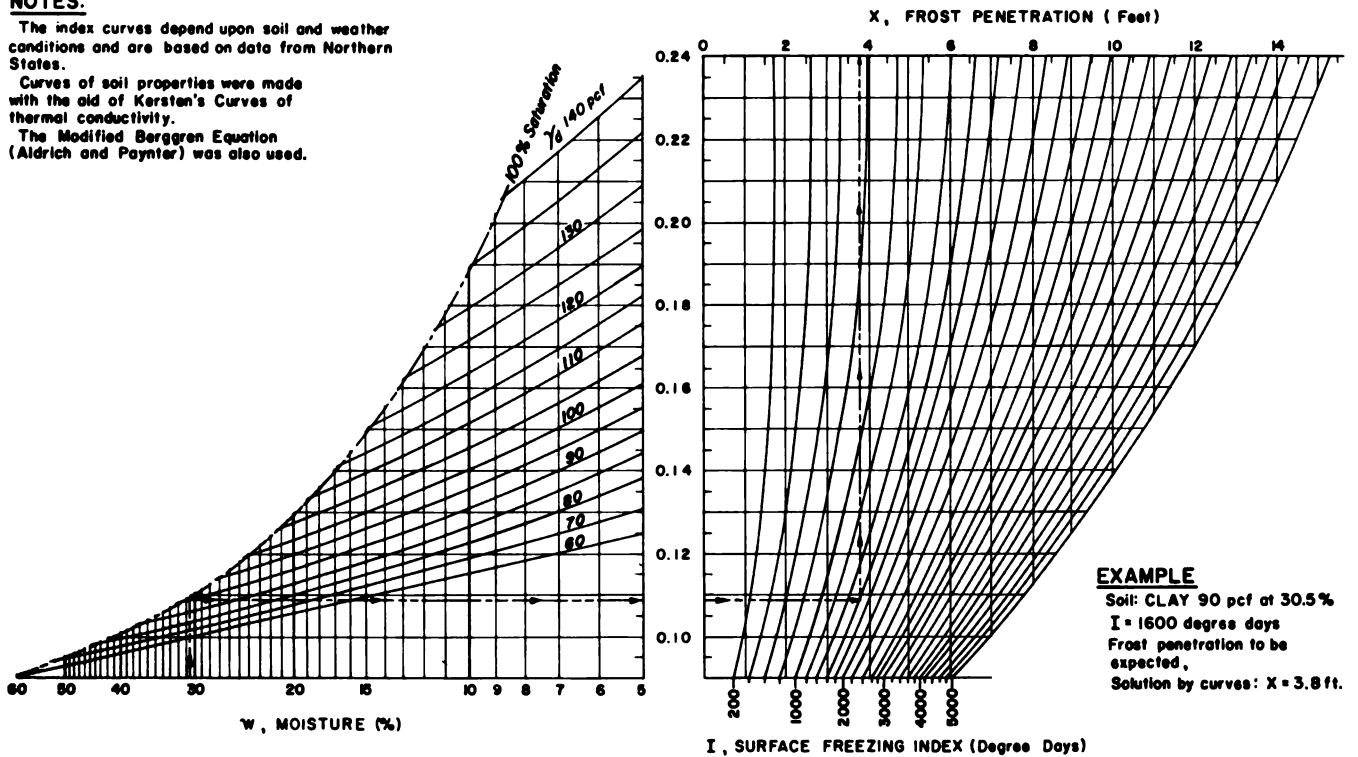

Fig. 11. Penetration of 32°F isotherm from soil properties and surface index — fine-grained soils, freezing

NOTES:

The index curves depend upon soil and weather conditions and are based on data from Arctic and Sub-Arctic Regions.
 Curves of soil properties were made with the aid of Kersten's Curves of thermal conductivity.
 The Modified Berggren Equation (Aldrich and Paynter) was also used.

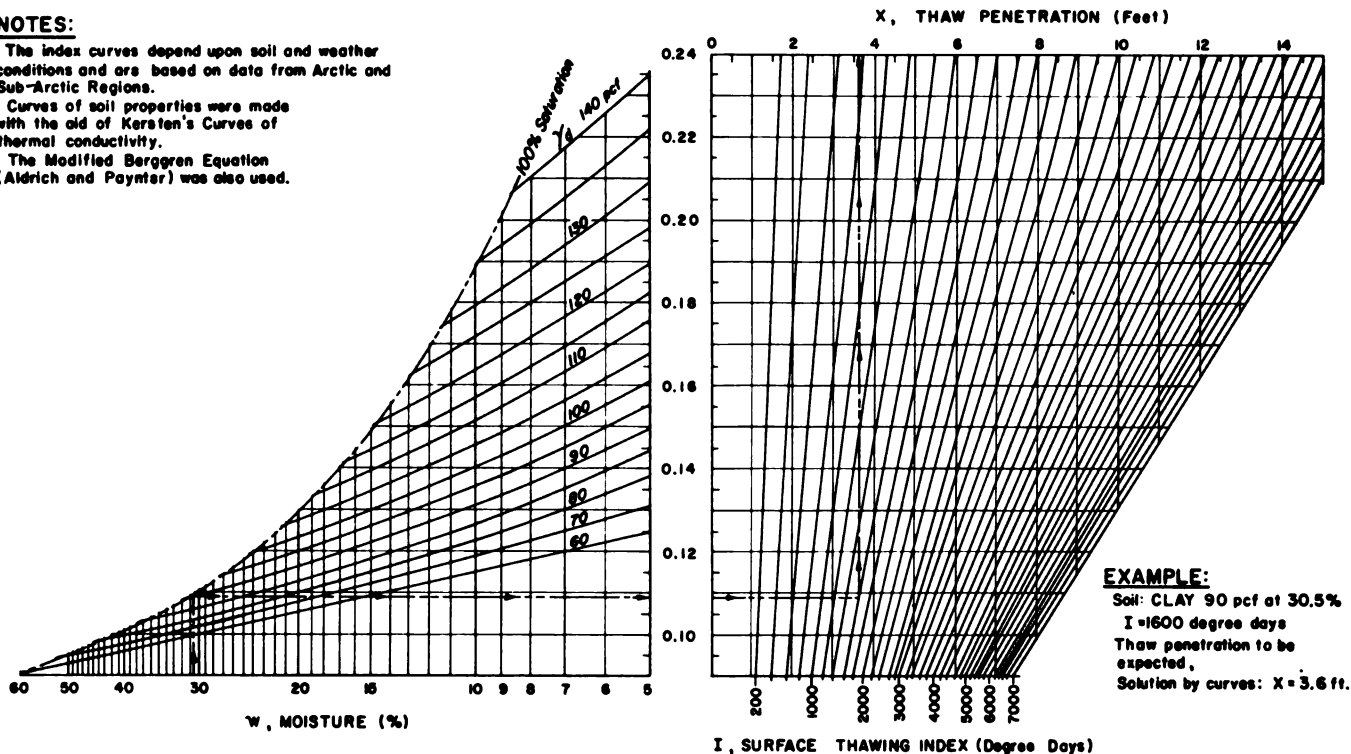

Fig. 12. Penetration of 32°F isotherm from soil properties and surface index —fine-grained soils, thawing

A combination of the ideas just discussed resulted in the construction of graphs (Figs. 9 to 12) that gave penetration X from soil properties and Surface Index (I). M values may be read from the vertical scale.

A complex problem for layered systems can be satisfactorily solved thus:

$$X = \lambda \sqrt{\frac{48KI}{L}}$$

$$X^2 = \frac{\lambda^2 48KI}{L}$$

$$(2X)(\Delta X) = \frac{\lambda^2 48K \Delta I}{L}$$

$$\Delta I = \frac{L \Delta X}{24\lambda^2} \frac{X}{K}$$

and X/K is the thermal resistance of depth X, R_x

$$\text{Therefore } \Delta I = \frac{L \Delta X}{24\lambda^2} R_x \tag{9}$$

ΔI are the degree days required at the surface to move the (T_0) isotherm through layer ΔX .

In computations, R_x is taken to the midpoint of the layer; the value of λ is based on average values of C and L, weighted for layer thickness, and (9) becomes

$$I_n = \frac{L d_n}{24\lambda^2} \left(\Sigma R + \frac{R_n}{2} \right) \tag{10}$$

where ΣR is the thermal resistance of the layers above layer "n". This extension leads to the simple solution of a complex engineering problem.

Example: Boring log from a taxiway at Thule Air Base is given (Table I). The mean annual temperature is 12°F, surface thawing index (I) is 1560 degree days, and length of thawing season is 105 days. The problem is to estimate the depth of thaw expected. The solution is presented in Table II.

Table I. Problem from Thule Air Base, Greenland

Depth (ft)	Material	Ice ^a Condi- tion	Dry unit wt (lb/ cu ft)	Water content %	Layers for com- putation
0	Asphaltic Concrete				a
0.4	(AC)				
1	GW - GP	Nb	155	2.4	b
2	GP	Nf	157	1.8	
3	GW	Nb	151	3.2	c
4	GW	Vx - Vc	151	3.2	
5	GP	Vx	152	2.1	
6	SM	Nb	136	6.5	d
7	SM-	Vx	144	4.6	
8	SC		143	4.6	e
9	SM - GM	Vx	140	2.8	

^aCRREL classification system

PAVEMENT DESIGN FOR FROST CONDITIONS

For flexible pavements the 2- to 4-in. thickness of bituminous concrete can usually be ignored, but it can easily be included as a separate layer for greater precision. Rigid pavements from 12 to 30 in. in thickness should be designed, however, as part of a layered system.

The problem is to find the frost, or thaw, penetration through a pavement overlying layers of nonfrost-susceptible materials protecting a frost-susceptible subgrade by limiting the subgrade penetration of the 32°F isotherm to a safe amount.

If P is thickness of pavement, K_p is conductivity of the material, C_p is volumetric heat capacity ($L_p = 0$), and B is penetration into base having parameters K_B , C_B , and L, then

$$\Delta I = \frac{L d_n}{24\lambda^2} \left(\Sigma R + \frac{R_n}{2} \right) = \frac{LB}{24\lambda^2} \left(\frac{P}{K_p} + \frac{1}{2} \frac{B}{K_B} \right)$$

Table II. Solution of a problem of a layered system (asphaltic concrete pavement over base course and subgrade)

$\alpha = 1.34; v_s = 14.9; I = 1560$

No.	Material	d	Σd	γ_d	w	K	C	L	Cd	ΣCd	\bar{C}	Ld	ΣLd	\bar{L}	μ	λ	λ^2	R_n	ΣR	$\Sigma R + R_n$	I_n	ΣI_n
a	AC	0.4	0.4	138	-	0.86	28											0.46			0*	0
b	GW-GP	1.6	2.0	156	2.1	2.1	30	470	48	59	29	751	751	376	1.15	0.46	0.21	0.76	0.46	0.84	125	125
c	GW-GP	3.0	5.0	151	2.8	2.0	30	610	90	149	30	1830	2581	517	0.86	0.51	0.26	1.50	1.22	1.97	579	704
d	SM	1.0	6.0	136	6.5	1.9	30	1270	30	179	30	1270	3851	642	0.70	0.535	0.29	0.52	2.72	2.98	544	1248
e ₁ ⁺	SM-SC	1.0	7.0	144	4.6	2.0	29	955	29	208	30	955	4806	686	0.65	0.55	0.30	0.50	3.24	3.49	464	1712
e ₂ ⁺		0.75	6.75	144	4.6	2.0	29	955	21	200	30	716	4567	678	0.65	0.55	0.30	0.38	3.24	3.43	340	1588
e ₃ ⁺		0.70	6.70															0.35	3.24	3.41	316	1564

$v_o = 32 - 12 = 20$

$v_s = \frac{1560}{105} = 14.9$

$\alpha = v_o/v_s = 1.34$

$I_n = \frac{Ld_n}{24\lambda^2} (\Sigma R + \frac{R_n}{2})$

$I_b = \frac{(470)(1.6)(0.84)}{(24)(0.21)} = 125$

$I_c = \frac{(610)(3.0)(1.97)}{(24)(0.26)} = 579$

$I_d = \frac{(1270)(1.0)(2.98)}{(24)(0.29)} = 544$

$I_{e1} = \frac{(955)(1.0)(3.49)}{(24)(0.30)} = 464$

$I_{e2} = \frac{(955)(0.75)(3.43)}{(24)(0.30)} = 340$

$I_{e3} = \frac{(955)(0.70)(3.41)}{(24)(0.30)} = 316$

Total thaw penetration 6.70 ft.
 (Observed value: 6.5 ft)

*No water in AC; hence negligible deg days required to thaw the pavement.

+Successive trials

and the solution is

$$B = P \frac{K_B}{K_P} \left(-1 + \sqrt{1 + \frac{48I_B \lambda^2 K_P^2}{P^2 L K_B}} \right) \quad (11)$$

I_B now represents the degree days required to freeze or thaw a thickness of base (B); hence B is the base thickness required for full protection from subgrade penetration. I derived this equation and used it to produce design curves for

pavements in frost conditions [1] (Fig. 13). Lambda values were obtained from figures previously described, and the surface index was 90% of the air freezing index, found by a statistical study at ACFEL to suit bare pavements. It was possible to compute the curves of Figs. 14 and 15, which are good approximations of expected frost depths for placing footings or laying pipes. Surface effects in Figs. 14 and 15 were covered empirically from ACFEL field data, mainly in New England.

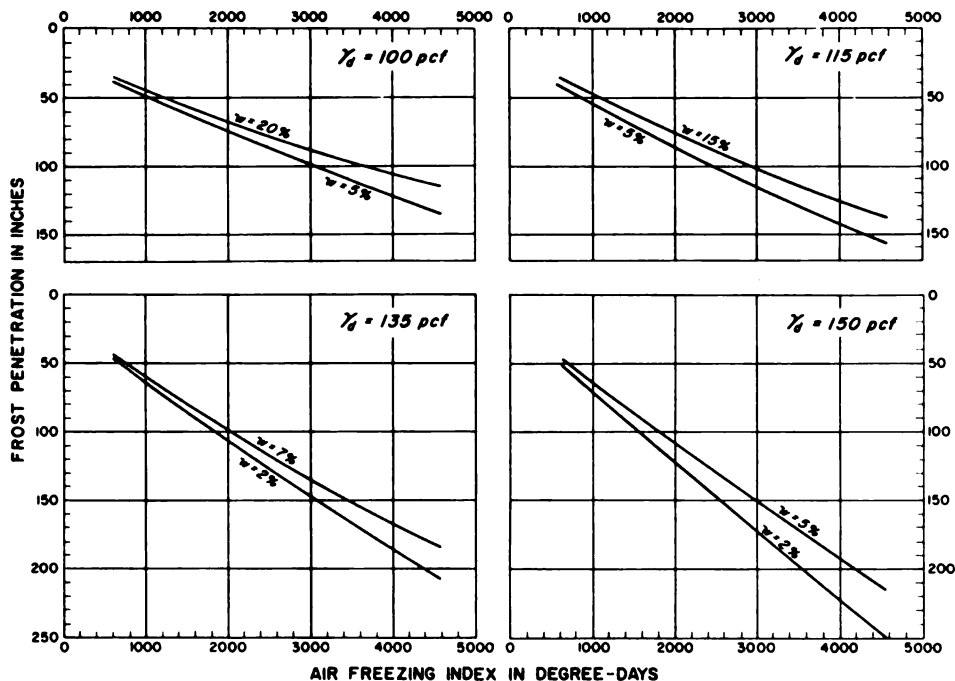

NOTES

1. Frost penetration depths are based on modified Berggren formula and computation procedures outlined in the following technical reports of the Arctic Construction and Frost Effects Laboratory, Corps of Engineers, U. S. ARMY:

- a. TR-42, Analytical Studies of Freezing and Thawing of Soils, First Interim Report, June 1953
- b. TR-67, Frost Penetration in Multilayer Soil Profiles, June 1957.

3. It was assumed in computations that all soil moisture freezes when soil is cooled below 32°F.

2. Frost penetration depths are measured from pavement surface. Depths shown are computed for 12 inch PCC pavements and are good approximations for bituminous pavements over 6 to 9 inches of high quality base. Depths may be computed with the modified Berggren formula for a given locality if necessary data are available

4. γ_d = Dry unit weight
 w = Moisture content in percent based on dry unit weight

Fig. 13. Frost penetration curves for pavement design—nonfrost-susceptible soils beneath pavements kept free from snow and ice. Northern states

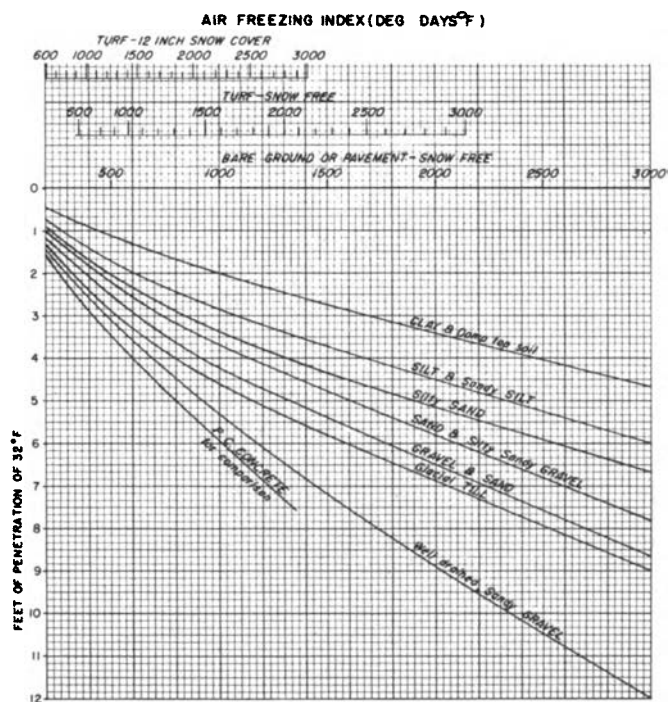

Fig. 14. Frost penetration in uniform soils under various surface conditions

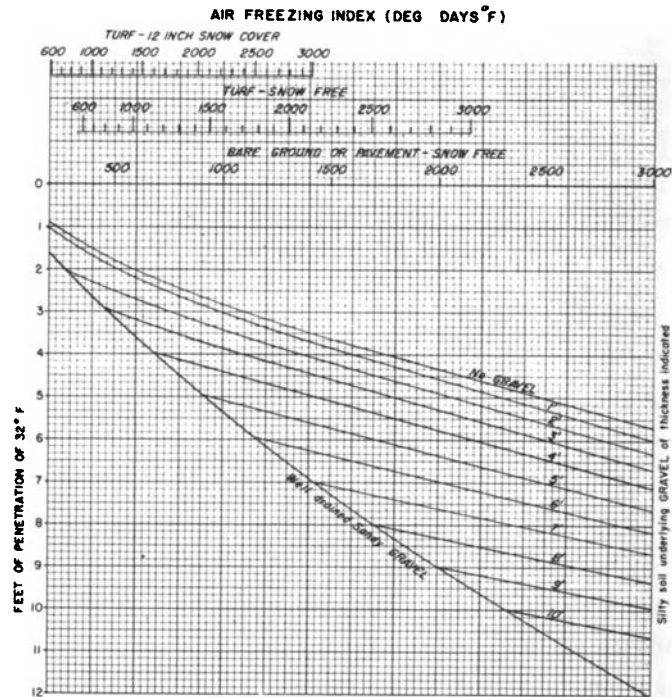
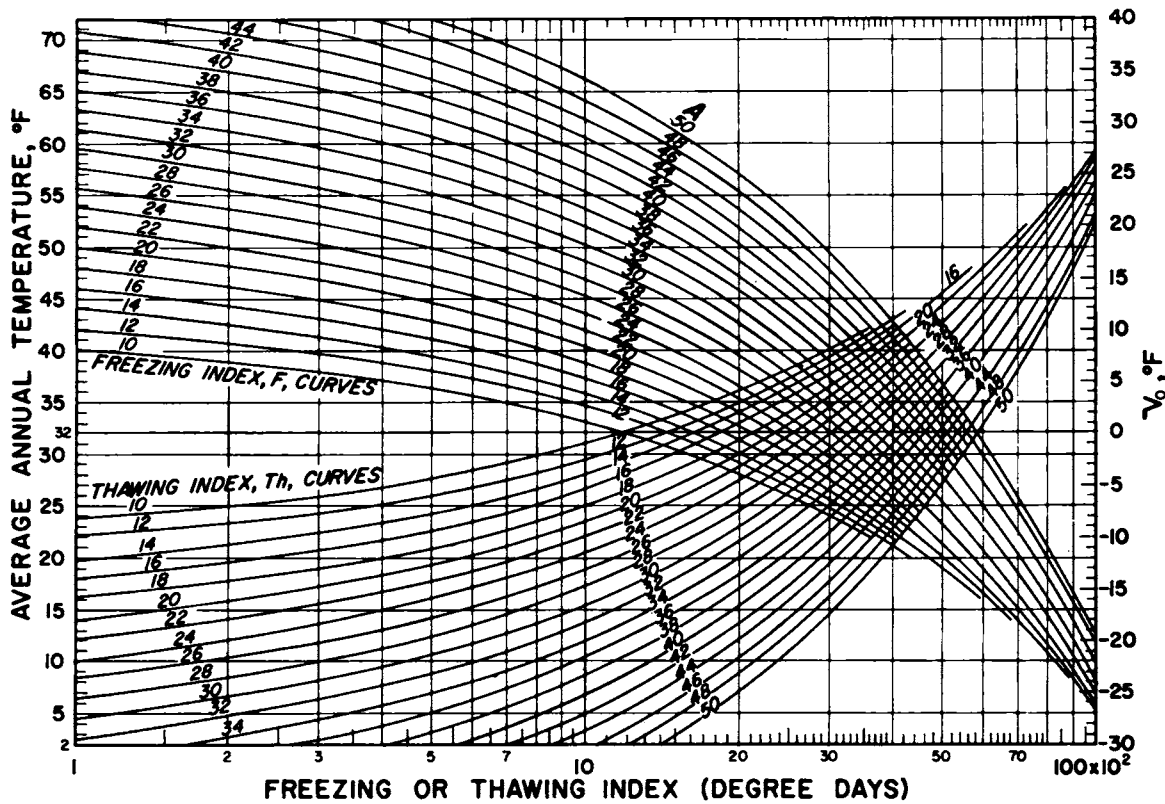

Fig. 15. Frost penetration in layered soils under various surface conditions



$$|F| = \frac{365}{\pi} \left[\sqrt{A^2 - V_0^2} - V_0 \cos^{-1} \frac{V_0}{A} \right]$$

if V_0 is positive, $0 < \frac{V_0}{A} < \frac{\pi}{2}$

if V_0 is negative, $\frac{\pi}{2} < \frac{V_0}{A} < \pi$

$$|Th| - |F| = 365 V_0, \text{ Degree Days}$$

$$t = \frac{365}{\pi} \cdot \cos^{-1} \frac{V_0}{A}, \text{ Length of Freezing Season in Days}$$

V_0 = Average Annual Temperature (M.A.T.) - 32°F
 A, Amplitude of Sine Curve, °F } $\frac{V_0}{A}$ is in radians

Fig. 16. Conversion, degree days and equivalent sine curve of temperature

It is often convenient to convert temperature-time curve and degree days from freezing index to the equivalent mean temperature and amplitude of a sine curve, and vice versa. Fig. 16 was produced for easy and quick conversions.

In order to protect a concrete retaining wall, a nonfrost-susceptible backfill was used. Due to the concrete thickness, I thought it preferable to change the surface freezing index to the equivalent sine curve of temperature by using the conversion curves. The temperature curve for the back of the wall was then found, assuming that concrete and drained NFS fill are sufficiently close thermally to assume an infinite mass with properties of concrete. (This assumption breaks down when very dissimilar materials are in contact).

The temperature curve was converted to the equivalent degree days for application of the Modified Berggren equation in the backfill with its latent heat effect. Fig. 17 is the result [5]: CRREL is now checking these curves by field observations.

Fig. 18 correlates a freezing index at depth with the surface freezing index; it is based on field data only and hence is purely empirical, though rational and useful in pipe calculations.

The principles discussed here may be applied with convenience and accuracy to many problems involving a step-change at a surface, although the most important application so far has been the curves (Fig. 13) for pavement design in frost areas.

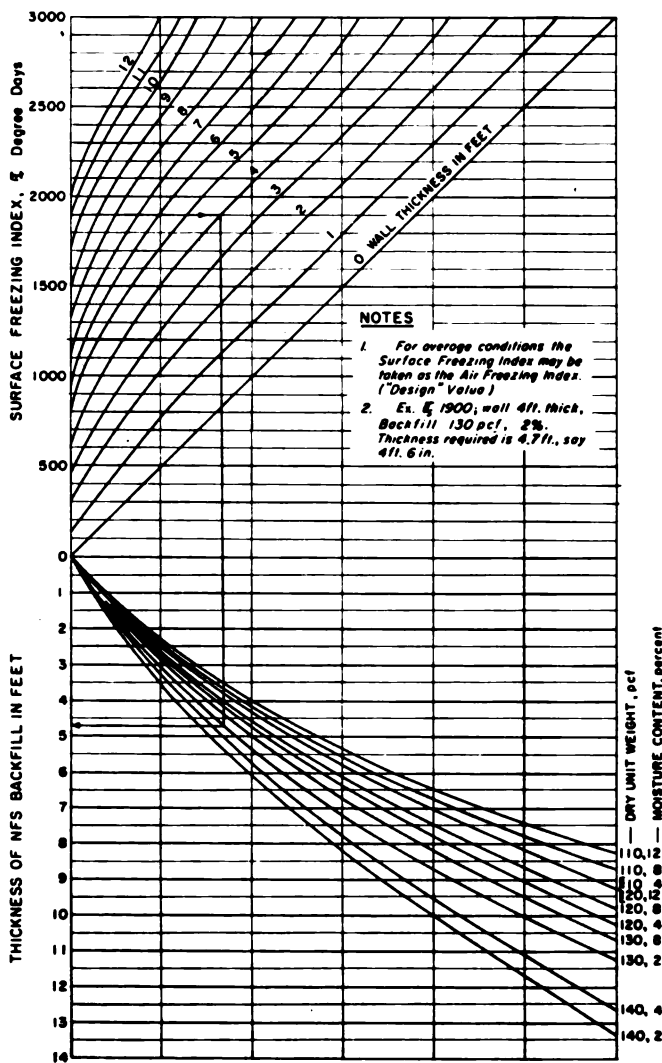
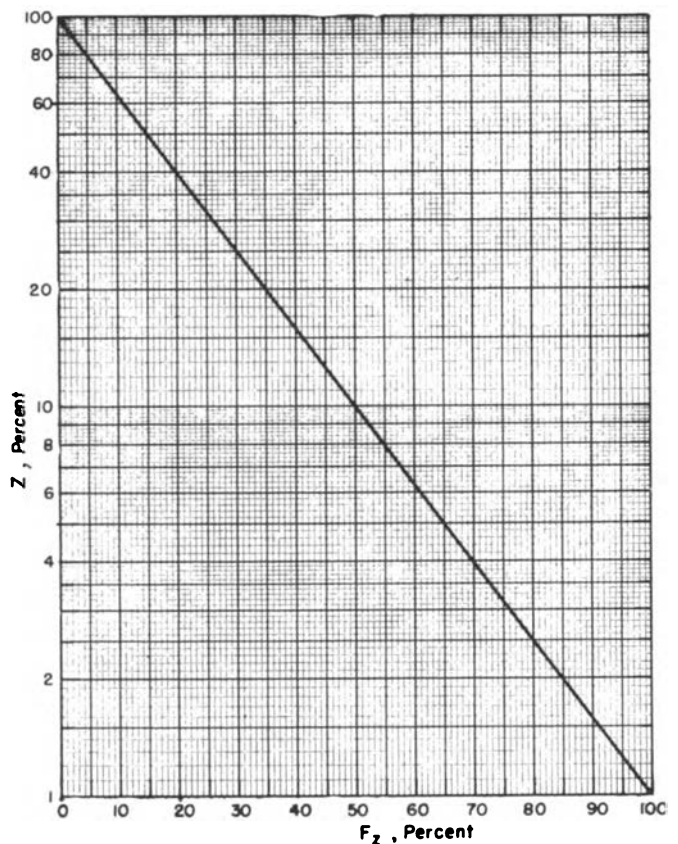

Fig. 17. Concrete retaining walls and nonfrost-susceptible backfills



$$F_z = 100 (1 - \lg Z^{1/2}) \text{ Percent}$$

F_z = FREEZING INDEX AS PERCENT OF SURFACE INDEX
 Z = DEPTH AS PERCENT OF FROST PENETRATION

Fig. 18. Degree days and depth

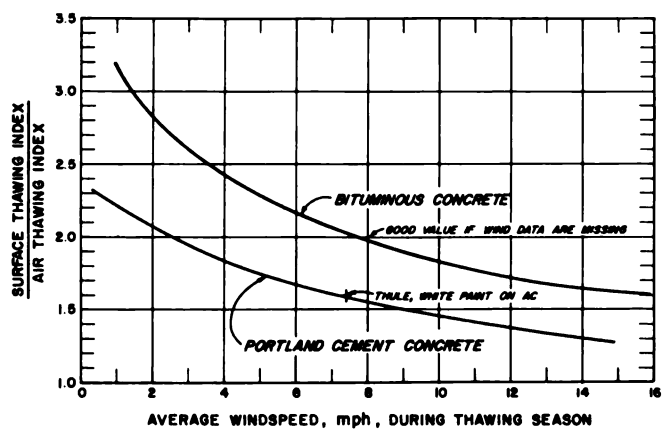

Fig. 19. Surface thawing index and air thawing index for the Arctic and sub-Arctic

AIR AND SURFACE INDEXES

For computations involving natural air temperatures, the degree day concept has the disadvantages of: (a) Not giving time and penetration, only total penetration; and (b) the problem of converting air degree days to surface degree days.

Statistical studies by the ACFEL staff show that for freezing in the northern states, the surface index for bare pavements and smooth soil surfaces kept free from snow is 90% of the air freezing index. For other surfaces, Figs. 14 and 15 may be used to convert index values.

Thawing in permafrost areas is not so simple. Fig. 19 shows how wind has a great effect on the indexes. The curves are approximate since wind, though most important, is only one of several factors. I based them on work for ACFEL by G. Leung, modified by field data from Alaska and northern Greenland.

The relationship between the air and surface indexes is quite complex, and for more precise work it probably would be better to use techniques now being developed for CRREL by R. F. Scott. His technique is based on heat flux principles, not degree days.

ACKNOWLEDGMENTS

These simple design methods were based on theory and a substantial amount of field data compiled by the ACFEL staff under Kenneth A. Linell.

REFERENCES

- [1] U.S. Army Corps of Engineers. "Pavement Design for Frost Conditions," *Eng. Manual 1110-1-306*, App. 1, 1962.
- [2] M. P. Aldrich, H. M. Paynter. "Analytical Studies of Freezing and Thawing of Soils," *ACFEL Tech. Rept. 42*, CRREL, 1953.
- [3] M. S. Kersten. "The Thermal Properties of Soils," *Bull. 28*, Eng. Experimental Station, Univ. Minn., 1949.
- [4] "Technical Considerations in Designing Foundations in Permafrost," *S.N. 91-60*, USSR, Transl. by V. N. Pavloff, *Tech. Trans. 1033*, NRC, Ottawa, Canada, 1962.
- [5] U.S. Army Corps of Engineers. "Procedures for Foundation Design of Buildings and Other Structures (Except Hydraulic Structures)," Section on Design of Foundations in Areas of Deep Frost Penetration, *Eng. Manual 1110-345-147*, 1961.

APPENDIX TABLES

Table A-I. Physical properties of sandy soils

Physical Characteristics					Thermophysical Coefficients			
Unit Wt (lb/cu ft)		Water or Ice (%)		Saturation (%)	Thermal conductivity (Btu/ft hr °F)		Specific Heat (Btu/cu ft °F)	
Soil γ	Dry γ _d	Wt	Vol	S _r	Thawed K _u	Frozen K _f	Thawed C _u	Frozen C _f
69	67	2	2	3	0.18	0.19	12.5	11.9
69	66	4	4	7	0.25	0.28	13.7	12.5
69	62	8	8	15	0.34	0.41	16.2	13.7
75	74	2	2	4	0.23	0.25	13.7	13.1
75	72	4	5	10	0.31	1.36	15.6	13.7
75	69	8	9	20	0.41	0.51	18.1	15.0
81	79	2	3	6	0.28	0.32	15.6	14.4
81	78	4	5	10	0.36	0.43	16.8	15.0
81	75	8	10	20	0.48	0.60	20.0	16.2
81	69	16	18	30	0.51	0.70	25.0	18.1
87	85	2	3	6	0.35	0.40	16.8	15.6
87	84	4	5	10	0.44	0.51	18.7	16.2
87	81	8	10	25	0.51	0.71	21.8	17.5
87	75	15	18	35	0.59	0.82	26.2	18.7
87	75	20	24	45	0.63	0.89	29.3	20.0
94	92	2	3	7	0.42	0.48	18.1	16.9
94	90	4	6	15	0.51	0.60	20.6	17.5
94	87	8	11	25	0.64	0.82	24.3	19.4
94	81	15	20	40	0.69	0.97	28.1	20.6
94	78	20	26	50	0.72	1.04	31.2	21.9
100	98	2	3	8	0.38	0.56	19.3	18.1
100	97	4	6	15	0.59	0.71	21.8	18.7
100	94	8	12	30	0.73	0.94	26.9	20.0
100	87	15	22	45	0.78	1.12	30.6	21.8
100	84	20	27	55	0.83	1.19	33.1	22.0
100	81	25	33	65	0.86	1.28	36.2	23.2
106	100	8	13	35	0.83	1.09	28.1	20.8
106	94	15	23	50	0.90	1.29	32.4	22.0
106	87	20	28	60	0.94	1.38	34.9	23.8
106	84	25	34	70	0.98	1.48	32.2	25.0
112	100	15	24	60	1.03	1.49	33.7	23.2
112	94	20	30	70	1.08	1.59	36.8	25.0
112	90	25	36	80	1.12	1.70	40.0	25.5
119	103	15	25	65	1.16	1.71	35.6	24.4
119	100	20	32	80	1.21	1.82	38.7	25.5
119	94	25	38	85	1.25	1.92	41.8	27.3
125	109	15	26	75	1.29	1.95	36.8	25.5
125	106	20	34	95	1.35	2.06	40.6	27.3
125	103	25	40	100	1.38	2.12	44.3	28.5
131	116	15	28	90	1.45	2.19	39.3	26.7
131	109	20	36	100	1.48	2.28	42.4	28.5
131	106	25	42	100	1.50	2.31	46.2	29.7

Table A-II. Physical properties of clayey soils

Physical Characteristics					Thermophysical Coefficients			
Unit Wt (lb/cu ft)		Water or Ice (%)		Saturation (%)	Thermal conductivity (Btu/ft hr °F)		Specific Heat (Btu/cu ft °F)	
Soil γ	Dry γ _d	Wt	Vol	S _r	Thawed K _u	Frozen K _f	Thawed C _u	Frozen C _f
69	62	8	8	15	0.23	0.27	17.5	15.0
75	69	8	9	15	0.28	0.34	20.0	16.2
81	75	8	10	20	0.34	0.40	21.9	18.1
81	69	18	20	35	0.40	0.50	28.7	20.6
87	81	8	10	20	0.42	0.49	23.7	19.4
87	75	18	22	40	0.49	0.62	30.6	22.5
87	69	27	30	50	0.54	0.73	33.7	23.7
94	87	8	11	25	0.49	0.59	26.2	21.2
94	75	18	23	45	0.57	0.73	32.5	23.7
94	75	27	32	55	0.62	0.86	35.6	25.0
94	69	40	44	75	0.68	0.96	42.5	27.5
100	94	8	12	25	0.58	0.59	28.7	22.5
100	84	18	25	50	0.66	0.86	34.3	25.0
100	78	27	34	65	0.71	0.99	38.7	26.2
100	72	40	46	80	0.77	1.09	44.9	28.7
106	100	8	13	30	0.65	0.80	31.2	24.4
106	90	18	26	55	0.75	0.97	36.2	26.2
106	84	27	36	70	0.81	1.13	41.2	28.1
106	75	40	48	85	0.87	1.23	46.8	30.6
112	94	18	27	60	0.84	1.11	38.1	28.1
112	87	27	38	80	0.90	1.27	43.1	29.3
112	81	40	52	100	0.96	1.36	49.9	32.5
119	100	18	29	70	0.95	1.26	40.0	30.0
119	94	27	41	90	1.01	1.43	45.6	31.2
119	84	40	54	100	1.06	1.51	52.4	34.3
125	106	18	31	85	1.07	1.44	41.8	31.2
125	100	27	43	100	1.11	1.59	48.0	34.3
125	90	40	58	100	1.15	1.64	55.0	36.2
131	100	18	32	90	1.20	1.61	43.0	31.2
131	103	27	54	100	1.23	1.75	50.6	34.3
131	94	40	60	100	1.24	1.77	57.4	37.5

^aValues of the coefficients (K_f) and (C_f) are given for a temperature of 14°F. Values of (K_u) and (C_u) for frozen clayey soils in the interval from 21° to 14°F are computed as the mean of the values of (K_f) and (k_u) and (C_f) and (C_u), taking into account the unfrozen water content

FACTORS AFFECTING FREEZE OR THAW DEPTH IN SOILS

R. F. SCOTT, California Institute of Technology

Under contract with the U. S. Army Cold Regions Research and Engineering Laboratory (CRREL), Hanover, New Hampshire, a method was developed which attempts to predict freeze or thaw depth in any soil under any conditions as a function of time. The technique can also be used to investigate the effect of different factors on heat flow into the soil and on thaw or freeze depth. Results of a study of various appropriate factors and their relative effects on the freezing or thawing process are presented. Although the method is reported elsewhere, a brief summary of the calculations is presented here.

In Neumann's solution to the problem of calculating thaw or freeze depth in a semi-infinite material as a result of a sudden step-change of temperature from below or above the melting point of the solid to above or below the melting point [1], the thaw or freeze depth is linearly proportional to the cumulative flux of heat through the surface of the medium, both quantities being functions of time. The constant of proportionality of thaw or freeze depth is determined by the familiar transcendental equation in the Neumann solution and is dependent both on temperature conditions and on soil thermal characteristics. Heat flux is accumulated from the time the surface passes through the freezing or melting point of soil moisture. Neumann's solution assumes the temperature to be initially uniform throughout the homogeneous medium.

On examining the results of a field study in which heat flux near the ground surface and thaw depth in the soil were both measured [2], a comparison of thaw depth with cumulative heat flux through the soil surface revealed a substantially linear relationship. Similar comparisons were made for two other regions studied and a more or less linear relationship existed for a layered soil [3, 4, 5]. The relationship was promising enough to warrant comparison of actual thaw and freeze depths at various sites with those obtained from calculation of cumulative heat flux through the surface and calculated linear relations between depth and the heat flux. This was carried out in two subsequent contracts [6, 7] for the Corps of Engineers and results were obtained which are believed to be sufficiently reliable for many engineering purposes.

The technique comprises the following steps with each quantity being determined over a suitable time increment:

- (a) Short-wave radiational heat flux reaching the ground surface is determined.
- (b) Albedo or absorptivity of ground surface is used to give short-wave radiation actually received by ground surface.
- (c) Long-wave outgoing radiational flux is calculated.
- (d) Approximate evaporational heat flux from ground surface is estimated.
- (e) Surface heat transfer coefficient is calculated from wind velocity, surface roughness, and atmospheric stability conditions.
- (f) Radiation temperature is computed by dividing net heat flux received by ground surface by surface transfer coefficient.
- (g) Radiation temperature is added to mean air temperature over incremental period to get equivalent temperature.
- (h) Numerical integration of the convolution integral using the equivalent temperature and a system function to obtain both cumulative heat flux through ground surface temperature as a function of time.
- (i) Surface temperature is used to determine day that the surface passed through melting or freezing point of the soil and the heat flux is revised to accumulate from that day.
- (j) Constant is computed relating thaw or freeze depth to cumulative heat flux in each soil layer, using Neumann's step-change surface temperature solution with appropriate temperature conditions.

- (k) Thaw or freeze depth is calculated as a function of time, using constants from (j) and revised cumulative heat flux.

This method involves most variables that may affect thaw or freeze depth. So long as the basic assumption of the method gives rise to reasonably correct results in practice, the technique can be used to determine the effects of variation of the different parameters on thaw or freeze depth in typical situations.

Since the relationship of cumulative heat flux to a change in any parameter is of particular interest (because it is not expressed in a closed-form mathematical relation), most space is devoted to the study of heat flux into the soil. The constant relating thaw or freeze depth to cumulative heat flux can be determined mathematically from Neumann's solution from which the effect of varying certain soil thermal parameters can be calculated.

Convolution integral solutions were obtained both by hand and by computer; different time increments were also used in different studies, but they have little significant effect on the analyses.

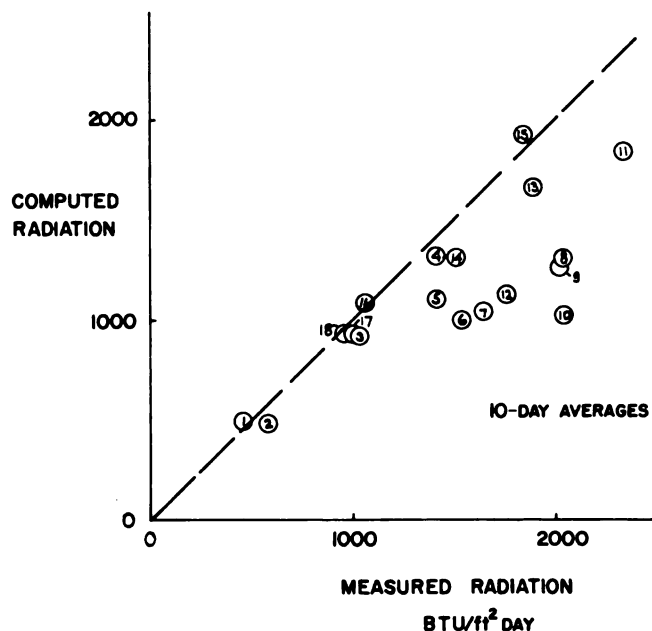

Fig. 1. Computed versus measured radiation, Barrow, Alaska

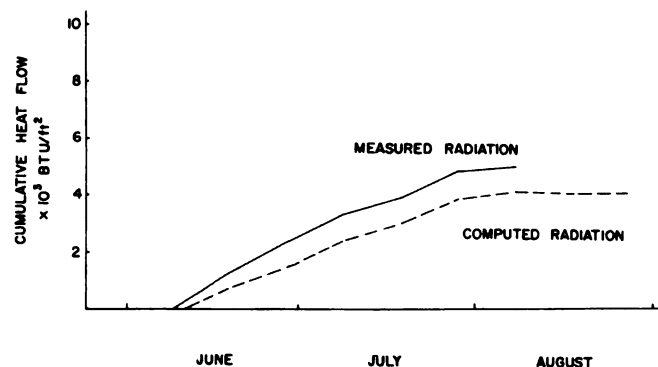

Fig. 2. Natural cover, Barrow (thaw)

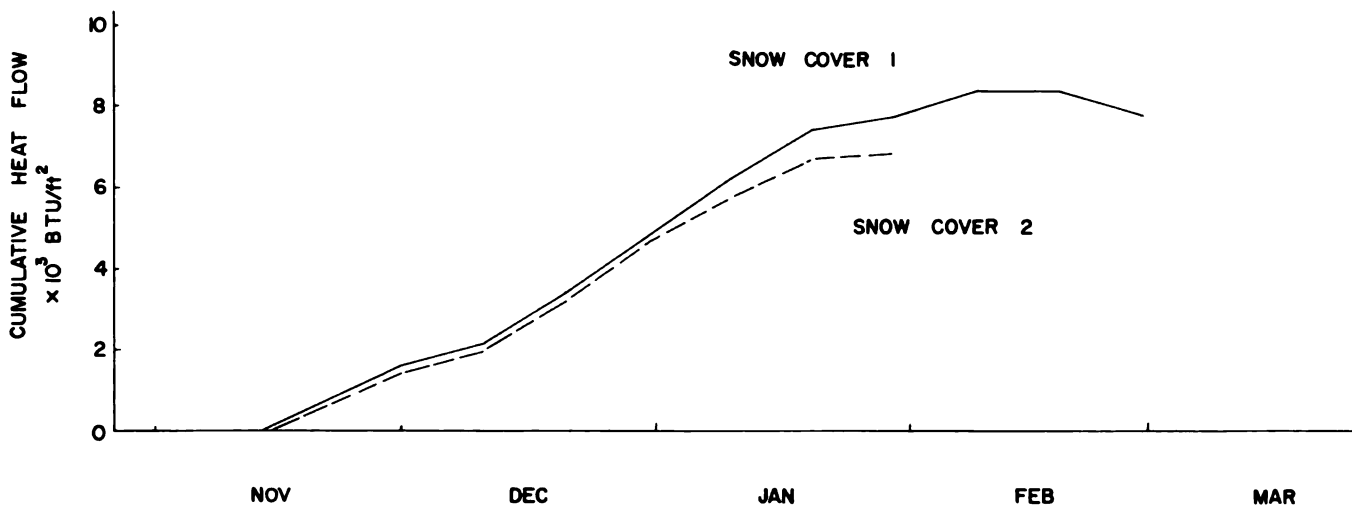

Fig. 3. Airfield pavement, Dow AFB, Maine (freeze)

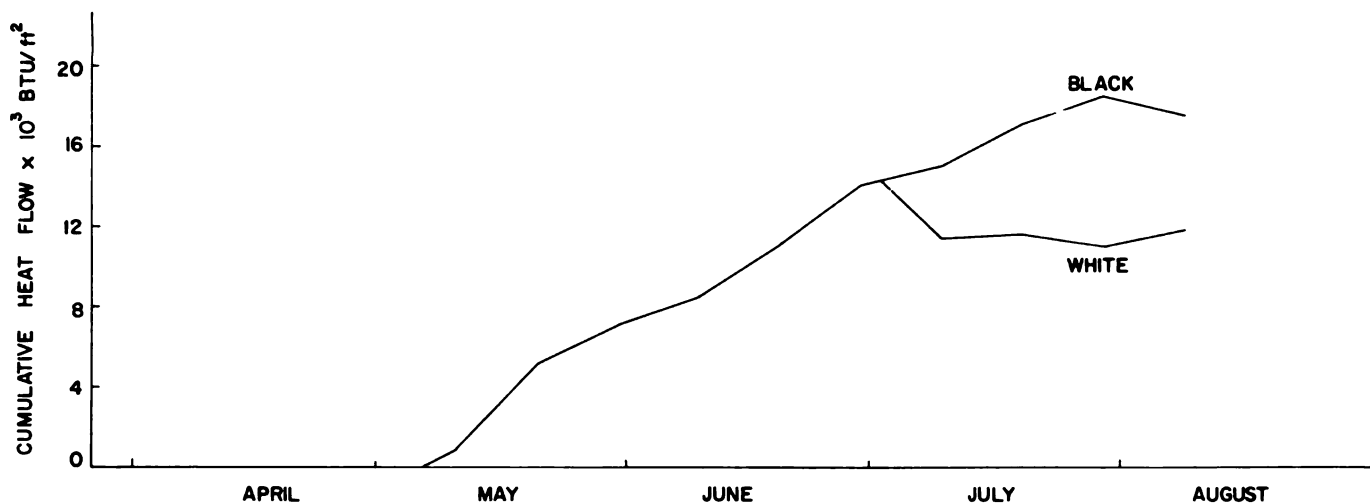

Fig. 4. Airfield pavement, lat. N 76° 33' (thaw)

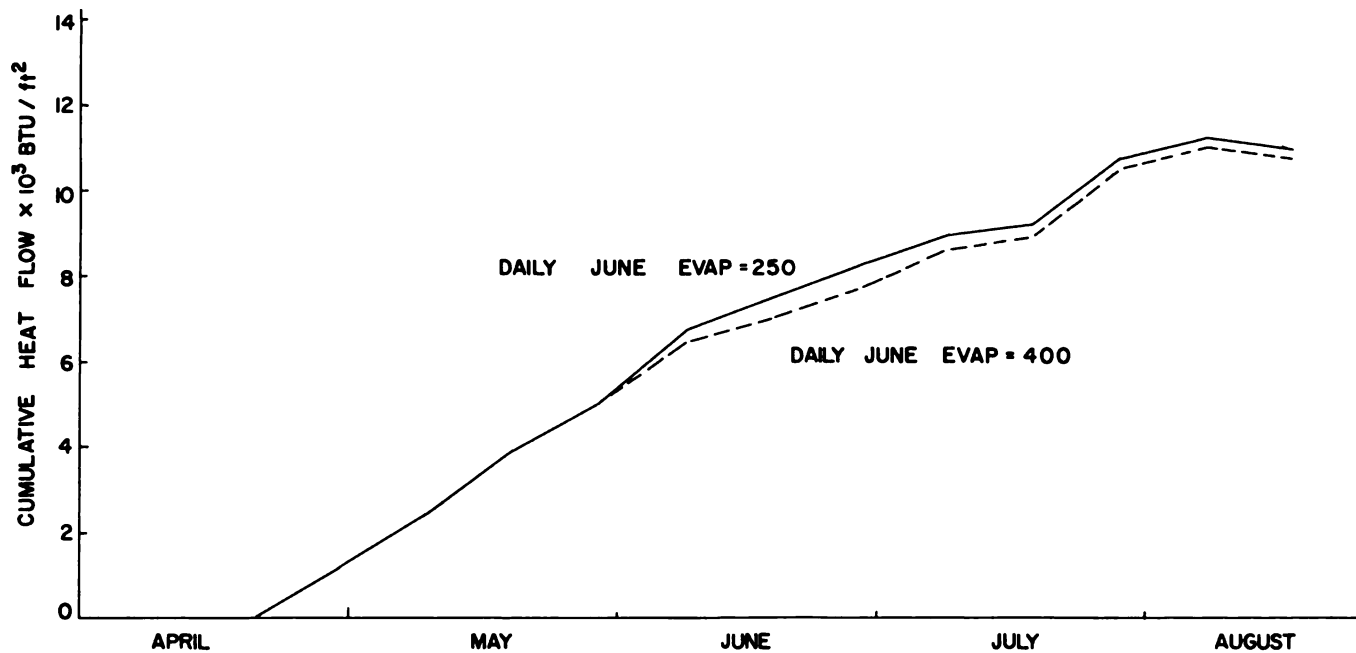

Fig. 5. Natural cover, Northway, Alaska (thaw)

EFFECT OF VARIOUS FACTORS ON HEAT FLOW INTO SOIL

Quantitative dependence of heat flux on a given factor is influenced by the physical parameters associated with a particular site. The results cannot always be generalized.

Incoming Heat Flux

The heat flux used in calculating radiation and equivalent temperatures can vary because of a difference in incoming short-wave radiation assumed, variations in long-wave outgoing radiation, or the heat flux attributed to evaporation, and air temperature. The effect of varying any one of these parameters, as well as cloud cover factors and ground-surface absorptivity, can be studied by changing the amount of heat flux in cumulative heat flow calculations.

At a given site, the measured incoming short-wave radiation is used if available locally or if data can be extrapolated from observations made nearby. However, in many cases the only observation at the site is that of cloud cover or percentage possible sunshine. Incoming short-wave radiation is then estimated from a computed theoretical clear day radiation curve and cloud cover factors based on previous studies [1].

At Barrow, Alaska, the measured amount of short-wave radiation (including cloud cover effects) was substantially different (Fig. 1) from values computed using a theoretical clear day incoming short-wave radiation curve and previous values for cloud cover factor. Two calculations were therefore carried out, one involving computed incoming short-wave radiation, and the other using measured incoming radiation at Barrow. The difference between the two resulting curves (Fig. 2) arises substantially from this reason (a slight effect) also arises from a different consideration of the surface transfer coefficient averaging in the two methods). Cumulative heat flux based on computed incoming short-wave radiation develops much more slowly than that from measured incoming radiation and attains a value approximately 15% smaller. If the actual source of the difference between incoming heat fluxes is disregarded, the difference could then be attributed to differing assumed surface absorptivities or to a change in amount of estimated evaporation. (Note: Figs. 2 through 8. Comparisons of cumulated heat fluxes for specific seasons of record).

Surface Albedo

At Dow, Maine, doubt arose as to the actual time variation of snow cover at a thermocouple assembly, where depth of freeze was to be measured, in contrast to a weather station, where meteorological observations were made. Consequently, two different snow covers were assumed for the calculations; these gave rise to different surface adsorptivities, to different short-wave radiational amounts, and, ultimately, to different incoming heat fluxes. The two curves (Fig. 3) for the same value of mean annual air temperature but different snow covers indicate the effect of different albedos. The result depends on the site and distributions assumed and cannot be assigned a quantitative value.

At one site, lat. N 76° 33' thaw depth was calculated for an airfield surfaced with black top asphalt whose albedo was assumed to be 0.90. Midway through the thawing season an attempt was made to reduce the thaw depth [8] by painting the pavement surface white; the new surface albedo was taken to be 0.40. The effect of this factor on the cumulative heat flux through ground surface is shown in Fig. 4.

Evaporation

Determination of the quantity of evaporation from a natural ground surface is at least as difficult as any other heat flux calculation, but compared with total incoming heat flux, changes in estimated evaporation on the order of 50 to 100% in different increments represent a relatively small perturbation.

A method for computing mean monthly evaporation is employed where both average temperature and amount of precipi-

tation are taken into account. This technique of accounting for evaporation is not extremely accurate, but it apparently gives satisfactory results within the limitations of the method. The results appear to be consistent and are also consistent with a previous observation [1] that on days when ground-surface temperature is higher than air temperature, heat loss due to evaporation is approximately the same as that lost by sensible heat transfer to the air, provided that moisture is available in the soil. The resulting change in amount of evaporation is shown in Fig. 5.

A change in evaporation was studied specifically for an Alaskan site. In one computation a value of 400 Btu/sq ft/day outgoing heat flux, due to evaporation throughout June was used. Results of the original computation indicated that this value might be too high. A second value of 250 was therefore assumed and applied in a subsequent calculation. The results are given in Fig. 5; the difference appears to be relatively small. The effect was most marked in June but diminished considerably by the time the peak cumulative heat flux quantity was reached in early August.

Surface Transfer Coefficient

The estimate of surface transfer coefficient depends upon an assumed value of atmospheric stability for each day considered. Even within one day the atmospheric stability conditions vary from stable, through neutral, to unstable, and back again so that the choice of average values of stability presents a difficult problem. However, most of the heat transferred from ground to air, or vice versa, during a day flows during atmospheric instability. Very little heat is conducted when the air is stable. Consequently, conditions of instability are of most interest in thaw or freeze depth studies. When hand computations were carried out, the air was assumed to be stable, unstable, or neutral according to whether the heat reaching the ground surface before cumulative heat calculations were begun, was negative (outgoing), zero, or positive (incoming) (negative, zero, or positive radiation temperature). Previous studies have shown that stability and net heat flux correspond closely when the air and calculated surface temperatures were compared.

The question therefore arises: To what extent does an averaging of the surface transfer coefficient for several days affect the results when an actual day-to-day (or hour-to-hour) variation in atmospheric stability occurs? Two studies examined this question in part.

In one, atmospheric stability was evaluated daily for calculating equivalent temperatures; these were averaged over 10 day increments. In a comparable solution all parameters were initially averaged over 10 day increments. A comparison of the cumulative heat fluxes is shown in Fig. 6.

In another study, a computer was used to calculate the cumulative heat flux on the basis of 1 day, 10 day, 14 day, and 20 day incremental averages of all data. Fig. 7 shows the smoothing effect of longer increments. Although peak cumulative heat flux is somewhat reduced and occurs somewhat later, the effect is not great. For hand computational purposes, the more desirable longer increments do not substantially affect the results.

Because the surface transfer coefficient is calculated only in the crudest way from wind velocities, surface roughness, and stability conditions [9], dependency of cumulative heat flux on the value of the surface transfer coefficient was investigated at Fairchild, Wash., where the freezing season, in particular, was considered. A change in surface transfer coefficient can be assigned to any one or a combination of the above conditions.

Some uncertainty arose about assigning a value of atmospheric stability; therefore, two computer calculations were made, each using a different value for the factor relating surface transfer coefficient to wind velocity. The two values represented unstable and stable atmospheric conditions throughout the season. In Fig. 8 a comparison of the results shows that under the conditions at Fairchild, a surface transfer coefficient four times larger gives a cumulative heat flux

reduced to about 60% of that obtained with the lower transfer coefficient. During the winter the air is generally warmer than the ground surface. A higher transfer coefficient reduces the amount of heat flow out of the surface and consequently reduces the freeze depth. Alternatively, the change in transfer coefficient could also be attributed to, for example, wind velocities differing by a factor of four.

Mean Annual Temperature

One study ascertained the effect of the mean annual air temperature on the cumulative heat flux calculated. At a site

where freeze depth was calculated, a difference in mean annual temperature of about 3°F resulted in a difference of 5 to 10% in cumulative heat flux. The higher cumulative heat flux resulted from the higher mean annual air temperature with all other conditions remaining the same.

Soil Thermal Diffusivity

Thermal diffusivity of the top layer of soil affects calculations for cumulative heat flow. Since the soil changes state during the season, there were two different values of thermal diffusivity used for sites in Alaska where thaw depths were being

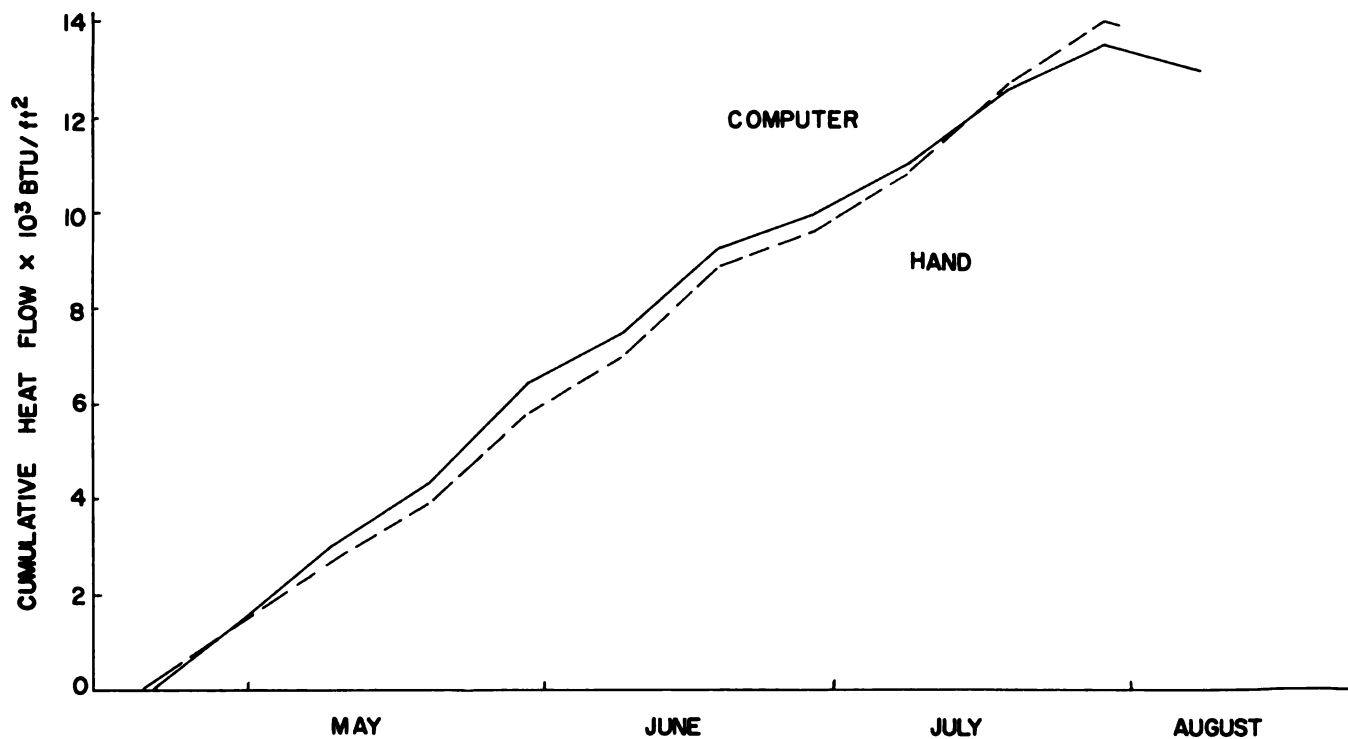

Fig. 6. Natural cover, Fairbanks, Alaska (thaw)

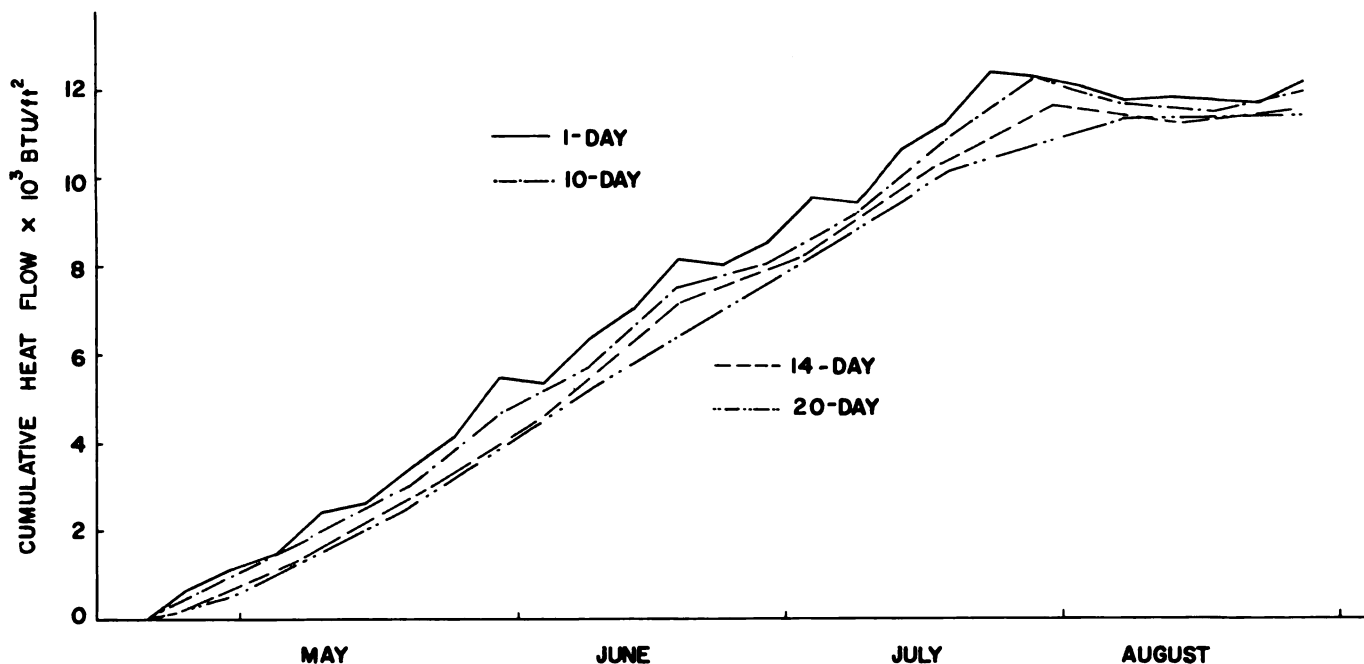

Fig. 7. Natural cover, Fairbanks, Alaska (thaw)

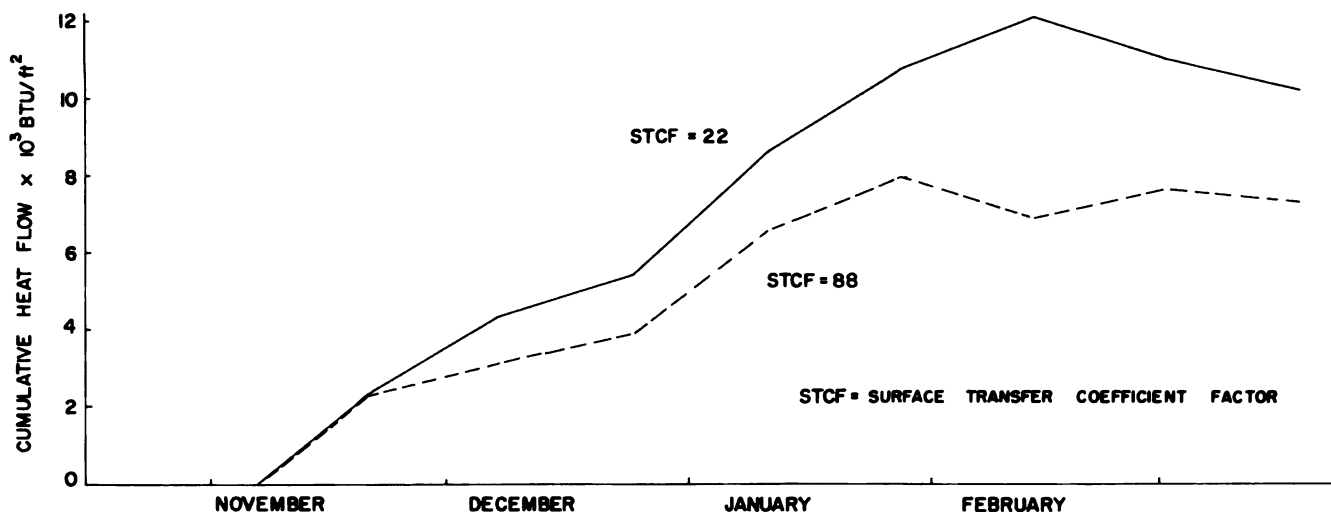

Fig. 8. Airfield pavement, Fairchild, Washington (freeze)

studied. The two values were appropriate to the frozen and thawed states of the soil. An increase in thermal diffusivity by a factor of almost four at one site resulted in a small and increasing difference between the curves of cumulative heat flux. The peak difference amounted to approximately 8% under the conditions studied. The higher value of the diffusivity gave rise to the higher value of cumulative heat flux.

At another site, two values of diffusivity, differing by a factor of 3.5, gave a larger effect on the curves of cumulative heat flux; the difference in peak values was 25 to 30%.

FREEZE OR THAW DEPTH

To obtain the freeze or thaw depth from the computed cumulative heat flux through the ground surface, the surface temperature curve, calculated from the first part of the procedure, was reduced to an equivalent step-change of temperature, whose magnitude was calculated. The ground temperature prior to the study was assumed to be uniform and the same as the mean annual ground temperature. The mean annual ground temperature need not be the same as the mean annual air temperature at a given site. With the values of mean annual ground temperature, equivalent step-change surface temperature, and thermal properties of each soil layer being determined from its physical characteristics of water content, dry unit weight, and soil type [10], the constant relating thaw or freeze depth and cumulative heat flux can be found by trial and error solution of Neumann's transcendental equation. A relationship can also be obtained between the cumulative heat flux and the thaw or freeze depth in Neumann's solution [5]. A different constant pertains to each soil layer in the region of interest.

A chart was then prepared for the site on which a working curve was drawn of cumulative heat flux versus thaw depth in straight lines at slopes determined by computed heat flux-thaw constants for the soil layers.

Combination of the calculated heat flux through the ground surface (from the time the surface first passes through the melting or freezing point of soil moisture) with the working

curve gives variation of thaw or freeze depth at a given site. The effect of differing soil properties or thermal characteristics on this relationship can be seen most readily from an inspection of Neumann's equation, since the heat flux-thaw depth relationship depends only slightly on the results (surface temperature) of the cumulative heat flux evaluation.

REFERENCES

- [1] R. F. Scott. "Study and Report of Micrometeorological Data Obtained in 1957-1958 at Tuto, Greenland," ACFEL, U.S. Army Engr. Div., New England, Waltham, Mass., 1959.
- [2] R. F. Scott. "Calculation of Meteorological Data, Tuto Ramp 1956," unpublished report of ACFEL, U.S. Army Engr. Div., New England, Waltham, Mass., 1957.
- [3] J. R. Mather, C. W. Thorthwaite. "Microclimatic Investigations at Point Barrow, Alaska, 1957-1958," Drexel Inst. Tech. Pub. in Climatology, Vol. 11, No. 2, 1958.
- [4] L. W. Gold. "Heat Flow and Ice Segregation at an Ottawa Site," D.B.R. Internal Rept. No. 171, D.B.R., Nat. Res. Coun. Canada, Ottawa, 1959.
- [5] R. F. Scott. "Heat Transfer in Soil Involving Change of State," Geotech., Vol. 11, 1961.
- [6] R. F. Scott. "Investigations and Report on Predicted Depth of Freeze or Thaw in Soils by Climatological Analysis of Cumulative Heat Flow," ACFEL, U.S. Army Engr. Div., New England, Waltham, Mass., 1961.
- [7] R. F. Scott. "Study and Report on the Validation of the Cumulative Heat Flow Technique," U.S. Army CRREL, Hanover, N.H., 1963.
- [8] C. W. Filwider, G. W. Aitken. "Effect of Surface Color on Thaw Penetration Beneath an Asphalt Surface in the Arctic," Proc. Intl. Conf. on the Structural Design of Asphalt Pavements, Univ. Mich. Press. Ann Arbor, April 1963, pp. 958-963.
- [9] R. F. Scott. "Estimation of the Heat-Transfer Coefficient Between Air and the Ground Surface," Trans. A.G.U., 38, 1957.
- [10] H. P. Aldrich, H. M. Paynter. "Analytical Studies of Freezing and Thawing of Soils," 1st Intl. Rept. to ACFEL, U.S. Army Engr. Div., New England, Boston, Mass., 1953.

CONTROL OF FROST PENETRATION IN NORWAY

SV. SKAVEN-HAUG, Geotechnical Department of Norwegian Railways, Norway

Apart from artificial heat supply we know of two methods, differing in principle, for preventing the destructive effects of frost penetration in the soil.

One consists of preventing the zero isotherm from penetrating into frost susceptible subsoil so that destructive heaving does not occur during the winter. On roads, railways, and open places this can be effected, if necessary, by adding layers of frost resistant materials. On existing plants, raising the surface is usually the most economical solution. If the surface cannot be lifted, then the existing subgrade is broken up and frost susceptible soil is replaced by nonfrost susceptible materials. If these materials are such that frost does not penetrate them to the same extent as the local soil, frost isolation is achieved.

The other method consists of preparing the local soil so as to prevent ice-lens formation during freezing. Because the destructions are due to the water phase, effort is concentrated on altering the water properties, replacing it by something else, or removing it. This nondestructive method has many attractive features. Adding different salts makes the pore water stiffer and more sluggish, thereby preventing lens formation. Further, an admixture of cement, bitumen, or resin clearly has a favorable effect. The best procedure would be to use injection, but this is impractical because fine grained soil is impervious to injection—and all frost susceptible soil is fine grained. For the same reason it is impossible to remove water by draining.

For the present we are forced to adopt the first method—that of providing a sufficiently thick frost isolating stratum comprising frost resistant materials.

FROST PREVENTIVE WORK ON NORWEGIAN STATE RAILWAYS

Railways built in Norway prior to 1915 had a 0.50 m bearing layer of gravel. These layers did not afford adequate protection against frost action on silty soils. Extensive, uneven frost-heave required costly maintenance shimming during the whole winter period and the subgrade proved to be unstable during spring thawing. Gravel foundations have, however, one great advantage over stone foundations. The sandy natural gravel is an excellent filtering material; the boundary between silt and gravel after 50 to 100 years is still sharp in spite of undulating subgrade deformations.

Where conditions are favorable, the track is raised with natural gravel. Because the tracks must be raised considerably (1.0 to 1.5 m), several reasons preclude raising as the general method. Among these are: Frequent occurrence of high embankments which must be widened; frequent occurrence of mountain tunnels which must be increased in height; and recent shortage of natural gravel, the only material that can be considered for extensive raising.

This is the background of very extensive mass replacement work, i. e., the excavation of frost susceptible soil to a sufficient depth and replacement with nonfrost susceptible materials. The aim is a shimless track, even in the severest winters. Work began in earnest in 1945, and since 1957 has been intensified by the decision to use broken stone instead of gravel as ballast on all the older railways. There is mass replacement of 25 to 30 km per annum on one track operational railways. In addition, raising is performed wherever frost-heave is moderate. Hopefully, the Norwegian State Railways will have frostproof subgrade by 1968 or 1970.

Materials or combinations of materials are selected that have a total layer thickness substantially less than the frost depth in the local natural soil. Mass replacement is, therefore, a distinctly frost isolating process, with small excavation depths and thin replacement layers. Layer thickness is dimensioned according to engineering calculations; for bottom

layer, materials with high frost capacity—that is, high water content—such as peat (Sphagnum), wood (discarded sleepers), and bark are used.

An exhaustive account of the frost preventive work of the Norwegian State Railways, including a historical survey, theoretical postulates, practical execution, and experiences, has been published [1]. This report is confined to a brief extract, supplemented by more recent experimental results.

CALCULATION OF FROST DEPTHS

The Norwegian calculation of frost penetration in soil [2] is probably the first scientifically based method which has found practical application. The significance of air temperature for frost penetration into soil is expressed numerically as the frost volume (F_T) which is calculated as the product of time (hours) and degrees Centigrade below zero ($^{\circ}\text{C}$).

In the time the frost takes to penetrate through a layer of material of indeterminate depth from its upper to lower surfaces, the part (Ω) of the total frost volume (F) is used up. Frost resistance of the layer is thus Ω . The sum of the frost resistance ($\Sigma\Omega$) of several superincumbent layers, which are frozen during the winter, is equal to the winter's frost volume (F).

By making certain simplifications, namely, by disregarding heat radiation and the earth's heat, which have opposite signs, the frost volume can be calculated from

$$\Omega = q \frac{\delta^2}{2} \left[\frac{1}{\lambda} + \frac{2}{\delta} \left(\frac{1}{\alpha} + \sum \frac{\delta_o}{\lambda_o} \right) \right]$$

with the units, hour $^{\circ}\text{C}$ where δ is thickness of the layer in m; q is cold-absorbing capacity in kilocal/cu m; λ is heat conductivity in kilocal/m hour $^{\circ}\text{C}$; α is factor of heat transition between surface and air in kilocal/sq m hour $^{\circ}\text{C}$; and

$\sum \frac{\delta_o}{\lambda_o}$ is heat penetration resistance of superincumbent layers in sq m hour $^{\circ}\text{C}$ /kilocal.

The constants (λ and q) for the material can be deduced from Figs. 1 and 2 [2] if the water content (volume percentage), which the soil layers have or acquire during the freezing process, is known.

In the following calculations, heat transition resistance ($1/\alpha$) between air and surface is also disregarded.

The amount of frost absorbed by the upper layer of material and equal to the layer's frost resistance is based on these presuppositions

$$\Omega_1 = \frac{q_1}{\lambda_1} \frac{\delta_1^2}{2}$$

In an underlying layer of thickness δ_2 , the frost resistance is

$$\Omega_2 = \frac{q_2}{\lambda_2} \frac{\delta_2^2}{2} + q_2 \delta_2 \frac{\delta_1}{\lambda_1}$$

For a layer lying below this, the frost resistance is

$$\Omega_3 = \frac{q_3}{\lambda_3} \frac{\delta_3^2}{2} + q_3 \delta_3 \left(\frac{\delta_1}{\lambda_1} + \frac{\delta_2}{\lambda_2} \right)$$

Expressing the frost resistance of all the superincumbent layers with the prescribed layer thickness as $\Sigma\Omega_o$, and assuming that the remaining amount of frost ($F - \Sigma\Omega_o$) is absorbed entirely by an underlying layer, e. g., a frost retarding replacement layer, then the required thickness of the latter is computed by

$$\delta = -\lambda \sum \frac{\delta_o}{\lambda_o} + \sqrt{\lambda^2 \left(\sum \frac{\delta_o}{\lambda_o} \right)^2 + 2 \frac{\lambda}{q} (F - \Sigma\Omega_o)}$$

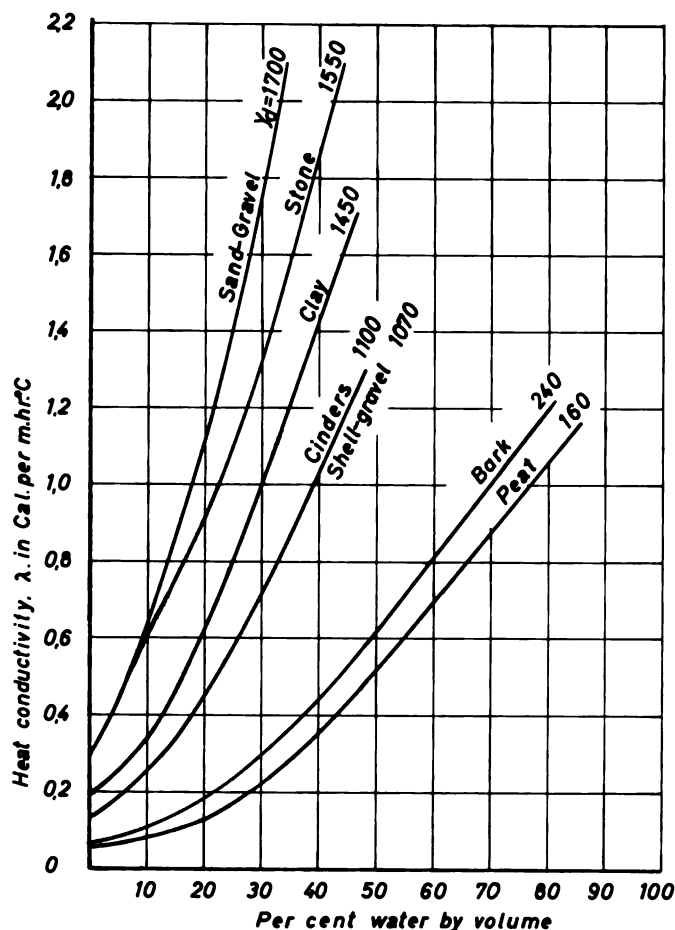

Fig. 1. Heat conductivity of frozen material, mean temperature -5°C

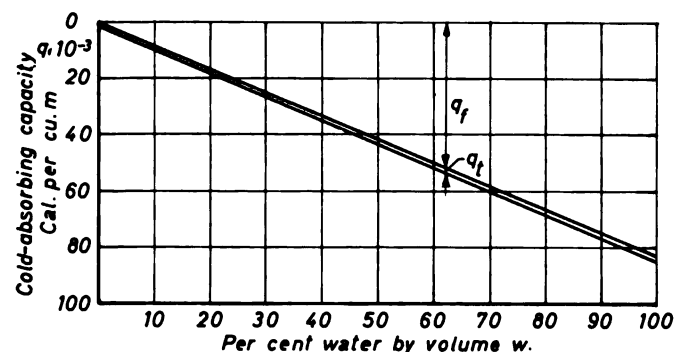

Fig. 2. Frost-storing capacity $q = q_f + q_t$ computed for the temperature interval $+2^{\circ}\text{C}$ to -2°C , where q_f is due to water and q_t to dry material; q_t is maximum value of the materials investigated (found in cobble stones). The minimum value (dried peat) is about 1/10 of the maximum

The method of calculation is based on the constancy of water content during freezing. This supposition is safe and correct as regards nonfrost susceptible materials used in frost resistant foundations. Agreement between calculated and observed frost depth has been very good. In frost susceptible ground, on the other hand, full agreement cannot be expected, as it is impossible to foresee how much water will be supplied during freezing. The water volume supplied (ice-lenses) depends, among other things, on air temperature fluctuations.

DESIGN OF REPLACEMENT LAYERS

The amount of winter cold greatly influences frost depth. The effective amount of cold for frost formation during a winter (F) is expressed numerically as the product of time and degrees of cold from an autumn date when the amount of cold begins to accumulate, until a spring date when this accumulation ceases. Deductions are made for intervening periods of mild weather. The units (hour $^{\circ}\text{C}$) are hours multiplied by degrees Centigrade. With good approximation, a winter's amount of frost (hour $^{\circ}\text{C}$) can be computed empirically by $(t_1 + t_2 + t_3 + \dots) 720 + 3\%$, where t_1, t_2, t_3, \dots are the average monthly temperatures for months having an average temperature below zero.

For practical use in frost dimensioning, a chart of Norway was prepared, showing curves for both maximum (F_{max}) and average (F_{mean}) amounts of cold.

Experience has proven it unnecessary to base frost isolation design for railways on the maximum amount of cold. On the other hand, frost isolation would be inadequate and would freeze through on an average of every second year if it were designed only for the mean amount of cold. The isolation is therefore designed to freeze through once every 20 years. This is justified by the fact that cold winters give drier and more isolating ballast layers. Experience also shows that harmful heave does not occur unless frost substantially penetrates the subgrade.

By statistical treatment of the meteorological materials [3], the degree of frequency of amounts of cold is known, and the amount of cold (F) with frequency 5%, i.e., occurring every twentieth year, can be computed from either $F = F_{\text{mean}} + 0.6 (F_{\text{max}} - F_{\text{mean}})$ or from $F = 0.82 F_{\text{max}}$.

Table I. Mean figures for design of Norwegian Railways frost foundations

	H_2O vol. (%)	Heat ^a conductivity, λ	Cold storing ^a capacity, q
Snow-ice	50	0.50	
Gravel ballast	13	0.80	12,300
Broken stone ballast	8	0.57	7,800
Locomotive cinders (including ash)	20	0.40	17,400
Peat	80	1.05	68,000
Bark	75	1.00	62,000
Gravel	13	0.80	12,300
Stone	8	0.57	7,800
Clay	45	1.65	39,000

^aValues for λ and q are derived from Figs. 1 and 2.

Diagrams have been prepared for the design of soil replacement layers, for differing local frost volumes (F), and for various types of replacement material.

Fig. 3 gives the requisite excavation depth and layer thickness for stone, gravel, cinders, bark, or peat underneath the formation with superincumbent broken stone ballast. The calculation is based on a superincumbent snow and ice layer of 0.06 m after the ballast layer is frozen. Peat, which can retain much water, requires the least thickness and is decidedly the best frost retarding material. Engineers have a theoretical confirmation of the excellent results shown by practical experience. Use of gravel requires larger thickness because it accommodates only a modest water content.

If for an average cold locality in Norway a frost resistant subgrade is dimensioned for a frost amount of 35,000 hour $^{\circ}\text{C}$, the following layer thicknesses are read off for the bottom layer (d) underneath 0.5 m of broken stone ballast: 1.7 m of stone; 1.4 m of gravel; 0.9 m of locomotive cinders, and 0.4 m of peat, wood, or bark.

The greatest reduction in frost depth is obtained by using a dry, isolating top layer and a moist bottom layer with a very large cold storing capacity. On railways, roads, and open

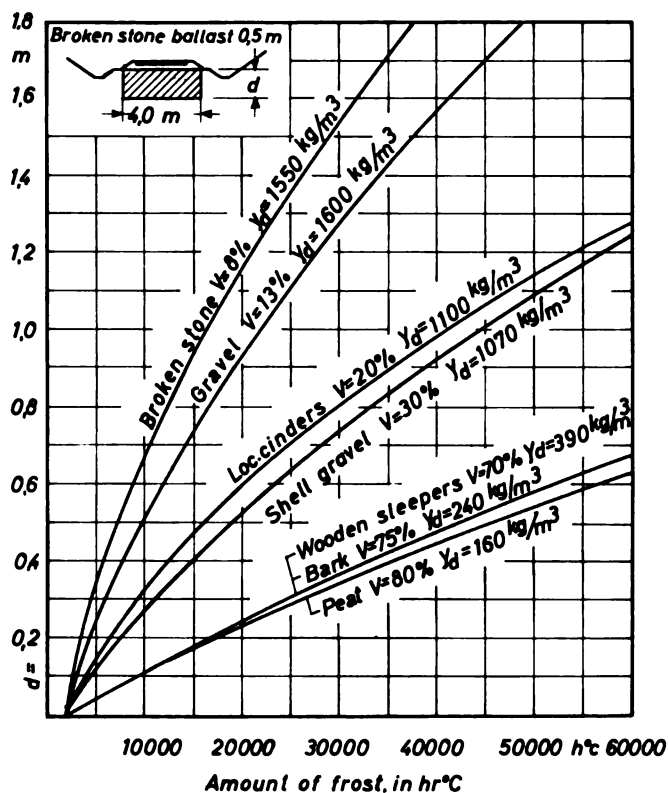

Fig. 3. Replacement depth for stone, gravel, cinders, bark or peat under the formation with superincumbent 0.5 m broken stone ballast

places in Norway, it is best to have a well drained bearing layer at the top, and a wet undrained bottom layer.

For roads and open places it may be convenient to use a slightly underdimensioned frost isolation, provided a moderate heave can be tolerated in an exceptionally cold winter and that the roadbed is sufficiently thick to prevent breakdown of the subgrade during thawing.

DURABILITY AND DEFORMATION OF ORGANIC MATERIALS IN FROST RESISTANT FOUNDATIONS

On the Norwegian State Railways it is safe and proper to use (in a frost resistant foundation) organic materials with high water retention properties that require a minimum of excavation depth and layer thickness. The top of Fig. 4 shows the use of peat. The peat mat is made of ready-pressed blocks 1.0 m long, 0.5 m wide, and 0.3 to 0.5 m thick, depending on local frost volume. The middle of Fig. 4 shows the use of discarded wooden sleepers, which have previously lain up to 25 years in the track and which still contain some creosote. Norwegian pine sleepers contain considerable amounts of heartwood. At the bottom of the figure is shown the use of spruce or pine bark which was pressed in advance on the site.

Systematic use of organic materials in the foundation is probably unique for Norway, and a detailed account of the method with the latest observations may, therefore, have interest. Naturally some doubt may arise about the durability of organic materials, and some fear be entertained or the possibility of extensive elastic deformations.

PEAT (SPHAGNUM)

Experience has been greatest with the peat mat. The oldest peat mat, made of loose peat stamped on the spot, is 60 years old; the oldest peat mat made of pressed peat blocks is 35 years old. The peat shows no qualitative alterations or extensive reduced layer thickness that might limit the isolating capacity.

Peat probably does not rot because in both summer and winter it is almost saturated with water and has a scanty oxygen supply. In places where frost isolation is needed, the subgrade is moist and the capillary rise in compressed peat is equal to or greater than the thickness of the peat mat. The mean annual air temperature where peat is used is low (0° to 6° C). All these factors greatly reduce bacterial activity.

Fig. 5 shows temperature measurements in the air and in the peat mat during the last five years at Otta on the Dovre Railway. Otta, situated in an inland area 288 meters above sea level, is a relatively cold place on the Norwegian State Railways.

The cross section (Fig. 5) shows that electric thermometers were built into the peat mat with a superincumbent 0.55 m of ballast. In 1959 and 1961 the track was raised 0.05 and 0.20 m, respectively, so that the thickness of ballast after 1961 became 0.80 m. Locomotive cinders in the ballast, as in this case, are not usual. Gravel or broken stone is laid directly on the peat mat. The top of Fig. 5 shows mean monthly air temperature and the winter's amount of frost. The winters from 1959 to 1962 were mild, and the amount of frost below average. The winter of 1963, however, was very cold and the amount of frost, 38,000 hour °C, was very close to the local maximum.

The middle of Fig. 5 shows the recorded temperatures from thermometers Nos. 4 and 6 in the peat mat. Thermometer No. 5 measures intermediate temperatures. No. 4 measures the highest summer and the lowest winter temperatures. The highest temperature recorded from No. 4 occurs in July and August and is approximately the same numerical value as the highest mean air temperature which occurs in June and July. The highest temperature recorded from thermometer No. 6 shows a lower value than the monthly mean air temperature. Seemingly then, oxidation causes no heat development in the peat mat. In the winter the frozen part of the peat mat has a substantially higher temperature than the mean monthly air temperature. The lowest temperature recorded from thermometer No. 4 in February 1963 was -3° C, while the average monthly air temperature was -15° C.

The bottom of Fig. 5 shows the observed and calculated frost boundary. The frost limit is checked by excavation. The agreement is good and relates to the difference of 20 to 50 mm for the winters from 1959 to 1962 and 80 mm for the winter of 1963. Significantly, the peat mat is overdimensioned since the track was lifted.

As mentioned, the winter of 1963 was extremely cold, and in the southeastern parts of Norway the frost volume approximated to the maximum values. No destructive frost heaving was noted wherever mass replacement was performed with organic materials, despite several places where the frost

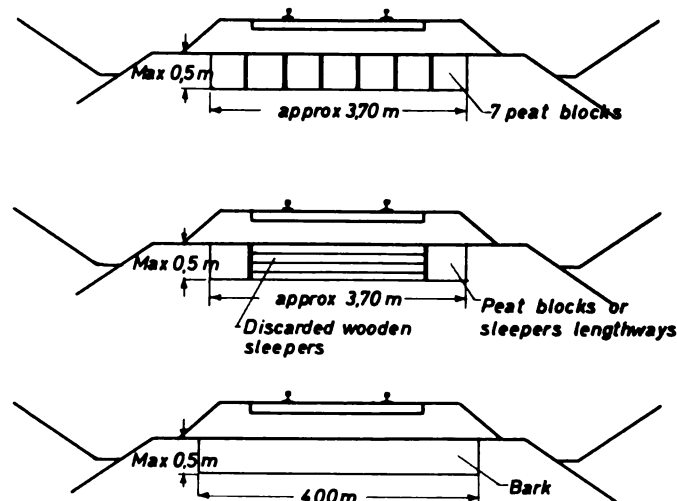

Fig. 4. Current mass replacement profiles for organic materials. Depth of trough equal to thickness of frost isolating layer, dimensioned by use of Fig. 3

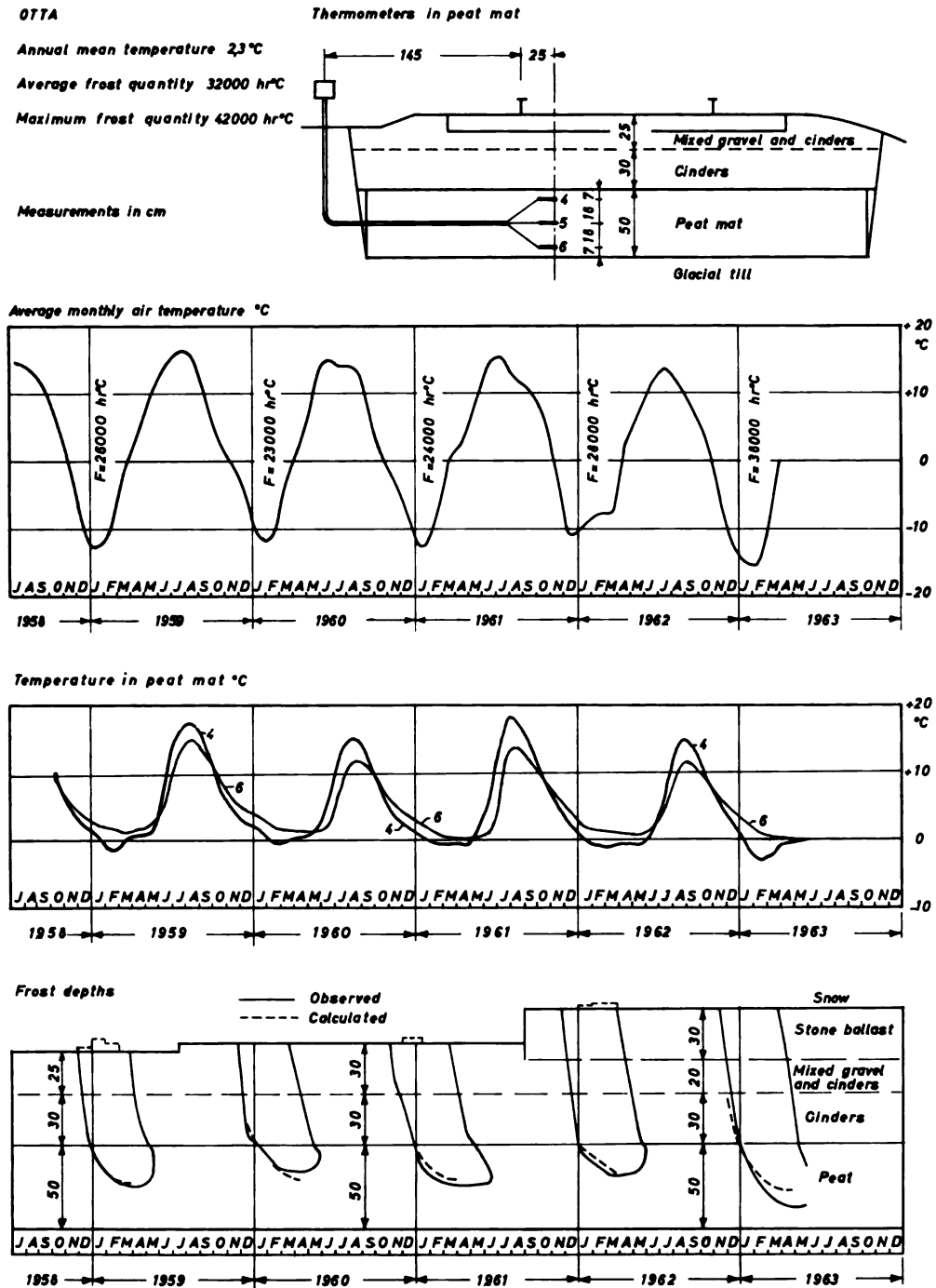

Fig. 5. Temperature measurements in air and in peat mat. Calculated and observed frost level, Otta, Dovre Railway

boundary lay as much as 10 cm below the lower edge of the mat. There were no ice layers in the underlying silt, which appeared somewhat dried. So apparently, the present dimensioning standards are unexaggerated and correct.

Peat bundles are pressed in advance to a dry density of approximately 160 kg/cu m (depending on the peat's degree of transformation), and the pressure is then 1.5 kg/sq cm. Since the peat is dried in advance, the weight of a block does not exceed 90 kg. Under the track, peat is compressed slowly, and measurements show 0.3 to 0.5 cm per annum in

the first 10-year period, with a tendency to diminish slightly. For the railway track the corresponding subsidence has no practical significance, as the track must for other reasons be regulated at intervals of a few years.

The elastic deformation of a 0.50 m peat mat under an axle pressure of 18 tons is satisfactory and not greater than that which often occurs in a natural subgrade [1] with ample water content. Experience is good with railways built across marshes with up to 3 m of peat and dry density of the peat is substantially less than in the peat mat.

DISCARDED SLEEPERS

Since 1954 it has been permissible to use discarded wooden sleepers, which still contain some creosote, as a frost resistant foundation. These sleepers are economical and do not cause track subsidence. Laying sleepers is somewhat more work than laying peat blocks.

BARK

In recent years spruce and pine tree bark has been a readily accessible material, because timber is now stripped of its bark at wood processing mills or collecting stations. After experimenting, the first trial stretches with bark were laid in 1961 and 1962 [4].

Table II. Approximate averages for current materials in compressed frost resistant mats

	λ kg/cu m	γ^d kg/cu m	T %	V %	L %	k m
Peat	1.60	160	10	80	10	0.5
Discarded sleepers	1.60	390	25	70	5	
Bark	1.60	240	15	75	10	0.5

Wet bark must be compressed to a dry density of about 240 kg/cu m. It causes smaller track subsidence as well as less elastic deformation than peat. Frost isolation is equal to that of peat. Unprocessed bark from storage heaps can be compressed by conventional implements, such as stampers or heavy vehicles. Vibratory machines have not proved suitable. Where bark cannot be conveyed directly on lorries, preference on one track railways is given to pressed blocks of the same size as for peat. Weight of the block is about 150 kg for a

0.5 m thickness, when the bark is taken from the storage heap, as compared with 90 kg for peat that has been somewhat dried in advance. Bark blocks are substantially cheaper than peat blocks, and the pressing of bark blocks for laying in 1963 has been started.

Expense prohibits the use of peat in a frost resistant roadbed. Bark is a waste product produced in such large quantities that storage places are filled to overflowing. Hitherto bark was used as leveling material. It was burned to ashes or dropped into the sea. In the author's opinion, bark is useful for road building in cold regions. Under a bearing layer of moderate thickness, 0.2 to 0.4 m of compressed bark provides a frostproof foundation and also serves as a very satisfactory filter layer against underlying silt.

In Table II the pressure used in making the blocks (of current materials) was 1.5 kg/sq cm. In the table λ is specific weight; γ^d is dry density; T, V, and L are percentages by volume of substance, water, and air; and k is height of capillary rise.

REFERENCES

- [1] Sv. Skaven-Haug. "Protection against Frost-Heaving on the Norwegian Railways," *Geotechnique*, London, Vol. 9, 1959, pp. 87-106.
- [2] A. Watzinger, E. Kindem, B. Michelsen, K. Heje. "Undersøkelser av masseskiftingsmaterialer for vei- og jernbanebygging," *Medd. fra veidirektøren*, No. 6, 1938, pp. 101-122; Nos. 7, 8, 9, 1941; pp. 81-88, 101-120, 125-134. German summary.
- [3] Sv. Skaven-Haug. "Frostmengdekart over Norge," *ibid.*, No. 5, 1944, pp. 49-54.
- [4] Sv. Skaven-Haug. "Bark as Frost-Insulating Material in Soil," *Wood Gazette*, Vol. 28, London, 1963, pp. 464-467.

AIR TEMPERATURES IN NORTHERN CANADA WITH EMPHASIS ON FREEZING AND THAWING INDEXES

H. A. THOMPSON, Canadian Meteorological Branch

Frost action in soils as a problem in highway, airport, and waterworks design and operation has been recognized for many years in southern sections of Canada and in the northern and central United States. Research on freezing and thawing in these areas has been facilitated by an abundance of ordinary climatological data and by reports from a growing network of soil temperature stations.

With the exception of scattered mining or railroad locations in the Canadian subarctic, information on the behavior and extent of permafrost was very meager prior to World War II. Soil temperature data were practically nonexistent; widely separated climatological stations had records of only a few years. Many observation stations (established in northern sections of the mainland during the war) remained in operation. With the establishment of the Joint Canadian and U. S. Weather Stations on the islands of the Canadian Arctic Archipelago in the years 1947 to 1950, climatological data became available from all parts of Canada.

Exploration and development in northern Canada has increased recently. Wide-spread areas of permafrost with intensive frost action confront engineers and scientists. The engineer in southern Canada is concerned with the depth and rate of frost penetration and retreat in soils in winter; his counterpart in northern Canada is concerned with depth and rate of thaw in permafrost in summer. Because adequate soil temperature information is lacking, calculations must be based on climatic averages. Many climatic elements affect freezing and thawing in soils, and air temperature is probably the most closely related single element [1].

At the close of the 1951-1960 decade, climatological data covering a standard ten-year period became available for the first time from many areas of northern Canada. Temperature observations are summarized here for the decade in a manner that will be most useful to those concerned with frost-action calculations.

In a literature review of soil temperatures and thermal properties, Crawford [2] noted that an empirical relationship involving degree-days below freezing air temperature and frost penetration into the ground was first used in highway design in the United States about 1930. The relationship has been confirmed by numerous investigators, and the use of freezing indexes in predicting frost penetration has become common engineering practice. Information on frost depth in soil is often required for a site at some distance from the nearest weather station. At such locations the freezing index map may be used with empirical design curves or equations to provide first approximations of frost penetration [3]. The soil freeze and thaw rate has considerable bearing on frost damage to ground installations [2]. This, in turn, is related to the rate of accumulation of degree-days, usually during the first few weeks of the freezing or thawing seasons.

Permafrost depth thaw may be determined in much the same manner as soil frost penetration, although in this case the thawing degree-day is the unit, while the thawing index represents seasonal accumulation. This relationship, a recent extension of the degree-day technique, is of considerable use in northern Canada. Sebastyan [4] singles out the thaw depth in permafrost areas as a major factor in pavement and founda-

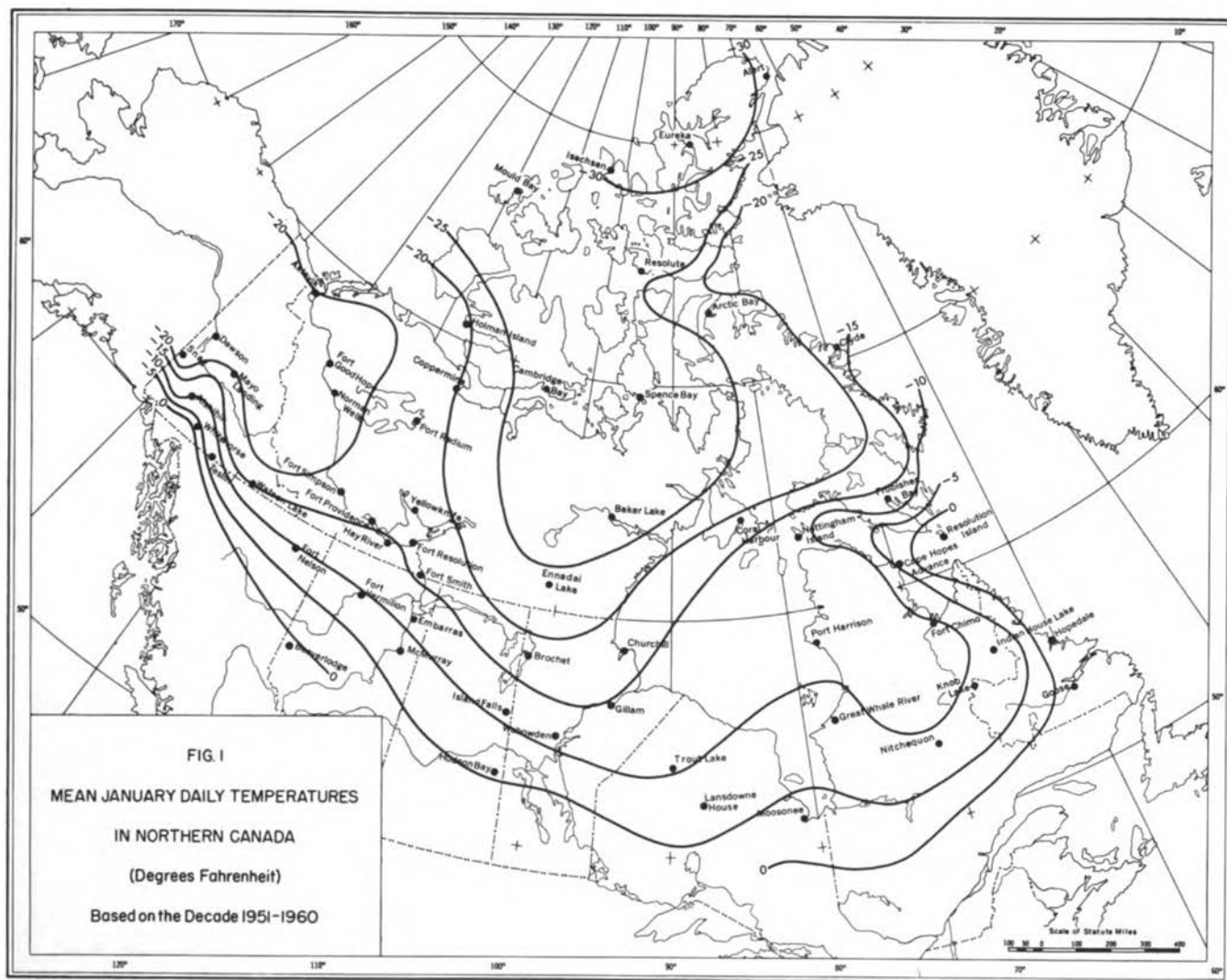

tion design. Knowledge of its maximum value and its variation during freezing and thawing periods is essential.

The degree-day method is based entirely on temperature, although indirectly the effects of such climatic factors as radiation and cloud cover are also indicated. However, the influences of several other climatic elements are neglected as are such environmental factors as surface cover, soil type, conductivity, and water content. Empirical correction factors have been determined for various types of surfaces which make it possible to convert air-temperature indexes (at screen level) to actual surface-temperature indexes [5].

Basic equations and design curves used in calculating thaw or frost depth may be found in "Calculations of Depth of Thaw in Frozen Ground" [6] and "Engineering Manual for Military Construction" [5].

Considered individually, freezing and thawing indexes are of little use in predicting the existence of permafrost. Whether permafrost will form, or if already present will persist, depends not only on frost penetration during the freezing season, as measured by the freezing index, but also on frost retreat during the thawing season, which, in turn, is indicated by the thawing index. Thus locations with high freezing indexes may not necessarily have permafrost if their thawing indexes are also high. If, however, their thawing indexes are low, permafrost will probably be present. The mean annual air temperature, which combines the temperature contributions of both thawing and freezing indexes, is a somewhat more useful expression of temperature relating to permafrost distribution, but according to Brown [7] there is only a very broad correla-

tion. Using mean annual temperature and average thawing index, Pihlainen [8] was able to arrive at an approximation of probable permafrost occurrence which may be considered suitable for preliminary engineering assessments.

COMPILATION AND PRESENTATION OF AIR TEMPERATURE DATA

In an earlier investigation [9], freezing and thawing indexes were calculated for many stations, mostly within the permafrost region. To provide this type of information in and just south of regions having discontinuous permafrost [7], similar calculations were made for about 20 more stations; freezing and thawing indexes are given for these stations and for the 40 stations of the original project. Maps for northern Canada show mean January, July, and annual temperatures (Figs. 1, 2, and 3). Other maps (Figs. 4 and 5) show the areal distribution of freezing and thawing indexes during the most recent decade.

The network of 60 stations includes the majority of stations north of 55 deg latitude in Canada which have continuous climatological records between 1949 and 1959. This period covered ten freezing and ten thawing seasons and represented the most recent decade of observations available at the time on punched cards. The 10-year period used is only a third of the 30 years recommended for calculation of climatic normals; therefore, the results should be regarded only as a good "sample." As fewer than one quarter of the stations involved have records over the 30-year standard period, there was no attempt to adjust the values to the standard normal period.

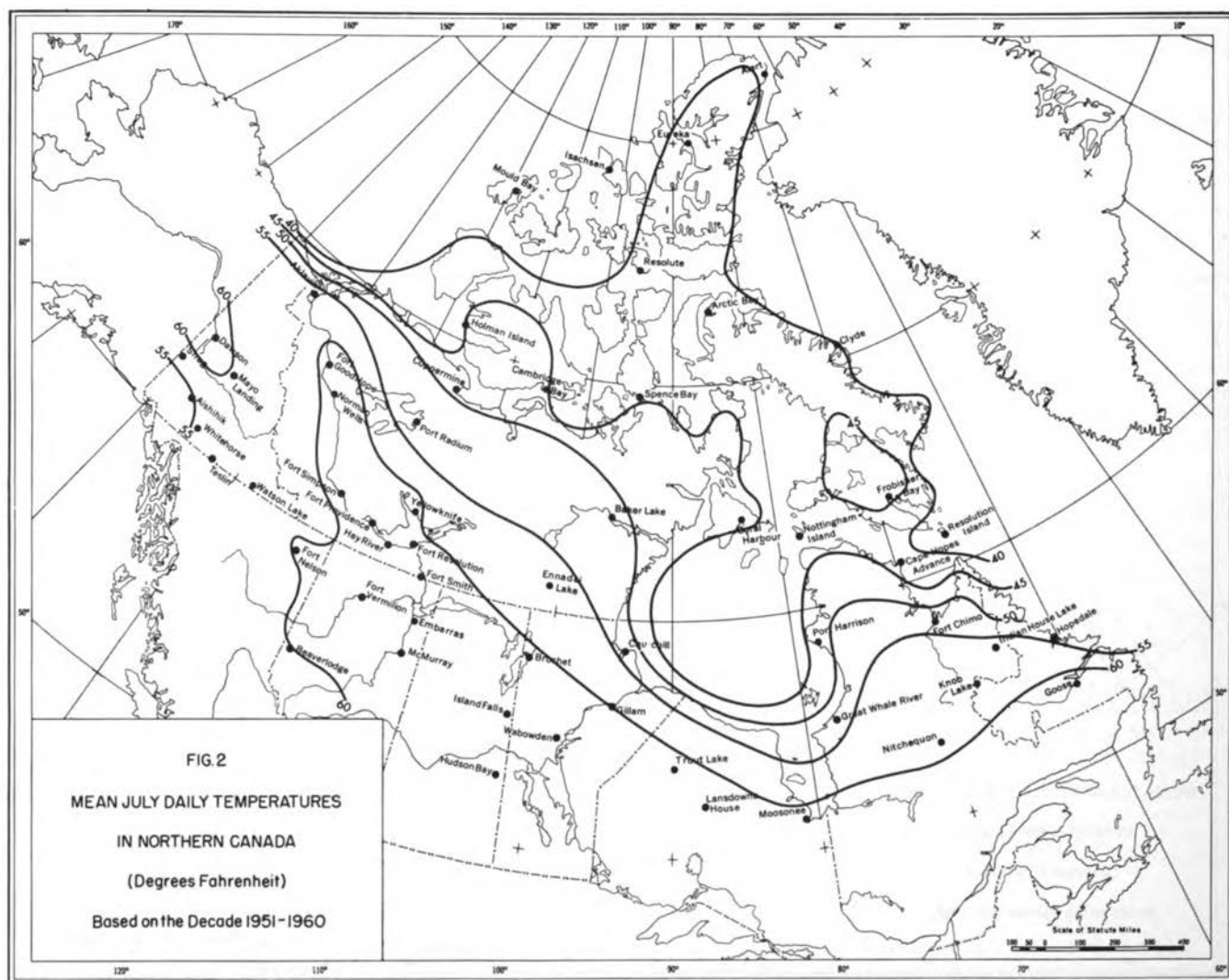

The 10-year period used in the degree-day calculations differs slightly from the standard decade 1951-1960 on which the mean daily temperature charts are based. Although the two periods are comparable as far as mean annual and mean daily July temperatures are concerned, the earlier period includes the unusually cold January 1950. However, in view of the rather open spacing of stations and the generalized rather than detailed construction of the climatic maps, the difference of one or two degrees in average January temperature should not be too significant.

The definitions used in these calculations are from the Engineering Manual, Corps of Engineers, U.S. Army [5]. Degree-days for any one day are the difference between the mean daily air temperature and 32°F. Freezing degree-days are given when the mean daily temperature is below 32°F; thawing degree-days occur when it is above 32°F. In the tabulations, the degree-day totals for each day were derived from mean daily air temperatures (in whole degrees, Fahrenheit, based on the average of daily maximum and daily minimum temperatures). To give algebraic summations of degree-days measured from 32°F, 365 punched cards per station year were machine processed.

The freezing index may be defined as the number of degree-days between the high and low points on a curve of cumulative degree-days versus time for one freezing season [5]. The thawing index is dependent on the maximum and minimum values on the summation curve during a thawing season.

The mean and extreme values and standard deviations of freezing and thawing indexes are listed for each station

(Tables I and II). Although a longer period of record would be desirable, the standard deviations based on ten years of the normally distributed indexes give an indication of their variability from one year to the next. However, it is not a satisfactory method for comparing the variations in two different areas.

CLIMATIC AND PHYSICAL FEATURES

Of the factors responsible for the temperature pattern of northern Canada, the high geographical latitude is probably the most significant. This area, which embraces the arctic tundra and the lightly forested subarctic belt, experiences extreme variations in the amount of solar radiation reaching the ground over the course of a year. Essentially it comprises an extensive, low-lying plain, along a NW-SE axis of the continent, bounded by high mountain and plateau areas west of the Mackenzie River and by the formidable barriers of mountainous Ellesmere and Baffin Islands in the east. In summer the ice-filled waters of the Arctic Ocean keep temperatures low over the islands of the Arctic Archipelago, while the cold waters of Hudson Bay exert a similar chilling influence on the northeastern mainland. Migratory low-pressure systems usually pass south of the subarctic in winter and, at best, only briefly interrupt the persistent flow of cold air over the region. In summer they frequently move through northern Canada and, in western mainland areas in particular, the season may be very warm.

Table I. Average and extreme values of freezing index (degree-days) 1949-1959

Station	10-yr. Av.	Std. Dev.	High	Season	Low	Season
Aishihik	5 302	738	6 291	1955-56	4 114	1952-53
Aklavik	8 037	546	8 594	1954-55	6 811	1949-50
Alert ^a	12 093	317	12 544	1950-51	11 397	1952-53
Arctic Bay	9 923	596	10 674	1953-54	8 849	1952-53
Baker Lake	9 422	457	10 072	1949-50	8 891	1952-53
Beaverlodge	2 866	708	4 007	1955-56	2 000	1954-55
Brochet	6 216	521	7 040	1949-50	5 417	1952-53
Cambridge Bay	10 860	318	11 311	1957-58	10 302	1952-53
Cape Hopes						
Advance	5 443	578	6 309	1956-57	4 562	1955-56
Chesterfield	8 750	447	9 449	1956-57	8 151	1952-53
Churchill	6 718	462	7 755	1949-50	6 253	1952-53
Clyde	8 671	523	9 365	1956-57	7 943	1952-53
Coppermine	8 882	496	9 439	1957-58	7 869	1952-53
Coral Harbour	8 539	656	9 510	1953-54	7 666	1952-53
Dawson	6 495	865	7 763	1955-56	5 261	1952-53
Embarras	4 632	629	5 409	1951-52	3 738	1952-53
Ennadai Lake	8 130	410	8 840	1949-50	7 660	1953-54
Eureka	13 322	533	14 243	1956-57	12 519	1952-53
Fort Chimo	5 381	613	6 176	1949-50	4 518	1957-58
Fort Good Hope	7 860	631	8 638	1950-51	6 877	1949-50
Fort Nelson	4 801	661	5 731	1950-51	3 793	1952-53
Fort Providence ^a	5 752	...	6 658	1955-56	4 731	1952-53
Fort Reliance	7 172	457	7 726	1956-57	6 337	1952-53
Fort Resolution	5 776	603	6 354	1951-52	4 618	1952-53
Fort Simpson	6 040	671	6 895	1950-51	4 916	1952-53
Fort Smith	5 613	612	6 235	1951-52	4 567	1952-53
Fort Vermillion	4 810	716	5 674	1951-52	3 598	1952-53
Frobisher Bay	7 052	680	8 096	1956-57	6 226	1955-56
Gillam ^a	5 815	335	6 256	1958-59	5 316	1952-53
Goose Bay	3 077	689	4 099	1949-50	1 877	1957-58
Great Whale River ^a	4 610	...	5 592	1949-50	3 834	1952-53
Hay River	5 548	648	6 332	1955-56	4 287	1952-53
Holman Island ^a	9 015	...	9 677	1955-56	7 931	1952-53
Hopedale ^a	3 303	663	4 235	1949-50	2 335	1957-58
Indian House Lake	5 319	666	6 165	1956-57	4 079	1957-58
Isachsen	12 753	458	13 486	1955-56	11 983	1952-53
Island Falls	4 837	545	5 609	1949-50	4 119	1952-53
Knob Lake	5 109	659	5 995	1949-50	3 898	1957-58
Mayo Landing	5 881	942	7 020	1950-51	4 480	1952-53
McMurray	4 086	666	4 973	1949-50	3 196	1952-53
Moosonee	3 790	551	4 626	1949-50	2 810	1952-53
Mould Bay ^a	11 912	525	12 529	1953-54	10 987	1952-53
Nitchequon	4 790	705	5 640	1958-59	3 672	1957-58
Norman Wells	7 220	620	7 973	1950-51	6 137	1952-53
Nottingham Island	6 401	562	7 227	1953-54	5 547	1952-53
Port Harrison	5 804	507	6 527	1949-50	5 165	1952-53
Port Radium	6 982	565	7 776	1955-56	5 713	1952-53
Resolute	11 204	390	11 591	1956-57	10 292	1952-53
Resolution Island	4 434	587	5 483	1956-57	3 791	1952-53
Snag	6 741	553	7 499	1955-56	5 964	1957-58
Spence Bay ^a	11 093	...	11 578	1956-57	10 524	1954-55
Teslin	4 048	796	5 224	1955-56	2 931	1957-58
Trout Lake	5 118	552	6 262	1949-50	4 189	1952-53
Wabowden	4 872	529	5 859	1949-50	4 159	1952-53
Watson Lake	5 402	704	6 510	1955-56	4 515	1954-55
Whitehorse	3 861	839	5 105	1955-56	2 852	1957-58
Yellowknife	6 623	563	7 159	1950-51	5 318	1952-53

^aPeriod of record less than ten years

Table II. Average and extreme values of thawing index (degree-days) 1949-1959

Station	10-yr. Av.	Std. Dev.	High	Year	Low	Year
Aishihik	2 412	224	2 715	1951	2 035	1955
Aklavik	2 261	302	2 859	1958	1 761	1959
Alert ^a	387	156	612	1956	141	1955
Arctic Bay	808	87	990	1954	699	1955
Baker Lake	1 515	207	1 947	1954	1 193	1950
Beaverlodge	3 859	311	4 393	1958	3 469	1959
Brochet	2 935	317	3 412	1955	2 525	1959
Cambridge Bay	1 016	201	1 406	1954	767	1959
Cape Hopes						
Advance	974	148	1 198	1955	822	1958
Chesterfield	1 321	182	1 673	1954	1 098	1957
Churchill	2 056	221	2 380	1955	1 764	1958
Clyde	655	83	795	1957	550	1959
Coppermine	1 362	208	1 620	1954	954	1959
Coral Harbour	1 175	137	1 487	1954	1 021	1959
Dawson	3 245	262	3 571	1950	2 787	1959
Embarras	3 861	282	4 145	1953	3 180	1959
Ennadai Lake	1 979	294	2 483	1954	1 620	1950
Eureka	701	145	847	1954	417	1953
Fort Chimo	2 206	244	2 501	1955	1 787	1956
Fort Good Hope	2 908	259	3 214	1958	2 385	1959
Fort Nelson	3 848	241	4 206	1958	3 409	1959
Fort Providence ^a	3 383	...	3 663	1955	2 895	1959
Fort Reliance	2 465	376	2 924	1955	1 768	1959
Fort Resolution	3 176	266	3 571	1953	2 633	1959
Fort Simpson	3 476	211	3 777	1953	2 995	1959
Fort Smith	3 365	274	3 685	1955	2 806	1959
Fort Vermillion	3 716	241	4 117	1958	3 406	1959
Frobisher Bay	1 262	172	1 541	1955	1 073	1959
Gillam ^a	2 850	271	3 404	1955	2 519	1958
Goose Bay	3 463	230	3 811	1959	3 061	1956
Great Whale River ^a	2 333	...	3 244	1955	1 911	1958
Hay River	3 171	257	3 472	1952	2 573	1959
Holman Island ^a	1 100	...	1 660	1954	820	1959
Hopedale ^a	2 269	263	2 574	1951	1 823	1956
Indian House Lake	2 172	226	2 417	1952	1 693	1956
Isachsen	402	158	649	1958	136	1953
Island Falls	3 606	253	4 129	1955	3 271	1959
Knob Lake	2 352	249	2 674	1954	1 840	1956
Mayo Landing	3 168	218	3 475	1953	2 816	1959
McMurray	3 776	261	4 102	1952	3 189	1959
Moosonee	3 611	362	4 365	1955	3 053	1950
Mould Bay	422	165	691	1958	129	1953
Nitchequon	2 629	331	3 075	1954	2 148	1956
Norman Wells	2 996	244	3 354	1958	2 531	1959
Nottingham Island	928	129	1 131	1958	780	1959 &
Port Harrison	1 677	362	2 293	1954	1 288	1959
Port Radium	2 220	341	2 799	1954	1 582	1959
Resolute	536	159	888	1958	322	1955
Resolution Island	552	82	686	1958	429	1959
Snag	2 859	222	3 158	1951	2 502	1955
Spence Bay ^a	973	...	1 150	1958	833	1959
Teslin	2 991	274	3 354	1957	2 568	1955
Trout Lake	3 208	330	3 896	1955	2 755	1950
Wabowden	3 553	258	4 068	1955	3 250	1950
Watson Lake	3 388	263	3 683	1953	2 965	1959
Whitehorse	3 271	263	3 607	1957	2 865	1955
Yellowknife	3 079	255	3 354	1955	2 483	1959

^aPeriod of record less than ten years

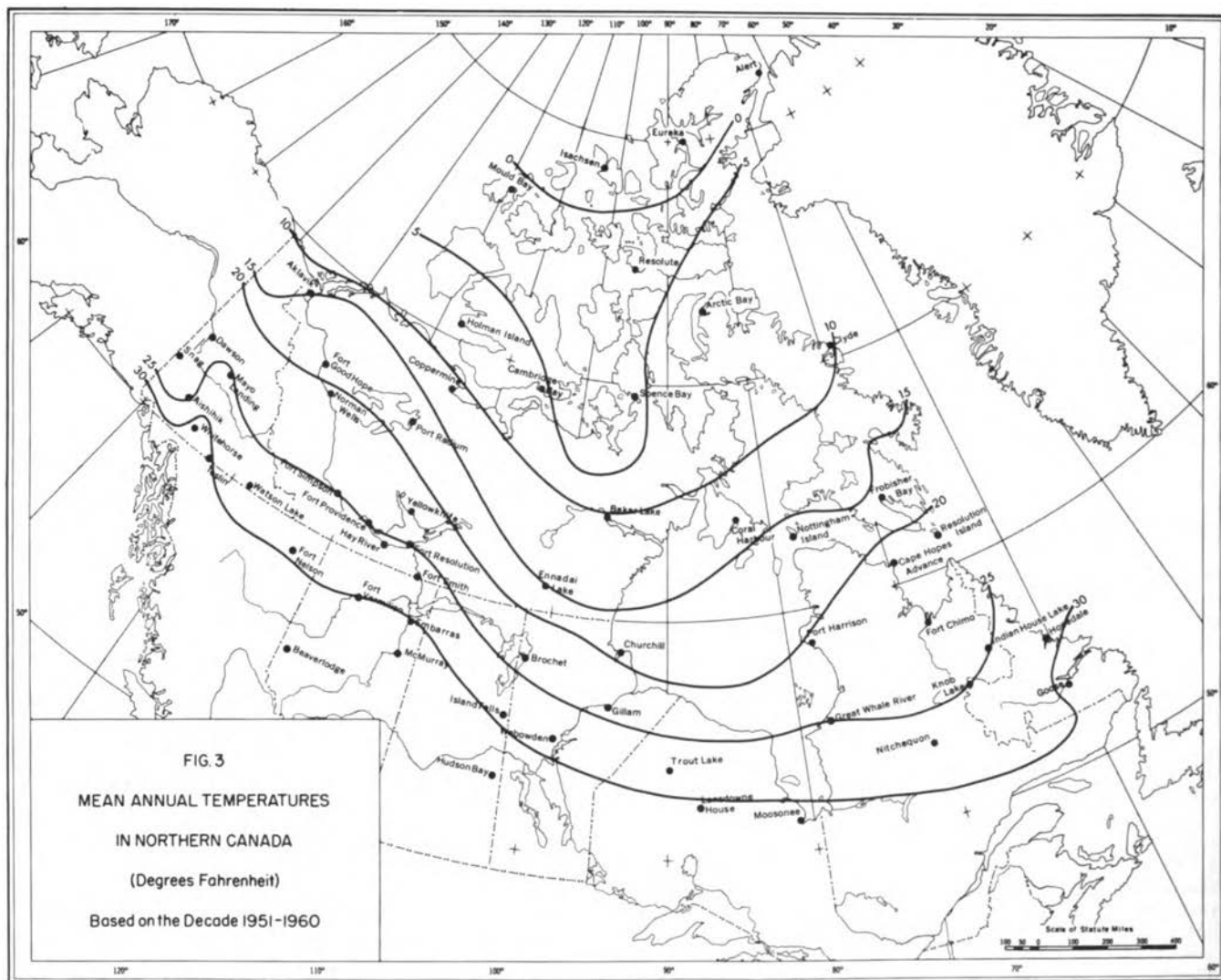

FREEZING SEASON AIR TEMPERATURES

Average dates for the start of the freezing and thawing season are charted (Figs. 6 and 7). Examination of the maps reveals that over the northern islands of the Archipelago the autumn freezing season starts about September 1, moves southward following periodic cold-air outbreaks, and reaches the southern limits of the sub-Arctic by October 20. During the decade, the earliest and latest dates were about plus or minus ten days at most stations. The delaying influence of ice-covered Hudson Bay, on the start of the thawing season, is immediately apparent. The thawing season in this area is only ten days earlier than in the high Arctic and about six weeks later than at the same latitude 700 miles further west.

The mean daily temperature map for January (Fig. 1) is shown as being typical of air temperature patterns during mid-winter months. In most areas of Canada, including the sub-Arctic, January is the coldest month of winter; but in the Arctic regions, February is colder. The main features of the chart are the cold center near northern Ellesmere Island (where mean daily temperatures are lower than -30°F) and the broad southward extension of the -25°F isotherm which delineates a large portion of the continental interior west of Hudson Bay. The tempering influences of open water and thin ice-cover over Lancaster Sound, Hudson Strait, and the east shores of Hudson Bay show up as areas of abnormal warmth.

Cold temperatures prevail along the Mackenzie River and over most of the Yukon, although mean values are nearly ten degrees higher than the mean daily January temperatures in the

Ellesmere Island cold center. Extremes of minimum temperature are very low in the Yukon and along the Mackenzie River and include -81°F at Snag, the lowest reported air temperature in North America. In contrast, extreme minima at most Arctic stations are from -55° to -65°F . In that section of the north-land, south of lat 60°N , mean temperatures correspond more closely with latitude although the general NW-SE orientation of the equal temperature lines is still apparent.

As the freezing index is a measure of combined duration and magnitude of below-freezing temperatures, it includes many degree-days from the mid-winter months. Comparison of Figs. 1 and 4 shows remarkable similarity in pattern over the Arctic Islands and in the northern continental interior. The dominating cold center over northern Ellesmere Island and its extension to the northern mainland is a feature of both maps. Eureka, the coldest station in Canada during most of the winter months, also has the highest freezing index. The southward bulge of cold air into the Barren Lands west of Hudson Bay (Fig. 1) is considerably flattened in Fig. 4, where account is taken of the shorter freezing season and the higher temperatures during the spring and fall transition months. The influence of the length of the freezing season on the freezing index is further illustrated by the areas of lower indexes along the Mackenzie River, in a section of northwestern Canada where mid-winter temperatures are low.

The freezing indexes, along the east coast of Hudson Bay, demonstrate the influence on the cumulative degree-days of the open-water months of October, November, and December. While Fig. 1 shows only five degrees difference between

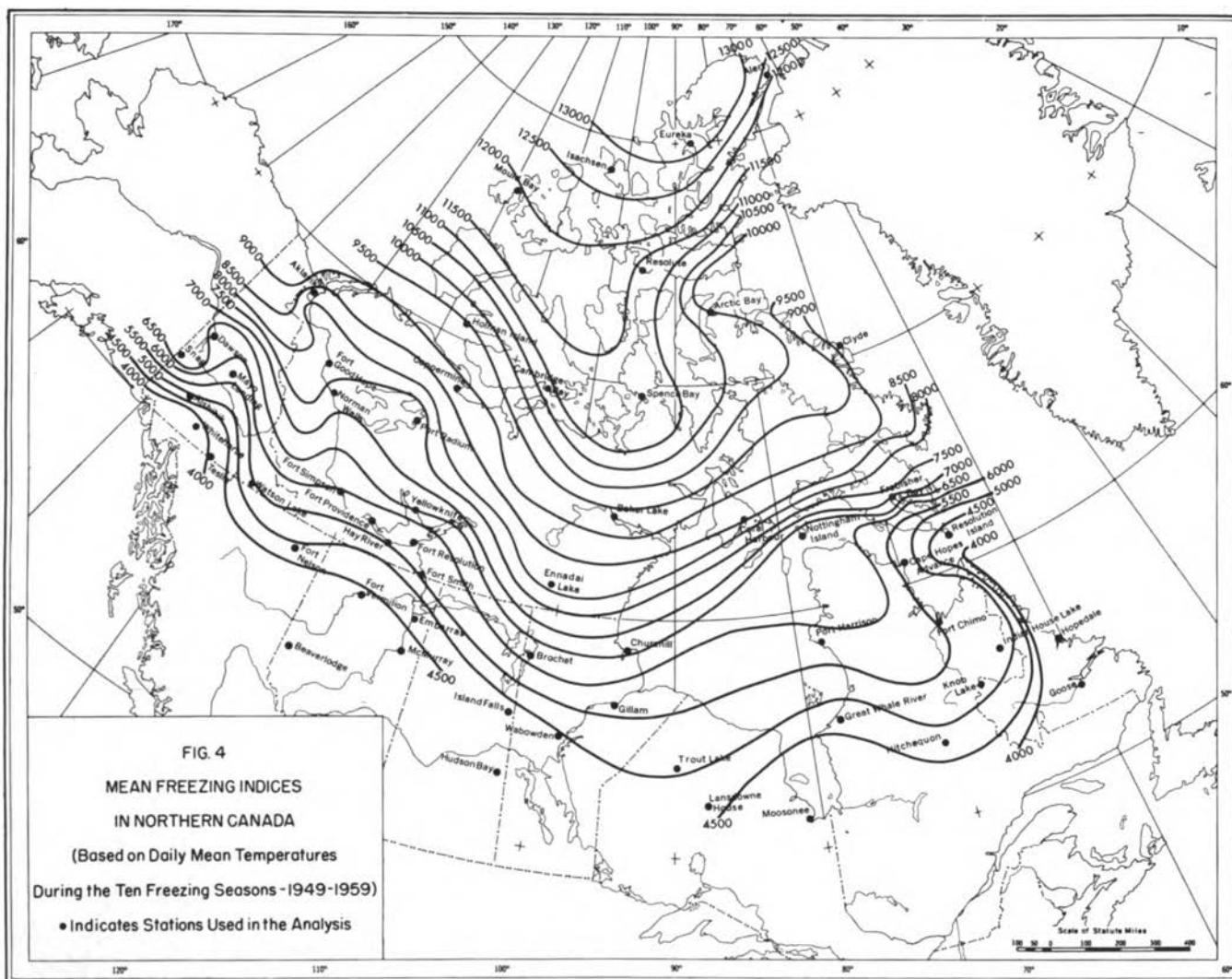

Churchill and Port Harrison, the average freezing index is nearly 1000 degree-days higher at Churchill than at Port Harrison. (The difference is only two degrees in February and March when Hudson Bay is frozen over.)

There is considerable year to year variation (Tables I and II) in the freezing index, with the greatest range occurring at stations in the Yukon.

THAWING SEASON

The patterns of the maps in Figs. 2 and 5 are remarkably similar.

Over the Arctic Islands, where temperatures in summer are controlled by the presence of ice-chilled waters and where the length of the thawing season varies only a few days with latitude, thawing indexes and mean daily temperature are closely related during a typical summer month (July). Mean daily temperatures average from 40° to 45°F, and thawing indexes range from 500 to 1000 degree-days.

Along the 50°F isotherm (Fig. 2), which extends from the Mackenzie Delta to Baker Lake thence to southern Hudson Bay and Ungava Bay and coincides approximately with the northern limit of tree growth, thawing indexes average about 1500 degree-days. North of this line, the climate in summer is maritime in character and temperature maxima range from 60° to 65°F. On the other hand frost may occur during any month of the short summer.

The familiar southeasterly trend of the temperature pattern from the Mackenzie River Delta at the Arctic Ocean to James

Bay in Ontario is due mainly to the heating of the northwest land masses, during long daylight hours, and the cooling influence on large areas of northeastern Canada by the cold waters of Hudson Bay. In this subarctic climatic zone mean daily July temperatures of 55° to 60°F can be expected. While temperatures reach 85°F during most summers, they do on occasion touch 95°F.

In general, the thawing indexes closely follow the July temperature distribution in the subarctic and range from 2000 to 3000 degree-days. Since the Mackenzie River basin has relatively higher summer temperatures as well as longer thawing seasons, than at similar latitudes east or west, thawing indexes at stations along the waterway are higher.

CONCLUSION

Less involved methods, such as the use of mean monthly temperatures or consideration of mean annual temperature and annual temperature amplitude, may be used to approximate freezing and thawing indexes at each station. However, calculations using mean daily temperatures give more accurate results and provide additional information, during specified periods, of the thawing and freezing seasons. For example, the time-summation tabulation of degree-days (with respect to 32°F) or the time-summation-curve slope during specified periods indicate accumulation of rate, and consequently, frost penetration or retreat rate.

Probabilities of any given number of degree-days being exceeded may be computed for each station using the mean

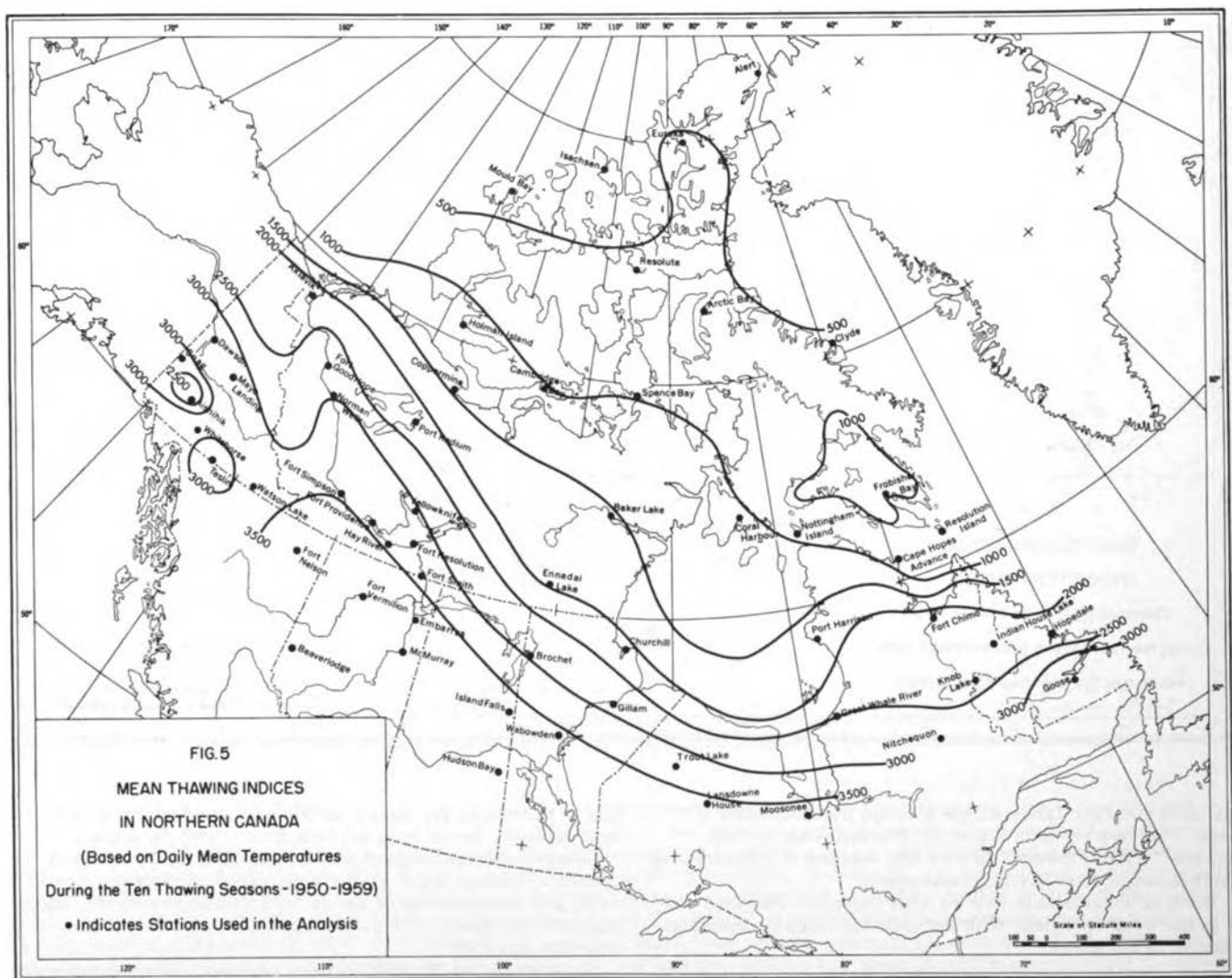

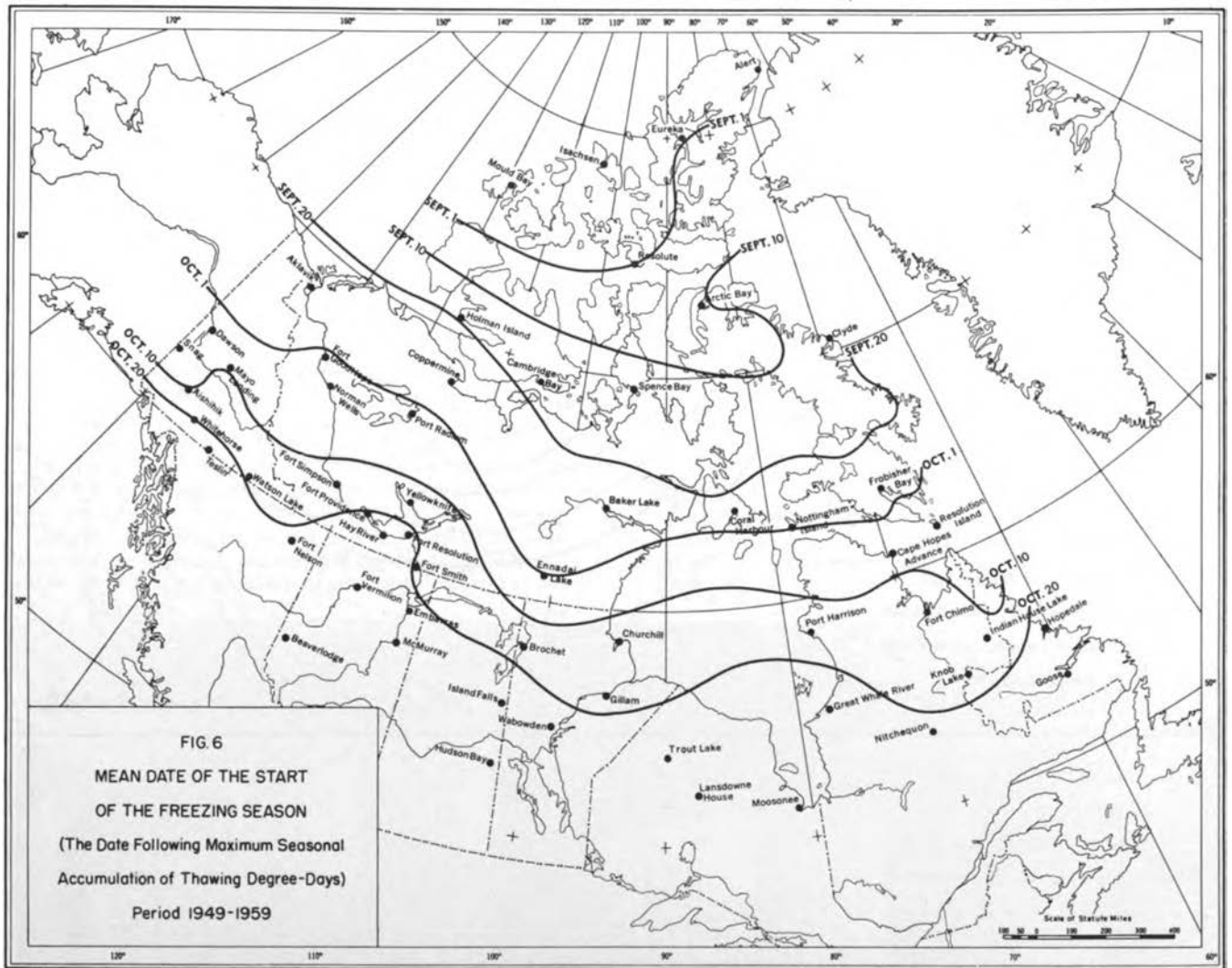

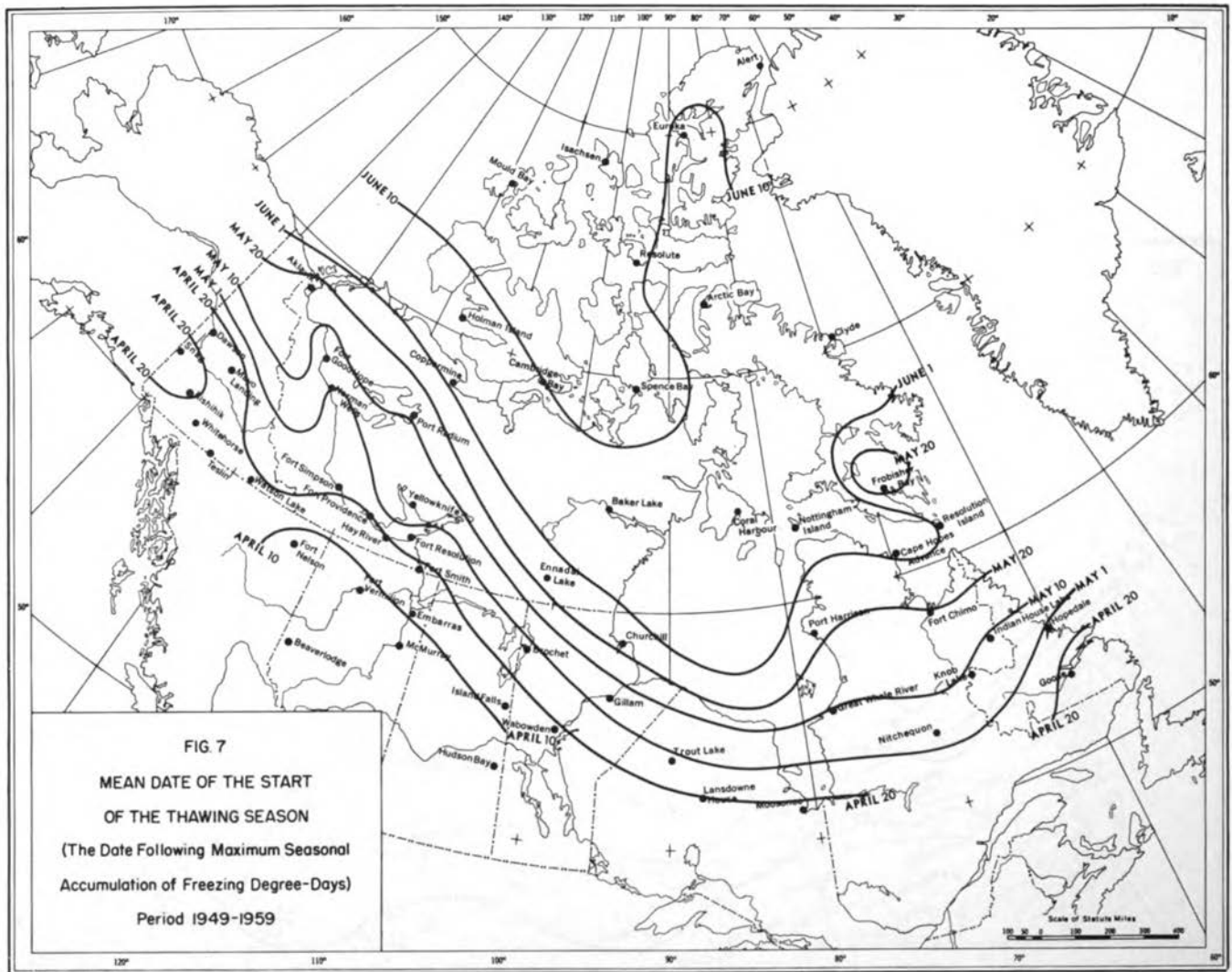

FIG. 7
 MEAN DATE OF THE START
 OF THE THAWING SEASON
 (The Date Following Maximum Seasonal
 Accumulation of Freezing Degree-Days)
 Period 1949-1959

values and standard deviations of the indexes listed in Tables I and II.

ACKNOWLEDGMENTS

The author is indebted to B.S.V. Cudbird and staff, Data Processing Section, for the machine analysis of the degree-day data, and to G. R. Kendall—all of the Climatology Division.

REFERENCES

[1] R. F. Legget, H. B. Dickens, R. J. E. Brown. "Permafrost Investigations in Canada," *Geol. of the Arctic*, Vol. 11, 1961, pp. 956-969.
 [2] C. B. Crawford. "Soil Temperatures, A Review of Published Records." NAS-NRC, *Highway Res. Bd. Spec. Rept. No. 2*, Jan. 1951, pp. 17-41.
 [3] C. B. Crawford, R. F. Legget. "Ground Temperature Investigations in Canada," Canada Natl. Res. Coun., Div. of Bldg. Res., *Paper No. 33*, Dec. 1955.
 [4] G. A. Sebastyan. "Department of Transport Procedures

for the Design of Pavement Facilities and Foundation Structures in Permafrost Subgrade Areas," First Canadian Conference on Permafrost, Natl. Res. Coun. of Canada, April 1962, pp. 167-206.

[5] Engineering Manual, Part 15, "Arctic and Sub-Arctic Construction," U.S. Army Corps of Engineers, Oct. 1954.
 [6] Harry Carlson. "Calculation of Depth of Thaw in Frozen Ground," NAS-NRC, *Highway Res. Bd. Spec. Rept. No. 2*, Jan. 1951, pp. 192-223.
 [7] R. J. E. Brown. "The Distribution of Permafrost and its Relation to Air Temperature in Canada and the USSR," *Arctic*, Vol. 13, No. 3, 1960, pp. 163-177.
 [8] John A. Pihlainen. "An Approximation of Probable Permafrost Occurrence," *ibid.*, Vol. 15, No. 2, June 1962, pp. 151-154.
 [9] H. A. Thompson. "Freezing and Thawing Indices in Northern Canada," First Canadian Conference on Permafrost, Natl. Res. Coun. of Canada, April 1962, pp. 18-36.

Published with the approval of the Director, Meteorological Branch, Dept. of Transport, Toronto, Canada.

COMPUTATION OF THE DEPTH OF FREEZING AND THAWING IN SOILS

V. S. LUK'YANOV, All-Union Scientific Research Institute of Transport Construction, USSR

Although basic laws of heat conduction are known and corresponding differential equations can be written, solving these equations with the complicated interrelation of all the parameters to the function itself—to the thermal regime—is assumed practically impossible even if the most advanced computing techniques are applied.

Soil is assumed to be a nonhomogeneous porous medium, the pores being filled with constantly moving liquids and gases. In this medium, dependent on change of temperature and movement of liquids and gases and on the change of their physical state, some heat sources and sinks occur; volumetric heat capacities, thermal conductivity, pattern and texture, as well as anisotropy are continually changing. All these changes in their turn influence heat transfer. Furthermore, the mass of soil may have a very complicated geometry and be influenced on boundaries by the thermal effects of rocks, air, sun and other radiation, ground water, and structures.

Calculating the soil thermal regime, put in such a way, seems to be rather difficult. Even for a relatively simple calculation of a one-dimensional process in a semi-infinite space, we must decide what kind of simplification is allowable, and how to carry out calculations, say, for predicting the natural soil thermal regime during one year for a permafrost area.

An answer to these basic problems was obtained by comparing results of field observations on thermal conditions with those computed by using a hydraulic integrator.

In 1934, at the All-Union Research Institute for Railway Construction, Moscow, the author proposed a hydraulic device, based on the principle of analogs, designed to solve

various problems of heat conduction. (The author received a number of author's certificates on applications made in 1934-1935.) Subsequently, this device was named "hydraulic integrator," for it helped solve problems of a much wider range. The method of hydraulic analogs and devices based on it are used successfully in the USSR for solving one-, two-, and three-dimensional problems in many technical fields [1 to 6].

The method consists of programing the process of water level changes in a system of vessels similar to the change of an unknown function such as temperature. Observations and records on the water level in the vessels solve the problem.

The method of computing by hydraulic integrator is based on an exact mathematical analogy between the process of water movement in integrator vessels and heat flow by conduction in the ground, when certain assumptions are made.

Space is considered in terms of finite differences, and time—as changing continuously.

The character of physical processes, computed by hydraulic analogs is defined by the following partial differential equation.

$$e \frac{\partial T}{\partial \tau} = \frac{a}{ax} \left(\alpha \frac{\partial T}{\partial ax} \right) + \frac{a}{ay} \left(b \frac{\partial T}{\partial ay} \right) + \frac{a}{az} \left(c \frac{\partial T}{\partial az} \right) + F \quad (1)$$

where

T is the unknown function; e.g., temperature, heat, concentration

x, y, z, τ are independent variables; i.e., the three space coordinates x, y, z and time, (τ)

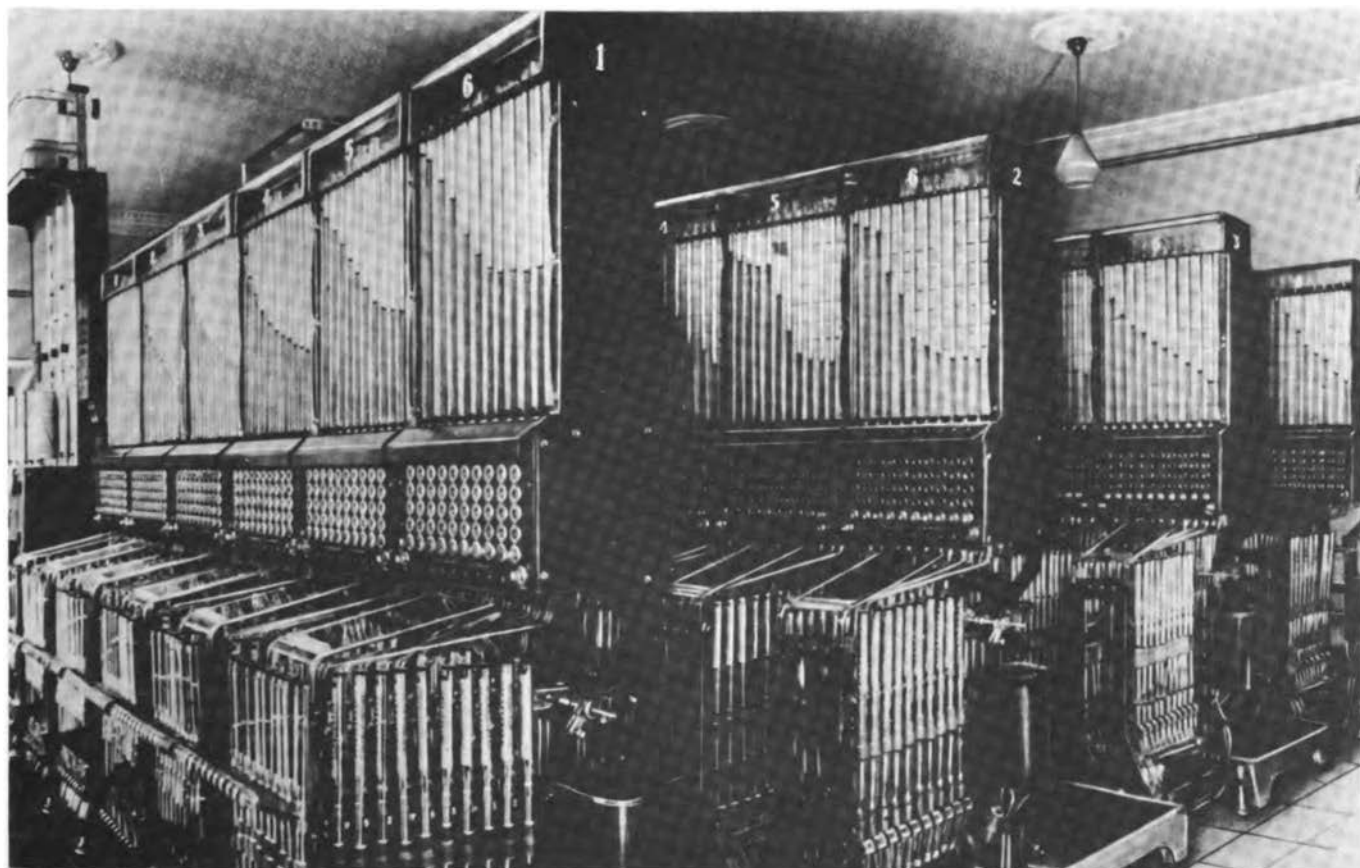

Fig. 1. Luk'yanov's hydraulic integrator (analog computer) for solving 3-dimensional problems

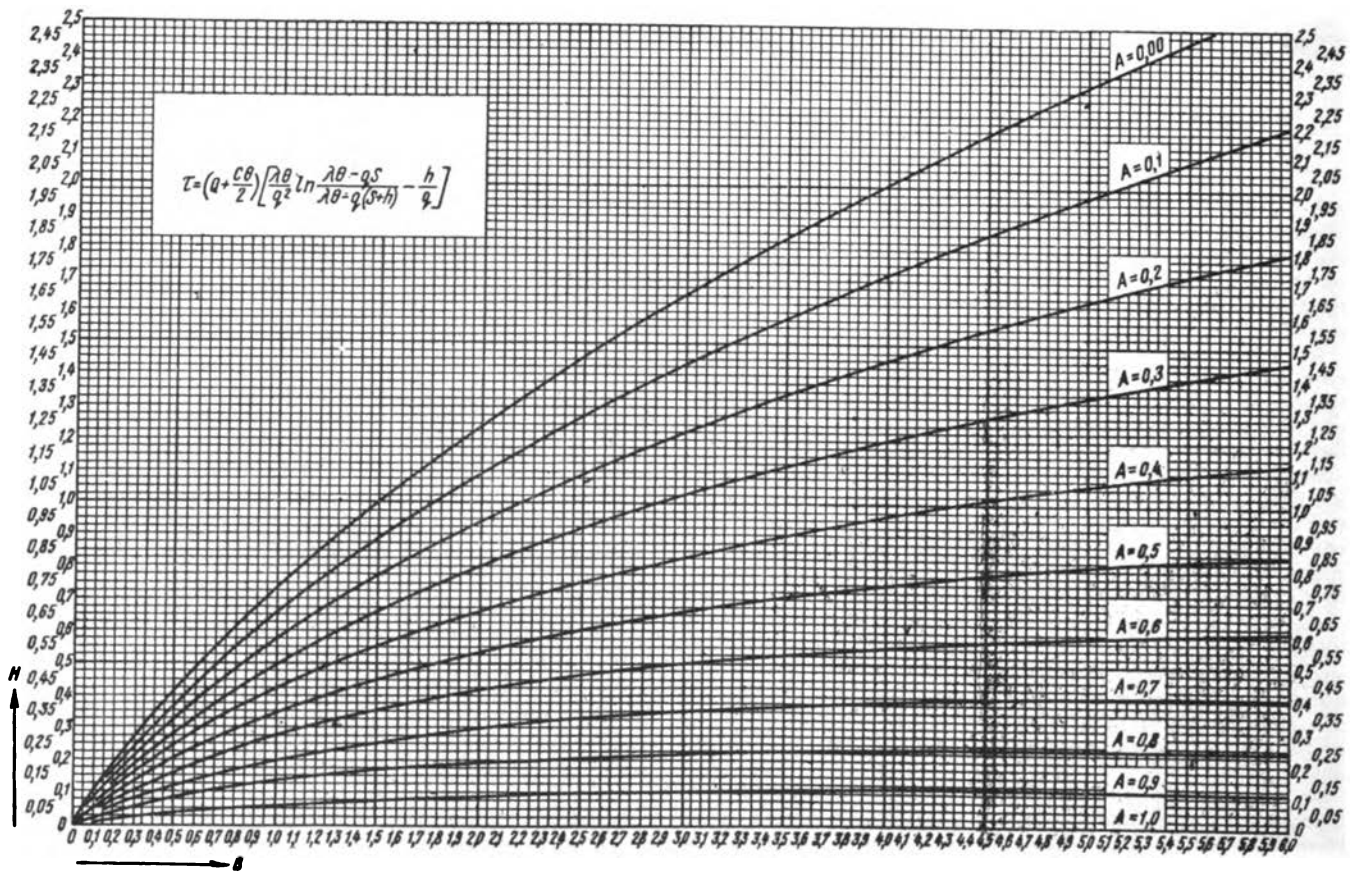

Fig. 2. Nomograms for determining depth of frost

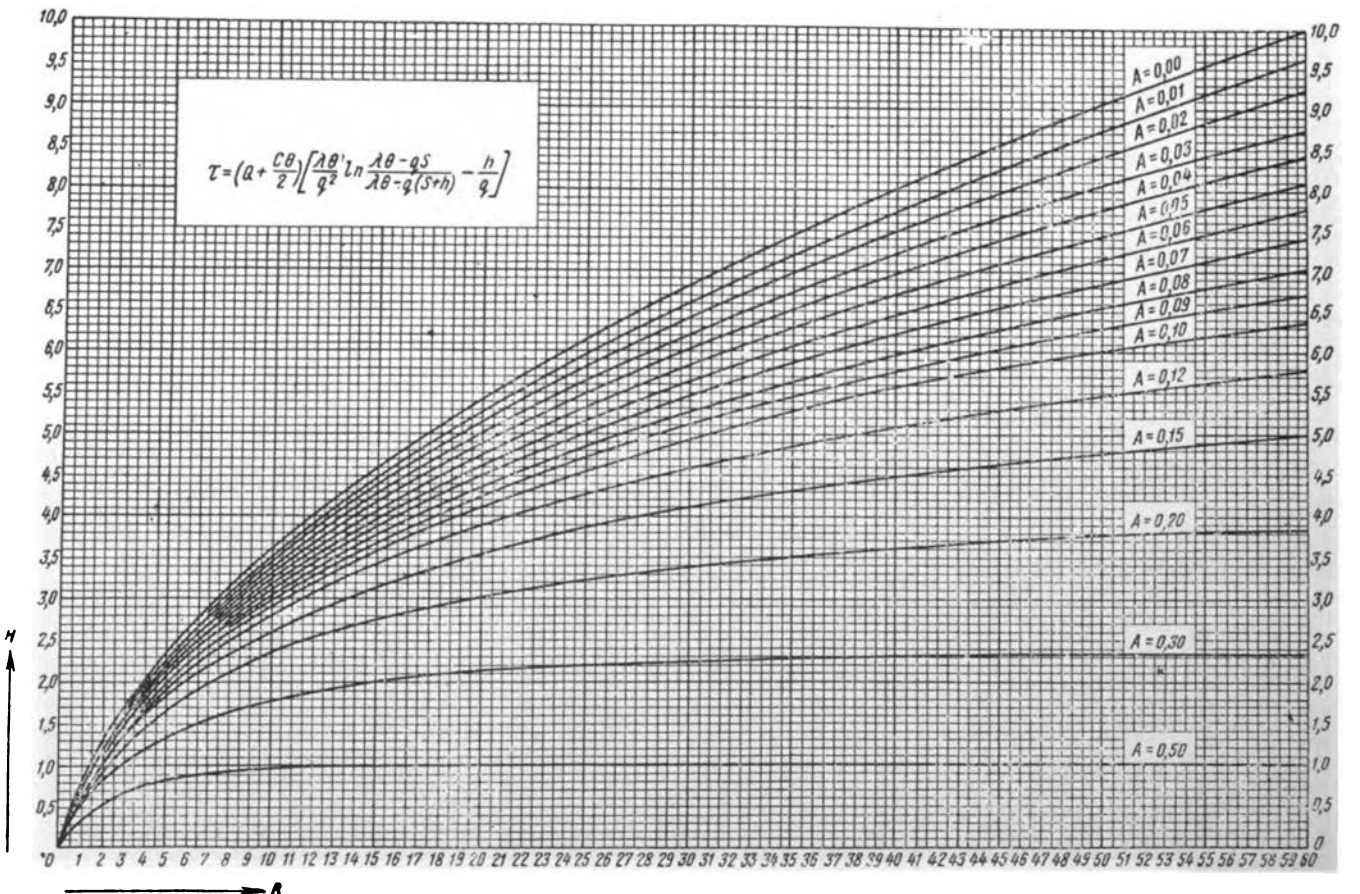

Fig. 3. Nomograms for determining depth of frost

e, a, b, c are known positive functions of x, y, z and sometimes of T and τ ; i.e., physical characteristics of the medium
 F is a known function of x, y, z, τ and sometimes of T ;
 i.e., internal sources

In 1937-1939, results of field observations of soil temperature changes were compared with those computed by the first integrators applying simplifying assumptions. Data of field soil temperature changes were analyzed at various depths in the course of a year in areas with and without permafrost.

Simplifying assumptions follow: (1) Soil is homogeneous; (2) thermally active water, (W in kg/cu m, is constant (i.e., the quantity of freezable water is not influenced by temperature change); (3) water freezes and thaws in soil at zero temperature, and the latent heat of fusion is equal to 80 kcal/kg; (4) heat capacity and thermal conductivity depend only on the frozen or thawed state of soil, and change stepwise passing zero.

On these assumptions, values of moisture content (W) and thermal conductivity (λ) were selected for thawed and frozen states separately, which allowed the reproduction of observation data on temperature behavior at various depths during one year by the hydraulic integrator with satisfactory accuracy.

By comparing results of computation and field observations, it was shown that if we could introduce in a certain way some average parameter values, we should be able, using these simplified assumptions, to obtain results sufficiently accurate for solving many engineering problems. This important conclusion has been constantly confirmed by practice.

At present, we apply the method of hydraulic analogs, using improved apparatus (Fig. 1).

Calculation for the hydraulic integrator can be made more complicated, if necessary, to attain closer similarity with natural conditions. For instance, by changing the vertical cross-sectional area of hydrointegrator vessels, we can consider a progressive freezing of water in the soil with lowering

temperature [4, pp. 139-143]; or by introducing sources and sinks, we take into account the heat transfer in ground due not only to heat conduction, but also to percolation of ground water. From the point of view of extending our knowledge about real thermal processes occurring in the ground, the possibility of solving the so-called "reverse problems" with the aid of hydrointegrators (the possibility of analyzing the field data in a way that allows us to define more precisely the initial assumptions and the parameter design values in various conditions) is of great value.

In many cases, however, we need to solve not the complete heat transfer problem, but the simpler one of finding the depths of frost or thaw in specific conditions. In such a case, it is desirable to obtain the answer by the simplest methods available, without special devices. Such a problem we meet, for instance, on earthwork in the winter, developing measures against frost heave on roads, determining allowable depths of embedding pipelines or foundations, etc.

For calculating the depth of soil freezing, we improved on the equation derived by Krylov, of the Institute of Construction on Frozen Soils [7, 8]. Krylov's equation is essentially an improved form of Stefan's equation or, to be more exact, the equation of Zaalschütze.

The suggested formula [4, 9] (symbols are somewhat different in [4]) is expressed as

$$\tau = \left(Q + \frac{C\theta}{2} \right) \left(\frac{\lambda\theta}{q^2} \ln \frac{\lambda\theta - qS}{\lambda\theta - q(h+S)} - \frac{h}{q} \right) \quad (2)$$

In (2), all the main factors determining the process of soil freezing are considered. It relates duration of freezing (τ) in hours, to the depth of freezing (h) in meters, difference of temperature (θ) in degrees, thermal conductivity of frozen ground (λ) in kcal/m deg-hour, volumetric heat capacity

of frozen ground (C) in kcal/cu m deg, volumetric latent heat of fusion, (Q) in kcal/cu m, heat flow from underlying strata (q) in kcal/sq m-hour, and, at last, to a factor (S) in meters,

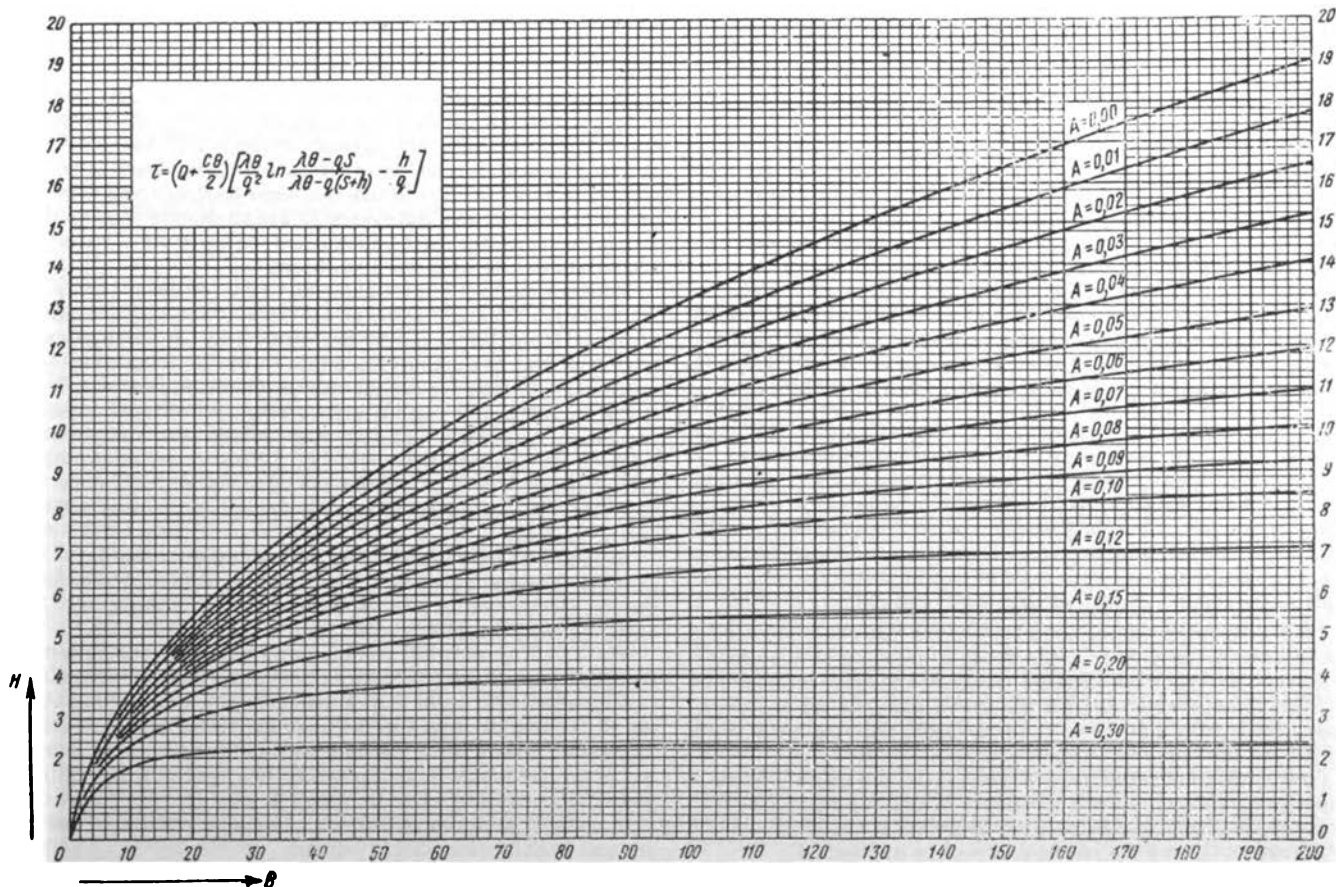

Fig. 4. Nomograms for determining depth of frost (continued)

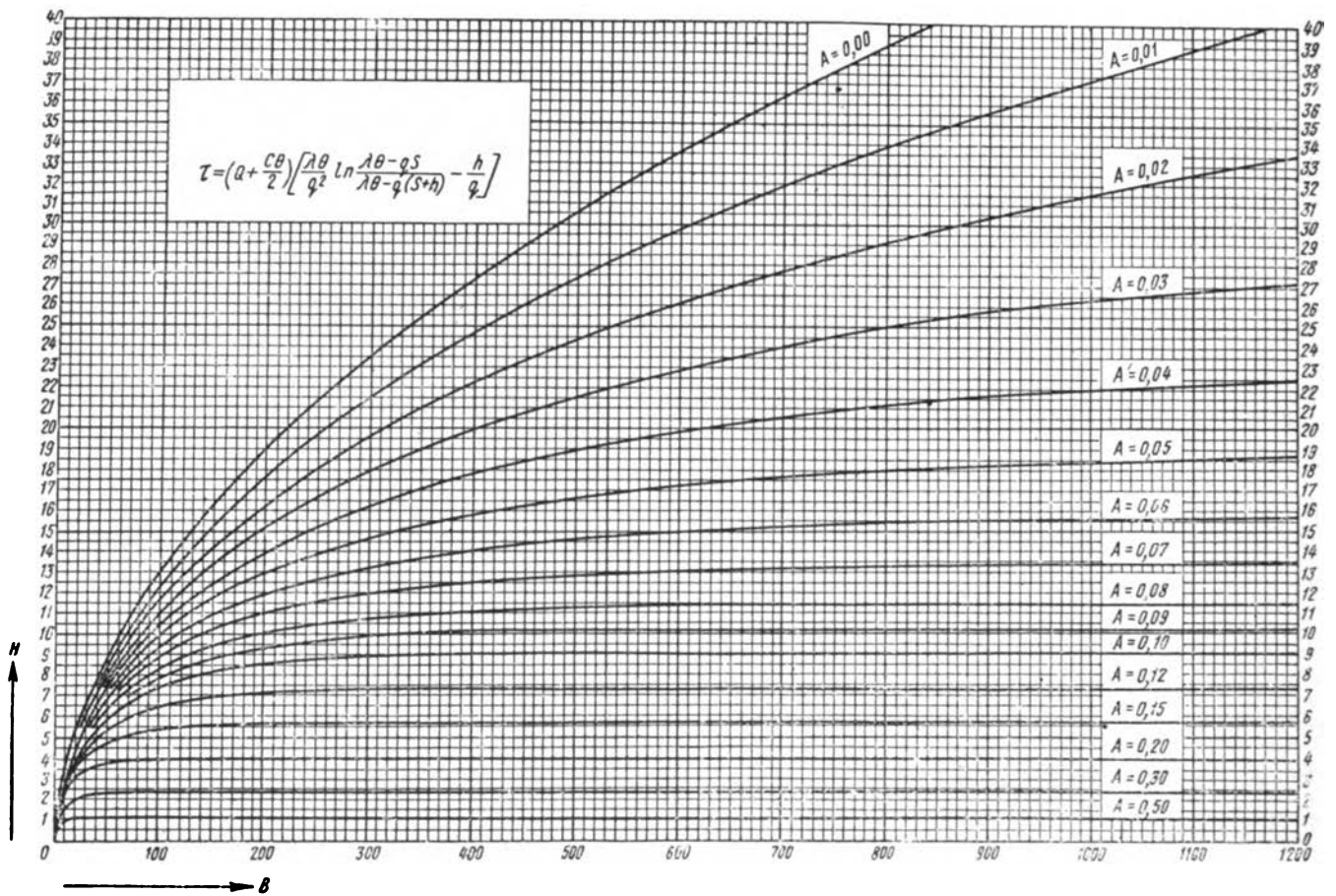

Fig. 5. Nomograms for determining depth of frost (continued)

which represents the depth of an assumed ground layer with thermal resistance equal to that of a heat insulating layer on the soil surface: Snow, straw, and so on.

The process of deriving (2) is given in [4] and [9]. It is based on the simplifying assumption that temperature distribution in the frozen layer at any moment corresponds to that of steady heat flow. This assumption is generally erroneous; but, as shown by comparative calculations on the hydro-integrator, its effect on the result is generally negligible.

Because (2) is rather inconvenient for practical calculations, M. D. Golovko of the All-Union Research Institute for Railway Construction [4] developed nomograms (Figs. 2-5) for this equation that make it easily usable. These nomograms show the relationships of dimensionless values A, B, and H.

where $A = \frac{qs}{\lambda\theta}$

$$B = \left(\frac{\lambda\theta}{S^2} \right) \left(\frac{\tau}{Q + \frac{C\theta}{2}} \right)$$

and $H = \frac{h}{S}$

The nomograms can be used for solving various problems. To determine, for example, the depth of freezing at a moment (τ), when soil thermal characteristics and thermal resistance of surface heat insulation are given, values of A and B are calculated; from A and B on the nomograms we obtain the value of H, and the unknown value h equals HS.

Using these nomograms, we may easily and quickly solve practical problems relating to effects of various factors and develop measures to control frost penetration.

Equation (2) and the nomograms can be applied [4, pp. 91-108] in more difficult cases of calculating soil freezing, considering changes of thermal factors related to

time and depth.

We solved the problem of computing depths of soil freezing to be included in the Building Code by considering diverse conditions over the broad territory of the USSR [4]. For defining maximum depth of soil freezing during the winter period, it was feasible to use the same formulas and nomograms. First, it was necessary to define factors responsible for maximum winter frost penetration; seven factors were stated—three climatic and four thermal.

Climatic factors are (1) duration of winter season (τ); (2) average difference between air temperature and temperature of freezing soil water during the winter (θ); (3) average winter heat flow from the underlying strata to the frost boundary (q).

Thermal factors are (1) the average thermal surface resistivity for the winter period, also taking into account a heat insulating layer such as snow, represented by the equivalent depth of an assumed soil layer (S); (2) volumetric heat capacity of frozen soil (C); (3) thermal conductivity of frozen soil (λ); (4) latent heat of fusion, determined by thermally active water.

Duration of winter season is defined by the monthly average temperature curve. The average difference between the temperature of air and that of freezing soil water is obtained from the same curve.

For simplifying calculations, maps with isolines over the European part of the USSR were compiled. They present duration of winter (τ), mean winter temperature (θ) for a case of water freezing at zero, and the average winter heat flow (q), from underlying strata [4]. The map with isolines for heat flow is based on computations performed by the hydraulic integrator and studies of many climatic data [4, pp. 69-77]. Heat flow from underlying strata is a result of summer heating of the ground; it decreases during winter.

When checking our method for determining maximum frost depth, many comparative calculations were performed using

the equations (with nomograms) and hydraulic integrator; these were also compared with field observations. The results permitted us to recommend this approximate method with confidence for many practical purposes.

The same method and equations can be applied for calculations in soil thawing. In this case, it is essential to consider solar radiation. This is done by introducing a correction to the design air temperature (t_p). While sun radiation, q_R (kcal/sq m hour) is acting, the calculation process can be performed as usual, only substituting for the real air temperature

$$t'_B = t_B + \frac{q_R}{\alpha}$$

where α is the heat transfer coefficient of the soil surface [4, pp. 28-32]. It is quite evident that volumetric heat capacity and thermal conductivity should be considered for thawed soil; thermal surface resistivity should represent the real surface conditions, such as vegetation, etc.

Technical progress requires solutions for more and more complicated problems of heat transfer from soil to different structures and arrangements. In these cases, studies and calculations are performed mostly by hydraulic integrators. By applying hydraulic integrators, complicated problems of heat transfer as a simultaneous effect of heat conduction and moving ground water are solved [6]. Ground water flow can be calculated analytically, by electrical analogs or by hydraulic analogs.

Further analyses of field observations should be compared with reverse problems solved by hydraulic integrator. Thus, calculation assumptions would be improved and safer prognoses would follow, based on proved assumptions and values of parameters obtained from field observations.

The method of hydraulic analogs is widely practiced in our country for it is simple, clear, flexible, and available to the personnel of various engineering branches.

REFERENCES

[1] V. S. Luk'yanov. "Engineering Computations by

Luk'yanov's Hydraulic Devices," Transjeldorizdat, Moscow, 1937.

[2] V. S. Luk'yanov. "Hydraulic Devices for Engineering Computations," Izvest. Akad. Nauk SSSR, Otd. Techn. Nauk, No. 2, Moscow, 1939.

[3] V. S. Luk'yanov. "Application of Hydraulic Analogies to Scientific Investigations," (J.) Technika Dzheloznykh Dorog, No. 7, 1946.

[4] V. S. Luk'yanov, M. D. Golovko. "Computation of Depth of Frost Penetration in Soils," Trudy Vses. Nauch.-Issled. Inst. Transportnogo Stroitelstva, Vyp. 23, Transjeldorizdat, Moscow, 1957.

[5] V. S. Luk'yanov, M. A. Veviorovskaya. "Application of Hydraulic Analog Method for Studying the Ground Water Filtration Process," Doklady k Sobraniyu Mezhdunarodnoi Assotsiatsii Hidrogeologov, Moscow, 1960.

[6] V. S. Luk'yanov. "Application of Hydraulic Analog Method for Computing the Thermal Regime Taking into Account Heat Transfer by Filtration Moisture Flow. Derivation of Similarity Criteria," Indzhenerno-Fizicheski Zhur., Vol. 5, No. 2, 1962.

[7] M. M. Krylov. "On the Thermal Analysis of Soil Freezing," Vestnik Inzenerov i Technikov, No. 1, 1934, p. 466.

[8] M. M. Krylov. "Accumulation of Cold in the Ground for Decreasing Aridity," Vestnik Melioratsiiai Hidrotehnika, No. 1, 1940, pp. 57-73.

[9] M. N. Goldstein, V. S. Luk'yanov, B. I. Nechaev, V. P. Ponomarev. "Construction of Roadbed During the Winter Period," Transjeldorizdat, Moscow, 1946, pp. 21-52.

[10] V. S. Luk'yanov. "Calculs et Recherches Concernant les Phénomènes Physiques dans les Sols et les Ouvrages à l'Aide des Integrateurs Hydrauliques, par la Methode des Analogies," Proc. 5th Intl. Conf. Soil Mech. and Found Engr., Vol. 3, Dunod, Paris, 1962, p. 383.

[11] F. Scott Ronald. "An Hydraulic Analogue Computer for Studying Diffusion Problems in Soil," Geotechnique, No. 2, London, June 1957.

TEMPERATURE FIELDS IN FOUNDATIONS

G. V. PORKHAYEV, V. A. Obruchev Permafrost Research Institute, Moscow

Determining temperature fields in foundations is important in finding optimum solutions when erecting structures on permafrost. Two main types of temperature fields are known. The first is characterized by a thawed bowl (as the structure is in use, the ground gradually thaws under its foundation). The second is characterized by a seasonally thawed layer (while the foundation remains frozen during operation).

Determining temperature fields in freezing and thawing soil with specific conditions of latent heat of fusion is a difficult problem of mathematical physics. Mathematical difficulties made it necessary to find easier ways.

When moist soil thaws, the maximum amount of heat is consumed in changing the phase composition of the water. The interface between frozen and thawed soil usually moves very slowly. As a result, the temperature field in a thawing soil layer is, at any given moment, nearly steady, so that the non-steady nature of the process may be regarded as a continuous transition from one steady state to another. This method in which the liquid movement at any given time is assumed to be steady, whereas its boundary is slowly moving, is widely used for solving many problems in hydromechanics.

K. E. Lemke was the first to use this principle (1886) [1], known in hydromechanics as the principle of successive changes of steady states. It was successfully applied to problems of melting and solidification by L. S. Leybenzon [2] when solving problems of liquid solidification in a clogged pipeline.

On the basis of this principle, many solutions are obtained to determine freezing-thawing depth in moist soils for one-dimensional processes [3]. These solutions are distinguished by different methods of determining boundary conditions, thermal capacity of the freezing or thawing soil, heat intake from thawed subsoils in case of freezing, and heat outlet into freezing subsoils in case of thawing.

Of two-dimensional problems, most developed are solutions for determining freezing time of a cylinder or changes in the radius of soil freezing-thawing around pipes [2, 4, 5]. Solutions are also found for a half-space whose surface carries a constant-temperature heater (strip or rectangular shape). These solutions are obtained by introducing empirical factors to one-dimensional solutions. They give the thawing depth under the center of the strip or rectangle or even along the entire width of the strip [6, 7, 8]. Until now the only analytic solution of a two-dimensional problem for half-space provided with a strip-type heater of constant temperature was S. S. Kovner's solution [9], published in 1933. All these solutions are based on the principle of successive change of steady states.

Kovner most clearly stated the main prerequisites for its application [9]: (1) Interfaces of a medium in thawed and frozen conditions are isothermal surfaces of steady-state temperature fields. (2) In thawed and frozen zones, temperature fields are described by the equations of steady-state temperature fields, with zone interface nonsteady.

In this case the thermal balance equation for the interface

of thawed and frozen zones (Stefan's condition) for two-dimensional problems is:

$$\int_s \left(\lambda_T \frac{\partial t_T}{\partial n} - \lambda_M \frac{\partial t_M}{\partial n} \right)_{z=\xi} ds = \sigma w \frac{dv(\xi)}{d\tau}, \quad (1)$$

and for three-dimensional problems

$$\int_V \left(\lambda_T \frac{\partial t_T}{\partial n} - \lambda_M \frac{\partial t_M}{\partial n} \right)_{z=\xi} dS = \sigma w \frac{dV(\xi)}{d\tau}, \quad (2)$$

where

t_T is thawed zone temperature, depending in a two-dimensional problem on x and z , and in a three-dimensional problem on x , y , and z

t_M is similar for frozen zone

λ_T, λ_M is coefficient of thermal conductivity in thawed and frozen medium, respectively

ξ is coordinate of zone interface

σ is latent heat of fusion of ice

w is quantity of ice in frozen medium

$v(\xi), V(\xi)$ is volume confined between outer boundary of thawed zone and melting surface for two- and three-dimensional problems, respectively

τ is time,

$\frac{\partial t}{\partial n}$ is derivative with respect to normal

Finding temperature distribution functions for thawed and frozen zones generally having rather intricate configurations, and solving (1) and (2) is a rather difficult matter. For instance, Kovner confined himself to such a solution of the problem when the half-space surface was given a constant temperature on a strip of width $2a$, $-a \leq x \leq a$, while the frozen zone temperature was zero.

Finding the temperature distribution functions for thawed and frozen zones by classical methods leads to this: It is necessary to consider two bodies having complex configurations of their boundary surfaces. For the frozen zone it is a half-space with a cavity whose surface is an interface of thawed and frozen zones. A zero or ice-melting temperature in the medium is present for this surface, while the half-space surface is given a temperature differing from zero.

To determine the temperature distribution function in the thawed zone, this distribution must be considered in the region confined by the interface of thawed and frozen zones with the surface temperature of zero (or of the ice melting temperature) and by a contour on which the thawed zone boundary condition is given.

Even with the zone interface predetermined, classical methods sometimes fail to find temperature distribution in thawed and frozen zones. Further operations (taking the derivative with respect to normal and, particularly, calculating a double integral in a two-dimensional problem and a triple integral in a three-dimensional problem with complex outlines of the zones) are possible only for simple cases. Therefore, it is proposed that temperature distribution functions in thawed and frozen zones be determined by using an auxiliary temperature and reducing multiple integrals to simple ones with the same initial conditions assumed by S. S. Kovner.

The frozen zone boundary is given a temperature (t_o); the thawed zone boundary is given a temperature (t_p). On the thawed-to-frozen zone interface, the temperature is zero and ice melts on the same surface. Temperature spread in each zone is quasi-stationary at any given moment, and is determined by the attitude of the interface and by the temperature on the zone boundary. So, the temperature on the frozen zone boundary has no direct effect upon temperature distribution in the thawed zone; it only affects the location of the zone interface. The same influence on the frozen zone temperature field is exerted by the temperature on the thawed zone boundary.

If no ice melting occurs on the zone interface, the law of

displacement on this surface is also valid. Under this condition, temperature distribution in the thawed zone is found. To comply with the law of displacement of the zone interface, a certain variable temperature must be maintained on the frozen zone boundary. The law of temperature changes must be such that zone interface displacement remains unchanged. This temperature can be called "auxiliary" since, as shown below, it does not occur in the final result. If there are two boundary conditions for any problem (one-, two-, and three-dimensional), the temperature distribution in the thawed zone is

$$t_T = t_{oB} + (t_p - t_{oB}) f(x, y, z) \quad (3)$$

where t_{oB} is auxiliary temperature on thawed zone boundary $f(x, y, z)$ is a certain function depending on the system configuration and t_T is zero on the interface.

Setting (3) equal to zero gives

$$t_{oB} = t_p \frac{f(x_o, y_o, z_o)}{f(x_o, y_o, z_o) - 1}$$

where x_o, y_o, z_o are coordinates of a certain point of the zone interface.

Temperature in the thawed zone is

$$t_T = t_p \frac{f(x_o, y_o, z_o) - f(x, y, z)}{f(x_o, y_o, z_o) - 1} \quad (4)$$

Temperature distribution in the frozen zone is

$$t_M = t_o + (t_{pB} - t_o) f(x, y, z) \quad (5)$$

where t_{pB} is auxiliary temperature on the thawed zone boundary.

If (5) for the interface equals zero, the following equation is obtained

$$t_{pB} = t_o \left[1 - \frac{1}{f(x_o, y_o, z_o)} \right]$$

Then, temperature in the frozen zone equals

$$t_M = t_o \left[1 - \frac{f(x, y, z)}{f(x_o, y_o, z_o)} \right] \quad (6)$$

On the basis of (4) and (6), final solutions may be obtained from conditions of (1) and (2) by simple methods.

For simplicity, an example was considered with two given temperatures: One for the thawed zone boundary, and the other for the frozen zone boundary. In a general case, different temperatures may be given for any number of sectors of zone boundaries. In such a case, n sectors on the boundary of one of the zones must correspond to n auxiliary temperatures on the other zone boundary.

In most applied problems, the temperature fields have planes of symmetry. For these, t_{oB} and t_{pB} are found, with $x = 0, y = 0$, and $z = \xi_o$ (three-dimensional problems), or $x = 0$ and $z = \xi_o$ (two-dimensional problems) where ξ_o is thawing depth in the plane of symmetry at any given moment. Besides, temperature gradients in thawed and frozen zones can also be determined, with $x = 0$ and $y = 0$, or with $x = 0$. then (1) and (2) are expressed by

$$\lambda_T t_p \frac{f'(\xi)}{f(\xi) - 1} - \lambda_M t_o \frac{f'(\xi)}{f(\xi)} = \sigma w \frac{d\xi}{d\tau}$$

Solution of this equation gives

$$\int_0^{\xi_o} \frac{f(\xi) - 1}{1 - q \left[1 - \frac{1}{f(\xi)} \right]} \frac{d\xi}{f'(\xi)} = \frac{\lambda_T t_p \tau}{\sigma w} \quad (7)$$

$$\text{where } q = \frac{\lambda_M t_o}{\lambda_T t_p}$$

Having determined ξ_o at time τ from (7), we find the configuration of the interface between thawed and frozen zones at

the same moment from (4) or (6), assuming t_T or t_M are zero
 $f(x, y, z) = f(\xi_0)$ (8)

If temperature on the boundary of the frozen zone is zero, then $q = 0$, and depth of thawing ξ_0 tends to infinity, with infinite τ . If value q is not zero, then the thawing depth tends to a certain limit ξ_{pr} , with infinite time. Evidently, if τ tends to infinity, then the subintegral function denominator in (7) must tend to zero. Thus, the expression for determining the thawing depth limit is

$$f(\xi_{pr}) = q_1 \quad (9)$$

where

$$q_1 = \frac{\lambda_M t_o}{\lambda_M t_o - \lambda_T t_p}$$

The equation of the interface of thawed and frozen zones is

$$f(x, y, z) = f(\xi_{pr}) \quad (10)$$

Temperature distribution functions in thawed and frozen zones at any time τ in compliance with (4) and (6) are equal to

$$t_T = t_p \frac{f(\xi_0) - f(x, y, z)}{f(\xi_0) - 1} \quad (11)$$

$$t_M = t_o \left[1 - \frac{f(x, y, z)}{f(\xi_0)} \right] \quad (12)$$

The distribution of temperatures in the thawed zone with $t_o = 0$ is also expressed by (11), since this distribution is determined only by temperature t_p and by location of the zone interface; any other value of t_o changes only the value of ξ_0 .

Temperature distribution in thawed and frozen zones, in the case of the thawing limit, is determined by (11) and (12), with $\xi_0 = \xi_{pr}$.

Several examples illustrate the application of this method.

Thawing of a soil mass bounded by plane x, y : On the mass surface a constant temperature (t_p) is maintained in strip, width $2a$, $-a \leq x \leq a$ from the moment of time ($\tau = 0$); temperature t_o outside the strip $\infty < x \leq a$ and $-\infty < x \leq -a$. Heat-conductance coefficients of thawed and frozen media differ.

Such conditions apply in finding the thawing depth and temperature fields in the foundation of a structure whose length is much greater than its width.

The steady-state field for a half-space in the case of a two-dimensional problem with a constant temperature (t_1) given on the strip $-a \leq x \leq a$ will have the form

$$t(x, z) = \frac{t_1}{\pi} \left(\arctan \frac{a+x}{z} + \arctan \frac{a-x}{z} \right) = t_1 f(x, z) \quad (12a)$$

or for the plane of symmetry $x = 0$

$$t(z) = \frac{2t_1}{\pi} \arctan \frac{a}{z} = t, f(z)$$

Then, the limiting depth of thaw in the symmetry plane is found from (9)

$$\frac{2}{\pi} \arctan \frac{a}{\xi_{pr}} = q_1$$

$$\text{from which } \frac{\xi_{pr}}{a} = \cot \frac{\pi}{2} q_1 = \varphi_1(q_1) \quad (13)$$

The graph of function φ_1 is shown in Fig. 1 (curve for $n = \infty$).

Coordinates of the interface limit of the thawed and frozen zones are found from (8)

$$\frac{1}{\pi} \left(\arctan \frac{a+x}{z} + \arctan \frac{a-x}{z} \right) = \frac{2}{\pi} \arctan \frac{\xi_{pr}}{a}$$

so, coordinate x of interface surface

$$x = \pm \sqrt{\frac{\xi_x}{\xi_{pr}} (\xi_{pr}^2 - a^2) + a^2 - \xi_x^2} \quad (14)$$

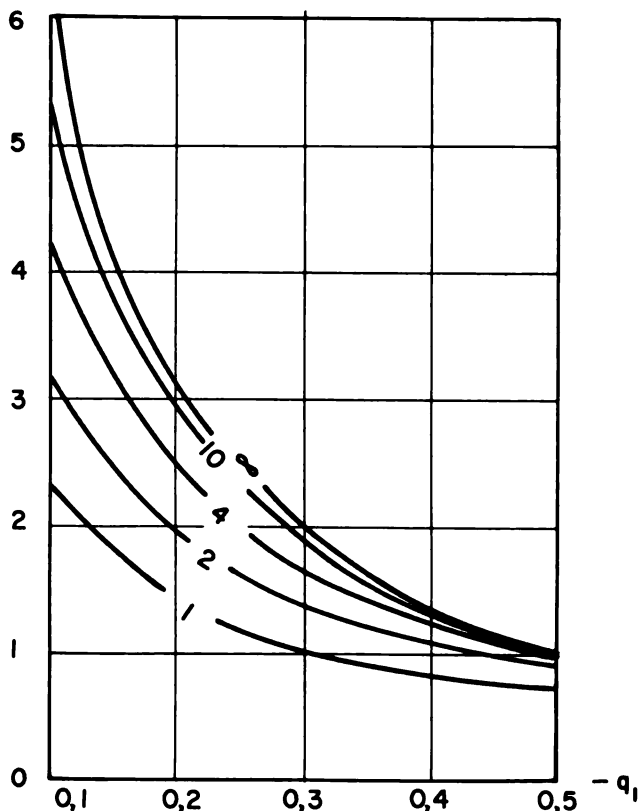

Fig. 1. foundation thawing limit under center of structure in two- and three-dimensional problems

where ξ_x is thawing depth at a distance $\pm x$ from the plane of symmetry.

Changes in thawing depth with respect to time in the plane of symmetry with $x = 0$ are found from (7) by inserting values of $f(z)$ and $f'(z)$ with $z = \xi_0$.

$$\int_0^{\xi_0/a} \frac{1 - \frac{2}{\pi} \arctan \frac{1}{u}}{1 - q \left(1 - \frac{2}{\pi} \arctan \frac{1}{u} \right)} (u^2 + 1) du = F_1 \left(q, \frac{\xi_0}{a} \right) = I_1 \quad (15)$$

$$\text{where } I_1 = \frac{2}{\pi} \frac{\lambda_T t_p \tau}{a^2 \sigma w}$$

The graphs of function F_1 are represented in Fig. 2 (curve for $n = \infty$).

Coordinates of the interface of the thawed and frozen zones at time (τ), similar to (14), are found from

$$x = \pm \sqrt{\frac{\xi_x}{\xi_0} (\xi_0^2 - a^2) + a^2 - \xi_x^2}$$

where ξ_0 is thawing depth with $x = 0$ at a moment of time.

Temperature distribution in the thawed zone is determined from (11):

$$t_T = t_p \frac{2 \arctan \frac{a}{\xi_0} - \left(\arctan \frac{a+x}{z} + \arctan \frac{a-x}{z} \right)}{2 \arctan \frac{a}{\xi_0} - \pi} \quad (16)$$

and, in the frozen zone, from (12):

$$t_M = t_o \left(1 - \frac{\arctan \frac{a+x}{z} + \arctan \frac{a-x}{z}}{\arctan \frac{a}{\xi_0}} \right) \quad (17)$$

Distribution of temperatures in the thawed and frozen zones, with the limiting position of the zone interface, is also found by (16) and (17), with $\xi_0 = \xi_{pr}$.

In applying this method for a three-dimensional problem, assume that temperature t_p is maintained from $\tau = 0$ on the half-space surface in the area $-a \leq x \leq a$ and $-b \leq y \leq b$ (the structure is rectangular, $2a \times 2b$, in plan). Beyond this area the temperature is t_0 . Coefficients of thermal conductivity of the medium in the thawed and frozen states differ.

When a constant temperature t_1 is maintained on a rectangular area located on the half-space surface, the temperature at any point of the half-space in a steady state, equals

$$t(x, y, z) = \frac{t_1}{2\pi} \left[\arctan \frac{(x+a)(y+b)}{z\sqrt{z^2+(x+a)^2+(y+b)^2}} - \arctan \frac{(x-a)(y+b)}{z\sqrt{z^2+(x-a)^2+(y+b)^2}} - \arctan \frac{(x+a)(y-b)}{z\sqrt{z^2+(x+a)^2+(y-b)^2}} + \arctan \frac{(x-a)(y-b)}{z\sqrt{z^2+(x-a)^2+(y-b)^2}} \right] = t_1 f(x, y, z)$$

For the axis of symmetry, with $x = 0, y = 0$

$$t(z) = \frac{2t_1}{\pi} \arctan \frac{ab}{z\sqrt{z^2+a^2+b^2}} = t_1 f(z) \quad (17a)$$

The depth of thawing limit on the axis of symmetry is found from (9)

$$\frac{2}{\pi} \arctan \frac{ab}{z\sqrt{z^2+a^2+b^2}} = q_1$$

and it follows that

$$\frac{\xi_{pr}}{a} = \sqrt{n^2 \cot^2 \frac{\pi}{2} q_1 + \frac{1}{4} (1+n^2)^2 - \frac{1}{2} (1+n^2)} = \varphi_2(q_1, n) \quad (18)$$

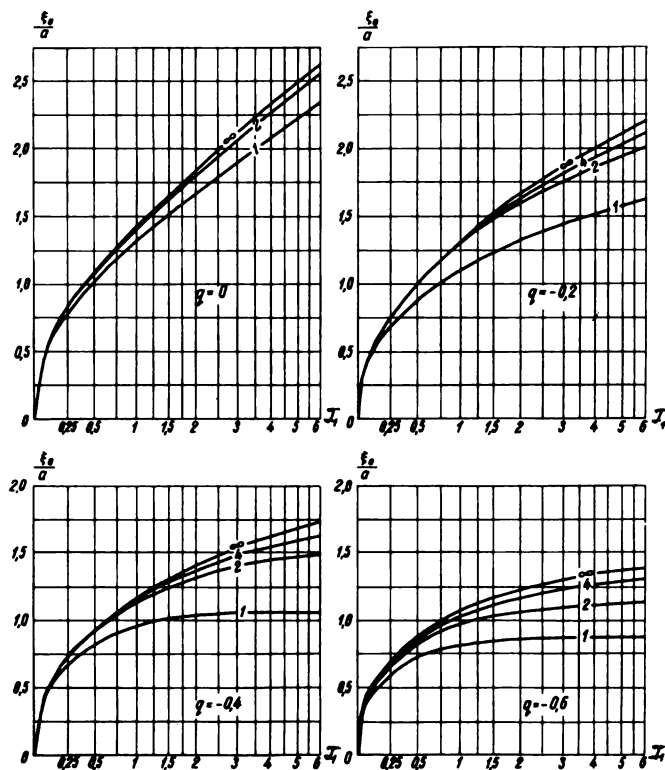

Fig. 2. Thawing depth with time under the center of a structure in two- and three-dimensional problems

where $n = b/a$.

Graphs of functions φ_2 are presented in Fig. 1.

Putting values of function $f(z)$ and its derivative in (7), we obtain

$$\int_0^{\xi_0/a} \left[\frac{1 - \frac{2}{\pi} \arctan \frac{n}{u\sqrt{u^2+1+n^2}}}{1 - q \left(1 - \frac{2}{\pi} \arctan \frac{n}{u\sqrt{u^2+1+n^2}} \right)} \right] \frac{[u^2(u^2+1+n^2)+n^2] \sqrt{u^2+1+n^2}}{n(2u^2+1+n^2)} du = F_2 \left(\frac{\xi_0}{a}, q, r \right) = I_1 \quad (19)$$

The graphs of the function F_2 are shown in Fig. 2. From these graphs, with the value $n > 2$, the depth of thawing can be calculated from (15) with sufficient accuracy, i.e., solution of the two-dimensional problem may be used for this type of three-dimensional problem.

To illustrate the universality of the proposed method, consider the following problem: A tube of radius r_0 is placed in a soil mass; the distance from mass surface to tube center is h_0 . Temperature t_p is maintained on the tube surface from $\tau = 0$; the mass surface temperature is t_0 . Coefficients of heat conductivity of the medium in thawed and frozen conditions differ. Find the limiting depth of thaw under the tube and changes of thaw depth with time. The coordinate origin is placed on the mass surface in the planes of symmetry; the value of ξ_0 is measured from the origin of coordinates. The steady-state temperature field around the tube is described by the equation of Forchheimer.

$$t(x, z) = t_1 \frac{\frac{x^2 + (z + \sqrt{h_0^2 - r_0^2})^2}{x^2 + (z - \sqrt{h_0^2 - r_0^2})^2} - 1}{2 \ln \left[\frac{h_0}{r_0} + \sqrt{\left(\frac{h_0}{r_0} \right)^2 - 1} \right]} = t_1 f(x, z)$$

For the plane of symmetry with $J \times C = 0$, the equation is

$$t(z) = t_1 \frac{\ln \frac{v + \sqrt{m^2 - 1}}{v - \sqrt{m^2 - 1}}}{\ln(m + \sqrt{m^2 - 1})} = t_1 f(v)$$

where

$$v = \frac{z}{r_0} \text{ and } m = \frac{h_0}{r_0}$$

In keeping with (9)

$$\frac{\ln \frac{v + \sqrt{m^2 - 1}}{v - \sqrt{m^2 - 1}}}{\ln(m + \sqrt{m^2 - 1})} = q_1$$

from which it follows that the limiting depth of thaw under the center of the tube is

$$\frac{\xi_{pr}}{r_0} = \sqrt{m^2 - 1} \frac{(m + \sqrt{m^2 - 1})^{q_1} + 1}{(m + \sqrt{m^2 - 1})^{q_1} - 1} = \varphi_3(m, q_1)$$

The graphs of function φ_3 are given in Fig. 3.

The depth of thaw with time is found by putting values of $f(v)$ and $f'(v)$ in (7)

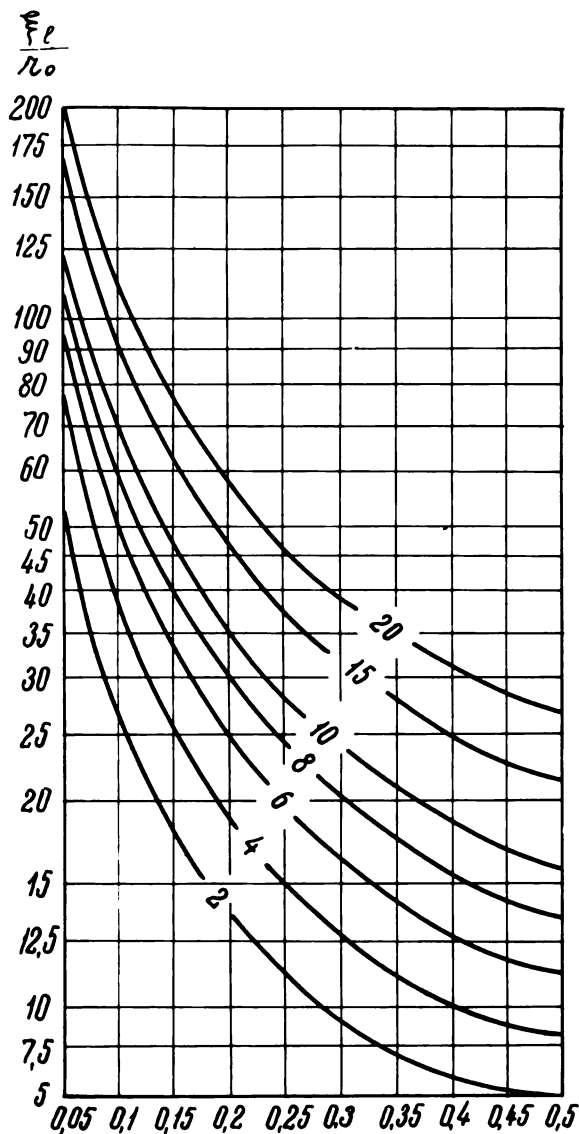

Fig. 3. Thawing limit under center of tube with different values of m

$$I_2 = \int_{m+1}^{\frac{\xi_0}{r_0}} \frac{\ln \frac{v + \sqrt{m^2 - 1}}{v - \sqrt{m^2 - 1}} - 1}{\ln(m + \sqrt{m^2 - 1})} \cdot \frac{1}{1 - q \left[1 - \frac{\ln(m + \sqrt{m^2 - 1})}{\ln \frac{v + \sqrt{m^2 - 1}}{v - \sqrt{m^2 - 1}}} \right]} dv = F_3 \left(\frac{\xi_0}{r_0}, m, q \right) = I_2$$

where

$$I_2 = \frac{\lambda_T t_p \tau}{r_0^2 \sigma w}$$

The graphs of function F_3 are shown in Fig. 4. Consider temperature fields under structures, where foundation soils remain frozen.

Ventilated cellars are the design most widely used for keeping the foundation frozen. In this case, the thickness of seasonally thawed layer differs from its thickness before construction. The temperature condition of the frozen foundation also changes. Calculation of an average annual temperature of soil in the structure foundation may be described by

$$t_M = t_0 - (t_0 - t_p) f(x, y, z) \quad (20)$$

where

t_0 is average annual temperature of the soil surface at a depth of zero annual amplitude

t_p is mean annual temperature of the soil surface under the structure

Function $f(x, y, z)$ depends on the plan and size of the structure. For example, for a structure whose width is considerably less than its length, it is function f from (12a). If the plan of the structure is rectangular, it is function f from (17a), etc.

However, until now there has been no method of determining the nominal temperature (t_p). In a ventilated cellar, periodic temperature changes of the soil surface occur within a period T of one year.

To determine the average annual temperature of the soil surface, consider the changes of its temperature at great depths, some 100 to 150 m, caused by periodic temperature fluctuations on the surface. Apparently, temperature change at such depths is negligible; however, it is not the value of the change that is of interest, but the possibility of its determination in principle.

The thawing-freezing boundary is displaced in the soil within a layer from 0.2 to 2 m thick. For forming the temperature field at depths of 100 to 150 m, such a boundary displacement is practically equivalent to the condition: That a temperature of 0° (or the soil thawing-freezing temperature) is maintained on the soil surface in the freezing-to-thawing period; then, changes in soil temperature at indicated depths are caused by the following kinds of periodic temperature fluctuations on its surface. In the periods of thawing (τ_L) and freezing (τ_p) the surface temperature is equal to 0° or to freezing temperature, whereas when the soil is completely frozen the usual course of the temperature remains on the surface (Fig. 5).

Periodic fluctuations are known to occur around a mean value. In this particular case, the soil average annual temperature (t_G) serves as the axis of fluctuations. In a homogeneous medium this fluctuation axis is parallel to the axis of depths; i. e., from the surface to any depth, the average annual temperature is t_G .

Thermophysical characteristics of frozen soil depend on its temperature; therefore, they condition displacement of the temperature fluctuation axis which is a curve. However, thermophysical characteristics of frozen soils are considered constant, even within the layer of annual temperature fluctuations where it undergoes maximum changes. As stated by V. A. Kudryavtsev [10], average annual temperature t_G shifts to positive or negative temperatures only within the seasonally thawed layer.

Thus, it follows that the soil average annual temperature (neglecting the geothermal gradient) from the bottom of the seasonally thawed layer to any depth equals the cooling impulse area Ω (a freezing index, USA) divided by the duration of the period (Fig. 5).

$$t_G = \frac{\Omega}{T} \quad (21)$$

This temperature must be considered nominal when soil temperature in the structure foundation is provided with a ventilated cellar, i. e., $t_p = t_G$.

If we approximate the curve that bounds the cooling impulse area by a sine curve of amplitude A , the equation for finding the average annual temperature of the cellar soil surface is

$$t_p = -A \frac{T}{\pi(\tau_L + \tau_p)} \sin \frac{\pi}{T} (\tau_L + \tau_p) \cos \frac{\pi}{T} \tau_p \quad (22)$$

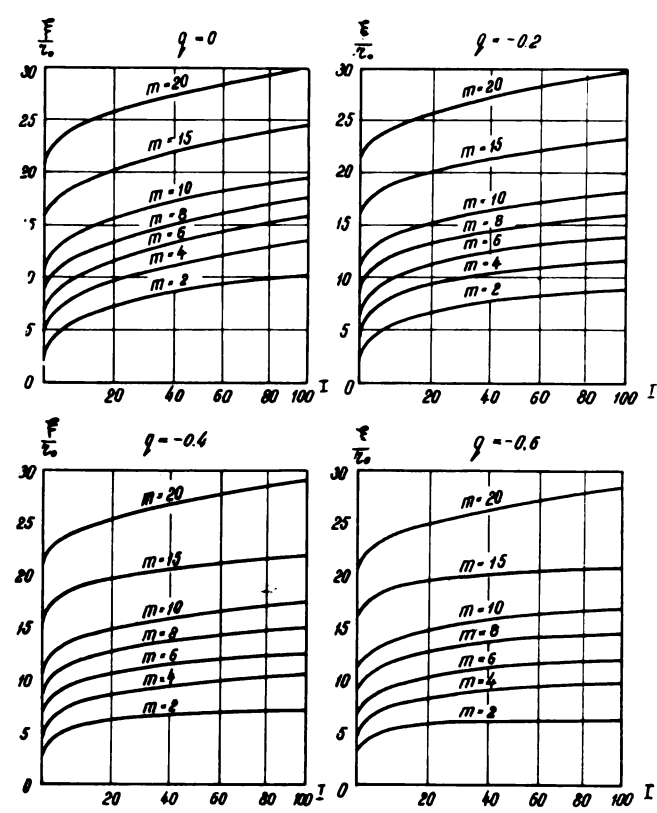

Fig. 4. Thawing with time under center of tube with different values of m

To evaluate (20) and (22), we shall compare the calculated results with observed data. This comparison is given for five most characteristic points in a permafrost area under natural conditions. Depending on the number and time of observations, depth (h) was considered a datum surface from which temperature was measured. Accordingly, the values of τ_L , τ_p , and Ω were taken at that depth. Results of calculations from (21) and (22) and observed data are given in the table.

Table Calculated and actual values of soil average annual temperature at depth of maximum seasonal thaw

Points	Depth h (m)	Ω deg month	Average Annual t_G		
			Equations 21	Equations 22	Actual
Tiki					
1951 to 1952	0.25	-139.1	-11.6	-12.0	-11.4
Suntar-Khayata					
1957 to 1958	0.3	-115.2	-9.6	-10.0	-9.4
Amderma					
1957 to 1958	0.4	-55.1	-4.5	-4.5	-4.5
Yakutsk					
1957 to 1958	0.2	-29.1	-2.4	-2.6	-2.4
Vorkuta					
1959 to 1960	0.1	0	0	0	0

Though (22) only approximates the area of cooling impulses, Ω , it fully reflects the physical nature of the process forming τ_p . Therefore, on the basis of (22), a required ventilation may be determined for a cellar, varying values τ_L , τ_p , and A to obtain the ventilation condition.

From (20) with τ_p known, only average annual temperature values may be determined at any point of a foundation. During the year the temperature of a frozen foundation changes periodically. Attenuation of the amplitude (in a two-dimensional, and more so in a three-dimensional problem) must occur more intensively than expected from Fourier's law. This requires

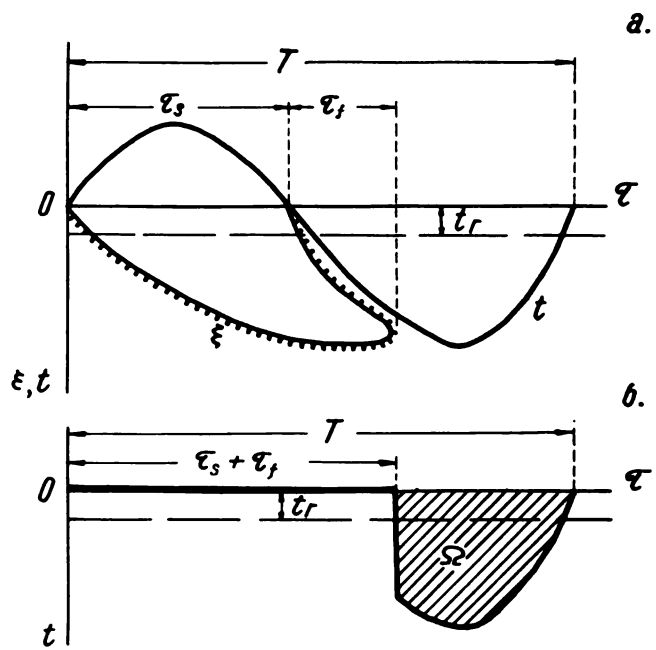

Fig. 5. Actual temperature change of surface and in depth of soil thawing in cellar during year (a) and nominal value (b)

a special solution. To determine maximum soil temperatures under the center of a structure, the temperature amplitude attenuation may be found to the first degree of approximation by using Fourier's law.

To find maximum temperature with respect to depth, an average annual temperature (t_p) of the soil at maximum thaw depth may be assumed as an initial amplitude. Temperature fluctuation amplitude A_z at depth ξ is calculated from

$$A_z = t_p \exp \left[-(z - \xi) \sqrt{\frac{\pi}{KT}} \right]$$

where K is coefficient of thermal conductivity of the ground.

Then, maximum soil temperature (t_{max}) under the center of a structure whose length is more than twice its width, according to (20) and (12a), is

$$t_{max} = t_o \left\{ 1 - \exp \left[-(z - \xi) \sqrt{\frac{\pi}{KT}} \right] \right\} + 2 \frac{t_p - t_o}{\pi} \left\{ \arctan \frac{a}{z} - \arctan \frac{a}{\xi} \exp \left[-(z - \xi) \sqrt{\frac{\pi}{KT}} \right] \right\}$$

or for a structure rectangular in plan, if the ratio of its sides is equal to or less than two, according to (20) and (17a)

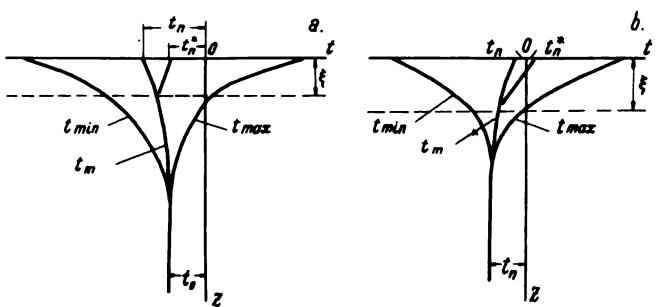

Fig. 6. Changes in maximum, minimum, and average annual temperatures of ground

$$t_{\max} = t_o \left\{ 1 - \exp \left[- (z - \xi) \sqrt{\frac{\pi}{KT}} \right] \right\} \\
+ 2 \frac{t_p - t_o}{\pi} \left\{ \arctan \frac{ab}{z\sqrt{z^2 + a^2 + b^2}} \right. \\
\left. - \arctan \frac{ab}{\xi\sqrt{\xi^2 + a^2 + b^2}} \exp \left[- (z - \xi) \sqrt{\frac{\pi}{KT}} \right] \right\}$$

Fig. 6 presents the changes of maximum, minimum, and average annual soil temperatures with respect to depth under a structure with a ventilated cellar.

Fig. 6a shows ventilation conditions present so that the soil is cooled additionally $t_p < t_o$. Fig. 6b illustrates soil temperature increase ($t_p > t_o$). In these figures t_p designates true average annual temperature of the cellar soil surface.

REFERENCES

[1] K. E. Lembke. *Inzhener*, Journal of the Ministry of Communications, St. Petersburg, No. 2, 1886.

- [2] L. S. Leybenzon. *Rukovodstvo po neftepromyslovoj mekhanike*, United Sci. Tech. Publ. House, Moscow and Leningrad, 1931.
- [3] *Osnovy geokriologii (merzlotovedeniya)*, Acad. Sci. USSR, Moscow, No. 2, 1959.
- [4] Kh. R. Khakimov. *Voprosy teorii i praktiki iskusstvennogo zamorazhivaniya gruntov*, Acad. Sci. USSR, Moscow, 1957.
- [5] I. A. Charnyy. "Computation of the Freezing Rate of Soils," *Sovetskiy Metropoliten*, No. 4, 1960.
- [6] G. P. Porkhayev. "Thawing of Permafrost Soils Under Heated Buildings," *Materialy k osnovam ucheniya o merzlykh zonakh zemnoy kory*, Acad. Sci. USSR, Moscow, No. 6, 1960.
- [7] G. P. Porkhayev. "The Steady-State Temperature Field in the Foundation of a Heated Building," *ibid.*, No. 5, 1959.
- [8] V. P. Ushkalov. *Glubina i skorest' ottaivaniya merzlogo osnovaniya, ikh predel'nyye velichini i raschet*, State Construction Publ. House, Moscow, 1962.
- [9] S. S. Kovner. "A Problem of Heat Conductivity," *Geofizika*, Vol. III, 1933.
- [10] V. A. Kudryavtsev. "The Effects of the Lithologic Composition and Moisture Content of Soils on Their Temperature Systems," *Vestnik Mosk. un-ta, ser. biol., pochvoved., geol., geog.*, Moscow, No. 4, 1958.

DISCUSSION—SESSION 5

P. I. MELNIKOV—The Shergin mine was sunk at Yakutsk more than 100 years ago. From 1844 to 1846 it was investigated by Middendorf who observed rock temperature changes to a depth of 116 m. His investigations yielded evidence which provided proof of the presence of a thick series of permafrost in Siberia.

Some scientists, particularly K. E. von Baer, cast doubt on Middendorf's temperature data because his measurements were performed seven years after the mine was sunk. For a long time many people displayed a keen interest in checking the temperature observations. From 1934 to 1941, almost 100 years after Middendorf, such observations were made. As a result of the geothermal investigations it was established that, to a depth of 60 m, the temperature in the mine appeared higher than recorded by Middendorf; a little deeper, temperature again decreased a bit.

To verify the geothermal investigations, a well of 120 m deep was drilled at a distance of 30 m from the mine in 1958. The temperature data obtained with the aid of the well confirmed the latter investigation. In the Shergin mine, winter air convection cooled the rock surrounding the mine to a depth of 60 m. Changes in rock temperature were not observed at greater depths. The higher temperatures found by Middendorf below 60 m were not the natural temperatures of that period, but resulted from heating in the course of sinking the well. The period of time from sinking the well to the temperature measurements carried out by Middendorf appeared insufficient to restore the temperature field of the rock surrounding the mine at these depths. Restoration of the disturbed temperature of the permafrost at depths over 60 m took place because of a heat flow from the surrounding frozen mass. This process proceeds very slowly and may last for scores of years—and even more.

The data indicate that the restoration process of the disturbed temperatures of rocks continues for a long time, especially in the lower part of the permafrost formation.

To determine the temperature dynamics of permafrost, it is necessary to carry out precise long term observations in the permafrost mass and 100 m deeper. Results of these observations will permit evaluation of the influence of short term and long term climatic fluctuations on the rock temperature.

F. J. SANGER—More applied research is required before we can dispense with simple developments, such as the modified Berggren equation, of the Neumann theory. Scott's work, a scientific approach to the problem of heat exchange at the

ground surface, is noteworthy in this respect, but he is handicapped by a lack of the right kind of data; too many observations and too few analyses exist at present. Nor are very precise observations, taken for short periods on fine days, of much help in predicting effects over many months. It seems correct to say that at present, computations making use of many parameters do not provide much greater accuracy than do the methods based on one or two parameters. The value of the degree-day methods is that they give useful results with minimum site data—which is unfortunately all that one usually has to work with.

The modified Berggren equation is very useful if a plane problem can safely be assumed. Its value for computations other than in ground surface problems has been well proven—e.g., in the buildings discussed by Lobacz and Quinn. For the time being Sanger's curves are useful and must suffice until the more precise methods being developed by Scott can be used in engineering practice. It is unfortunate that the conference has not elicited more papers on the heat exchange at the air-ground interface.

The discontinuity introduced by latent heat forces one into approximate techniques that give good practical solutions if care, experience, and judgment are used in their application. Thus if a soil has a very low water content, latent heat may be neglected. If the water content is high, heat capacity may be ignored, especially if temperature changes are small. Good solutions are obtainable by using latent heat and adding a little for heat capacity that is based on the temperature range. A useful method is to take the total change in energy between two working temperatures on either side of the freezing point and divide by the temperature change for an equivalent heat capacity. Standard solutions then become possible, or numerical and computer techniques with finite difference equations can be used.

Lukyanov's work in hydraulic analog computers is well known. It is doubtful if such computers are preferable to the electronic analog and digital computers however, mainly because of a lack of flexibility in tube sizes, hydraulic difficulties at valves and fittings, and size and complexity of the set-up for any but the simplest problems. The theory is simple, and the writer admits a weakness in liking to see temperature changes as they occur and in discounting the lower speed as compared with the other computers. However, it seems probable that electronic analogs and digital computers will supersede the hydraulic analog computer, except perhaps

for educational purposes. The Lukyanov computer has a remarkably fine record of service in the design of difficult structures.

The other contribution from the USSR, by Porkhayev, deals with a very difficult problem, basic in foundation engineering, especially if the design assumes ground thawing after construction. This is an active topic in the Soviet Union at present. The difficulty to an inexperienced engineer is in the equivalent diffusivity concept; diffusivity varies from point to point since it depends upon temperature. This means that an estimated complete solution is required to start with: then it can be modified until the precise result is obtained—which may be a lengthy process. The writer has used this technique in comparatively simple problems but has been reluctant to apply it to difficult ones, mainly because the labor is not commensurate with the degree of precision of soils data and

the desired results. However, we are not so interested in thaw consolidation under an existing structure as Russian engineers are, and the more rigorous treatment may be justified. Porkhayev's contributions in this field have been very significant and a paper from him is very welcome, based as it is on many years of working on a good team at the Obruchev Institute.

Skaven-Haug has published several valuable papers on the use of compressed peat blocks. Perhaps his paper will arouse more interest. Certainly the technique should be tried for roads where some roughness seems inevitable, but acceptable; the application to airfields is less promising. CRREL will soon be testing the concept for roads in Alaska: the conditions are not likely to produce startling results, but the effects of the compressed peat blocks in the base should be revealed.

SESSION VI PHYSICO-MECHANICAL PROPERTIES OF FROZEN GROUND

LABORATORY DETERMINATION OF THE DYNAMIC MODULI OF FROZEN SOILS AND OF ICE

C. W. KAPLAR, U.S. Army Cold Regions Research and Engineering Laboratory

Elastic constants of frozen soils and of ice were determined as part of the studies of strength properties of frozen soils [1]. The elastic properties of frozen soils have not been extensively studied. However, several investigators [2 to 9] have measured the elastic properties of ice. In this study, tests were conducted in both media to obtain needed data and to facilitate comparison between the two. Dynamic methods were used in nondestructive tests. Electromagnetic vibrations were induced in beams of frozen soil and ice. Dynamic rather than static methods are more suitable for determining elastic properties [2, 3, 10].

The static method usually involves measurements in the plastic, rather than the elastic, range of deformation. Elastic deformation takes place over such a small range of load and deformations that extremely small stresses must be used. Deformations within the elastic range are so small that their measurement is difficult and subject to considerable error. [11, 12].

The dynamic method is an indirect procedure relating sonic resonant frequencies to the elastic properties of the material. By its use, the large aberrations caused by plastic deformation can be avoided. In the field, velocities of elastic waves produced by buried explosive charges can be measured directly. In the laboratory, longitudinal and transverse wave velocities can be computed from the resonant frequencies induced in small beams of frozen soil and ice.

It is hoped that the results of these studies will be useful in seismic applications in permafrost regions for possible identification of frozen subsurface strata and in the design of foundations of critical structures subjected to vibrating or oscillating loads. Data from these tests have been useful in the design of radar foundations in permafrost.

INVESTIGATIONS PERFORMED

Materials Used in the Investigation

Table I lists the materials investigated, the number of specimens of each material tested, and the orientation of the beams during vertical freezing, i.e., whether in horizontal or vertical position.

A complete summary of soil characteristics and other data is shown in Fig. 1.

Test Equipment

Dynamic modulus test apparatus—The electromagnetic vibrator used in this investigation is shown in Fig. 2. The vibrator was designed and constructed by Francis Birch of Harvard University. Beams approximately 1-1/2 by 1-1/2 by 11 in. were used in the investigation. Permanent bar magnets, 3/16 by 3/16 by 2 in., were frozen flush into horizontal grooves prepared in each end of the frozen specimen beams with the ends of the magnets protruding 1/4 in. on each side (Fig. 3). Vibration of the specimens was initiated by a pair of electromagnets mounted in series at one end of the vibrator. The electromagnets were held in adjustable supports and could be rotated 90 deg. A switching arrangement was provided to enable corresponding poles of the two electromagnets to be of same or opposite polarity. The arrangement of the detector

magnets on the other end of the specimen was the same as on the driving end.

Table I. Materials tested

Material	Symbol	Number of specimens tested	
		Frozen horizontally	Frozen vertically
Peabody gravelly sand (minus 3/4 in. mesh)	SP	2	0
McNamara concrete sand	SM	1	1
East Boston till ^a	SEBT	0	5
New Hampshire silt	SNHS	2	1
Fairbanks silt	SFS	0	5
Yukon silt	SYS	0	5
Boston blue clay (undisturbed)	SBC	6	0
Fargo clay (undisturbed)	SFFC	5	0
Alaskan peat (undisturbed)	SAP	1	1
Ice, artificially frozen	SI	6	4
Ice, natural ^b	SI-(P)	1	0

^aFour specimens consisted of material passing No. 4 mesh sieve, and one specimen of material passing the 3/4 in. sieve

^bSpecimen obtained from large beam cut out from natural lake ice at Portage Lake, Me., in March, 1953

Freezing trays—Two specially made wooden molding trays, which could be easily dismantled, were used in the preparation of the soil beams. One of the trays contained six horizontal compartments for the preparation of horizontally frozen beam specimens (i.e., frozen in a horizontal position). The specimens molded in this tray are identified by the prefix HB (horizontal beam). The other tray contained 25 vertical compartments for the preparation of beams to be frozen in a vertical position. The samples molded in this tray are identified by the prefix VB (vertical beam).

PREPARATION AND FREEZING OF SPECIMENS

Except for the undisturbed soils, such as Fargo clay, Boston blue clay, and Alaskan peat, test materials were molded at optimum water content to densities approximately 95% of the maximum determined by either the Providence Vibrated Density Test or the Modified AASHTO Test (Fig. 1), whichever was applicable. The Providence Vibrated Density Test method was used only on cohesionless soils such as Peabody gravelly sand and McNamara concrete sand. The clay and peat test specimens were trimmed from larger undisturbed chunk samples at their natural densities. Only horizontal beams were cut from undisturbed chunk samples which were oriented in the same position as in the field. Except for one specimen of Alaskan peat, no vertical beams were cut, because of difficulties in manipulating such slender specimens.

The inside walls of the wooden molds were lubricated with petrolatum and lined with transparent cellulose acetate, 0.007 in. thick. The petrolatum and acetate minimized side

GRAIN SIZE DISTRIBUTION

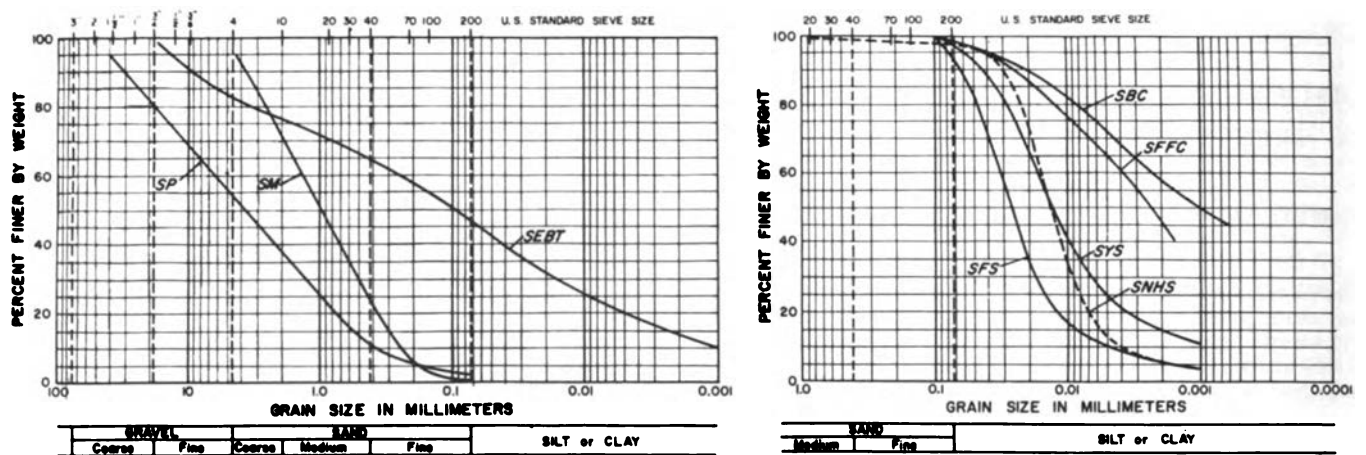

SUMMARY OF SOIL TEST DATA

SOIL LEGEND	NAME	SOURCE	DEPARTMENT OF THE ARMY UNIFIED SOIL CLASSIFICATION			ATTERBERG LIMITS			SPECIFIC GRAVITY	COMPANION CHARACTERISTICS	
			DESCRIPTION	GROUP SYMBOL	LIQUID LIMIT	PLASTICITY INDEX	SHRINKAGE LIMIT	MAX. DRY UNIT WT. (pcf)		OPTIMUM WATER CONTENT (percent)	
SP	Peabody Gravelly Sand	Peabody, Mass.	Bank run gravelly SAND	SP	non-plastic		-	2.72	134 (1)	-	
SM	McNamara Concrete Sand	Needham, Mass.	SAND, brown, angular, processed for concrete	SP	non-plastic		-	2.72	123 (1)	-	
SEBT	East Boston Till (-3/4")	East Boston, Mass.	Clayey, gravelly SAND (Glacial Till)	SC	21	7	-	2.76	137 (2)	8.1	
SNHS	New Hampshire Silt	Manchester, N. H.	Light gray brown, inorganic clayey SILT	CL-ML	26	5	-	2.70	107 (2)	15.6	
SFS	Fairbanks Silt	Fairbanks, Alaska	Brown and gray SILT, containing traces of mica and some organic matter	ML-OL	28	4	-	2.68	112 (2)	15.7	
SYS	Yukon Silt	Whitehorse, Yukon Territory, Canada	Gray, well graded, inorganic clayey SILT	CL-ML	28	9	-	2.73	121 (3)	12.8	
SBC	Boston Blue Clay	No. Cambridge, Mass.	Stiff lean CLAY, relatively homogeneous and free of fractures and verves	CL	47	27	22	2.81	-	-	
SFFC	Fargo Clay	Fargo, North Dakota	Dark gray, friable, highly plastic homogeneous fat CLAY, with honey-comb structure (organic content 8%)	CH-OH	68	46	15	2.76	-	-	
SAP	Alaskan Peat	Fairbanks, Alaska	Dark brown to black PEAT; fibrous, partially decomposed (organic content 82 percent)	Pt	Tests inapplicable			1.52	-	-	

NOTES: (1) Providence Vibrated Density (Proc. 2nd Intl. Conf. on Soil Mech. and Fdn. Engineering, v. 4, p. 243);
 (2) Modified AASHO Density (ASTM T180-57D); (3) Standard Proctor Density (ASTM T99-57A)

Fig. 1. Summary of soil characteristics

friction of frost-heaving specimens during freezing and facilitated the removal of frozen specimens from the molds.

The specimens, in trays, were placed in freezing cabinets, de-aired under vacuum, and saturated. A de-aired water supply was provided to the bottom of the trays, with water level maintained at the level of the tops of the specimens during freezing. The space between the tray and the walls of the cabinets was insulated with granulated cork, leaving only the top of the tray exposed to cabinet air temperature.

Specimens were frozen unidirectionally, from top to bottom, with the bottom of the trays exposed to a temperature of approximately 38°F. The cabinet air temperature was reduced daily by successively larger decrements, as necessary, to

freeze the specimens uniformly at a rate ranging from approximately 1/2 to 3/4 in. per day, as frequently observed in nature. After freezing, the specimens were removed and carefully trimmed to uniform dimensions, measured, weighed, and tempered for a period of at least 16 hours at each test temperature before sonic testing.

The ice-lenses which formed in the frost-susceptible soils in horizontally frozen beams were parallel to the longitudinal axis of the beam, while the ice-lenses in the soils frozen vertically were perpendicular to the longitudinal axis. Photographs of typical specimens frozen horizontally and vertically, showing the orientation of the ice-lenses, are shown in Figs. 4 and 5, respectively.

TEST PROCEDURE

The specimens, with bar magnets embedded horizontally across each end, were supported on their sides in a horizontal position in the apparatus between pairs of posts with blunt cone-shaped prongs. For longitudinal and torsional vibrations, the beam was supported midway between the ends. For flexural vibrations, the beam was supported at the "quarter" nodes, a distance from each end equal at 0.224 times the length of the specimen.

The two driving electromagnets were adjusted so that each projecting end of the bar magnet in the test beam lay between the poles of the magnets.

Since the poles of the electromagnets change polarity with the frequency of the alternating current in the coils, they alternately attract and repel the permanent bar magnet, causing the specimens to vibrate. The position of the two driving electromagnets, the direction of the current in their respective coils, and the position of the specimen supports, determine the type of vibration that results.

For flexural and torsional vibrations, the electromagnets were set so that their poles were in the same vertical plane as the bar magnets on the specimen (Fig. 2). To produce flexural vibrations, the alternating current was made to pass through the coils to produce a polarity of opposite sign in the corresponding poles of the two electromagnets. The resulting simultaneous attraction and repulsion of the bar magnet in a vertical direction caused the beam to vibrate in flexure. To incite torsional vibrations, the beam was supported firmly at its midpoint and current passed through the driving magnets to simultaneously induce the same polarity in corresponding poles. This caused the specimen to vibrate in torsion about its longitudinal axis. Longitudinal vibrations were produced with the poles of the electromagnets placed in a horizontal

plane, with corresponding poles having opposite polarity, the specimen being supported at the midpoint. The effect was alternately to push and pull on the bar magnet in a horizontal plane, parallel to the longitudinal axis of the specimen.

The permanent bar magnet at the opposite end of the beam responded at the same frequency, and the fluctuations of the magnetic field induced an electromotive force of varying intensity in the receiving or detecting coils. In theory, the peak voltage is induced when the specimen is vibrating at its natural frequency, and the amplitude of the vibrations is then at a maximum. The resonant frequency was detected with a vacuum tube voltmeter or a cathode ray oscilloscope (or both) connected to the detecting coils, and read from the dial markings of the calibrated oscillator.

The following equations [13] were used in the computations:

Flexural Vibrations

$$E_f = CW(f_f)^2 \tag{1}$$

(A value of 1/3 was assumed for Poisson's ratio when finding C from curves given [13]. The value of μ is not critical, and the assumption is reasonable.)

Longitudinal Vibrations

$$V_L = 2f_L L \text{ and } E_L = \frac{W(V_L)^2}{g} = \frac{4wL^2(f_L)^2}{g} \tag{2}$$

Torsional Vibrations

$$V_t = 2f_t L \text{ and } G = \frac{w(V_t)^2 R}{g} = \frac{4wL^2 R(f_t)^2}{g} \tag{3}$$

(R is 1.83 for a square prism [13].)

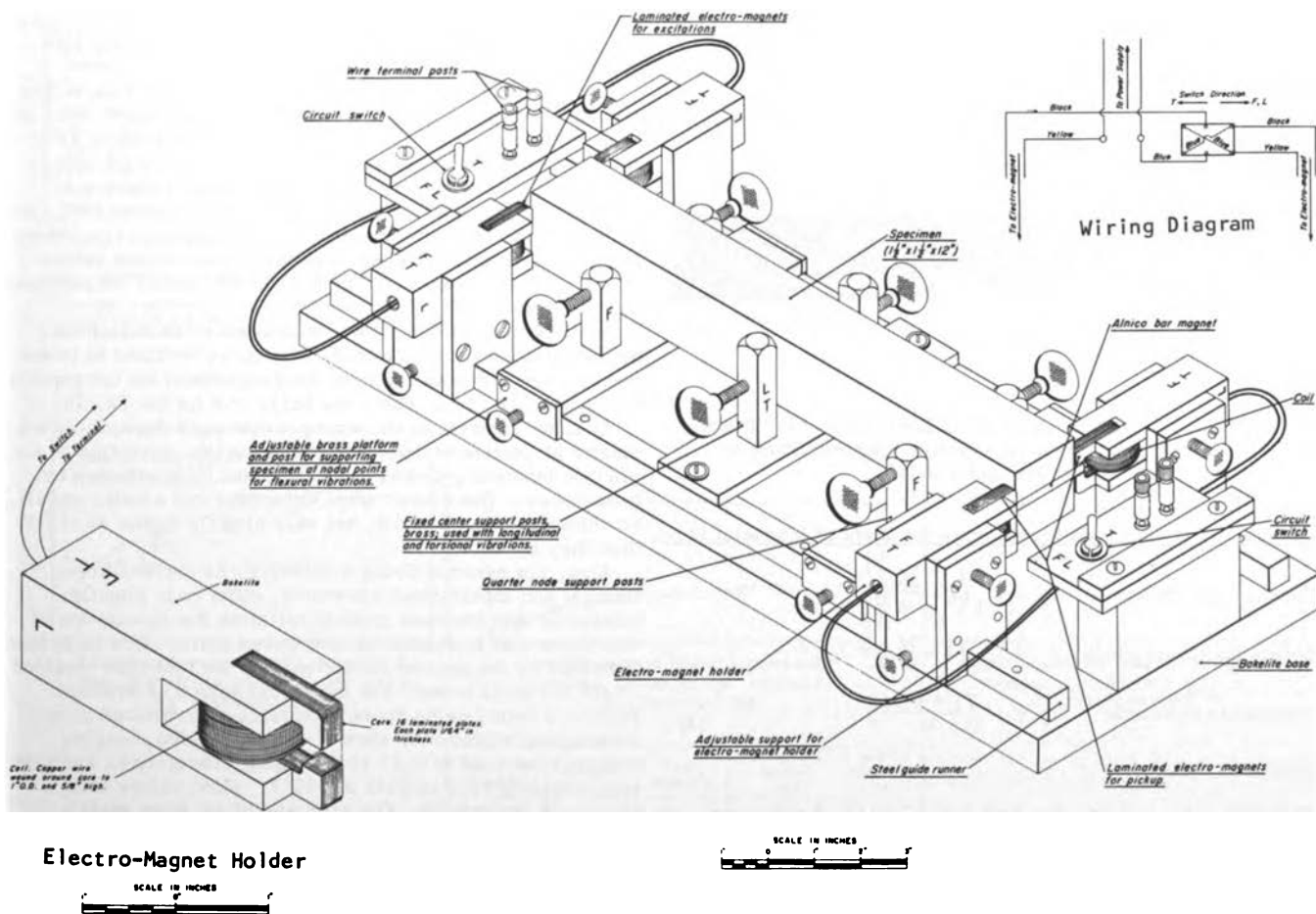

Fig. 2. Electromagnetic three-mode beam vibrator

TEST RESULTS AND DISCUSSION



Fig. 3. Specimen of frozen sand showing permanent bar magnet



Fig. 4. Typical beam of undisturbed Boston blue clay frozen in horizontal position. Ice-lenses oriented horizontally, parallel to longitudinal axis of beam. Note magnets in ends of specimen



Fig. 5. Typical beam of undisturbed Boston blue clay frozen in vertical position. Ice-lenses oriented perpendicular to longitudinal axis. Top of specimen at left

Corrections to Observed Frequencies for Mass of Magnets [14]

Flexural vibrations: $f_f = f'_f \left(1 + \frac{2M}{W}\right)$
 Longitudinal vibrations: $f_L = f'_L \left(1 + \frac{M}{W}\right)$
 Torsional vibrations: $f_t = f'_t \left(\frac{1 + k^2M}{W}\right)$ (4)

Poisson's Ratio

Poisson's ratio is computed from E and G using the relation:
 $\mu = \frac{E}{2G} - 1$ (5)

It should be remembered that these formulas are strictly applicable only to an isotropic homogeneous solid obeying Hooke's Law.

The individual test results from 13 specimens of 3 typical soils and 11 ice specimens are presented in Figs. 6 to 9. Space limitations do not permit presentation of individual test results of all specimens of the different soils used in this investigation. (A more complete and detailed report is under preparation for publication as U.S. Army CRREL Research Report 163.) However, all test results on all soils and ice are summarized in Fig. 10. In Figs. 6 and 7, a single average solid line has been drawn through points representing values obtained from dilatational (longitudinal) vibrations for all specimens of a given soil. A similar, but dashed line, has been drawn through points obtained from flexural vibrations. The test temperatures ranged from approximately 32°F to below -10°F.

Theoretically, for an elastic isotropic homogeneous solid, the dynamic moduli of elasticity derived from flexural and longitudinal vibrations should be the same. In all present tests, the numerical values of E obtained from flexural vibrations were slightly lower than those obtained from longitudinal vibrations. This is not surprising, since a frozen soil containing irregularly stratified ice-lenses, cannot truly be considered an isotropic homogeneous material. Only an isotropic material, one in which every plane is symmetrical, can be characterized by only two elastic constants such as Young's modulus and Poisson's ratio [15]. Flexural and longitudinal vibration tests performed with the same equipment on prismatic and cylindrical bars of aluminum gave compatible results, generally within 2% of each other.

In Figs. 6c and 7c, curves of dynamic Poisson's ratio versus temperature are presented—calculated using the relationship $\mu = (E_L/2G) - 1$. Average values of dynamic E and G obtained from curves in Figs. 6a, 6b, and 7a, 7b, were used in the formula. Only E from longitudinal vibrations was used, since E from flexural vibrations was considered less reliable.

The plotted data and summary curves in Fig. 10 show that dynamic moduli and elastic wave velocities in frozen soils are temperature dependent—more so at temperatures above 20°F and less so at colder temperatures. The propagation velocities in the silts and clay appear particularly sensitive to temperature changes from 32° to 20°F. Below about 20°F, the velocities increase linearly and are less dependent on temperature. This behavior is believed due to the varying percentages of unfrozen water still present in the soil at temperatures below freezing [16].

A comparison of laboratory-determined wave velocities, both dilatational and torsional, with those obtained in permafrost by seismic methods show good agreement for comparable soil types [17, 18]. The same holds true for ice [3, 19].

In sharp contrast to the strong temperature dependence of elastic properties of frozen soil, the elastic properties of ice, whether laboratory-frozen or natural, are little affected by temperature. The elastic wave velocities and elastic moduli, as shown in Figs. 8 and 9, are only slightly higher at -10°F than they are at 30°F.

Also, the dynamic Young's moduli E, as derived from flexural and longitudinal vibrations, differ only slightly, indicating that ice more closely satisfies the assumption of isotropism and homogeneity than frozen soils. This is further indicated by the greater consistency of the test data obtained.

For the soils tested, the individual values of dynamic Poisson's ratio, using Young's modulus E determined from longitudinal vibrations, show a wide scattering, ranging roughly from 0.22 to 0.55 at the higher temperatures and from approximately 0.21 to 0.45 at -10°F. Most values fall between 0.25 to 0.38. The silts and clays show greater divergence of values than the soils composed of coarser-grained particles, such as the gravelly sand and the glacial till.

The values of Poisson's ratio for ice, although covering a relatively wide range, show the least scattering of all the materials tested. This wide variation of μ for different speci-

mens of a given soil at a given temperature and mode of vibration reflects the sensitive dependence of Poisson's ratio upon the values of the modulus of elasticity and rigidity in the formula $\mu = E/2G - 1$. A very small change in E or G is amplified greatly in the values of μ . For example, assuming $G/E = 0.40$ (a good approximation in most cases): If the error in E and G is only 5% (this is more than a reasonable estimate based upon the scatter of points on the moduli plots), then the maximum error in μ is about 50%. To restrict the

maximum error in μ to 20%, E and G must each be determined to an accuracy of about 98%, which is very difficult to achieve. In these studies, in view of the many areas of measurement and since E or G are also proportional to the frequency and length squared, it is most probable that the maximum error in any one determination of E and G is unlikely to be less than 5%. For this reason, any value of Poisson's ratio computed from an individual test cannot be considered reliable. Furthermore, the formulas and equations used here

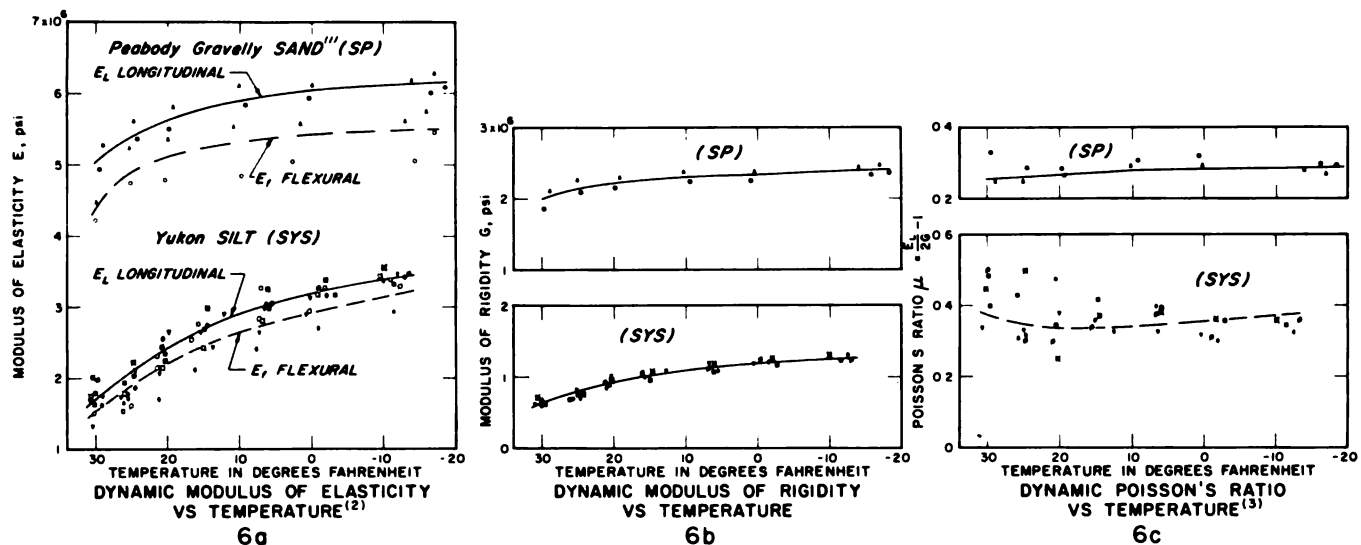

SPEIMEN NUMBER	SYMBOL	TRAY NUMBER	TOTAL UNIT WEIGHT (pcf)	WATER CONTENT (%)
SP - 300	• •	HB - 11 *	129	14.5
SP - 301	• •	HB - 11	131	12.7
SYS - 376	• •	VB - 9 **	125	22.9
SYS - 377	• •	VB - 9	130	22.5
SYS - 378	• •	VB - 9	131	20.1
SYS - 379	• •	VB - 9	132	19.8
SYS - 380	• •	VB - 9	126	20.2

* HB () indicates test beams frozen from top to bottom in horizontal position. Ice lenses oriented parallel to longitudinal axis of beam, in a horizontal plane.
 ** VB () indicates test beams frozen from top to bottom in vertical position. Ice lenses oriented normal to longitudinal axis of beam.

NOTES

(1) Minus 3/4 inch material only.

(2) Solid symbols in graphs a represent values computed using fundamental longitudinal frequencies. Open symbols represent values computed using fundamental flexural frequencies.

(3) The solid symbols in graph c indicate values computed using each value of modulus of elasticity, E_L , as shown in graph a. The solid line in graph c represents Poisson's ratio computed using the average value of E_L indicated by the solid curve in graph a.

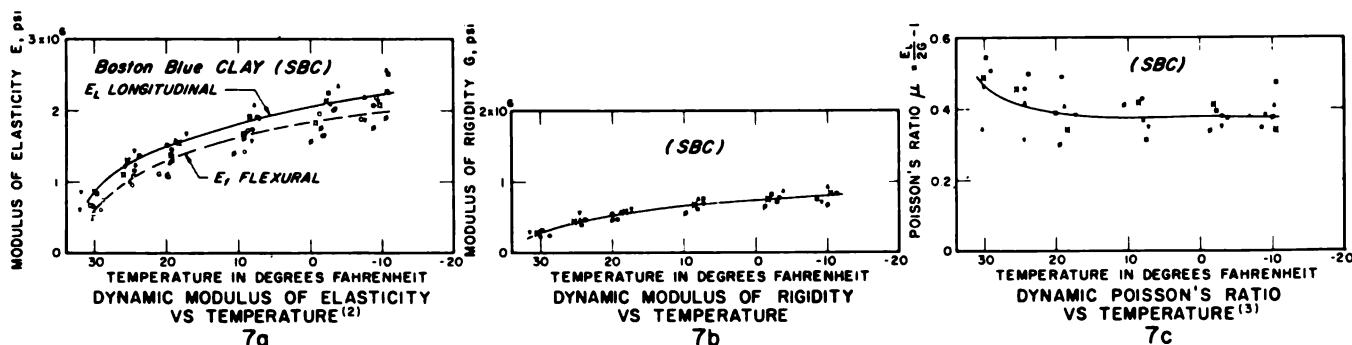

SPEIMEN NUMBER	SYMBOL	TRAY NUMBER	TOTAL UNIT WEIGHT (pcf)	WATER CONTENT (%)
SBC - 307	• •	HB - 11 *	100	54.1
SBC - 307A	• •	HB - 11	110	37.2
SBC - 308	• •	HB - 11	89	85.0
SBC - 309	• •	HB - 11	95	60.8
SBC - 309A	• •	HB - 11	90	73.8
SBC - 310	• •	HB - 11	107	41.6

Fig. 6 and 7. Dynamic elastic properties of several typical frozen soils versus temperature

are applicable only to homogeneous, isotropic, and elastic materials.

Taken as a whole, the values of dynamic Poisson's ratio indicated by the summary curves in Fig. 10f, which are based on the average values of the modulus of elasticity derived from longitudinal vibrations (the average curves in Fig. 10b), and the values of the modulus of rigidity (the average curves in Fig. 10c), appear to be of the right magnitude. Except for Peabody gravelly sand and the ice specimens, Poisson's ratio

for practically all of the remaining soils varies with temperature in different ways.

From the curves shown in Fig. 10f, it is impossible to express the relationship of Poisson's ratio to temperature in general terms applicable to frozen soils as a whole. Some of the curves are concave in shape; others are convex. For some soils, Poisson's ratio increased with temperature; for others, it decreases. The largest variations with temperature occur at higher temperatures, i.e., above 20°F. Whereas some

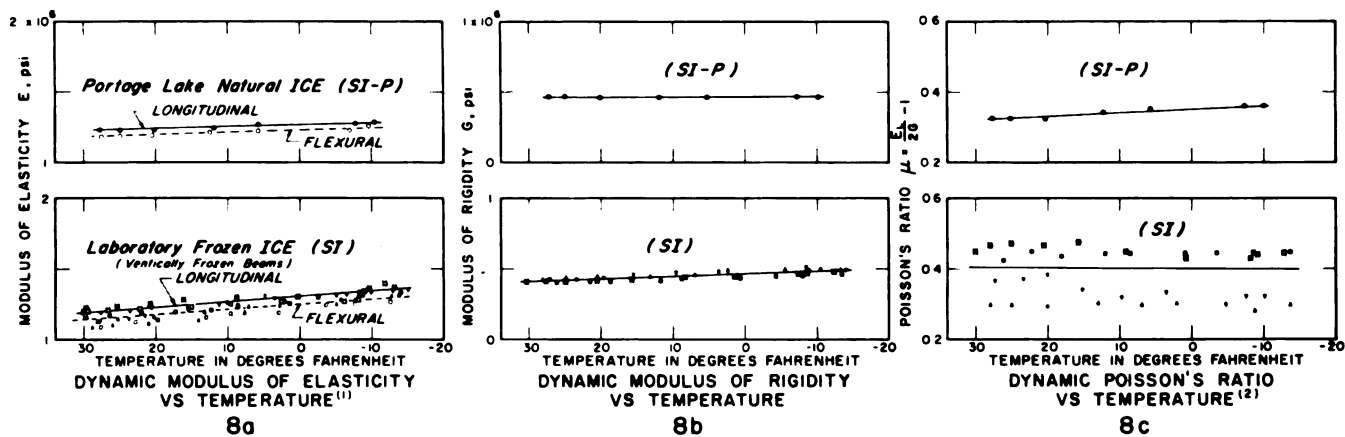

SPECIMEN NUMBER	SYMBOL	TRAY NUMBER	UNIT WEIGHT (pcf)
SI-664	• •	VB-5 [#]	54
SI-665	• •	VB-5	55
SI-667	• •	VB-5	56
SI-668	• •	VB-5	56

* VB () indicates test beams frozen top to bottom in vertical position

SPECIMEN NUMBER	TYPE OF ICE	LENGTH (in)	CROSS SECTIONAL AREA (sq in)	WEIGHT (lb)	DENSITY (lb per cu in)
SI-(P) ^{**}	CLEAR	9.95	2.24	0.725	0.0326 (56.3 pcf)

** Horizontal Beam (Optic Axes of crystals oriented normal to longitudinal axis of beam)

NOTES

(1) Solid symbols in graphs a represent values computed using fundamental longitudinal frequencies. Open symbol represent values computed using fundamental flexural frequencies.

(2) The solid symbols in graph c indicate values computed using each value of modulus of elasticity, E_L , as shown in graph a. The solid line in graph c represents dynamic Poisson's ratio computed using the average value of E_L indicated by the solid curve in graph a.

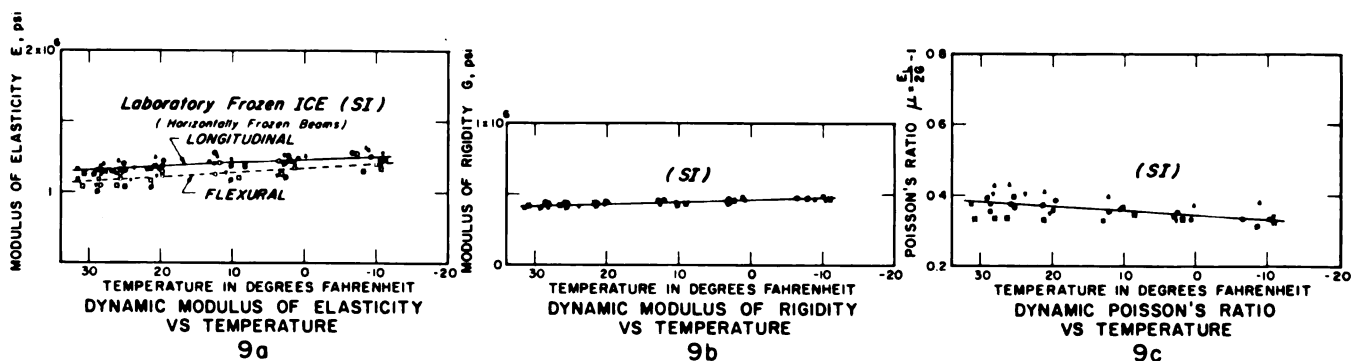

SPECIMEN NUMBER	SYMBOL	TRAY NUMBER	UNIT WEIGHT (pcf)
SI-670	• •	HB-10 [#]	56
SI-671	• •	HB-10	55
SI-672	• •	HB-10	56
SI-673	• •	HB-10	55
SI-674	• •	HB-10	55
SI-675	• •	HB-10	55

* HB () indicates test beams frozen from top to bottom in horizontal position

Figs. 8 and 9. Dynamic elastic properties of naturally frozen and laboratory frozen ice versus temperature

relationship between the elastic properties and the type of soil is apparent in all of the other graphs shown in Fig. 10, no such relationship is evident for μ . For example: Poisson's

ratio for Boston blue clay (SBC) and Fargo clay (SFFC) are divergent at temperatures above 10°F, but the values nearly coincide between 6° and -10°F. The values for two of the

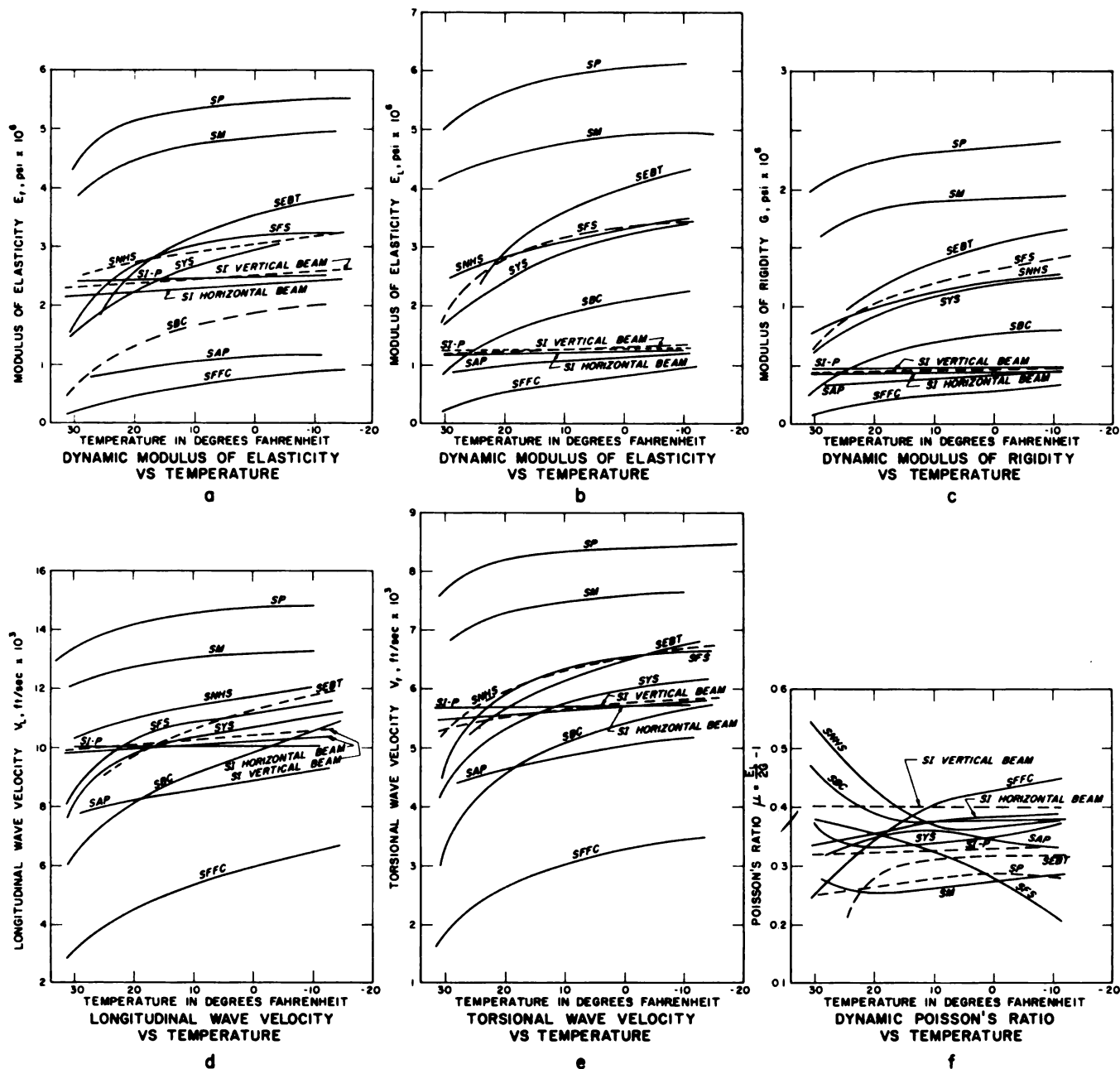

LEGEND

- | | |
|------------------------------|---------------------------------|
| SP — Peabody Gravelly Sand | SYS — Yukon Silt |
| SM — Mc Namara Concrete Sand | SBC — Boston Blue Clay |
| SEBT — East Boston Till | SFFC — Fargo Clay |
| SNHS — New Hampshire Silt | SAP — Alaskan Peat |
| SFS — Fairbanks Silt | SI — Laboratory Frozen Ice |
| | SI-P — Portage Lake Natural Ice |

NOTES

This figure summarizes all data obtained in this investigation. Each curve represents test results of two to six specimens. Curve of Poisson's Ratio vs temperature is based on values taken from average curves in graphs b and c.

Fig. 10. Summary plot of dynamic elastic properties of frozen soils and of ice versus temperature

silts, Fairbanks silt and Yukon silt, diverge at temperatures below 10°F, but are reasonably close above that temperature.

Values of Poisson's ratio determined by Tsyovich and Sumgin [7] on several artificially frozen soils using a method of torsion tests ranged from 0.2 to 0.5.

The value of Poisson's ratio for ice was determined by Ewing, Crary, and Thorne [3] to be 0.365 ± 0.007 by use of dynamic methods (longitudinal vibrations); the average curves of Poisson's ratio for ice presented in Figs. 8c and 9c show approximately the same value. The individual values, however, ranged from 0.28 to 0.47 in a 40°F range, with the greatest differences occurring between specimens frozen vertically. Natural lake ice ranged in μ from 0.32 to 0.36. From measurements of horizontal wave velocities in a supposedly isotropic ice sheet, Kohler [11] derived the value of 0.30. It is evident here that the same limitation to obtaining a reliable and reproducible value of Poisson's ratio holds for ice as for frozen soils.

The scope of these tests did not permit a study of the effect of various factors such as crystal size, structure, and orientation on the elastic properties of ice. The variations in water content and density in the frozen soils were incidental, resulting from varying degrees of uncontrolled ice segregation which occurred during freezing. Undoubtedly, these affected the elastic behavior. With the limited data available, an attempt was made to correlate unit density and water content and the elastic properties, but no consistent relationship could be found.

A study of graphs a through c in Fig. 10 indicates that the elastic properties, the dynamic moduli of elasticity and rigidity, and propagation wave velocities are principally dependent on the type of soil. The coarser-grained soils show higher wave velocities and greater moduli values. Note that the clays have the lowest values, with ice somewhat intermediate.

The limited data available are not sufficient to draw any conclusions as to what the effect was, if any, of the manner in which the soil specimens were frozen, i.e., vertically or horizontally, although one might expect that the orientation of ice-lenses in a beam of frozen soil would affect the overall dynamic properties. Additional experimentation with close control of such parameters as soil density and water content might shed more light on the subject. From a practical viewpoint, it would be extremely difficult to arbitrarily control the size and spacing of ice-lenses in frost-susceptible soils, frozen at normal rates with or without available free water.

SUGGESTIONS

Sonic (dynamic) methods have been used for many years in determining the quality of concrete in slabs and monolithic structures. Kesler and Higuchi [20] claim to have established a relationship between the dynamic modulus of elasticity, the damping capacity of concrete, and the compressive strength of concrete, which enables prediction of the strength of concrete within an error of 5%. Since frozen soils, concrete, and ice are visco-elastic materials, the viscous properties can be evaluated by recording the logarithmic decrement, a measure of the damping capacity.

Studies by Chang and Kesler [21] indicate that a relationship may exist between the static (creep) and dynamic behavior of concrete. Nakaya [6] used the dynamic method to study the viscous properties of ice. A promising field for further research and study would be to correlate the visco-elastic properties of frozen soils with dynamic properties.

CONCLUSIONS

Vibratory nondestructive techniques can be applied successfully in the laboratory to the study of dynamic elastic properties of frozen soils and of ice. The technique opens a fertile field for investigation of the visco-elastic properties of frozen soil. The dynamic moduli (E and G) and wave transmission velocities of frozen soils increased with a decrease in

temperature; the greatest rate of increase occurred between 20° and 32°F. At temperatures lower than 20°F, the dynamic properties of fine-grained soils (silts and clays) were markedly more temperature-dependent than those of the coarse-grained soils. This dependence is believed due chiefly to progressive freezing, with decreasing temperature, of additional pore water, both in the adsorbed layer and in the smaller pores, and is a function of grain size. The mineral composition of soil grains and type and quantity of ions present in the pore water may also be significant contributing factors. Alaskan peat (water content approximately 300% by weight) and ice showed only a slight increase in moduli and wave transmission velocities with decreasing temperature.

In the range of temperatures used in these investigations: (a) The elastic moduli for the coarser-grained soils were more than four times those for fine-grained soils and ice. (b) The wave velocities for coarser-grained soils were more than twice those for fine-grained soils and ice.

Values of Poisson's ratio for frozen soils as computed from average values of E (longitudinal vibrations) and G generally range between 0.25 and 0.38. Within this range, average curves of Poisson's ratio versus temperature showed a very irregular pattern unrelated to soil type, although the coarser soils gave more consistent results.

The dynamic elastic properties of ice, including wave velocities, were consistent with findings of other investigators. Values of Poisson's ratio for a given ice specimen showed remarkable consistency throughout the temperature test range, although the difference between some specimens was considerable. The average values of Poisson's ratio for the laboratory-frozen ice and natural lake ice, based on results obtained using longitudinal vibrations, ranged from 0.32 to 0.40, but the maximum range of individual values was 0.28 to 0.47.

Present limited data are insufficient to draw any conclusions as to the effect, if any, of the manner in which the soil specimens were frozen, i.e., in a vertical or horizontal position. However, values of Poisson's ratio computed for individual ice beams frozen vertically show a much greater deviation from the mean than those from horizontally-frozen beams, indicating a possible effect of crystal size and structure.

All the materials tested were anisotropic. Therefore, high accuracy cannot be expected from the use of simplified theory assuming isotropy.

Velocities and elastic constants developed by procedures outlined in this report may be useful in seismic explorations in permafrost and for predicting the response of frozen foundation materials to dynamic loading.

ACKNOWLEDGMENTS

This investigation was performed at the Arctic Construction and Frost Effects Laboratory (ACFEL), U.S. Army Corps of Engineers, New England Division, Waltham, Massachusetts (now CRREL at Hanover, N.H.). The work was performed under K. A. Linell, Chief, and J. F. Haley, Asst. Chief of the Laboratory. The author wishes to express his appreciation to Melvin Levey for assistance.

NOTATIONS

C	Factor depending upon the shape and size of the specimen, mode of vibration, and Poisson's ratio
E_f	Young's modulus of elasticity derived from flexural vibrations
E_L	Young's modulus derived from longitudinal vibrations
G	Modulus of rigidity (elastic modulus in torsional vibrations)
f_f, f_L, f_t	Fundamental resonant frequency corrected for mass of magnets

f'_f, f'_L, f'_t	Observed fundamental resonant frequency
g	Gravitational acceleration (386 in./sec ²)
i	Number of nodes
k	Ratio of radius of gyration of magnet to that of specimen (used in frequency correction formula for torsional vibrations)
L	Length of specimen
M	Weight of magnets
R	A geometrical factor used in torsion theory
V	Velocity of wave propagation
w	Unit weight of specimen
W	Total weight of specimen
μ	Poisson's ratio

Subscripts f, L, and t refer to flexural, longitudinal, and torsional vibrations, respectively.

REFERENCES

- [1] Frost Effects Lab., Corps of Engrs., U.S. Army New England Division, SIPRE. Investigation of description, classification and strength properties of frozen soils, Fiscal Year 1951, Vols. 1 and 2, SIPRE Rept. 8, Wilmette, Ill., June 1952.
- [2] R. W. Boyle, D. O. Sproule. "Velocity of Longitudinal Vibrations in Solid Rods (Ultrasonic Method) with Special Reference to the Plasticity of Ice," Can. J. Res., Vol. 5, 1931, pp. 601-618.
- [3] M. Ewing, A. P. Crary, A. M. Thorne, Jr. "Propagation of Elastic Waves in Ice," Pt. I, Physics, Vol. 5, No. 6, 1934, pp. 165-168.
- [4] M. Kornfeld, P. Shestikhim. "Elasticity of a Crystal as Dependent on Temperature," Compt. Rend., Akad. Sci. USSR, Vol. 36, No. 2, 1942, pp. 52-56.
- [5] B. L. Lagutin, A. P. Shul'man. Data on the Problem of Ice Crossings, Boston, Mass.: Arctic Construction and Frost Effects Lab. 1954, pp. 46-63 (revised ed. transl. No. 25).
- [6] Ukichiro Nakaya. "Visco-elastic properties of snow and ice in the Greenland Ice Cap.," SIPRE Res. Rept. 46, 1959.
- [7] N. A. Tsytoich, M. I. Sumgin. "Principles of Mechanics of Frozen Ground," Moscow, Akad. Sci. USSR, Ch. 5, 1937.
- [8] N. A. Tsytoich, I. S. Vologdina. Determination of Elastic Constants of Frozen Soils and Examination of Their Properties of Plasticity, Transl. Akad. Sci. USSR, Vol. 3, 1936, pp. 7-54.
- [9] T. D. Northwood. "Sonic Determination of the Elastic Properties of Ice," Can. J. Res., Vol. 25, 1947, pp. 88-95.
- [10] J. T. Wilson, R. Strong. Bibliography on Lake Ice, Ann Arbor, Mich., Engr. Res. Inst., Univ. Mich., 1948.
- [11] R. Kohler. "Beobachtungen an Profilen auf see-Eis," Z. Geophysik, Vol. 5, 1929, pp. 314-316.
- [12] T. R. Butkovich, J. K. Landauer. "Creep of Ice at Low Stress," SIPRE Res. Rept. 72, 1960.
- [13] G. Pickett. "Equations for Computing Elastic Constants from Flexural and Torsional Resonant Frequencies of Vibration of Prisms and Cylinders," Proc. Am. Soc. Testing Materials, Vol. 45, 1945, pp. 846-865.
- [14] (Lord) Rayleigh. Theory of Sound, New York, McMillan Publ. Co., 1929.
- [15] A. E. H. Love. Mathematical Theory of Elasticity, 4th Ed., Cambridge Univ. Press, 1922.
- [16] N. A. Tsytoich. "Fundamentals of Frozen Ground Mechanics," (New Investigations), 4th Intl. Conf. Soil Mechanics and Foundation Engineering, 1957, p. 116.
- [17] Hans Roethlisberger. "The Applicability of Seismic Refraction Soundings in Permafrost Near Thule, Greenland," SIPRE Tech. Rept. 81, 1961.
- [18] H. R. Joesting. "Geophysical Exploration in Alaska," Arctic, Vol. 7, No. 3, 1954, pp. 165-175.
- [19] M. Ewing, A. P. Crary. "Propagation of Elastic Waves in Ice," Pt. 2, Physics, Vol. 5, 1934, pp. 181-184.
- [20] C. E. Kesler, Y. Higuchi. "Determination of Compressive Strength of Concrete by Using Its Sonic Properties," Proc. Am. Soc. Testing Materials, Vol. 53, 1953, pp. 1044-1052.
- [21] T. S. Chang, C. E. Kesler. "Correlation of Sonic Properties of Concrete with Creep and Relaxation," T and AM Rept. No. 94, Univ. Ill., 1956.
- [22] K. F. Woitkovskii. "Mechanical Properties of Ice," Transl. by U.S. Army Map Service and Arctic Inst. of N. America for USAFCRL, Aug. 1962.

THERMAL PROPERTIES OF FROZEN GROUND

M. S. KERSTEN, University of Minnesota

This paper is based mainly on a study of thermal properties of soils made at the University of Minnesota between 1945 and 1949 under the sponsorship of the Corps of Engineers, U. S. Army. The Corps of Engineers found, from the study of problems encountered in the design and construction of airfields, roads, buildings, and other structures in cold regions, that a knowledge of thermal properties of soils was highly desirable. At that time information was lacking on the thermal conductivity of soil and its variation with soil conditions—particularly for frozen soils. The University of Minnesota study was primarily on thermal conductivity with some work on specific heat determination.

Work on soil conductivity has been continuing during the past 15 years. Soil probes have been developed and used for field tests [1, 2, 3]. A considerable amount of this work was done by those concerned with problems of heat loss from underground power cables. However, most of this work was on unfrozen soils. Very little seems to have been published on actual thermal conductivity values of frozen soils together with descriptive data on the soils. Higashi [4] has reported some laboratory test results on frozen soils, but the densities

were not in the range of the Minnesota tests. Lachenbruch reports the use of a probe for field tests, stating that it has been used "for more than 400 determinations *in situ* of the thermal conductivity of frozen and thawed soil materials including peat, clay, silt, sand, and gravel" [3].

Investigators have devised equations, charts, or nomograms to aid in the selection of thermal conductivity values [5, 6]. Several of these are reviewed [1, 7]. They refer mainly, however, to unfrozen soils.

MINNESOTA TESTS

The purpose of the thermal conductivity study at the University of Minnesota was to make tests on a large number of soil types at a variety of densities and moisture contents and at a range of temperatures so that the results could be studied to show which variables were important. (The term "density" has the same meaning as "dry unit weight"; units are lb/cu ft.) Equations or charts to estimate the thermal conductivity of a soil were to be developed when information such as textural classification, moisture content, and density were known.

Tests were made on 19 soils which represented a wide textural range, including gravel, sand, sandy loam, silt loam and clay, plus crushed rocks and peat. Moisture contents and densities were varied for each material, and tests were made at both above and below freezing. Results of almost a thousand individual conductivity values were determined [8].

TEST APPARATUS

Test apparatus including a tubular soil container was designed for the thermal conductivity tests. The soil container (Fig. 1) consists of three concentric sections of copper pipe. The smallest, or inner pipe, is divided into three parts, each containing a cartridge-type electric heater. The two outer pipes form a cooling chamber through which alcohol, at the desired temperature, is circulated. Soil is placed in the annular space between the inner and middle copper pipe. Other parts of the apparatus include alcohol tanks with heating and cooling units and temperature control, a motor-generator set for supplying power to the heaters, and a control table where measurements were made of temperatures on the hot and cold sides of the soil and the power input to the heaters.

MATERIALS TESTED

Table I lists the test materials with some of their physical constants. They are listed essentially in order of texture, from coarse to fine; peat soil is listed last. Of 19 materials, five were naturally occurring sand or gravel containing less than 3% silt and clay; seven were crushed rock or mineral and Ottawa sand—included to study the effect of mineral composition; six were naturally occurring soils containing 30% or more of silt and clay, varying in texture from sandy loams to a clay, and one was an organic soil, a peat.

In analyzing results the soils were divided into two groups by texture: Coarse grained and fine grained. For naturally occurring soils (not manufactured materials such as crushed rocks), soils P4601, P4709, P4604, P4503, P4502, and P4711 were considered as the coarse grained group and soils P4713, P4505, P4602, P4710, and P4708 were in the fine grained group. Thus P4711, Dakota sandy loam—about two-thirds sand—was considered as coarse grained and P4713, Ramsey sandy loam—about half sand—was considered as fine grained.

TEST CONDITIONS

Test conditions for each soil varied somewhat according to the soil characteristics, but in general the following procedure was used: Each soil was tested at several different moisture contents; these varied from an air-dried condition to moisture contents greater than the optimum moisture content of the so-called modified moisture-density compaction test (Method T-180, Am. Assoc. State Highway Officials). The greatest moisture content at which tests were made, excluding tests on the peat soil, was about 35% on the Healy clay. Most sand soils were tested at about four different moisture contents; the heavier textured soils such as silt loams and clays were tested at five to seven different moisture contents. In the soils tested the ice was distributed throughout the sample and did not occur in segregated layers.

At each moisture content, tests at different dry densities

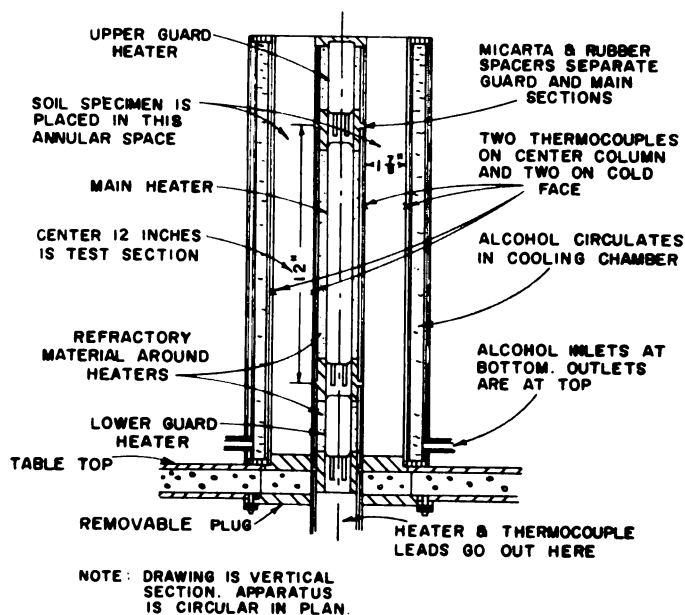

Fig. 1. Vertical section of soil tube for thermal conductivity tests

Table I. Soil properties in thermal conductivity tests

Soil no.	Soil name	Grain size analysis				Liquid limit	Plastic index	Range of conditions for conductivity tests	
		Gravel over 2mm	Sand 2.0 to 0.05mm	Silt 0.05 to 0.005mm	Clay below 0.005mm			Moisture content, % dry wt.	Dry density lb/cu ft
P4601	Chena River gravel	80.0	19.4	...	0.6	NP ^a	0.2 to 5.2	105 to 133
P4703	Crushed quartz	15.5	79.0	...	5.5	NP	0.0 to 4.3	103 to 120
P4704	Crushed trap rock	27.0	63.0	...	10.0	NP	0.2 to 3.8	103 to 120
P4705	Crushed feldspar	25.5	70.3	...	4.2	NP	0.1 to 4.1	103 to 120
P4706	Crushed granite	16.2	77.0	...	6.8	NP	0.1 to 4.1	102 to 120
P4702	20-30 Ottawa sand	0.0	100.0	...	0.0	NP	0.0 to 1.7	97 to 109
P4701	Graded Ottawa sand	0.0	99.9	...	0.1	NP	0.0 to 5.6	97 to 108
P4714	Fine crushed quartz	0.0	100.0	...	0.0	NP	0.0 to 4.6	97 to 108
P4709	Fairbanks sand	27.5	70.0	...	2.5	NP	0.2 to 17.6	107 to 123
P4604	Lowell sand	0.0	100.0	...	0.0	NP	0.2 to 17.7	91 to 118
P4503	Northway sand	3.0	97.0	...	0.0	NP	0.6 to 21.8	92 to 113
P4502	Northway fire sand	0.0	97.0	3.0	0.0	...	NP	0.5 to 14.0	97 to 116
P4711	Dakota sandy loam	10.9	57.9	21.2	10.0	17.1	4.9	1.9 to 18.4	84 to 137
P4713	Ramsey sandy loam	0.4	53.6	27.5	18.5	24.6	9.3	2.6 to 18.6	88 to 126
P4505	Northway silt loam	1.0	21.0	64.4	13.6	27.3	NP	1.4 to 23.0	75 to 114
P4602	Fairbanks silt loam	0.0	7.6	80.9	11.5	34.0	NP	2.2 to 39.0	70 to 109
P4710	Fairbanks silty clay loam	0.0	9.2	63.8	27.0	39.2	12.4	2.4 to 37.3	58 to 102
P4708	Healy clay	0.0	1.9	20.1	78.0	39.4	15.0	3.0 to 35.2	64 to 108
P4707	Fairbanks peat	NP	9.3 to 284.0	7.4 to 25

^aNP means nonplastic

were attempted. Densities varied from those obtained by just pouring dry sands to the maximum that could be obtained by heavy ramming. Data in the last two columns of Table I indicate the range of moisture contents and dry densities represented in the conductivity tests on each soil.

Thermal conductivity tests were made at four temperatures. Approximate mean temperatures were 70, 40, 25, and -20°F. In each case a 10° temperature differential was applied to the soil; i.e., for the 70° test the hot side was at 75°F, the cold side at 65°F. The conductivity value was determined in a 4- or 5-hour run after a balanced condition was reached.

THERMAL CONDUCTIVITY VALUES

Because most studies on thermal conductivity of soil have been made at above-freezing temperatures, it is interesting to compare thermal conductivity (k) of soil at mean temperatures 25° and 40°F. The hot and cold side temperatures for these tests were 30° and 20°F in the first case, and 45° and 35°F in the other.

The ratio of the k-value at 25° to 40°F was found to be chiefly dependent on the moisture content. This is illustrated in Fig. 2 for two soils—one sandy, the other fine textured. The variations are typical of those found for other sandy and silt and clay soils. For soils that were quite dry, very little difference was found in the two k-values. At low moisture contents (about 6 to 9% in sandy soils and about 12% in silty and clayey soils) the k-value for the frozen soil was slightly less than that of the unfrozen soil. For moisture contents increasing above those indicated, the ratio of k at 25°F to k at 40°F becomes increasingly greater than 1.0.

Since ice has a greater thermal conductivity than water, the ratios of more than unity for high moisture contents are to be expected. A possible explanation of the lower conductivities for frozen soils at low moisture contents is that the ice in such soils may not have had the same continuity that the water films had. It is also possible that in this particular test apparatus, there was a poorer distribution of the ice content in the soil sample between the hot and cold faces than there was of the water content for the 40°F tests. There are no data to support either of these suggestions.

COMPARISON OF CONDUCTIVITY VALUES

The relationship of the conductivity values at temperatures below the freezing point, 25° and -20°F, appears to depend on moisture content. For tests made on all soils, excluding the peat, the ratio of the conductivity at -20° to that at 25°F for moisture contents of 0 to 5% (121 tests) average 0.99; 5 to 10% (22 tests), 1.01; 10 to 15% (21 tests), 1.05; 15 to 20% (13 tests), 1.06; and 20% or more (15 tests), 1.04. Thus, on the basis of averages of a large number of tests, conductivity

of frozen soils does not vary markedly in a temperature range from 25° to -20°F. Conductivity at -20° becomes somewhat greater than at 25°F as the moisture content increases. Further inspection of the data indicates that the increase in conductivity of frozen soils for a drop in mean temperature is greater for a soil with a high density than for that with a low density.

EFFECT OF MOISTURE CONTENT

Since conductivity values for frozen soils do not vary widely for a temperature variation from 25° to -20°F, only the test results at 25°F are considered in this discussion on the effect of moisture content. (The term "moisture content" is used, although "ice content" might be more appropriate.)

When values for soils tested at a wide range of moisture contents were inspected, k-values and moisture content for a given dry density appeared to have a straight line relationship on arithmetic paper. Results for two soils are shown in Fig. 3; one soil is a sand, the other a silty clay loam. Thus, the equation for the thermal conductivity for a given soil at a given density can be written.

$$k = A + B (\text{moisture content}) \quad (1)$$

A and B being constants, and the moisture content being a percentage of the dry weight of the soil.

To indicate the numerical increase in thermal conductivity for moisture content ranges, the average value of B (i.e., the increase in k for a 1% increase in moisture content) is about 1.0 for sands and 0.5 for silt and clay soils. These values also vary with the dry density, being somewhat more for high densities, and less for low densities.

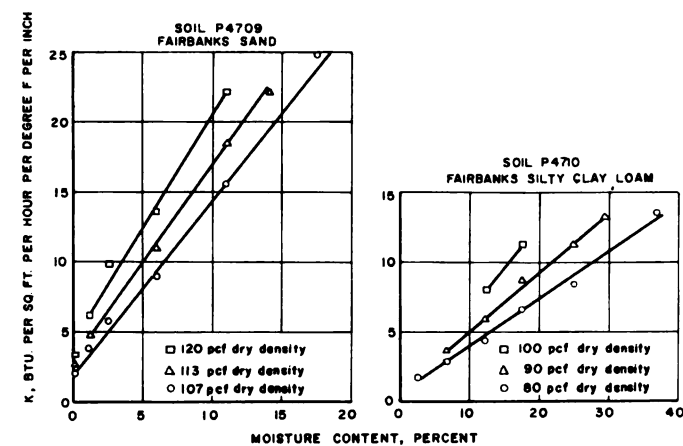

Fig. 3. Variation of thermal conductivity with moisture content of soil, mean temperature 25°F

The effect of moisture content might also be considered by expressing moisture in terms of the degree of saturation of the void space. A soil whose voids are entirely filled with ice would be 100% saturated; if only half the voids were filled it would be 50% saturated.

Fig. 4 shows the data of Fig. 3 plotted on the basis of percentage of saturation. Curves for different densities are close together; i.e., if moisture is expressed in terms of percentage of saturation, conductivity varies directly with this percentage, and the effect of variations in dry density at a given percentage of saturation is small (within the range of densities tested).

Because many soils in the field may exist at moisture contents close to 100% saturation, the conductivity values of the soils in this test may be of interest. Saturation was not always attained in the actual tests; therefore, estimated values for 100% saturation were obtained by extending the straight line curves (as in Fig. 4) to reach this point. Fig. 5, based on such values, indicates two groups of points. The

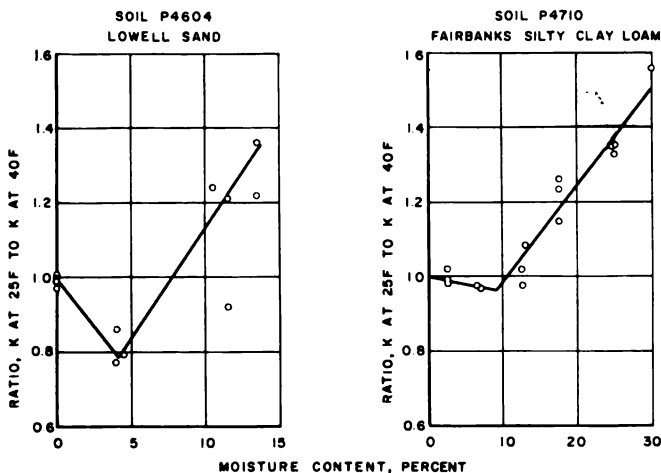

Fig. 2. Variation of conductivity (below to above freezing) with moisture content of soil

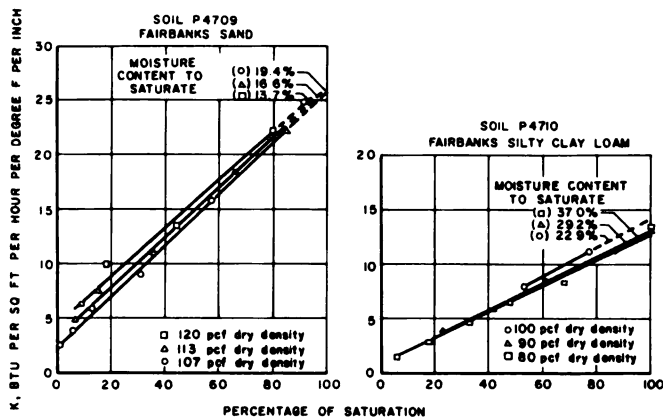

Fig. 4. Variation of thermal conductivity with percentage of saturation, mean temperature 25°F

points for seven of the soils for the various density curves which could be drawn (17 points) give conductivity values varying between 11 and 17 Btu/sq ft/hour (for a thermal gradient of °F/in.).

The soils in this group include all the fine-textured silty and clay soils, with some sandy ones.

The other group is for three soils, all sands or sandy soils; conductivity values are between 21 and 27.

Ice has a conductivity value of about 15. Thus one would expect that the conductivity of a saturated soil would approach this value if the density was low. Recognizing the possible errors in the extrapolation required to obtain some of the points of Fig. 5, the average value of about 14 for one group of points is probably not far out of line. Sandy soils with high quartz contents have high conductivities when frozen, as indicated by the high group of values in Fig. 5. With a decrease in density, the conductivity of saturated sands would probably decrease and approach 15; the points of Fig. 5 and inspection of Fig. 4 indicate only very slight reductions.

EFFECT OF DENSITY

An increase in density at a given moisture content resulted in an increase in thermal conductivity (Fig. 3). Fig. 6 shows graphs for two soils on a semilog scale. This variation can be written

$$k = A(10)^B (\text{density}) \quad (2)$$

A and B being constants. Curves for both soils in Fig. 6 have fairly constant slopes. As an average, an increase of 1 lb/cu ft in density will increase the k-value of a soil by about 3% for the range of moisture contents and densities

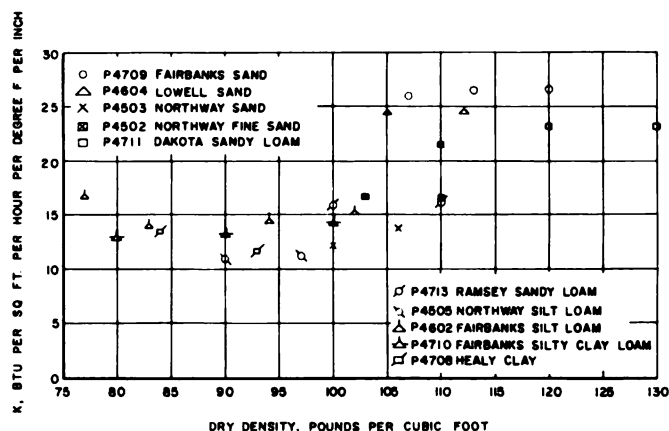

Fig. 5. Variation of thermal conductivity and density for 100% saturated soils, mean temperature 25°F

included in these tests.

EQUATIONS AND CHARTS

The purpose of the thermal conductivity tests was to determine the effect of the important variables and also to formulate equations or charts which could be used to estimate thermal conductivities of other soils at their existing conditions. Such charts must represent certain average conditions and hence will not be as correct as an actual test on each soil.

The most important variables for frozen soils were found to be the texture of the soil, the moisture content, and the dry density.

Textural variations were simplified by dividing soils into two groups: "Sand and gravel" and "silt and clay." In general, if a soil has more than 50% sand and gravel, it is in the first group; if it has more than 50% silt and clay, it is in the second group.

Equations for variations in moisture content and density were compared for one group, and an attempt was made to select the best average coefficients. The equations arrived at in this manner for the sand and gravel soils were

$$k = 0.076(10)^{0.013\gamma} + 0.032^{0.0146\gamma} (\text{moisture content}) \quad (3)$$

For the silt and clay soils

$$k = 0.01(10)^{0.022\gamma} + 0.085(10)^{0.008\gamma} (\text{moisture content}) \quad (4)$$

These equations are for frozen soils, γ is the dry density in pcf and the moisture content is a percentage of the dry weight. The equations are not meant for moisture contents below 1% for sands and gravels, nor below 7% for silts and clays.

To make use of these equations for selecting conductivity values for soils known to exist at certain moisture contents and densities, the charts of Fig. 7 have been prepared. One curve is for silt and clay soils, the other for sandy soils. The 100 and 50% saturation curves are calculated for an assumed specific gravity of 2.70 for the soil solids and 1.09 for the ice.

Since the charts are admittedly the result of averaging the tests on a variety of soils, some error is expected in their use. For five fine-textured soils (P4713, P4505, P4602, P4710, and P4708), 124 tests were made at below-freezing temperatures. To indicate the general nature of agreement of the charts with the measured thermal conductivity values in the Minnesota tests, the following values are given: The ratio of k by equation to k by test varied between 0.9 and 1.10 for 67 tests, between 0.8 and 1.20 for 107 tests, and between 0.7 and 1.30 for 120 tests. For the sand and gravel soils, the chart (Fig. 7) checks the test results very well for three of the clean materials (Chena River gravel, Fairbanks sand, and Lowell sand), with 39 of 42 tests within 25%. The tests which do not check are essentially those with less than 3% moisture content. The two Northway soils did not check

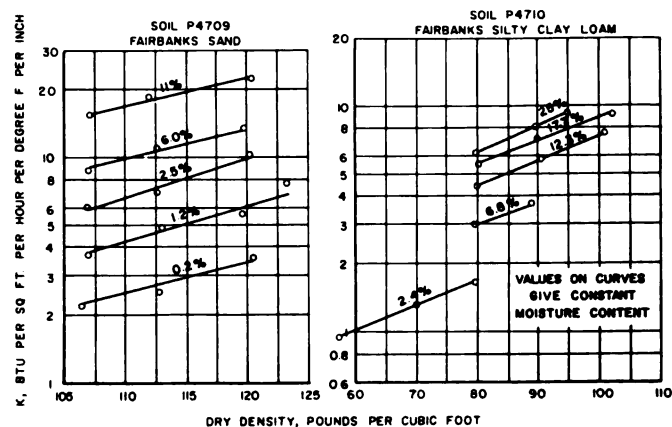

Fig. 6. Variation of thermal conductivity with dry density of soil, mean temperature 25°F

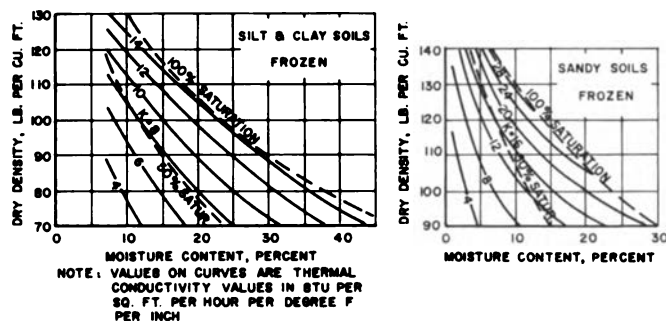

Fig. 7. Diagram of thermal conductivity of frozen soils

the chart very well; this is attributed to their peculiar mineral composition. Where other sands were dominantly quartz (43 to 72%), Northway sands had only about 10% quartz. Because of this peculiarity, the results on the Northway sands were discounted in preparation of the chart.

To obtain a more accurate estimate for a given soil, its grading, dry density, and moisture content can be compared with the individual soils and test conditions included, and in many cases a comparable test situation can be found [8].

There is continuing need to accumulate data on measurements of thermal conductivity of soil together with such soil information as texture, moisture content, and density. With compilations of such information, tables or charts can be

improved and thus made more helpful in estimating conductivity values for other soils.

REFERENCES

[1] AIEE Insulated Conductors Committee. "Soil Thermal Characteristics in Relation to Underground Power Cables," *AIEE Trans.*, Vol. 79, Pt. 3, 1960, pp. 798-856.
 [2] M. Van Rooyen, H. F. Winterkorn. "Structural and Textural Influences on Thermal Conductivity of Soils," *Proc. Highway Res. Bd.*, Vol. 38, 1959, pp. 576-621.
 [3] A. H. Lachenbruch. "A Probe for Measurement of Thermal Conductivity of Frozen Soils in Place," *Trans. Am. Geophys. Union*, Vol. 38, 1957, pp. 691-697.
 [4] A. Higashi. "On the Thermal Conductivity of Soils, with Special Reference to That of Frozen Soil," *Trans. Am. Geophys. Union*, Vol. 34, No. 5, 1953, pp. 737-748.
 [5] M. W. Makowski, K. Mochlinski. "An Evaluation of Two Rapid Methods of Assessing the Thermal Resistivity of Soil," *Proc. Inst. Electrical Engrs.*, Vol. 103, Pt. A, 1956, pp. 453-470.
 [6] A. S. Mickley. "The Thermal Conductivity of Moist Soil," *AIEE Trans.*, Vol. 70, Pt. 2, 1951, pp. 1789-1797.
 [7] M. Van Rooyen, H. F. Winterkorn. "Theoretical and Practical Aspects of the Thermal Conductivity of Soils and Similar Granular Systems," *Bull. 168, Highway Res. Bd.*, 1957, pp. 143-205.
 [8] M. S. Kersten. *Final Report, Laboratory Research for the Determination of the Thermal Properties of Soils*, Corps of Engineers, U. S. Army, 1949.

PLASTIC DEFORMATION OF FROZEN SOILS

F. J. SANGER AND C. W. KAPLAR, U. S. Army Cold Regions Research and Engineering Laboratory

Experience has shown that frozen soils under load are not usually Hookean solids, but may have an irrecoverable deformation after an initial elastic strain. It is also known that the rheological properties are very sensitive to temperature, an important characteristic of viscosity.

The main purpose of the investigation was to study the effects of temperature and stress on the plastic, i. e., irrecoverable, deformation of several frozen soils under unconfined compression at a constant load.

Preliminary work on six soil types [1] showed that good dead-weight load tests could be made in a small space under close temperature control, and that for these tests, a specimen should be under load for at least 60 hours. Time increases with decreasing temperature and stress, and depends on soil properties, temperature, and load. This paper deals with tests conducted on eight frozen soils: 1. McNamara concrete sand (SM); 2. Manchester fine sand (SNH); 3. New Hampshire silt (SNHS); 4. Fairbanks silt (SFS); 5. Yukon silt (SYS); 6. Fargo clay (SFFC); 7. Boston blue clay (SBC), and, 8. Alaskan peat (SAP).

Similar tests were made on artificial ice for comparison. The soils and sample preparation are described in the Appendix. Soils 1, 4, 6, and 8 are studied in this paper, with special attention to No. 6, Fargo clay, owing to exceptionally good data.

The specimens consisted of cylinders about 2-3/4 in. in diameter and about 6 in. high, each carefully trimmed to ensure that the ends were square to the axis. Just before being tested, each specimen was coated with a thin film of petrolatum to prevent ice sublimation during the comparatively long loading period. The specimens of clay and peat were carved out of undisturbed blocks; others were remolded close to natural densities. (See Appendix.)

Nominal compressive stresses of 20, 50, and 80 psi were used; test temperatures were 20°, 25°, 28°, and 31°F, and occasionally 32°F.

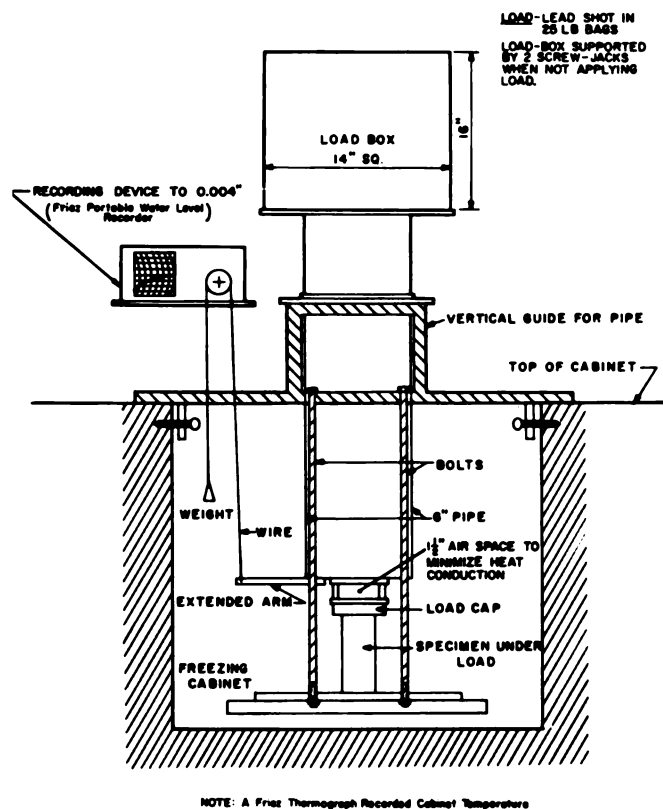

Fig. 1. Diagram of test apparatus for plastic deformation tests

TEST PROCEDURE

Fig. 1 illustrates the test equipment set up in a freezing cabinet where the temperature could be held to within three-fourths of a degree of the range from 12° to 31° F. This simple test apparatus worked very well and generally gave trustworthy results.

The specimen was first centered with a cap which applied a seating load of 6 lb. Bags of lead shot were placed in the container to make up the desired load. This was then gently lowered to just touch the load cap. When everything was ready, the load was applied to the specimen by a quick release of the mechanical jacks, following a very small seating load, and was left on as long as desired, or until the deformation reached 2 in., the limit of the jacks. The test condition was hence "constant load" rather than "constant stress," and no impact was initially applied.

ADJUSTMENTS OF TEST RESULTS

The laboratory tests resulted in deformation-time curves at specified temperatures and conventional stresses (based on initial cross-sectional area). Since the diameter of a specimen increased with time, the actual stress was diminishing with time.

The actual stress was computed on the assumption of constant volume and the maintenance of cylindrical form. The natural (logarithmic) strain was then adjusted to constant stress by assuming that for very small changes, strain was proportional to stress.

For equivoluminal deformation, $\mu = 0.5$ (a reasonable assumption for converting λ to η) and

$$\eta = \frac{\lambda}{2(1 + \mu)} = \frac{\lambda}{3} \quad (\dot{\epsilon} = \frac{\sigma}{\lambda})$$

Fig. 2 shows typical strain-time curves for a frozen clay—SFFC. The three stages of creep are clearly seen on one curve (32° F, 80 psi), and the effects of changes in stress and in temperature are evident.

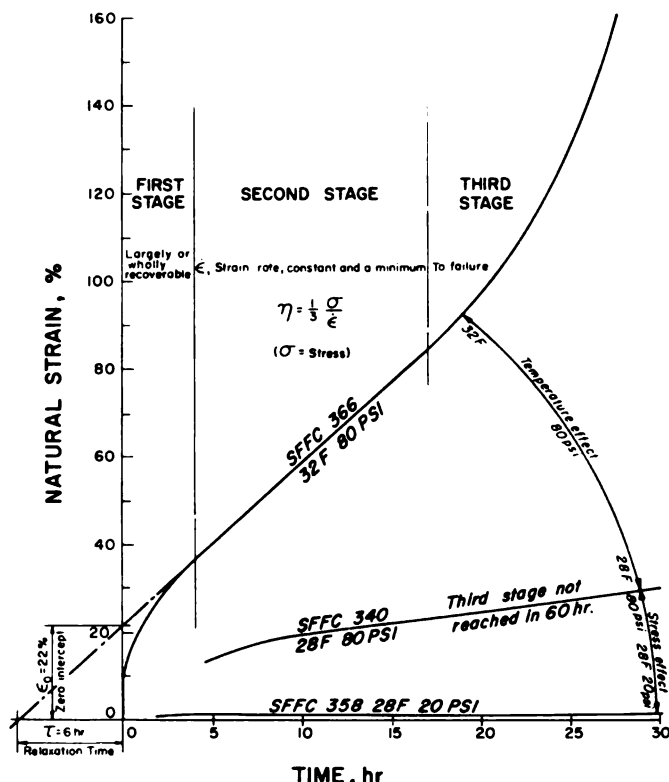

Fig. 2. Typical time-strain curves (Fargo clay)

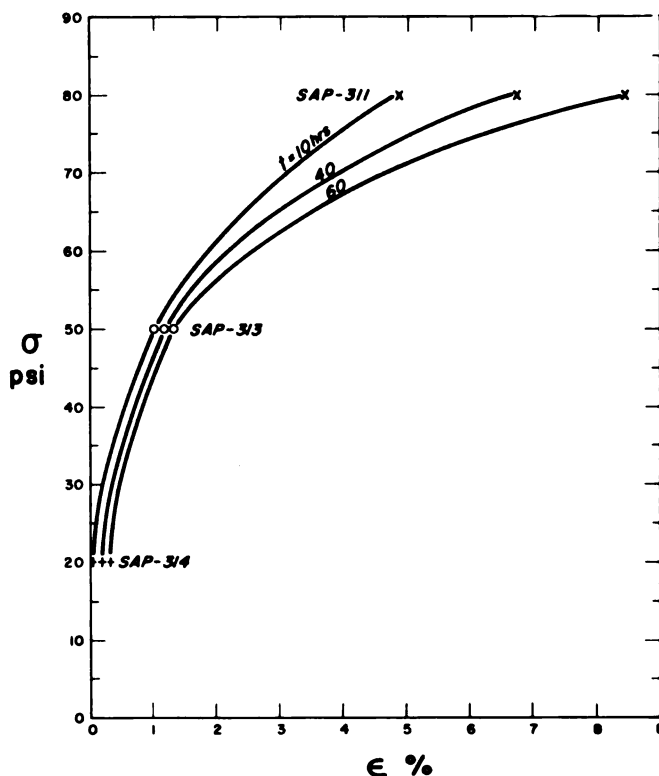

Fig. 3. Typical strain-stress curves at constant temperature (Alaskan peat) at 29° F

For each soil analyzed, three nominal stresses, 20, 50, and 80 psi, and three or four nominal temperatures, ranging from about 20° to 32° F, were test parameters for the study of these relationships: (a) Time—strain at constant stress and temperature; (b) time-stress-strain (isometric triaxial plot) at constant temperature; and (c) temperature-stress—rate of strain.

Where data permitted, other parameters were studied, in particular, the relationship between rheological properties and "ice" content of the soil.

Fig. 3 shows typical curves of stress and strain for constant temperature and variable times. Each curve can be conveniently expressed by a hyperbolic sine function of stress. Figs. 4 through 8 summarize the laboratory data.

STRAIN RATE, STRESS, AND TEMPERATURE OF FARGO CLAY

It seemed reasonable to express temperature in terms of degrees below the melting point (θ), since $\dot{\epsilon}$ gets comparatively very large if θ approaches zero, and Russian investigators had found degrees of frost a valuable parameter [3, 4]. Within the boundary conditions of the tests, by curve-fitting techniques, the minimum strain rate can be expressed as:

$$\dot{\epsilon} = 80 \times 10^{-6} \sinh b\theta^{-1} \text{ per hour}$$

where $b = 1.45 \exp(0.029 \sigma)$.

The very strong dependence on stress is evident. No simple equation of the type $\dot{\epsilon} = B(T)\sigma^n$ where T is absolute temperature and n is a constant can apply, although the expression given is by no means unique.

Zero Intercept

For Fargo clay (by curve-fitting)

$$\epsilon_0 \% = 4.0 \sigma \theta^{-2.3}$$

Then total strain for Fargo clay (assuming that the third stage is not reached) is

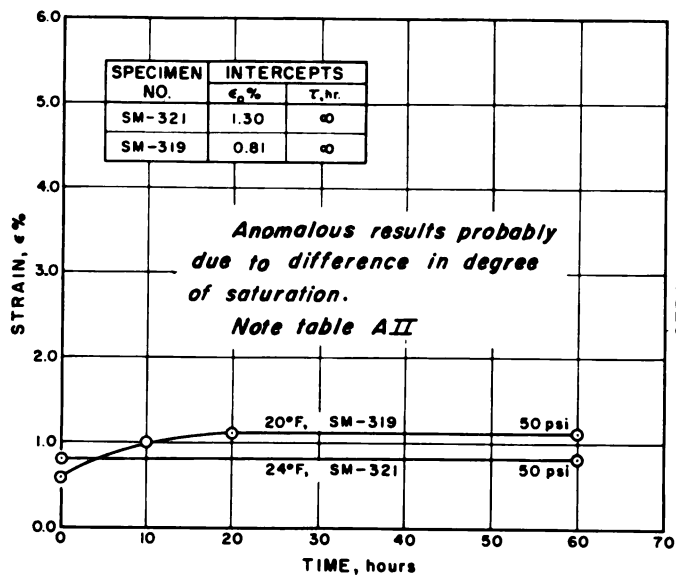

a. STRAIN-TIME at 20°F and 24°F

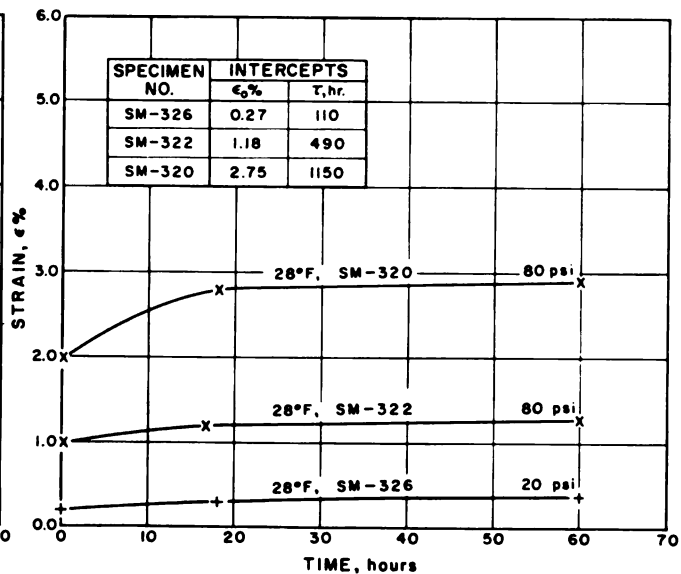

b. STRAIN-TIME at 28°F

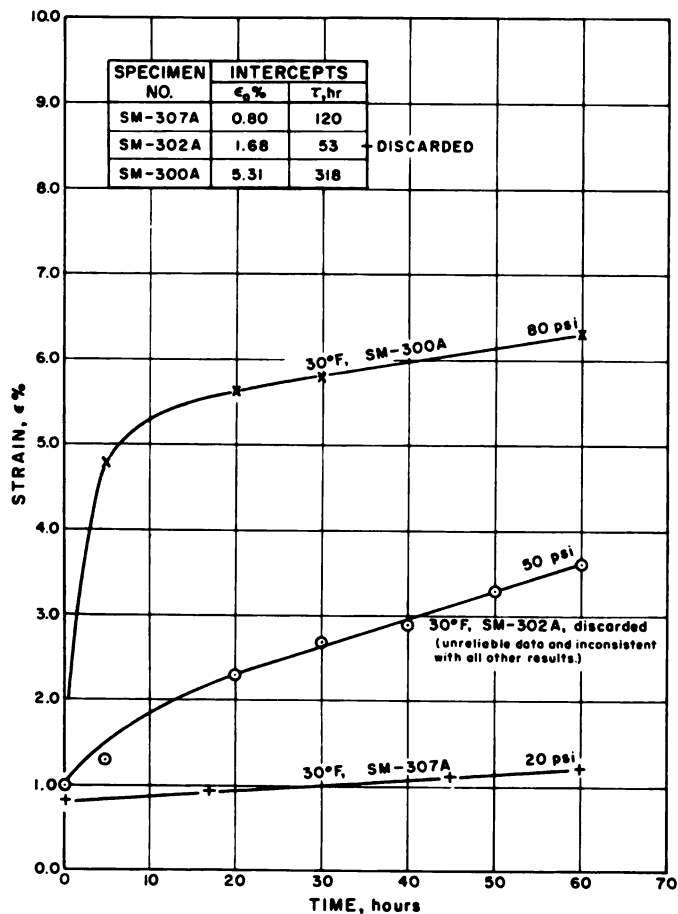

c. STRAIN-TIME at 30°F

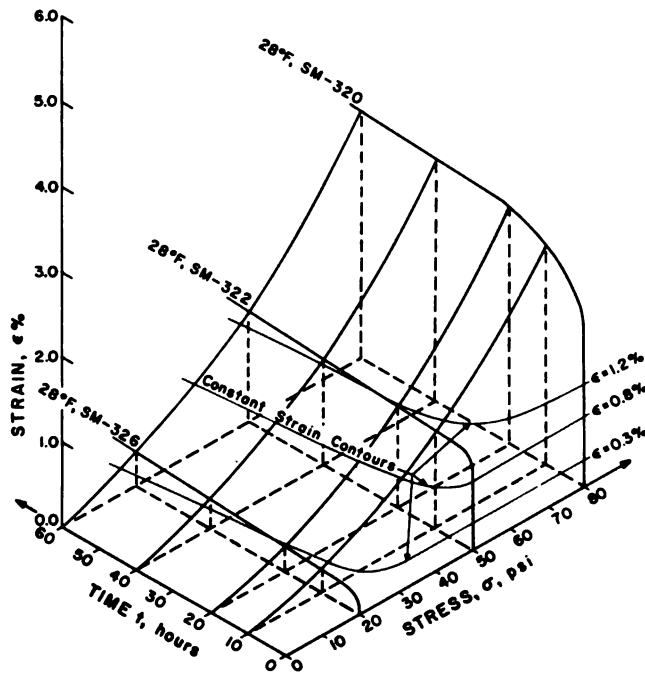

NOTE:
 Strain contours are arbitrary.

d. TIME-STRESS-STRAIN at 28°F

Fig. 4. Summary of time-stress-strain data for frozen McNamara concrete sand

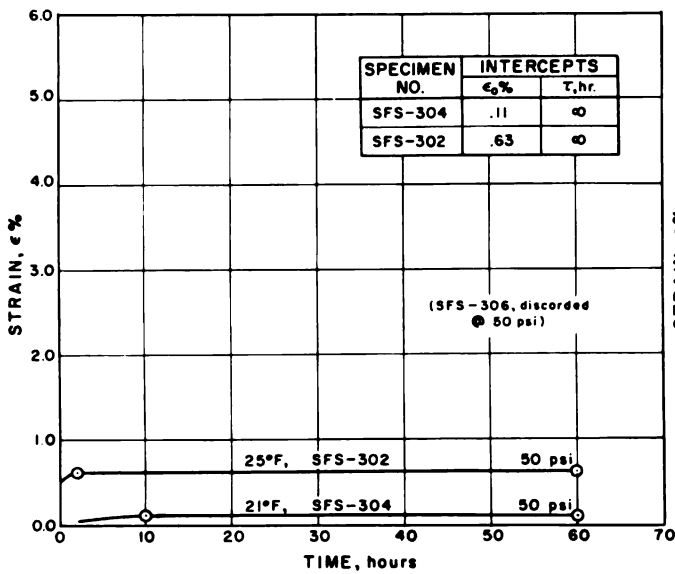

a. STRAIN-TIME at 21°F and 25°F

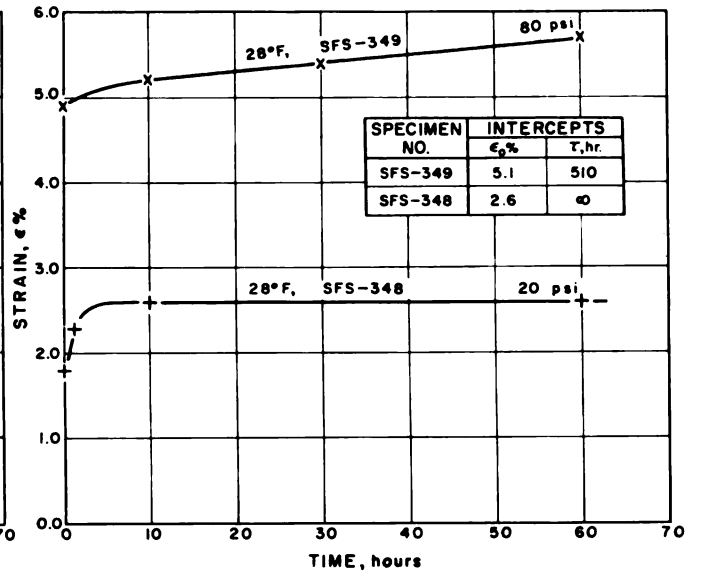

b. STRAIN-TIME at 28°F

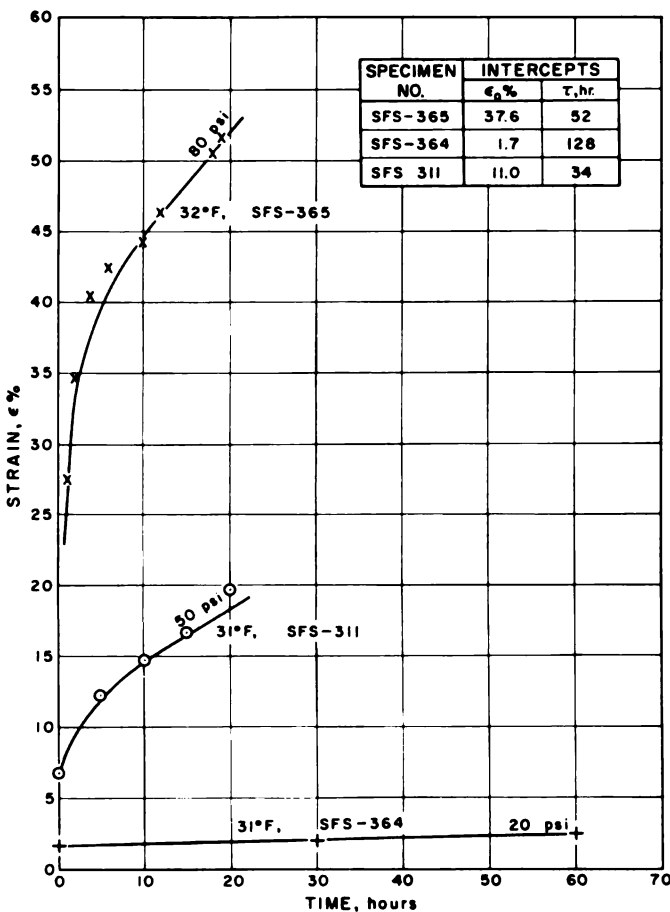

c. STRAIN-TIME at 31°F and 32°F

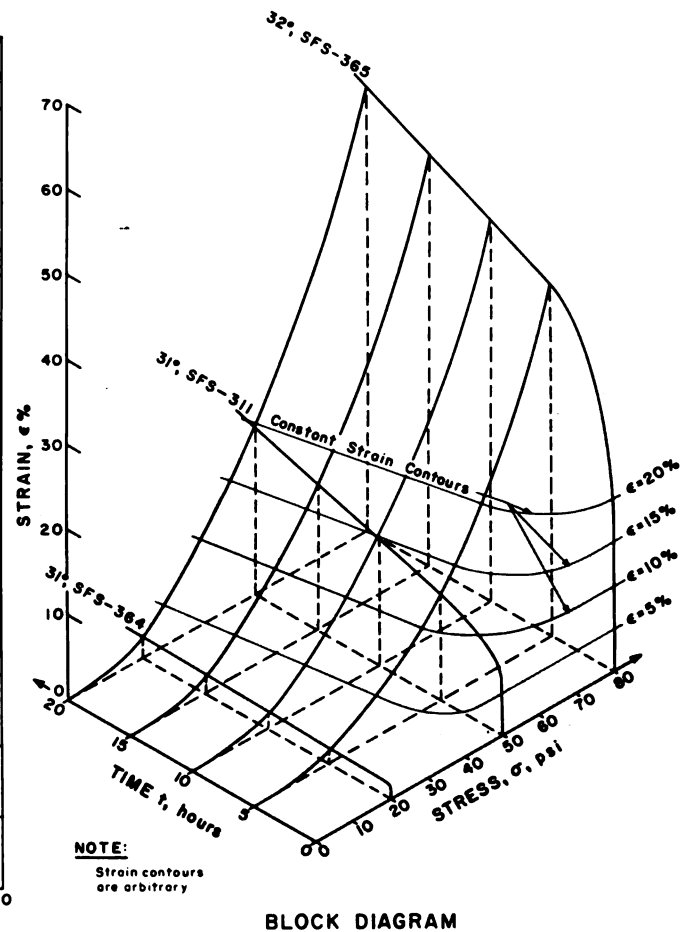

d. TIME-STRESS-STRAIN at 31°F and 32°F

Fig. 5. Summary of time-stress-strain data for frozen Fairbanks silt

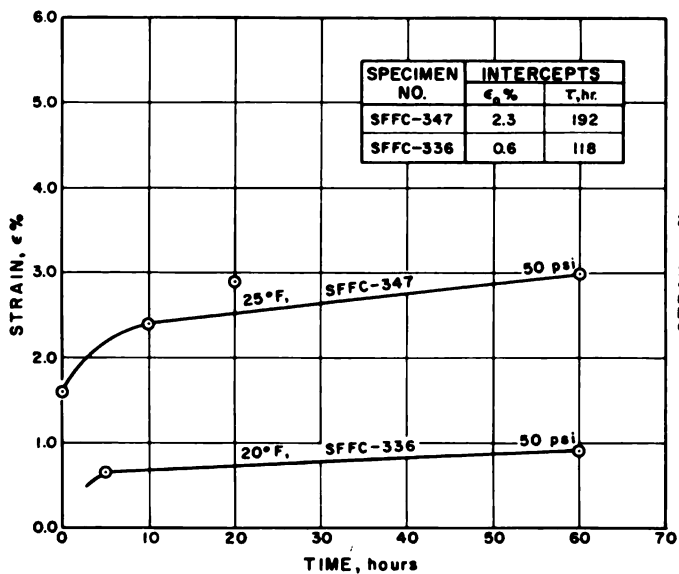

a. STRAIN-TIME at 20°F and 25°F

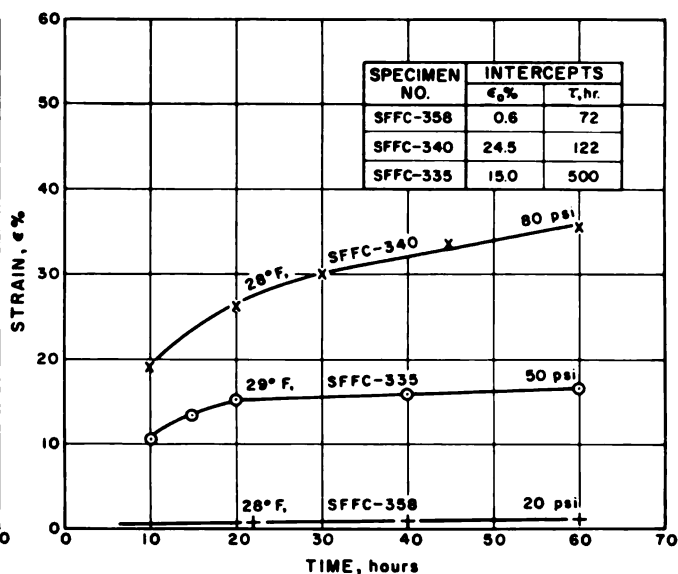

b. STRAIN-TIME at 28°F and 29°F

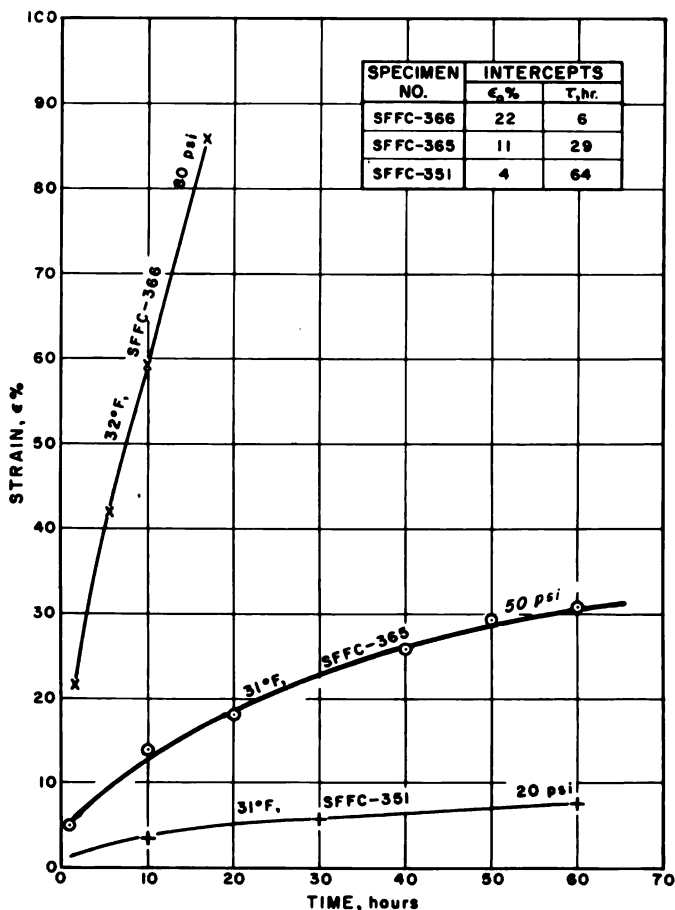

c. STRAIN-TIME at 31°F and 32°F

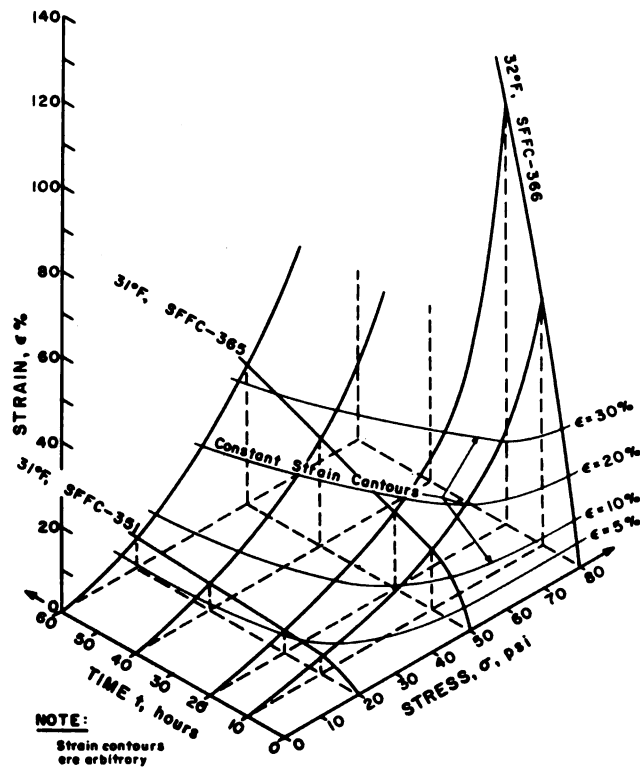

d. TIME-STRESS-STRAIN at 31°F and 32°F

Fig. 6. Summary of time-stress-strain data for frozen Fargo clay

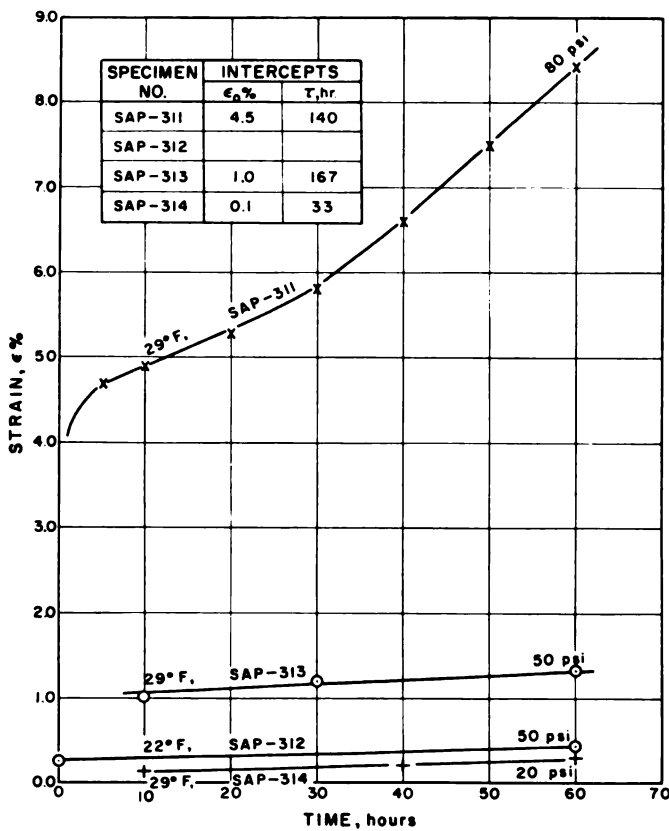

d. STRAIN-TIME at 29°F

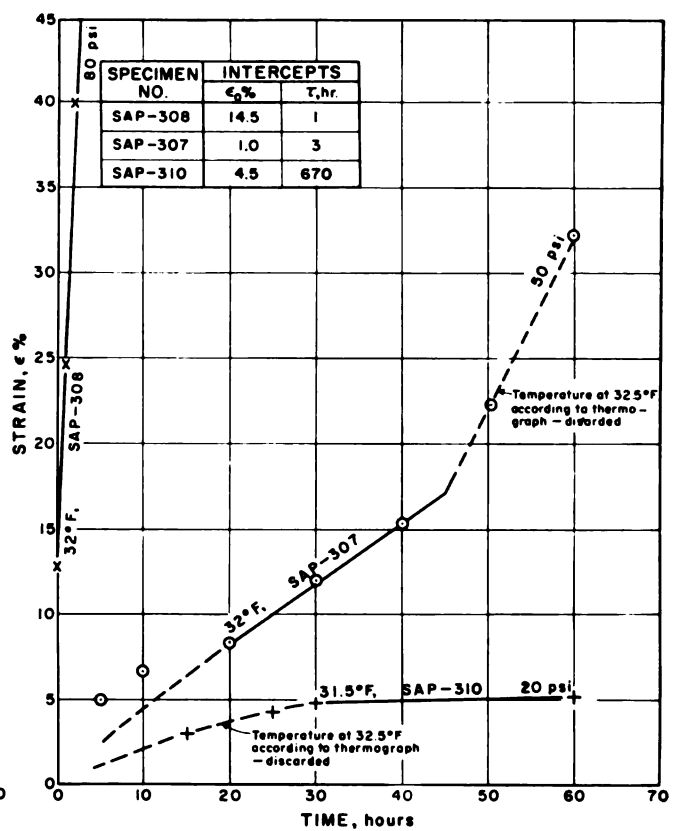

b. STRAIN-TIME at 31°F to 32°F

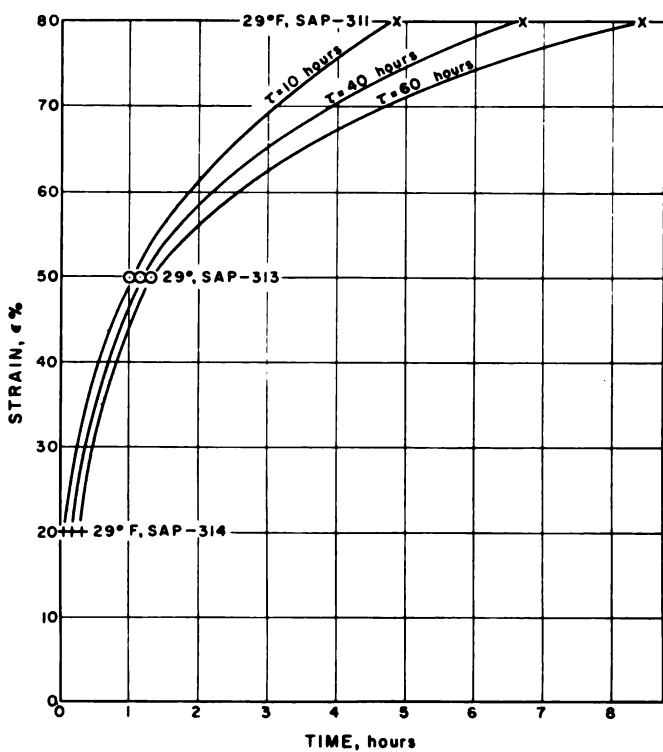

c. STRESS-STRAIN at 29°F

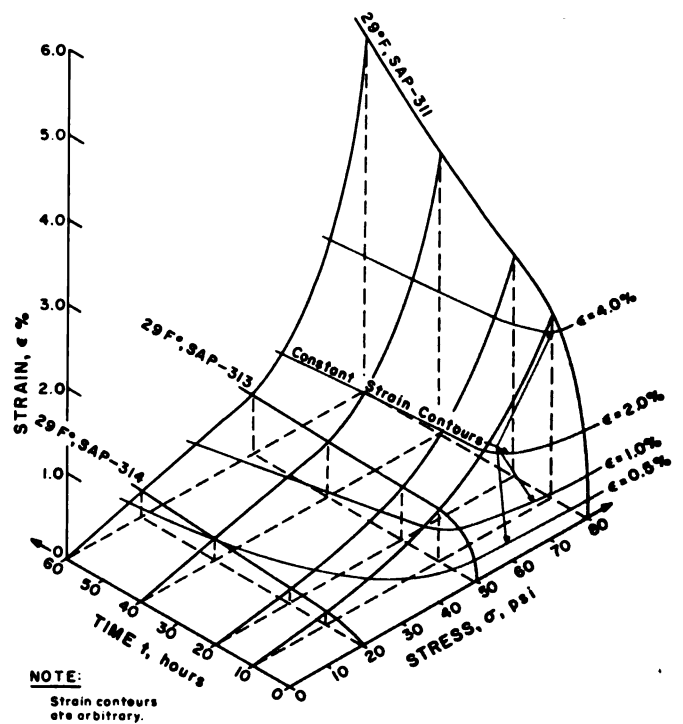

BLOCK DIAGRAM

d. TIME-STRESS-STRAIN at 29°F

Fig. 7. Summary of time-stress-strain data for frozen Alaskan peat

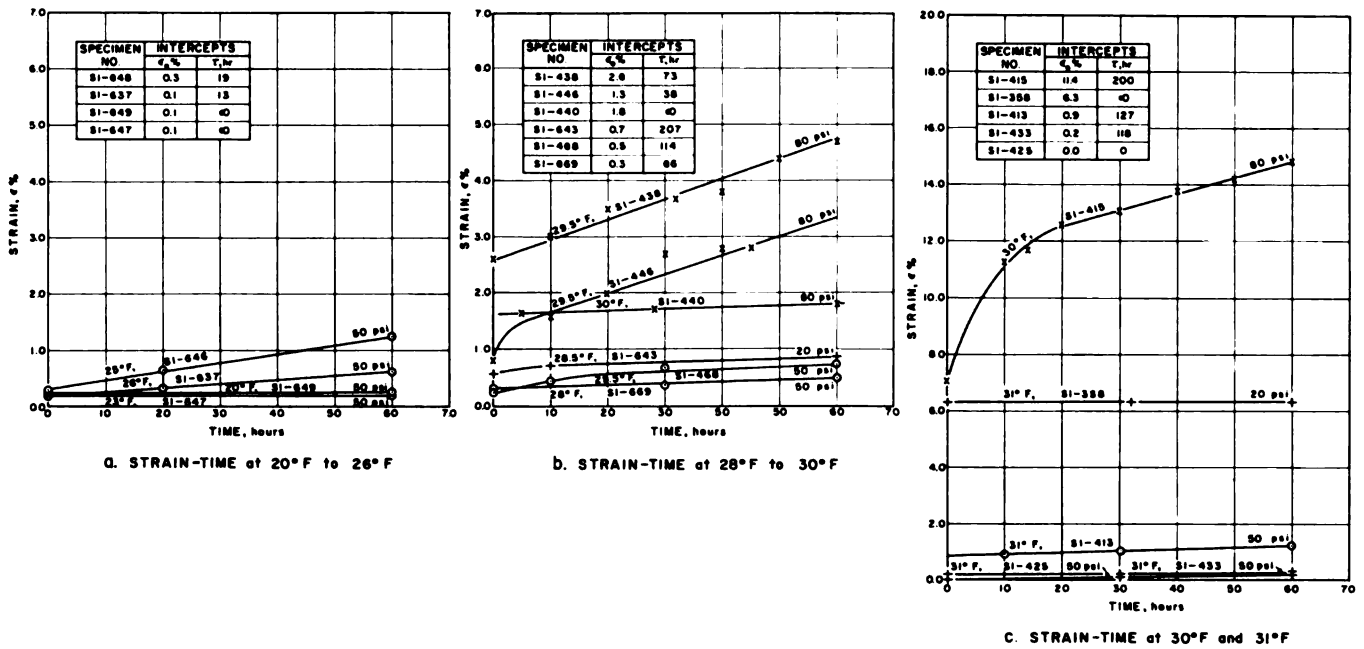

Fig. 8. Summary of time-stress-strain data for artificially frozen ice

$$\epsilon \% = 4.0 \sigma \theta^{-2.3} + 80 \times 10^{-4} (\text{Sinh } b\theta^{-1}) t$$

where t is in hours.

DISCUSSION

Limiting Creep Stress

Results indicated that the frozen soils usually had some temperature-stress conditions at which the deformation under constant load remained constant. Analysis of the data for this project led to no useful generalizations, and only tests can determine the particular conditions with an unknown soil.

Soils and Ice

Ice seemed to have a lower strain rate than saturated (or almost saturated) soils at the same temperature and stress. The data showed considerable scatter, and the existence of any limiting creep stress is uncertain. The average unit weight of 24 ice specimens was 56.6 pcf; most specimens weighed 55 pcf, and the values spread from 52 to 59 pcf.

Strain-Rate and Soil Properties

An important basic parameter seemed to be the volume of water-ice as compared with the volume of mineral grains. Other variables are soil type; nature of minerals in the soil; surface conditions of clay minerals; degree of soil compaction; degree of soil saturation; mode of ice occurrence—whether homogeneous or not; and amount of unfrozen water as percentage of total water substance (in fine-grained soils).

The ratio of volume of ice to volume of soil grains, termed here the "volumetric ice-soil ratio," was the most significant, so it was used for comparing the soils. The assumption that all water was frozen had a very small effect on the volume computation.

The other parameters used were minimum rate of natural strain ($\dot{\epsilon}$), nominal stress (σ), and temperature (T). Figs. 9 through 11 show some results of the analysis. The high strain rate in clays reflects the depressed freezing point and high proportion of unfrozen water. "Ice" (in Figs. 9, 10, 11) means total water substance in a frozen soil.

Little was done with the secondary rheological parameters which were computed, and no attempt was made to find a

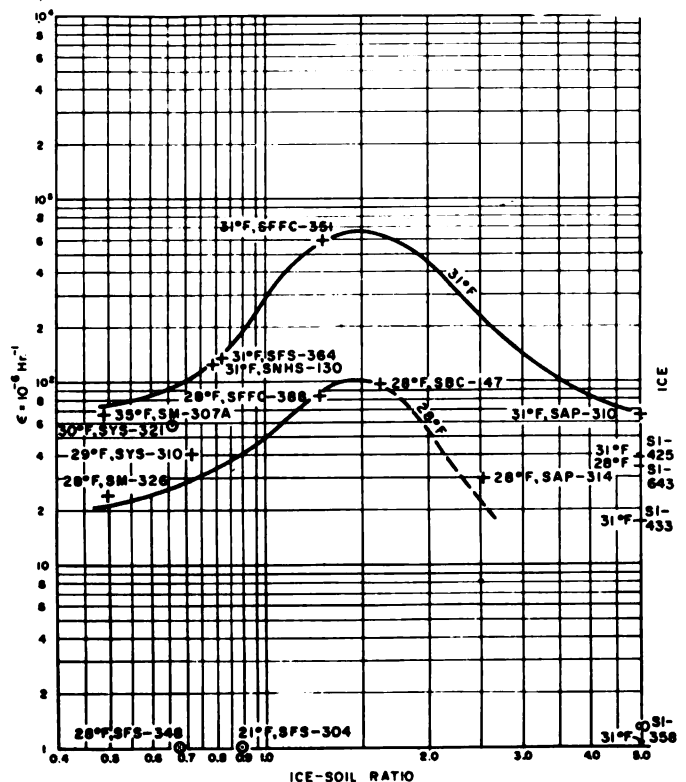

Fig. 9. Rate of strain-volumetric ice-soil ratio at 20 psi

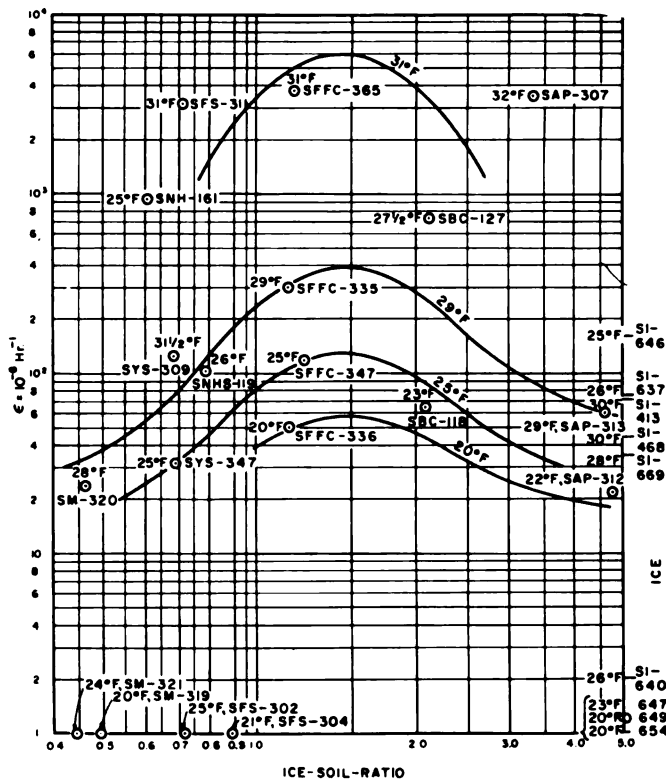

Fig. 10. Rate of strain-volumetric ice-soil ratio at 50 psi

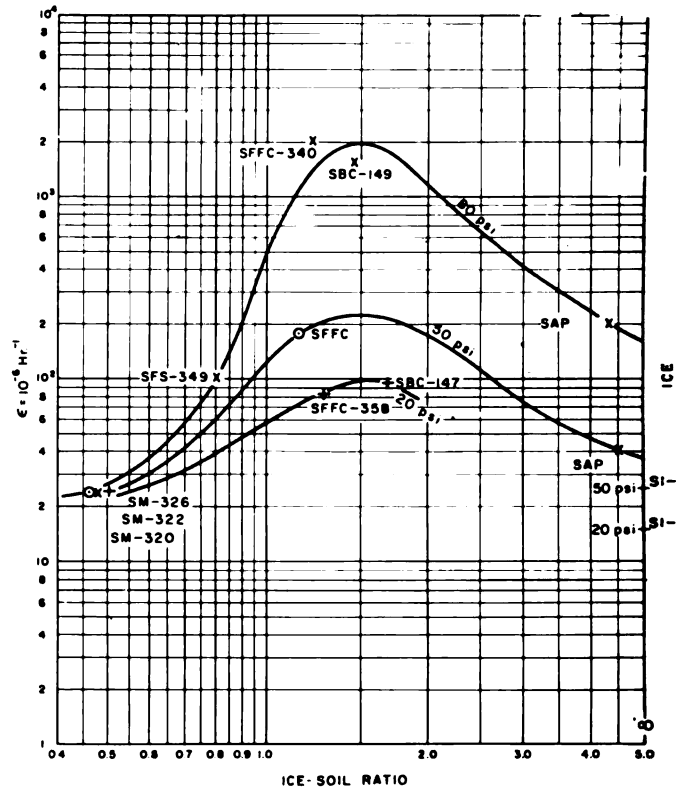

Fig. 11. Rate of strain-volumetric ice-soil ratio at 28°F

Table. Summary of analytic results

	Specimen No.	Temp. (°F)	Vol. Ice / Vol. soil	ε _o (%)	t hour	10 ⁻⁶ ε / hour	10 ⁶ λ / psi-hour	10 ⁶ η / psi-hour
McNamara Concrete Sand	SM-326 ^a	28	0.504	0.27	110	24.0	0.83	0.28
	SM-307A ^a	30	0.486	0.80	120	66.7	0.30	0.10
	SM-319 ^b	20	0.489	0.81	∞	0	∞	∞
	SM-321 ^b	24	0.445	1.30	∞	0	∞	∞
	SM-322 ^b	28	0.469	1.18	490	24.0	2.08	0.69
	SM-320 ^c	28	0.463	2.75	1 150	24.0	3.33	1.11
	SM-300A ^c	30	0.455	5.31	318	167.0	0.48	0.16
Fairbanks Silt	SFS-348 ^a	28	0.684	2.6	∞	0	∞	∞
	SFS-364 ^a	31	0.824	1.7	128	133	0.15	0.05
	SFS-304 ^b	21	0.892	0.11	∞	0	∞	∞
	SFS-302 ^b	25	0.726	0.63	∞	0	∞	∞
	SFS-311 ^b	31	0.709	11.0	34.0	3 200	0.016	0.05
	SFS-349 ^c	28	0.796	5.1	310	100	0.80	0.27
	SFS-365 ^c	32	0.838	37.6	52	7 320	0.011	0.004
Fargo Clay	SFFC-358 ^a	23	1.240	0.60	72	83	0.24	0.080
	SFFC-351 ^a	31	1.267	4	64	600	0.033	0.011
	SFFC-336 ^b	20	1.138	0.6	118	51	0.98	0.33
	SFFC-347 ^b	25	1.213	2.3	192	120	0.42	0.14
	SFFC-335 ^b	29	1.135	15	500	300	0.17	0.057
	SFFC-365 ^b	31	1.162	11	29	3 780	0.013	0.0043
	SFFC-340 ^c	28	1.201	24.5	122	2 000	0.040	0.013
	SFFC-366 ^c	32	1.276	22	6	38 000	0.00021	0.00007
	SAP-314 ^a	29	2.542	0.1	33	30	0.67	0.22
Alaskan Peat	SAP-310 ^a	31-1/2	5.045	4.5	670	67	0.30	0.10
	SAP-312 ^b	22	4.775	0.25	8 800	21.7	2.30	0.77
	SAP-313 ^b	29	4.489	1.0	167	60	0.83	0.28
	SAP-307 ^b	32	3.341	1.0	3.0	3 500	0.014	0.0047
	SAP-311 ^c	29	4.276	4.5	14.0	330	0.242	0.081
	SAP-308 ^c	32	4.480	14.5	1.0	117 500

^aStress is 20 psi

^bStress is 50 psi

^cStress is 80 psi

rheological model to express observed phenomena. The relaxation time was not found to follow any law for any material. The model, if found, would be complex and of small value. The computed results are given in the Table.

COMMENTS ON EXPERIMENTAL WORK

Unconfined compression tests are the simplest for studying plastic deformation of frozen soils, but test convenience is offset by difficulties in analysis.

The soils tested were as near saturation as possible. Permafrost is not always saturated and research at lower water-ice contents is desirable. Other modifications suggested are: Use of more than three stresses, a wider temperature range, and better temperature control; constant stress rather than constant load; more precise deformation measurements; and observations during relaxation on load removal from a stressed condition. Research now in progress at the U. S. Army CRREL incorporates these changes.

COMMENT ON THE ANALYSIS OF THE LABORATORY DATA

Tests were made at constant load, necessitating small adjustments to compute the strain effects of a constant stress not quite equal to that on the specimen. This detracts from the accuracy of the analysis, but shows relationships between creep parameters better than if load and deformation were used unadjusted.

ACKNOWLEDGMENT

This paper covers a small part of a three year (1951-1953) study of frozen soils performed by the personnel of the Arctic

Construction and Frost Effects (ACFEL) Corps of Engineers, U. S. Army. The laboratory was under the direction of Kenneth A. Linell; Chester W. Kaplar was project engineer; James F. Haley, Henry W. Stevens, and O. W. Simoni contributed to the laboratory work. The report is by Frederick J. Sanger, formerly special assistant at ACFEL.

APPENDIX— SPECIMEN PREPARATION DATA

Before Freezing

All specimens about 2-3/4 in. diameter and most trimmed off to a height of about 6 in.

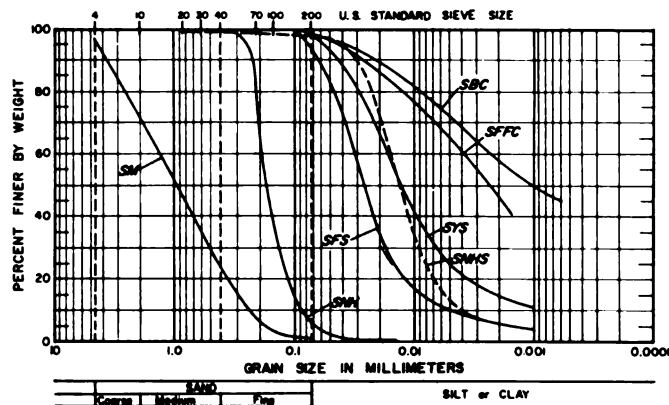

Fig. A1. Grain size distribution of test soils

Table A. I. Soil descriptions

Soil Legend	Name	Source	Department of the Army Unified Soil Classification Description	Atterberg Limits			Specific Gravity	Compaction Characteristics		
				Group Symbol	Liquid Limit	Plasticity Index		Shrinkage Limit	Max. Dry Unit Wt. (pcf)	Optimum Water Content (%)
SM	McNamara Concrete Sand	Needham, Mass.	SAND, brown, angular, processed for concrete	SP	non-plastic		-	2.72	123 (1)	-
SNH	Manchester Fine Sand	Manchester, N.H.	Uniform, fine SAND, light brown, clean	SP	non-plastic		-	2.68	106 (1)	-
SNHS	New Hampshire Silt	Manchester, N.H.	Light gray brown, inorganic clayey SILT	CL-ML	26	5	-	2.70	107 (2)	15.6
SFS	Fairbanks Silt	Fairbanks, Alaska	Brown and gray SILT, containing traces of mica and some organic matter	ML-CL	28	4	-	2.68	112 (2)	15.7
SYS	Yukon Silt	Whitehorse, Yukon Territory, Canada	Gray, well graded, inorganic clayey SILT	CL-ML	28	9	-	2.73	121 (3)	12.8
SBC	Boston Blue Clay	No. Cambridge, Mass.	Stiff lean CLAY, relatively homogeneous and free of fractures and varves	CL	47	27	22	2.81	-	-
SFFC	Fargo Clay	Fargo, N. D.	Dark gray, friable, highly plastic homogeneous fat CLAY, with honeycomb structure (organic content 8%)	CH-OH	68	46	15	2.76	-	-
SAP	Alaskan Peat	Fairbanks, Alaska	Dark brown to black PEAT; fibrous, partially decomposed (organic content 82%)	Pt	Tests inapplicable		-	1.52	-	-

Notes: (1) Providence Vibrated Density
 (2) Modified AASHO Density
 (3) Standard Proctor Density

Table A. II. Summary of test conditions

Material	Specimen Number	Heave %	Dry Unit Weight	Water Content	Degree of Saturation	Ratio:		Average Test Temp. °F	Compressive Stress (Conventional) psi	
			After Freezing pcf	After Freezing %	at End of Test %	Vol. Ice / Vol. Soil	Void Ratio e			
McNamara Concrete Sand	SM-307A	2	112	16.4	94	0.486	0.516	30.0	19.6	
	SM-302A	6	114	15.6	94	0.463	0.489	30.0	52.6	
	SM-300A	0	112	15.0	86	0.445	0.516	30.0	76.2	
	SM-326	5	109	17.0	90	0.504	0.558	28.0	19.4	
	SM-322	6	112	15.8	91	0.469	0.516	27.5	49.8	
	SM-320	4	109	15.6	83	0.463	0.558	28.0	84.2	
	SM-321	5	111	15.0	84	0.445	0.530	24.0	51.5	
	SM-319	3	111	16.5	92	0.489	0.530	20.3	50.3	
Fairbanks Silt	SFS-364	20	87	29.3	100	0.824	0.808	31.0	19.5	
	SFS-311	12	94	25.2	94	0.709	0.780	30.5	51.5	
	SFS-365	18	88	29.8	97	0.838	0.901	31.2	78.1	
	SFS-348	12	96	24.3	95	0.684	0.732	28.0	20.3	
	SFS-349	19	90	28.3	96	0.796	0.859	28.5	80.4	
	SFS-302	12	91	25.8	90	0.726	0.780	24.0	50.0	
	SFS-304	14	86	31.7	98	0.892	0.945	21.0	51.2	
	Fargo Clay	SFFC-351	8	75	42.1	98	1.267	1.297	30.8	20.5
SFFC-365		4	78	38.6	96	1.162	1.209	31.2	50.7	
SFFC-366		5	74	42.4	96	1.276	1.328	32.0	77.0	
SFFC-358		6	76	41.2	98	1.240	1.267	28.0	20.6	
SFFC-335		8	79	37.7	96	1.135	1.181	29.7	51.6	
SFFC-340		2	77	39.9	97	1.201	1.238	27.5	79.8	
SFFC-347		2	76	40.3	96	1.213	1.267	25.6	49.4	
SFFC-336		1	79	37.8	96	1.138	1.181	20.5	51.2	
Alaskan Peat		SAP-310	4	15	304.3	95	5.045	5.326	32.0	20.3
		SAP-307	6	22	201.5	100	3.341	3.313	32.0	50.2
	SAP-308	1	17	270.2	98	4.480	4.581	32.0	81.5	
	SAP-314	0	25	153.3	91	2.542	2.796	29.0	19.7	
	SAP-313	2	17	276.8	100	4.589	4.582	29.5	50.8	
	SAP-311	2	19	257.9	100	4.276	3.994	29.5	79.0	
	SAP-312	5	16	288.0	97	4.775	4.931	22.5	49.3	
	SAP-309	7	16	282.5	95	4.684	4.931	18.5	50.8	

SM compacted to approximately 117 pcf = 95% Providence Vibrated Density.

SFS compacted to approximately 105 pcf = 95% Modified AASHO Density.

SYS compacted to approximately 115 pcf = 95% Standard Proctor Density.

SNH, SNHT, and SNHS molded to 95% Modified AASHO Density.

SFFC, SBC, and SAP trimmed from undisturbed samples.

During Freezing

All specimens frozen axially downward in an open system at a rate of about 1/2 in. per day, excepting Manchester Fine Sand, which had a rate of 1 in. per day.

After Freezing

Nearly all specimens trimmed to about 6 in. in height and the ends squared.

Before Testing

Each specimen was tempered for at least 16 hours at the test temperature.

Table A.I with soil descriptions and Table A.II listing some of the test conditions follow:

REFERENCES

- [1] U. S. Army CRREL, "Investigation of Description, Classification and Strength Properties of Frozen Soils," SIPRE Rept. 8 by ACFEL, U. S. Army Corps of Engineers, 1952.
- [2] M. Reiner. Building Materials; Their Elasticity and Inelasticity, Interscience Publishers, New York, 1954.
- [3] Tsyrovich, Sumgin. Principles of Mechanics of Frozen

Ground, 1937, SIPRE Transl. 19, U. S. Army CRREL, 1959.

[4] S. S. Vyalov. "Rheological Properties and Bearing Capacity of Frozen Soils," Acad. Sci. USSR, 1959, CRREL Transl. 74, tech. ed. F. J. Sanger, 1965.

[5] I. Finnie, W. R. Heller. Creep of Engineering Materials, McGraw-Hill, New York, 1959.

[6] S. S. Vyalov, et al. "Strength and Creep of Frozen Soils and Calculations for Ice-Soil Retaining Structures," Acad. Sci. USSR, 1962, CRREL Transl. 76, tech. ed. F. J. Sanger, 1965.

NOTATION (Refer to Fig. 2)

- σ stress, psi
- ϵ natural strain, %
- $\dot{\epsilon}$ minimum (time) rate of change of natural strain (second stage of stage of creep), per hour
- ϵ_0 zero intercept, %
- t relaxation time, hour
- T temperature, F
- θ degree of frost, measured below 32° F
- λ coefficient of viscous compression: [2], stress times time—usually psi-hour
- η coefficient of dynamic viscosity, stress times time
- μ Poisson's ratio

DISCUSSION

[Editor's note: See discussion by A. ASSUR at end of Session 6]

CLOSURE

Assur is very kind to call attention to the fantastic formula that (contrary to his statement) is not proposed. It was presented, as indicated in the paper, to show that the simple equation $\dot{\epsilon} = B(\sigma)^n$, often used for creep in metals, is unrealistic with a frozen soil: Space limitation prevented an extended discussion. Roughly speaking, n is about 2-1/3 for Fargo clay, but the fit is poor.

Using strain and not strain rate leads to an equation of the Vyalov type

$$\epsilon = \frac{2 \times 10^{-2} \sigma^{7/3} t^{1/3}}{(1 + \theta)^{5/2}}$$

SOIL FREEZING CONSIDERATIONS IN FROZEN SOIL STRENGTH

RAYMOND N. YONG, McGill University, Montreal

In the study of soil properties and characteristics, it is useful to describe fundamental relationships of soil behavior in terms of measured properties. For soils at temperatures above freezing, of particular interest are soil strength and compressibility or deformation—since these have the most bearing on stability of engineering structures. The parameters in such behavior characteristics are being closely scrutinized [1]. It is becoming more evident that the laws of mechanics applicable to granular soils may not be as easily applied to many clay soils because of the presence of molecular and surface forces.

The method of test evaluation is important in determining factors of soil strength. This is particularly important in the determination of shear strength parameters of clay soils. Between limits of operative parameters defined by granular soils and clays, friction is thought to be primarily responsible for granular soil strength; cohesion is the other controlling parameter in clay soil strength. The cohesion parameter, however, has not been defined too clearly, and seems best interpreted as an inherent property of clay soils, dependent in part on such factors or variables as (a) clay mineral and soil composition, (b) prestress history, (c) soil structure, (d) nature of pore water and degree of saturation, and (e) method of test evaluation.

If soil freezing occurs, other pertinent factors and parameters must be considered. Temperature, ice content, partial freezing of the pore water giving rise to unfrozen water or incomplete freezing, undercooling and duration of freezing, number of ice crystals formed, orientation and size of ice crystals, and availability of water, are some considerations. Little is known about the degree of influence of these factors and their role in the determination of frozen soil strength.

EXPERIMENTATION

Two phases considered for this study were: (a) Frozen soil strength determination, and (b) soil freezing factors influencing frozen soil strength.

For frozen soil strength determination, in addition to the standard unconfined compression test, a ring shear test with axial restraint was used to measure shearing strength of artificially frozen soils (Fig. 1). With this type of tester, it is possible to place an axial restraint of known magnitude on the test specimen before performing the actual shear test. Shear strength is measured in terms of a transverse shear under predetermined initial axial restraints varying from zero to 240 psi.

In almost all instances in the ring shear test, specimen deformation under transverse shear caused axial elongation. No attempt was made to measure this elongation; rather, increase in axial pressure caused by restraint of elongation was noted as a function of initial axial confinement—to be used in evaluation of shear strength characteristics. For this

where ϵ is natural strain, %; σ is stress, psi; t is time, hour; and θ is in Fahrenheit degrees.

We agree with Assur's views on formulas in general, merely pointing out that many formulas of engineering value do not satisfy rigorous criteria of mathematics and physics.

To date, no satisfactory theory for creep of frozen soils has been developed: The problem is much harder than creep in metals. For this reason, the only way to solve engineering problems is by approximate equations based on plausible reasoning, experiments, and experience. The equations proposed by Vyalov have drawbacks, but appear to be the best at the moment. A study of two references [4,6] is recommended.

We agree with Assur's closing paragraph.

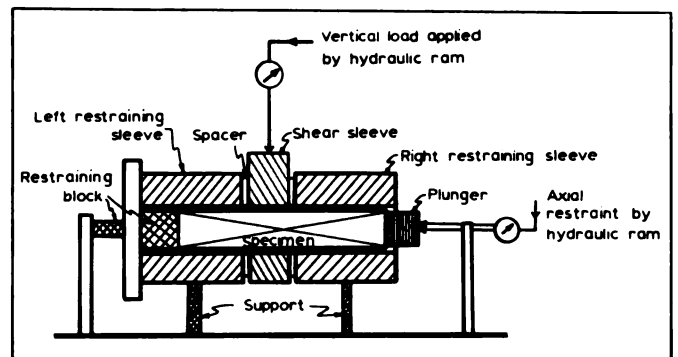

Fig. 1. Schematic picture of ring shear tester

portion of the study, three types of soil were used. The grain size distribution for soils (sand, silt, and clay) is given in Fig. 2 with pertinent soil properties given in Table I.

Variation in density of saturated sand samples was achieved by either funneling sand into aluminum foil-lined cardboard cylinders or vibrating the prepared samples in three layers. Density variation ranged from 133 pcf for dense samples to 118 pcf for loose samples. In silt and clay samples, both kneading compaction and consolidation techniques were used. Consolidated samples were used solely in the unconfined compression test series. For any one compression or shear test, a minimum number of five identical specimens were used.

Table I. Properties of soils used for study

Sand:	Apparent friction angle = 37°, apparent cohesion = 0, sp gr of solids = 2.65	
	Silt	Clay
Liquid limit	25.1	67.0
Plastic limit	17.0	28.8
Specific gravity of solids	2.68	2.73
Optimum water content, (standard compaction)	16.5	28.5
Optimum dry density	114.5 pcf	87.8 pcf
Mineral content in approximate percentage		
Chlorite	...	2-3
Biotite	...	10
Amphibole	...	2-3
Feldspar	20	50-60
Quartz	80	25

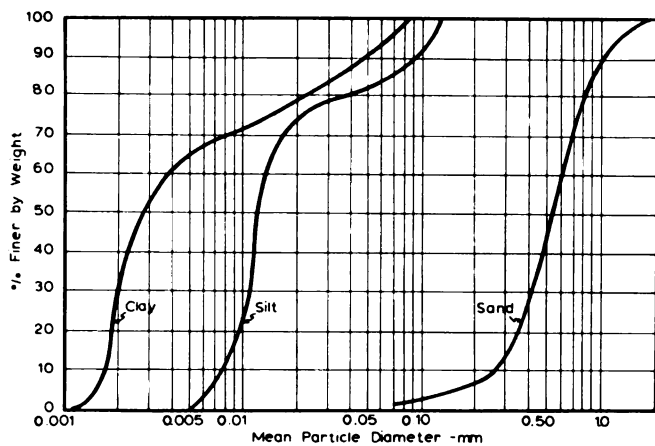

Fig. 2. Grain size distribution

Soil freezing factors of primary importance in influencing frozen soil strength centered around the problem of unfrozen water in the frozen soil-water system. Measurements of unfrozen water for both frozen clay and silt samples were made by the calorimetric method. In support of this, soil suction experiments were performed by pressure-membrane technique.

RESULTS AND DISCUSSION

Because of the nature of the mechanism involved in the freezing soil-water system, it is not possible to present detailed results for the numerous test specimens needed to obtain a sensible statistical average.

This paper discusses the shear strength evaluation of frozen soils and also points out the need for an understanding of pertinent soil freezing factors in the study of frozen soil strength.

Unconfined Compressive Strength

Figures 3 through 5 show characteristic curves for unconfined compression tests on both sand and clay samples frozen to temperatures of -4.7°C and -17.8°C . These demonstrate expected relationships between rate of strain, temperature, and density. The designation of "fast" for the unconfined compression test refers to a constant rate of stress application of 1000 psi per minute, while the "slow" test corresponds to a constant rate of stress application of 200 psi per minute.

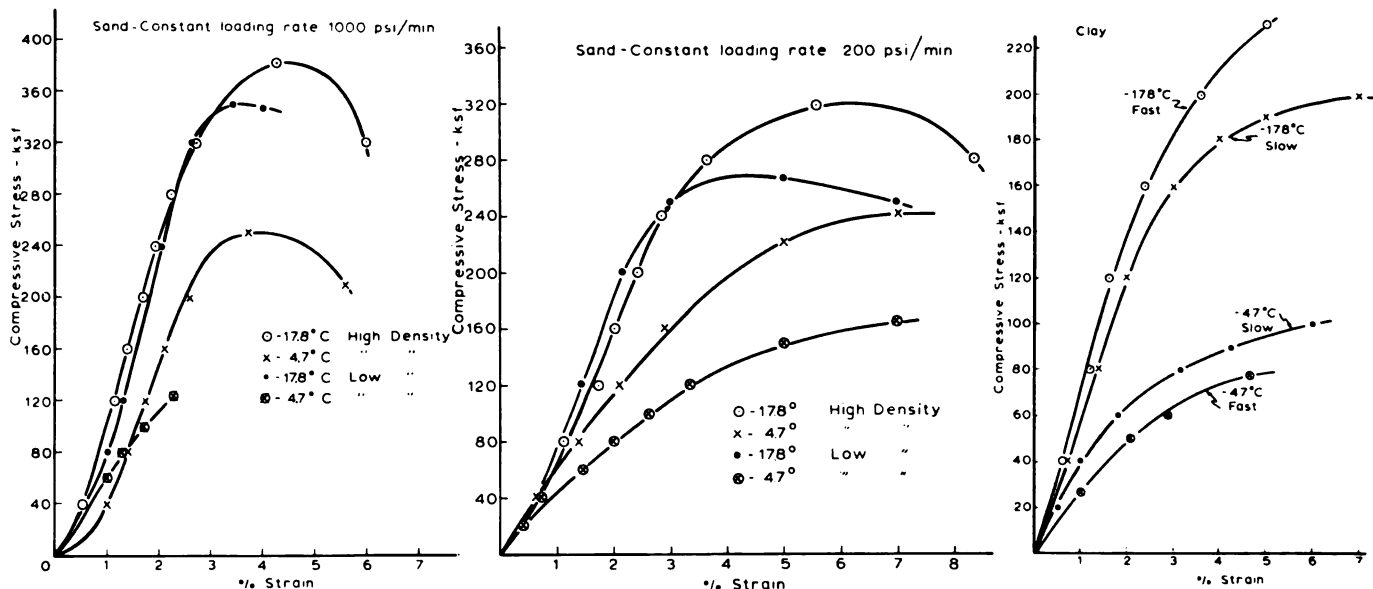

Figs. 3, 4, and 5. Unconfined compression tests

These relationships are by no means new and have been reported quite extensively by other investigators [2, 3, 4]. As pointed out by Tsyvovich [3], the total strength and shear components contributing to strength will increase with a decrease in temperature. The influence of stress relaxation on strength properties has also been noted [3] as a function of time rate of loading. Reasons for lower strength of clay samples at higher temperature because of increased loading rate are not too well understood. Observed compression performance of clay samples at higher temperature showed considerable specimen bulging at the lower loading rate coupled with some elastic rebound with a load decrease or release. Quite possibly, incomplete saturation of consolidated samples contributed to many other factors that must be considered.

While behavior of artificially frozen soil samples under unconfined compression may be explained in terms of behavior of individual shear strength parameters, the nature of influence of soil freezing factors contributing directly to parametric behavior and, subsequently, to frozen soil strength remains unknown and indistinct. Based upon test results and support of previous studies, it appears feasible to measure unconfined compressive strength as a function of temperature, time rate of loading, and such soil properties as void ratio, density, etc., and to report these as ultimate variations of parameters such as cohesion and friction. However, this presupposes that these parameters are separable as far as individual strength contribution is concerned.

It was found, based upon numerous unconfined compression tests on sand and clay samples, that the scatter of results could be attributed to nonreproducibility of particle orientation or specific ice formation in soil pores. In order to arrive at a sensible strength relationship with prescribed factors, it was necessary to conduct tests on no less than five samples for any one specific condition. Based on this performance characteristic, it becomes evident that more attention should be given to an understanding of soil freezing factors as they affect frozen soil strength.

Ring Shear Test

To gain further insight into factors affecting frozen soil strength, it was felt that information gained by observing specimen behavior under some variable normal pressure would be of use in explaining shear strength variation with certain soil properties. In Fig. 6, shear strength variation is given as a function of both temperature and initial water content. No attempt is made in this particular graph to distinguish between ice content and unfrozen water content. General behavior of frozen clay soils is such that at some stage

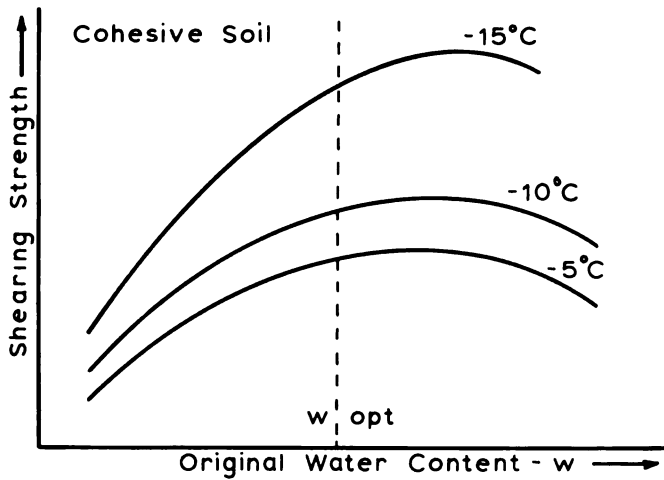

Fig. 6. Original water content and shearing strength

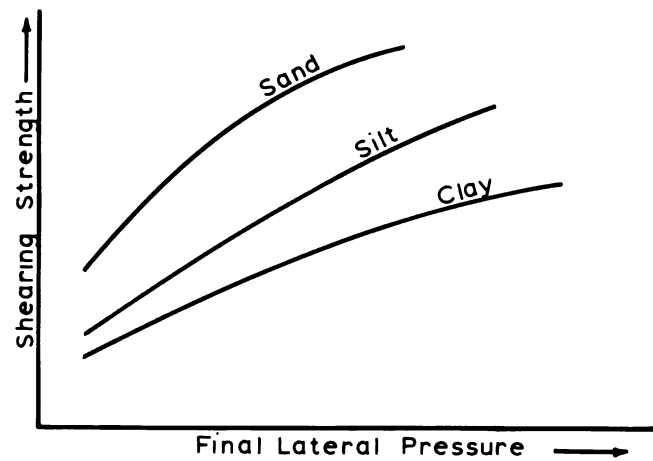

Fig. 7. Axial confinement and shearing strength

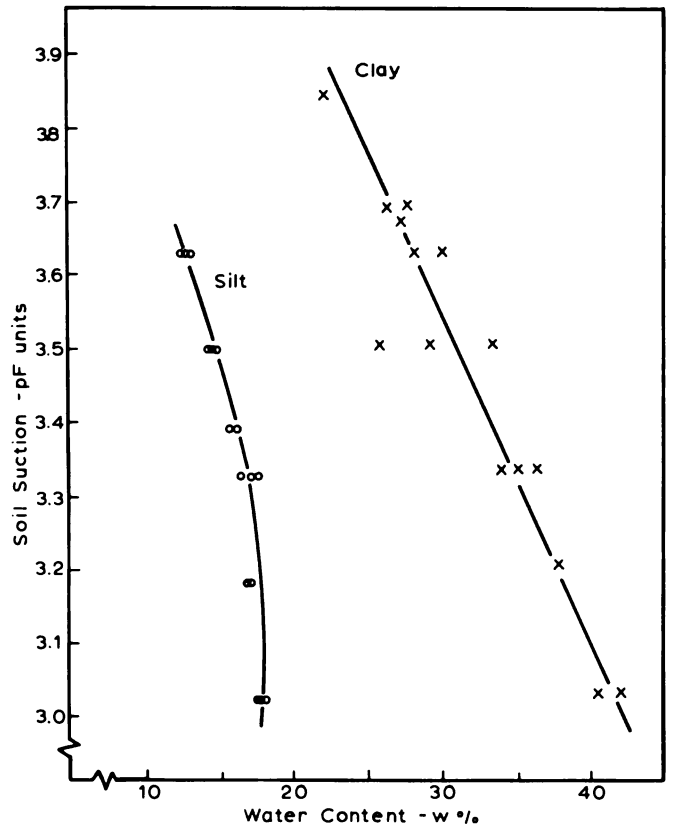

Fig. 9. Soil suction and water content

beyond the optimum water content, frozen soil shear strength decreases with increasing initial molding water content. This behavior is not inconsistent since there will eventually be an asymptotic ice strength established for that particular test temperature.

For axial confinement and shear strength variation, it is possible to obtain relationships for strength dependency on both initial and final axial confinement. Fig. 7 shows general relationships in terms of axial pressure realized at the point of shear failure. It is possible to infer from these an operative friction angle for the materials; however, it is not possible to comprehend the entire significance of this parameter. Although the radial constraint imposed on test specimens tends to destroy the rationality of the test, the relationships derived show a reasonable trend between normal pressure and shear strength.

From previous investigations and observation of specimen behavior [3, 5, 6], it is apparent that ice content and unfrozen water content should also be considered in the evaluation of strength of the frozen soil-water system. It would seem that the greater the quantity of water remaining unfrozen, the lower would be the strength of the partially frozen soil. Unfortunately, this relationship cannot be simply described in those terms. Without paying heed to the percentage of water remaining unfrozen, and considering unfrozen water content as the ratio of weight of unfrozen water to that of the solid mineral particles, it is possible to relate increasing strength with increasing unfrozen water content. The relationship was observed in this study. Pursued further, it becomes obvious that other fundamental factors have been overlooked. Unexplained is the development of unfrozen water in a partially frozen soil, such as interparticle action and double layer water. A study should be made to establish these factors and how they individually affect the final demonstrated result.

Another approach would be to use a measure that incorporates most or all of the factors into an observable or measurable quantity. For this, the soil suction capacity or moisture potential seems a useful and adequate factor to describe the

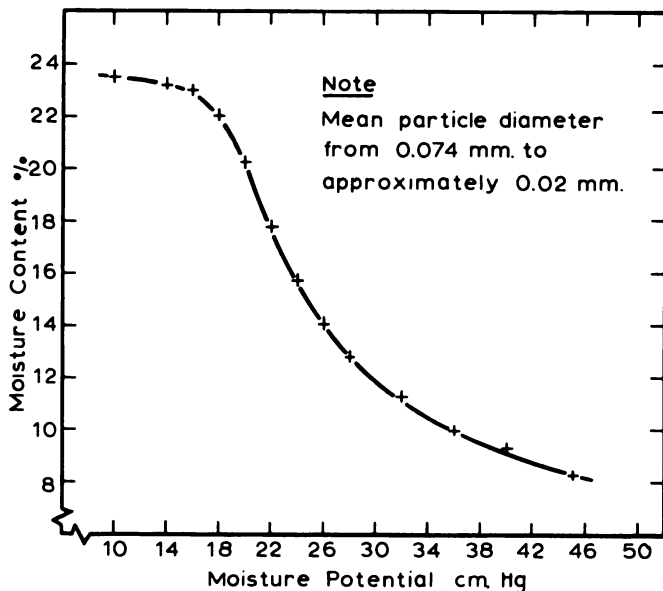

Fig. 8. Desorption curve for silt fraction

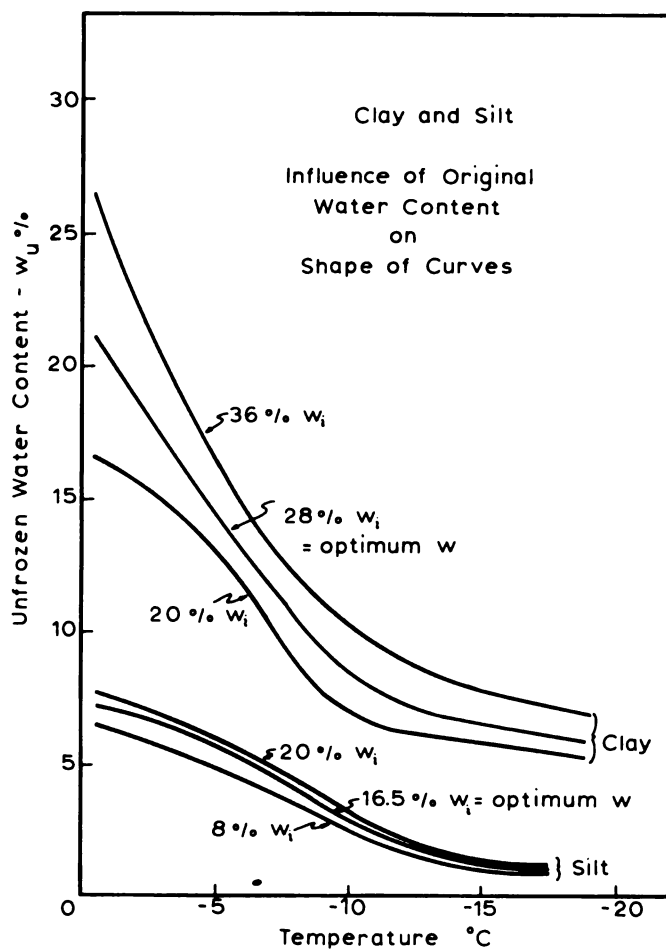

Fig. 10. Temperature and unfrozen water content

relationship between unfrozen water and temperature for any one particular density or configuration. Much of the same forces are active in both soil suction and development of unfrozen water in partially frozen soils. In Figs. 8 and 9, both the desorption curve for the coarse silt fraction and the soil suction curves for the clay and silt are shown. These may be used with Fig. 10, which shows the results of unfrozen water determinations expressed in terms of unfrozen water content and related to temperature for varying densities. It is important to note that the quantity of water remaining unfrozen at any one temperature is dependent on whether the test specimens are frozen to the test temperature or undercooled and subsequently raised to test temperatures [6, 7]. Curves in Fig. 10 represent average unfrozen water content for a series of test specimens frozen to the test temperature and for others undercooled 2°C then tested at the same test temperature. Depending on initial water content, test temperature, and soil type, the undercooling effect could result in a decrease of unfrozen water content of from 10% to 45%. These unfrozen water and temperature relationships are explained in greater detail by Martynov [8]; however, many of the factors considered probably can be adequately accounted for by using the moisture potential relationships.

With the results of tests on unfrozen water, it is possible to compute total ice content—assuming that the difference between unfrozen water content and initial water content is the resultant ice content of the partially frozen soil sample. Interpretation of results of the ring shear test in terms of ice content is interesting because it is possible to derive a relationship between increasing ice content and shear strength quite similar to that for the unconfined compression test [7]. Higher strengths are obtained with greater initial axial confinements. Effect of temperature on shear strength viewed in

terms of ice content is not demonstrated very clearly. Bands in Fig. 11 include strength determinations at temperatures of from -5° to -20°C. Dispersion of strength as a function of temperature is greater with zero axial confinement, and gets progressively lesser with increasing axial confinement. Many factors involved in the development of unfrozen water, however, could be important in this type of relationship and could undoubtedly obscure other more fundamental factors such as ice and soil particle interaction. It is significant that increasing ice content results in higher shear strengths. This trend was shown in Fig. 6 and in unconfined compression tests conducted by other investigators [9]. A peak shear strength must be expected (Fig. 6) with increasing ice content, which must be followed by a subsequent decrease in strength. Tests conducted to date have not shown this as yet; however, this phenomenon must be expected.

In Figs. 12 and 13, increase in axial confinement from restraint of specimen elongation under transverse shear is examined. Because of the scattering of results, these are best interpreted as trends rather than exact relationships. These trends are well defined and permit observations on the relationship between axial pressure increase and original water or ice content. Further study is needed to clarify these trends. There is, however, a significant relationship among such factors as ice and water content, axial restraint and axial pressure increase, and demonstrated shear strength. While there is an obvious increase in axial pressure due to increasing ice or original water content, this relationship must also depend upon soil type, density, and rate of shear application in its description of ice and soil particle interaction. In its present form, frozen soil deformation under shear depends quite critically not only on density and ice content, but also on the degree of initial saturation. Both Figs. 12 and 13 show that the increase in axial pressure is reduced if ice content is lowered—corresponding to a low initial saturation. Expansion or volume change induced by transverse shear application will result in increased axial pressure if there is sufficient restraint. With air voids, however, restraint is reduced, and resultant axial elongation is decreased. Local melting of ice at pressure contact points

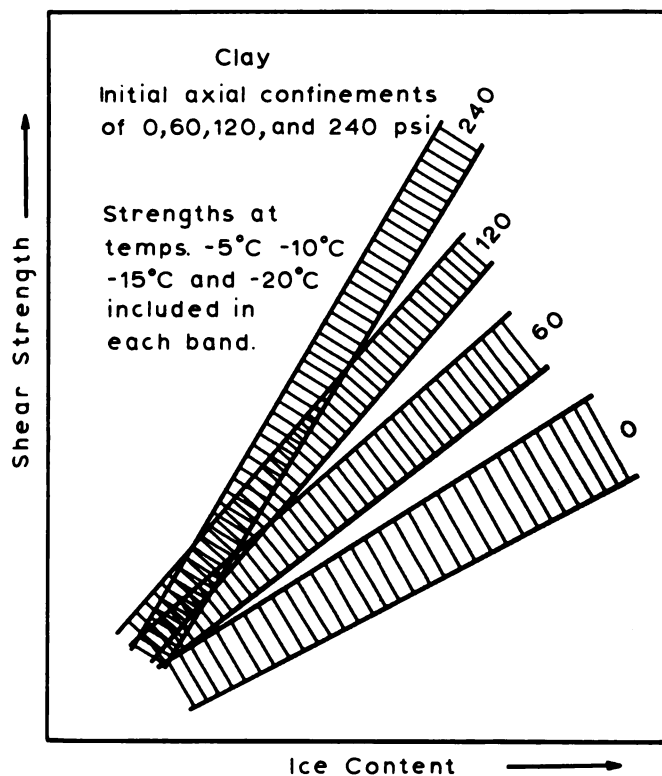

Fig. 11. Ice content and shear strength

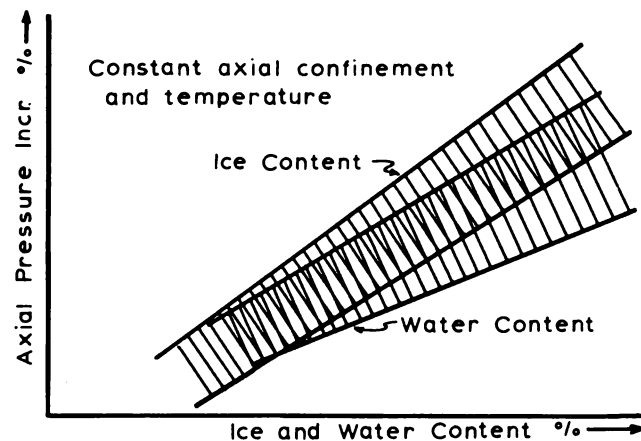
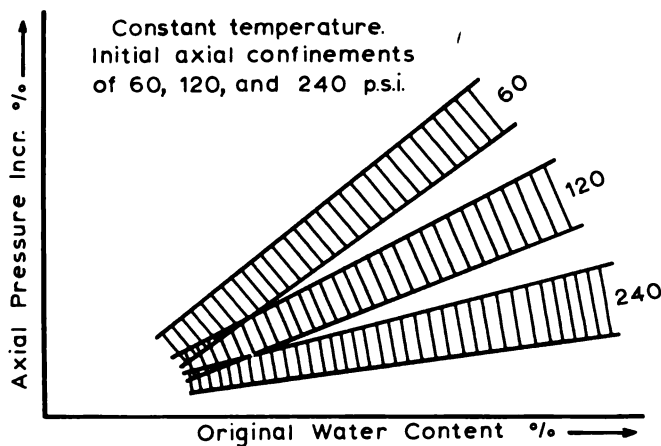

Fig. 12. Increase in axial confinement with constant temperature

Fig. 13. Increase in axial confinement with constant axial confinement

will also reduce total volume change because of subsequent displacement of melt water into air spaces.

CONCLUSION

Results presented show that problems associated with soil freezing are significant and materially affect frozen soil strength. Although it may be possible to obtain compressive and shear strengths of frozen soil, it is not possible to describe completely factors or mechanism involved. Inter-particle forces characterizing soil suction are also believed to be active in the development of unfrozen water; this plays an important role in ultimate manifestation of frozen soil strength.

ACKNOWLEDGMENT

The author is indebted to the Defence Research Board of Canada for its support.

REFERENCES

[1] M. J. Hvorslev. "Physical Components of the Shear Strength of Saturated Clays," *Res. Conf. Shear Strength of*

Cohesive Soils, Am. Soc. Civil Engrs., June 1960, pp. 169-273.
 [2] Arctic Construction and Frost Effects Lab., "Investigation of Description, Classification and Strength Properties of Frozen Soils," *SIPRE, Rept. No. 8*, 1951.
 [3] N. A. Tsytoich. "Bases and Foundations on Frozen Soil," *Spec. Rept. 58*, Highway Res. Bd., Canada, 1960.
 [4] R. N. Yong. "Some Shearing Characteristics of Frozen Soil - Part 1," *Rept. No. D, Phys. R. (G) M.G.2*, Defense Res. Bd., 1960.
 [5] C. W. Lovell. "Temperature Effects on Phase Composition and Strength of Partially-Frozen Soil," *Bull. 168*, Highway Res. Bd., 1957, pp. 74-95.
 [6] R. N. Yong. "Research on Fundamental Properties and Characteristics of Frozen Soils," *Proc. 1st Canadian Conf. Permafrost*, 1962, pp. 84-108.
 [7] G. A. Leonards, O. B. Andersland. "The Clay-Water System and the Shearing Resistance of Clays," *Res. Conf. Shear Strength of Cohesive Soils*, Am. Soc. Civil Engrs., June 1960, pp. 793-818.
 [8] G. A. Martynov. Chapter 6, *Principles of Geocryology*, Pt. 1, NRC Transl. TT-1065, 1963, pp. 153-192.
 [9] N. A. Tsytoich, M. I. Sumgin. *Principles of Mechanics of Frozen Ground*, SIPRE, Transl. 19, 1959.

REDUCTION OF FROST-HEAVE BY SURCHARGE LOADING

GEORGE W. AITKEN, U.S. Army Cold Regions Research and Engineering Laboratory

Results are presented from a current study evaluating the effect of surcharge loading on reduction of frost-heave in a permafrost area. Field data were obtained from a test installation constructed at the Alaska Field Station (AFS) of the U.S. Army Cold Regions Research and Engineering Laboratory, (CRREL), at Fairbanks, Alaska. Laboratory tests (conducted at the former Arctic Construction and Frost Effects Laboratory, now a part of CRREL) supplied other data.

Both field and laboratory data show a marked reduction in the frost-heave of a fine-grained soil with increase in surcharge pressure. Results also indicate a definite relationship between surcharge pressure and rate of frost-heave when the rate of heave is proportional to the rate of frost penetration.

SITE CONDITIONS

The Alaska Field Station is located about three miles northeast

of Fairbanks, which has a mean annual temperature of about 26° F and a mean annual precipitation of about 12 in., including a mean annual snowfall of about 40 in. The average freezing and thawing indexes for the years 1952 through 1962 were 5600 and 3300 degree-days, respectively.

The surcharge test installation was built in an undisturbed section having relatively dense grass that grows to a height of about 2 ft during the summer (Fig. 1). The ground surface has a gentle east to west slope with essentially uniform surface elevations in the north-south direction. A slight natural ground depression extended through the site in an east-west direction located about 75 ft from the south end of the test sections. This depression evidently served as a natural drainage channel, for during construction the soil here appeared substantially wetter and softer than adjacent areas to the north and south.

Silt containing decaying organic matter in layers and

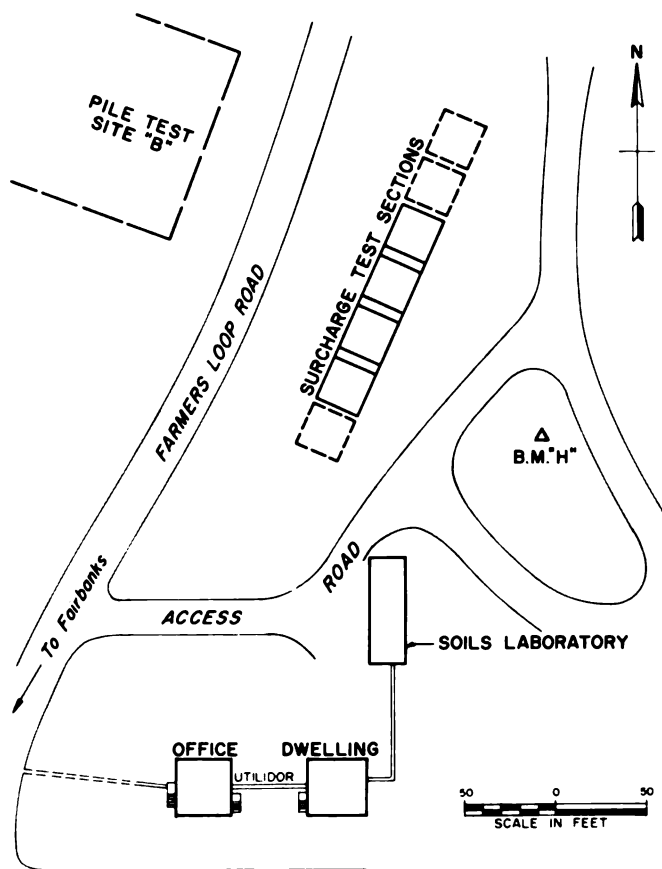

Fig. 1. Site layout

pockets underlies the area, making construction particularly difficult. The average seasonal frost penetration was about 5 ft and permafrost existed at about 7 ft beneath the test site prior to construction. A lane of steel-pierced plank was placed completely around the stripping limits to protect the existing surface cover before construction began. Drill rigs were the only equipment used on the area comprising the control and natural ground sections; they were lifted onto the areas by a crane to minimize surface disturbance.

TEST INSTALLATION CONSTRUCTION

Construction began in late August 1960 with the intention of completing the base course and concrete placement prior to freezeup. Initially, 12 to 18 in. of surface material was stripped from the 118 by 25 ft area comprising test sections of 2, 4, 6, and 8 psi. Heavy rainfall (that for 1960 was the highest for September since 1925) made it impossible to operate heavy equipment on the stripped area. As a base for the concrete, 6 in. of sand followed by 12 in. of gravel was placed on the silt subgrade. Final grading was not completed until the end of September.

It was necessary to enclose and heat the gravel base area to prevent the gravel from freezing and to provide protection for the fresh concrete. A wood-framed, polyethylene-sheathed shelter was constructed over the base course and a single Herman-Nelson-type heater was used to keep the base course free of frost. A second heater was needed in mid-October to maintain suitable temperatures for concrete curing. Four main slabs of 25 by 25 ft separated by three transition slabs of 6 by 25 ft were constructed. All slabs were 6 in. thick and reinforced with welded wire mesh; main slabs were separated from transition slabs by a 1 in. premolded joint material (Fig. 2).

INSTRUMENTATION

Instrumentation monitored ground temperatures under and adjacent to the test sections, vertical movement of the concrete-surfaced sections and the adjacent unsurfaced control and natural ground sections, and ground-water elevation at the test site (Fig. 3). Each assembly (Fig. 3) consisted of 24 copper constantan thermocouples uniformly spaced from the ground or pavement surface to a maximum depth of 24 ft. Data from these assemblies were obtained using a portable precision millivolt potentiometer with an ice-bath reference junction.

Vertical movement data were obtained from pavement-heave and vertical-movement gages (Fig. 4). Pavement-heave gages were installed in the spring of 1961 through openings one ft square left in the concrete slabs for this purpose. Steel couplings for the gages were grouted in place, the grout being bonded to existing concrete with an epoxy resin. The 1.25 in. reference rod and 2.5 in. coupling extension for the center gage on the 4, 6, and 8 psi sections were sleeved up through the load boxes and were accessible from the top of the boxes. The heave gages were observed, using a machinist's depth

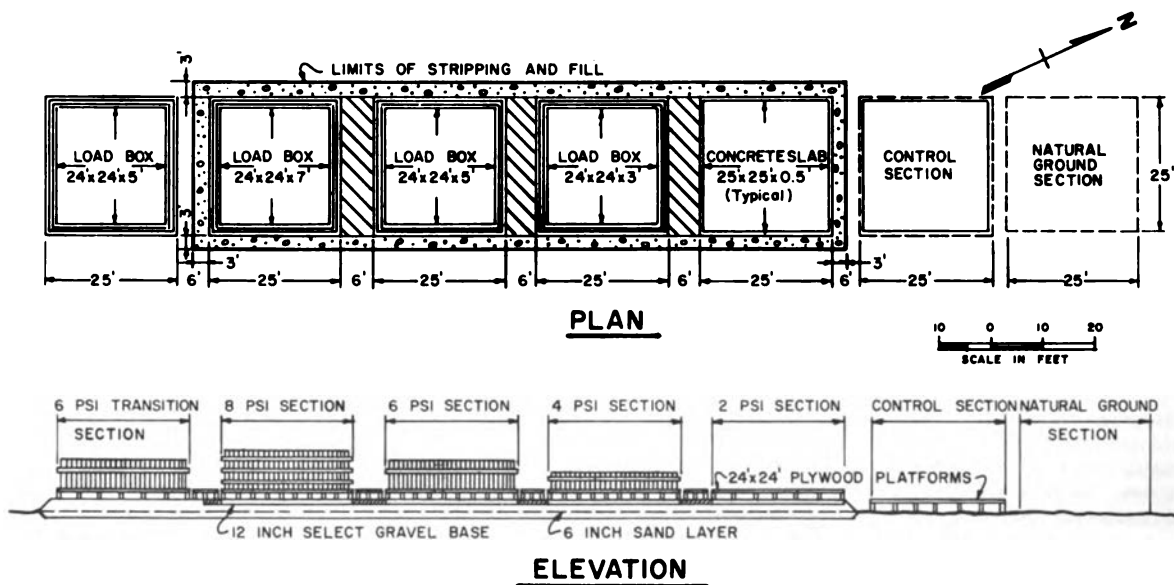

Fig. 2. Test section

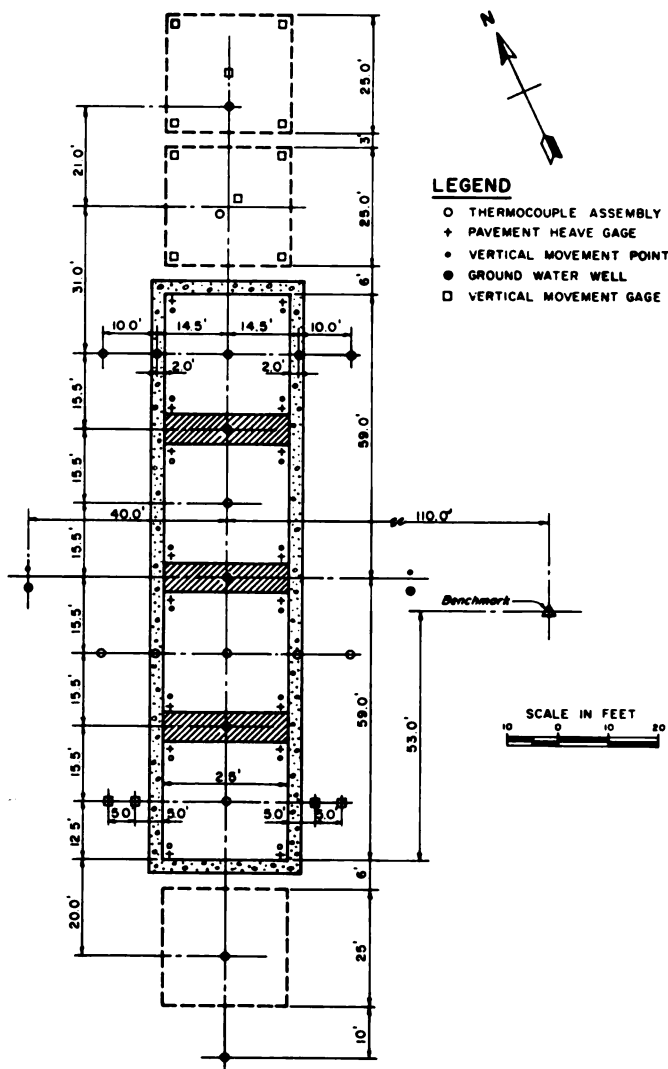

Fig. 3. Instrumentation layout

gauge to measure the difference in elevation between the inner reference rod, which serves as a benchmark, and the steel coupling embedded in the concrete. The vertical-movement gages in the platform-covered control section were observed by measuring the displacement between the gage reference rod and steel angles attached to the platform over each reference rod. All other vertical movement gages had steel frames resting on the ground surface designed so that displacement measurements could be easily obtained between the reference rods and the adjacent frames with a depth gage. These gages have performed excellently to date.

Two ground-water wells were installed (Fig. 3) to approximately 16 ft below the ground surface. Ground-water observations were obtained in these wells using an electric water level indicator.

OBSERVATION SCHEDULE

Regular weekly observations have been made on all ground temperature assemblies and heave gages since installation. Depth of ground water is measured biweekly during the thawing season and weekly during the period immediately preceding freezeup. Level observations are conducted monthly on all heave-gage reference rods and two vertical movement points installed adjacent to the ground-water wells. Frost and permafrost probings and other special observations are performed as required during the test period.

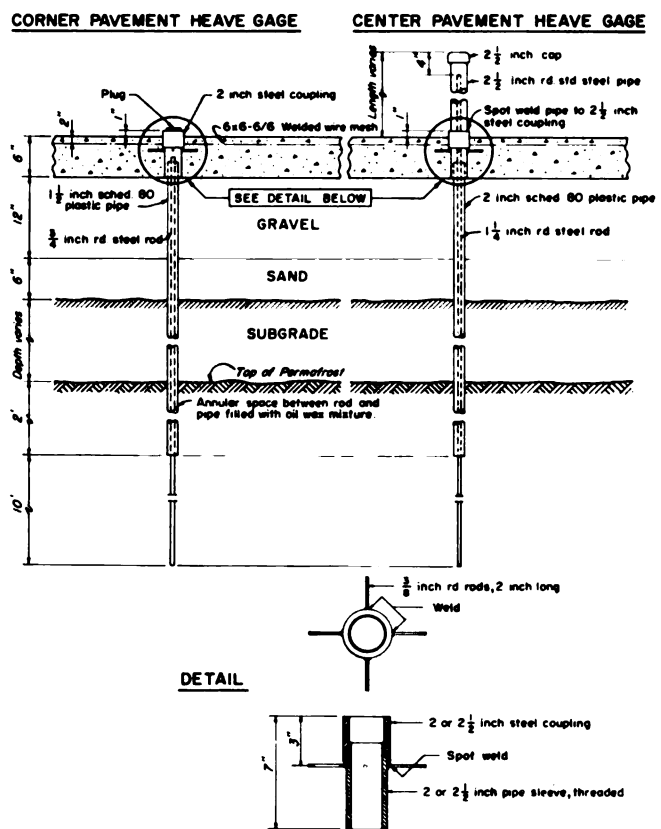

Fig. 4. Heave gage details

DEPTH	SYMBOL	UNIFIED SOIL CLASSIFICATION	WATER CONTENT %	DENSITY PCF	LL	PL	PI	G
		Turf and Peat	—	—	—	—	—	—
1.0	ML	Dr grey SILT w/roots and organics	32.9	84.5	35.4	31.6	3.8	—
1.7	ML	Dark brown SILT w/random spaced 1/2 inch thick organic layers	31.0	89.5	32.1	29.1	3.0	2.74
3.5	ML	Dark grey SILT w/randomly oriented rust stains and thin organic layers	32.6	87.2	32.7	30.0	2.7	2.69
5.8	ML	Brown and grey SILT w/organics, as compressed leaves and twigs	41.5	76.4	31.6	30.8	0.8	2.69
7.4	ML	Dark grey SILT w/thin organic layers randomly spaced	38.0	79.9	33.5	32.0	1.5	2.69
10.1		Permafrost at 10.1 feet						
10.8	ML	Grey brown SILT, frozen, w/thin organic layers and hairline ice lenses.	118.6	42.1	38.1	34.5	3.6	2.65
14.6			94.9	50.3	34.7	31.4	3.3	2.70
19.0	ML	Grey SILT, frozen, w/thin organic layers randomly spaced and stratified hairline ice lenses.	47.0	68.0	31.5	28.1	3.4	2.70
24.0		Bottom of exploration						

Fig. 5. Boring log and soil data, October 1960

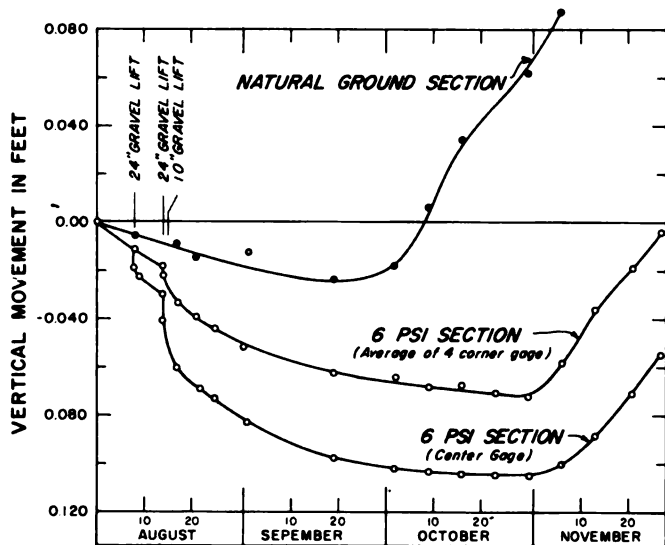

Fig. 6. Loading curves, 6 psi section

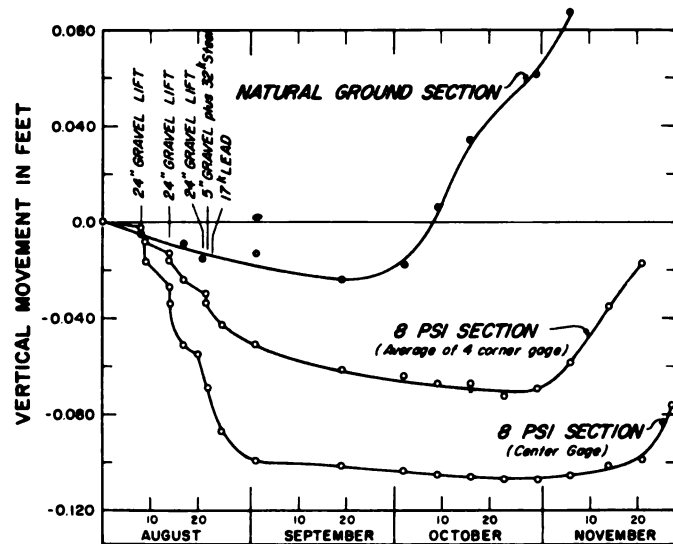

Fig. 7. Loading curves, 8 psi section

SOIL DATA

Continuous soil samples were obtained to 24 ft beneath the center of the control section, the 2 to 4 and 6 to 8 psi transition sections prior to construction. Fig. 5 shows the soil log for the boring made under the 6 to 8 psi transition section together with related soil test data.

LOAD BOX CONSTRUCTION AND LOADING

Construction of boxes for loads on the 2, 4, 6, and 8 psi sections and the transition and control section platform (Fig. 2) took from mid-April to mid-May, 1961. The boxes remained empty during the summer, while loading started in early August after all seasonal subsidence of the concrete slabs had occurred. The ducted load boxes provided air circulation for a more uniform frost penetration beneath the test sections.

The 18 in. base course and 6 in. concrete slab of the 2 psi section placed a load of about 2 psi on the subgrade soil, so that no additional surcharge load was required on this section. Surcharge load for sections 4, 6, and 8 psi was obtained by filling the load boxes with gravel. Gravel moisture content

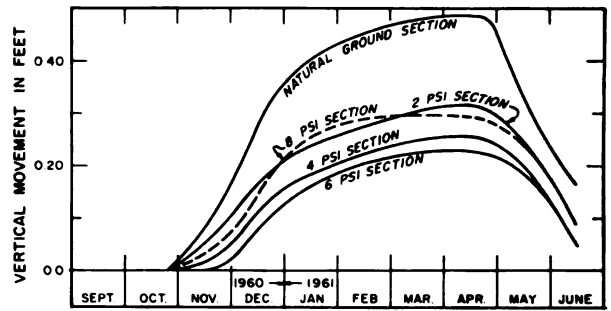

Fig. 8. Data from 1960 to 1961

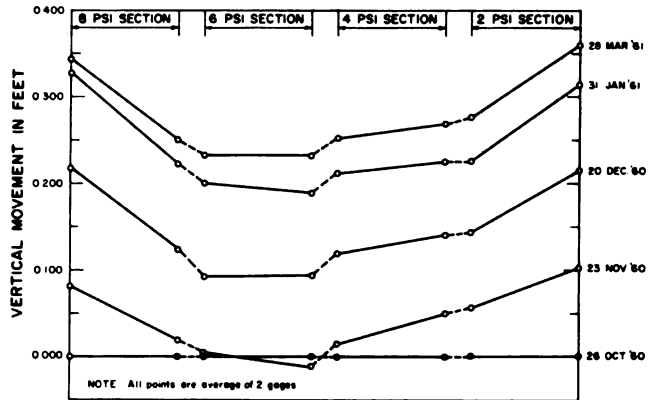

Fig. 9. Longitudinal heave profile, 1960 to 1961

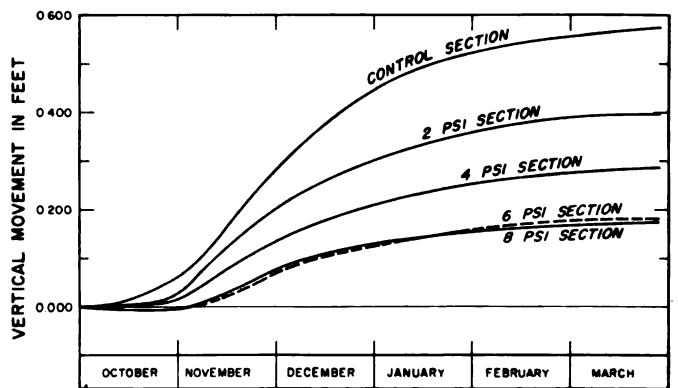

Fig. 10. Heave-time curves, 1961 to 1962 freezing season

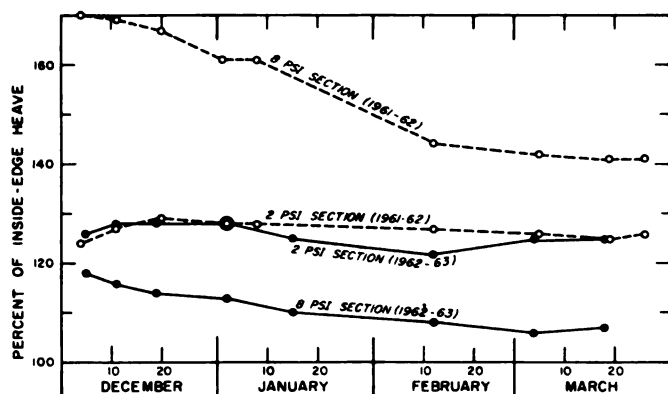

Fig. 11. Effect of 6 psi transition section in reduction of edge effect

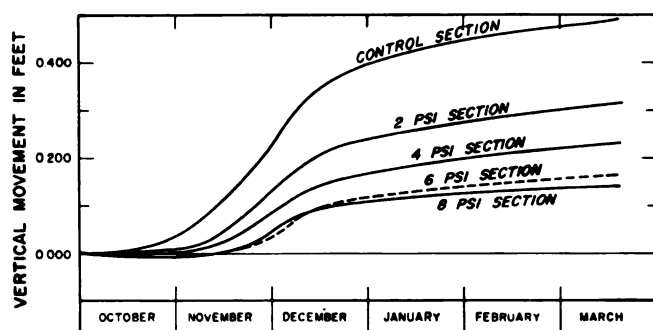

Fig. 12. Heave-time curves, 1962 to 1963 freezing season

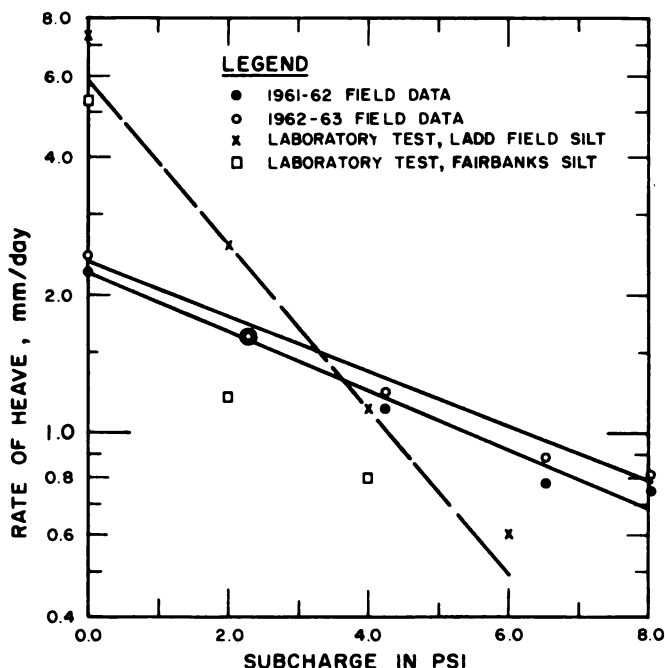

Fig. 13. Rate of heave versus surcharge loading

and density were closely controlled, and the boxes were covered after loading to prevent any large changes in moisture content of the fill. A maximum load of 2 psi was added each week until the design loadings of 8, 6, and 4 psi had been obtained. All instrumentation was frequently observed during the loading period.

PERFORMANCE DURING LOADING PERIOD

Figs. 6 and 7 present the vertical movement during the loading period for the 6 and 8 psi sections, showing that the slabs assumed a slightly dish shape upon application of load. Average settlement of the 4 and 8 psi sections during the loading period was about as expected; the 6 psi section, because of the natural drainage channel, however, exhibited slightly greater settlement than was anticipated. No problems were encountered during the loading period, and all instrumentation performed satisfactorily.

PERFORMANCE DURING 1960 TO 1961 FREEZING SEASON

As mentioned, the sand and gravel base course and concrete slab place a load of about 2 psi on the silt subgrade. Note the interesting vertical movement data obtained during the 1960 to 1961 freezing season to see how the sections performed under an equal 2 psi load. Figs. 8 and 9 present pertinent data for the 1960 to 1961 freezing season. Both the 2 and 8 psi slabs exhibited a slightly greater heave than 4 and 6 psi slabs, due primarily to the edge effect on the ends of the 2 and 8 psi sections (Fig. 9). Vertical movement data for the 1960 to 1961 freezing season were obtained by averaging level observations taken on the corners of each slab, as the pavement-heave gages were not operative. Data from the natural ground section were obtained by averaging the four corner vertical movement gage readings. The data show that a considerable reduction in total heave, up to 50% for the 4 and 6 psi sections, was obtained with only a 2 psi surcharge on the subgrade soil.

The condition of the concrete after this first freezing season was excellent, with only minor cracking on one corner of the 6 psi slab.

PERFORMANCE 1961 TO 1963

The 1961 to 1962 freezing season was slightly colder than average with a freezing index of about 5900 degree-days F. This was the first freezing season for the test sections under design load. Fig. 10 shows the vertical movement of test sections during the period from October 1961 to March 1962. The 2 psi section heaved about 30% less than the natural ground and control sections; this was also the case in the 1960 to 1961 season. The 4 psi section showed a 30% reduction in heave when compared to the 2 psi section, and over-all vertical movement of about 50% less than the natural ground and control sections.

Vertical movement of the 6 and 8 psi sections during this period was almost identical because: (1) Influence of edge effect on the south end of the 8 psi section results in a high average heave for this section; (2) performance of the 6 psi section during the loading period and the wetter-than-average subgrade conditions under this section suggests that some additional subgrade settlement occurred during the early part of the freezing season; and (3) temperature data show less frost penetration beneath the 6 psi section than under the 8 psi sections (possibly in part due to differences in subgrade moisture conditions beneath them).

An additional 6 psi section (Fig. 2) was constructed adjacent to the 8 psi section in late summer 1962 to minimize the edge effect on the south end of the 8 psi section. This edge effect has complicated analysis of the vertical movement data as mentioned before. Fig. 11 shows the effect of the new section in reducing edge effect. The outside (north) edge of the 2 psi section heaved about 25% more than the inside edge in both the 1961 to 1962 and 1962 to 1963 seasons. The heave of the outside (south) edge of the 8 psi section, with relation to the inside edge, was materially reduced during the 1962 to 1963 season, indicating the effectiveness of the new 6 psi transition section.

Fig. 12 presents the heave-time curves for the 1962 to 1963 freezing season. The vertical movement for all test sections during this season was less than the preceding year. The rates of heave observed, however, were quite similar for both years through the end of December. This relationship might

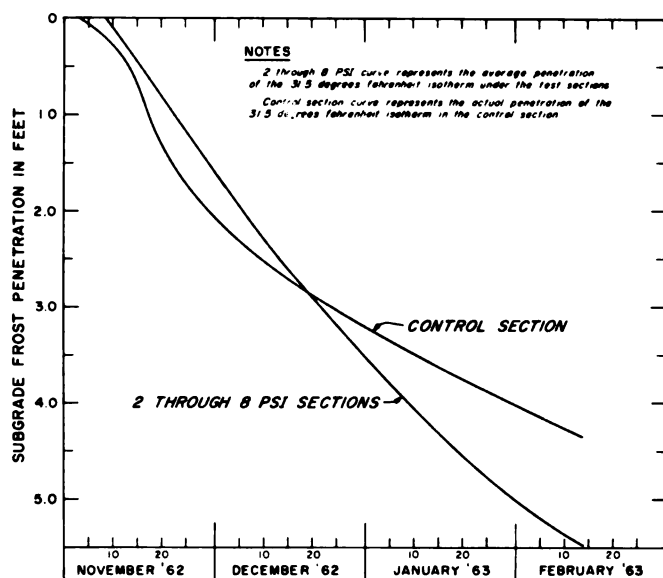

Fig. 14. Frost penetration 1962 to 1963 freezing season

have held for a longer period except that January 1963 was the warmest January in 26 years at Fairbanks, thus slowing frost penetration beneath the test sections. A more detailed analysis of the rate of heave versus surcharge is presented later.

VERTICAL MOVEMENT DATA

This analysis attempts to formulate a relationship to enable the airfield and highway designer to determine the reduction in seasonal frost-heave resulting from the surcharge load imposed on the subgrade by a nonfrost susceptible base course fill. Close examination of the vertical movement versus time curves (Figs. 10 and 12) shows that the vertical movement of all sections is essentially linear with respect to time for a considerable portion of the frost-heave cycle. Therefore, during this portion of the heave cycle, the vertical movement can also be related to the surcharge pressure using

$$R = ae^{-bG_o}$$

where R is the rate of heave in mm/day, G_o is the surcharge load in psi, and a and b are empirically determined constants. Fig. 13 presents some curves obtained using this approach. Laboratory data for this figure were obtained from undisturbed soil samples placed in cylinders of 6 by 6 in. Samples were frozen from the top down at a rate of 0.25 in. per day in a specially designed freezing cabinet [1]. Surcharge weights were placed on the samples to a maximum of 6 psi. The steeper slope of the laboratory curve indicates that an unlimited supply of free water was available at the freezing face in the laboratory specimens which, of course, is lacking in the field.

In Fig. 13, the increase in surcharge pressure at the freezing face due to increase in frozen overburden is neglected, because it is a constant for each pressure at any given time. An expression including this factor as well as one encompassing the entire heave cycle could be developed, although the complexity of the latter expression would limit its design usefulness.

The linearity of the frost penetration curves for the 1962 to 1963 freezing season (Fig. 14) suggested another solution. If frost penetration is essentially linear, the relation between heave and penetration for various surcharges is as shown on Fig. 15. This relationship may possibly be a special case; a more detailed investigation in this area is necessary before it could be used for design.

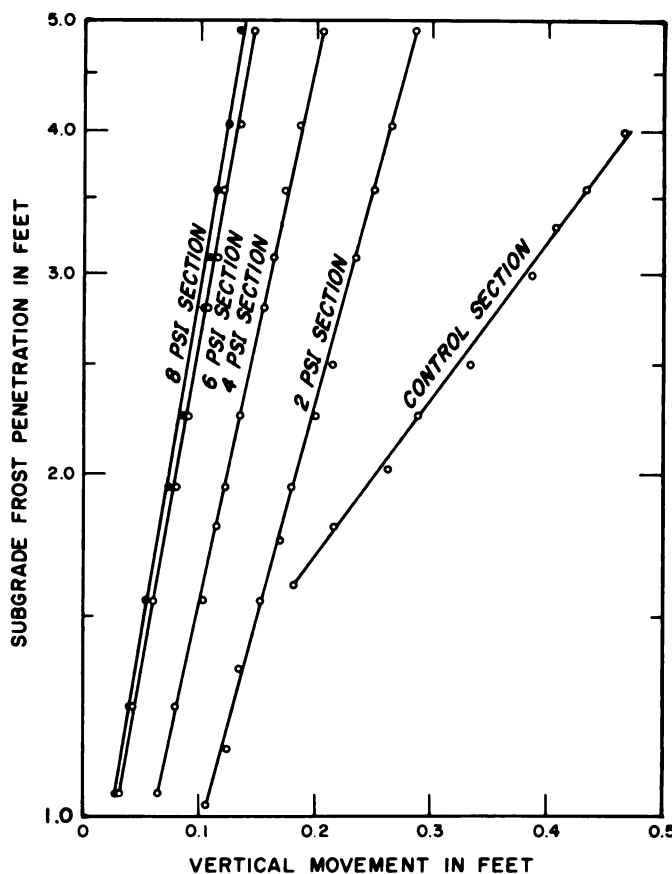

Fig. 15. Frost penetration versus heave 1962 to 1963

CONCLUSIONS

Seasonal frost-heave of fine-grained soils in a permafrost area may be reduced considerably by nominal surcharge loads.

Field and laboratory data available indicate a definite relation between frost-heave rate and surcharge pressure on the subgrade, when frost-heave is essentially linear with time. Data also show the possibility of developing relationships between heave, frost penetration, and surcharge pressure.

With additional field and laboratory data it will be possible to develop design criteria suitable for airfield and highway engineers. These criteria will assist the designer in his selection of optimum nonfrost-susceptible base course thickness to assure reliable pavement performance.

ACKNOWLEDGMENT

Substantial support to this investigation is being furnished by AFS personnel under F. F. Kitze. This is an interim report of a program at USA CRREL for the Civil Engineering Branch, Engineering Division, Military Construction, Office, Chief of Engineers.

REFERENCE

[1] K. A. Linell, C. W. Kaplar. "The Factor of Soil and Material Type in Frost Action," *Highway Res. Bd. Bull.* 225, 1959, pp. 81-126.

INSTABILITY OF MECHANICAL PROPERTIES OF FROZEN AND THAWING SOILS

N. A. TSYTOVICH, Frozen Soil Mechanics Laboratory, Obruchev Permafrost Research Institute, USSR

When using permafrost as foundations or as a medium for construction, an engineer encounters a peculiar material. It has no qualities common to other materials, and is so easily affected from the outside that even minor changes in the value, character, and time of effect of the external factors interfere with the mechanical properties of the material.

It is very important to know, therefore, what changes of the mechanical properties of frozen soils should be taken into consideration while making calculations for foundations of structures to be built on frozen soils, underground communications in frozen soils, etc. It is important to find out what may result from these changes; that is, to establish methods of determining design characteristics of frozen soils that consider their instability.

It is necessary to estimate beforehand the effect of changes in the bearing capacity of frozen soils in engineering practice, and the maximum value of this change, nonuniformity of deformation of a frozen soil mass in depth, and other characteristics of the mechanical properties of frozen soils. Following are the main characteristics: Strength characteristics, such as the ultimate continuous resistance to compression and shear, and deformation moduli in the frozen and thawed states.

CAUSES OF INSTABILITY

Mechanical properties of frozen and thawing soils depend upon their internal interparticle bonds, such as electromolecular, aqueocolloidal, and ice-cementational.

The most important properties for frozen soils with their negative or zero temperature (in which even a part of the water is frozen [1]) are ice-cementation bonds because they are the strongest and most easily changed. The mechanical properties of frozen soils depend mainly on the number and properties of these bonds.

The most important properties for thawing soils are the process of destruction of the ice-cementation bonds (which controls the jump-type changes of their porosity when thawing) [2], and the values of the aqueocolloidal and electromolecular bonds, which change during thawing and in further consolidation.

Ice-cementation bonds are rather sensitive to external changes and thus interfere with the mechanical properties of frozen soils and permafrost.

The causes of the instability of the mechanical properties of frozen soils are both quantitative changes in content of pore ice and unfrozen water in frozen soils, and qualitative changes of ground ice under external influences.

Direct experiments show (Bouyoucos, 1916; Beskov, 1935; Yung, 1934; Andrianov, 1936; and Tsytoovich and Nersesova, 1940-53, etc., [3-7]) that frozen soils, as well as permafrost, always contain an amount (perhaps insignificant), of unfrozen water together with ice [1].

According to the principle of dynamic equilibrium of unfrozen water and ice in frozen soils formulated by the author [1, 8] the amount of unfrozen water is not constant. It changes with the change of external influences affecting frozen soils, (temperature, pressure), with which it is in dynamic equilibrium.

The problem of the phase composition of water and of the change of this content under the effect of external influences is investigated in detail [7]. It is suggested that both the quantitative changes of the amount of unfrozen water and of pore ice in frozen soils and the properties of pore ice—that is, its quality—are the main causes of instability of the mechanical properties of frozen soils and permafrost.

Recent investigations [9, 10] show that properties of pore

ice, as well as of segregated ice; lenses, wedges, etc., (see report of Shumskiy-Vtyurin in this volume, Session 2), do not remain constant, but are affected significantly by external influences. The stressed zones are characterized by recrystallization or change of macro- into microcrystalline ice, while the axes of the crystals are reoriented. Change of negative temperature is accompanied by change in the mobility of hydrogen atoms in the ice-crystalline lattice, upon which the qualitative changes of ice depend.

In turn, the qualitative changes of ice result in an increase of ice strength with reduction of temperature. Temperature reduction not only causes a decrease in the number of liquid water films adsorbed by the surface of ice crystals (indirectly proved by the experiments of Yong according to which the initial content of ice in frozen soils affects the quantitative content of unfrozen water in frozen soils [11]), but also significantly increases the strength of ice crystals.

FACTORS AFFECTING INSTABILITY

These factors are: (a) Change of temperature of soil under natural conditions and under the effect of construction; (b) change of stress state in freezing, frozen, and thawing soils under the effect of internal and external influences, and (c) duration of load which controls relaxation of stress and creep of frozen and thawing soils.

Temperature change of permafrost under natural conditions is usually irregular. This irregularity affects the heterogeneity of permafrost [1, 2, 8, 10-14]; the lower the temperature of frozen soils, the higher the resistance of these soils to external factors, and the lower the deformation. But intensity of the temperature effect on the mechanical properties of frozen soils varies with the region of phase transformation of water within which the temperature changes take place.

The author [2] considered the range of temperatures within which the change of unfrozen water is greater than 1% per 1°C to be the range of significant (intensive) transformations of water in frozen soils into ice. The range of temperatures within which the change of unfrozen water is from 1 to 0.1% per 1°C should be considered the range of insignificant transformation of water. The range of temperature within which the changes of unfrozen water are less than 0.1% per 1°C should be considered the range of practically frozen state.

Within the range of intensive (significant) phase transformations of water (for sandy soils—from 0° to -1°C, and for clay soils—from 0° to -7°C), the factor affecting the strength of frozen soils and of permafrost is the amount of unfrozen water and its change with the change of the negative temperature.

With reduction of temperature from -1° to -2°C, the strength limit for frozen sand with simple compression changes [2, 10, 15-17] from 64 to 75 kg/sq cm (by about 15%), while the strength limit of frozen clay with the same change of temperature changes from 10 to 15 kg/sq cm (by 50%). This is rather natural since the amount of unfrozen water in sand diminishes by not more than 1%, while in frozen clay it diminishes by 5%, a much greater value.

Thus, within the range of insignificant water phase transformations, it is impossible to explain the strength increase of frozen soils only by the increase of their ice content (or by reduction of the amount of unfrozen water in them), as the simultaneous effect of the second factor described; that is, the effect of the qualitative change of ice is significant (increase of its strength with reduction of the negative temperature) [9, 10].

Within the range of the practically frozen state, with the amount of unfrozen water changing by less than 0.1% per 1°C, the main factor affecting the strength properties of a given frozen soil is the strength of cementation ice and its increased strength with temperature reduction.

These statements are applicable for estimating the deformation (compressibility) of frozen soils with a change in negative temperature.

As experiments [12, 18] show, the compressibility of frozen soils at high temperature—within the range of intensive phase transformations of water—is high and close to the compressibility value of dense clays (compressibility coefficient m_v is about 0.005 to 0.03 sq cm/kg). For the practically frozen state, compressibility of frozen soils can be neglected in engineering calculations.

The difference in temperature of permafrost in depth under natural conditions results in the nonuniformity of strength and deformation properties of frozen soils. This should be taken into account when designing foundations to be built on permafrost. The problem is complicated further because during construction there will be significant thermal influences on the frozen foundation soil, making it thaw.

Three main methods of building [12] on permafrost are now in use: (a) The method of preservation of frozen condition of soils under the foundation (by using sub-floor spaces ventilated in winter); (b) the constructional method which adapts the structure to the irregular settlement of thawing soils under the foundation, and (c) the method of preparing the foundation prior to building.

With the first method, it is very important to know what temperature will exist for a sufficiently long time—two to ten years. Ultimately, with the given composition of a frozen soil, its ice content, the main factor affecting its strength properties is the negative temperature magnitude.

It is also important to know the distribution of the temperatures in permafrost below the thawing basin in order to estimate its bearing capacity when installing deep foundations, piers, piles, etc. In any case, predicting the temperature increase below the foundation, especially if it increases to a positive value, is of great importance.

The complete solution of the problem of determining the profile of the maximum (stabilized) thaw basin is given by G. V. Porkhayev in Session 8; the engineering solution of this problem is described by V. P. Ushkalov, et al (Session 7).

In this report, there is a rather simple but sufficiently precise solution of the problem of the temperature determination in the heating basin under structures built according to the method of preservation of the frozen condition (with the ventilated underground space). Also solved is the problem of the stable thawing basin of heated structures (with floors on the ground), built in accordance with the constructional method. The latter method was worked out by S. V. Tomirdiario [16, 17], who developed the idea of S. S. Kovner [19] using the known solution of the Dirichlet problem for the stress field in a half-space with the stress sources in its profile.

Tomirdiario [17] uses the converted formula of the stress field (in compliance with the solution of the Dirichlet problem), adding the temperature field of the lithosphere to the general expression $(\theta_m + Gy)$, where θ_m is mean annual temperature of the soil surface, G is geothermal gradient in the lithosphere, and y is depth coordinate. The thermal insulation of the building floor (with area F) is taken into account by adding an equivalent layer $S = F \lambda_{th}$ (where λ_{th} is the coefficient of thermal conductivity of thawed soil).

After introducing a factor for reduction to a homogeneous layer which equals λ_{th}/λ_f , as stated by S. G. Gutman, where λ_f is the coefficient of thermal conductivity of frozen soil, Tomirdiario obtains the solution of the problem

$$\theta_{max} = \theta_{xy} + \theta_{A1} \quad (1)$$

where θ_{max} is the maximum temperature at the given depth beneath the active layer, θ_{xy} is mean annual temperature of

soil beneath the active layer for the point with coordinates (x, y) , and θ_{A1} is amplitude of annual temperature fluctuation at the boundary of any layer (l) .

The temperature (θ_{xy}) , with any number of heating sources, is determined from

$$\theta_{xy} = \frac{1}{\pi} \sum_i^n \left[\left(\frac{\lambda_{th}}{\lambda_f} \theta_{Bn} - \theta_m \right) \left(\arctan \frac{\frac{B_n}{2} - X + l_n}{y + F \lambda_{th}} + \arctan \frac{\frac{B_n}{2} + X - l_n}{y + F \lambda_{th}} \right) \right] + \theta_m + G_y \quad (2)$$

where θ_{Bn} is temperature inside the building, B_n is width of each building, and l_n is distance from the origin of the coordinates located in the center of the building on the far left to the center of all other buildings (if the thermal effect of several buildings is to be determined).

Value θ_{A1} is found from the following approximate expression:

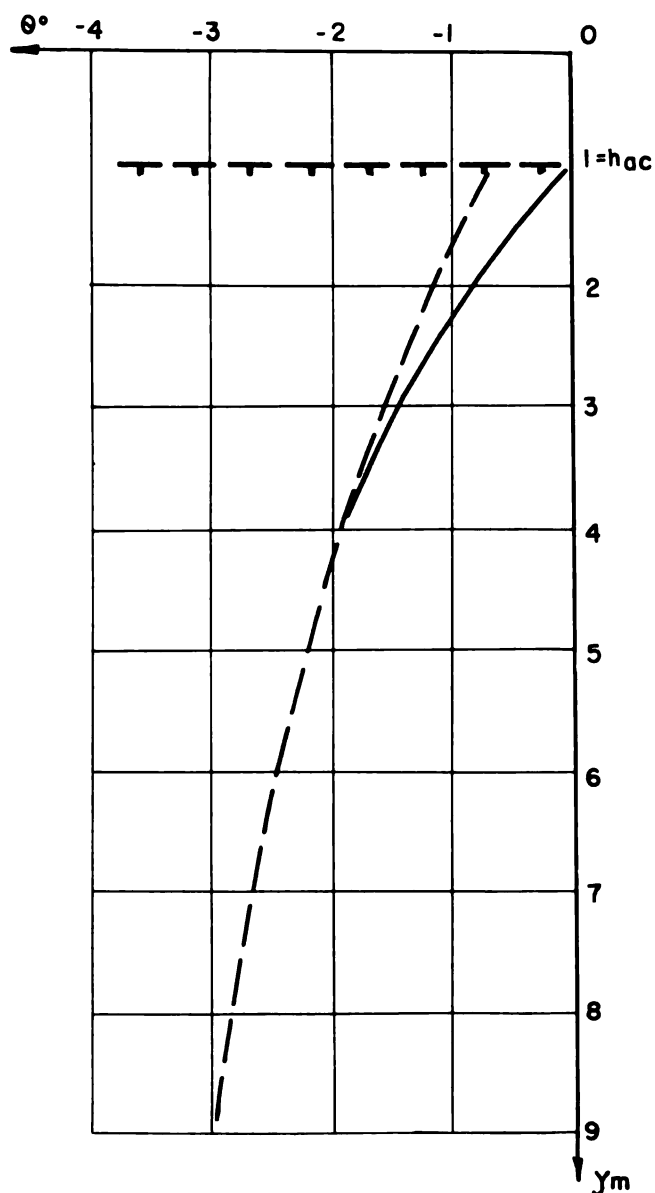

Fig. 1. Curves of maximum heating in permafrost under a building foundation: --- Maximum steady state heating; — Maximum seasonal temperature in permafrost

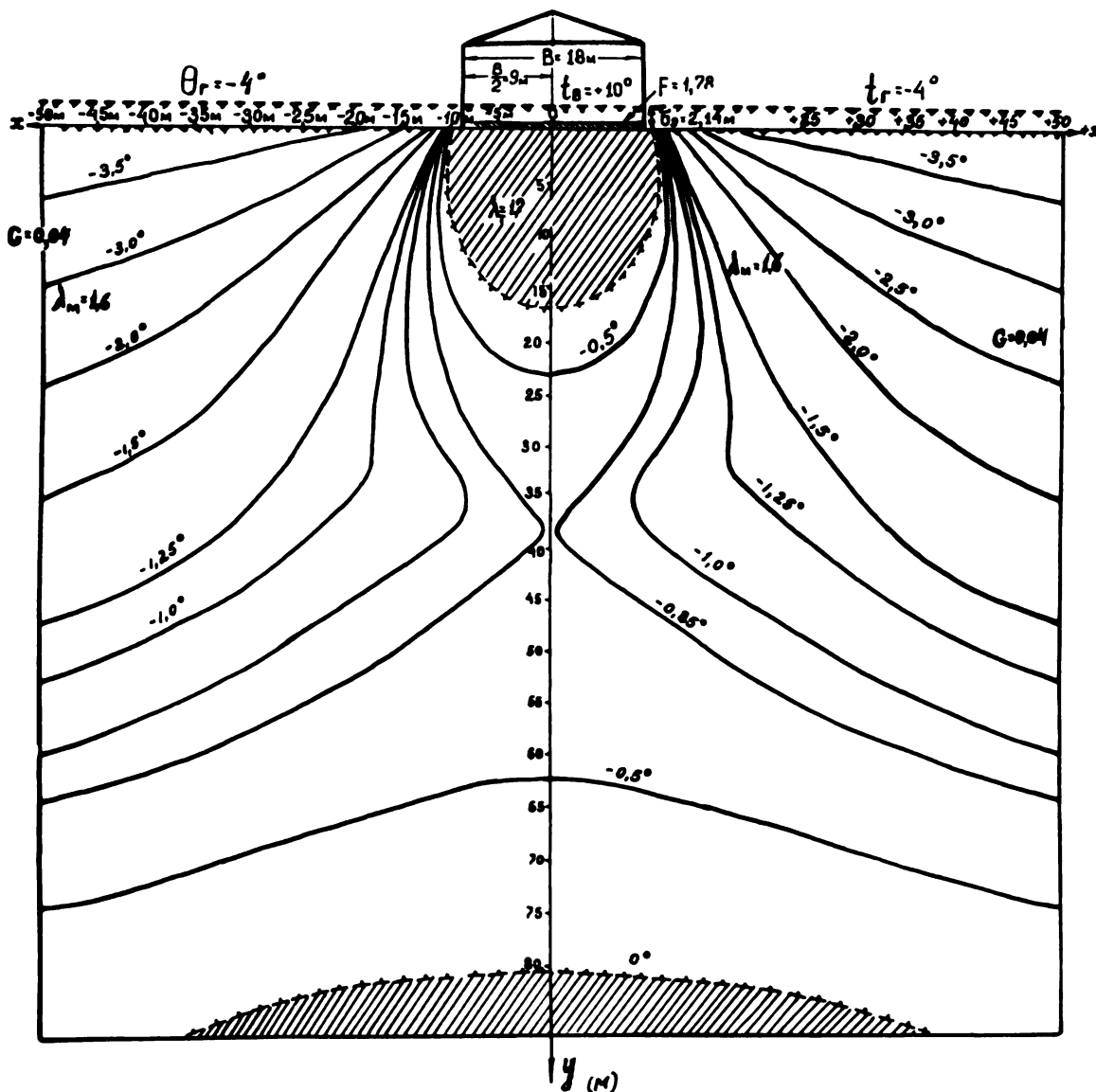

Fig. 2. Temperature field in the ground under an isolated heated building with floor on grade

$$\theta_{Ai} = \theta_{(i-1)} e^{-\delta_i \sqrt{\frac{\pi}{\alpha_i^E T}}} \quad (3)$$

where θ_{Ai} is amplitude at the upper boundary of any layer (i), δ_i is known thickness of separate soil layers, T is period of one cycle of temperature (1 year or 8760 hours), and α_i^E is effective thermal diffusivity of any (i) layer, to be determined considering the heat used to change unfrozen water in the soil pores into ice within the given range of temperature change [16].

As an example, Fig. 1 gives curves of the maximum heating condition and of the maximum seasonal temperature of permafrost calculated by (1) and (2) of S. V. Tomirdiario [16], for these values: B = 9.7 m, $\lambda_{n-1} = B/2$, $\theta_{Bn} = 17^\circ\text{C}$, $\theta_m = -6^\circ\text{C}$; permafrost in icy, sandy loam (w = 40%, $\lambda_f = 1.75 \text{ kcal/m-hour-}^\circ\text{C}$).

The example is of an actual building, under which the temperature of permafrost was measured at various depths for one year. The measured temperature values are close to the calculated values [17].

The results calculated from the same equation (2) are illustrated in Fig. 2 [17] for the thawing basin of the building with the floor on the ground taking into account the thawing of

the frozen foundation.

The temperature field obtained under the building is rather complicated, but should be considered if it is necessary to determine precisely the change of the bearing capacity of the foundation soils resulting from the increases in their temperatures.

The properties of permafrost are unstable not only during preservation of the frozen foundation, but also in thawing of the soils under structures. First, during thawing, boundary conditions change as the depth of soil with low compressibility (permafrost) continuously increases; then, in thawing (for clay soils for a long time after thawing), the soil consolidates, causing variations of the deformation modulus in the width of the thawing layer.

Thus, as shown by V. D. Ponomarev, who works in the laboratory directed by the author, tests with models of thawing clay foundations indicate that the change in the void ratio of the thawed soil under load diminishes with depth according to an exponential law. While this significantly affects the distribution of pressure within the depth of the thawed layers, the main effect is on the pressure distribution at the contact surface of thawed and frozen layers. The tests were done under the conditions of a plane problem (Fig. 3c).

Fig. 3a illustrates the curves of change of the soil void

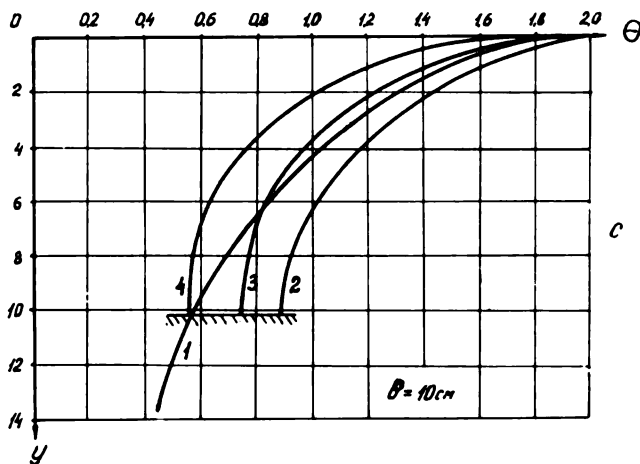
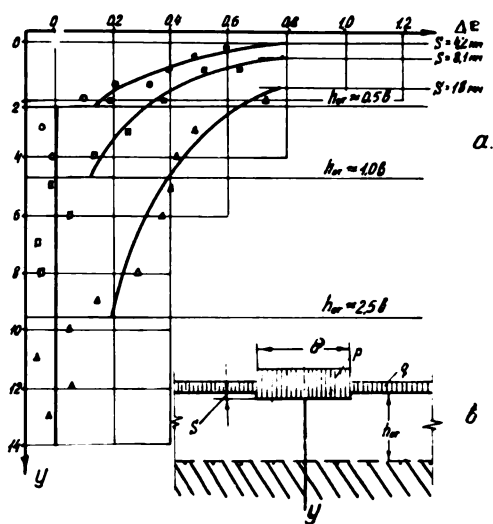

Fig. 3. Nonuniformity in consolidation (expressed as void ratio Δe) and distribution of the sum of principal stresses θ with depth y in thawing frozen clay

ratio (Δe) in the process of thawing, while Fig. 3c shows the distribution with depth of the sum of the principal stresses (θ) obtained by use of electronic analog computer analysis of nonuniform foundation soil, the deformation modulus which diminishes with depth. In this case, curve 1 corresponds to an infinite uniform half-space under the conditions of the plane problem; curve 2 corresponds to the elastic uniform layer on the incompressible foundation soil; curves 3 and 4 correspond to the nonuniform layer, with its deformation modulus linearly diminishing with depth. For curve 3, $E_{\max}/E_{\min} = 2$ and for curve 4, $E_{\max}/E_{\min} = 50$.

The above data show that within the layer of variable compressibility, lying on the incompressible foundation soil, the sum of the principal stresses to which the consolidation settlement during thawing is proportional, can be significantly less than for a homogeneous layer and even for the homogeneous half-space.

Thus, the change in compressibility with depth significantly affects the value of the ultimate settlements during thawing.

A change in the stress condition of freezing, frozen, and

thawing soils greatly affects their deformation and their resistance to the external factors. As is shown by the investigations carried out at the Igarka scientific research station of the USSR Academy of Sciences [15], freezing of soils is accompanied not only by generation of stresses in the freezing layer and by a change in the pore pressure in this layer, but also by an increase of pressure in the frozen soil layers as well (this pressure greatly exceeds the pressure values caused by the weight of the upper layers).

For instance, with freezing of the soil to 1.8 m under the conditions at Igarka, the pressure in the frozen fine grained soil reached 0.75 kg/sq cm, which is much greater than the pressure caused by the weight of the soil, approximately 0.3 kg/sq cm.

Fig. 4 illustrates the graphs obtained by V. O. Orlov [15] for the change in pressure in frozen soil, when measured by mechanical gages and the graphs illustrating the change of the soil temperature at points close to the locations of the gages.

The graphs show that pressures, in general, follow the changes in the soil temperature. The data can be explained by the supposition that in accordance with the principle of dynamic equilibrium of unfrozen water and ice in frozen soils [1, 20], the main effect of the stress field is phase transformations occurring in the freezing and frozen soils: The change of the negative temperature of frozen soils causes not only a change in ice content, but also in stress, which in turn affects the mechanical properties of the frozen soils.

The external pressure affects the properties of frozen soils in two ways: First, the amount of unfrozen water in frozen soils increases with an increase in pressure; and second, local pressures at the points of contact of the mineral particles also significantly increase.

The increase in amount of unfrozen water in frozen soils results in reduction of their strength and in the increase of their deformability, which is most important within the temperature range of intensive phase transformations of water into ice. Experiments by the author showed [8] that a clay soil at -1.7°C contained 42% unfrozen water, but when subjected to an external pressure of 2 kg/sq cm at the same temperature, the soil contained 58% unfrozen water.

Such a significant change in unfrozen water content affects both ultimate strength and deformation modulus of frozen soils—both decrease. For instance, Young's modulus of a sandy loam permafrost of undisturbed structure (which contains 8% clay, with moisture content $w_0 = 40\%$, at a temperature of

$\theta = -4^{\circ}\text{C}$) is: With a pressure of 1 kg/sq cm, $E_1 = 100 \times 10^3$ kg/sq cm, with a pressure of 2 kg/sq cm, $E_2 = 60 \times 10^3$ kg/sq cm, and with a pressure of 3 kg/sq cm, $E_3 = 47 \times 10^3$ kg/sq cm.

For very dense frozen soils, the effect of external pressure on unfrozen water content, and consequently on their deformability, is reduced. This may be explained by the great

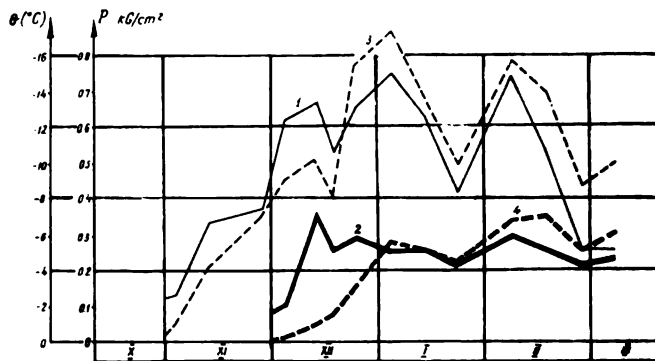

Fig. 4. Pressure and temperature changes in frozen ground during freezing and cooling. 1. Pressure at depth of 0.4 m; 2. Pressure at depth of 1.0 m; 3. Temperature at depth of 0.5 m; 4. Temperature at depth of 1.0 m

coherence of pore water in these soils.

The cause of the influence of external pressure on the mechanical properties of frozen soils is the transformation at points of contact of the mineral particles caused by large local stresses. These stresses effect thawing of ice, its flow, and movement of water into less stressed regions, as shown by the work of S. S. Vyalov [18]. He studied the distribution of ice in permafrost prior to and after load tests.

In layers of ice under the effects of a stress field, there is a recrystallization of ice, a reduction of the size of ice crystals, and a change of their orientation relative to the direction of the stresses. These changes occur rather slowly, but always take place, as shown by special experiments [2]. Fig. 5 shows photographs of ice microsections prior to the test (Figs. 5a and a') and after continuous compression (Fig. 5b) and shearing (5b').

Being affected by the stresses, the amount of unfrozen water in a frozen soil changes, as does the ice-cementation. Ice flows from the more stressed regions into the less stressed ones. This process, accompanied by recrystallization of ice layers, causes both stress relaxation and a somewhat denser packing of the mineral particles of frozen soils. These processes and the changes of properties of frozen soils have more significant effects when stress action is continuous.

Duration of load effect is one of the most important factors affecting the mechanical properties of frozen soils. It is well known [10-12, 14, 18] that rapid increase of load or its slow application quite differently influence the resistance and deformability of frozen soils. With a rapid increase of load, the resistance of frozen soils is high, while with continuous effect of load, the strength of frozen soils is reduced many times. This reduction is a result of plastic flow of ice layers and viscous flow of unfrozen water influencing not only relaxation (reduction) of stresses, but also creep of frozen soils under load.

Strength reduction of frozen soils is well described by a logarithmic relationship. Discussion of creep of frozen soil under load by Vyalov appears in Session 6 of this volume.

Main relationships were obtained recently [21] from work by Vyalov. In 1959, he showed by experiments [18] that the relationship between stress and strain for frozen soils is not linear. The deformation modulus is dependent both on negative temperature magnitude (θ°), and time of load action (t), that is,

$$\sigma = E(\theta^\circ, t) \epsilon^m \quad (4)$$

where $E(\theta^\circ, t)$ is the deformation modulus of a frozen soil, which may be assumed equal to $E(\theta^\circ, t) = \omega(\theta+1)^K t^{-\lambda}$ as was experimentally proved by S. E. Gorodetskii [21]; where ω, K, λ are parameters obtained experimentally (some values are given in Vyalov's report), ϵ is strain of a frozen soil, and m is a parameter (less than 1), which depends neither on the temperature of a frozen soil nor on time.

If Volterra-Boltzmann's equation from the theory of hereditary creep is used to describe the deformation of frozen soils, the equation of creep of frozen soils (neglecting their momentary deformation in case of constant stress) can be described as follows [21]:

$$\epsilon = \frac{\sigma t \lambda}{\omega(\theta + 1)^K} \quad (5)$$

The continuous tangential resistance of frozen soils in case of displacement along the foundation surface (the value required for calculations of foundations in heaving) is the temperature function [15]:

$$\tau_F = C + d\theta^{n_0} \quad (6)$$

where d and n_0 are parameters of a logarithmic group of curves, and C is a factor characterizing the relationship

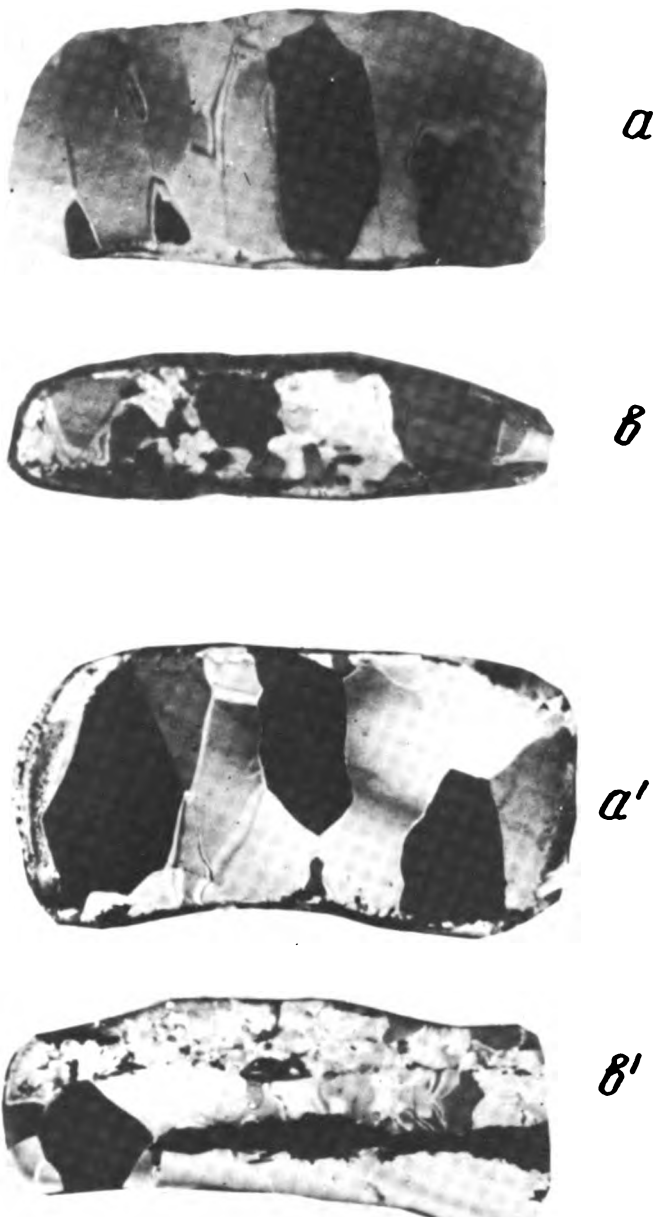

Fig. 5. Structure of ice segregations in frozen soil: a and a' Before loading; b After prolonged testing in compression; and b' After prolonged testing in shear

between resistance to shear and ice content of frozen soils having the same velocity of load increase at which d and n_0 were determined.

Dependence of shear resistance of frozen soils on ice content (ratio of weight of ice to weight of all water substance contained in the frozen soil) and on velocity of soil movement along the foundation surface can be approximated by the straight line equation [15].

RESULTS OF INSTABILITY

As shown, the mechanical properties of frozen and thawing soils greatly depend upon three factors: (a) The value of the negative temperature, which influences the ice content of frozen soils; (b) the internal state of stress, changing as a result of phase transformations of water in frozen soils caused

by changes of the negative temperature and external load, and (c) the duration of the load application, which affects relaxation and slow creep of frozen soils.

With a constant negative temperature and constant external load, frozen soils as compared with pure ice have a finite value of the continuous resistance (continuous strength), not zero. However, the value of this resistance is sensitive to external influences: A change in the temperature of even 0.1°C or in the external pressure of even a fraction of a kg/sq cm, especially if the soils are at a high temperature, is enough to change the ultimate continuous strength. This should be considered when estimating strength and deformation properties of frozen soils.

Instability of the mechanical properties of frozen soils and their sensitivity to external influences cause a variation in depth of frozen and thawing soils. This, along with the non-linearity of the relationship (for these soils) between stress and strain and the hereditary creep property, complicates calculations in frozen soils to be used for foundations. Giving consideration to the relationships described sometimes permits more effective designs of foundations for structures that are built on permafrost and thawing soils. Further, forecasting the behavior of permafrost and thawing soils may be more accurate—closer to observed results.

Take, for example, the solution to the contact problem worked out by Yu K. Zaretskii [13] for a rigid footing on a frozen soil having nonlinear creep properties; the modulus of deformation E follows the law

$$E^{1/m} = \gamma \eta$$

where γ is the depth, and m and η are parameters of pressure; p_0 is the pressure at the center of the footing; and p_b is the pressure at a distance of $39/40$ of the half-width (as fractions of P_B). For nonlinear and nonuniform soil, $m = 0.3$ and $\eta = 0.5$; $p_0 = 0.476$, and $p_b = 0.597$. For a uniform soil having stress and strain proportional, $p_0 = 0.318$, and $p_b = 1.431$.

The data show that considering the nonuniformity and non-linearity of the frozen soil permits a more uniform distribution of pressure during design that would usually be obtained by use of the linear elasticity theory.

With more uniform distribution of reactive pressures, bending moments for the footing are much reduced, which permits more economical design (from 30 to 40%) without impairing the strength.

Similarly, taking into account the reduction of the deformation modulus with depth for thawing soils leads to more economical solutions.

CONCLUSIONS

When estimating the mechanical properties or deformation of frozen and thawing soils for design, their instability with time should be considered. Either the choice of the design characteristics should depend on the proposed time period, service life of the construction, or the value of these characteristics should correspond to the ultimate stable values.

In considering the future changes of the mechanical properties of frozen and thawing soils, the theory of predicting interaction of the structure and permafrost should be worked out and tested in practice.

Taking into account the nonuniformity and nonlinearity of permafrost on the basis of the theory of hereditary creep permits an approach to the natural mechanical processes and determination of the most economical design.

Further investigations of the theory of calculations in permafrost as nonuniform in depth for nonelastic bases (on the

basis of the experimental determination of their actual properties, with changes of temperature, state of stress, and time taken into consideration) are very necessary.

REFERENCES

- [1] N. A. Tsytoich. "On a Theory of Equilibrium of the Water Content in Frozen Soils," AN. SSSR, Vol. IX, No. 5-6, 1945 (in Russian).
- [2] "Materials for Laboratory Investigations of Frozen Soils," Symp. 1, 2 and 3, AN. SSSR, Moscow, 1953-1954, 1957 (in Russian).
- [3] G. Bouyoucos. "Further Studies on the Freezing Point Lowering of Soils," Mich. Agr. Exp. Sta. Tech. Bull., No. 31, 1916.
- [4] G. Beskow. "Tjälbildningen och Tjällyfteigenen," Sver. Geol. Unders. Ser. C, No. 375, Stockholm, 1935, (Also: "Soil Freezing and Frost Heaving with Special Application to Roads and Railroads," Transl. J. O. Osterberg, Tech. Inst. Northwestern Univ., 1947).
- [5] E. Yung. Zeitschr. Pfl. Dung. Bodenk., B. 24, H. 1-2, 1932.
- [6] P. I. Andrianov. Coefficients of Expansion of Soils on Freezing, I, Temperatures of Freezing Soils, II, transl. of Far Eastern States Exped., 1st ed., Moscow, 1936 (in Russian).
- [7] Z. A. Nersesova, N. A. Tsytoich. "Unfrozen Water in Frozen Ground," in this volume, Session 4.
- [8] N. A. Tsytoich. "On Unfrozen Water in Unconsolidated Earth Deposits," AN. SSSR Geol. Ser., No. 3, 1947 (in Russian).
- [9] P. A. Shumskii. Principles of the Structure of Glaciers, Moscow, AN. SSSR, 1955 (in Russian).
- [10] N. K. Perkarskaya. Strength of Frozen Soils in Shear, Moscow, AN. SSSR, 1963 (in Russian).
- [11] R. Yong. "Research on Fundamental Properties and Characteristics of Frozen Soils," Proc. 1st Can. Conf. Permafrost, Ottawa, 1963.
- [12] N. A. Tsytoich. Bases and Foundations on Frozen Soils, Moscow, AN. SSSR, 1958 (in Russian), (Also: Highway Res. Bd. Spec. Rept. 58, 1960).
- [13] N. A. Tsytoich. Soil Mechanics, 4th ed. Ch. III, Moscow, Gov. Publ. House, 1963 (in Russian).
- [14] N. A. Tsytoich, M. I. Sumgin. Fundamentals of the Mechanics of Frozen Soils, Moscow, AN. SSSR, 1937 (in Russian), (also: CRREL Tech. Transl. 19, 1959).
- [15] V. O. Orlov. Cryogenous Swelling of Frozen Soils, Moscow, AN. SSSR, 1962 (in Russian).
- [16] S. V. Tomirdiaro. "Calculation of Maximum Temperatures in Permafrost Under Foundations," Foundations and Soil Mechanics, No. 4, Govt. Publ. House, 1960 (in Russian).
- [17] S. V. Tomirdiaro. Heat Calculations for Foundations in Permafrost Regions, transl. of North Eastern States Sc. Res. Inst., Magadan, 1963 (in Russian).
- [18] S. S. Vyalov. Rheological Properties and Bearing Capacity of Frozen Soils, AN. SSSR, Moscow, 1959 (in Russian), (CRREL Tech. Transl. 74, 1965).
- [19] S. S. Kovner. "On a Problem in Heat Conduction," Geophysics, Vol. III, 1st Ed., 1933 (in Russian).
- [20] N. A. Tsytoich. "Construction in a Permafrost Environment," Conf. SOPS, AN. SSSR, 1941 (in Russian).
- [21] S. S. Vyalov et al. Strength and Creep of Frozen Soils and Computations of Ice-Soil Retaining Structures, AN. SSSR, Moscow, 1962 (in Russian), (CRREL Tech. Transl. 76, 1965).

DISCUSSION

O. B. ANDERSLAND and H. B. DILLON, Michigan State University, East Lansing—Time-temperature data obtained during the rapid loading (at constant strain rate) of a frozen clay sample are shown in Fig. A.1(b). Measurable increases in the sample temperature during loading amounted to almost 0.1°C

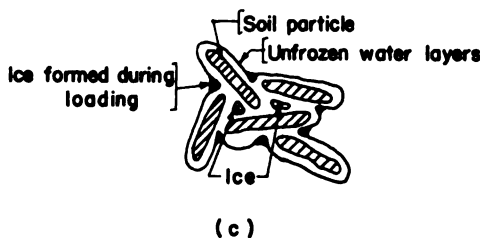
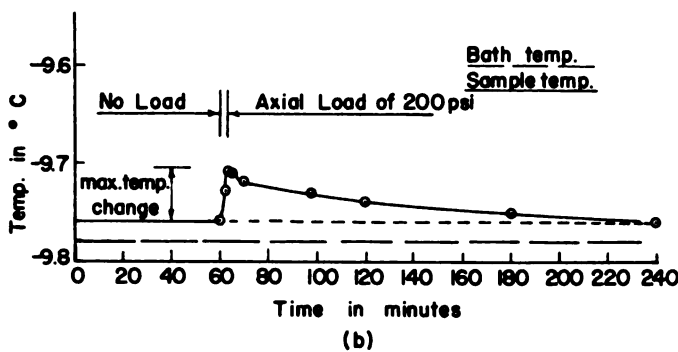
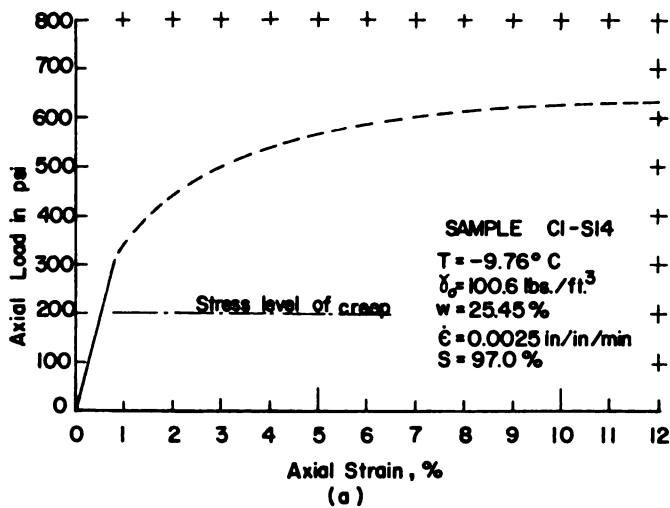

Fig. A.1. (a) Typical stress-strain curve for a frozen clay (LL = 60%, PL = 26%); (b) Change in temperature during loading for creep test; and (c) Simplified representation of particle arrangement, ice, and unfrozen water in soil sample

for 0.5% axial strain. The sample temperature before loading was held at a constant value of -9.76°C . The molded dry density, molded water content, and rate of strain were, respectively, 100.6 lb/cu ft , 25.45% , and $0.0025 \text{ in./in./min}$. The computed stress-strain curve and stress level used on creep test samples subsequent to loading are shown in Fig. A.1(a).

Temperature measurements were made using thermocouples embedded in the sample center and the sample side. The measured increase in temperature during loading and subsequent decrease to the surrounding bath temperature while under the constant load for the creep test is shown in Fig. A.1(b). Energy put into the sample during loading cannot explain the increase in the sample temperature (see sample calculations).

A plausible explanation for the source of energy responsible for this increase is the latent heat released by small quantities of the unfrozen water changing to ice during deformation. Fig. A.1(c) shows schematically where this might occur. Soil particles forced closer together or sliding along another particle may displace some liquid water from the region immediately adjacent to the soil particle into zones where it may transform to ice. This unfrozen water, on changing to ice, releases approximately 80 cal/g . An estimate can be made of the quantity of unfrozen water that was involved in this process based on the specific heats and weights of soil solids, liquid water, and ice (see sample calculations). For a sample 1.42 in. in diameter by 3.0 in. in height, approximately 0.3% unfrozen water based on dry weight of solids was involved in this "icing process" during loading.

These data contribute information on a mechanism which may influence the initial "elastic" deformation of frozen clay soil during rapid loading.

SAMPLE CALCULATIONS

Energy input by loading is

$$\begin{aligned} \text{average stress} \times \text{total strain} &= \text{energy per unit volume} \\ (\text{lb/sq in.}) (\text{in./in.}) &= (\text{in.-lb/cu in.}) \\ (200/2) 0.005 &= 0.5 \end{aligned}$$

For the sample, $0.5 (4.67) = 2.34 \text{ in.-lb}$, or 0.065 cal

Neglecting energy losses and a small change in ice content, energy required to heat the sample by 0.06°C is the heat gained by soil solids, ice, and water = 2.68 cal . Freezing of 0.033 g or 0.3% unfrozen water would release sufficient energy to account for the above difference.

RHEOLOGY OF FROZEN SOILS

S. S. VYALOV, V. A. Obruchev Permafrost Research Institute, Moscow

RHEOLOGICAL PROCESSES

As a result of ice content and unfrozen water content, frozen soils are characterized by clearly expressed rheological properties [1-6]: The ability to develop creep deformation, and to relax and reduce the resistance to load if it is continuous. The effect is significant. Deformations developed with time are hundreds of times greater than initial ones, while the continuous strength is from 5 to 15 times smaller than the momentary one. Engineering designs should, therefore, be based on the rheology theory.

Typical curves of creep in frozen soils, i.e., relative deformation with time under a constant load (Fig. 1a), differ with respect to stress magnitude. If stress is small, strain is damped with time, but if stress is large, nondamped creep strain results. Initially, the usual momentary deformation (ϵ_0) is built up (OA section of the curve in Fig. 1b), then variable deformation (ϵ_1) is developed (AB section of the curve) at a decreasing rate. In the damped process this rate tends to zero. For nondamping, the deformation rate attains a maximum value and becomes approximately constant—the stage of steady plasto-viscous flow (ϵ_2) is formed (section BC). As deformation progresses, this stage changes into a progressive flow (ϵ_3) (section CD) with an increasing deformation rate and ending in brittle or viscous failure. Generally, soil resistance in this stage is considered to be zero, which increases the bearing capacity as failure of the soil begins at some point N; thus, it is more correct to include section CN in the soil resistance.

The processes just described can be explained as follows [1]: Intermolecular bonds (cohesion forces) effecting the strength of frozen soil can be conveniently divided into three groups: (1) Intermolecular, cohesion itself; (2) structural cohesion, developed in geological formation of soils; and (3) cohesion due to ice cementation. As stated by N. A. Tsytoich, frozen soils are characterized by dynamic equilibrium between the liquid and solid phases of water. An external load causes concentration of stress at points of

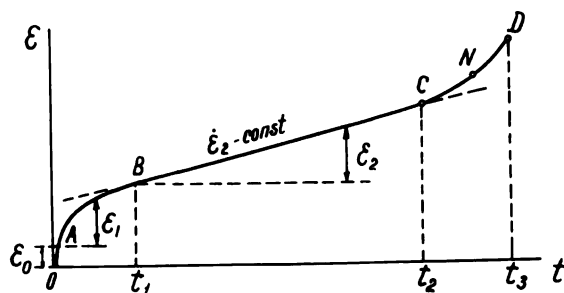
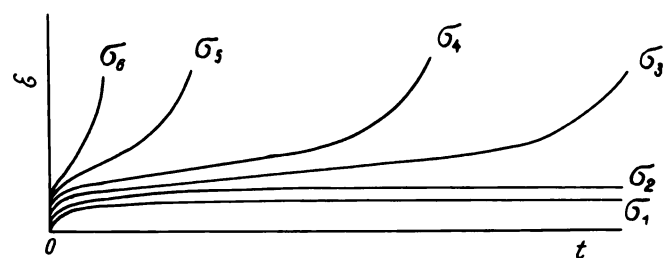

Fig. 1. Creep curves of frozen soil: top—group of curves for various loads; bottom—schematic creep curve

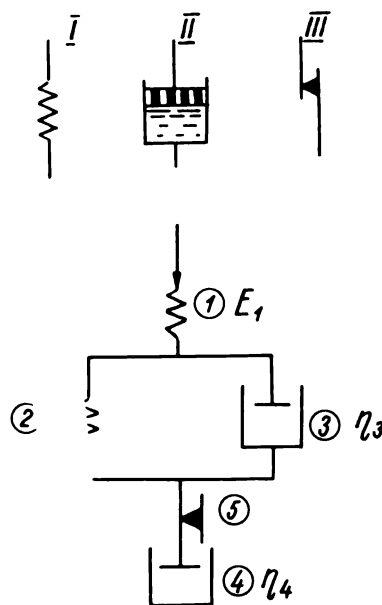

Fig. 2. Mechanical model of elasto-plasto-viscous body: top—I elastic, II viscous, III plastic elements; bottom—frozen soil model

contact, resulting in plastic flow and melting of ice. As a result of this, the dynamic equilibrium is disturbed, and pore water increased by melted ice migrates into a zone of lower stress, where it again freezes. Simultaneously, structural and ice-cementation bonds in the weaker places yield, and mineral particles slip. These processes take some time and are accompanied by reorientation of ice crystals, which tend to orient with their basal planes parallel to the slide direction, and by reorientation of mineral particles. This results in a reduction of the shearing resistance—i.e., weakening. This is simultaneously accompanied by denser packing of the mineral particles and a consequent increase in intermolecular bonds, by building up new ice-cementation bonds and elimination of the defects, i.e., by strengthening. If strengthening exceeds weakening, the process is damped, but if weakening overcomes strengthening, nondamped creep results.

Schematically, the deformation process can be expressed

$$\epsilon = \epsilon_0 + \epsilon(t) = \epsilon_0 + \epsilon_1 + \epsilon_2 + \epsilon_3 \quad (1)$$

where $\epsilon(t) = \epsilon_1 + \epsilon_2 + \epsilon_3$ is deformation developed with time (ϵ_3 is usually not taken into consideration).

Depending on the load, deformation ϵ_0 can be completely recoverable (instantaneously) or can include a residual non-recoverable part. Deformation ϵ_1 includes both recoverable and residual parts, a time-delayed restoration of deformation. Deformation ϵ_2 and ϵ_3 are completely residual.

The deformation process can be illustrated qualitatively by a mechanical model (Fig. 2), which shows elastic qualities by a spring (I), viscous qualities with a dashpot (II), and plastic qualities as a braking element $\sigma = \sigma_\infty$ (III). Various combinations of these elements illustrate different rheological models (Kelvin's, Maxwell's, Bingham's, etc.). The model for frozen soils is illustrated in the lower part of Fig. 2. ϵ_0 is illustrated by 1, ϵ_1 by 2 and 3, ϵ_2 by 4; deformation is possible only with stress $\sigma > \sigma_\infty$.

But the model fails to provide a quantitative description of the actual deformation process of frozen soils (1), as no model can incorporate all the peculiarities of frozen soils, more particularly, the nonlinearity of the process and change in soil properties during this process. Thus, it is better to use the phenomenological theories of creep for frozen soils, which permit introducing parameters derived from experiments into the equations, and which characterize the actual soil. The most suitable is the Volterra-Boltzmann theory of nonlinear hereditary creep which has been successfully used with frozen soils [1, 2].

DEFORMATION EQUATION

As deformation in any moment of time (t_1) consists of elastic deformation linearly connected with stress, and of plastic deformation, which is nonlinear (Fig. 3a), the relationship of stress to strain can be expressed

$$\epsilon_1 = \frac{\sigma}{E_1} + \left(\frac{\sigma}{A_1}\right)^{\frac{1}{m}} \quad (2)$$

where E_1 and A_1 are moduli of linear and of nonlinear deformation, respectively.

But the curve of the total deformation can, without great error, be described by a monomial equation. In general, this curve bends with $\sigma = \sigma_3$ (Fig. 3b) and is described by two different laws. To simplify calculations, one common law can be used for the whole stress range

$$\epsilon_1 = f(\sigma) \text{ or } \sigma = f(\epsilon_1) \quad (3)$$

As deformation increases with time, every t_1 is characterized by its own curve $\epsilon - \sigma$ (Fig. 3c). The upper curve ($t = 0$) corresponds to the usual momentary deformation, while the lower one ($t = \infty$) corresponds to deformation with continuous, unlimited duration of load (σ); each intermediate curve refers to deformation caused by a load during time (t_1).

Experiments show that all the curves are similar and can be described with a power law. So, (3) can be expressed as

$$\epsilon = \left(\frac{\sigma}{A(t)}\right)^{\frac{1}{m}} \text{ or } \sigma = A(t) \epsilon^m \quad (4)$$

where $A(t)$ is the modulus of total deformation, which changes its value with respect to duration of load application, beginning with initial A_0 to a minimum, ultimate, continuous A_∞ . The modulus also depends on the temperature of the frozen soil; and $m \leq 1$ is the strengthening factor, which can be taken as independent of time and temperature.

The stress-strain state, while changing with time, can be described by a rheological equation of state, including stress, strain, their rates, and time. In compliance with the theory of nonlinear hereditary creep, these equations can be expressed [2]

$$\varphi(\epsilon) = \sigma(t) + \int_0^t K(t-\nu)\sigma(\nu) d\nu \quad (5)$$

$$\sigma = \varphi[\epsilon(t)] - \int_0^t R(t-\nu)\varphi[\epsilon(\nu)] d\nu \quad (6)$$

With constant stress or constant strain, the equations can be simplified to

$$\varphi(\epsilon) = \sigma \left[1 + \int_0^t K(t) dt\right] \quad (7)$$

$$\sigma = \varphi(\epsilon) \left[1 - \int_0^t R(t) dt\right] \quad (8)$$

The first terms on the right describe the initial stress-strain state; the second, the change of this state with time. Function $\varphi(\epsilon)$ describes the relationship between stress and strain for the initial time ($t = 0$), which can be expressed by (4) with $A(t) = A_0$.

Function $K(t) = \frac{1}{\sigma} \frac{d}{dt} [\varphi(\epsilon)]$ is a creep function relating

strain rate with stress; function $R(t) = -\frac{1}{\varphi(\epsilon)} \frac{d\sigma}{dt}$ is a

relaxation function, representing the rate of stress-reduction required to maintain unit deformation. The relationship between function $K(t)$ and deformation modulus $[A(t)]$ in (4) can be expressed

$$A(t) = \frac{A_0}{1 + \int_0^t K(t) dt} \quad (9)$$

For the methods of determining $\varphi(\epsilon)$, $K(t)$, and $R(t)$ see [2]. Equations (5) and (6) are rather general and can describe any deformation law with respect to function $K(t)$. For frozen soils it can be assumed that

$$K(t) = \frac{a}{1 + bt} \text{ or } K(t) = \frac{a\lambda}{t^{1-\lambda}} \quad (10)$$

The first of the two expressions for $K(t)$ is investigated in [3]; the second expression was obtained by S. E. Gorodetskii [2].

By substituting these expressions into (7) and by considering the relationship in (4), the first expression for $K(t)$ yields the logarithmic equation of "secular deformation"

$$\epsilon^m = \frac{\sigma}{A_0} \left[1 + \frac{a}{b} \ln(1 + bt)\right] \quad (11)$$

and the second expression for $K(t)$ yields

$$\epsilon^m = \frac{\sigma}{A_0} [1 + at^\lambda] \quad (12)$$

Equations (11) and (12) can be obtained directly by substituting the $A(t)$ into (4) in compliance with (9).

The effect of temperature (θ) of a frozen soil is taken into account in the equation derived by S. E. Gorodetskii [2].

$$A_0 = w(\theta + 1)^k \quad (13)$$

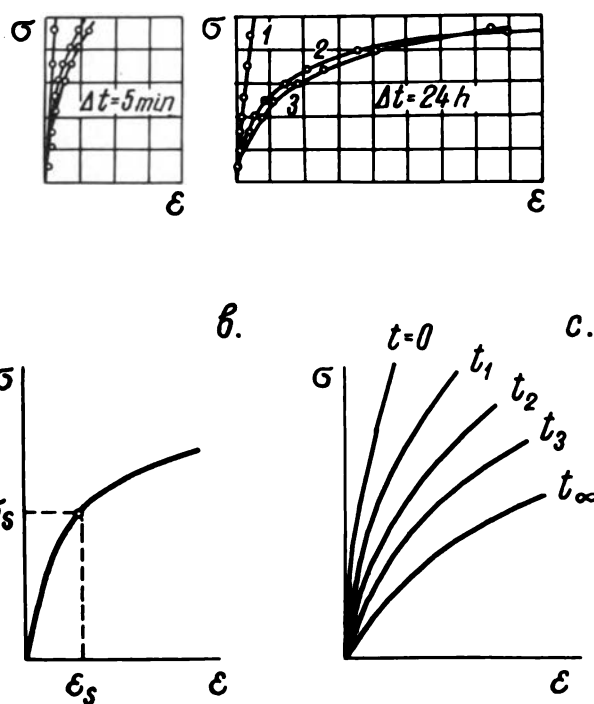

Fig. 3. Curves showing relation between stress (σ) and deformation (ϵ) of frozen soil: a—division of total deformation (3) into recoverable (1) and nonrecoverable (2) parts for different durations of load; b—schematic curve; c—group of curves for various durations

where θ is temperature (absolute value) and w and k are parameters.

If the initial deformation which is small for frozen soils, is neglected, (12) can be expressed

$$\epsilon^m = \frac{\sigma t^\lambda}{\omega(\theta + 1)^k} \quad (14)$$

where $\omega = \frac{w}{a}$

The values of the parameters of this equation for the case of unconfined compression for a frozen silty sand having a 26% moisture content are: $m = 0.27$; $\lambda = 0.1$; $k = 0.9$; and

$$\omega = \frac{9 \text{ kg (hr)}^\lambda}{\text{sq cm (}^\circ\text{C)}^k}$$

Equations (12) and (14) describe an unlimited increase of deformation but at a reducing rate. If the process continues with an essentially constant rate, use

$$\frac{d\epsilon}{dt} = \dot{\epsilon} = \zeta (\sigma - \sigma_\infty)^\mu \quad (15)$$

where $\mu \geq 1$ and ζ is the reciprocal of viscosity.

Equation (15) represents the process when flow with a noticeably constant rate begins only with a stress exceeding σ_∞ . But this statement and the idea of the limit of continuous strength itself (σ_∞) are conventional as they depend on the precision and duration of measurements. That is why in some cases the flow process is better described by

$$\epsilon = \zeta \sigma^\mu \quad (16)$$

Parameter μ in (15) and (16) does not depend on temperature, while parameter ζ is a temperature function that can be expressed by (13).

In some cases, deformation can be expressed by the sum of (11) or (12) and (15) or (16).

CONTINUOUS STRENGTH OF FROZEN SOILS

As is evident from testing a series of specimens of frozen soil with a different but constant stress for every specimen, the lower the stress, the longer the time required for failure (Fig. 1a). The curve illustrating continuous strength (Fig. 4) is obtained by plotting failure loads on the Y-axis and time on the X-axis. The curve shows the loss of strength with increase of load duration, which is the process of strength reduction. With compression, rupture itself is detected only in low moisture dense frozen soils. With ice-saturated soils, deformation has a plastic character and ends in the flattening of the specimen without destroying its continuity. The moment of rupture of a low-moisture dense frozen soil is clearly shown (point D, Fig. 1b), while the idea of strength of an ice-saturated soil may be merely conventional. But in all cases the deformation process inevitably results in a progressive flow stage. Thus, the conventional criterion of strength is considered to be some selected critical value of deformation, which initiates progressive flow; i.e., point C, Fig. 1b. This adds to the factor of safety in bearing capacity.

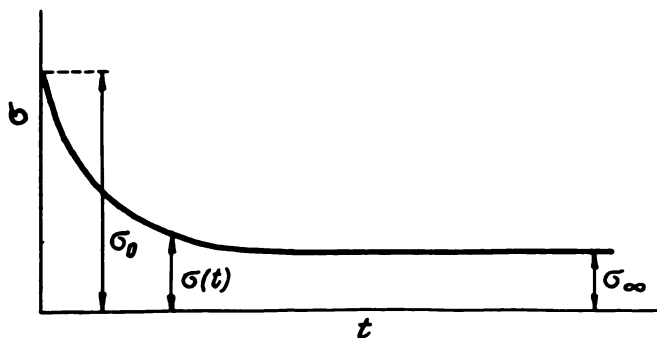

Fig. 4. Continuous strength curve

In Fig. 4 the intersection of the curve on the Y-axis illustrates the usual momentary failure stress (σ_0); the ordinate of any point, $\sigma(t)$, is considered the long term strength, i.e., the resistance to failure for a given load duration, while the asymptote to the curve is the ultimate continuous strength (σ_∞). If this limit is not exceeded, the specimen does not fail with any unlimited value of time.

The law of strength reduction is described with sufficient accuracy by

$$\sigma(t) = \frac{\beta}{\ln \frac{t+t^*}{B}} \approx \frac{\beta}{\ln \frac{t}{B}} \quad (17)$$

where β , B , and $t^* = B e^{\beta/\sigma_0}$ are parameters; σ_0 is the initial momentary strength. To simplify the equation t^* can be neglected.

Table I. Values of β and B in (17)

Soil	Temp. °C	Unconfined compression		Cohesion	
		β kg/sq cm	B min	β kg/sq cm	B min
Sandy loam, silty; moisture: 26%	- 5	253	2.69×10^{-2}	87	1.41×10^{-3}
	-10	418	2.49×10^{-2}	183	2.55×10^{-4}
	-20	698	2.22×10^{-2}	251	4.42×10^{-4}
Clay, compact; moisture: 20 to 24%	- 5	342	3.15×10^{-5}	115	4.15×10^{-4}
	-10	448	4.02×10^{-5}	156	3.05×10^{-3}
	-20	576	1.29×10^{-3}	276	1.02×10^{-3}

Equation (17) (with $t = \infty$) results in $\sigma_\infty = 0$, which is not consistent with the idea of continuous strength at some finite stress. That is why the idea is purely conventional. But in practice, after some long enough period of time, strength reduction is so insignificant and so slow that it can be neglected in engineering calculations. For calculations, σ_∞

can be obtained from (17) with $t = (50B^{0.05})^{1/1.05}$ years which corresponds conventionally to $(\sigma_\infty - \sigma_{50})/\sigma_{50} = 0.05$ where σ_∞ is a calculated value of σ and σ_{50} is the value of σ with $t = 50$ years; B is the parameter of (17) in years. The fact that the ultimate continuous strength is an actual value as a calculated characteristic was proved by tension tests when loads from 20 to 2 kg/sq cm caused failure of specimens, while a load of 1.8 kg/sq cm did not result in failure, though the test was continued for 6 years.

The maximum reduction of strength of frozen soils occurs during an initial, comparatively short period of time (several hours or days).

The relationship between continuous strength and temperature is expressed similarly to (13). Sometimes the linear relationship ($K \approx 1$) is true.

Table II gives characteristics of compressive, tensile, and shearing strength, cohesion and adfreeze of some frozen soils [1, 2]. The cohesion value is determined by pressing in a spherical indenter in accordance with the method devised by N. A. Tsytoich [6]; this method is similar to the Brinell test, but penetration is prolonged, so that it is accompanied by a reduction of the cohesive resistance. Adfreeze forces are determined by pulling out round wooden rods which have frozen into the ground; this value is relative, depending on the rod size.

COMPLEX STRESS CONDITIONS

The state of complex stress is described by the intensity of tangential stresses

$$\begin{aligned} T &= \sqrt{\frac{1}{6}[(\sigma_x - \sigma_y)^2 + (\sigma_y - \sigma_z)^2 + (\sigma_z - \sigma_x)^2] + \tau_{xy}^2 + \tau_{yz}^2 + \tau_{zx}^2} \\ &= \sqrt{\frac{3}{2}} \tau_n \end{aligned} \quad (18)$$

Table II. Data on conventional-momentary and ultimate-continuous strength of frozen soils

Soil	Mois- ture, %	Strength (kg/sq cm; at temp, °C)									
		-0.3°		-1.1°		-4.5°		-10°		-20°	
		M ^a	C ^b	M	C	M	C	M	C	M	C
Unconfined Compression											
Sandy loam, silty (Callovian)	26	43	14.8	70	20	128	34.5
Sandy loam, light	22	35	5.0
Clay, compact (Bat Baiossa)	22	28	12.5	39	16.5	66	24.3
Tension											
Sandy loam, light	31	20	1.8
Shear											
Clayey loam, light	32	4.7	0.7
Clay	32	4.6	1.1	18	6.8
Cohesion											
Sand, medium grained	25	17	1.87	19	2.2	20	3.7
Sandy loam, heavy, silty (Callovian)	26	20	3.7	30	7.2	43	10.1
Clayey loam, heavy	36	4.3	0.6	8.6	1.0	12	2.5
Clay, compact (Bat Baiossa)	22	20	4.6	29	6.8	47	11.5
Clay, varved	35	5.65	1.8	8.0	2.6	14.5	4.2
Sandy loam, heavy, silty	34	4.5	0.95	7.3	1.6	7.7	2.8
Adfreeze (soil with wood)											
Sandy loam,	35-	4.0	0.75
heavy, silty	42-	...	-1.0	11.5	2.6
Clayey loam, light	36	3.5	0.5
		-4.2	-0.7

^aMomentary
^bContinuous

by the intensity of the shearing deformation

$$\Gamma = \sqrt{\frac{2}{3} [(\epsilon_x - \epsilon_y)^2 + (\epsilon_y - \epsilon_z)^2 + (\epsilon_z - \epsilon_x)^2]} + \gamma_{xy}^2 + \gamma_{yz}^2 + \gamma_{zx}^2$$

$$= \sqrt{\frac{3}{2}} \gamma_n / \quad (19)$$

by the average normal (hydrostatic) stress

$$\bar{\sigma} = \frac{\sigma_x + \sigma_y + \sigma_z}{3} \quad (20)$$

and by the average linear deformation that equals one-third of the volumetric deformation

$$\bar{\epsilon} = \frac{\epsilon_x + \epsilon_y + \epsilon_z}{3} \quad (21)$$

where σ_x, γ_x and $\tau_{xy}, \gamma_{xy} \dots$ are normal and tangential stresses and deformations; τ_n and γ_n are octahedral stress and strain.

Solving creep problems consists in the compatible solution of the equilibrium equations, the equations of deformation continuity and of the rheological state, which describes the relationship between the components of stress and deformations (or of their rates) and time. These equations (Hencky) are

$$\epsilon_x - \bar{\epsilon} = \chi(\sigma_x - \bar{\sigma}), \quad \gamma_{xy} = 2\chi \tau_{xy} \quad (22)$$

where $\chi = \frac{\Gamma(\dot{\nu})}{2T(\dot{\nu})}$

Present creep and plasticity theories assume that the tangential stress (T) causes only shape change, which is independent of the hydrostatic pressure ($\bar{\sigma}$). This hydrostatic pressure ($\bar{\sigma}$) causes only volumetric change that is independent of T

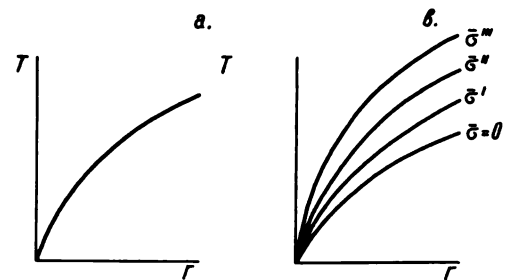

Fig. 5. Relationship between stress (T) and deformation (Γ): a—commonly used with plastic theory; b—effect of hydrostatic pressure

$$T = \varphi(\Gamma) \text{ and } \bar{\sigma} = \bar{\varphi}(\bar{\epsilon}) \quad (23)$$

The first equation shows that the curve of the relationship between T and Γ (Fig. 5a) is similar to that of σ and ϵ with a simple stress state; the curve can be obtained from the tests for unconfined compression or tension or for pure shear. Thus, the power equation follows [4]

$$T = \bar{A}(\dot{\nu}) \Gamma^m = \frac{-m+1}{2} A(\dot{\nu}) \Gamma^m \quad (24)$$

where $\bar{A}(\dot{\nu})$ is the deformation modulus for complex stress which equals the deformation modulus with pure shear. $A(\dot{\nu})$ is the deformation modulus with unconfined compression or tension.

Equation (24) can be obtained from (4)—taking into consideration that in unconfined compression, (18) and (19)

become: $T = \sigma/\sqrt{3}$ and $\Gamma = \epsilon/\sqrt{3}$ (with $\bar{\epsilon} = 0$). Deformation equations for complex stress conditions are similar to those used for the simple stress state; they can be obtained from the latter equations by substitution of T, Γ, \bar{A} for σ, ϵ, A . Thus, (5) and (6) become

$$\varphi(\Gamma) = T(t) + \int_0^t K(t-\nu) T(\nu) d\nu \quad (25)$$

$$T = \varphi[\Gamma(t)] - \int_0^t R(t-\nu) \varphi[\Gamma(\nu)] d\nu \quad (26)$$

where $\varphi(\Gamma) = \bar{A}_0 \Gamma^m$, $\bar{A}_0 = 3 \frac{m+1}{2} A_0$ and K and R have the same values as for simple stress.

The remaining equations will be transformed in a similar way. For instance, (14) will be

$$\Gamma^m = \frac{T(t)^\lambda}{\bar{\omega}(\theta+1)^k} \quad (27)$$

$$\text{where } \bar{\omega} = 3 \frac{m+1}{2} \omega$$

The same is true for (15) and (16), in which

$$\bar{\Gamma}, T, \bar{\zeta} = 3 \frac{\mu+1}{2} \zeta \text{ are substituted for } \epsilon, \sigma, \zeta.$$

The time effect in volumetric deformation is described with equations similar to (25) and (26), for example

$$\bar{\sigma} = \bar{\varphi}[\bar{\epsilon}(t)] - \int_0^t V(t-\nu) \bar{\varphi}[\bar{\epsilon}(\nu)] d\nu \quad (28)$$

When investigating plastic deformation, it is usually supposed that the material is incompressible, i.e., $\bar{\epsilon} = 0$. This assumption can be made for a frozen soil at a low temperature. Frozen soils at high temperatures are capable of being compressed and of developing a significant volumetric deformation [1, 5, 6], which should be considered, especially when designing foundations.

Function $V(t)$ in (28) is similar to function $R(t)$ of (26), but function $V(t)$ should be considered as being composed of two members $V(t) = V_1(t) + V_2(t)$, which reflects the peculiarities of the volumetric deformation process of soils. The first of these members describes deformation by consolidation, which is controlled by flow of water and which is connected with permeability. This deformation has a damped character and its rate depends upon the geometrical dimensions of the compressed soil mass (and on its boundary conditions), all this being described in function $V_1(t)$. Function $V_2(t)$ describes volumetric creep deformation, which as well as linear creep deformation does not depend upon geometrical dimensions and may be either damped or nondamped, depending on the stress magnitude. Let us note that function $\bar{\varphi}(\bar{\epsilon})$ may be different for the consolidation processes and for volumetric creep. The specific role of each process and of its laws is the object of further investigations.

The deformation equations above are to be substituted into (22), the equation of state.

All that has been said is true for a material equally resistant to compression and tension, not having internal friction—i.e., for frozen clay soils.

GENERALIZED CREEP THEORY TAKING HYDROSTATIC PRESSURE INTO ACCOUNT

The majority of frozen soils have different resistances to tension and compression and are characterized by internal friction. (Internal friction of frozen soils is a conventional conception and is to be considered as increase of shearing resistance under the effect of normal stress.)

For such bodies, a generalized creep theory with the effect of the hydrostatic pressure taken into account [2] has been developed. Final conclusions based on this theory are given.

As in triaxial compression tests on unfrozen soils (I. A. Botkin and others) and tests on frozen soils (E. P. Shusherina and the author) hydrostatic pressure ($\bar{\sigma}$) causes not only volumetric deformation ($\bar{\epsilon}$), but has significant effect on

shape deformations (Γ), while the intensity of the tangential stress (T) affects both volumetric and shape deformations. Evidently, testing for triaxial compression with different values of $\bar{\sigma}$ does not give a common curve $T-\Gamma$ (for given T_1) but a group of such curves, each of which corresponds to its own value of σ (Fig. 5c). Consequently, the general initial relationships (32) can be expressed $T = \varphi(\Gamma, \bar{\sigma})$ and $\bar{\sigma} = \bar{\varphi}(T, \Gamma)$.

As for previous cases, volumetric deformations should be considered only for soils at high temperatures.

On changing the curves $T-\Gamma$ (Fig. 5b) for different values of $\bar{\sigma}$ into a graph of relationship between T and σ for different Γ , a group of curves will be obtained, one of which (for the given value of Γ_1) is illustrated in Fig. 6a. The equation of these curves will be

$$T = \varphi_1(\Gamma) + \varphi_2(\Gamma) \Omega(\bar{\sigma}) \quad (29)$$

where

$$\varphi_1(\Gamma) = T_0 = \tau \text{ is pure shear; } \varphi_2(\Gamma) = \frac{T - T_0}{\Omega(\bar{\sigma})} \text{ represents the}$$

increase of shearing resistance due to $\bar{\sigma}$ (Fig. 6b); $\Omega(\bar{\sigma})$ is a function characterizing the effect of $\bar{\sigma}$.

Equation (29) is commonly expressed as an integral equation: its solution together with (26), the creep equation, describes the relationship of $T, \Gamma, \bar{\sigma}$, and t . A similar equation for volumetric deformation describes the relationship of $T, \bar{\epsilon}, \bar{\sigma}$, and t .

As these equations are rather complicated for practical use, they can be simplified, considering that:

1. The relationship of T and $\bar{\sigma}$ is linear (dotted line in Fig. 6a), i.e., $\Omega(\bar{\sigma}) = \bar{\sigma}$; and consequently, $\varphi_2(\Gamma) = \tan \Psi(\Gamma)$, where $\Psi(\Gamma) = T_0/H$, the angle of deviation on the octahedral plane.
2. Functions $\varphi_1(\Gamma)$ and $\varphi_2(\Gamma)$ at any time (t_1) are described by the power law (Fig. 6b)

$$\varphi_1(\Gamma) = \bar{A} \Gamma^m \text{ and } \varphi_2(\Gamma) = \bar{B} \Gamma^n \quad (30)$$

3. When under load, all the stress components change proportionally to one factor, the load value increasing slowly and gradually, which permits taking the time effect into account, considering parameters \bar{A} and \bar{B} to be functions of t (Fig. 6c).

Then (29) will be

$$T = T_0(\Gamma) + \bar{\sigma} \tan \Psi(\Gamma) = \bar{A}(t) \Gamma^m + \bar{\sigma} \bar{B}(t) \Gamma^n \quad (31)$$

The first term of this equation defines resistance to pure shear; the second, increase of this resistance due to $\bar{\sigma}$.

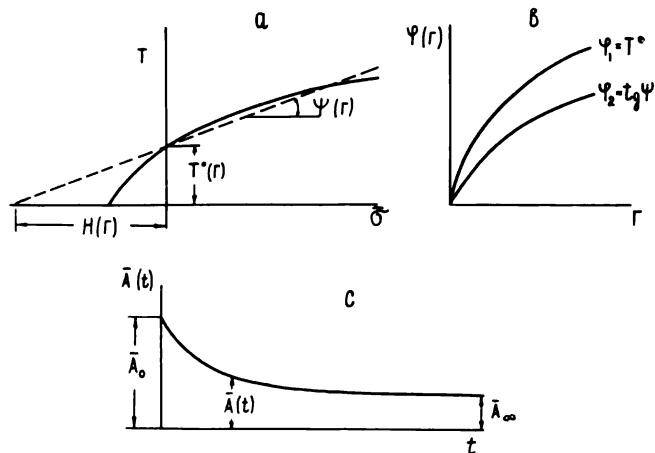

Fig. 6. Relationship between stress (T), deformation (Γ), and hydrostatic pressure ($\bar{\sigma}$): a—relationship between T and $\bar{\sigma}$ for given Γ ; b—form of functions $\varphi_1(\Gamma) = T_0$ and $\varphi_2(\Gamma) = \tan \Psi$ c—parameter $A(t)$ or $B(t)$ changes with time

Equation (31) is substituted into the equation of state (22) where function χ will be

$$\chi = \frac{\Gamma^{1-m}}{2[\bar{A}(t)\Gamma^{m-n} + \bar{B}(t)\bar{\sigma}]} \quad (32)$$

Parameters $\bar{A}(t)$, $\bar{B}(t)$, m , and n are obtained from the tri-axial compression tests or torsion and compression tests under creep conditions. Changes of $\bar{A}(t)$ in time and its relation to temperature (θ) of the frozen soil are defined by (9), (10), and (13). Parameter $\bar{B}(t)$ is also a function of t and θ , but to a lesser degree. As proved by the experiments for sand and sandy loam, this parameter does not depend either on t or on θ . Parameters m and n for all frozen soils do not depend on t and θ ; it is possible that for some soils $m \approx n$. In this case (31) and (32) are greatly simplified.

If deformation rate $\dot{\Gamma}$ is substituted in the above equations for deformation, the equations can be used for flow equations (15) and (16) too. In this case value T_∞ will equal $T_\infty = S + \bar{\sigma} \tan \Psi$, which is described in detail later.

STATE OF ULTIMATE STRESS

Problems of ultimate equilibrium are solved by solving the equilibrium equation and the equation of state of ultimate stress. For materials having creep properties, the time effect should be considered, because with continuous load application the resistance diminishes.

For frozen soils having equal resistance to compression and tension and without internal friction, the ultimate state is described by

$$T = S(t) \quad (33)$$

where $S(t) = \tau_s(t) = \sigma_s(t)/\sqrt{3}$ is ultimate resistance in pure shear and σ_s is ultimate resistance in compression or tension, time dependent.

The change of S with time is described by (17), if value $\bar{\beta} = (1/\sqrt{3})\beta$ is substituted for β .

For frozen soils having different resistances to compression and tension and having internal friction, ultimate equilibrium can be described by

$$T = S(t) + \bar{\sigma} \tan \Phi(t) \quad (34)$$

where $\Phi(t)$ is the angle of internal friction on the octahedral plane.

As the failure stress depends on the load duration, its ultimate straight line ($T - \bar{\sigma}$) (Fig. 7a) will correspond to each t value. The change in time of the intensity of failure stress is illustrated by a group of curves of continuous strength, each of which corresponds to a given $\bar{\sigma}$ value. With $\bar{\sigma} = 0$, the curve coincides with the curve of continuous strength in pure shear. Value S changes with time and temperature in accordance with (17) and (13). Value Φ depends less on these factors. For sand and sandy loam soils, this value depends neither on t nor on θ .

METHODS OF CALCULATION

Frozen soils used as foundation or construction materials should be considered with respect to continuous strength

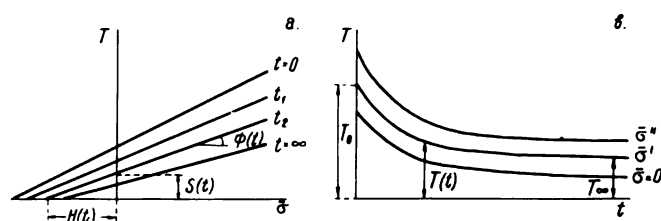

Fig. 7. Ultimate state of frozen soils: a—relationship between T and $\bar{\sigma}$ at different times; b—curves of continuous strength with different $\bar{\sigma}$

and creep [deformation].

The purpose of the first calculation is to determine the load under which the frozen soil in a given time will be in the state of ultimate equilibrium. This means that the relation between stress components is such that it results in a progressive flow (which causes rupture or loss of stability). The calculation is made according to the theory of ultimate equilibrium widely used in soil mechanics. The equation is of the ultimate stress state with consideration of the time factor. If the effect of transient loading, such as shock, wind, impact, etc., is required, the conventional-momentary values are used in calculations. If the effect of relative short-lived loads is investigated (for instance, when designing temporary supports of frozen soil, to be used for mining shafts, trenches, etc., with the help of artificial freezing), the values corresponding to the known load duration are taken for calculation. If the effect of the ultimate continuous load is considered (for instance, design of foundations), the ultimate continuous values are used. Based on these calculations, the ultimate load value is obtained into which a factor of safety is introduced.

Calculations for creep [deformation] consist of determining the stress with which deformation within the set load duration will not exceed the maximum value allowed for the construction. Calculations are made in accordance with creep theory. The basic equation is the rheological equation of state.

The calculations are simplified if deformation development and reduction of strength with time need not be determined, and the final values of deformation and strength within the set period (construction service life) are adequate. In this case the calculations for deformation are based on values \bar{A}_1 and \bar{B}_1 of (31) (if the effect of the hydrostatic pressure is not considered, $B = 0$) for the calculated period t_1 . The values \bar{A}_1 and \bar{B}_1 are determined directly from Fig. 6c (if $\bar{\sigma}$ is not taken into account in Fig. 5b), by the curve plotted for t_1 . These values of \bar{A}_1 and \bar{B}_1 are substituted in (32) for χ in (22), the equation of state.

For strength calculations, substitute finite values S_1 and Φ_1 corresponding to a given t_1 into the equation of ultimate equilibrium (33) or (34). These values are determined from Fig. 7a for the given value of t_1 .

Calculations for structural foundations in frozen soils and data on permissible pressure values are given [1, 5]; artificially frozen soils are also covered [2].

Here are three problems which the author considers worthy of discussion:

1. Validity and expedience of the ideas of the continuous strength limit and of the division of deformation into the damped and undamped types, remembering that these ideas are purely arbitrary.
2. Evaluation of the proposed equations of deformation (creep) and of strength reduction of frozen soils; then comparison of these equations with experimental data obtained by others.
3. Direction of further investigations in the rheology of frozen soils and ways of using the results of these investigations in the design and construction of foundations.

REFERENCES

[1] A. G. Brodskaja. Compression of Frozen Soils, Acad. Sci. USSR, Moscow, 1962.
 [2] S. S. Vyalov. Rheological Properties of Frozen Soils and Their Bearing Capacity, Acad. Sci. USSR, Moscow, 1959.
 [3] S. S. Vyalov, et al. Strength and Creep of Frozen Soils and Calculations in Ice-Soil Retaining Structures, ed. S. S. Vyalov, Acad. Sci. USSR, Moscow, 1963.
 [4] N. K. Pekarskaia. Resistance of Frozen Soils to Shear and the Influence of Their Structure, Acad. Sci. USSR, Moscow, 1963.
 [5] N. A. Tsyrovich. Bases and Foundations on Frozen Soils, Acad. Sci. USSR, Moscow, 1958.
 [6] S. S. Vyalov, A. M. Skibitskii. Proc. 4th and 5th Intl. Conf. Soil Mech. Found. Engr., Vol. 1, 1957 and 1961.
 [7] N. A. Tsyrovich. Ibid., 1957.

DISCUSSION—SESSION 6

O. B. ANDERSLAND—Physicomechanical Properties of Frozen Soil—My comments are directed toward the papers on creep of frozen soils and to the session subject.

The time-dependent plastic deformation of frozen soil under constant deviator stress is known as creep. Inspection of a typical isothermal constant deviator stress creep curve for a frozen clay (Fig. 1A) reveals some of the complexities of creep. After an initial strain, ϵ_1 (obtained immediately upon loading), the creep rate decreases over the primary stage of creep, remains almost constant over the secondary stage, and increases over the tertiary stage until terminated by rupture. For very small deviator stresses, the tertiary stage may not be reached. Sanger and Kaplar [1] presents curves on several soils obtained for temperatures down to 20°F and deviator stresses of 20, 50, and 80 psi.

If the soil structure had remained constant during the creep test, the creep rate would have remained constant and the deformation-time curve would have been a straight line. The observed changes in creep rate (Fig. 1B) under a constant deviator stress and temperature must arise from changes in the frozen soil structure resulting from the creep process. These changes in structure complicate the creep process and hinder direct experimental analyses of conventional creep curves. Simple theoretical approaches to the solution of the creep problem are ineffective. Special experimental techniques must be employed to measure the effects of temperature or stress on the creep rate under constant conditions of structure. In addition, these same techniques must be used to evaluate the influence of different structures on the stress and temperature laws for creep.

EFFECT OF TEMPERATURE ON CREEP RATE

Several papers [1, 2, 3] show a need for more information on the influence of temperature on creep rate. Dorn [4] states that creep can only occur as a result of some thermally activated deformation mechanism. If thermal activation did not occur, the plastic strain obtained at a given temperature would be dependent only on the applied stress. The time-dependent creep phenomena in frozen soils must therefore be stimulated by continued thermal excitation of deformation mechanisms.

An hypothesis which relates the time-dependent creep phenomenon of frozen soil to temperature and other variables might be based on the theory of rate processes [5]. This theory has met with considerable success in the study of many different materials such as unfrozen soils, ceramics,

metals, asphalt, and concrete [6, 7, 8]. A general expression for creep rate of frozen soils might take the form

$$\dot{\epsilon} = A(\sigma, T, st) \exp \frac{-\Delta E(\sigma, T, st)}{RT} \exp B(T, st) \sigma_d \quad (1)$$

where $\dot{\epsilon}$ or $d\epsilon/dT$ is creep rate; A is a parameter which may depend on stress, temperature, and soil structure; B is a parameter which may depend on temperature and soil structure; σ is stress; σ_d is deviator stress; T is absolute temperature; st is frozen soil structure; ΔE is activation energy, i. e., energy which must be supplied by thermal fluctuations or external forces for flow to occur; and R is the gas constant.

Secondary creep rates at different temperatures and at a constant stress can be used to determine an observed activation energy if it is assumed that soil structure, parameters A and B, and the activation energy are relatively insensitive to small temperature changes. Also, one must assume that structural changes caused by sample deformation are insignificant. Then, taking the logarithm of (1) we obtain

$$\ln \dot{\epsilon} = \text{const.} - \frac{\Delta E}{RT} + \text{const.} \quad (2)$$

It follows that a plot of $\ln \dot{\epsilon}$ versus $1/T$ should be a straight line with slope equal to $-\Delta E/R$ from which ΔE may be determined directly.

A simple technique has been used on metals to determine the effect of temperature alone on the creep rate during a constant stress creep test [9]. After an appropriate amount of creep at a given stress, the temperature is changed quickly from T_1 to a slightly different temperature, T_2 . The abrupt change in temperature will cause a change in the creep rate. The stress is the same just before and after the change in temperature. If the structure is assumed to be identical and parameters A and B and the activation energy to be constant just preceding and immediately following the change in temperature, the change in creep rate must be due to the temperature change. For a single thermally activated process, the creep rates $\dot{\epsilon}_1$ and $\dot{\epsilon}_2$ just before and immediately following the abrupt change in temperature from T_1 to T_2 are related by

$$\dot{\epsilon}_1 \exp \frac{\Delta E}{RT_1} = \dot{\epsilon}_2 \exp \frac{\Delta E}{RT_2} \quad (3)$$

Rewriting (3)

$$\Delta E = \frac{R \ln (\dot{\epsilon}_1 / \dot{\epsilon}_2)}{\left(\frac{1}{T_2} - \frac{1}{T_1} \right)} \quad (4)$$

from which the observed activation energy can be obtained.

Although the effect of temperature alone on the creep rate may be isolated by this technique on metals, the observed activation energies obtained by application of (4) to frozen soils may be fictitious. If the different deformation mechanisms in frozen soil depend on one another so that none of them can occur without the others going on simultaneously, then the slowest one (usually with the highest activation energy) will be rate controlling. If the mechanisms are independent and each of them can individually produce deformation, then the fastest one (usually with the smallest activation energy) will be rate controlling [10].

EFFECT OF STRESS ON CREEP RATE

For very low stresses the effect of stress on creep rate of frozen soils is small and often neglected. Increase in stress leads to creep rate becoming more stress-dependent [1].

An evaluation of the creep rate dependence on deviator stress is usually attempted by noting the effect of stress on the secondary creep rate for tests conducted at a given temperature. If the structures that are generated during creep were independent of the deviator stress, the results obtained

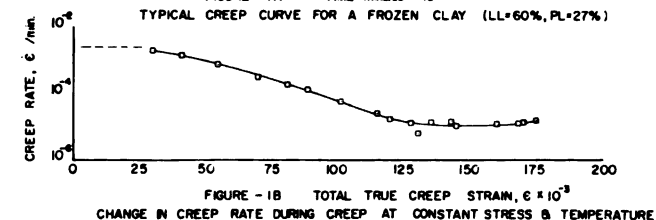
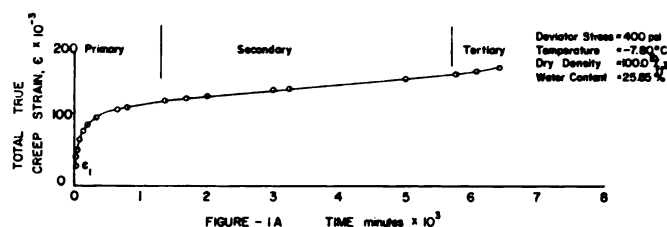

by this technique would be acceptable. No tests of the validity of this simplifying qualification are available for frozen soils.

A technique somewhat analogous to one for determining the effect of temperature on creep rate has been used on metals for obtaining the effect of stress on creep rate for a given structure [7]. It consists of precreeping a series of duplicate specimens under a given stress and temperature to a prescribed strain, then the stress is reduced abruptly to a different value for each specimen of the series. Since each specimen will have experienced identical creep histories, their structures should be the same just preceding the abrupt decrease in stress. Therefore, the new creep rate, obtained immediately following the abrupt decrease in stress, should reflect only the influence of stress on creep rate.

With all the variables in (1) held constant except deviator stress, the equation may be rewritten as

$$\dot{\epsilon} = \text{const} (\exp B \sigma_d) \quad (5)$$

Taking logarithms of both sides of (5) gives

$$\ln \dot{\epsilon} = \ln \text{const} + B \sigma_d \quad (6)$$

Thus, under the conditions of constant temperature and structure, the logarithm of creep rate should be a linear function of the deviator stress.

Mitchell and Campanella [11], using a different technique, have shown that the logarithm of strain rate is a linear function of the deviator stress for unfrozen illite and San Francisco Bay mud under conditions of constant temperature, effective stress, and structure. They obtained strain versus time data for a series of load increments from which strain rates could be determined. The logarithm of strain rate plotted against deviator stresses gave the straight line relationship.

FROZEN SOIL STRUCTURE AND CREEP MECHANISMS

Structure of frozen soil includes the composition, geometrical arrangement, and packing of soil particles, together with the solid, liquid, and gaseous phases of soil moisture. Mitchell [6] uses the number of interparticle contacts per unit area of cross section as indicative of a structure factor. Electrical repulsive and attractive forces acting between soil particles must influence creep behavior. Properties of the liquid water adjacent to soil particles influence the over-all behavior of the soil mass.

Little information is available on the mechanisms retarding or contributing to creep deformation. Resistance to displacement of two randomly oriented particles in contact with each other is derived from three sources: (1) A frictional resistance generated by normal force transmitted across the interparticle contact, (2) a force required to break interparticle bonds (cohesion) at points of contact between particles, and (3) the effort that must be expended to permit dilation. To cause displacement, either through sliding of the contact or bond rupture, energy must be supplied for particles to overcome potential energy barriers. Thermal energy contained in the soil mass and external forces are available as a source for energy necessary to activate bond rupture. Creep deformation may be the result of activation and subsequent failure at a contact as the result of the acquisition of sufficient energy. Primary creep might be characterized by bond rupture occurring at a decreasing rate, and secondary creep by bond rupture occurring at a constant rate. Tertiary creep could involve movement of soil particles to new positions of lower equilibrium energy. More research is needed before we can fully explain creep phenomenon in frozen soils.

REFERENCES

- [1] F. J. Sanger, C. W. Kaplar. "Plastic Deformation of Frozen Soils," in this volume.
- [2] N. A. Tsyvovich. "The Instability of the Mechanical Properties of Frozen Grounds," *ibid.*
- [3] S. S. Vialov. "Rheology of Frozen Grounds," *ibid.*
- [4] J. E. Dorn. "Progress in Understanding High-Temperature

Creep," H. W. Gillett Memorial Lecture, Am. Soc. Testing Materials, 1962.

[5] S. Glasstone, K. Laidler, H. Eyring. The Theory of Rate Processes, McGraw-Hill, New York, 1941.

[6] J. K. Mitchell. "Shearing Resistance of Soils as a Rate Process," Proc. Am. Soc. Civil Engrs., Vol. 90, No. SM1, Jan. 1964.

[7] I. Finnie, W. R. Heller. Creep of Engineering Materials, McGraw-Hill, 1959.

[8] M. Herrin, G. Jones. "Behaviour of Bituminous Materials from the Viewpoint of Absolute Rate Theory," Proc. Assoc. Asphalt Paving Technologists, Feb. 1963.

[9] J. E. Dorn. "The Spectrum of Activation Energies for Creep," Creep and Recovery, Am. Soc. Metals, Cleveland, Ohio, 1957.

[10] Hans Conrad. "Experimental Evaluation of Creep and Stress Rupture," Mechanical Behavior of Materials at Elevated Temperatures, McGraw-Hill, 1961, p. 149.

[11] J. K. Mitchell, R. G. Campanella. "Creep Studies on Saturated Clays," ASTM Symp. Laboratory Shear Testing of Soils, Ottawa, Canada, Sept. 1963.

DISCUSSIONS

(A) A. ASSUR—Creep of Frozen Soils—One of the most prominent characteristics of frozen soil is its creep under stress, caused primarily by its ice content. The need for engineering information has precipitated a number of studies in the past. Frequently empirical expressions have been used to express the intensity of creep deformation as a function of temperature and stress. I would like to voice my concern, however, about some of the relations proposed at this conference. As a matter of principle, certain theoretical considerations should be given even to empirical or computational equations.

Sanger and Kaplar propose

$$\dot{\epsilon} = 80 \times 10^{-6} \sinh b \theta^{-1} \quad (A.1)$$

for the minimum creep rate per hour with

$$b = 1.45 \exp(0.029 \sigma) \quad (A.2)$$

This is a very complicated expression which is not the usual hyperbolic sine relation for minimum creep rate. It is a relation of the type

$$\dot{\epsilon} = a \left(e^{be/\theta} \frac{\sigma/\sigma_0}{\theta} - e^{-be/\theta} \frac{\sigma/\sigma_0}{\theta} \right) \quad (A.3)$$

which is a very inconvenient expression with an exponential forming the power of two other exponentials. An equation which, according to the authors, applies within the "boundary conditions" (sic) or limits of the tests should be constructed in much simpler form. If a more complicated equation is used, it should be meaningful for simple boundary conditions so that the limited test data can be expanded and extrapolated to meaningful results rather than be misleading. For example, at 32°F, the melting point of ordinary ice, the soil should still behave as an engineering material with a certain finite creep rate. Equation (A.1), however, gives $\dot{\epsilon} = \infty$ for $\theta = 32^\circ\text{F}$ although this temperature is included in the test material.

A meaningful creep equation should give $\dot{\epsilon} = 0$ for $\sigma = 0$. Equation (1), however, gives a finite creep rate for zero stress at each temperature since $b = 1.45$ for $\sigma = 0$, except for 32°F when the creep rate becomes infinite for zero stress—which, of course, is not possible.

It is interesting to note that Vialov proposes equations which are simpler to use and exhibit none of the deficiencies of (A.1). By considering Vialov's (14) and (16)

$$\dot{\epsilon} = \text{const} \frac{\sigma^{1/m}}{(\theta + 1)^{k/m}} \quad (A.4)$$

for the creep rate at a given time. This equation will give a

finite creep rate for the freezing temperature θ (θ in $^{\circ}\text{C}$) and will always correctly extrapolate to zero creep for zero stress. It will not give an infinite creep rate for zero stress at the melting point, as (A.1) does.

Equation (A.4), however, exhibits other principal and dimensional difficulties. It will not extrapolate to a linear relation between $\dot{\epsilon}$ and σ for small σ , as it is observed and required for Newtonian viscosity. For dimensional correctness the denominator of (A.4) should be written either as

$$(\theta + \theta_0)^{k/m} \text{ or } (\theta/\theta_0 + 1)^{k/m} \text{ introducing really a fourth}$$

constant. The power k/m would indicate that the temperature effect would depend upon the power $1/m \geq 1$ for the stress—which is itself stress-dependent according to observations. The real difficulty, however, lies in the fact that the constant of (A.4) has no definite dimension, since its dimension will depend upon k and m which are material constants and stress-dependent. A true physical constant should change its value but not its dimension, depending on the material and its properties.

We come to the conclusion that much further thought should be devoted to the proper choice of creep equations. Also, we should consider that there is a continuous transition between frozen and unfrozen soil, depending on the unfrozen water content. This general transition should be properly reflected in future theoretical work as well as in equations describing experimental results.

(B) F. J. SANGER—Physicomechanical Properties—These comments are by an engineer more interested in the use of frozen soils in construction than in theories.

The moderator has classified the papers under three headings. They may also be divided into two groups: (1) Test data for practical engineering application, showing frozen soil behavior under environmental changes of temperature and stress, and (2) studies of rheological processes for the formulation of theories for someone else to apply (the more difficult job).

Kersten's paper presents his well-known curves of thermal conductivity that have been so valuable for many years—his original report is a classic—plus some analysis and recent references. The most recent Russian tables (1961) of conductivity and heat capacity are similarly based on two soil classes. I drew curves similar to Kersten's and found excellent agreement. CRREL uses the Kersten curves for nearly all computations involving heat conduction in soils.

Kaplar's report on the study of dynamic moduli, although also performed a few years ago, should be better known. I used his data to evaluate the spring constant for checking the behavior of large footings under dynamic loading on permafrost. Such experiments, however, need amplification by studies on the damping characteristics of frozen soils. These studies are now in progress at CRREL, but by techniques based on longitudinal and torsional forced vibrations in triaxial conditions. Complex moduli and an angle of lag based on the visco-elastic theory are used in analysis, but no particular rheological model has yet been devised.

Aitken's important work on the effect of surcharge in reducing frost-heave under pavements is based on theory, observed laboratory effects, and small-scale tests at airfields. CRREL is studying the effects on a large scale at the Alaskan Field Station, Fairbanks. Results are already valuable; but some aspects, notably edge effects, have been difficult to analyze; and fieldwork is continuing. These tests will undoubtedly improve the precision of engineering design very soon. It is one thing to know an effect exists; another, to transfer the effect to a design that, at best, is empirical and costly. Analysis of heave observations on airfield pavements shows that heave is from 5 to 15% of the frost penetration into a frost-susceptible subgrade, with about 10% as a common ratio. For this reason I analyzed Aitken's data and arrived at the curves of the figure shown (Fig. B.1). Future tests will aid in checking these preliminary curves.

However, they apply only to Fairbanks' test conditions, of which depth to ground water is important, since observation and theory show that energy from the freezing of water must create a moisture gradient as well as overcome resistance to heave.

Yong, with many years of laboratory experience in the rheology of frozen soils, is observing effects with carefully planned experiments, but faces a complex problem in sorting the many interconnected parameters to establish a satisfactory theory of frozen soil rheology. Some test conditions, such as remolded soils and very complex stress patterns, will be particularly difficult to interpret and apply to engineering.

Sanger's report on CRREL laboratory studies directed by Kaplar merely presents data showing the behavior of a wide range of natural soils (which are well described) in unconfined compression at steady load and temperature. These preliminary studies facilitated the planning of more precise investigations, now under way at CRREL. The paper gives numbers that I have used in engineering design, but adds little to theoretical knowledge. The data indicate that no simple equation covers all possibilities and that equations must be developed for estimating deformations that are valid only within specified limits. Using a separate time function seems more promising than using strain rate. Careful sample preparation and full description of specimens and test conditions are important. Investigators in frozen soil rheology do not always present this vital information.

Tsytoich presents the development of his early work on the dependence of mechanical properties on several factors, particularly stress. This is the most difficult effect to allow for in engineering, even by empirical methods. Recent developments based on studies in his laboratory show how really difficult it is to predict thaw consolidation with precision. A design method based on equivalent thermal diffusivity is difficult to apply, since it involves the assumption of the temperature regime with which to start. I have used it only for comparatively simple problems but agree that it is a valuable technique in the hands of an experienced engineer.

The instability of mechanical properties points up to the important truth in frozen ground engineering, that thermal and rheological computations cannot be separated owing to their close interconnection.

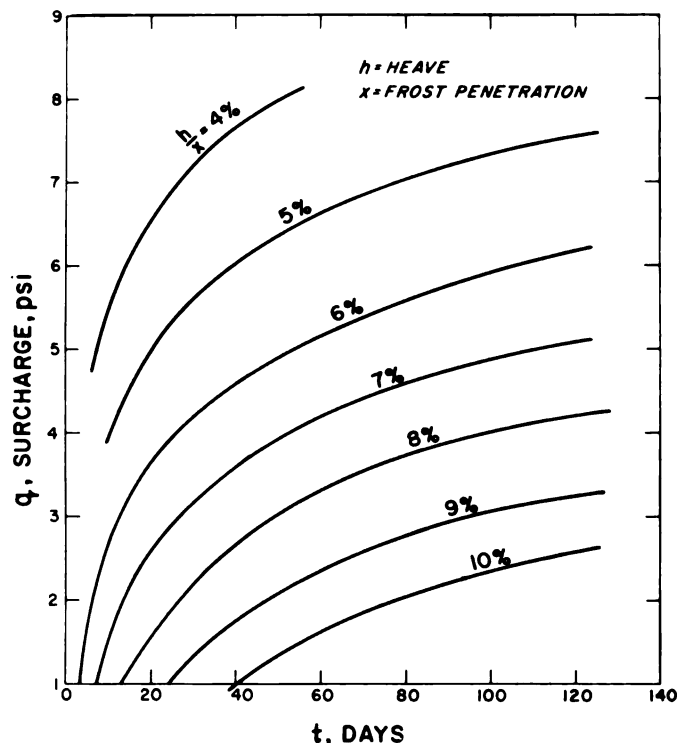

Fig. B.1. Ratio of heave to frost penetration with time, surcharge and heave of pavements

works available in English. The equation he has adopted, linking load and duration of application to cause failure by plastic flow, is very convenient for engineering design despite theoretical drawbacks. Vialov, Tsytoovich, Khakimov, and others have been using the formula successfully for more than six years. I have used it for some time in the design of artificially frozen ice-soil cofferdams, the problem Vialov started out to solve less than ten years ago. Laboratory creep tests on undisturbed samples give pairs of values for stress and time to failure, but computing the constants B and β is slow, and errors are easily made. Following Vialov by plotting points of the reciprocal of stress on a base of the logarithm of time, I have always been able to draw good straight lines from which to read off stress values for two convenient times. My nomogram (Fig. B.2) is then used to determine the ultimate stress for the life of the structure, usually less than one year. The values thus obtained for several temperatures provide, with a safety factor, useful design figures. The nomogram is

only as good as the basic equation, which is the best we have at present.

CURRENT PROGRESS IN CREEP OF FROZEN SOILS

Design using only cohesion based on unconfined compression tests is simplified but not economical, especially at high pressures; so the great value of the normal stress in increasing shear resistance, as discussed by Vialov, becomes important. Unfortunately, no really good techniques or test apparatus have been perfected as yet. A combination of simple tension, simple compression, and, possibly, various cohesion tests, has many drawbacks. Tension, compression and a pure shear test using a hollow cylindrical specimen is possible but difficult. The triaxial compression creep test is probably ideal and Vialov once worked on this, but I have not seen his results. CRREL is now working on triaxial creep tests down to about 0°F; below this temperature, design of the

$$S_t = \frac{\beta}{\lg\left(\frac{t}{B}\right)}$$

S_t = Stress to cause failure in time (t) hours
 β and B Soil constants. (temperature-dependent)

For time scales other than those given:
 tan α , where α is the angle between the scale and the horizontal = $\frac{2}{5} \left(\frac{\beta \cdot \lg t}{\lg t} \right)$

EXAMPLE $S_1 = 2800$ psi (a)
 $S_{10} = 1900$ (b)

Required: S at 3 months
 Join ab and produce to 3 mo. scale
 S = 1050 psi

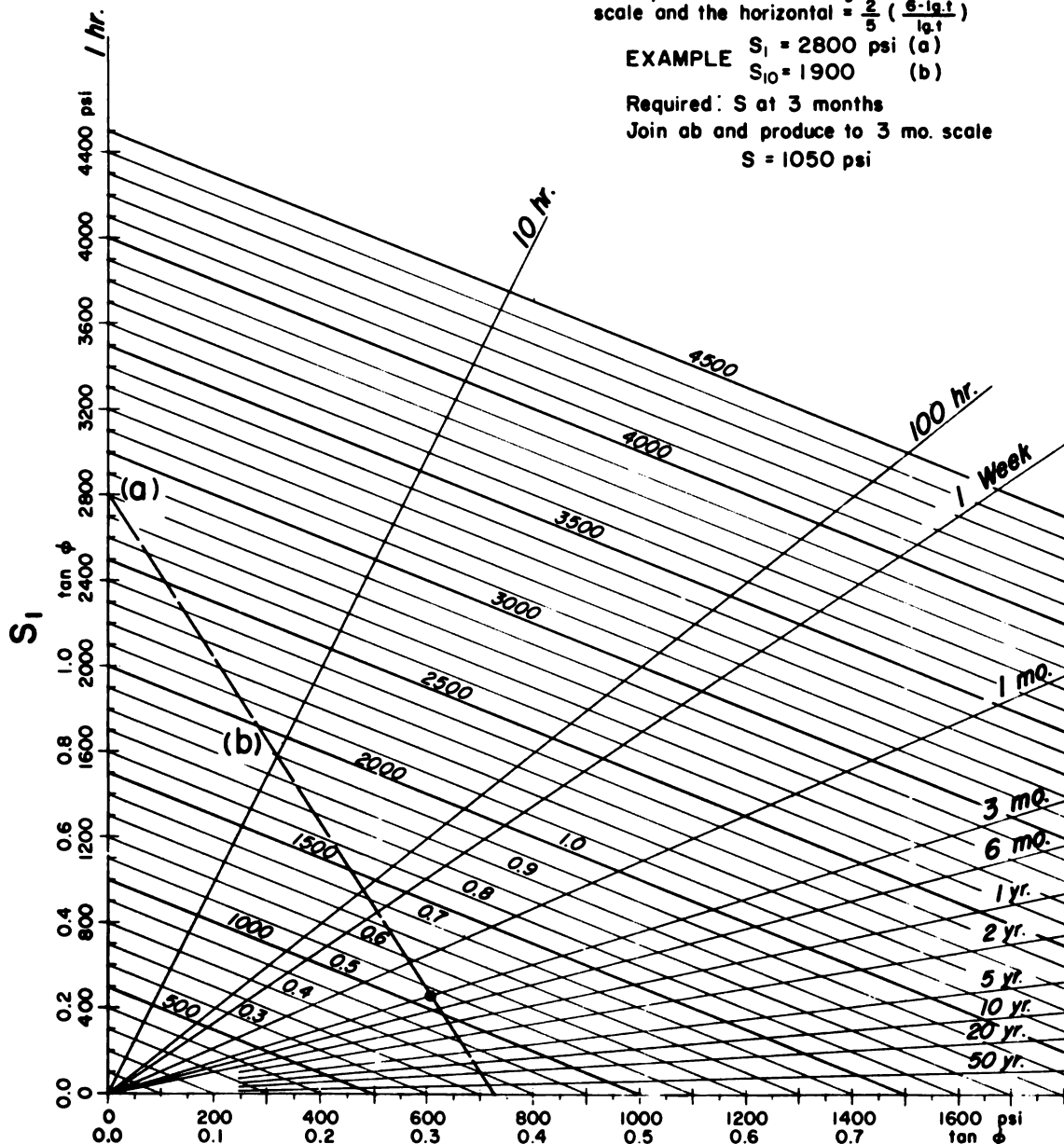

Fig. B.2. Relation between stress and time to failure in creep

In the short time at his disposal, Vialov outlined results of his many years of pioneer work in the rheology of frozen soils. Because of their importance, CRREL is making his two main apparatus becomes quite a problem, but to -40°F seems attainable. In the past two years considerable interest has been aroused in the storage of liquefied natural gas at about -260°F in large open pits excavated at ground surface and then roofed over. As a result some private laboratories have obtained interesting data on soil properties at cryogenic temperatures.

Here are some properties for silts and clays in the temperature range from 14° to -320°F : Thermal conductivity about doubles in magnitude as temperature falls. Specific heat falls sharply with temperature. Thermal diffusivity rises about 10 times with falling temperatures. Unconfined compressive strength rises about 25 times as the temperature falls to the liquid nitrogen level. Young's modulus increases more than 100 times as the temperature falls. Strain at failure falls rapidly with temperature; e. g., from about 20% to less than 1%. Coefficient of thermal contraction for natural soils does not vary much as the temperature falls.

Research Problems

Of many challenging questions here are a few to provide ideas:

1. Do all soils pass into the third stage of creep at some finite time depending upon the usual soil parameters plus stress and temperature?
2. What is the best way to obtain the Mohr envelopes for a frozen soil which creeps? Until we have these envelopes it is necessary to estimate $\phi(t)$, a time-dependent "friction" angle, if the full shear strength is to be used in design. This is

undesirable, so ϕ is nearly always neglected.

3. Is it possible to find equations for creep deformation and strength that can be used in engineering design and at the same time satisfy theoreticians?

Vialov's formula $\sigma = \beta / \ln(t/B)$ fits all experimental data I have analyzed so far, and at least for short periods of time is satisfactory in engineering design, but doubt exists when design numbers are obtained by extrapolation.

4. For given soil at constant temperature, does the final stage of creep occur at a constant strain? Evidence contradicts it so far, but some investigators apparently think that a limiting strain controls the onset of failure. This harks back to early hypotheses regarding failure of solid bodies under stress.

5. The Tsytovich ball penetrometer test for cohesion is somewhat controversial, possibly because of known drawbacks in the Brinell test for metals and doubts regarding the Ishlinskii theory. But the test is attractive and practical and should be thoroughly investigated to clear up doubts. In the recent edition of his book, Mekhanika Gruntov, Tsytovich also shows an interesting setup for using large ball penetrometers (50 cm in diameter) for design of foundations on unfrozen cohesive soils, indicating his confidence in the principle.

6. Aside from creep phenomena, research into the response of frozen soil to dynamic loading has great potential, such as: (a) Wave propagation in frozen soils, and (b) relationship between time to failure in suddenly applied increasing load and ultimate resistance to failure. In all frozen soils tested so far, resistance increases as time falls; but the reverse occurs in fresh water ice, and conceivably, at high ice concentrations, ultimate strength may not vary much as the rate of load increases. This should be investigated.

SESSION VII EXPLORATION AND SITE SELECTION

PHOTOINTERPRETATION IN THE ARCTIC AND SUB-ARCTIC

R. E. FROST, J. H. McLERRAN, and R. D. LEIGHTY, U.S. Army Cold Regions Research and Engineering Laboratory

Successful use by engineers of remote and often inaccessible areas is contingent on knowing the identity, physical properties, and distribution of soils and rocks and their behavior when disturbed.

In much of the Arctic and sub-Arctic, problems facing the engineer are greatly compounded because of the interplay of certain of the environmental stresses which have been responsible for severe seasonal frost activity in the surface layers and the presence of permanently frozen materials below the surface.

Thus, the poor soil areas can be eliminated almost entirely by study of photos and the field study can be concentrated on those areas best suited to construction or where special design features can be incorporated if a structure must be sited in an area of relatively bad soils.

Research in the laboratory and in the field conducted by Purdue University between 1945 and 1950 resulted in development of a technique for obtaining information about the identity and condition of frozen and unfrozen soils and rocks and established the value of airphotos in arctic and subarctic engineering. Many large installations constructed in northern lands owe part of the success of their performance to the successful use of airphotos to obtain engineering information. Much research has been done to improve photoanalysis methods, and much research is underway to determine best film, filter, scale, time of year, etc. New sensors, automation, and computer-oriented surveys contribute to new analytical methods.

ARCTIC TERRAIN ANALYSIS

Study of an area consists of three major steps: (a) Critical analysis of a region by emphasizing interplay of environmental stresses responsible for origin, composition, configuration, and condition; (b) conducting very detailed study of minute surface features of an area—the component parts of a surface, often called pattern elements, and (c) summation and verification of findings.

The degree of agreement between regional and local aspects must be determined so that predictions can be made concerning the characteristics of the area. After this the analyst has data which permits interpretation of the results within the framework of specific job requirements—whether for engineering, agriculture, economic development or some other important use.

The following basic principles are necessary for successful analysis of airphotos:

Airphotos record landscape patterns which shows the results of the relation between origin, composition, dynamic factors of physical development, and land use.

Airphoto patterns are repetitive and the information content can be extended from area to area only if the origin, composition, and dynamic landscape development are repetitive.

The elements of the natural landscape pattern are landform, drainage, erosion, tones, vegetation, land use, and features indigenous to the area.

The elements of the pattern of cultural development of the landscape are related to such basic urban or rural functions, or both, as residential, industrial, governmental, institutional, recreational, municipal services and facilities, and

the transportation-communication net which binds them together.

Photoanalysis and interpretation of natural landscape patterns presuppose use of basic principles of the earth sciences so that full consideration can be given to the relation between origin, composition, and dynamic landscape development.

Photoanalysis and interpretation of cultural development of the landscape must consider the degree of terrain alteration or adaptation to suit specific needs as may be influenced by such factors as tradition, historical accident, economics, or environment.

Regional Analysis

Regions can be studied successfully through small-scale areal photos, assembled either in mosaic or in photo-index form. Scales varying between 1 to 40,000 and about 1 to 100,000 may be used, perhaps, for all but the most complex areas. Defining major patterns that characterize the region of interest (Figs. 1 and 2) reveal location, economic pursuit, physical makeup, origin, and climate. Thus, regional analysis appraises geography, physiography, geology, and climate.

Study of the geography includes: Area location, size, shape, and boundary conditions; spatial relationships between major features, and development of transportation to and within the area. Significantly, this study has stimulated an initial opinion on the relation between man and his environment from knowledge of land use within each major pattern.

The next step is the determination of the physical makeup of the landscape by study of physiographic indicators. Form character of gross topography and spatial relationships between the smaller physical units are analyzed. Major forms are classified into mountains, hills, plains, basins, and escarpments.

Obviously, topographic indicators are many and varied, but identification is simple for sunlight and shadow, drainage, vegetation, degree of adaptation to the terrain by land-use practices (field shapes and transportation net), and timber lines.

Once the physical makeup is established, indicators of origin and landscape development must be considered. In all but the most complex areas, it is not too difficult to determine origin and trace the sequence of events responsible for present composition and form. From study of small-scale photos, determination of the general geology of an area is greatly simplified. The consolidated deposits are residual to the area (called bedrock—igneous, sedimentary, and metamorphic) or transported by wind, water, ice, and gravity. Indicators are many and varied: Some are directly observable; others, subtle and found only under very close study, and some are determined solely through inference and reason.

Another phase in regional analysis is defining and evaluating the climate. Indicators place the environment in one of these broad climatic categories: Arid, semiarid, subhumid, humid, tropical, arctic, or polar. The choice is made by detailed study of two natural indicators (vegetation and erosion) and one man-made indicator (land-use practice).

The final phase in regional analysis is summation of data. It is now possible to form opinions concerning physical makeup, broad composition types, origin of deposits, sequence of landscape development, activities of man, and general climate. Regional analysis yields very little direct

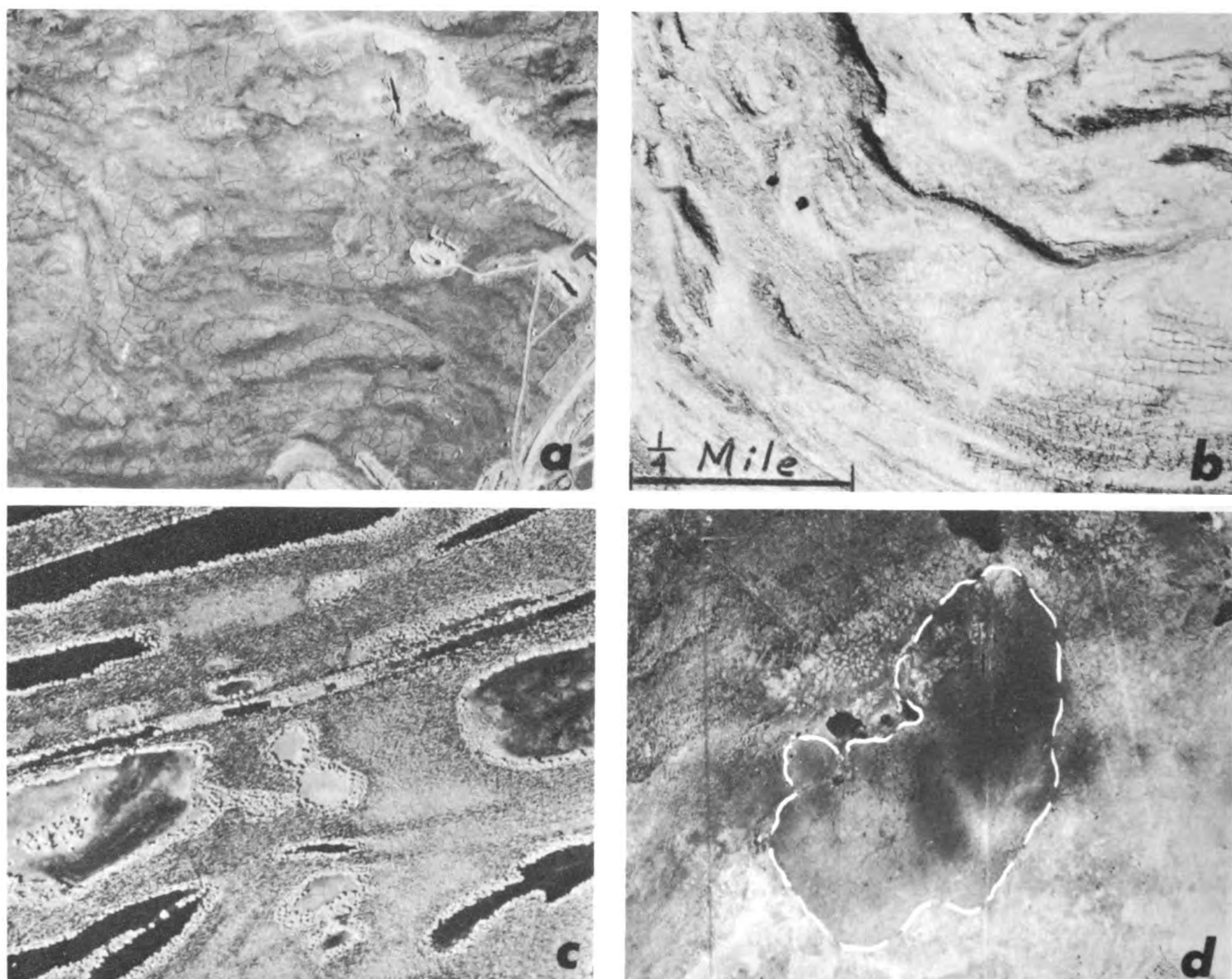

Fig. 1. Airphoto patterns associated with the arctic environments: a. Polygonal patterns in outwash sands and gravels; b. Polygonal patterns and frost boils over sedimentary rocks; c. Vegetative patterns in wet lowlands; d. Organic deposit in polygonal area

information about frost or permafrost phenomena in an area. Such data must await detailed stereoscopic study of contact photos where each pattern element is closely examined.

Pattern Element Analysis

Stereoscopic pairs of contact photos typical for each major pattern are studied to determine physical characteristics of the minute features. The scale best suited for general analysis is about 1 to 20,000 (± 4000). The common pattern elements of natural landscape are landform, drainage, erosion, tones, vegetation, land use, and special features. Each element suggests important pattern data—such as properties of the soil, rock, or a combination. Study of the pattern elements yields detailed information about the frost and permafrost phenomena of various parts of the area.

Close scrutiny of landforms includes size, shape, boundary conditions, spatial relationships, and surface configuration. These properties point to composition and degree of homogeneity of a deposit. In arctic or subarctic regions such landform characteristics as slope, exposure, configuration, and topographic position are important in determining frost and permafrost phenomena. Peculiarities of arctic or subarctic weathering have caused notable softening of many arctic landforms; this is significant in evaluating frost-action phenomena.

Drainage is best studied after marking all drainage ways in an area. In general, the areal drainage pattern is little altered

by permafrost. At best, this pattern aids in identifying the major parent materials, their homogeneity, and over-all porosity.

Studying minute erosional features (wind, water, thermal, chemical) provides data on the existence of soil profile and its development, condition of materials, soil or rock types and textures, degree of induration, etc. In arctic and subarctic regions, study of minute erosional features has added significance. Frozen soils erode chiefly because of thaw induced either by running water or by a sudden thermal imbalance between air-soil temperature as controlled by vegetative cover and heat exposure. Permafrost exerts considerable influence on gully characteristics, resulting in such unusual forms as "button" and "polygon-net" gullies.

Vegetation is important in terrain analysis since it provides a single expression where all significant physical, chemical, and biological factors are integrated. In an undisturbed area the fully developed plant community is in dynamic equilibrium with the prevailing combination of factors operating largely through climate and soil. Thus vegetation is a very useful indicator of soil type and condition in an area. In arctic and subarctic areas, however, vegetation is inadequate as the only indicator, since vegetation changes constantly and many factors affecting the changes are local. Often permafrost can be inferred by correlating cover types with texture, drainage, and topographic position.

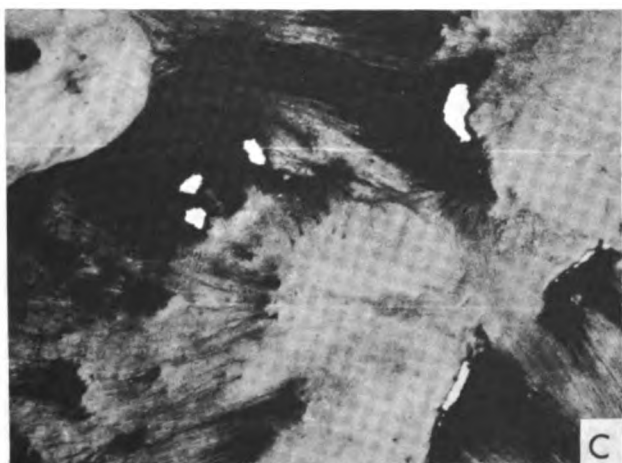

Fig. 2. Airphoto patterns reflecting surface conditions: a. Solifluction stripes indicating relatively uniform soil flow on gradual slopes; b. Solifluction lobes indicating areas of soil movement and changes of slope; and c. Grasses indicating wet surface soils below melting snow fields

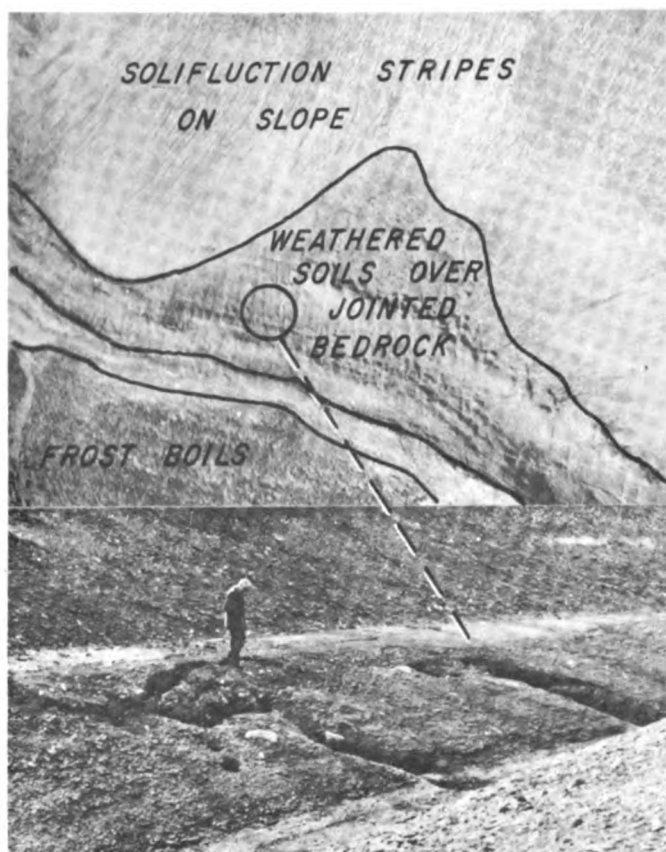

Fig. 3. Failure created when ditch was constructed over ice-wedges in jointed bedrock. These wedges can be predicted from the airphoto pattern of the area

Phototones (tonality or grey scale value) provide important clues to lateral and vertical homogeneity in an area. Certain matter-energy relationships are responsible for producing the tones. Both man- and nature-controlled factors can cause widespread variations in the resulting image. In the Arctic and sub-Arctic, tones are unimportant as direct indicators of soil texture, but under certain circumstances they may reflect poor drainage, vegetation changes, topographic "lows," possibly permafrost, or a combination. Tones should be evaluated for topographic patterns, vegetation, drainage, and landform.

The cultural aspect of a pattern (land use), whether urban or rural, provides further areal data. Degree of alteration of or adaptation to the landscape by human activity should be described. Economic and sociological development in the area gives insight into the value man places on definite features. This is important where the extent of development disturbs the thermal regime. Severe thaw results from poor design, construction, and maintenance procedures causing damage to highways, railroads, and airfields (Figs. 3 and 4). Indiscriminate movement of vehicles in areas of adverse frost or permafrost conditions produces well-established visible evidences. Furthermore, carelessness with discharge and waste storage also produces indications of delicate thermal balance. Clearing land incidental to some enterprise such as agriculture, timber, or mining may also result in strong indicators of frost or permafrost phenomena.

Special features that are indigenous to arctic areas may be the result of severe climate, a catastrophic event, composition, or a combination of several factors. Patterns associated with frost or permafrost phenomena range from easy to most difficult to analyze using airphotos. Many features may be associated directly with areas of ground ice, unstable thermal regime, severe frost susceptibility, or various types of severe earth movement. Chief among such features are frost boils,

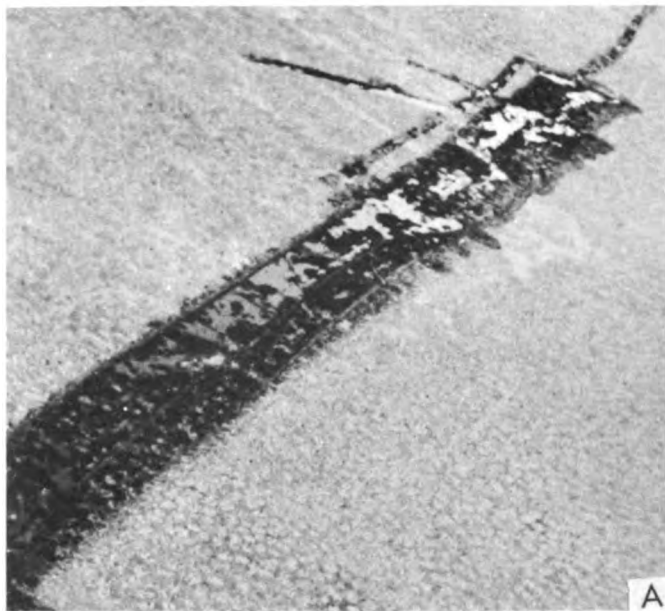

Fig. 4. Results of disturbing the thermal equilibrium of the terrain: a. Thawing created by removal of surface soils along a proposed airstrip; b. Thawing of ground ice after removal of surface soils; and c. Compressing surface vegetation by vehicle traffic creating subsurface thaw

polygons, pingós, thermokarst, button drainage, leaning trees, altiplanation terraces, mud flows, and solifluction lobes.

Summation and Verification

Study of each element yields information about the physical properties of the area and its materials. Data are then correlated and areas of agreement or disagreement are determined. In cases of disagreement further study may be necessary. When complete agreement is achieved the data are made available in map or report form ready to be used for a particular problem. Physical properties of an area and its behavior under conditions of load, disturbance, or use may provide important answers to problems of criteria governing location, design, construction, maintenance, and materials survey for large structures or installations.

ARCTIC ENGINEERING SIGNIFICANCE

In arctic and subarctic regions photoanalysis is significant not only because of remoteness and inaccessibility but also because of the problems of use, alteration, and disturbance of the frost and permafrost regime. Interpretation of photoanalysis data must inform those responsible for design, location, construction, maintenance, and materials survey of the significance of frost or permafrost phenomena in the area, as well as give the identity and distribution of the various soils and rocks. Information in permafrost areas should include ice-soil relationships, type and distribution of ice masses, characteristics of the active zone, surface configuration, surface and subsurface drainage and water bodies, continuity of the permanently frozen materials, and characteristics of the vegetation (perhaps in terms of type, structure, density, and distribution). Location and distribution of frost-susceptible materials should be presented as well as the relation between active and permafrost zones. Data on slopes, vegetation, texture, moisture condition, and in certain instances, on snowdrifting under winter conditions, can be obtained.

Selected routes and structure sites can be inspected critically and rated in order of priority with respect to criteria. The locations for field sampling can be noted for use in planning and conducting the necessary field sample program to obtain design data. Marginal and adverse areas or routes can be dropped from further consideration without recourse to field inspections.

Considerable advance data can be given to the design engineers prior to obtaining detailed profile data from the field. For example, a map can be prepared (site map or strip map of the area on either side of the route centerline) showing type and distribution of soils, rocks, drainage, vegetation, permafrost type and condition, frost-action potential, and characteristics of the active zone (Fig. 5). For highways such information is very important in solving several problems of geometric design. Because of the often delicate thermal regime in many frost and permafrost areas, the time of year or the general climatic condition for construction frequently becomes more critical than actual design features. Design depends on the time of year selected for construction as well as construction technique. Also important is the degree of terrain alteration or adaptation necessary. Careless construction during thawing periods can negate the best design features and result in construction difficulties and poor performance. Conditions based on maximum thaw in an undisturbed state and then the expected behavior for particular construction practices should be adequately described.

Use of photos to identify physical properties and to predict behavior provides the builder with valuable data. For example, information concerning trafficability and workability with respect to climatic condition can usually be obtained with ease. Selecting equipment and techniques can be based on such data. Photos are useful in determining access to an area and locating access routes between construction site and sources of materials. Where minimum disturbance practices are recommended, photos can be used to locate utility roads.

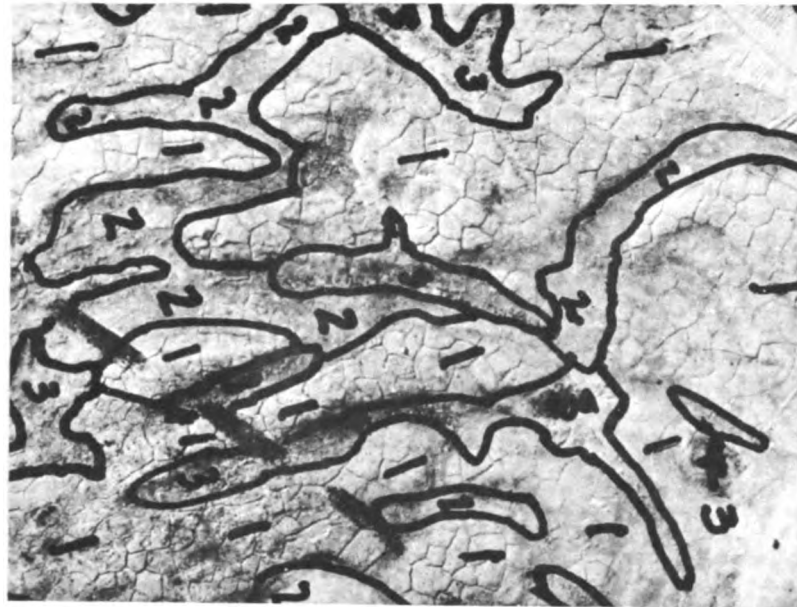

Fig. 5. Typical engineering soil maps prepared for site analysis in arctic areas

Periodic photocoverage is important not only for construction progress but also for critical review to determine thermal upset and thermal stability due to disturbance.

Where adverse locations must be considered for special reasons, airphotos are excellent for obtaining information on location, characteristics, and workability of borrow materials. Included also are data on controlling excess water which may result from induced thaw in the borrow area. In many frozen areas the practices of progressive thaw, spreading and windrowing for drying, and stockpiling must be followed well in advance of actual need at the site to ensure a supply of workable materials during the construction season. This permits earlier than normal construction dates during subsequent seasons.

NEW SYSTEMS AND TECHNIQUES

The technique described yields information which can be expressed in qualitative terms only. Of the imaging techniques available today, none can match the visual photograph for information content per unit of area. Much research is needed with aerial photographic and other remote sensing systems to obtain a "quantitative breakthrough." The visual photograph records only reflected surface information while subsurface information is obtained indirectly, it is inferred by analyzing surface patterns. Using other imaging techniques might provide the quantitative breakthrough if their information is used to supplement that obtained from the visual photograph.

Radar systems and infrared thermal scanners are two remote

imaging techniques now receiving considerable attention. Like visual phototechniques these systems use energy from the electromagnetic spectrum but each from a different portion. For instance, the photographic image results from the sensitization of an emulsion by reflected solar energy, whereas infrared thermal imagery is derived from the thermally induced radiation of the materials being sensed by a scanning detector. Radar imagery results from recording the reflected return of a signal emitted from the system itself. The intensity of this reflected signal is a function of the electrical properties of the materials in question. There are radar systems today which permit the measure of thickness of portions of the ice-cap. Research is underway to make these systems airborne and find possible application for measuring the thickness of sea ice, river ice, or lake ice.

Although some systems use portions of the spectrum beyond the camera, it is not obsolete; it merely supplements the available sensors. We should, therefore, determine when and under what conditions these other systems should be used. To record energy differences which are thermally engendered and are either radiated, reflected, or emitted beyond the visible spectrum, it is necessary to select a sensor combination designed to work in certain energy bands, but due consideration should be made for the fundamentals involved and the atmospheric conditions through which the energy must travel. When used improperly, such devices are either worthless or an expensive novelty.

Successful use of any system is based on understanding design features, limitations, natural and instrumental parameters, matter-energy relationships, and intelligent use.

Color aerial photography also shows promise. A limited amount of color photography taken along the Arctic Coast was studied by the authors. This photography exhibited considerable detail and a wide range in soil color tones which appeared to have advantages over black and white photography.

SUMMARY

Photointerpretation by remote sensing photoanalysis has progressed considerably in the last 20 years, but this appears to be only the beginning. As new systems using electromagnetic energy, force fields, acoustical energy, or atmospheric sampling become available, research must be continued to define and determine its application.

The following references are presented according to the conference format, but as the list is intended for additional reading and the authorities are used as references to text material, the reference numbers have not been inserted in the text.

REFERENCES

[1] R. E. Frost, J. E. Hittle, K. B. Woods. "Summary and

Statement of Technique, Aerial Photographic Reconnaissance Investigation, Frozen Soils in the Territory of Alaska," App. 3, Comprehensive Rept., Airfield Construction in Arctic and sub-Arctic Regions, Contract Rept., Purdue Univ. for St. Paul District, Corps Engrs., 1948.

[2] E. G. Stoeckeler. "Identification and Evaluation of Alaskan Vegetation from Airphotos with Reference to Soil, Moisture, and Permafrost Conditions," Tech. Rept. 21, ACFEL, 1949.

[3] R. E. Frost, O. W. Mintzer. "Influence of Topographic Position in Airphoto Identification of Permafrost," Highway Res. Bd. Bull. No. 28, Soil Exploration and Mapping, 1950.

[4] R. E. Frost. Evaluation of Soils and Permafrost Conditions in the Territory of Alaska by Means of Airphotos, Vols. 1, 2, Contract Rept., Purdue Univ. for St. Paul District, Corps Engrs., 1950.

[5] E. G. Stoeckeler. Trees of Interior Alaska, Their Significance as Soil and Permafrost Indicators, St. Paul District, Corps Engrs., 1952.

[6] R. E. Frost. "Interpretation of Permafrost, Features from Airphotos," Highway Res. Bd. Spec. Rept. No. 2, Frost Action in Soils, 1952.

[7] R. D. Leighty. "Proposed Relocation of Camp Tuto and Access Road of Airphoto Survey," Tech. Rept. 52, U.S. Army SIPRE, April 1958.

[8] Manual of Photographic Interpretation, Am. Soc. Photogrammetry, 1960.

[9] R. D. Leighty, A. O. Poulin. "Ice Cap Access Route Narssarsuaq, Greenland," Tech. Rept. 48, U.S. Army SIPRE, May 1960.

[10] R. E. Frost. "Aerial Photography in Arctic and sub-Arctic Engineering," J. Air Trans. Div., Proc. ASCE, Vol. 86, No. AT 1, May 1960, pp. 27-56.

[11] A. E. Pressman, et al. "Terrain Analysis of Ice-Free Land Sites in Arctic Canada," Final Rept. 206, Air Force Cambridge Res. Lab., 1961.

[12] "Airphoto Pattern Reconnaissance of Northwestern Canada," Tech. Rept. 41, ACFEL, Vols. 1, 2, 1962.

[13] J. R. Chaves, R. L. Schuster, R. J. Warren. "A Preliminary Evaluation of Color Aerial Photography in Materials Surveys," Highway Res. Bd. Proc., Vol. 41, 1962, pp. 611-620.

[14] J. P. Minard, J. P. Owens. "Application of Color Aerial Photography to Geologic and Engineering Soil Mapping," Highway Res. Bd. Bull. 316, 1962, pp. 12-22.

[15] R. D. Leighty. "Engineering Information of Arctic Areas Obtained from Aerial Imagery," Trans. Symp. Photo Interpretation, Intl. Archives Photogrammetry, Vol. 14, Sept. 1962, pp. 383-389.

[16] A. E. Pressman. "Comparison of Aerial Photographic Terrain Analysis with Investigation in Arctic Canada," Photogram. Eng., Vol. 29, No. 2, March 1963, pp. 245-252.

GEOPHYSICAL METHODS FOR DELINEATING PERMAFROST

DAVID F. BARNES, U. S. Geological Survey, Menlo Park, California

Freezing of interstitial water in rocks and soils causes changes in physical properties that can be located and measured by several geophysical prospecting procedures. Accordingly, these procedures provide possible methods of mapping the distribution and size of permafrost layers, and of determining some of the physical characteristics of the frozen ground. Since they are primarily indicators of the presence of frozen interstitial water rather than of the thermal regime that defines permafrost, however, the results can be misleading in dry or saline water areas. Furthermore, most of the methods are sensitive to variations in the degree of interstitial freezing, and where these variations occur near the ground surface, they may mask the effects of more important physical changes at greater depths.

These factors cause the effectiveness of geophysical methods to vary from site to site, and probably have delayed their adoption as routine methods of delineating permafrost. Nevertheless, geophysical techniques have been used in many North American permafrost areas, and have provided useful information about the distribution, thickness, and physical character of the permafrost. They probably could be profitably used in many more areas as a preliminary step for planning or possibly as a substitute for exploratory drilling.

Physical properties that probably change most when interstitial water in rocks and soils freezes are the elastic moduli and the electrical conductivity. Therefore, seismic and electrical methods are believed to be the most useful geophysical methods for permafrost studies. Freezing of interstitial water has little or no effect on density, magnetism, or radioactivity of rocks, so the other standard geophysical prospecting techniques have not been tried. However, gravity surveys have been considered for locating large ice lenses and other density variations in permafrost [1] and have indicated the presence of large ice cores in pingos [2]. Modern developments in the design and use of sensitive gravimeters might make further gravity investigations for locating ice bodies profitable. Nevertheless, seismic and electrical methods provide the best possibilities for geophysical investigations of permafrost, and the effects of freezing on the seismic wave velocity and electrical conductivity of rocks and soils are reviewed briefly.

SEISMIC VELOCITIES IN PERMAFROST

Seismic compression wave velocities in frozen ground were measured at several places in North America, both in relation to testing the applicability of seismic methods for permafrost studies, and in the course of exploration for petroleum and other minerals. Permafrost studies primarily involved refraction measurements and have been concentrated in the Tanana Valley, Alaska, and at Thule, Greenland. Seismic exploration for petroleum consisted primarily of reflection surveys, but velocity data were obtained from supporting refraction measurements and velocity logs of drill holes. Many petroleum surveys have been made in Alaska and northern Canada, but only the data from Naval Petroleum Reserve No. 4 have been released for public inspection.

Table I summarizes seismic velocity data obtained from several studies in permafrost areas. The data were obtained over 25 years, during which the measuring techniques and knowledge of factors which affect seismic velocities advanced greatly. Furthermore, almost all early measurements were a byproduct of investigations whose primary aim was prospecting for placer deposits, ground water, or petroleum.

Roethlisberger's [3, 4] measurements at Thule may be the only ones made primarily for the seismic study of permafrost. His data show a uniformity that reflects both modern measurement techniques and limitation of measurement to rocks of well

identified lithology. The wide range of some of the other velocities in the table suggests varied lithology, porosity, and degree of interstitial freezing. For example, data gathered by the author in 1952 for the velocity of frozen alluvium in the Tanana Valley include 15 measurements made at several different locations and in rocks at near freezing temperatures in which the degree of interstitial freezing probably varies much more than in the -11°C permafrost at Thule.

Few of the seismic velocity measurements in permafrost have been accompanied by adequate description of the physical properties of the rocks in which they were made. In preparing Table I, some of the rock types were identified by reference to geologic maps and reports published after the velocity measurements were made. Likewise, the ground temperature measurements were made at places as much as 25 miles away from the sites of the velocity measurements, or were estimated from Weather Bureau climatic data, so that most of them do not give exact conditions at the site of measurement.

Table I also includes a summary of permafrost velocity data obtained from Naval Petroleum Reserve No. 4, Alaska, where comprehensive geophysical and geological investigations were made [5-9]. However, most of the Petroleum Reserve seismic measurements emphasize data from depths below the permafrost. Velocity logs were made in nine test wells, but since only one or at most three geophones were placed within the permafrost layer in each well, the variation of velocity with depth in the permafrost cannot be determined. Furthermore, some of the wells were drilled in rocks containing saline interstitial water that was only partly frozen, and other wells were drilled in areas where nearby ocean or lakes probably caused higher than normal ground temperatures.

The seismic refraction data were also obtained for the location of deeply buried layers. Because of long geophone spacings near the shot point, thin high-velocity, near-surface layers may not have been recorded. Shallow refraction measurements made in direct support of permafrost investigations [10] gave somewhat higher surface velocities than those recorded by the United Geophysical Co. [5] on long geophone spreads. The velocities obtained in some of these refraction measurements may also have been lowered by the thawing effect of water bodies near the geophone spreads.

In Table I, the velocity of compressional waves in frozen ground is significantly higher than the velocity in unfrozen rocks; velocity varies greatly with lithology and temperature. The logical approach to an understanding of the causes of this variation is to consider the velocity of compressional waves in the materials that constitute frozen ground: Mineral grains, ice, unfrozen fluids, organic matter, and gases that fill the remaining voids. The velocity of compressional waves in most rock-forming mineral grains (with the possible exception of clays and other secondary minerals) probably varies from about 12,000 to 20,000 ft/sec, the velocity range encountered in compact igneous rocks [11-13]. Pure ice has a velocity of about 12,200 ft/sec, but partly frozen saline water may have a velocity as low as 8000 ft/sec [14] depending on temperature, salinity, and gas content. Water has a compressional wave velocity of about 4400 to 4800 ft/sec, depending on temperature and salinity. Air at 0°C has a seismic velocity of about 1090 ft/sec; and the velocity in some types of dry, spongy, organic matter may be even lower.

Many laboratory and theoretical studies have been made that provide a basis for calculating the velocity of compressional waves in mixtures of materials with known velocities. Birch and Bancroft [15] note that theoretical studies by Voight in the 19th century suggested that the elastic properties of an aggregate of crystals could be evaluated by averaging the elastic properties of the component crystals. Laboratory measurements [12, 13, 15] have shown that the elastic

properties of a rock may be computed by averaging (on a volume percentage basis) the elastic properties of the component minerals—provided the rocks being studied are subject to pressures high enough to eliminate voids and flaws.

The effects of voids and of materials filling voids have also been studied extensively. Gassman [16] computed the seismic velocity of an aggregate of uniform spheres as a function of overburden pressure and pore fluid velocity and pressure, but his results are not directly applicable to poorly sorted mineral aggregates. Several laboratory studies [17-20] have been made of mineral-fluid mixtures, and a few [19, 21, 22] considered the effect of solidification of the interstitial material. Müller's [22] experiments are probably the only ones made outside the USSR in which ice filled the interstitial pores. (During the conference, the author learned of the more comprehensive laboratory determinations of the seismic velocities of frozen soils made by C. W. Kaplar which are published in this volume. Kaplar's velocities agree much more closely with velocities measured in the field than do previous measurements, but they also suggest that naturally frozen rocks may contain unfrozen or gas-filled voids. There

is still need for further investigations of the relationship between seismic velocity, porosity, saturation, and unfrozen water content.)

Müller measured the velocity in six synthetic sand and clay cores which had different porosities but which were well saturated with water before freezing. Fig. 1 shows the velocity variations that he obtained as a function of temperature. The flatness of the curve for pure ice and the gentle slope for four other curves suggest that a small portion of the interstitial water in these cores did not freeze until very low temperatures were reached. The much greater temperature dependence shown by the bottom curve for an "Altwarmbuchner" clay suggests that a larger amount of the interstitial water remained unfrozen at temperatures near the freezing point. Such a curve should be typical of rocks and soils in which the freezing point is lowered by saline interstitial water or by interfacial forces in fine-grained soils (although Müller's interpretation of the Altwarmbuchner curve seems somewhat different).

Data taken from these curves have been used to prepare Fig. 2, which shows the effect of porosity on the velocity

Table I. Seismic compressional-wave velocities measured in permafrost

Rock Types	Locality and Reference	Seismic Velocity (kilo ft/sec)		Estimated Ground Temp., °C
		Frozen	Unfrozen	
Quaternary sediments				
Silt and organic matter	Fairbanks Area, Alaska ^a	5-10	1.8-4	-1
Alluvial clay	Northway, Alaska ^b	7.8		-2
Silt and gravel	Fairbanks Area, Alaska ^c	7.7-10		-1
Aeolian sand	Tetlin Junction, Alaska ^c	8		-3
Floodplain alluvium	Fairbanks Area, Alaska ^c	8-14	6.1-7	-1
Tundra silts, sands, and peats				
(Gubik Formation, probably saline)	Barrow Area, NPR-4, Alaska [9]	8-8.8		-9
(Gubik Formation, probably saline)	Skull Cliff Area, NPR-4, Alaska [9]	7.4-8.9		-9
(Gubik Formation, less saline)	Topagoruk Area, NPR-4, Alaska [9]	8-12		-9
Gravel	Fairbanks Area, Alaska ^a	13.0-15.2	6-7.5	-1
Outwash gravel	Tanacross, Alaska ^c	7.6-10		-3
Glacier moraine	Delta Junction, Alaska ^c	7.6-13.2		-2
Unclassified sediments	Isachsen, Canada [44]	8.8		-10
Glacier outwash	Thule, Greenland [4]	14.1-15.3		-11
Glacier till	Thule, Greenland [4]	15.4-15.5		-11
Mesozoic sediments				
Mudstone (Ogotoruk Formation) ^d	Ogotoruk Creek, Alaska [45]	14.2	11 ^d	-5
Mudstone (Ogotoruk Formation) ^{d,e}	Ogotoruk Creek, Alaska [45]	13.2		-5
Shale and siltstone (Schrader Bluff Formation) ^e	Fish Creek Test Well 1, NPR-4, Alaska [5]	8.9-9.8	6.6-7.6	-8
Shale and sandstone (Chandler Formation) ^{e,f}	Umiat Test Well 2, NPR-4, Alaska [6]	12.7		-7
Shale and sandstone (Nanushuk Group) ^{e,g}	Simpson and Minga Wells, NPR-4, Alaska [7,8]	8.1-8.4	5-7	-9
Sandstone (Colville Group)	Umiat Area, NPR-4, Alaska [9]	10.7		-7
Sandstone and shale (Nanushuk and Colville Group)	Meade-Oumalik Area, NPR-4, Alaska [9]	10-14		-9
Sandstone (Isachsen Formation)	Isachsen, Canada [44]	11.1		-10
Paleozoic and older sediments				
Shale (Dundas Formation)	Thule, Greenland [4]	13.3-14		-11
Sandstone (Narssarssuk Formation)	Thule, Greenland [4]	15.6-17.9		-11
Quartzite (Wohlstenholm Formation)	Thule, Greenland [4]	18,		-11
Dolomite (Narssarssuk Formation)	Thule, Greenland [4]	18.9-19.5		-11
Metamorphic rocks				
Schist (Birch Creek Schist)	Fairbanks Area, Alaska ^a	13-16		-1
Gneiss	Thule, Greenland [4]	20		-11

^aObtained from H. G. Taylor, 1938, Report on geophysical work by the seismic method in placer deposits of Fairbanks District of Alaska, unpublished report to U. S. Smelting, Refining & Mining Co.

^bUnpublished data from J. H. Swartz and E. R. Shephard, U. S. Geol. Survey, 1946

^cData by author in 1952

^dThe Materials Testing Laboratory, U. S. Army Engineer District, Alaska, tested cores from this well and found that 5 porosity measurements averaged 6.4% and that dynamic measurements on unfrozen cores gave elastic moduli which may be used to compute a velocity in the unfrozen rocks of about 11,000 fps

^eMeasurements by velocity logs of wells; rest measured by refraction

^fPorosity measurements of 44 cores from Umiat Test Well #2 averaged 13.5% [46]

^gPorosity measurements of 15 cores from Simpson Test Well #1 averaged 30.8% [47]

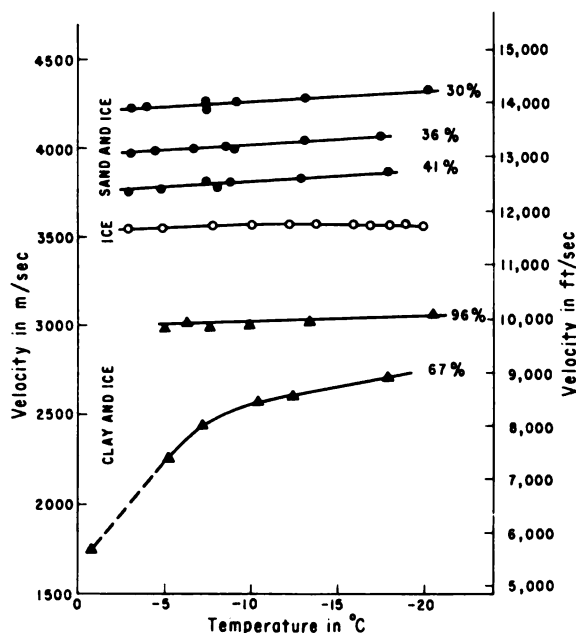

Fig. 1. Sound velocity in frozen, synthetic cores of various porosities as a function of temperature [22]

Copyright © 1961 European Association of Exploration Geophysicists. Reprinted by permission from Gerhard Müller, "Geschwindigkeitsbestimmungen elastischer Wellen in gefrorenen Gesteinen und die Anwendung akustischer Messungen auf Untersuchungen des Frostmantels an Gefrierschächten," *Geophysical Prospecting*, Vol. 9, No. 2, June 1961, The Hague.

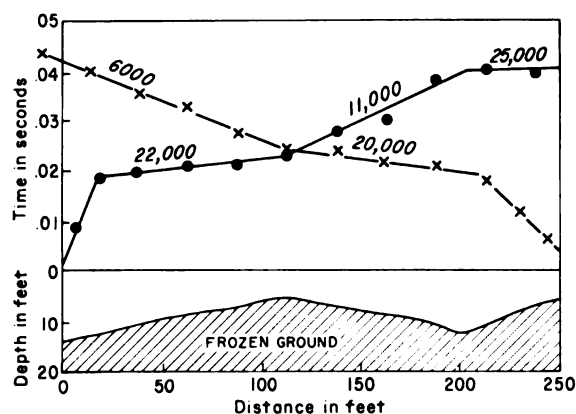

Fig. 3. Seismic travel-time curves and apparent velocities at Eielson Field, Alaska, showing irregular top of permafrost (author's 1952 data)

(actually reciprocal of velocity) of saturated cores. Fig. 2 is very similar to Müller's Fig. 3, except that the temperature of the cores approximates that of northern Alaska permafrost. The straight line in Fig. 2 represents a time-average formula used by both Wyllie [19, 20] and Müller [22] for approximating the velocity in mineral-fluid or mineral-ice mixtures.

If the formula is valid for all porosities, such a line should intersect the 0% and 100% porosity ordinates at the reciprocal velocities of the mineral matrix and the interstitial fluid respectively. Müller believed that the low velocity for ice (8300 ft/sec instead of 12,000 ft/sec) given by the intercept of the line through his data indicated the inclusion of air in his cores. This interpretation is probably correct, and other approximations would not give more reasonable intercepts. For example, a curve based on a volume-percentage average would be concave and would intersect the 0% and 100% porosity ordinates at even lower velocities.

Gas- and liquid-filled voids probably influence the seismic velocity of naturally frozen ground even more than in Müller's synthetic cores. Only three field measurements of the seismic velocity of frozen ground have been accompanied by measurements of porosity. These were made in northern Alaskan test wells; the data from them are indicated by footnotes in Table I and are plotted on the graph in Fig. 2. In all three cases the velocities in the naturally frozen rocks are significantly lower than velocities indicated by laboratory measurements and by calculations based on percentage volumes occupied by ice and minerals. This is good evidence that most naturally frozen ground contains a significant proportion of gas- or liquid-filled voids. Any further studies of the seismic velocity in frozen rocks should include measurement of the volumes occupied by fluids and gas. Recent studies of sea ice [23, 24] suggest that the elastic properties of an ice-brine mixture may be estimated from chemical composition and temperature. Frozen ground is a more complex system, but its seismic velocity is probably determined by similar laws.

Although formulas for computing and understanding the velocities of compressional waves in frozen ground are not yet available, these velocities show the following characteristics: (1) They are higher when the ground temperature is low; (2) they are higher in older, more compact, and less porous rocks; (3) they are lower when the interstitial water is saline and only partly frozen; (4) they are lower in very fine-grained rocks (clay) in which the freezing point is lowered by interfacial forces; (5) they are higher when measured over a horizontal direction than over a long vertical direction, because refraction in the horizontal measurements usually shows the velocity of the highest velocity layer, and the vertical velocities are an average of high- and low-velocity layers.

SEISMIC SURVEYS OF PERMAFROST

The large velocity contrast between frozen and unfrozen ground

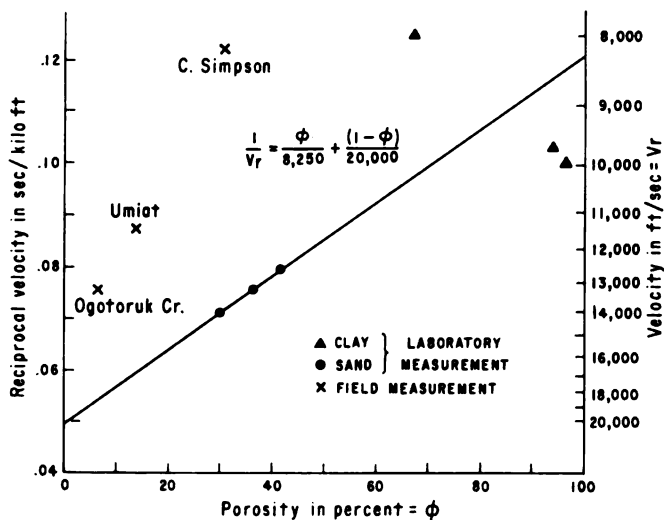

Fig. 2. Sound velocity of frozen rocks at approximately -7°C as a function of porosity (laboratory measurements by Müller [22], field measurements from Alaska [6, 7, 42 to 44]).

Copyright © 1961 European Association of Exploration Geophysicists. Reprinted by permission from Gerhard Müller, "Geschwindigkeitsbestimmungen elastischer Wellen in gefrorenen Gesteinen und die Anwendung akustischer Messungen auf Untersuchungen des Frostmantels an Gefrierschächten," *Geophysical Prospecting*, Vol. 9, No. 2, June 1961, The Hague.

immediately suggests that seismic surveys may be used to delineate permafrost bodies. However, none of the various seismic methods have proven satisfactory for measuring the thickness of permafrost layers, although they do provide information about the depth to the upper surface, the physical properties of the permafrost, and sometimes the depth and physical character of the underlying bedrock layers.

The refraction method has been used for most permafrost investigations [3, 4, 25]. The principles and procedures of this method are based on Snell's law and are adequately described in standard geophysical texts. The fundamental limitation of the method is that it only records layers having velocities higher than those in the overlying layers.

Refraction measurements thus provide a good method of mapping the extent of a permafrost layer and the depth to its upper surface. If the permafrost table is shallow, such measurements could be more economically made by probing rods; but in areas where the permafrost table is more than 6 ft deep, the seismic method may be less expensive. The topography of the permafrost surface and the velocities generally encountered make computation of the depths by delay-time techniques [26, 28] very simple. Depths to the permafrost layer may thus be determined at the location of each geophone, which means that with standard equipment, as many as 12 permafrost depths may be determined for each shot. Fig. 3 shows an example of refraction travel-time curves and the permafrost profile computed from these data. Fig. 4 shows an example of travel-time curves indicating the presence of a suprapermafrost ground water layer in the Tanana Valley, Alaska.

Refraction measurements have also proved useful for detecting high-velocity rocks beneath permafrost. Most igneous or metamorphosed rocks, especially frozen ones, have velocities greater than those of frozen unconsolidated sediments, so energy that travels through crystalline bedrock beneath frozen alluvium or glacial deposits appears as a first arrival and can be used for calculating the depth to the bedrock. If the bedrock consists of sedimentary rocks, or if it is not frozen, its velocity may be lower than or close to that of the frozen overburden, and the energy traveling through it may arrive later or at nearly the same time as the energy traveling through the permafrost.

In normal refraction prospecting, such energy is hard to distinguish, and the presence of the lower layer may not be detected. However, in some arctic areas, the energy that

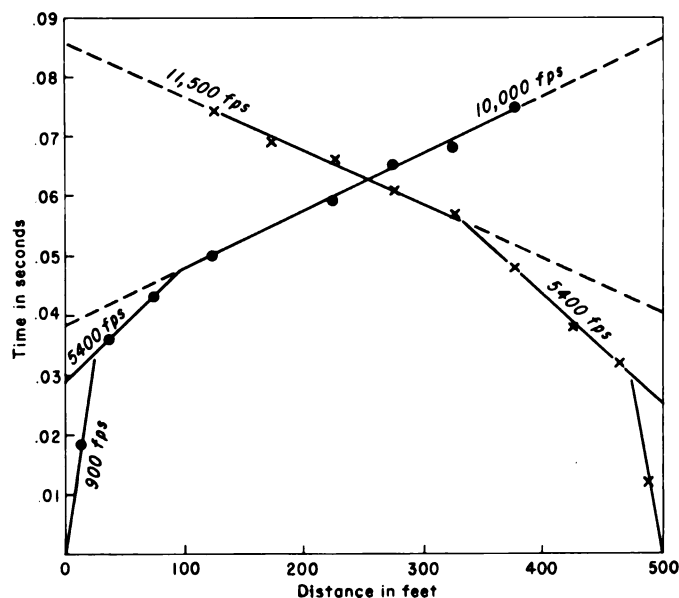

Fig. 4. Seismic travel-time curves near Fairbanks, Alaska, showing 15 ft of dry alluvium (velocity 900 ft/sec), overlying about 40 ft of water-saturated sediments (velocity 5,400 ft/sec), above permafrost (velocity 10,750 ft/sec) (author's 1952 data)

travels through the permafrost attenuates rapidly; thus, later arrivals may be distinguished. Barnes and MacCarthy [29] recorded a second-arrival refracted wave traveling through crystalline schist beneath frozen alluvium in the Tanana Valley, Alaska; Roethlisberger [3, 4] recorded a second-arrival refraction from frozen shale beneath frozen sands and gravels at Thule, Greenland.

The attenuation of energy traveling through the permafrost layer is probably caused by the inverse velocity gradient within the permafrost which has higher temperatures at depth. The vertical permafrost velocities used to compute the depth of bedrock layers should generally be lower than the horizontal velocities recorded at the surface, so drill-hole depths or vertical velocity logs are a valuable aid in interpreting the seismic data. Furthermore, all refraction measurements of layers beneath the permafrost should be accompanied by measurement of depth to permafrost table along the entire seismic line, because changes in thickness of the active layer may produce large changes in the apparent velocity, which may be misinterpreted as an effect of deeper layers.

Refraction measurements have proved the most useful procedure for seismic studies of permafrost, but other seismic methods for measuring the thickness of the permafrost layer have also been tried. Crowley and Hanson [30] attempted to use flexural wave dispersion to measure the thickness of frozen alluvium in the Tanana Valley, Alaska. This dispersion was observed on a line more than a mile in length, but the lack of a good theoretical model prevented a satisfactory interpretation. Furthermore, dispersion measurements require that uniform permafrost thickness and elastic properties extend for such long distances that the method does not provide sufficient resolution for most site selection problems.

Crowley [31] used a high-resolution reflection seismograph (Southwest Industrial Electronics Co.) to try to obtain reflections from the base of the permafrost layer. Tests were made in several parts of Alaska, but only one seismic arrival was recorded that could have been a reflection off the bottom of the permafrost. The interpretation of that arrival could be questioned. In most places the base of the permafrost is probably both irregular and gradational so that it does not form a good seismic reflector.

ELECTRICAL PROPERTIES OF PERMAFROST

Almost all the electrical investigations of permafrost in North America have employed DC instruments which measure self-potential and resistivity. Earth potentials in arctic areas exhibit large fluctuations which are related to auroral activity and other electromagnetic phenomena [32, 33]. However, investigations by MacCarthy [34] suggest that self-potentials also respond to freezing and thawing processes. Resistivity, however, is the property that has been used for measuring the size and distribution of permafrost bodies.

The frozen ground resistivities published by Joesting in 1945 [35] are still the best compilation of North American data. Table II was prepared largely from data in his paper, and values from Greenland [36] and Antarctica [37] have been added. Several later geophysical parties [25, 33, 38] have made dc resistivity measurements in the Tanana-Yukon area where Joesting's observations were made. Most of the later measurements show values within the ranges cited by him. The only resistivity data from the investigation of Naval Petroleum Reserve No. 4 are well logs made a short time after the drilling of each well was completed. Because the drilling process probably thawed a large zone around the well, these resistivity data are not considered typical of frozen rocks. The resistivities shown in Table II were all obtained from depth stations made on the ground surface. The interpretation of these depth stations involves problems which will be discussed in a later section and which make the values computed from them somewhat uncertain.

Table II shows that the resistivities of frozen rocks and soils may be 10 to more than a hundred times larger than the resistivities of unfrozen rocks. The lowest frozen-rock resistivities shown in the table are those from the very low

Table II. Field measurements of rock and soil resistivity for direct currents

Rock type	Locality	Resistivities Ohm-cm x 10 ⁻⁴		Approx. Temp.	Ref.
		Frozen	Unfrozen		
Silt and organic matter	Yukon-Tanana Area, Alaska	20-80	0.36-19	-1	[35]
Sand and fine gravel	" "	63-240	2.2-7.1	-1	[35]
Gravel	" "	78-410	10.0-18.5	-1	[35]
Conglomerate	Circle District, Alaska	120-160	2.2-7.0	-1	[35]
Glacial drift	Thule, Greenland	30-400	...	-11	[36]
Gneiss	" "	730-1370	...	-11	[36]
Basaltic debris	Scott Base, Antarctica	1.5-15	...	-21	[37]
Marine gravel	Hallett Base, Antarctica	.32-4.0	...	?	[37]

temperature rocks in the Antarctic. However, both of these measurements were made close to the ocean and may be influenced by the presence of saline water. The table does not cover a sufficient range of ground temperatures and interstitial-water compositions to show how these factors affect the resistivities. However, both resistivity and seismic velocity are similarly influenced by changes in porosity, interstitial fluids, and some lithologic factors [36, 39]. Therefore, the resistivity of frozen rocks probably shows the same qualitative relationship as the velocity of frozen rocks, although the resistivity is especially sensitive to the amount of ionic conduction in the interstitial fluids. The Alaska and Greenland data in Table II seem to confirm the tendency of frozen-rock resistivities to increase with both lower temperatures and increased compactness.

There is even less theoretical and laboratory information for quantitative evaluation of frozen-rock resistivities than for frozen-rock velocities. Cook [40] made some laboratory measurements of the resistivity and dielectric constant of synthetic permafrost samples. His measurements were made with a Q-meter operating at about 100 mc/sec on samples at a temperature of -35°C. His results are shown in Table III.

These values are significantly lower than those obtained in the field with DC prospecting techniques—an unexplained difference that may be related to the difference in measurement techniques. Additional data are available in the Russian literature [41]. However, many investigations of the resistivity of unfrozen rocks [42] show that the resistivity is largely a function of interstitial fluids.

Table III. Radio frequency properties of synthetic permafrost at 100 mc/sec and -35°C [40]

	Resistivity (ohm-cm)	Dielectric constant
Frozen tap water with 0.2% Ca(HCO ₃) ₂	2 500 000	3.5
Frozen tap water in coarse sand	120 000	4.5
Frozen wet sandy clay	13 000	5.0
Brown soil	20 000	4.4
High Fe clay	6 800	7.0
High Al clay	62 000	3.3
Limy mud (lagoonal)	14 000	3.6
Silica mud (diatomaceous)	13 500	1.0

RESISTIVITY SURVEYS IN PERMAFROST

Theoretically, resistivity measurements on the ground surface are capable of determining both the horizontal and vertical extent of buried, high-resistivity bodies, such as permafrost layers. However, interpretation of the field data involves comparisons with results computed for simple mathematical models that are seldom closely approximated in nature, and solutions are not unique for any but the most simple field conditions. Small variations in temperature, lithology, and vegetation can cause large resistivity variations, which are generally departures from the simple conditions that can be analyzed mathematically.

Field measurements in North America generally employ the Wenner configuration of four equally spaced and aligned electrodes, in which current enters the ground at the outside electrodes and potential is measured at the inside electrodes. Horizontal changes in resistivity are detected by keeping the electrode spacing constant and moving the array along a traverse in steps that are usually equal to either one or one-half electrode spacing. This procedure has been quite successful for indicating discontinuities in permafrost occurrence and in thickness of overburden (Fig. 5). In some areas, changes in rock type or permafrost depth cause apparent resistivity changes that are as large as the changes caused by the presence or absence of permafrost in other areas, but an experienced observer can usually identify the cause of the resistivity changes correctly.

If the center of the electrode array remains in one place and the electrode spacing is gradually enlarged, data for a graph of apparent resistivity versus electrode spacing are obtained. This graph gives an indication of the variation of resistivity with depth. Since these "resistivity depth stations" can indicate the thickness of permafrost, they have been used in most arctic and subarctic resistivity studies. Fig. 6 shows a log-log plot of apparent-resistivity data obtained from a depth station on an alluvial fan near Tok Junction, Alaska.

The field data did not include enough readings at small electrode spacings to define a smooth curve on the left side of the figure, and no theoretical curve that matches the data at these spacings was found. However, the two lines in the figure are theoretical curves obtained from Mooney and Wetzel [43], which fit either the 2, 5, or 10 ft data. Both

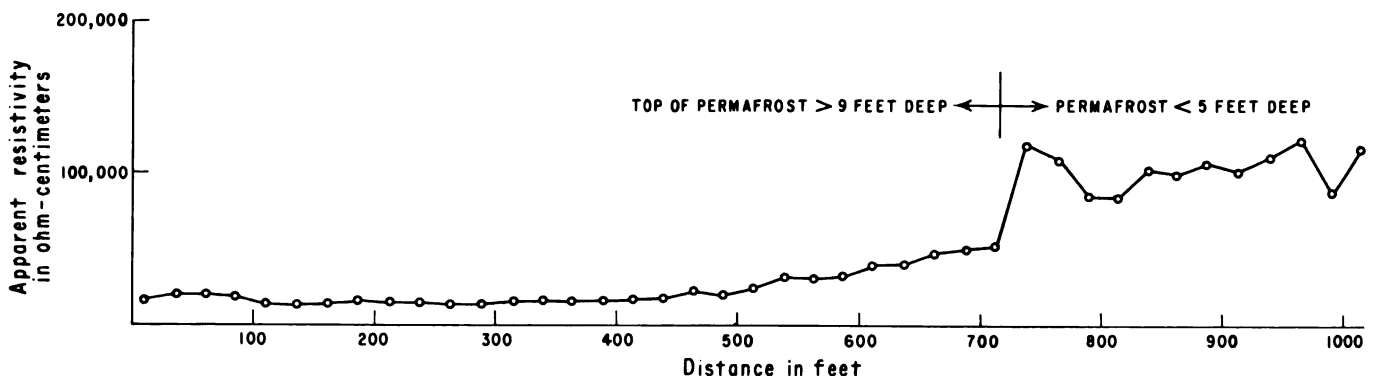

Fig. 5. Horizontal-resistivity profile in frozen alluvial silts (constant 50-ft electrode separation) (author's 1952 data)

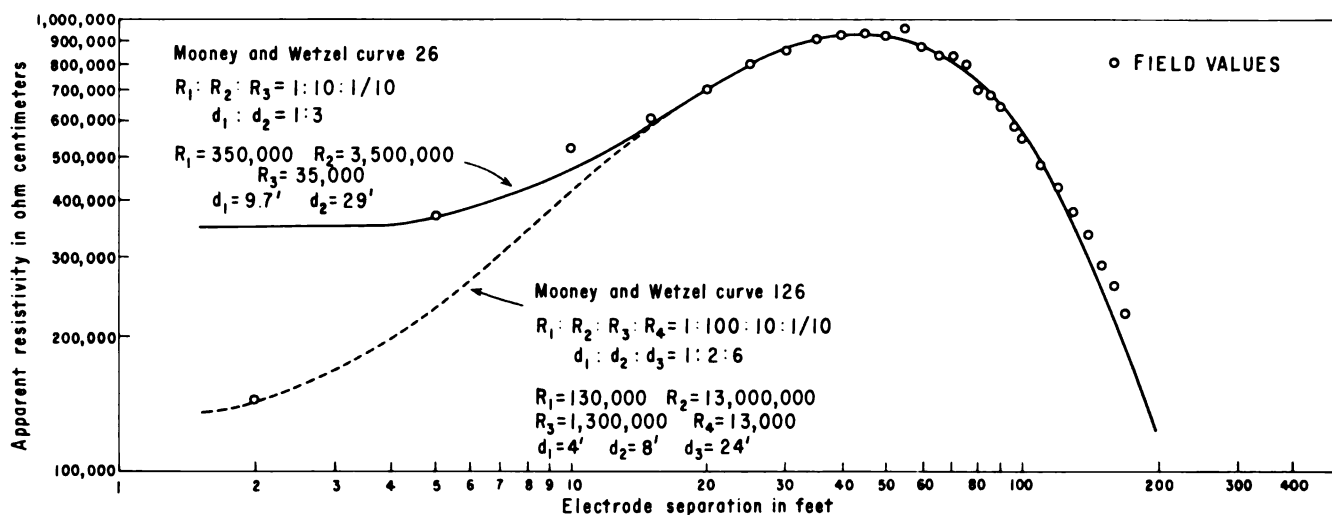

Fig. 6. Resistivity-depth data and interpretations (author's 1952 data)

curves give depths to an underlying low-resistivity layer that approximately agree with a 29 ft depth to the bottom of permafrost obtained from temperature measurements in a nearby drill hole. However, the curves indicate quite different conditions at the top of the permafrost, and thus show the difficulties of computing permafrost resistivities from field measurements.

More observations at small electrode spacings would have eliminated much of this uncertainty. Fits which were nearly as good could also have been made with curves computed for other models that would not represent expected field conditions.

The computed curves used for analyzing the data in Fig. 5 were obtained by a high-speed computer and were published in 1956 [43]. However, most tests of resistivity techniques for measuring permafrost thickness were made in earlier years when only two-layer and a very few three-layer curves were available. Since most permafrost problems involve three- or four-layer cases, the early data had to be interpreted by several partly empirical techniques for combining two-layer curves or for emphasizing the importance of small trends in the field data [29]. The publication of about 350 three-layer and more than 2000 four-layer curves [43] thus provides a much-improved tool for the interpretation of resistivity-depth data.

Many of the field curves from permafrost investigations are more complex, however, than any of the computed curves, and probably represent conditions involving gradational layers or more layers and larger variations in resistivity than those which were mathematically computed. Examination of field data from more than 50 permafrost stations in Alaska indicates that most of the data obtained before 1956 did not include a sufficient number of readings at small and large electrode spacings to adequately define the curve shape. If enough readings had been obtained, approximately one-fourth of these improved curves could be matched against computed curves, and an experienced analyst could probably use the computed curves and various curve combining techniques to interpret another half of the field curves. The remaining quarter of the Alaskan permafrost stations produced curves that are too complex for interpretation by existing techniques.

Fig. 6 can be used to illustrate another factor that makes the determinations of permafrost thickness by resistivity measurements difficult. The downward slope indicating the low resistivity material beneath the permafrost begins at an electrode separation of about 60 ft and is not adequately defined until the separation is more than 150 ft. This means that the total electrode array had to be more than 450 ft long to measure a permafrost thickness of less than 30 feet. Thicker permafrost would require proportionately longer spreads, because long electrode separations are required to measure the thickness of any insulating layer lying between the two conductive layers—the condition encountered in permafrost areas in summer when

the active layer thaws. The main difficulty in using long spreads is that uniform layers seldom extend for long distances, so that the electrodes cross lateral variations in active-layer thickness, which cause many curve irregularities and hinder interpretation.

Three improvements might be made in electrical techniques for measuring permafrost thickness. If resistivity measurements were made in late winter or early spring, the active layer would be frozen, shorter spreads would be adequate, and the curves obtained would be smoother and easier to interpret. If AC or commutated DC equipment were used, potential fluctuations caused by telluric currents would have less effect on the readings, and small potential electrodes could be used. This would yield better readings at small electrode separations. Finally, electromagnetic techniques are now available which can measure the depth of buried conductors without using long electrode spreads. These methods have been used in permafrost investigations in the USSR [41] and should be tested in North America.

REFERENCES

- [1] A. P. Bulmasov. Oblast' i uslovia primeneniia geofizicheskikh metodov razvedki v raionakh mnogolaynoi merzloty, Materialy po podzemnym vodam Vostochnoi Sibiri, Akad. Nauk SSSR, Vostochno-Sibirskii Filial, Irkutsk, 1957, pp. 157-163.
- [2] J. R. Mackay. "Pingos of the Pleistocene Mackenzie River Delta Area," *Geog. Bull. (Canada)* No. 18, 1962, pp. 21-63.
- [3] Hans Roethlisberger. "Seismic Refraction Soundings in Permafrost Near Thule, Greenland," in G. O. Raasch, ed., *Geology of the Arctic*, Vol. 2, *Internatl. Symp. Arctic Geol.*, 1st., Calgary, Alberta, 1960, Proc., 1961, pp. 970-981.
- [4] Hans Roethlisberger. "Applicability of Seismic Refraction Soundings in Permafrost Near Thule, Greenland," *Tech. Rept. 8*, U. S. Army CRREL, Feb. 1961.
- [5] H. B. Chalmers, Jr. "Report of Well Velocity Survey of Fish Creek Test Well No. 1," *U. S. Geol. Survey open-file report, United Geophysical Co.*, Rept. 49-21, Aug. 14, 1949.
- [6] J. A. Legge, Jr. "Report of Well Velocity Survey of Umiat Test Well No. 2," *ibid.*, Rept. 47-8, Dec. 8-10, 1947.
- [7] J. A. Legge, Jr. "Report of Well Velocity Survey of Umiat Test Well No. 2," *ibid.*, Rept. 48-1, Feb. 21, 1948.
- [8] Eugene Wiancko. "Report of Well Velocity Survey of Minga Velocity Test No. 4," *ibid.*, Rept. 50-7, May 8, 1950.
- [9] J. R. Woolson et al. "Seismic and Gravity Surveys of Naval Petroleum Reserve No. 4 and adjoining areas, Alaska," *U. S. Geol. Survey Prof. Paper 304-A*, 1962, [1963].
- [10] J. C. Maxwell. Personal comm., 1953.
- [11] A. F. Birch, J. F. Schairer, H. C. Spicer. "Handbook of Physical Constants," *Geol. Soc. Am. Spec. Paper 36*, 1942.

- [12] L. H. Adams, R. E. Gibson. "Elastic Properties of Certain Basic Rocks and of Their Constituent Minerals," Natl. Acad. Sci. Proc., Vol. 15, No. 9, pp. 713-724.
- [13] L. H. Adams, E. G. Williamson. "Compressibility of Minerals and Rocks at High Pressures," J. Franklin Inst., Vol. 295, 1923, pp. 475-529.
- [14] Kenneth Hunkins. "Seismic Studies of Sea Ice," J. Geophys. Res., Vol. 65, No. 10, 1960, pp. 3459-3472.
- [15] A. F. Birch, Dennison Bancroft. "Effect of Pressure on the Rigidity of Rocks," J. Geol., Vol. 46, 1938, No. 1, pp. 59-87; Pt. 2, No. 2, pp. 113-141.
- [16] Fritz Gassmann. "Elastic Waves Through a Packing of Spheres," Geophys., Vol. 16, No. 4, 1951, pp. 673-685.
- [17] D. S. Hughes, J. L. Kelly. "Variations of Elastic Wave Velocity with Saturation in Sandstone," ibid., Vol. 17, No. 4, 1952, pp. 739-752.
- [18] W. O. Murphy, Jr., J. W. Berg, Jr., K. L. Cook. "Seismic Velocity Study of Synthetic Cores," ibid., Vol. 22, No. 4, 1957, p. 813.
- [19] M. R. J. Wyllie, A. R. Gregory, L. W. Gardner. "Elastic Wave Velocities on Heterogeneous and Porous Media," ibid., Vol. 21, No. 1, 1956, pp. 41-70.
- [20] M. R. J. Wyllie. "An Experimental Investigation of Factors Affecting Elastic Wave Velocities in Porous Media," ibid., Vol. 23, No. 3, 1958, pp. 459-493.
- [21] Kumizi Iida. "Velocity of Elastic Waves in a Granular Substance," Earthquake Res. Inst. Bull., Vol. 17, Pt. 4, Tokyo Imperial Univ., 1939, pp. 783-808.
- [22] Gerhard Müller. Geschwindigkeitsbestimmungen elastischer Wellen in geofrorenen Gesteinen und die Anwendung akustischer Messungen auf Untersuchungen des Frostmantels an Gefrierschächten, Geophys. Prospecting, Vol. 9, No. 2, 1961, pp. 276-295.
- [23] D. L. Anderson. "Preliminary Results and Review of Sea Ice Elasticity and Related Studies," Engr. Inst. Canada Trans., Vol. 2, No. 3, 1958, pp. 116-122.
- [24] W. F. Weeks. "Studies of Salt Ice, I—The Tensile Strength of NaCl Ice," U.S. Army (CRREL) Res. Rept. 80, 1961.
- [25] H. R. Joesting. "Geophysical Exploration in Alaska," Arctic, Vol. 7, Nos. 3-4, 1954, pp. 165-175.
- [26] A. J. Barthelmes. "Application of Continuous Profiling to Refraction Shooting," Geophys., Vol. 11, No. 1, 1946, pp. 24-42.
- [27] L. H. Tarrant. "A Rapid Method of Determining the Form of a Seismic Refractor from Line Profile Results," Geophys. Prospecting, Vol. 4, No. 2, 1956, pp. 131-139.
- [28] S. M. Wyrobek. "Application of Delay and Intercept Times in the Interpretation of Multilayer Refraction Time Distance Curves," ibid., Vol. 4, No. 2, 1956, pp. 112-130.
- [29] D. F. Barnes, G. R. MacCarthy. "Preliminary report on tests of the application of geophysical methods to Arctic ground water problems," Open File Report, U.S. Geol. Survey, 1964.
- [30] F. A. Crowley, R. E. Hansen. "Seismic Measurements in Permafrost Areas of Interior Alaska," [abs.] Alaskan Sci. Conf. 7th Proc., 1956, p. 54.
- [31] F. A. Crowley. Personal comm., 1959.
- [32] W. J. Rooney, K. L. Sherman. "Earth Current Measurements at the College-Fairbanks Polar Year Station," Terrestrial Magnetism and Atmospheric Electricity, Vol. 39, 1934, pp. 187-202.
- [33] E. M. Westcott, V. P. Hessler. "The Effect of Topography and Geology on Telluric Currents," Geophys. Res., Vol. 67, No. 12, 1962, pp. 4813-4823.
- [34] G. R. MacCarthy. "Natural Earth Potential Anomalies near Point Barrow, Alaska," [abs.] Am. Geophys. Union Trans., Vol. 36, No. 3, 1955, p. 519.
- [35] H. R. Joesting. "Magnetometer and Direct-Current Resistivity Studies in Alaska," Am. Inst. Mining Metall. Petroleum Engrs. Trans., Vol. 164, 1945, pp. 66-87.
- [36] A. U. Meyer, Hans Roethlisberger. "Electrical D-C Resistivity Measurements on Glacier Ice near Thule, Greenland," U.S. Army CRREL Tech. Rept. 87, 1962.
- [37] T. Hatherton. "Electrical Resistivity of Frozen Earth," J. Geophys. Res., Vol. 65, No. 9, 1960, pp. 3023-3024.
- [38] E. M. Westcott, V. P. Hessler. "Effect of Topography and Geology on Telluric Current," Alaska Univ. Geophys. Inst. Sci. Rept. No. 3, 1960.
- [39] L. Y. Faust. "A Velocity Function Including Lithologic Variations," Geophys., Vol. 18, No. 2, 1953, pp. 271-288.
- [40] J. C. Cook. "RF Electrical Properties of Salty Ice and Frozen Earth," J. Geophys. Res., Vol. 65, No. 6, 1960, pp. 1767-1771.
- [41] B. N. Dostovalov. "Elektricheski karakteristiki meizlyk porod," Akad. Nauk SSSR, Trudy Inst. merzlotovedeniia im. V. A. Obrucheva, Vol. 5, 1947, pp. 18-35.
- [42] M. R. J. Wyllie. "The Fundamentals of Electric Log Interpretation," 2d ed., revised, Academic Press, New York, 1957.
- [43] H. M. Mooney, W. W. Wetzel. "The Potentials about a Point Electrode and Apparent Resistivity Curves for a Two-, Three-, and Four-Layer Earth," Minn. Univ. Press, 1956, 243 loose sheets of reference curves.
- [44] G. D. Hobson. "Seismic Exploration in the Canadian Arctic Islands," Geophys., Vol. 27, No. 2, 1962, pp. 253-273.
- [45] D. F. Barnes. "Seismic Velocity Measurements at the Ogoruk Creek Chariot Site, Northwestern Alaska," in Geol. Investigations in Support of Project Chariot in the Vicinity of Cape Thompson, Northwestern Alaska—Prelim. Rept., U.S. Geol. Survey TEI-735, 1960, pp. 62-78, issued by U.S. Atomic Energy Comm. Tech. Inf. Service, Oak Ridge, Tenn.
- [46] F. R. Collins. "Test Wells, Umiat Area, Alaska, with Micropaleontologic Study of the Umiat Field, Northern Alaska," by H. R. Bergquist, "U.S. Geol. Survey Prof. Paper 305-B, 1958, pp. 71-206.
- [47] F. M. Robinson. "Test Wells, Simpson Area, Alaska, with a Section on Core Analysis, by S. T. Yuster," ibid., Paper 305-J, 1959, pp. 523-568.

INSTRUMENTS FOR TEMPERATURE MEASUREMENTS IN PERMAFROST

B. L. HANSEN, U.S. Army Cold Regions Research and Engineering Laboratory

The scope of this paper is restricted to three of at least 12 temperature-measuring methods using probes in thermal equilibrium with media whose temperature is to be measured. The requirements that must be met in the installation of probes to measure the temperature of permafrost within specified limits of error have been considered by others [11, 12].

The three methods discussed are: (a) Resistance thermometers, (b) thermocouples, and (c) semiconductor techniques (thermistors).

Equipment described under each of these three headings is suitable for use in a polar environment in that it is reasonably robust, portable, and accurate when subjected to and used over a wide range of ambient temperatures.

RESISTANCE THERMOMETERS

Operation of resistance thermometers is based on the fact that the electrical resistance of most metals increases with increased temperature.

The first use of this principle is credited to Siemens in 1871, and Callandar laid the foundations of modern resistance thermometry in 1887.

Resistance thermometers are the most accurate of all temperature-sensing devices and the International Temperature Scale is defined in terms of the resistance of a platinum thermometer from the oxygen point (-183°C) to the freezing point of antimony (630.5°C).

The first resistance thermometer system made specifically for use in a polar environment was built by Leeds & Northrup for the United States Antarctic Service Expedition of 1939-1941. This system has been described by Wade [1] and is very similar to the equipment used by U.S. glaciologists in the International Geophysical Year program. Similar equipment was used until 1961 in Alaska by the U.S. Army Corps of Engineers Arctic Construction and Frost Effects Laboratory (now U.S.A. CRREL) [2] to obtain ground temperature data at various test sites. The equipment is still being used in Antarctica (Fig. 1). Fig. 2 is a theoretical diagram of the system.

The resistance thermometer (T) consists of a coil of fine copper wire wound on a metal bobbin which is soldered to the inside of a protective brass sheath. The sheath also provides a moisture seal and strain relief for the 3 lead, (A, B, and C) rubber covered cable which connects the resistance thermom-



Fig. 1. Triple-range temperature indicator and resistance thermometer

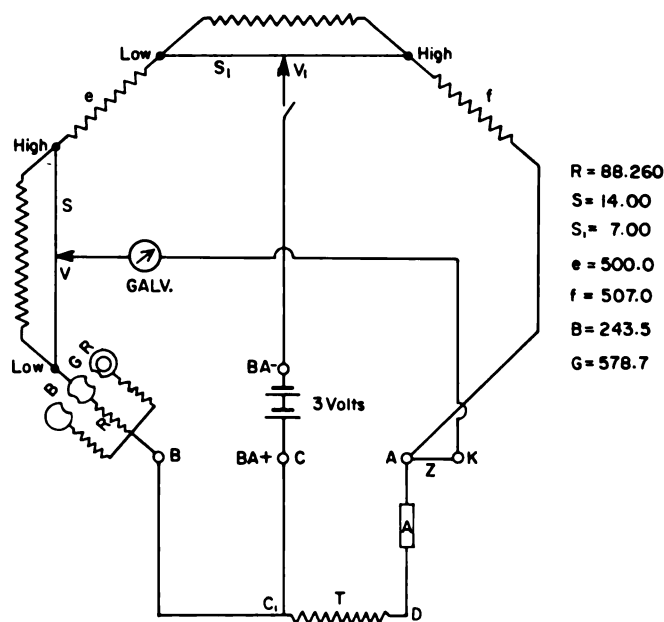

Fig. 2. A double-slidewire bridge

eter to the temperature indicator. These thermometers have a resistance of 100 ohms at 25°C , and their resistance-versus-temperature curves match to within 0.1°C over the range -65° to 25°C . The thermometers were obtained with hermetically sealed leads 10 to 100 ft in length.

The temperature indicator is a dual slidewire Wheatstone bridge. The slidewires (S and S_1) are mounted on a drum which is calibrated to indicate the temperature. The slidewires are so proportioned that the bridge ratio is always unity; i.e., VV_1 is always equal to AV_1 .

At balance $VB + BC_1 = (AV_1/VV_1)(T + AD)$; if the resistances of the leads (BC_1 and AD) are equal, the resistance of the arm (VB) is equal to the resistance of the thermometer (T) regardless of the length of the leads.

The temperature indicator has three ranges: The low (black) range is from -65° to -30°C ; the middle (green) range is from -35° to 0.4°C ; and the high (red) range is from -5° to 30.5°C . The ranges are selected by a plug and block system across coil R.

The scales are graduated in intervals of 0.2°C , the indicator can be balanced and temperatures estimated to 0.02°C , and the indicator has a limit of error of 0.1°C when operated at any ambient temperature within its range.

The combined limit of error of this resistance thermometer system is $\pm 0.2^{\circ}\text{C}$. However, Wade reports "Tests with the thermometers, before they were shipped to the Antarctic, showed that temperature measurements made with any one of the resistance coils connected to either of the indicators were accurate to better than 0.1°C throughout the range -70° to $+10^{\circ}\text{C}$." Our own tests indicate a probable system error of $\pm 0.1^{\circ}\text{C}$.

The final element to be considered is stability. Temperature indicators which have been in service eight years still meet the specified limit of 0.1°C (in fact the average deviation is 0.04°C) throughout the range. Resistance thermometers have been calibrated, installed in the Antarctic snow and ice for several years, and then returned to the Bureau of Standards for calibration. These thermometers are still matched to within 0.15°C and the deviation at the ice point is not more than

0.2°, 17 years after they had been manufactured. The drift from the original calibration is less than this.

This resistance thermometer system is truly rugged, portable, self contained, and stable over a long period of time. It provides a temporary sensitivity of 0.02°C, and is certainly accurate to within ±0.2°C, and probably to within 0.1°C, when used at any ambient temperatures within its range.

THERMOCOUPLES

The principles of thermoelectric thermometry are adequately described in a paper on that subject by Roeser [3].

The use of thermocouples to measure temperature in permafrost is usually restricted to applications where great accuracy is not required, the cost of a resistance thermometer installation is not warranted, or the small size and flexibility of the thermocouple is required.

The system to be described consists of one or more copper constantan thermocouples, a reference junction in an ice bath, and a portable precision potentiometer calibrated in both temperature and millivolts. It has been extensively used both in the laboratory and in the field.

Fig. 3 is a circuit diagram of the portable precision potentiometer, Rubicon Model 2735-Special. The symmetry of the circuit, the nearly equal ohmic value and identical construction of the coils comprising the two branch circuits is believed to be responsible for the excellent performance of this instrument over a wide range of ambient temperatures. The slidewire on these instruments was calibrated by Rene Ramseler of USA CRREL after the instruments had come to thermal equilibrium at temperatures from -10° to 28°C and found to be within the specified limit of error of 10 μV. The zero shift did not exceed 3 μV.

The slidewire is calibrated in 0.5° increments from -80° to 26°C for copper constantan presuming the use of a reference junction at 0°C and in 20 μV increments from -2.78 to 1.04 mV. The instrument can be balanced to, and temperatures estimated to, 0.1°C when used with thermocouples whose resistance does not exceed 50 ohms.

The scale covers the range to -80°C so that the calibration of thermocouples can be checked at the carbon dioxide point [4] and/or at the freezing point of mercury. By calibrating the thermocouples with the instrument at the temperature

at which it will be used, it is possible to make measurements with a limit of error of 0.2°C.

The equipment is portable. Reasonable handling is necessary to avoid breaking the galvanometer suspension and an ice bath is required for the reference junction.

SEMICONDUCTOR TECHNIQUES (THERMISTORS)

Several areas of investigation, such as the geothermal studies of permafrost and the stability of structures built on and in permafrost or ice, require temperature data where 0.01°C is a significant figure.

The suitability of thermistors for such application has been adequately demonstrated by the United States Geological Survey [5].

Friedberg [6] has presented a concise summary of the use of semiconductors as thermometers which cites most of the useful references known to the author.

The present practice in the use of thermistors for precise temperature measurements is to select a suitable thermistor type for the particular application; procure a few more than will be required; age them, discarding those which are not stable; calibrate those remaining over the required range several times; then prepare resistance versus temperature tables from the calibration data. Temperature observations are made by measuring the resistance of the thermistor and converting the observed resistance to a temperature using the appropriate table of formula.

Selection

Usually a glass probe or bead type is chosen whose resistance will not exceed 100,000 ohms or be less than 1000 ohms over the desired temperature range.

AGING

The thermistors are aged by cycling them between the boiling point of water and the sublimation temperature of carbon dioxide, measuring the resistance at the triple point of water after each period at the boiling point. Those thermistors which are stable to within 0.002°C at the triple point are calibrated.

CALIBRATION

The resistance of the thermistor is measured using a 5-decade Wheatstone Bridge whose calibration is known to 0.01%. Measurements are made at fixed points such as the transition temperature of sodium sulfate (32.38°C), the triple point of water (0.01°C), and the freezing point of mercury (-38.87°C), or in controlled temperature baths. The calibration standards are platinum resistance thermometers certified by the National Bureau of Standards.

PREPARATION OF TABLES

The resistance measurements at various temperatures are used to determine the three constants in the formula $\log R = A + B/(T + \theta)$ where R is the thermistor resistance at the temperature (T); A, B, and θ are constants. Use of this formula was proposed by Bosson [7] and Swartz [8]. Leonard E. Stanley of USA CRREL has prepared a program for the Bendix G-15D computer which is used to evaluate the constants and prepare tables of R as a function of T at 0.1°C intervals over the range -40° to 35°C.

The question of how well this formula fits the thermistor data has been examined by Clark [9] and Ross [10]. Ross found that the deviation of computed from observed temperatures does not exceed 0.025°C over the tabulated range and that the deviation curve would be applicable to all thermistors of the same type calibrated at the same temperatures. The deviation could be reduced to less than 0.01°C by calibrating at 15°C intervals over the desired range, although it is probably simpler and more economical to include the correction

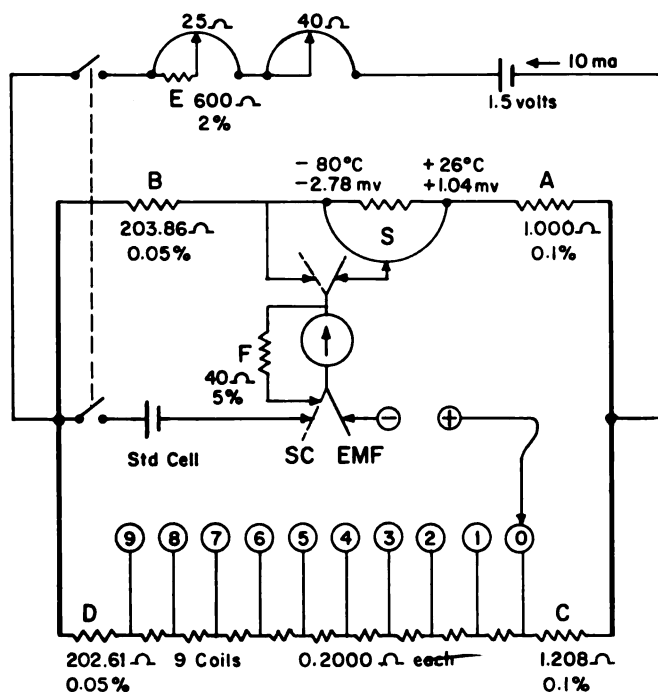

Fig. 3. A portable thermocouple potentiometer

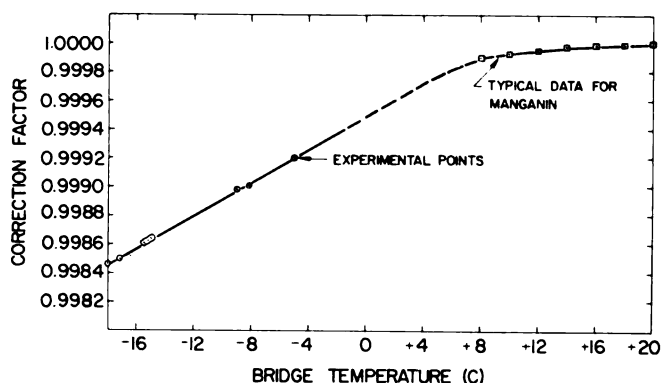

Fig. 4. Temperature correction curve for G-1 Mueller bridge

that has already been determined in the computer program.

The problem of making resistance measurements of the required accuracy in the field has been a bit more difficult to solve.

The usual laboratory equipment used to measure resistance, or electromotive force, contains a number of wire-wound coils which determine the calibration of the equipment. These coils are usually wound with manganin wire, whose resistance is nearly independent of temperature under normal laboratory conditions.

Fig. 4 shows how the bridge correction factor for a G-1 Mueller bridge with manganin coils varies as a function of temperature. The significance of this factor depends, of course, upon the accuracy required. As an example, if this bridge was used in conjunction with a 100 ohm copper resistance thermometer, the measured values would be in error by 0.25°C at an ambient temperature of -10°C, increasing to 1°C at an ambient temperature of -50°C.

If the same bridge were used to measure the resistance of a thermistor, the resistance error would be the same but the equivalent temperature error would only be one-tenth as great; this is, of course, a major reason for using thermistors. The error is still ten times larger than the 0.01°C, which is desired as a significant figure.

Some temperature and stability tests on resistance coils wound with Evanohm wire showed that if a Wheatstone bridge had similar coils for its ratio arms and the two highest decades (1000 ohms and 100 ohms) the necessity for bridge corrections could be eliminated.

A prototype facility for measuring the resistance of thermistors was built and shipped to Leeds and Northrup, who had agreed to build several similar units.

The special Wheatstone bridge facilities (Fig. 5) which are designed to measure the resistance of thermistors in a polar environment have an input connector and probe selector switch so that measurements can be made on a cable containing a number of thermistors, an adjustable and metered bridge voltage so that self heating of the thermistors can be limited to an acceptable value (not over 0.001°C), and an electronic null detector. The ratio arms and the two highest of the five decades are made of Evanohm wire. The equipment has a limit of error of 0.05% when operated at ambient temperatures in the range of -30° to 30°C. This is equivalent to an error of ±0.01°C in the temperature measurements.

Field tests have shown that it is possible to make tempera-

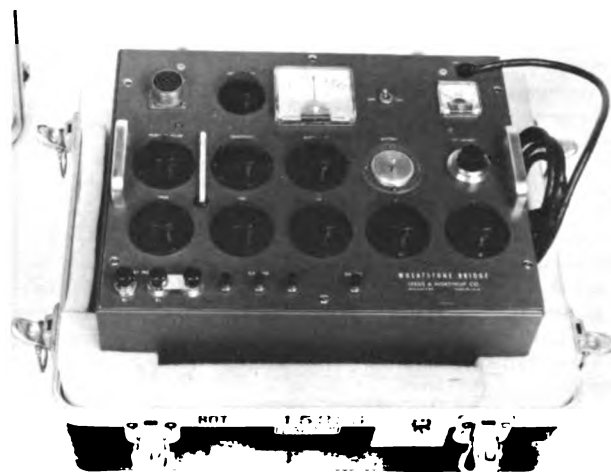

Fig. 5. Wheatstone bridge facility for thermistors

ture measurements in permafrost with a limit of error of 0.02°C and a sensitivity and reproducibility of 0.002°C using the instrumentation which has been described.

REFERENCES

- [1] F. A. Wade. "Sub-Surface Temperature Measuring Equipment," *J. Glaciology*, Vol. 1, No. 2, 1947, pp. 73-74.
- [2] G. W. Aitken, C. W. Fulwider. "Ground Temperature Observations, Aniak, Alaska," U.S. Army CRREL, *Tech. Rept. 101*.
- [3] W. F. Roesser. "Thermoelectric Thermometry," *Temperature—Its Measurement and Control in Science and Industry*, Reinhold Pub. Co., 1941, 3rd printing, 1952, Vol. 1, pp. 180-205.
- [4] R. L. Scott. "The Calibration of Thermocouples at Low Temperatures," *ibid.*, Vol. 1, pp. 206-218.
- [5] A. H. Lachenbruch, et al. "Temperature in Permafrost," *ibid.*, Vol. 3, 1962, pp. 791-802.
- [6] S. A. Friedberg. "Semiconductors as Thermometers," *ibid.*, Vol. 2, 1955, pp. 359-382.
- [7] G. Bosson, F. Gutman, L. M. Simmons. "A Relationship Between Resistance and Temperature of Thermistors," *J. Appl. Phys.*, Vol. 21, Dec. 1950, pp. 1267-1268.
- [8] J. H. Swartz, et al. "A Preliminary Report on Geothermal Investigations in Naval Petroleum Reserve No. 4," *U.S. Geol. Survey Rept.*, 1952.
- [9] L. E. Clark, Jr. "Report on the Determination of Exactness of Fit of Western Electric Type 1'E Thermistor to the Equation $\log R = A + B/(T + \theta)$ and $\log R = A + B/(T + \theta) + CT$," *Tech. Memo. No. M-1951*, U.S. Army Signal Engr. Lab., Fort Monmouth, N. J., 26 Feb. 1958.
- [10] C. W. Ross. "Thermistor Characteristics and Direct Reading Temperature Bridge," unpublished data, 19 Oct. 1960.
- [11] W. M. Rohsenow, J. A. Clark, P. C. Van Alstyne. "Analysis of Errors in Ground and Air Temperature Measurements," U.S.A. ACFEL, *Tech. Rept. 52*, 1954.
- [12] J. P. Cunningham, W. M. Rohsenow. "Electrical Analog Study of Errors in Ground Temperature Measurement," U.S.A. ACFEL, *Tech. Rept. 70*, 1960.

DEW LINE SITE SELECTION AND EXPLORATION

T. A. HARWOOD, Defense Research Board, Department of National Defense, Canada

Construction and site exploration in northern regions is affected by three main factors: Logistics, climate, and terrain. This applied particularly to site exploration for the DEW line.

The DEW Line was sited generally along the 69th parallel. It was urgent to construct airfields and buildings in the summer of 1957. Thus, site surveys, selection, and exploration had to be made in late winter and spring of the same year, i.e., between mid-February and mid-June.

The sites extended for 2000 miles from the Canadian-Alaskan border to the edge of Baffin Bay. Site exploration parties experienced a wide climate range as they moved along the line and also as the season progressed into summer. Temperatures in the beginning were severe, (-46°F in central Canada in early March), but moderated to the mid-30's in June. Snow cover ranged from a few inches on the central sites to a few feet on Baffin Island.

Soil conditions ranged from alluvial silts mainly in the west, disintegrated limestones and shales (in situ soils) in the central regions, to bare metamorphosed rocks in the east. On certain airfield sites in the east, valleys, because of marine submergence, were filled with a material similar in many ways to the Leda clays met with in the Ottawa Valley. All sites were underlain by permafrost with the active layer varying from 6 ft in the west and east to as little as 3 ft in some central sites. Permafrost was in all cases continuous and of unknown thickness.

SITE CRITERIA

For the DEW Line, three basic types of stations were used. Building construction, except towers, was of the same basic modular design; these modular buildings were extended by the addition of other modules. Hence, the word train (train of modules) for a building complex was developed.

All airstrips had identical design criteria (USAF AFCIE-P, March 1955), differing only in length.

Sites were limited geographically by the required spacing of stations on the line with upper and lower limits to this spacing. This left about 10 sq miles in which sites could be chosen.

Wherever possible, maps and airphotos were used to pinpoint desirable sites, one criteria being that the site should be on the highest hill. However, in regions such as the Pelly Bay area, one of the most inaccessible sites, no vertical or other suitable portion of an oblique photograph was available for contouring so that site selection had to be made on the spot.

SITE SELECTION AND SURVEY TEAMS

Six site survey teams were formed by the consulting engineers (Knappen, Tibbets, Abbott, and McCarthy). Included were a party chief (geologist or surveyor), surveyor, soils engineer or geologist, driller, cook, and cook's helper and handyman. Most parties had an aircraft thus adding a pilot and mechanic. Each party was completely self sufficient and theoretically independent of the major contractor who followed them into the field.

Since climate and geological conditions were so harsh, site survey criteria sheets were made up. These sheets asked a series of questions that were divided into lists for each major unit on the site, i.e., train, towers, garage, roads and airstrips, water supply, and sewage. (See Appendix, "Site Criteria Book," at end of this article.)

Before going into the field the chief engineer of the consulting company briefed each party on the optimum answers to each question and the relative importance of each question. Sites within the site region were chosen by the party on the basis

of these questions and answers. That the system worked well is shown by the fact that of over 40 sites only two airfield locations were changed, one for proximity (a reduction in length which brought the airstrip closer to the train) and one for meteorological reasons.

FOUNDATIONS

Since the line extended over 2000 miles, it was quite apparent, due to geological provinces, that soil conditions might be classed into three basic types: (a) Perennially frozen silts with ice-lenses of some magnitude; (b) in situ developed soils and screes with little ice-lensing; and (c) bare rock, perhaps in places with "pushups." It was therefore summarily decided by the general contractor and consulting engineer before going into the field that there would be three main types of foundation. These were to be: (a) Steamed-in piles; (b) pads with mud sills; and (c) sills bolted to the rock. All buildings were to have an airspace and be 4 ft off the pad (or rock) to minimize thawing effect and snowdrifting.

This arbitrary distinction in foundation design broke the line into three major construction units: (a) Pile foundations from the U.S.-Canadian border to Liverpool Bay east of the Mackenzie River; (b) pad foundations from Liverpool Bay to central Baffin Island (with some exceptions); (c) rock bolted foundations generally down the east coast of Baffin Island. For this reason the soil survey for building foundations could be relatively simple—and considering climate, frozen ground, and snow cover—had to be.

AIRSTRIPS

In the case of airstrips the first consideration was approach angles; second, the proximity of masts and antenna arrays. When those two main criteria had been considered it was possible to assess such things as grades, fill, fill material available, and finally, soil conditions. Within limits, soil conditions were completely disregarded if sufficient granular fill were available that, in the estimation of the site planners, would allow a subgrade thickness to be built up to protect the natural permafrost or even induce permafrost into the emplaced material itself.

In some places beach material was laid directly over lakes or lagoons, covering about a foot or so of ice frozen to the bottom. Here the idea was to develop quickly an airstrip for spring and early summer so that construction of building shells could continue throughout the summer before a sealift. In at least one case, fill material was placed over 4 ft of ice. This artificial ice-lens has remained, although some slumping of the material has occurred at the edges of this particular airstrip. Generally, soil and permafrost conditions were not considered the most important factor in the choice of an airstrip location, although every effort was made to choose the best soil conditions. Disregarding alignment, approach angle and grade were the criteria which received the most careful consideration and attention. Proximity and source of granular material then followed, since it was felt that with enough material the permafrost problem could be overcome relatively easily, though in some cases rather expensively.

TOWER AND ANTENNA FOUNDATIONS

At the time of the site surveys the design of the towers and parabolic antenna had not been decided; therefore, only descriptions of tower sites and soil conditions were needed. In the end all towers were of the ball-joint (single pivot) type so that slight movements of the foundations and thus any misalignment of the dishes could be and were corrected by adjust-

ment to the dishes. Requirements for the foundations of the tropospheric scatter antenna were more severe.

Tower and antenna bases were put on bedrock where possible. Where not possible, footings that varied with antenna heights were placed on concrete blocks with two-thirds of the mass below maximum depth of the active layer. This approach seemed satisfactory.

WATER SUPPLY AND SEWAGE

About 50% of the stations were in limestone country, mostly glaciated. Adequate water supply was a definite problem here since all the lakes were uniformly shallow. At one main site the lake was only 7 ft deep and frozen to the bottom, so that in the first two years water in late winter had to be procured by thawing ice. Later this lake was deepened by a dam toward the outlet.

Another problem in these limestone areas was sewage disposal. In most cases the lakes and lagoons were nearly all at the same elevation and were assumed to be connected by jointing in the limestone when the permafrost thawed, particularly at the end of the summer when the active layer had reached its greatest thickness. Every effort was made, therefore, to discharge sewage into the sea. In the end, and certainly in all cases of seacoast stations, this was done. Fortunately, the inland stations were all on Pre-Cambrian rock, and here lakes are generally in bowls or rock depressions usually separated by a clear cut divide. Most stations were also at a considerable elevation and always on a spine. Thus, separation of sewage from water supply was relatively simple.

SURVEY MONUMENTS

Survey monuments if not properly emplaced in areas of deep soils or silts could easily become dislodged and in some cases completely lost by being buried in the soil if they collapsed. Two types were used: One type was a cruciform engraved in very large boulders and described carefully in the field notes and appendixes to site criteria; the other type was simply a sharpened steel rod 0.25 in. by 5 ft that was driven into the ground to its full length. Instructions were given to the contractor that in late summer another 7 or 8 ft rod was to be driven in the same spot. These rods were also carefully described, and cairns were later erected over the rods; the best type of cairn was a pentagonal array of 45 gal drums (two high). So far as is known these markers or monuments were satisfactory.

ACTUAL SITE SELECTION IN THE FIELD

As mentioned, sites were in three geological provinces: Deep silts, limestones overlaid by shattered rock and thin soils, and Pre-Cambrian rocks—mainly glacial scoured and usually bare. These facts were known in the site planner's office at Churchill, Manitoba, and permitted some preplanning. Here is an outline of survey procedure in the field.

Initially the available airphotos (mainly obliques) were studied in the office. Most party chiefs and members were completely unfamiliar with photointerpretation in Arctic and permafrost areas and, therefore, had little feel for what they saw. Intensive briefings were given as to what to avoid where possible. Instructions were also given to disregard any permafrost features where large quantities of gravel were available. Party chiefs were told to use the photos purely as terrain guides and in all circumstances to follow the criteria sheets.

Once on the ground after being flown into the site area, the party set up camp as close to the proposed site as possible. This was not easy, since the highest point often had to be chosen from the air before landing; sometimes a considerable effort went into landing and finding a close camp site.

Immediately after setting up housekeeping, the group re-examined the airphotos and moved off to the highest point. This was confirmed by a theodolite horizon check. A survey was made of snow conditions to determine prevailing wind; this and an assessment of snow drifts set the alignment of the

building and airstrip. The main dimensions of the building were then paced out and indicated by pegs. The geologist or soils engineer with the driller could then start digging in the snow to examine the underlying soils or rock. This preliminary exploratory work basically decided the foundation type. Then a quick survey was made for horizon angles since the inter-visibility of stations for microwave communication determined the tower height, which in turn determined the minimum distance of the runways from the station.

At this stage with a fairly precise idea of tower heights, it was possible to examine potential airstrip sites. The USAF criteria for airstrips can be simplified by initially looking at five items: (a) Approach angles, (b) distance from proposed towers, (c) alignment to prevailing wind (the spring snowdrifts), (d) grades, and (e) sources and proximity of fill (must be granular). Once these were satisfied all else followed. Only cursory attention was paid initially to soil conditions.

When a suitable airstrip site was found, it was, as in the case of the buildings, paced and crudely staked, and the soils crew was put to work.

The main party then returned to the site and roughed in other facilities such as garages, tanks, and tower sites. The soil crew followed and examined each site. Finally, a water supply was chosen; after this a sewerline could then be crudely aligned.

After sites were selected the actual survey began and the construction was properly staked. With this done and the soil surveys complete, foundation criteria could then be suggested and were added as appendixes to the site criteria sheets.

EXAMPLES OF SITES

It is worthwhile now to look at some actual examples. The airphotos used as illustrations were taken after the stations were built and are representative of the three types of conditions mentioned earlier.

Fig. 1 shows a station in the western Arctic, west of the Mackenzie River and close to a place called "Shingle Point." This implies that there was plenty of beach material available. The site was on deep, silty, glacial materials underlain by permafrost, with no rock outcrops. Pile foundations were used for the building. The airstrip is gravel or beach material laid on the undisturbed surface. Note that there are very few vehicle tracks off the road or airstrip. This is an indication of the extremely difficult summer soil conditions: Note the polygons and general lack of surface drainage.

Far to the east of the above site, in Melville Peninsula and



Fig. 1. Station on western Arctic coastal plain near Shingle Point. Note characteristic permafrost morphology for this area

on Pre-Cambrian rocks is another small station (Fig. 2). The station is sited on bare rock, but here a gravel pad was used. Unfortunately, the airstrip had to be located on a side slope of glacial tills with strong downslope soil striping or solifluction. The problem was to cut the side slope (into the permafrost) and to backfill with sufficient gravel for adequate lateral drainage so as to prevent the uphill side of the airstrip from flowing over the strip.

Since the strip was limited to small planes, the problem was solvable. However, had larger aircraft been used, another location would have been necessary.



Fig. 2. Station in Melville Peninsula. Note development of airstrip on slope. Soil flow is indicated by striping

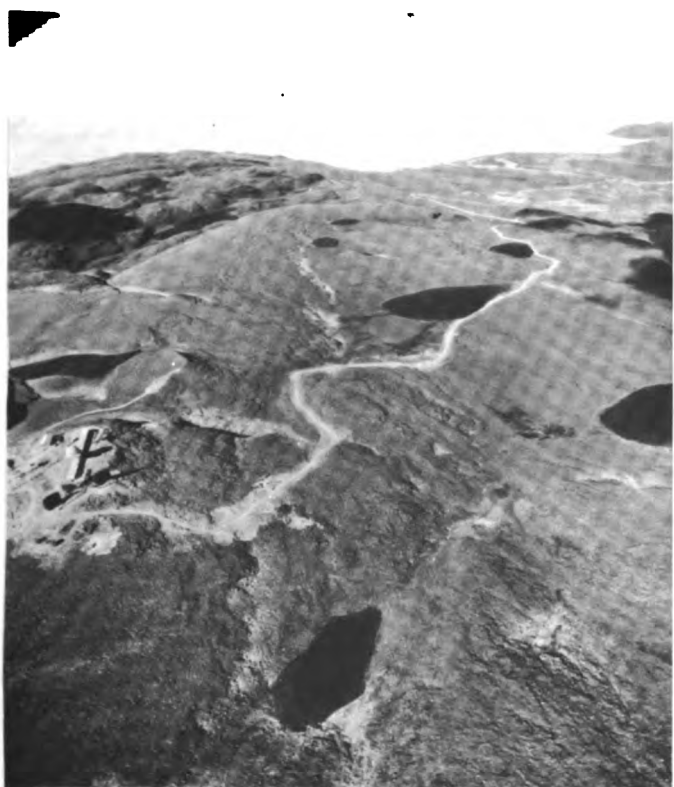

Fig. 3. Site in Melville Peninsula. Note airstrip in background on end moraine which has blocked the valley



Fig. 4. Airstrip of station in Fig. 3. Note material pulled in from moraine. Road follows bare rock surface



Fig. 5. Station site in Foxe Basin. Note alignment of the longitudinal axis of buildings to the prevailing wind so as to prevent drifting between buildings

In Fig. 2 one can see also the sewerline leading over the divide separating it from the water supply.

At another site (Fig. 3) the station is again located on bare rock and is on a mountain top several miles from the coast. Here a gravel pad rather than rock bolts was advised. Unfortunately, the contractor did not pay sufficient attention to the quality of his gravel, accepting too many fines. This is the only station where heaving occurred on the pad, distorting the buildings. The airstrip is on the seacoast. No permafrost problems were foreseen at the airstrip site and none were encountered since the airstrip was placed chiefly on a well sorted end moraine, and most of the morainic material was drawn into the airstrip.

One of the larger stations (Fig. 4) was built on the eastern seacoast of Foxe Basin. Here the highest point was on an old gravel beach at an elevation of 25 ft. Site selection was simple, the main problem being to align the airstrip and place it as near as possible to the building (Fig. 5). This was done

in the following manner. In this area along the coast are many current spits and raised beaches, and apparently the current pattern in the Foxe Basin has not changed much in time. About 5000 ft north of the station an old (relict) current spit (some 16 ft high, 500 ft long, and 150 ft wide) extended away from the sea but into the prevailing wind and inland into an old lagoon. On the far side of this lagoon lay another relict beach. The unfrozen gravels of the spit were simply pulled by scrapers into the old lagoon and toward the far beach; no attention was paid to permafrost conditions. The ledge was probably only 5 or 6 ft beneath the surface, and when a reasonable thickness of gravel was laid to the other beach, the scrapers worked material from this beach onto the strip. At the center the fill reached a thickness of 7 ft overlaying some 2 to 4 ft of ice. So far as is known this ice still underlays the strip. The choice of location so facilitated construction that the strip ac-



Fig. 6. Station site as in Fig. 5. Note waterline. Sewerline here discharges seaward



Fig. 7. Station in Foxe Basin. Note how layout of buildings, airstrip, and roads has been incorporated into the raised beaches. Level area to right of airstrip is entirely underlain by peat



Fig. 8. Coastal station in Baffin Island. The cliffs here are about 1200 ft high



Fig. 9. Airstrip of station in Fig. 8

cepted aircraft (up to a DC 3) three weeks after the start of work. Fig. 6 shows the dam which later deepened the water supply lake. At the time of survey it was frozen (7 ft) and no other suitable source of potable water near the station was found.

On an island farther east, possibly the worst permafrost and site conditions were encountered west of Liverpool Bay. Here, luckily, the highest point (20 ft) was right next to a suitable, though again shallow, water supply and was actually a peak of an old beach (Fig. 7). This beach was connected rather sinuously with an esker, which in turn has been incorporated into another raised beach. Fortunately, the esker was

almost aligned into the prevailing wind. While the esker was too winding to be used as the actual strip alignment, it could be and was used as a nearby source of granular material, making airstrip construction very easy. On this island there was little drainage. The airstrip was underlaid by 4 ft of peat (Cate - gory 14, Radforth), probably induced in the past by the extraordinary drainage conditions. All roads were also built on the raised beaches. The vertical photograph shows how roads, airstrip, and buildings are related to the esker and raised beaches.

Finally the most easterly station is on the Baffin Bay coast (Fig. 8). Here, perched on a high cliff and subjected to high winds, the gravel-pad technique was again used, but the buildings were also bolted to the rock. Only in a few stations north of this, in those perched on the high cliffs, were the rock-bolt foundations used.

The airstrip in Fig. 9 posed a problem and had to be moved three times for meteorological reasons, finally being sited over eight miles away from the station. The location finally chosen was a fairly flat plain underlaid by till, fairly well drained with little or no soil stripping. No problems were encountered in building this strip, since granular material was available.

CONCLUSIONS

The DEW Line was built in haste and with great urgency; therefore, it was considered by the contractors and engineers acceptable to take risks. With this in mind possible permafrost problems became rather secondary considerations, the primary consideration being location of buildings and, in particular, towers with regard to the over-all requirements of the line, and the alignment and approaches to airstrips.

Study of airphotos showed where bad permafrost conditions might be expected and avoided; but generally the instructions were to disregard soil conditions, accepting the principle that if problems did arise they could be rectified after the Line was in operation. The facts support this procedure, for so far as is known only one station experienced damage from frost action (not permafrost), and while on one or two airstrips some slump later occurred, this was quickly corrected.

Special precautions were taken in designing tower foundations to prevent misalignment, and again, so far as is known, no problems followed.

The siting of these stations could, therefore, be called a purely pragmatic approach to permafrost. It was there, it had to be dealt with, and it was dealt with in the classic manner—by using thick gravel pads or piles. One thing is certain: Permafrost did not slow up site surveys or construction.

It must be realized, however, that, in all cases, building trains were light; and for the remaining facilities, there were very few units that were heated or had foundation problems that could not be rectified by adding more gravel.

The DEW Line is quite a remarkable series of installations. Each visitor is surprised that site exploration was possible in the late winter and spring.

Published with permission of the Chairman, Defense Research Board.

APPENDIX: SITE CRITERIA BOOK

Answer all questions in as much detail as possible. Explain why questions are not answered.

Train Site

Train size and type (state). Observed direction spring winds. Buildings are aligned to this wind direction. If answer to above is no, give reason. Is site well drained. Topography of

train site; give elevation. Foundation and soil conditions at train site. Approximate quantity of granular material required for pad.

Water Supply

Show on map primary source. Thickness of ice; depth of lake. Water tastes fresh. Sample was taken. Elevation of water surface. Show on map secondary source. Thickness of ice; depth of lake. Water tastes fresh. Sample was taken. Elevation of water surface.

Sewage Disposal

Liquid pumped; solids pumped. If pumped will material drain away. Can it contaminate the camp water supply. Can it contaminate the water supply for others. Show on map suggested sump area.

Oil Storage

Number and type of tanks. Desired location. Desired distance from building. Elevation tank site. Contamination from burst tank. Topography of tank site. Foundation and soil conditions at tank site.

Garages

Number. Doors face desirable northerly. Topography of apron site. Approximate quantity of granular material required for pad. Foundation conditions at garage site.

Horizon Profile

Azimuth. Remarks.

Towers

Location of tower. Tower height. Ground elevation at base of tower. Great circle azimuth to next station. Antennae oriented on great circle azimuth. Required distance from train. Foundation conditions at tower site. Foundations for anchorages. Describe topography at tower site. Repeat above for antenna site.

Roads

Give a general description of road layout and topography. Show on map location of fill and cuts. Approximate quantity of material required. Can this material be obtained along alignment. Culverts required.

Airstrip (USAF Criteria, AFCIE-P, March 1955)

Orientation desired. Length required; overrun required. Longitudinal grade. Width. Extension possible/not possible. Topography of airstrip site. Culverts under airstrip required. Glide angle. Approximate quantity of granular material required. Wind direction observed.

Apron (USAF Criteria, AFCIE-P, March 1955)

Size. Availability, yes or no. Topography apron site. Approximate quantity of granular material required.

Hanger

Type. Doors face northerly; if not state reason. Granular fill required for alignment with runway and pad, and for hanger floor. Topography of site. Foundation and soil conditions at site.

Field Drawings

Has site plan been completed; date. Has airstrip plan been completed; date. Has site area plan been completed; date. Have site notebook and site plans been forwarded to base office: State number of items and by what means; state plane no. or pilot. Date. Date site survey conducted: Party; party chief.

CORE DRILLING IN FROZEN SOILS

M. JUUL HVORSLEV and T. B. GOODE, U. S. Army Engineer Waterways Experiment Station, Vicksburg, Mississippi

Greater difficulties are encountered during core drilling in frozen soils than in frozen rocks, and the former has been under active development only in the last decade. Satisfactory cores of frozen soils have been obtained under favorable soil or temperature conditions or both, but it is not yet possible to formulate definite and detailed recommendations for core drilling in frozen soils under all conditions. The objectives of this paper are to suggest possible procedures and to call attention to general requirements and needed research. The principal basis for these suggestions is core drilling operations in frozen glacial deposits at TUTO (Thule Take-Off) near Thule, Greenland, during 1956 and 1957 by the U. S. Army Engineer Waterways Experiment Station, which are described by the authors in reports of limited distribution. Additional data were obtained from the various papers and reports shown in the list of references and from visits to and discussions of core-drilling operations by the U. S. Army CRREL. Drilling in frozen rock is not discussed.

FROZEN SOILS

The soils in arctic and antarctic regions are primarily silts, sands, gravels, glacial tills, and organic materials. Some properties of these frozen soils are very important for core drilling.

The short-term strength of frozen soils and adhesion between embedded stones and the frozen matrix increases with decreasing temperature (Fig. 1). Therefore, low temperatures facilitate core drilling and vice versa.

The freezing point is depressed for water near the particles and in capillaries of fine-grained soils. Some of the water in these soils remains unfrozen at temperatures appreciably below 0°C (Fig. 2). Unfrozen water decreases strength and facilitates straight drilling and drive sampling, but tends to

increase breaking and thawing of the soil during core drilling.

Space between grains in some frozen soils is completely filled with ice, and the imperviousness of these soils facilitates core drilling. However, voids in other frozen soils are only partially filled with ice, and the perviousness of such soils may cause loss of drilling fluid and contamination of the cores by the fluid. A low degree of saturation with ice decreases the strength of frozen soil and also the amount of heat required to thaw it; thus difficulties in obtaining satisfactory soil cores are increased.

Deep within arctic regions, soils are hard and permanently frozen to great depths, and only the upper 20 to 30 ft are

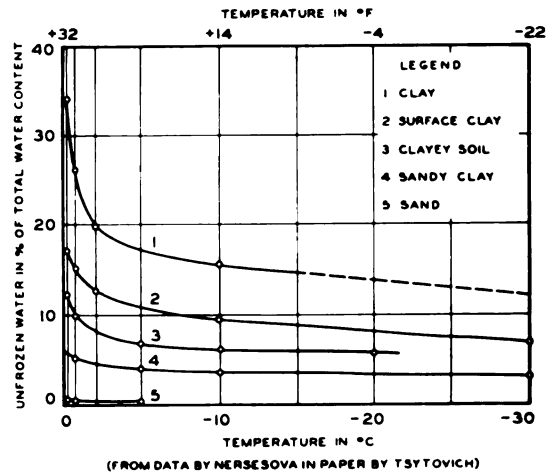

Fig. 2. Unfrozen water content of frozen soils

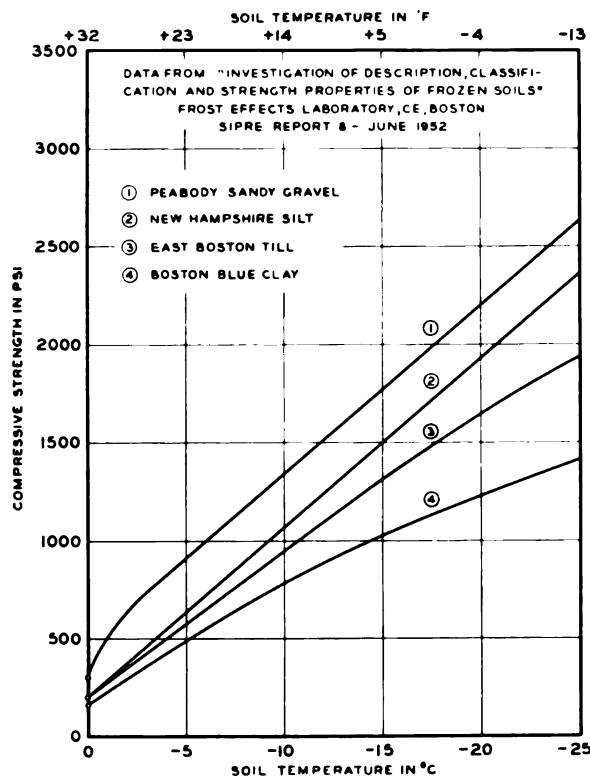

Fig. 1. Strength-temperature relations for frozen soils

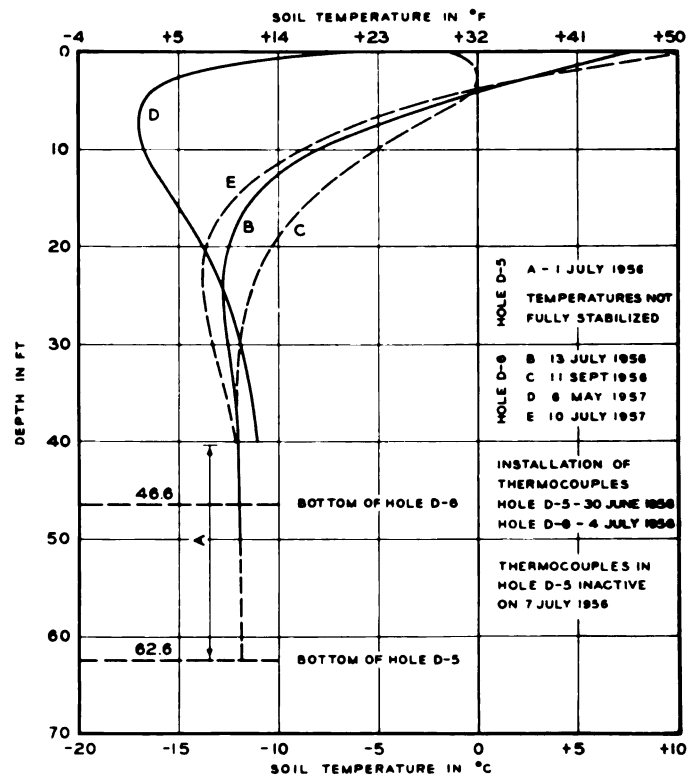

Fig. 3. Soil temperatures in bore holes 5 and 6 at Tuto

subject to appreciable seasonal temperature changes (Fig. 3). Below the depth of seasonal temperature changes, soils in sub-arctic regions may have temperatures only slightly below 0°C. Frozen zones may be discontinuous in lateral extent and also interbedded by strata of unfrozen soil. All these factors increase the difficulties of foundation exploration.

OBJECTIVES AND METHODS OF EXPLORATION

The primary objectives of foundation explorations in arctic and subarctic regions are to obtain data on: (a) Boundaries of thawed and frozen zones within depths which may influence construction activities and behavior of erected structures, (b) amount and mode of occurrence of ice in various soil strata, and (c) composition and properties of soils in these strata.

The boundaries between thawed and frozen zones can sometimes be determined by penetration tests, but the results of such tests are not reliable in dense deposits. Penetration resistance of frozen loose soils may equal that of unfrozen dense soils. Principal constituents of the soils are determined by cuttings from auger, percussion, and rotary drilling; however, the cuttings do not yield reliable data on the amount of ice in the soil. Representative samples of lightly frozen and fairly fine-grained soils can be obtained by drive sampling, but this method cannot be used effectively in frozen gravel and glacial till. Complete information on foundation conditions can be obtained in test pits, which may be used to advantage for shallow explorations and when core-drilling equipment is not readily available; but excavation of deep pits in frozen soils is expensive, even when explosives are used. Core drilling is undoubtedly the most efficient and satisfactory method for adequate exploration of frozen coarse-grained soils, and it can be used in all frozen soils and ice.

PRINCIPAL EQUIPMENT FOR CORE DRILLING

Drilling Rigs

Core drilling described in this paper was performed with a Franks Model FA-11, truck mounted rotary drilling rig, which has a 27 ft mast, "N" size drill rods, hydraulic feed, and a slush pump capacity of 100 gal/min. This drilling rig was fully satisfactory. Its power was needed for occasional rough drilling in unfrozen and coarse glacial till. However, lighter portable equipment can undoubtedly be used to advantage in less accessible regions and wherever special difficulties are unlikely to occur. The drilling rig should be able to operate a standard (4 by 5-1/2 in.) double-tube core barrel to the depths desired, and should have hydraulic or hand control rather than screw feed. Preferably, the slush pump should operate independently of the rotational speed of the drill head.

Casing

Casing is not usually required in hard frozen soils. Only a short length of 6 in. casing was used in Greenland for stabilizing the borehole through the unfrozen surface strata. Casing may be needed in subarctic regions for penetrating lightly frozen strata of limited thickness and exploring under-

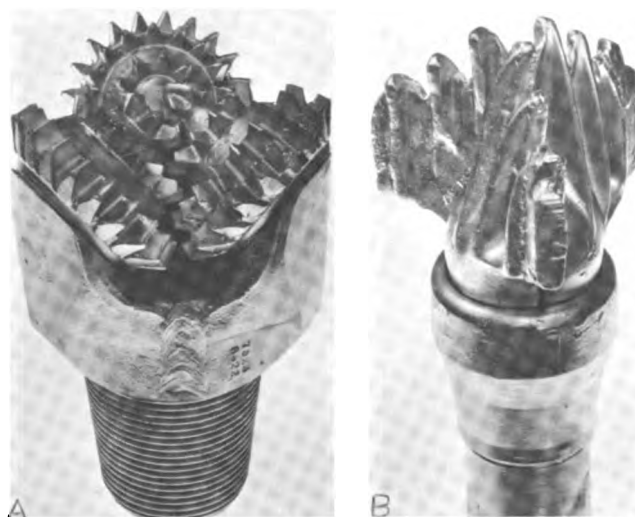

Fig. 4. Drilling bits: (A) Tricone rock bit; (B) Hawthorne bit

lying unfrozen soils. Drilling mud with a temperature above 0°C does not prevent gradual sloughing and caving of boreholes in fully saturated frozen soils.

Drilling Bits

Tricone rock bits (Fig. 4A) were used in Greenland for drilling through the unfrozen glacial till and for remaining boreholes in frozen soils, whereas Hawthorne bits (Fig. 4B) were used in silts, clays, and ice. Holes may be drilled with other types of bladed bits, chopping bits, and augers, but detailed data on the efficiency of available bits and augers in various types of frozen soils are not available to the authors.

Core Barrels

Soils artificially frozen at very low temperatures, below -25°C, have a strength comparable to that of nonfissured soft rock, and cores can be obtained with various types of core barrels, including single-tube barrels, provided low temperatures are maintained throughout the operations.

However, double-tube, swivel-head core barrels of the "M" type with bottom discharge bits are preferable or necessary for successful core drilling in frozen soils with temperatures normally encountered in the field. The core barrel should not be smaller than the 2-1/8 by 3 in. size (designated NXM by manufacturers) which usually yields satisfactory cores of frozen, fine-grained soils but often broken and incomplete cores of lightly frozen, coarse-grained soils. Better cores and consistently higher core recovery are generally obtained with standard 2-3/4 by 3-7/8 in. or with 4 by 5-1/2 in. double-tube core barrels, especially in lightly frozen soils or in cases where soil strength is reduced by incomplete saturation with ice. Torsional strength of a core increases linearly with the third power of its diameter.

A standard (4 by 5-1/2 in.) double-tube core barrel was

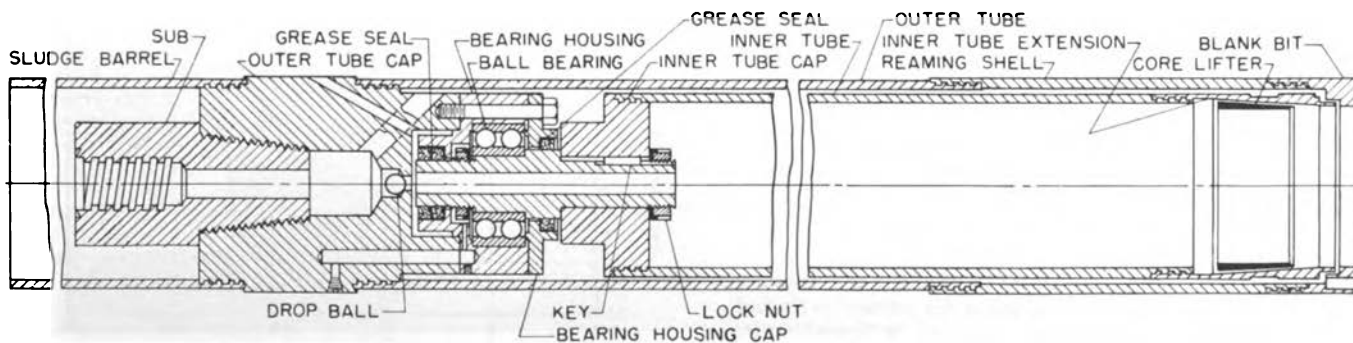

Fig. 5. Standard double tube core barrel



Fig. 6. Steel coring bit for ice

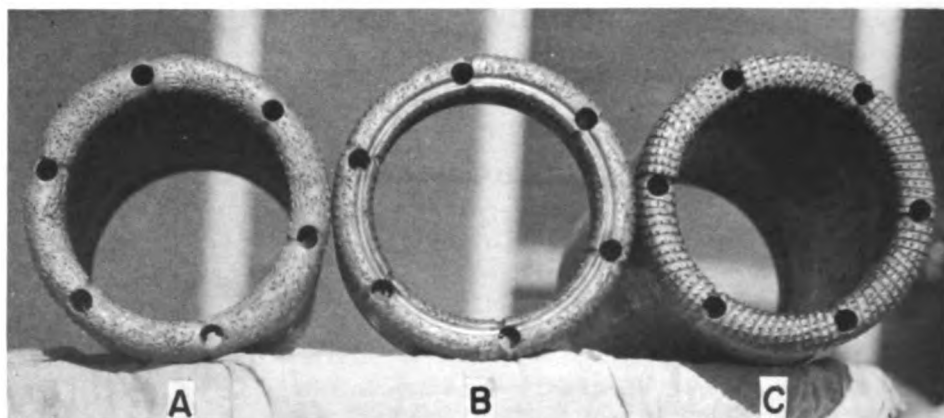

Fig. 7. Bottom discharge diamond coring bits: (A) Run 67 ft, worn bit; (B) Run 35 ft, damaged bit; and (C) Run 86 ft, good condition

used in most of the core drilling in Greenland. It (Fig. 5) has a sludge barrel or calyx which reduces the velocity of drilling fluid required to remove the coarser cuttings. Trial runs were made with an NXM core barrel, which yielded fairly good but broken cores; however, narrow water passages in this barrel were easily clogged by ice. Split-ring core lifters functioned satisfactorily in hard frozen soils, whereas basket-type core lifters were required in lightly frozen soils and when the temperature of the drilling fluid was high enough to cause some surface thawing of the cores.

Coring Bits

Steel coring bits with bottom discharge and teeth of various designs may be used in ice and compacted snow. For core drilling in ice, the bit shown in Fig. 6 was the best of various types, designed and manufactured by George E. Failing Co. in cooperation with SIPRE, now U.S. Army CRREL. This bit has long teeth with discharge opening at midheight on the back of the teeth, which reduces the tendency of ice cuttings to clog.

Bottom discharge coring bits with tungsten carbide inserts may be used effectively in frozen, fine- and medium-grained, but not gravelly soils. Bits with various shapes and arrangements of the inserts may yield satisfactory results, but the optimum design for frozen soils has not yet been determined.

Coring bits with large, protruding, tungsten carbide inserts may cause stones in gravelly soils or coarse till to be torn out of the frozen matrix and roll under the bit, thereby breaking up the core. In such soils it is usually necessary to use diamond coring bits. Examples of such bits after use in the (4 by 5-1/2 in.) core barrel are shown in Fig. 7. These bits had a matrix impregnated with diamond chips in addition to surface-set diamonds. One of the bits shown in Fig. 7 was damaged and another was badly worn after relatively short runs, probably because diamonds were torn out of the matrix and rolled under the bit, and possibly the matrix was too soft for the conditions encountered. When the frozen soil contains very hard and abrasive stones, it may be well to use diamond-impregnated coring bits without surface-set diamonds, at least not in the bottom face of the bit, but such bits would not be efficient for core drilling in frozen fine-grained soils or in ice.

Standard diamond reaming shells in core barrels were used in connection with the above mentioned diamond coring bits.

DRILLING FLUIDS AND SLUSH PITS

Compressed Air

This medium is used successfully for removal of cuttings in boreholes through unfrozen and fairly dry surface soils and also for core drilling in compact snow on the Greenland Ice Cap. However, effective use of compressed air for routine core drilling in fairly well-saturated, frozen soils is question-

able because of the greater unit weight and tendency of cuttings to ball, greater heat developed during drilling compared with snow, and costs and difficulty of adequate cooling of large quantities of air when the ambient air temperatures are relatively high.

Fresh Water

This medium is used with temperatures at or slightly above 0°C for core drilling in ice and frozen fine-grained soils, but cores of frozen coarse-grained soils, obtained with fresh water as drilling fluid, are often broken and partially thawed, and the recovery ratio depends on the amount of ice and the temperature of the soil. Furthermore, water tends to freeze at contact with walls of holes in very cold soils, especially during interruptions of drilling operations.

Brine

Fully satisfactory results of core drilling in frozen soils are possible only when the temperature of drilling fluid is below 0°C. During the 1956 core-drilling operations in Greenland, 2 to 4% of sodium chloride by weight and snow or ice were added to circulating water. Sodium chloride was preferred to calcium chloride because it was readily available and absorbs heat when dissolved, whereas calcium chloride produces heat during solution and is more corrosive than common salt. Excess amounts of snow or ice were maintained in the slush pit, and the temperatures attained (-1° to -2°C) were close to the freezing point of the weak brine (Fig. 8), which reduces possible melting of ice in cores by brine. The rate of melting of ice by brine of various salinities and at various temperatures of brine and ice should be explored. Good cores were obtained in hard frozen soils, but some thawing and loss of cores occurred in the upper lightly frozen and partially saturated strata. Weak brine tended to freeze when in contact with the walls of holes in hard frozen soils; it was necessary to

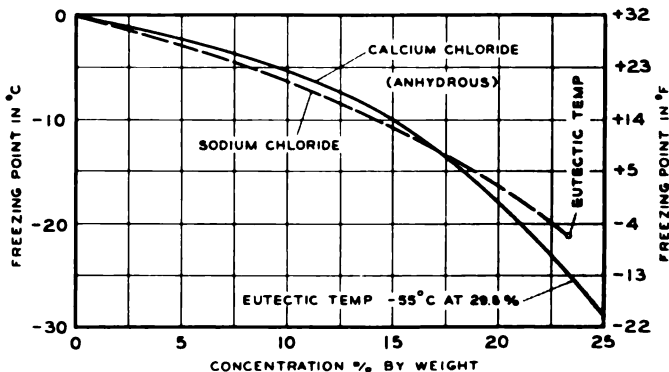

Fig. 8. Freezing temperatures of brines

empty the boreholes of brine during protracted interruptions of drilling operations. Much greater concentrations of salt would be required to prevent freezing of noncirculating brine at the soil temperatures encountered (Figs. 3 and 8).

Fuel Oil

Some of the above mentioned difficulties were avoided in 1957 by using Arctic Grade Fuel Oil DF-A as drilling fluid. This fuel oil was readily available and had a cloud point of -45.5°C . Other grades of fuel oil may be used provided the oil is dewaxed. Fuel oil was cooled by adding sodium chloride and snow or ice. Temperatures between -4° and -6°C were occasionally attained. Cores and recovery ratios were then consistently better than those obtained with fluid temperatures of -1° to -2°C . However, adding salt and ice produces a brine of relatively high salinity which is dispersed in the fuel oil and may cause melting of ice in the soil and cores. The rate of melting of ice by fuel oil-brine mixtures is not known and should be investigated. This problem can be circumvented by cooling with dry ice or by the indirect procedures discussed later.

Drilling Mud

As previously mentioned, drilling mud is not usually required for stability of boreholes in frozen soils, but brine or fuel oil may seep into partially saturated and pervious frozen soils, contaminating the cores, unless brine or oil is converted into drilling mud by suitable additives. A drilling mud formed of water and Aquagel may be used for starting a hole and for sealing the surface casing. Further addition of Zeogel and sodium chloride and cooling by ice or snow produces a drilling mud usable for core drilling in pervious frozen soils. However, the mud temperature must approximate the freezing point of the brine to prevent thawing of frozen cores. This requirement applies also to the usual oil-base drilling muds which contain water and antifreezing additives. Further inquiries and investigations are needed concerning drilling muds suitable for core drilling in pervious frozen soils and in interbedded frozen and thawed strata in subarctic regions.

Slush Pits

A slush pit excavated in coarse-grained soils is usually not satisfactory for core drilling with special and cooled drilling fluids. A Falling portable sheet-metal slush pit of 150-gal capacity was used in 1956 but was found inadequate for both settling of the cuttings and cooling the drilling fluid. A sheet metal slush pit of 270 gal capacity (Fig. 9) was built and used in 1957. The surface casing passes through the sleeve at the

head of the pit. Removable screens are provided in front of the overfall opening in the middle baffle wall and also over one-half of the rear compartment. Drilling in ice produces large amounts of ice chips, and their removal is facilitated by an additional sloping screen in the middle compartment. The walls of the sheet-metal pit were insulated by backfilling with soil or snow, and an improvised awning shaded the entire slush pit against direct rays from the sun.

Cooling of the Fluid

Salt and snow were added to the fluid in the front compartment, and the mixture was stirred at short time intervals. Ice may also be added in the central compartment. When available, snow was a convenient cooling medium, but despite screens it was often difficult to prevent snow crystals from entering the circulating system and clogging the core barrel. These difficulties can be eliminated or reduced by indirect cooling of the drilling fluid, which also will prevent fuel oil, used as drilling fluid, from becoming contaminated by brine during cooling.

One possible arrangement for indirect cooling is shown in Fig. 10A where the cooling chamber is a removable box with a series of copper tubes, through which the drilling fluid flows. The chamber is filled with water, salt, and snow or ice, and its relatively small volume permits use of high salt concentrations and attainment of low temperatures of the cooling mixture. The cooling chamber may also be a fully separate unit with coiled copper tubing, as shown in Fig. 10B. Perhaps a commercially available heat exchanger could be used effectively here, since drilling fluid is pumped through tubing, whereas it flows by gravity through the pipes in Fig. 10A. Drilling fluid is circulated through the pipes or coils of the cooling chamber by a small auxiliary pump; however, the main slush pump with appropriate bypass valves and pipes may also be used, provided it can operate independently of the drill head.

Cooling with dry ice may be used when very low temperatures are needed, or when snow or ice are not readily available. Dry ice may be added to the drilling fluid in the slush pit, but indirect cooling (Fig. 10) prevents particles of dry ice from entering the circulating system and clogging the core barrel.

The cooling chamber in Fig. 10B may be replaced with a special mechanical refrigerating unit, developed by U. S. Army CRREL. Such a unit provides very effective temperature control of drilling fluid, which is highly desirable in development operations and in large explorations under difficult conditions. However, a mechanical refrigerating unit is heavy and expensive, and simpler or improvised methods, similar to

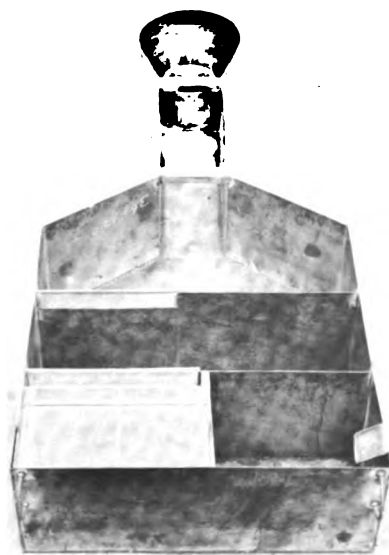
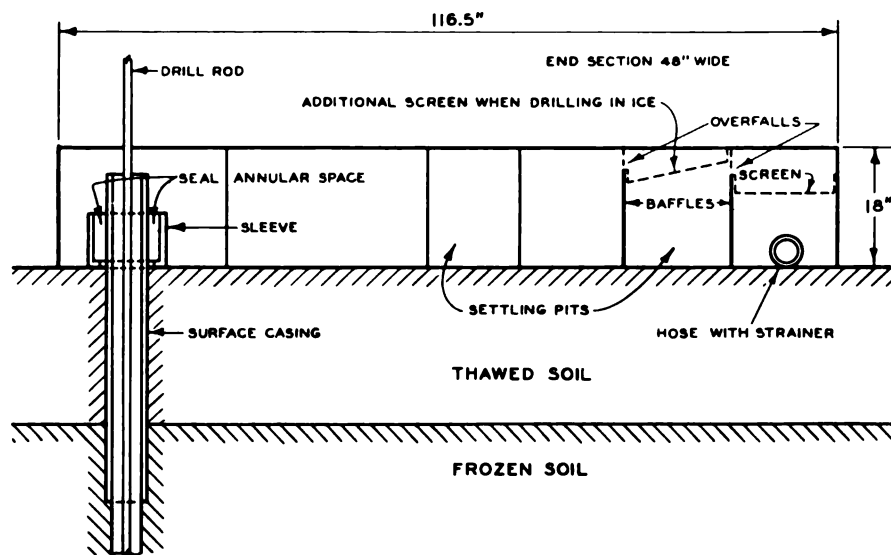
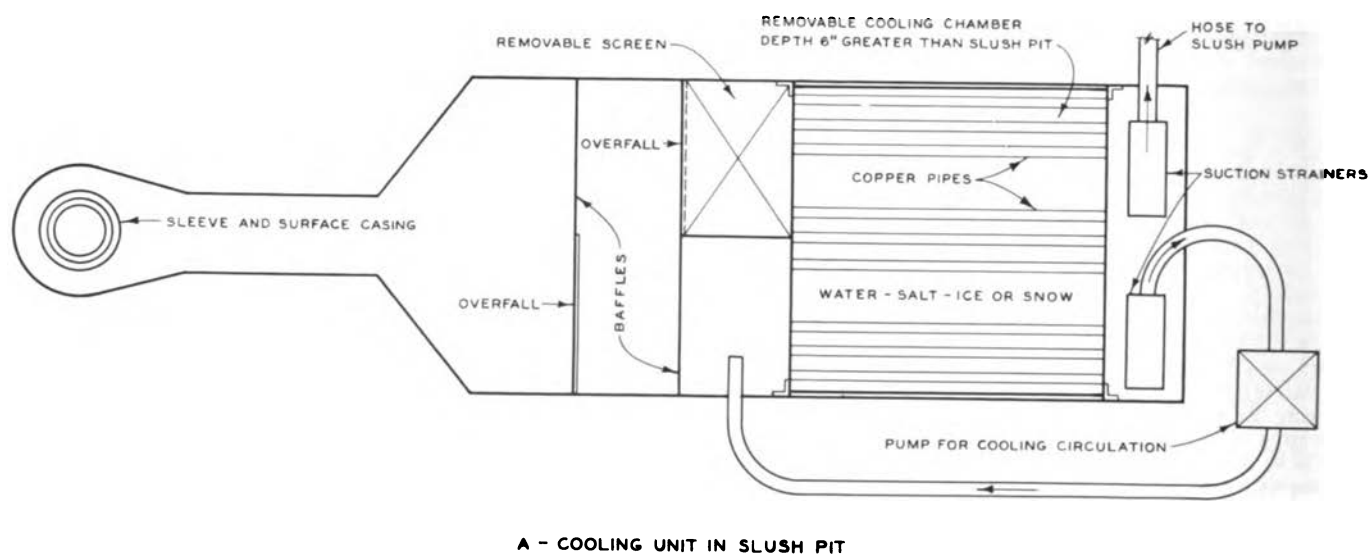
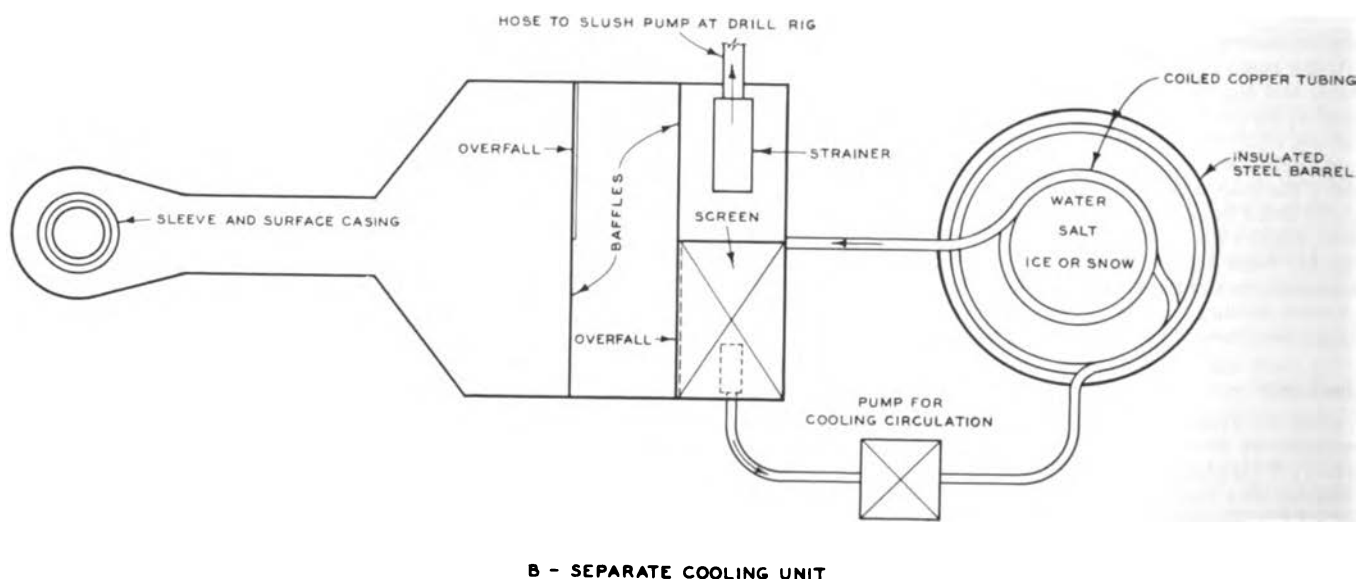

Fig. 9. Portable sheet metal slush pit





A - COOLING UNIT IN SLUSH PIT



B - SEPARATE COOLING UNIT

Fig. 10. Arrangements for cooling drilling fluid

those shown in Fig. 10, may be preferable for explorations of limited extent and in poorly accessible localities.

CORE DRILLING OPERATIONS

Start of Hole

In preparation for actual coring operations, a hole should be drilled through unfrozen surface soils and 1 to 2 ft into frozen soil. Surface casing should be set and driven into this hole, carefully sealed and, preferably, frozen to the soil. Any convenient drilling method with or without compressed air or water may be used, but Aquagel or water-based drilling mud may be needed to seal the casing and pervious soil. However, brine, fuel oil, or oil-based drilling mud should not be used before the surface casing has been set and sealed. Proper setting and sealing of surface casing is often difficult in the gravelly and stony glacial deposits prevalent in arctic regions, but it is very important for subsequent core drilling.

Drilling Fluid or Mud

As previously mentioned, drilling mud should be used when

frozen soils are partially saturated and pervious. Mud may be diluted and brine or fuel oil used when fairly well-saturated and impervious frozen soils are encountered. Drilling fluid should be adequately cooled, especially for core drilling in lightly frozen soils. Temperatures of the drilling fluid should be measured both in the rear compartment of the slush pit and at the outflow from the surface casing. Fluid temperature at the coring bit should not exceed -4°C . In shallow boreholes the temperature at the bit is nearly equal to that at the outflow, but in deep boreholes through hard frozen soils and ice the fluid temperature at the bit may be higher than at the outflow because of some cooling while fluid is flowing up through the borehole.

The rate of flow of drilling fluid should be high enough to cool the bit and remove the cuttings but not so large that it causes erosion of the core. Rates used in Greenland for a 4 by 5-1/2 in. core barrel varied from 10 to 30 gal/min in lightly frozen soils and up to 90 in hard frozen soils and in ice. Optimum values of the rate of fluid circulation were not obtained but are probably about 20 gal/min in lightly frozen soils and increase with decreasing temperature of the soil and drilling fluid.



A

HOLE 5—4-IN. CORE 22—DEPTH 41.9 TO 45.7 FT
GRANITE BOULDER UNDERLAIN BY SILTY SANDY GRAVEL WITH ICE COATINGS



B

HOLE 5—4-IN. CORE 26—DEPTH 57.7 TO 62.6 FT
SILTY SANDY GRAVEL WITH COBBLES AND ICE COATINGS. W = 7.7%



C

HOLE 6—4-IN. CORE 8—DEPTH 25.2 TO 30.0 FT
VARVED CLAYEY SILT AND SAND WITH ICE LENSES AND LAMINAE. W = 28.5%



D

HOLE 6—4-IN. CORE 9—DEPTH 30.0 TO 34.9 FT
SILTY GRAVELLY SAND. NOTE ICE BELOW BOULDER FRAGMENT. W = 9.8%



E

HOLE 11—4-IN. CORE 29—DEPTH 234.6 TO 244.7 FT
SILTY GRAVELLY SAND WITH COBBLES AND ICE COATINGS.



F

HOLE 11-A—4-IN. CORE 5—DEPTH 207.0 TO 214.5 FT
SILTY GRAVELLY SAND WITH COBBLES AND ICE COATINGS—CORE SURFACE MELTED



G

HOLE 6—NX CORES 12 AND 13—DEPTH 43.9 TO 46.6 FT
SILTY GRAVELLY SAND WITH COBBLES, ICE VEINS AND COATINGS. W = 4.6%

Fig. 11. Examples of frozen soil cores from Tuto

Core Barrels and Bits

It is advisable to use one of the large standard-core barrels in lightly frozen, partially saturated soils, or where subsurface soil and temperature conditions are unknown. NXM core barrel may be used, if desired, when hard frozen and fully saturated soils are encountered. Bit pressure should be relatively light in frozen soils, but fairly high rates of rotation may be used when drill rods are straight and properly centered. Oil pressures of 50 to 200 psi in the hydraulic feed, corresponding to a bit pressure of 750 to 3000 lb and rates of rotation of 100 to 300 rpm were used in Greenland for a 4 by 5-1/2 in. core barrel, but optimum values for various soil and temperature conditions have not yet been determined. Four in. cores of 5 and 10 ft lengths were obtained in hard frozen soils; runs in lightly frozen soils varied between 2 and 4 ft because of breakage of the cores and blocking of the core barrel or, in some cases, because of clogging of the waterways in the core barrels or bits by ice chips and snow crystals.

Cores and Field Tests

A triangular wooden tray forms excellent support for frozen and brittle soil cores during removal from the core barrel, cleaning, and inspection for preparation of the boring log. One objective in exploring frozen foundation soils is to ascertain their ice content. Unit weight and water content of representative sections of frozen cores should be determined in the field unless such sections are shipped frozen to a laboratory. It is also advisable to photograph representative sections of the cores, in some cases all the cores, especially when they are not stored in regular core boxes. Photographs of frozen cores of various soil types obtained in Greenland are shown in Fig. 11.

General Comments

Difficulties in adequately cooling the drilling fluid and in obtaining satisfactory soil cores near ground surface may be decreased materially by core drilling in winter and early spring, when ambient air temperatures are low, snow or ice is readily available, and soils are hard frozen.

In subarctic regions only surface soils are hard frozen during late winter and early spring. Lightly frozen soils are encountered at shallow depths, possibly interbedded with unfrozen zones. These conditions greatly increase the difficulties in obtaining cores of frozen soils. The strength of lightly frozen soils may be increased and better cores obtained when the temperature of the drilling fluid is decreased; but the temperature of the fluid should not be so low that it causes freezing of unfrozen soils before or after they enter the core barrel, since this would preclude determining the boundaries of frozen and unfrozen zones by core drilling. Perhaps a relatively viscous drilling mud is better for stabilizing the borehole and preventing loss of cooled fluid when passing through unfrozen zones. Surface casing should also extend through seasonally frozen soil and an underlying unfrozen zone to permanently frozen soil. The authors can offer only general suggestions, since their experience is confined to arctic and temperate zones, and planned core-drilling operations in subarctic regions did not materialize.

Seasonal variations of temperatures and boundaries of frozen soil may be important for design and construction.

Therefore, core drilling is often supplemented by temperature measurements in boreholes over extended periods. These measurements may be made by thermocouples or thermistors at varied intervals of depth, which furnish data for temperature profiles (Fig. 3). The space around temperature gages should preferably be backfilled with the same soil as that removed from the borehole and above all at the same water content, at least within the depth of seasonal temperature changes. If the backfill has a different water content, a time difference exists between freezing and thawing of the backfill and the surrounding undisturbed soil. The freezing point is depressed for water in fine-grained soils, and the change to the frozen state may be determined by temperature profiles and

diagrams similar to that shown in Fig. 2.

CONCLUSIONS

Currently developed equipment and procedures for core drilling in frozen soils yield satisfactory cores of fine-grained soils and also of hard frozen, coarse-grained soils, but optimum values of certain operating factors have not been established yet by systematic experiments.

The principal requirements for core drilling in frozen soils are: (a) Drilling fluid should have a temperature which will not cause melting of ice or a detrimental decrease in strength of the soil below the bit and in the core. (b) Salt water or brine may be used as a drilling fluid provided its temperature is close to its freezing point. Dewaxed fuel oil forms a more flexible and satisfactory drilling fluid when it is cooled by dry ice or through a heat exchanger rather than by direct addition of salt and ice. Brine and fuel oil should be converted to drilling mud by suitable additives when used in pervious frozen soils. (c) The frozen soil core should be able to withstand torsional forces transmitted by the core barrel and coring bit. The optimum core diameter increases with increasing temperature and decreasing strength of the frozen soil. (d) The core barrel should be of the double tube, ball-bearing swivel type, and so constructed that cores of lightly frozen, silty and sandy soils are protected against erosion by the circulating drilling fluid. (e) The coring bit should be of the bottom discharge type. Hardened steel and tungsten carbide are adequate as cutting media in frozen fine-grained soils, but diamonds are preferable for core drilling in frozen, coarse-grained soils for general use. The bit should be so designed and operated that gravel and stones are cut not torn out of the frozen matrix.

Satisfactory circulation and conservation of the drilling fluid requires that surface casing be extended and carefully sealed into the frozen soil. Further investigations are needed for development of simple, portable equipment, and methods for cooling the drilling fluid and for composition of an oil-base drilling mud without any additives which may cause melting of ice in the soil even though the temperature of the drilling mud is below 0°C. Fully satisfactory procedures for core drilling in lightly frozen, coarse-grained soils and in interbedded frozen and thawed zones, often encountered in subarctic regions, have not yet been developed.

ACKNOWLEDGEMENTS

Tactical support for the core drilling in Greenland, mentioned in this paper, was rendered by the U. S. Army Engineer Arctic Task Force. The authors also wish to thank the personnel of the U. S. Army CRREL (formerly ACFEL and SIPRE) for information and assistance freely given.

REFERENCES

- [1] W. K. Boyd, G. R. Lange. "Interim Report on Core Drilling in Frozen Ground," 7th Ann. Drilling Symp. - Exploration Drilling, Univ. Minn., Minneapolis, Minn., 1957, pp. 127-131.
- [2] R. R. Carver. "Improvement of Core Recovery by the Freezing Method," ibid., pp. 132-136.
- [3] J. D. Cumming. Diamond Drill Handbook, 2nd ed., J. K. Smit & Sons, Toronto, Ontario, 1956.
- [4] M. J. Hvorslev, T. B. Goode. "Core Drilling in Frozen Ground," 7th Ann. Drilling Symp. - Exploration Drilling, Univ. Minn., Minneapolis, Minn., 1957, pp. 114-126.
- [5] M. J. Hvorslev, T. B. Goode. "Core Drilling in Frozen Ground," Tech. Rept. No 3-534, U. S. Army Engr. Waterways Exptl. Station, Vicksburg, Miss., Jan. 1960.
- [6] F. F. Kitze. "Some Experiments in Drive Sampling in Frozen Ground," Paper at the 7th Alaska Sci. Conf., Juneau, Sept. 1956.
- [7] L. R. McDonald, P. C. Bremner. "Permafrost Drilling,"

Can. Mining J., Vol. 77, No. 10, Oct. 1956, pp. 92-94.

[8] J. A. Pihlainen, G. H. Johnston. "Permafrost Investigations at Aklavik - 1953," Tech. Paper No. 16, Div. Bldg. Res., Natl. Res. Coun., Ottawa, Jan. 1954.

[9] N. A. Tsytoich. "The Fundamentals of Frozen Ground Mechanics - New Investigations," Proc. 4th Intl. Conf.

Soil Mech. Found. Engr., London, Vol. 1, 1957, pp. 116-119.

[10] Résumé of Methods of Obtaining Core Samples in

Permanently Frozen Ground Used by the Permafrost Field Operations Branch, Fairbanks, Alaska. U. S. Army Engr. Dist., St. Paul, Minn., Feb. 1950.

[11] "Investigations of Description, Classification, and Strength Properties of Frozen Soils," SIPRE Rept. No. 8, U. S. Army Engr. Div., New England, ACFEL, June 1952.

[12] K. L. Vonder Ahe. "Operating Problems in Oil Exploration in the Arctic," Petrol Engr., Vol. 25, Feb. 1953, pp. B-12 - B-18.

ENGINEERING SITE INVESTIGATIONS IN PERMAFROST AREAS

G. H. JOHNSTON, National Research Council, Ottawa, Canada

Three main factors hinder construction in arctic and subarctic regions: Logistics, climate, and terrain [1]. Difficult access and limited transportation facilities create problems in the movement of personnel and materials [2, 3]. Climate, although not much more severe than in more southerly regions (such as the Canadian Prairies or the Russian Steppes), differs mainly in the duration of cold weather rather than in extremes of temperature [4, 5]. The long winter with almost constant darkness results in a very short field or construction season. The season is restricted further by periods of breakup and freezeup when many areas are completely isolated. Perhaps the most important factor that distinguishes northern areas from other regions is the terrain [6], of which perennially frozen ground (permafrost) is the dominant feature. More than 20% of the land area of the world (including about 50% of Canada) is underlain by permafrost.

Areas underlain by permafrost may be subdivided in several ways based on the ground thermal regime (ground temperature), but northern regions are usually divided into two broad zones based on the areal and vertical extent of the permafrost: the continuous zone, where permafrost is found everywhere to considerable depth (> 100 ft), and the discontinuous zone, where relatively thin (< 100 ft) patches or islands of frozen ground are separated by thawed areas. Within the discontinuous zone patches of permafrost range from very sporadic (near the southern boundary of the region) to extensive (in the northern part of this zone, where frozen ground predominates). Extensive and varied occurrence of permafrost makes it a prime consideration in any northern engineering work.

Most engineering problems are caused by thawing of perennially frozen ground which contains large quantities of ice. Ice segregation in soils (or rock) ranges from concentrations of minute lenses to large inclusions of ice several ft thick. Different forms of ice segregation occur in all soils, even in gravel and coarse sand. The most serious difficulties, however, are encountered with frozen fine grained soils; even when moisture (ice) content of these soils is very large, ice segregation is often difficult to discern. Thus, presence of ice and properties of soil in frozen and thawed states are of direct concern to the engineer.

Experience with permafrost and failures attributed to its unusual properties have shown that it affects every type of engineering project, be it selection of a new townsite or erection of a single structure in an established community. Even though much information has been collected in recent years on the relatively unpredictable occurrence of permafrost and its properties, the need for adequate site investigations cannot be overemphasized. The form and extent of investigations may vary, depending on particular job requirements, but certain basic procedures should be followed in acquiring the information needed for good design and construction.

For any northern project, information should be collected to determine: (a) Distribution of permafrost and conditions under which it exists and (b) properties of the permafrost.

Site investigations in any region are usually conducted in three phases, namely: Preliminary office studies and planning, field investigations, and laboratory and office studies (prepa-

ration of reports).

Planning of each phase requires greater attention when northern sites are considered, primarily because of permafrost but due also to the relative isolation and general lack of knowledge of the terrain. This paper suggests a logical sequence for carrying out site investigations in permafrost areas [7].

"Site investigation," as used here, is limited to those phases of an over-all site evaluation which pertain to the collection of information on permafrost conditions. Except for illustrative purposes, no attempt is made to describe procedures which apply only to specific types of projects, such as railroad or road location and construction, water supply and distribution systems, or buildings. Comments made, however, apply to all types of engineering projects.

At least a year is generally required to complete an adequate engineering site investigation in permafrost areas. Some overlapping of the three phases will occur since certain portions of each are better conducted at different times of the year. Depending on the type of project, investigations may be completed in much less than one year; for others, work may continue well into a second year, but in general, a one year period is needed to assess properly all site conditions affecting design and final planning [8].

PRELIMINARY OFFICE STUDIES AND PLANNING

Emphasis must be placed on careful planning and compilation of pertinent information prior to conducting field investigations. This preliminary work is normally carried out several months prior to the field season. For most areas, the season begins in March or April. Much time and effort can be saved (and survey costs reduced) if the area has been thoroughly studied beforehand. In addition, depending on information acquired during this initial study, some assessment can be made of foundation designs and construction techniques which might be used.

Background Information

Although meager information is available for many northern regions, data on adjacent or similar areas may provide useful information on general conditions which may be encountered. Of particular interest is a knowledge of the geology and climate; both are intimately connected with the formation and existence of permafrost.

Many northern areas have been geologically mapped, albeit superficially in most instances. Reference to such maps and to published reports can provide much information of value. Most of the Arctic and sub-Arctic have been glaciated; thus, accounts of the glacial history are of specific interest with respect to soil and permafrost conditions. Accounts of the travels of many early explorers and geologists provide valuable descriptions of the terrain and geomorphology [9].

Climate plays an important role with respect to permafrost, particularly with regard to the ground thermal regime [10]. Broad correlations exist between the occurrence of permafrost

and air temperature [11, 12]. In addition, although the north is generally known as an arid or semi-arid region, precipitation, through surface drainage, has a considerable effect. Meteorological records [13] should always be examined and summarized to evaluate local climate with respect to permafrost. Knowledge of local climate is also invaluable, of course, in planning field operations.

A complete folio of pertinent maps, geologic, topographic, and hydrologic (if available), covering the areas to be investigated, will provide further information and will also be useful for recording field observations. Scales of 1:50,000 or larger are most useful but maps of smaller scale should not be disregarded. Most of northern North America has been mapped to some degree and maps are generally available through the Federal Governments of Canada and the U.S.A.

An important source of information, often neglected, is contact with agencies, firms, or individuals who work or have worked in the areas under investigation. In many cases useful site information is available from those with exploratory, development, or construction experience in the area (e.g., mining companies, trappers, and prospectors). Contact with such people can be made prior to and during the field exploration. Observations on performance of existing structures are also most valuable.

Airphoto Studies

Airphotos provide the most valuable aid for preliminary planning and site evaluation [14]. Airphoto coverage, to various scales, is now readily available for most northern regions. The airphoto serves as a map; the surface features on this map (together with a knowledge of the geologic and climatic history of the area), when properly interpreted, can yield a wealth of information on subsurface conditions [15, 16]. Soil types and permafrost conditions are indicated by or can be inferred from relief, vegetation, and drainage characteristics. Color tones on photographs provide further clues. Detrimental permafrost areas can be identified and delineated by recognizing phenomena such as soil polygons and patterned ground forms resulting from frost action [17]. Ice-wedge polygons may vary in diameter from 15 to 500 ft. Pingos, thermokarst lakes, "drunken forests," or ground subsidence caused by thawing of large buried ice masses, solifluction lobes or terraces, frost mounds, hummocks, and mud boils can all be readily identified; when seen on an airphoto, they indicate potentially unsuitable foundation conditions.

The topographic position of a locality is perhaps the most important feature related to permafrost that can be recognized on an airphoto; this assists greatly in predicting permafrost conditions since detrimental permafrost conditions generally occur in certain topographic situations. For example, many of the phenomena just mentioned are associated with low-lying areas, such as coastal plains and stream valleys or depressions in upland areas.

Dense forest growth, particularly in the discontinuous permafrost zone, may mask ground surface features on an airphoto. Certain vegetation associations [18-21] are closely related to subsurface conditions and permafrost occurrence and, therefore, when considered together with topographic position, soil texture, and drainage, can serve as fairly reliable indicators.

In general, the surface drainage pattern is little altered by permafrost. Local drainage patterns and characteristics (e.g., "beaded" or "button" streams) seen on airphotos do, however, provide useful clues. The thawing effect of water, either still or running, on the occurrence and thermal regime of permafrost is great because of its heat storage capacity and powers of erosion. Slumped lake banks and polygonal surface features disintegrated by running water are evidence of this effect.

Most surface features associated with permafrost are the result of a complex relationship of many factors such as climate, geology, freezing and thawing, relief, and drainage [22]. Much depends on the experience of the airphoto "reader" and his ability to analyze and interpret what he

sees. Even though permafrost and general terrain conditions can be predicted fairly reliably from airphotos, it is still necessary to visit selected areas which have been subdivided on the basis of similar terrain characteristics (e.g., relief, drainage, and vegetation) in order to verify the interpreted conditions [23, 24].

Planning

Careful planning for field operations is essential if the work is to proceed efficiently and economically. Movement of personnel and equipment into and about the areas under investigation is affected greatly by difficult access and lack of transportation at certain times of the year. Special care is required in planning for projects such as road location surveys which cover large areas and varying types of terrain. Every detail must be carefully thought out because the field season is short and supply lines are usually long and difficult. Good communications are essential.

Personnel selection is very important. An experienced civil engineer should supervise and coordinate all activities. Most surveys require a glacial geologist preferably with training in geomorphology, a soils engineer, and/or civil engineer assisted by technicians. All should be well qualified and very familiar with permafrost. Depending on the objectives and scope of the project, other specialists may be required, e.g., a botanist and a hydrologist. If local labor is not available, additional assistance will have to be brought in.

The success of the investigation will depend largely on the degree to which the work has been preplanned and on the knowledge of the area which the field workers have acquired before entering the second phase, i.e., the field investigation.

FIELD INVESTIGATIONS

Field investigations are usually carried out in two stages: An exploratory survey is conducted over wide areas to assess general site conditions and factors which influence permafrost and to select sites for detailed examination; and detailed investigations are conducted at selected sites to gather detailed information on permafrost conditions relevant to the design of structures and construction techniques to be used.

Exploratory Survey

Potential sites or routes selected by preliminary office studies, primarily through the use of airphotos, are examined during this stage. These areas are evaluated for their suitability in all seasons. Geological studies include bedrock control and the glacial history (with which permafrost is closely associated) of the over-all area with more detailed examinations at specific locations.

A terrain reconnaissance is made to map topographic features including relief, drainage, and vegetation patterns and characteristics. Areas of patterned ground and permafrost phenomena are delineated. Locations of "icings" are noted. Lake and stream ice thicknesses and snow accumulation patterns and depth are observed. Transit and tape and level surveys are made to establish horizontal and vertical control for the area. Field sketches or plans are prepared on which all terrain information can be recorded. Data can also be noted on airphotos or topographical maps already available.

Determination of the distribution of permafrost is the most important aspect of the exploratory survey. Selected areas are examined by borings, test pits, and probings to check predictions and to determine actual subsurface conditions. Distribution of permafrost, its areal and vertical extent, and factors which appear to control its existence such as drainage (surface and subsurface), vegetation (type and thickness of moss cover), and topographic position are very important, particularly along the southern fringe of the permafrost region. The depth to which seasonal freezing and thawing penetrates (active layer) and the rate at which these processes take place, the depth to the permafrost table, the presence of taliks (unfrozen zones) within permafrost, and the movement of sub-

surface water are also factors that must be determined. Types of ice segregation and various materials with which they are associated must be known and delineated.

Samples of perennially frozen materials can be obtained in several ways [25]. Naturally occurring exposures and hand boring methods will provide general information for relatively shallow depths. Test pits and core drilling provide detailed information on soils and ice segregation to greater depths.

Geophysical methods [26, 27] to determine the depth to and extent of permafrost have had increasing application. Seismic refraction soundings appear to be suitable for determining the upper limit or depth to permafrost; electrical resistivity methods are most useful in determining the thickness of permafrost. Experience in their use is limited, however, and reliability of results depends to a great extent upon the interpretation.

Suitable instrumentation and observation programs (to obtain data for the designer and planner) should be set up early in the exploratory stage of the field work. Meteorological observations, including measurement of air temperatures, precipitation (rain and snow), and wind (direction and velocity), should be made to provide information on local climate. Permafrost is defined on a temperature basis; thus, data on the ground thermal regime is needed to describe permafrost conditions. Ground temperature installations should be made to depths of at least 20 ft and greater if possible. Ground movement gages may be necessary in many cases to determine detrimental effects due to freezing and thawing of the active layer. Observations on the rate and depth of thaw under various terrain conditions are also essential and should be made throughout the thawing season (the maximum thaw will be observed in the late fall) by simple hand probing methods. To provide useful information, such observations should be made on a regular daily, weekly, or monthly basis; since, in most cases, the observation period should cover at least six months, the observations should be started as soon as possible.

Finally, the construction and performance history of similar structures in the area will provide much information on site conditions. These sources will prove of inestimable value to the designer and should not be overlooked. Observations on existing structures should be initiated at this stage.

Exploratory survey is the most important stage of a field investigation. Although its purpose is to obtain general information on surface and subsurface conditions over a wide area, and it might therefore be considered rather superficial, results obtained dictate to a large extent the future of the proposed project. On the basis of the information obtained, unsuitable areas are eliminated and final sites and routes selected for more detailed examination. Design criteria and construction methods and techniques also evolve during this stage. Thus, it is a critical period of extensive and intensive examination of all factors related to permafrost and its effect on the proposed project.

Detailed Investigation

This phase of the field program provides the detailed information needed for final planning and design of the project. Various construction methods and techniques are assessed and selected during this stage. This work is done at sites selected during the exploratory survey to supplement information already obtained. Preliminary designs may be drawn up during this stage and layout of structures at approved sites begun. The field supervisor of this stage should be completely familiar with the requirements of the project so that he can direct the field program along the right paths. Close coordination of all operations between field and head offices is necessary.

Observations begun during the exploratory survey (including depth of thaw in disturbed and undisturbed areas and ground temperature measurements) are continued and expanded. More detailed records of subsurface conditions at actual construction sites are required in selecting foundation designs [28]. In particular the ground thermal regime should be critically

analyzed, and the form and extent of ice segregation in the underlying materials should be noted in detail [25].

Test pits have particular application to site exploration in areas covered with deposits of stony tills or gravel. A major advantage of this method is that it permits the frozen soil and the ice segregation to be examined in the undisturbed condition. They can be excavated at any time of year to depths of 20 to 30 ft by compressed-air or gasoline-engine jackhammers. Core-drilling methods to obtain undisturbed frozen samples are widely used for investigations to depths of 20 ft or greater. Although coarse grained soils have been successfully sampled using special refrigeration equipment and techniques [29], drilling methods are most applicable in fine grained soils. Good cores of undisturbed material can be sampled for moisture (ice) content and unit weight determinations and for identification and classification of soils encountered. Some testing may be done at the site, but many samples are shipped out in plastic containers (to reduce weight and thus transportation costs) for laboratory analysis. Although refrigerated methods can be used to ship samples, it is difficult to preserve specimens in the frozen state and therefore photographic techniques have been developed to provide a permanent record.

At this stage actual test installations at the site can be made and construction procedures can be developed. For instance, if pile foundations are under consideration, field studies might include an evaluation of pile-placing techniques and pile-load and pull-out tests to determine adfreeze strengths. Test fills might be constructed for road and airstrip design purposes. Bearing capacity tests of frozen soil might also be included. Although it takes time to accumulate useful results, much valuable information can be obtained at this stage, particularly for large construction programs which may take several years to complete, e.g., roads, railroads, and townsite developments. Some construction may be started during this early period but it will be generally limited to such activities as site preparation and opening of borrow pits. In these cases it is useful to observe methods of excavating and the handling and placing of frozen and thawed materials.

Detailed terrain conditions are accurately and specifically described and delineated. Topographic maps, with contour intervals of from 2 to 5 ft are required to portray surface configurations and conditions. Subsurface information including soil and permafrost conditions at or along finally selected sites and routes are shown on plans, and sections or logs and are described by test results and written reports.

During both the exploratory and detailed surveys, information collected in the field is sent back to the head office for evaluation with respect to the project as a whole. Although over-all direction of the field work may come from there, many decisions as to the course of the work must be made by the field supervisor. Various phases of each type of survey may overlap or be carried on at the same time and in conjunction with each other. Nothing should be overlooked or omitted during these stages so that final planning and design may proceed without delay. It may not be possible to obtain missing or forgotten information until the following year.

FINAL STUDIES AND PREPARATION OF REPORTS

This phase of site investigation consists primarily of office studies directed toward presentation of all site information needed for the planning and design of engineering structures. Evaluation of laboratory test results of the physicomaterial properties of the materials encountered at construction sites are of prime importance for foundation design and selection of construction procedures and techniques. Preparation of detailed maps and drawings showing terrain conditions at appropriate scales is necessary for final route selection and proper siting of structures. The designer and planner is dependent wholly on information in the final reports and recommendations of field workers. Emphasis must be placed upon preparation of thorough and detailed reports.

Some thought should be given to continuing and expanding observations begun during field investigations. Observations,

such as ground temperatures, depth of thaw in undisturbed and disturbed locations, and effects of and changes in drainage patterns (both surface and subsurface, though not always of immediate value) will provide useful information for future projects in the area. Studies should be continued by instrumentation and observation of the performance of various structures and their effects on permafrost conditions. Such studies will provide valuable information for future work of similar nature.

Many investigations have been made at various northern locations. Unfortunately, experience gained and conditions encountered are seldom recorded. There is a great and immediate need for such information to increase our knowledge of permafrost and the conditions under which it exists. All engaged in northern work are urged to record their observations for the general benefit.

REFERENCES

- [1] R. F. Legget, H. B. Dickens. "Building in Northern Canada," Natl. Res. Coun. Div. Bldg. Res., Tech. Paper No. 62, 1959.
- [2] P. D. Baird. "Transportation," Geography of the Northlands, Kimble and Good, ed., Am. Geog. Soc., Spec. Pub. No. 32, John Wiley, 1955, pp. 187-209.
- [3] K. B. Woods, R. F. Legget. "Transportation and Economic Potential in the Arctic," Traffic Quart., 1960, pp. 435-458.
- [4] H. A. Thompson. "Temperature Normal: Averages, and Extremes in the Yukon Territory and the Northwest Territory," Arctic, Vol. 15, 1962, pp. 308-312.
- [5] R. W. Rae. Climate of the Canadian Arctic Archipelago, Dept. Transport, Meteorological Div., Form 9002, Toronto, 1951.
- [6] M. Dunbar, K. R. Greenway. Arctic Canada from the Air, Dept. Natl. Defence, Defence Res. Bd., Ottawa, 1956.
- [7] N. I. Saltykov. "Methods of Engineering Geocryological Investigations," Osnovy Geokriologii (Merzlotovedeniya), V. A. Obruchev Inst. Geocryology, Acad. Sci. USSR, Moscow, 1959, Pt. 2, pp. 298-347.
- [8] S. Muller. Permafrost or Permanently Frozen Ground and Related Engineering Problems, U.S. Army, Office Ch of Engs., Spec. Rept., Strategic Engr. Study No. 62, 1945.
- [9] E. deK. Leffingwell. "The Canning River Region, Northern Alaska," U.S. Geol. Survey, Prof. Paper 109, 1919.
- [10] R. F. Legget, H. B. Dickens, R. J. E. Brown. "Permafrost Investigations in Canada," Proc. 1st Intl. Symp. Arctic Geology, Vol. 2, 1961, pp. 956-969.
- [11] R. J. E. Brown. "The Distribution of Permafrost and Its Relation to Air Temperature in Canada and the U.S.S.R.," Arctic, Vol. 13, 1960, pp. 163-177.
- [12] H. A. Thompson. "Freezing and Thawing Indices in Northern Canada," Proc. 1st Can. Conf. Permafrost, Natl. Res. Coun. Canada, Tech. Mem. No. 76, 1963, pp. 18-36.
- [13] Climatic Summaries for Selected Meteorological Stations in Canada, Dept. Transport, Meteorological Branch, Vol. 1, 1947, and Addendum to Vol. 1, 1954.
- [14] R. E. Frost. "Aerial Photography in Arctic and Subarctic Engineering," J. Air Transport Div., Am. Soc. Civil Engrs., Vol. 86, 1960, pp. 27-56.
- [15] R. E. Frost. "Interpretation of Permafrost Features from Airphotographs," Frost Action in Soils, U.S. NAS-NRC, Highway Res. Bd., Spec. Rept. No. 2, 1952, pp. 223-246.
- [16] D. J. Belcher. "Determination of Soil Conditions by Aerial Photographic Analysis," Proc. 2nd Intl. Conf. Soil Mechanics Foundation Eng., Rotterdam, 1948, Vol. I, pp. 313-321.
- [17] A. L. Washburn. "Classification of Patterned Ground and Review of Suggested Origins," Geol. Soc. Am. Bull., Vol. 67, 1956, pp. 823-866.
- [18] H. P. Hansen. "Postglacial Forests in the Yukon Territory and Alaska," Am. J. Sci., Vol. 251, 1953, pp. 505-542.
- [19] I. Hustich. "The Boreal Limits of Conifers," Arctic, Vol. 6, 1953, pp. 149-162.
- [20] M. E. Britton. "Vegetation of the Arctic Tundra," Arctic Biol., Biol. Colloquium, ed. H. P. Hansen, Oregon State Coll., 1957, pp. 26-61.
- [21] R. J. E. Brown. "Effects of Vegetation of Permafrost," in this volume.
- [22] K. B. Woods, J. E. Hittle, R. E. Frost, "Correlation Between Permafrost and Soils as Indicated by Aerial Photographs," Proc., 2nd Internl. Conf., Soil Mech. and Foundation Eng., Rotterdam, Vol. 1, 1948, pp. 321-324.
- [23] G. H. Johnston, R. J. E. Brown, D. N. Pickersgill. Permafrost Investigations at Thompson, Manitoba-Terrain Studies, Natl. Res. Coun. Canada, Div. Bldg. Res., Tech. Paper No. 158, 1963.
- [24] R. C. Sager. "Aerial Analysis of Permanently Frozen Ground," Photogrammetric Engr., Vol. 17, 1956, pp. 123-132.
- [25] G. H. Johnston. Soil Sampling in Permafrost Areas, Natl. Res. Coun. Canada, Div. Bldg. Res., Tech. Paper No. 155.
- [26] H. R. Joesting. "Geophysical Exploration in Alaska," Arctic, Vol. 7, 1954, pp. 165-175.
- [27] H. Roethlisberger. "The Applicability of Seismic Refraction Soundings in Permafrost near Thule, Greenland," Tech. Rept. No. 81, U.S. Army CRREL, 1961.
- [28] L. A. Nees, A. Johnson. "Preliminary Foundation Exploration in Arctic Regions," Symp. Surface and Subsurface Reconnaissance, ASTM, Spec. Tech. Publ. No. 122, 1951, pp. 28-39.
- [29] M. J. Hvorslev, T. B. Goode. "Core Drilling in Frozen Ground," 7th Ann. Drilling Symp., Exploration Drilling, Univ. Minn., Minneapolis, 1957.

This paper from the Division of Building Research, National Research Council, Canada, is published with the approval of the Director of the Division.

REFRIGERATED FLUIDS FOR DRILLING AND CORING IN PERMAFROST

G. R. LANGE, U.S. Army CRREL

When important structures are to be founded upon permafrost, subsurface investigations are required in greater accuracy and detail than in temperate regions.

Useful techniques of drilling and coring in permafrost (and elsewhere) have been gained only when an organization or individual was confronted with the problem of supplying subsurface information for the solution of a very real, immediate, and often difficult engineering problem of site selection or foundation design or both. Working against tight schedules enforced by arctic field seasons and often hampered by logistics that would seem incredible to exploration parties who work the year round on good roads in temperate climates, these people have usually produced the required information and sometimes even produced it on time. However, very little of this drilling technology and experience has found its way into the engineering literature. Notable exceptions are Bremmer's work at Resolute Bay [1], the work of Johnston, Brown, and Pihlainen at Anuivik [2], and Hvorslev and Goode at Tuto in Greenland [3].

In 1953, CRREL (then SIPRE) initiated an active program of investigation of the problem of drilling and coring in permafrost. This program is termed active, as opposed to the work mentioned above, because the only objective of the program (until the final field season) was the improvement of permafrost drilling and subsurface sampling techniques rather than the collection of information and samples for site selection and foundation design. This program was continued until 1960, with a substantial interruption from 1955 to 1957 during which a deep ice coring program was carried out in connection with the IGY glaciological investigations in Greenland and in the Antarctic. Operational field experiences are summarized first, then a rational approach to the design of a system for drilling and coring in permafrost is described.

FORT CHURCHILL, 1954

In order to gain first hand experience with the special problems of drilling and coring in permafrost, a small truck-mounted rotary rig was brought to Fort Churchill, Manitoba, in the spring of 1954. The rig, a Failing Model 43 SA, was powered by a 24 hp gasoline engine and had a 23 ft tubular steel mast. The piston pump, powered by a duplicate engine, delivered 47 gal/min at 200 psi. The rig was essentially a heavy duty diamond drill with a splined kelly and slow rotational speeds. This plant is rated for 300 to 500 ft of 6 in. diameter hole. Several varieties of rock and drag bits as well as core barrels, core bits, and small diameter augers were provided for the investigation.

Difficulty in drilling frozen rocks and soils was originally assumed to be due to the extra resistance of the material because of its frozen condition, i.e., a rock or soil gained so much strength upon freezing that its "drillability" was substantially decreased. For this reason, the rig was instrumented to record as many of the variables of the drilling process as seemed appropriate. These included rpm, load on the bit, rate of penetration, pump discharge, and pressure. It was expected that certain combinations of these variables and bit types would be found optimum for high rates of penetration in frozen soils.

Ground temperatures below the level of seasonal change at Fort Churchill rarely fall below 28°F in the till-like marine clays that constitute to 40 to 80 ft overburden. Brown [4] places Churchill at about the southern limit of continuous permafrost, and our investigations there support this. The frozen marine clay is overlaid by 8 to 15 ft of frozen sandy gravel in which spring and summer temperatures may be as low as 14°F.

It was necessary to conduct the auger trials in this stronger,

coarser gravel unit at the surface. It was found that the rig would drive any ruggedly designed auger of up to 6 in. in diameter at penetration rates of 1.0 ft/min and more. Subsequent work in the same locality with much larger diameter augers driven by a suitably large augering rig also demonstrated that the material is easily drilled at reasonable high penetration rates [5].

During rotary drilling and coring trials, it was found necessary to "case off" the upper permeable gravel layer. The relatively warm (40° to 45°F) water used as drilling fluid seeped into the gravel, causing thawing and subsequent slumping of the gravel hole walls. Some slumping due to thawing was encountered in drilling with the warm water in the underlying clay unit; however, it was a good deal more competent than the gravel when thawed, and the drilling trials were satisfactorily completed in the clay. As with the augering, the rate of penetration was found to rise as a roughly linear function of rpm or bit load, and rates of 1.0 to 2.0 ft/min were easily obtained except when occasional cobbles and boulders were encountered.

Initial coring trials using warm water in the frozen marine clay resulted in thawed core and hole walls. These results suggested that improvements might result if the drilling fluid were to be cooled to reduce the amount of thawing. A supply of ice was made available, and this was placed in the metal mud pit. The temperature of the drilling water then ranged from 32° to 39°F (depending upon the daily weather conditions), and this resulted in marked improvement of core recovery and wall stabilization. Some lengths of frozen core 2 to 3 ft long were taken with little or no evidence of thawing.

DEFINITION OF THE PROBLEM

If a structure is to be founded upon frozen soil or rock, and since the physical properties of the materials may vary greatly, depending upon the phase composition of the water (especially in soil), it is highly desirable that the properties of the material be examined in the laboratory at approximately the same temperature as it occurred in nature. Therefore, the objective of this program became the development of a system for obtaining frozen cores and transporting them with minimum thermal disturbance to a laboratory cold room for testing. Thus, a means of cooling one or more drilling fluids to temperatures below the freezing point of water was sought. It should not be dependent upon supply of natural, artificial, or dry ice and should remain functional during the warmest summertime temperatures in the Arctic. Diesel fuel (arctic grade) and compressed air were initially selected as the drilling fluids for this application.

DESIGN OF THE FIRST DRILLING FLUID REFRIGERATOR

Feasibility of refrigeration of drilling fluids was examined and design criteria were established from which the required refrigeration capacity could be calculated. These criteria were:

1. The system should be capable of cooling a flow of either diesel fuel or compressed air (but not simultaneously).
2. Maximum ambient air temperature of 70°F was assumed.
3. Flow rate and pressure of both compressed air and diesel fuel must be adequate for drilling and coring a 6 in. hole to 1000 ft, since this was the rated capacity of the drill rig and pump selected for the investigation, based on use of water and water-based drilling muds in unfrozen rocks and soils.
4. A minimum subsurface temperature of 15°F was assumed, and thermal disturbance of hole wall and core were to be minimized.

Therefore, based on calculations shown later in this paper, the system should be capable of delivering 100 gal/min of diesel fuel at 400 psi at 15°F with an ambient air temperature of 70°F or 500 cu ft/min of compressed air at 100 psi at the same ambient air temperature.

The method used to estimate the heat gains of the drilling fluid due to the warm surface lines and tanks and due to frictional resistance to flow in the drill pipe and hole are presented in the second part of this paper. It was found that a five-ton (60,000 Btu/hour) unit would meet the design criteria for the fluids given above. A portable machine of this capacity was built that weighed approximately 5000 lb and was 6.5 ft high, 4 ft wide, and 6.5 ft long. A Freon compressor was driven by a 30 hp gasoline engine. Expansion of the Freon chilled a supply of "brine" (ethylene glycol). The brine could be circulated through either of two heat exchangers, one of which was used to chill the diesel fuel and the other to chill a flow of compressed air. The diesel fuel chilling coils were designed to be lowered into the open metal mud pit, and the air chilling coils were contained in a pressure vessel which followed an air-to-air heat exchanger in the compressed air line.

INITIAL DRILLING FLUID REFRIGERATOR TRIALS, 1958

In summer 1958, a Failing-1500 rig on a tracked trailer, a complete set of coring and drilling tools including specially designed coring bits, and the refrigeration unit described above were taken to the Fairbanks Permafrost Research Station of the Arctic Construction and Frost Effects Laboratory (now Alaska Field Station, CRREL). Drilling and coring trials were made in 200 ft of frozen silt that had a minimum ground temperature of about 28°F below 50 ft. This was considered an ideal test situation in view of the ambient air temperatures, which occasionally reached 80°F.

It was found that the frozen silts and sands could be drilled very rapidly and efficiently with nearly all types of drag and rock bits. In the warmest weather, all cuttings were delivered to the surface in a frozen condition by the flow of refrigerated diesel fuel, and no casing or mud was required to maintain hole walls except in the thawed active zone. After initial drilling trials, coring was attempted with equally promising results. Cores as small as 2-3/4 in. were regularly recovered, often in unbroken lengths as long as the core barrel would permit.

Some difficulties were encountered, however. Large amounts of fine cuttings were collected in the diesel fuel chilling pit, substantially inhibited the efficiency of the cooling coils and necessitated frequent cleaning. In order to remain independent of an electrical power source, no thermostat system for drilling fluid temperature control had been provided. Nearly constant attention of one man was required for manual control, and it was difficult to maintain the drilling fluid temperature at a constant level.

Although results with diesel fuel were very encouraging, greater difficulties were encountered with compressed air. The system was able to refrigerate the required flow of air to the desired temperatures for short periods; but time consuming defrosting was frequently required, particularly during periods of high ambient humidity. Even greater difficulties were encountered in cooling the heavy drilling string to ground temperature before commencing drilling or coring. This pre-cooling was necessary since cuttings of frozen soil rising on the air stream in the annulus between hole wall and tools would stick to the warm tool string and block the upward flow of air. At the mass flow rates required for each of the two different fluid streams to remove the cuttings from the hole, the diesel fuel has approximately 30 times the capacity for heat removal as the compressed air.

$$C_{pd} Q_d \approx 30 C_{pa} Q_a \quad (1)$$

MODIFICATIONS BASED ON INITIAL TRIALS

To overcome the problem of fine cuttings clogging the diesel

fuel-cooling coils, the open-coil bundle was replaced by a shell-and-tube heat exchanger designed for use between the conventional mud pump suction and the settling pit. A second and better baffled mud settlement pit was added that allowed the fallout of all particles larger than silt size. Mud is taken from the downstream end of the settlement pit by a small high-volume, low-head pump and driven through the bundle of tubes which are 5/8 in. in dia.; and cold brine is circulated around the tube bundle in the insulated shell. Cross sections were so arranged that the fluid velocity was much greater in the tubes than in the settlement pit, so as to prevent the lodging of large cuttings in the heat exchanger tubes. The discharge end of the heat exchanger was fitted with a thermostat that controlled a motor driven bypass valve in the brine system. Thus, drilling fluid temperature could be automatically controlled within a preselected range of approximately $\pm 2^\circ\text{F}$, which was adjusted to bracket the expected ground temperature.

TRIALS WITH MODIFIED REFRIGERATION IN FROZEN SILT AND GRAVEL, 1959

With these modifications, the system was again taken to the Fairbanks area for trials in the summer of 1959. Again, tests were made in the frozen silt in order to evaluate the new modifications of the diesel fuel heat exchanger and to attempt to improve techniques for the use of compressed air. The modifications described above proved very successful, particularly when using diesel fuel. It was hoped that increased coring bit clearance for improved air flow would offer at least a partial solution to the compressed air problem; however, efficient use of this medium still proved most difficult, chiefly for the reason demonstrated in (1).

The rig and refrigerator were then moved to a site underlain by 50 to 80 ft of frozen gravels in order to explore the possibilities of the diesel fuel refrigeration system for obtaining core samples of this difficult material. After a little experience, it was found that good cores of frozen gravel and frozen sandy gravel could be taken with reasonable regularity in warm weather. Although the longest unbroken pieces of core were never longer than 3 ft, cobbles as large as 4 in. in dia. were generally cut clean by the diamond bits, even when only bonded by ice no colder than 27°F. Oil-based mud additives were used to adjust viscosity and specific gravity of drilling fluid with considerable success.

CONCLUSIONS BASED UPON EXPERIMENTAL INVESTIGATIONS

The very satisfactory results of the seasons of 1958 and 1959 demonstrated that by using refrigerated diesel fuel, holes may be drilled and excellent quality, thermally undisturbed frozen cores may be obtained from any fine or coarse grained permafrost soil at any season of the year. We cannot recommend the use of refrigerated compressed air in warm weather for the reasons given above; however, good results might be obtained in winter. If the ambient air is cool enough (20°F or cooler) and if subsurface conditions are favorable, an air-to-air heat exchanger might be used to advantage over the refrigerated diesel fuel system.

Work described above was experimental and confined to soils consolidated by ice at relatively shallow depths. A full scale operational test was desired.

PROJECT CHARIOT: DRILLING, CORING, AND CORE SHIPMENT

Geological and geophysical investigations, preliminary to the projected firing of nuclear explosives at a considerable depth below the surface as a cratering experiment at the Atomic Energy Commission's (AEC) Project Chariot in northwestern Alaska, required that exploratory holes be drilled and cored to depths of approximately 1000 ft in rocks frozen to about that depth. It was also considered highly desirable that cores be taken in the frozen state. A drilling contractor was engaged to core two of these holes in the summer of 1959. Using NC continuous wireline coring equipment, he cored one hole to

598 ft and drilled and cored another to 1172 ft. Unfortunately, the relatively warm water from a nearby creek was used as the drilling fluid, and no core was recovered in the frozen state. Further, the warm fluid thawed the ice that bonded the fragments of the badly crushed fine-grained siltstone and mudstone, causing the hole walls to cave.

Accordingly, arrangements were made with the U.S. AEC and the U.S. Geological Survey (USGS, which was responsible for geological and geophysical investigations) to attempt to drill or core (or both) two or three holes to a depth of 1000 to 1200 ft at the Chariot site during the summer of 1960. Core was to be taken in the frozen state and maintained in that state in the field and during transportation to the CRREL (then SIPRE) cold laboratory in Wilmette, Ill., and to the USGS cold laboratory at Menlo Park, Calif.

Using the drilling equipment and refrigerator described above, the holes were drilled with 3-7/8 in. rock bits; and approximately 10 ft of core was taken every 100 ft. Diamond Core Drill Manufacturers Association large series, double-tube, swivel-type core barrels (which took 2-3/4 in. core from a 3-7/8 in. hole) were used with both internal and bottom discharge type diamond bits. On the first hole, 10 ft of frozen colluvial silt was encountered, and about 9 ft of this was recovered as frozen core. Four-inch casing was set to 16 ft (6 ft into the bedrock surface), and a seal was made by introducing water and allowing the casing to freeze in place. Drilling and coring was initiated in the fine grained frozen siltstone. This hole was drilled to a depth of 1200 ft. Approximately 10 ft of coring was attempted at 100 ft intervals which yielded 82.5 ft of frozen core. Recovery for the cored portion was 95%. A string of NX (3-1/2 in. OD) casing was set in the 3-7/8 in. hole to protect a thermistor cable. It went easily to the bottom demonstrating complete absence of caving. The second hole was drilled and cored in a similar manner to a depth of 1000 ft. This hole was located just above an ocean beach, and 27 ft of thawed beach gravel was encountered above the bedrock surface. The round, clean gravel could not be cored, and 4 in. casing was set into bedrock and sealed by freezing as before. Seventy-one ft of frozen core was recovered with 86% recovery. Most of the core loss occurred in two or three runs when the core barrel became blocked by failure of the core along near vertical joint cracks. As before, easy insertion of the 3-1/2 in. casing showed that the competency of the wall rock had been maintained by the cold fluid.

Thermistor cables were installed in both holes by the USGS and in one hole by CRREL. Very accurate ground temperature measurements were obtained. Description of these measurement systems are reported in this volume by Hansen [6]. Because holes were drilled with minimal temperature disturbance due to the drilling fluid, hole temperatures that were probably within 0.02°C of equilibrium with the rock temperature were measured only a few months after drilling the holes [7]. Thermistor cables were inserted in the diesel fuel-filled hole which allowed removal of the cable for repairs if required; in fact, one cable was easily removed after a period of about a year for recalibration and use elsewhere.

Cores were stored at the site in domestic freezers powered by a small portable generator arranged so that the freezer thermostat automatically started the generator. The freezer was charged with dry ice and remained without power during air transport to Wilmette, Illinois.

PROJECT CHARIOT: CORE ANALYSIS

After detailed logging and photography, part of the core was shipped to the USGS laboratory at Menlo Park, Calif., where determinations of the thermal conductivity of the frozen core were made to calculate heat flow to the surface at the site [7]. At CRREL, bulk density, total liquid content, and total water content were determined for 21 frozen samples. The cores had absorbed considerable diesel fuel; and when dried to constant weight, the weight loss was thought to be due in part to volatilized diesel fuel. A Soxhlet extraction process was adapted,

and true water content was determined. Total liquid contents ranged from 0.5 to 4.4%; total water contents for the same set of samples were between 0.2 and 2.4% (by weight of dry solids). Determination of amount of unfrozen water in these samples would be of great interest, since the strength of this particular rock in the frozen state appeared to depend on ice bond. Methods of measuring ice content (i.e., amount of unfrozen water) were investigated, and we are now able to do this with reasonable accuracy by calorimetry. However, the validity of data taken from samples that were stored at -20° to -40°C for three years is doubtful; therefore, ice content determination will not be attempted. A detailed description of the coring operation and laboratory work can be found in [10].

DIRECT EXPANSION REFRIGERATORS FOR DIESEL FUEL ONLY

The two-stage refrigeration system described above was required so that either diesel fuel or compressed air could be cooled interchangeably. Since our experience with the refrigeration of compressed air in warm weather was not encouraging, it became obvious that the brine stage of heat transfer might be eliminated by using the Freon to cool the drilling liquid directly. Two drilling fluid refrigerators of this type have been built, but neither has been used in the field at this writing. Freon is circulated in the tube bundle of a shell- and tube-heat exchanger, and drilling fluid is driven through the shell by a low head, high volume pump. Several special large drain taps are provided on the bottom of the shell so that it may be easily cleared of cuttings. Final evaluation of this type of system will require field use. However, economies of weight and power were definitely achieved; increased ease of operation and temperature control can be expected.

CALCULATION OF REFRIGERATION REQUIREMENTS

Two sources of energy contribute to the elevation of the temperature of the drilling fluid above the desired (or subsurface) temperature; one is external, the other internal to the fluid stream.

Most obvious of these is the warm ambient air surrounding the surface pipes, tanks, etc.,—i.e., external to the fluid stream. For summer operation, this may be reduced to 20 or 30% of the total refrigeration requirement by adequate insulation of pipes, tanks, and hoses. Careful application of 1 to 1.5 in. of insulating material having a thermal conductivity of about 0.25 Btu/ft/hour/sq ft/°F to tank surfaces should be sufficient. Pipes and hoses will require a thickness equal to about one-half of their OD. If operations are to be carried out in seasons when the ambient air temperature is equal to or less than the required fluid temperature, the surface heat gains may be neglected.

It is also necessary to remove by refrigeration all of the energy applied to the fluid stream by pumping. Thus, if the refrigerator is to be designed for a specific pumping unit, the refrigeration requirements internal to the fluid stream are simply equal to the power input of the pump.

If the pumping unit is to be specified, then the total maximum head losses in the drilling fluid system must be calculated. When using diesel fuel or muds based upon diesel fuel, head loss values for water will not be correct due to the different viscosity and density. It should be noted that while higher viscosities and fluid densities will give greater head losses, lower fluid velocities will suffice to lift the same size chips, since the carrying power increases with viscosity and density. Various forms of Darcy's law for both circular and annular cross sections may be used to determine the frictional head losses. The formulas below were used in the calculations.

For total refrigeration required

$$R_t = R_i + R_e \quad (2)$$

From operational experience we find that

$$R_t \approx 1.3 R_i$$

$$R_i = \text{Hhp}_{in} \times 42.4 \text{ Btu/min/hp} \quad (3)$$

$$R_t = 1.3 \text{Hhp}_{in} \times 42.2 \text{ Btu/min/hp} \quad (4)$$

where 1 ton = 200 Btu/min.

If pump capacity is specified, the volumetric discharge rate required is

$$\text{GPM} = VA (60 \text{ sec/min}) \times (7.48 \text{ gal/cu ft}) \quad (5)$$

where A is area of drill rod hole wall annulus (sq ft).

Having established the required volumetric flow rate, the velocities in all of the other elements of the drilling fluid system are easily obtained from the geometry of drill rods, core barrels, and hole; an approximation of the pump pressure required to overcome the head losses in the entire system may be calculated from Darcy's law.

For circular sections

$$H_L = \frac{fLV^2}{D2g} \quad (6a)$$

For noncircular sections

$$H_L = \frac{fLV^2}{D_e 2g} \quad (6b)$$

[D_e is designated as: $D_e = 4 \text{ HR}$ (hydraulic radius)]

$\text{HR} = A/P$ for an annulus, $D_e = D_o - D_i$.

For f above, the Reynolds' number must be obtained by

$$\text{Rn} = \frac{DV \rho_m}{\mu_e} \quad \text{for circular sect.} \quad (7a)$$

$$\text{Rn} = \frac{D_e V \rho_m}{\mu_e} \quad \text{for noncircular sect.} \quad (7b)$$

Viscosity may be converted from kinematic to absolute by

$$\mu = \nu \rho \quad (8)$$

For conversion to English engineering units $\mu_e = \mu \times 6.7 \times 10^{-4}$

When Rn has been obtained, ϵ/D of ϵ/D_e (relative roughness) is required to enter a standard hydraulic friction factor diagram (CRANE A-24) for f . For the surface of most drill rod and drill pipe, $\epsilon/D \approx 10^{-5}$ to 10^{-6} . For the annular flow between drill string and the rougher hole wall, the highest ϵ/D available on the friction factor chart is used, (usually $\epsilon = 0.05$). The value of f is obtained for both hole wall and drill string surfaces and weighted according to the ratio of the area of rough surface to the area of smooth surface. Hughes suggests a (weighted ?) $f = 0.5$ for the annular flow in oil field holes; however, diamond drill holes, particularly in hard rocks, are much smoother.

Head losses may now be obtained for all of the circular and annular sections. For head losses directly in psi using diesel fuel (specific gravity = 0.815):

$$H_L (\text{psi}) = \frac{0.35fLV^2}{D2g} \quad (9a)$$

or

$$\frac{0.35fLV^2}{D_e 2g} \quad (9b)$$

However, Crane suggests that when the width of the annulus becomes very small and flow becomes laminar (as it does with diamond drill wire line rods), HR is then the width of the annulus; thus, for small annuli

$$D_e = \frac{D_o - D_i}{2}$$

At the couplings of diamond drill rods, where the inside diameter is abruptly reduced and where the tool joint of oil field type drill pipe constricts the uphole annular flow, there will be appreciable energy losses due to the abrupt constrict-

tion and expansion of the cross section. These may be computed by

$$H_L = K \frac{V^2}{2g} \quad (10)$$

V is the velocity in the smaller diameter (ft/sec)

D_1/D_2 is used to determine K from an empirical relationship given in hydraulic handbooks (Crane p. A-26). D_1 is smaller diameter, D_2 is larger diameter (any units, but similar). Separate values of K must be determined for contraction and for expansion. It is also suggested that the frictional head losses in the short, reduced cross sections of couplings and tool joints be analyzed using the total length of all of the couplings or joints for L.

Frictional head losses in surface lines may be estimated as 10 to 20% of the total losses in the drill rods, core barrels and bits, and drill rod-hole wall annulus. With total head loss and volumetric discharge rate established, the hydraulic power output required from the pump is calculated by

$$\text{Hhp}_{out} = \frac{\text{GPM } H_L \rho_m}{33,000 \text{ ft-lb/min/hp}} \quad (11)$$

where H_L = total head losses (ft of liquid) and ρ_m = density of liquid (lb/gal).

The efficiency of most positive displacement duplex piston pumps used for rotary and diamond drilling is approximately 85%, therefore

$$\text{Hhp}_{in} \approx 1.15 \text{Hhp}_{out} \quad (12)$$

ACKNOWLEDGMENTS

To acknowledge all individuals, manufacturing and contracting firms, and government agencies that substantially contributed to this project is impossible here. However, I am especially grateful for the encouragement of W. K. Boyd, Tech. Dir., CRREL. The skill and ingenuity of Jack Tedrow as the drilling foreman during most of the work is also deserving of special mention.

NOTATION

A	area of flow cross section (sq ft)
C_{pa}	specific heat of compressed air (Btu/lb/°F or cal/g/°C)
C_{pd}	specific heat of diesel fuel (Btu/lb/°F or cal/g/°C)
D	dia. of circular cross section of flow (ft)
D_e	equivalent dia. for noncircular cross sections (ft)
D_i	inside dia. or smaller dia. of annulus (ft)
D_o	outside dia. or larger dia. of annulus (ft)
GPM	volumetric discharge rate (gal/min)
Hhp_{in}	pump shaft input (hp)
Hhp_{out}	pump power output (hydraulic hp)
H_L	friction head loss (ft of liquid)
K	resistance coefficient
L	length of flow path (ft)
P	wetted perimeter (ft)
Q_a	required mass flow rate compressed air (lb/min)
Q_d	required mass flow rate diesel fuel (lb/min)
R_e	refrigeration requirements external to fluid stream (tons or appropriate energy rate unit)
R_i	refrigeration requirements internal to fluid stream (tons or appropriate energy rate unit)
Rn	Reynold's number (dimensionless)
R_t	total refrigeration required (tons or appropriate energy rate unit)
V	velocity of drilling fluid (ft/min)
a	area of flow cross section (sq in.)
f	friction factor (dimensionless)
g	acceleration of gravity (32 ft/sec ²)
ϵ	absolute roughness (ϵ/D = relative roughness or ratio of size of irregularities to dia.)

μ	(metric) absolute viscosity
μ_e	(English) absolute viscosity (lb/ft-sec)
ν	kinematic viscosity (sq cm/sec)
ρ	(metric) fluid density (g/cc)
ρ_m	density of fluid (lb/cu ft)
ρ_{me}	density of fluid (lb/gal)

REFERENCES

- [1] Peter C. Bremmer. "Diamond Drilling in Permafrost at Resolute Bay, NWT.," Publ. Dominion Obs., Ottawa, 1958.
- [2] J. A. Pihlainen, G. H. Johnston. "Permafrost Investigations at Aklavik: 1953," Tech. Paper 16, Natl. Res. Coun., Can., 1954.
- [3] M. J. Hvorslev, T. B. Goode. "Core Drilling in Frozen Ground," Tech. Rept. 3-534, Corps Engrs. Waterway's Exptl. Station, Vicksburg, Miss., Jan. 1960.
- [4] R. J. E. Brown. "The Distribution of Permafrost and Its Relation to Air Temperature in Canada and the USSR," Arctic, Vol. 13, Sept. 1960.
- [5] J. E. McCoy. "Exploration for Permafrost at Fort Churchill," Spec. Rept. No. 46, unpubl. MS., CRREL.
- [6] B. L. Hansen. "Instrumentation for Temperature Measurements in Permafrost," in this volume.
- [7] A. H. Lachenbruch, G. W. Greene, B. V. Marshall. "Permafrost and Geothermal Regime," Bioenvironmental Features of the Ogotoruk Creek Area, Cape Thompson, Alaska, in press.
- [8] G. R. Lange, T. K. Smith. "Exploration Drilling and Coring and Analysis of Frozen Cores," ibid.

The following manuals and handbooks were found useful in the hydraulic and refrigeration calculations: Eshbach, Handbook of Eng. Fundamentals, 1952, John Wiley. Brantly, Rotary Drilling Handbook, 1961, Palmer Publications. Flow of Fluids Through Valves, Fittings and Pipes, Crane Co. Tech. Paper No. 410. Hughes Tool Co., Bull. No. 1-B "Hydraulics in Rotary Drilling," 1957. Shaw and Loomis, Cameron Hydraulic Data, Ingersoll - Rand Co., 1951. Standards, Diamond Core Drill Manufacturing Assn., Bull. No. 2. J. D. Cumming, Diamond Drill Handbook, 1951, J. K. Smit & Sons of Canada.

DISCUSSIONS

GEORGE L. GATES—Lange's paper is an important addition to the meager literature on methods of drilling and coring in permafrost. The search for petroleum in Alaska also has resulted in a background of information on drilling and coring in permafrost. During 1944-1953, eleven wells were drilled on the Umiat structure in U.S. Naval Petroleum Reserve No. 4 in the Arctic Circle. Working in cooperation with the U.S. Navy, the U.S. Geological Survey and the Federal Bureau of Mines have published reports [1, 2, 3] on the technology of drilling and coring in permafrost using rotary and cable tools and several different drilling fluids—including water-base mud, crude oil, and oil-base mud.

The purpose of these coring operations was to obtain the properties of the petroleum reservoir rock—particularly the oil and water content. Although they were not frozen, the cores were quickly wrapped in aluminum foil, placed in cans, covered with paraffin, and sealed. Later the cans were opened in the laboratory, and the cores were analyzed for the oil and water content, porosity, and permeabilities to several fluids. A tracer was added to the oil-base drilling fluid, and analysis of the oil extracted from the core samples showed that an average of 3% of the pore space was filled with oil filtrate from the drilling fluid. Study of the cores showed a decrease in permeability with contact with water and brine, and also with a lowering of the temperature. Wells completed with oil-

base drilling fluids were more productive than those completed with water or brine in the hole.

Reports show that petroleum was produced from permafrost areas in Russia and Canada also.

Another problem that requires knowledge of properties of frozen ground is the underground storage of liquefied petroleum gases. These liquids have been successfully stored underground at a temperature of -259°F [4, 5] for use during periods of peak demand.

REFERENCES

- [1] F. R. Collins, H. R. Bergquist, M. C. Brewer, G. L. Gates. "Test Wells, Umiat Area Alaska," U.S. Geol. Surv. Prof. Paper 305-B, 1958.
- [2] George L. Gates, W. Hodge Caraway. "Well Productivity Related to Drilling Muds: Umiat Field, Naval Petroleum Reserve No. 4, Alaska," U.S. Bureau Mines Rept. Invest. 5706, 1960.
- [3] Oren C. Baptist. "Oil Recovery and Formation Damage in Permafrost, Umiat Field, Alaska," ibid. 5642, 1960.
- [4] Oren C. Baptist. "Frozen Earth Liquefied Natural Gas Storage," Gas Age, Vol. 130, No. 4, April 1963, pp. 22-28.
- [5] B. E. Eakin, C. G. von Fredersdorff. "Belowground Storage of Liquefied Natural Gas," Chem. Engr. Progr., Vol. 58, No. 11, Nov. 1962, pp. 47-54.

JERRY BROWN and PAUL SELLMANN—Occasionally specialized field investigations require chemically clean techniques for obtaining frozen core samples. As an addition to the paper by Lange, we would like to describe briefly the equipment used at Barrow, Alaska, in 1963 to obtain physically and chemically undisturbed frozen soil samples. The fluid used was compressed air. It was cooled in an air-to-air aftercooler which took advantage of the cold ambient temperatures. Coring was feasible to ambients slightly below freezing. A small portable drill rig (Concore A5 Junior), similar to the one shown in the movie "Building in the North," was employed. It was mounted on a one ton sled and pulled with a weasel which provided maximum stability and mobility. A single-wall core barrel, commonly used in concrete coring, and a removable tungsten carbide, saw tooth (Wyr-lok) bit was used. Removal of the cuttings was facilitated by increasing the outside annulus of the standard bit to 1/8 in. A total of 300 ft of 2-1/2 in. dia. core was obtained from the frozen, saturated, and supersaturated silts and ice-wedge ice. Daily sharpening and occasional replacement of the carbide tips were required. The coring was confined to the upper 5 ft of permafrost.

This coring method, which employs naturally refrigerated compressed air is recommended when chemically uncontaminated cores are required. It is further suggested that such coring be reserved, whenever possible, for spring when ground and air temperatures are sufficiently low to prevent melting during and after the coring operation.

CLOSURE

I would like to thank Gates (for one discussion) and Brown and Sellmann (another discussion) for their valuable expansion of the subject matter of my paper. It is indeed regrettable that the petroleum industry was not better represented at the conference, because, judging by Gates' discussion, they could have contributed substantially to our knowledge.

The following remarks were written with the problems of subsurface exploration for (civil) engineering projects in mind; however Gates' remarks suggest that they might also apply to certain aspects of the petroleum industry, such as recovery techniques and other problems of reservoir engineering.

Several papers in this session describe the sort of subsur-

face exploration program that is often required by an engineering project of any importance in areas underlain by permafrost. In these cases, the time allowed to gather the required information has been limited either by the construction schedule or the short field season. Funds (synonymous with personnel and equipment) have also been limited, since it is good engineering practice to allow only a certain fraction of the estimated design costs for exploration. These papers describe efficient means of gathering the required information for design, and the engineer who is responsible for the design and siting of structures on permafrost is well advised to study these papers when planning his subsurface exploration program.

However, the preceding discussions of Gates and of Brown and Sellmann as well as other papers in this session [1, 2, 3] show that if time and money are not severely limited, much detailed, accurate information can be obtained from beneath the surface of permafrost terrain.

Based on the above referenced papers and discussions and on conversations with these and other investigators, we find that the following subsurface exploration capabilities are now available:

1. Holes may be drilled and frozen cores may be taken at any time of year to a depth sufficient to penetrate any reported thickness of permafrost in North America. If the depth-temperature relationship is known or can be estimated (this can be determined from a preliminary hole from which no core is taken), the drilling fluid temperature can be adjusted to cause a thermal disturbance to the core of no greater than $\pm 1.0^{\circ}\text{C}$.

2. Use of refrigerated fluid reduces thermal disturbance to the hole wall so that equilibrium ground temperatures are reached a short time after the cessation of drilling and the installation of a thermistor cable.

3. Frozen cores taken in this way can be stored at the site of drilling in portable freezers, modified to cycle over a narrow temperature range, and adjusted to the appropriate ground temperature. Equipment for on site storage of this sort is relatively inexpensive and requires only a dependable source of electrical power.

It is highly desirable to perform laboratory work on cores of frozen rock and soil as soon as possible after obtaining them, since appreciable losses of both the liquid and solid phases of water in the sample will result from evaporation during storage at any temperatures, even below the freezing point. We dare not reduce the temperature of the sample below its original ground temperature for fear of inducing irreversible changes in the ice content or phase composition of the sample water. We can only minimize these evaporative losses and hysteresis-like changes by performing analyses as soon as possible after the sample is taken from the borehole. By using portable "walk-in" refrigerators, a good deal of the analytic work could be accomplished at the drilling site, thus reducing the time available for evaporative losses and the cost of refrigerated transport to permanent laboratory facilities. Important tests that could be done in this manner are: Density, phase composition of the water, total water content, and dynamic elastic properties. Other tests in which delay would cause error could also be run in the field.

If the facilities of permanent refrigerated laboratories are required, samples may be flown to the laboratory in appropriate insulated containers. While we have not yet accom-

plished either core storage and transport to such close temperature tolerances ($\pm 1.0^{\circ}\text{C}$), or analysis of frozen core at the drilling site, there is no reason why they cannot be accomplished, nor should they be outrageously expensive.

4. The temperature in a borehole may be measured with a precision of $\pm 0.02^{\circ}\text{C}$ at any depths required in permafrost. Hansen describes the instrumentation required [2].

5. Barnes [1] demonstrated how the upper surface of permafrost may be described with considerable accuracy. His excellent review also suggests that other useful properties of the permafrost may be measured in place by geophysical methods.

While information of this degree of precision is not generally required for most engineering projects, there are special cases where the extra expense of exploration with precision may be justified—in fact, required. Gates', Brown's, and Sellmann's discussions illustrate some of these cases.

If we contemplate the founding of a very heavy, expensive, or important structure upon permanently frozen rocks or soils, we probably must be prepared to use all or some of the techniques described above. The proposed construction of Rampart Dam on the Yukon River may very well become a case in point. A thorough knowledge of the distribution and mode of occurrence of ice and free water in the permafrost bedrock and soils both at the dam site proper and near the shore line of the proposed reservoir will be fundamental to the final design.

Another area where precise exploration has already proven to be valuable is in basic investigation of permafrost as a geologic phenomenon. This point is well illustrated by the preceding discussions. Lachenbruch et al [4] and the author [5] have reported efforts in this regard at Project Chariot. If Antarctic and Greenland icecaps may be defined as permafrost, a large scale precise subsurface exploration program was carried out during the IGY. This program in continuing, with greater precision and far deeper penetrations of the icecaps. In fact, some of the equipment, instruments, and methods that we have only recently begun to apply to the subsurface exploration of permafrost were originally developed for the IGY program. It appears quite reasonable that careful, precise subsurface exploration in selected permafrost locations could shed some light on questions of geologic import, such as the date of the onset of permafrost and the magnitude of the climatic change that caused it. Lachenbruch's extensive work at Barrow and Chariot demonstrates the potential of these methods when applied to geologic research.

REFERENCES

- [1] David F. Barnes. "A Review of Geophysical Methods for Delineating Permafrost," in this volume.
- [2] B. Lyle Hansen. "Instrumentation for Temperature Measurements in Permafrost," in this volume.
- [3] G. Robert Lange. "The Use of Refrigerated Fluids for Drilling and Coring in Permafrost," in this volume.
- [4] A. H. Lachenbruch, G. W. Greene, B. V. Marshall. "Permafrost and the Geothermal Regime," Bioenvironmental Features of the Ogotoruk Creek Area, unpubl. data, Project Chariot, U.S. AEC.
- [5] G. R. Lange, T. K. Smith. "Exploration Drilling and Core Analysis," ibid.

AIRPHOTO INTERPRETATION APPLIED TO ROAD SELECTION IN THE ARCTIC

J. D. MOLLARD, J. D. Mollard & Associates, Ltd.,
J. A. PIHLAINEN, * Arctic Consultant, Canada

Engineering interpretation of terrain conditions from airphotos is particularly important in northern regions because terrain maps detailed enough to intelligently select routes and sites do not exist. Moreover, office airphoto studies can be used to exploit the North's short season for field work.

Techniques of airphoto interpretation and their application to engineering studies in temperature climates are well documented. They can also be applied to northern regions. To a large extent, any inability to fully apply these techniques arises from gaps in our understanding of northern terrain phenomena.

The identification and mapping of terrain information is invaluable to northern engineering; and its appraisal for engineering purposes must keep pace.

THE PROJECT

The asbestos project of Murray Mining Corp., Ltd., is located at Asbestos Hill in the northern tip of Ungava Peninsula (Fig. 1). It is situated approximately 30 miles southeast of Deception Bay on Hudson Strait. The Eskimo village of Sugluk, 60 miles to the northwest, is the nearest point of habitation; the nearest land bases are located at Frobisher Bay and Fort Chimo, 240 and 340 air miles, respectively.

The proposed asbestos development is among the largest considered in the Canadian north. It includes a dock for 10,000 ton freighters; harbor facilities for a 9 month store of mill products (i.e., 70,000 tons or 1,400,000 bags of asbestos); a 40 mile road from dock to mine site; an asbestos production plant to mine and process 3000 tons a day of asbestos ore, with a provision to expand to 5000 tons a day; a townsite accommodating over 1000 workers and their dependents; and, other ancillary facilities, such as an airstrip and a surface-storage reservoir.

While airphoto interpretation was used in the preliminary study of the dock, mill, town, and airstrip sites, this paper deals only with location of the dock-to-mine road.

ENVIRONMENTAL CONDITIONS

The project area is situated in a belt of sedimentary and volcanic Pre-Cambrian rocks approximately 25 miles wide that runs along the 61st parallel from Cape Smith to Cape Wales. These sedimentary and volcanic rocks overlie still older Pre-Cambrian acidic gneiss and granite.

The landscape is a peneplained bedrock upland with an average altitude of 1700 ft above sea level. This surface is occasionally interrupted by deep winding canyons and rounded mountain hills 2000 ft high. Local relief frequently exceeds 1000 ft. Pre-Cambrian bedrocks are either exposed or are masked by a thin veneer of glacial drift and disintegrating colluvial rock detritus.

Climate is characterized by a long cold season rather than by extremes in temperature. The estimated mean annual temperature is approximately 17°F; summer daily maximum temperatures seldom exceeded 70°F; annual precipitation is low and totals about 14 in. with reported snowfall averaging about 6 ft. Strong winds sweep across the peninsula and often attain velocities of 100 mph.

Harsh environment restricts plant growth to the more hardy species: Grasses, sedges, mosses, lichens, low brush, and stunted willows. The closest coniferous trees are nearly 300 miles south. In only one location, near the mine site, has

*Deceased, January 1964

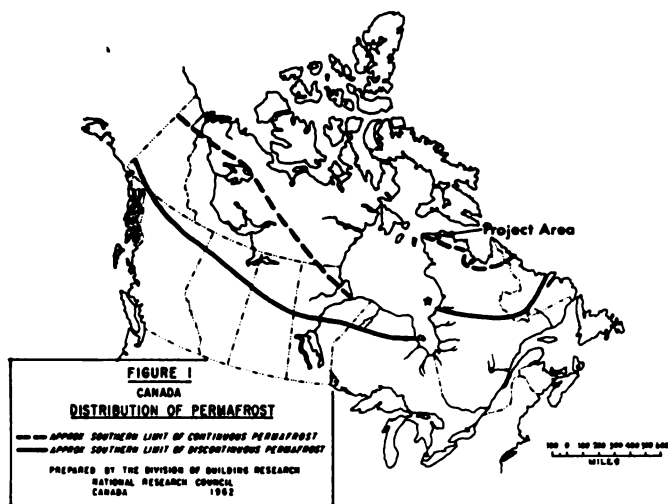

Fig. 1. Map showing project area and distribution of permafrost in Canada

a small growth of stunted willows been observed. Near the coast one finds 1 to 2 ft willow, alder, and ground birch in sheltered environments.

Climatic data and on site drilling experience reveal continuous permafrost in the project area. Observations also suggest that the total depth of frozen material can exceed 500 ft, with a minimum temperature of approximately 20°F at about 100 ft.

An unusual occurrence of permafrost was observed under the waters of Deception Bay. Limited observations here suggest random, sporadic remnants of permafrost. In one near shore borehole, drilled approximately 150 ft out from low tide shoreline, an estimated 20 ft of perennially frozen silty sand is overlain by 17 ft of coarse-grained materials, 16 ft of silty clay and, finally, 30 ft of ocean water.

In the project area the maximum seasonal depth of thaw, commonly known as the "active layer," is about 5 ft. This 5 ft thick active layer occurs in exposed south-facing granular materials that are well drained with essentially no organic cover. An active layer 2 ft deep can be expected in poorly drained, north-facing exposures underlain by fine-grained materials occurring beneath organic cover. Variations in exposure, surficial materials, drainage, and organic cover result in active-layer depths that range between these two extremes.

OBJECTIVES OF THE INITIAL AIRPHOTO STUDY

Before field work began, an initial office airphoto interpretation was made using high-level photography (1 in. = 3333 ft). Objectives were to: (a) Establish a provisional classification of the terrain according to factors believed to significantly affect road location; (b) locate the most likely route as well as "competitive" alternative sections of routes in certain areas; (c) tentatively map and evaluate terrain conditions detectable in airphotos covering a band several miles wide, commencing at the proposed asbestos mine site and ending at the dock site some 40 miles away; (d) map granular materials and make tentative predictions regarding their probable composition and condition; (e) comment on terrain conditions and their engineering implications at previously selected dock, mill, town, and airstrip sites.

OFFICE STUDY OF AIRPHOTOS

Scale of 1 in. = 3333 ft

Before starting to map terrain types the airphoto interpreter should become familiar with the variety, origin, likely composition, and condition of near-surface materials occurring in the region. Accordingly, high-level airphotos showing a wide region between the proposed mine and dock sites were scanned stereoscopically. This study was made before the photographs were annotated. It was anticipated that observation of continuous permafrost effects in localities remote from favored routes might provide diagnostic clues to the origin, composition, and condition of surficial materials along selected routes.

The next step was to classify and evaluate the range and relative importance of terrain features occurring in the area. Hence, an initial provisional route was selected and then restudied to improve certain sections of the original location.

Alternate route segments were marked where terrain conditions along two or more competitive-looking lines appeared about the same. The terrain was then typed along the routes and, to facilitate fieldwork, contact airphotos were appropriately annotated.

Several guidelines were used in selecting the routes marked on high-level airphotos. For example, attempts were made to:

1. Locate where chances of discovering nearby granular material landforms were good. (Except for thin surface layer, granular deposits were expected to be perennially frozen. Prominent thermokarst depressions in some of the glaciofluvial deposits suggested thick silty to fine sandy strata.)
2. Select a route having acceptable vertical and horizontal alignment.
3. Select a route having minimum over-all length.
4. Avoid actively creeping solifluction features on slopes, a characteristic surface expression of the region.
5. Avoid locating the road near residual snow patches and nivation hollows, sources of runoff water that travel down-slope, causing adverse drainage and icing conditions.
6. Avoid steeply sloping corrugated ground where swales act as runoff channels during spring thaws and after heavy summer rains.
7. Avoid terrain situations requiring substantial cuts.
8. Avoid deep valleys and minor depressions likely to harbor snow for prolonged periods, thus increasing maintenance costs.
9. Avoid springs and wet marshy flats in lowlands that might cause icings to form across roadways athwart the path of runoff.
10. Avoid pronounced polygonal ground overlying fine-grained, poorly drained surficial materials.

Selections of first choice and alternate routes were based on evidence interpreted from high-level airphotos. Field work followed preliminary office airphoto study. An attempt was made to rule out less attractive alternate segments by visual inspection from helicopter flights and by periodic examinations on the ground. Remaining routes were to be rephotographed at a lower level. These were marked on existing mosaics along with proposed flight lines. The new photos were taken at a scale of about 1 in. = 1000 ft.

Scale of 1 in. = 1000 ft

Detailed study of the terrain airphotos scaled to a lower level involved:

1. Selecting more refined trial routes. Alternate segments were again marked where the terrain appeared "tough," and suitable alternates were detectable in low-level photos. With minor deviations, trial routes followed the general routes selected from study of high-level airphotos. Spot checking in the field resulted in modifications.
2. Selecting, from among the trial routes, the best line with minimum alternate segments. All other trial lines were erased from the photos.
3. Marking mileages on selected route and on short segment alternates.

4. Examining the entire route to determine, classify, and map the variety of terrain types.

5. Reexamining the photos to delineate terrain types on both sides of the selected route.

6. Marking terrain boundaries in ink.

7. Locating additional deposits of granular material too small to be seen on the high-level photos. All gravel prospects were marked on individual contact photos and these were referenced to the small-scale mosaic.

TERRAIN MAP LEGEND

Typing of terrain from airphotos was based largely on inferred origin, evolution, and composition of landforms as these attributes affect road location, design, construction, and maintenance.

Figs. 2 to 9 reveal terrain types described below; these illustrations also show microfeatures and permafrost indicators mapped along the final route locations. Figs. 10 to 15 reveal ground views taken in July 1961. Symbols and descriptions of terrain types mapped are given below.

Bedrock Deposits

Rock remnants (R) are isolated and essentially bare. Slopes are usually steep, very rough, and broken. Frost-shattered, angular boulders cover a highly uneven bedrock surface.

Colluvial Deposits Formed Largely by Solifluction

Rounded or flattened summits (S) are surrounded by long, smooth, uniform slopes. The flattened topographic highs usually end at lobate-terrace scarps. These landforms are also called "altiplanation plateaus and terraces." They consist of loose surficial accumulations of small and large



Fig. 2. Airphoto shows route location in vicinity of Mile 2. Letters are symbols for terrain conditions described in the text. Arrows point to localities of potential snowdrift. Grades are a major consideration in road location. Note distinctive gullies on terrain D

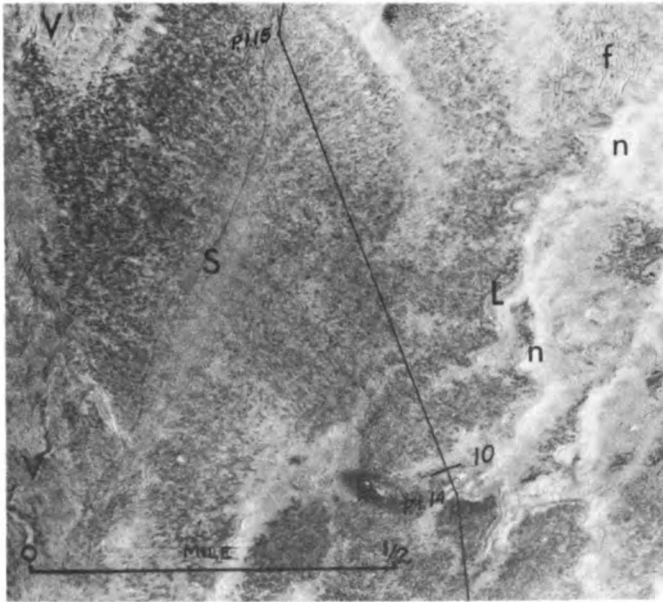

Fig. 3. Principal terrain here is S. Where feasible, the route follows the crests of smoothly rounded hilltops. Drainage and topography here are more favorable and snow drifting is minimized. Potential seepage, runoff, and icing problems can be expected downslope from nivation hollows harboring snowbanks

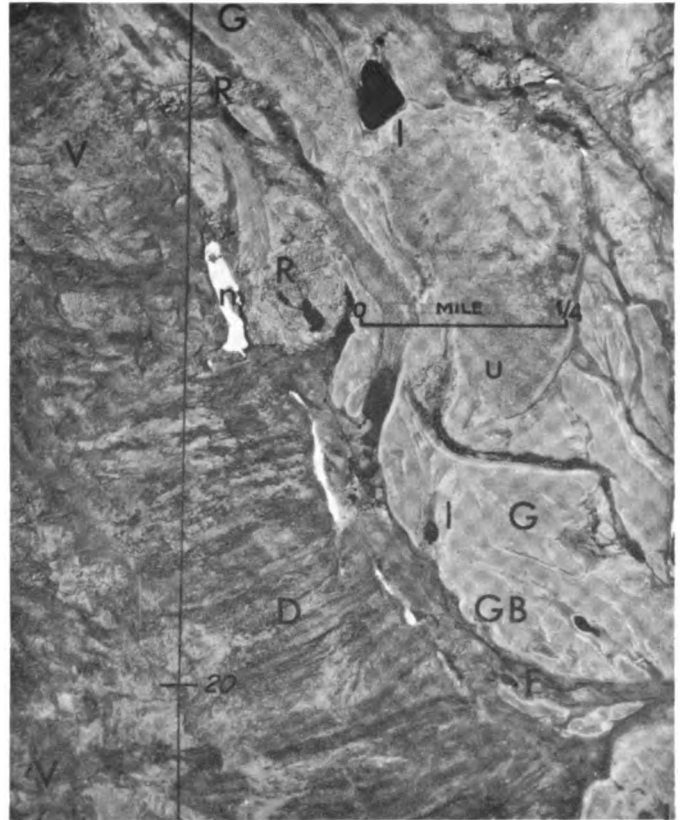

Fig. 5. The route here descends from the upland into a broad valley partly filled with sandy glaciofluvial deposits. A small area of bedrock is crossed at R. Because bedrock is situated in a low-lying area, nearly granular-fill materials (G) can be used to cover the irregular rock surface. Careful stereoscopic viewing is required to differentiate between terrain types "G" and "GB." Note the uniform light tones and distinctive channel markings on this glaciofluvial deposit. Small lakes marked "1" result from melting of large masses of ground ice



Fig. 4. Grade considerations necessitated following the base of this smooth hillside. Three isolated remnants of granular materials were mapped (Gm, see text) for field exploration and testing

angular blocks, finer rock-waste materials, and rubble drift. ("Rubble drift" is a coarse agglomeration of angular debris and large angular blocks set in a fine-grained material of glacial origin—the whole mixture being greatly affected by solifluction).

Lobate terraces and solifluction lobes (L) are terrace-like forms. They partly surround extensive streaked sheets of creeping solifluction debris. Frequently found along lower slopes, these lobes are seldom crossed by well-defined gullies and are composed of coarse angular boulders near scarp faces. Surface detrital materials become successively finer and wetter, upslope from frontal scarps, and consist partly of rubble drift. Depth to bedrock may be several inches to several feet. Ordinarily, slopes on this terrain type are

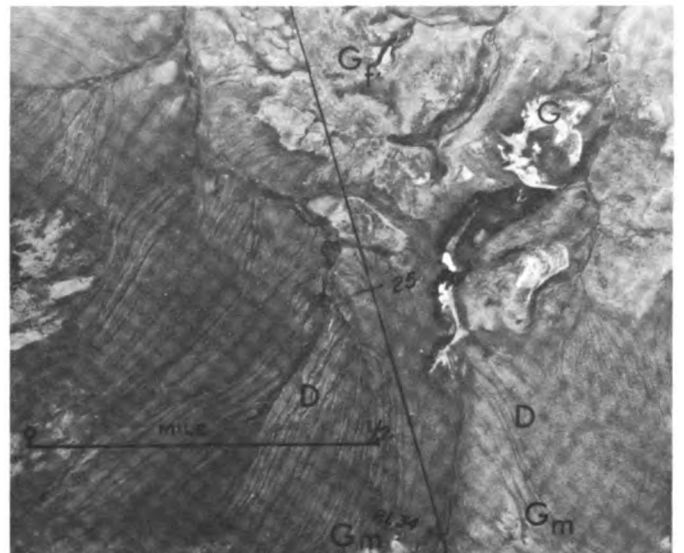

Fig. 6. Location of remnants of glaciofluvial deposits (Gm) suggests subsurface materials on terrain D are silty to fine sandy glaciofluvial materials. At Gf, well-defined ice-wedge polygons, are apparent; at G these stratified melt water deposits are actively eroding (white area)

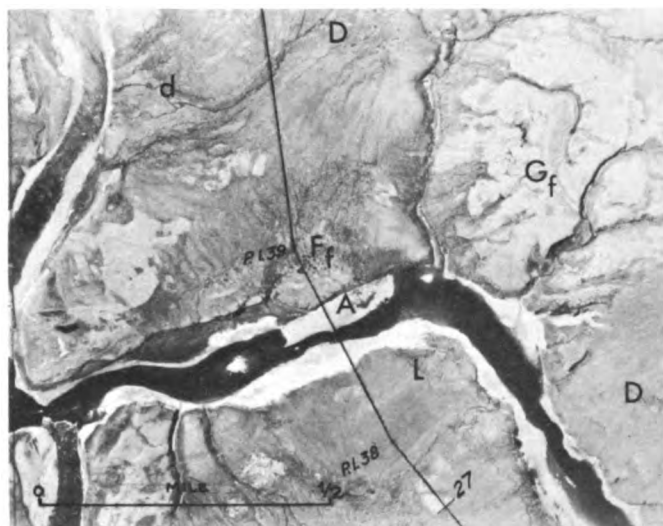

Fig. 7. Coarse bouldery composition of alluvium can be detected at "A." Depressed-center polygons are represented at Ff. Narrow river crossing at "A" and favorable approach conditions make this a promising bridge site. The permafrost table is expected to be relatively deep-lying below the channel section, owing to thermal effects of river water

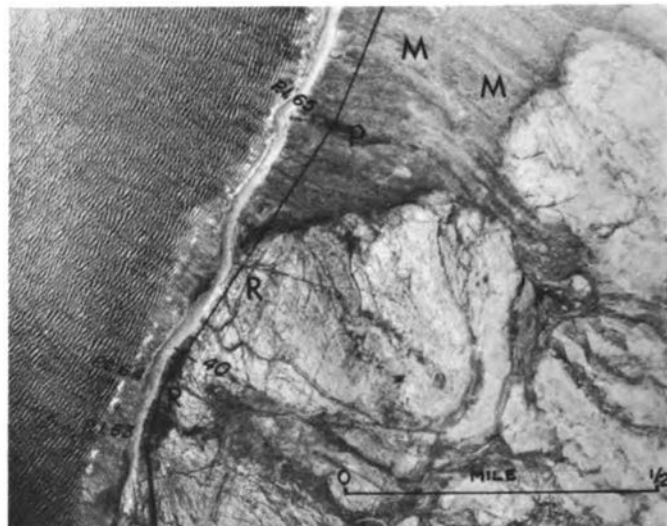

Fig. 9. Area marked "M" is situated well below the former ocean strandlines. That these deposits are fine-grained glaciomarine sediments must be field checked. Small white specks are boulders moving downslope under the influence of surface runoff, gravity, and frost action. The fine dark lines on the bedrock surface are fracture lines where the surficial deposits have been removed by erosion

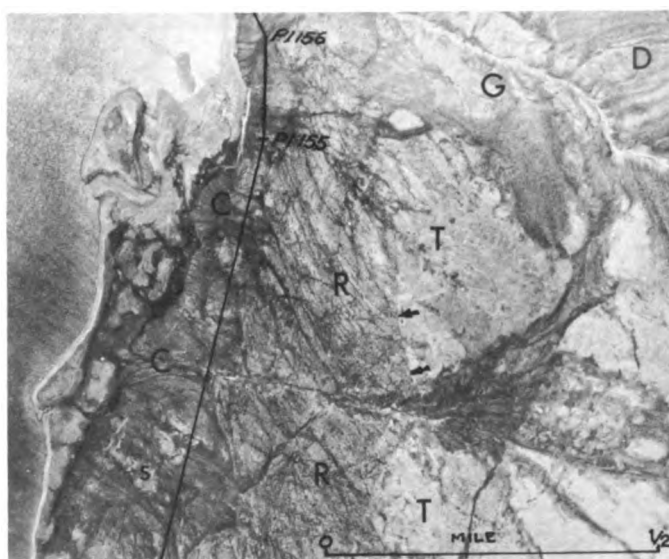

Fig. 8. A marked change in tone and texture of airphoto pattern follows the arrows, which denote a former ocean surface (strand line). Downslope of the arrows on the mountain-side (toward Deception Bay), the surficial materials (T) have been removed by wave action. The bedrock surface is therefore exposed and bedrock fracture systems are clearly evident. During successive lowering of the ocean level wave action on part of a hanging delta (G) has produced a series of detectable wave-cut notches. In this segment of the route, main considerations involve avoiding major rock excavation and controlling grades

steeper than those found on S and flatter than those found on V. Very bouldery to block-studded solifluction lobes and scarps (V) are usually situated just downslope from frost-riven bedrock outcrops composed of large boulders, often occurring as lag concentrates. Slopes are relatively steep and broken. Fossil nivation hollows are a common nearby

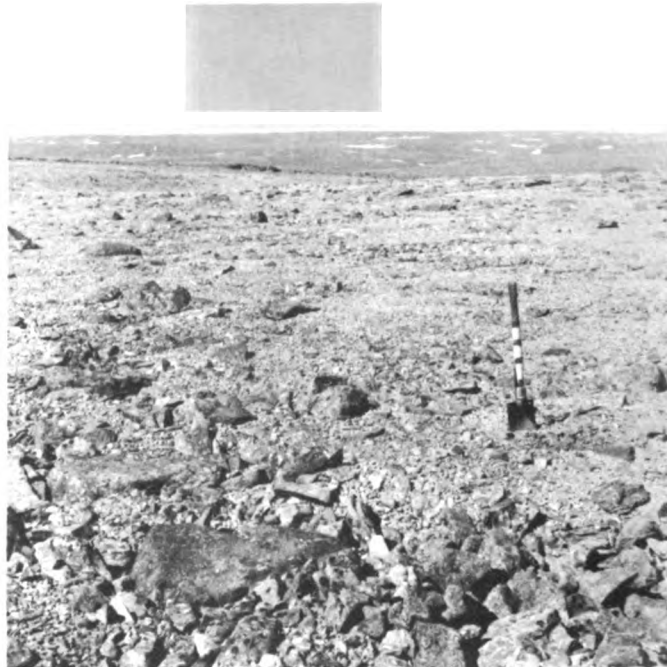

Fig. 10. Colluvial rock detritus on a sloping plain located approximately 0.5 mile east of the 1961 Asbestos Hill Camp. The surface here is free of vegetation. Common microforms are nonsorted rings and streambed boulders concentrated by runoff. Material under the gravel-sized rock-detritus veneer is a silty gravel containing boulders. (Note: All ground photos were taken in July 1961)

feature. These forms and slopes are usually much drier than those mapped in L. Bedrock may project to ground surface; hence, V is frequently found with R. Detritus-mantled, gullied colluvial slopes (D) are indicated by subparallel drainage on colluvial slopes. Relatively few large boulders can be seen in the photos. Slopes are moder-



Fig. 11. General view looking south and down a boulder-strewn water course. Ground slope is about 10%. Water erosion from runoff of snow melt produces these boulder "trails" and patches



Fig. 13. Slumping and erosion of a creek bank in vicinity of Mile 22. Colluvial materials underlying the slightly sloping surface have high ice contents



Fig. 12. Looking north from a V-notch gully about 1 mile east of the 1961 Asbestos Hill Camp. General view of colluvial rock-detritus plain. Much of the light color results from weathered serpentine rock, which is quickly reduced to silt size by the harsh climate

ately steep to gentle and usually appear smooth in airphotos and are composed of rubble drift and angular boulders set in a matrix of fine grained colluvial materials. Multiple sub-parallel rills and larger gullies trend down the steepest pitch of these slopes. These small watercourses, while fairly straight regionally, are irregular in detail. A striated-slope

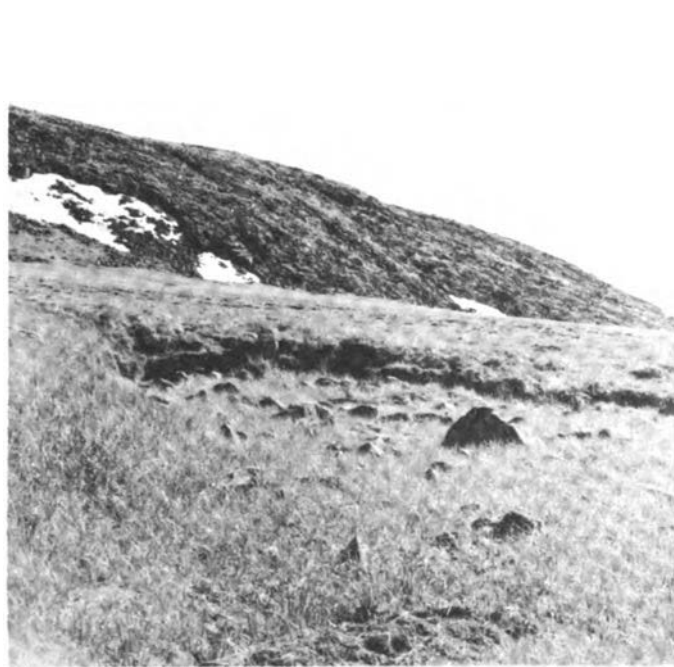

Fig. 14. Portion of a belt of colluvium that exhibits the effects of solifluction. The "nick" in the solifluction lobe outlined by boulders is caused by erosion from melting of snows, which collect here in winter

pattern is therefore developed.

Coarse Glaciofluvial and Alluvial Deposits

Glaciofluvial terrace remnants and stream-dissected glaciofluvial deposits (G) are flat-topped only where stream dis-



Fig. 15. General view of the glaciofluvial deposit about 1 mile northwest of Mile 25. This view shows approximately 200 ft of stratified gray sands and silts containing a few thin gravel lenses

section and mass wasting processes have not obliterated the original constructional topography. Deposits are mainly remnants of valley trains (i.e., valley outwash) and less commonly include dissected kame terraces and hanging glacial deltas; they are composed of silty, fine to medium sands with minor silty and gravelly strata. Poorly drained wet depressions on terrace surfaces show polygonal-crack patterns, which are probably related to a silty surficial veneer.

Glaciofluvial deposits studded with large boulders (GB) are composed of coarse gravelly to very bouldery deposits. In many localities, stream-eroded bedrock occurs at or near ground surface. GB includes coarse ice-contact deposits whose original topography has been much modified by erosion.

Alluvial flood-plain deposits (A) consist of bouldery, channel-lag concentrates along the beds and sides of major rivers and intermittent streams.

Cones and fans (C) of alluvial and colluvial origin are usually found at the base of steep-gradient tributary streams. They are composed of coarse angular, bouldery materials set in a finer matrix.

Fine-Grained Ponded, Slopewash, and Glaciomarine Deposits

Fine-grained, slack-water deposits (F) are situated in poorly drained, gently sloping to depressional sites. This terrain type is composed mainly of silty and silty clay ponded sediments and fine slopewash constituents deposited in slack-water environments. F includes a veneer of ponded silty "backland" deposits on "tilted" glaciofluvial terraces. This terrain is very wet, contains organic material, and unusually high ice contents. Low-centered, ice-wedge polygons are commonplace.

Glaciomarine deposits (M) are composed of silty clay materials with minor scattered pebbles and boulders. These deposits are poorly drained, contain very high ice contents, and are found mainly near the dock site.

Predominantly Glacial Till Deposits

Till-capped rounded hilltops and till-capped gentle slopes (T) often appear as island-like remnants surrounded by wet ground or exposed bedrock. Till is composed of silty clay matrix with small to large rock sizes and appears to offer relatively better

drained sites. Small patches of frost-shattered bedrock can be detected where depth of till is shallow or absent. Frost boils, sorted rings and nets, and other small-scale permafrost microforms appear as diagnostic features in airphotos.

Permafrost-Induced Forms and Conditions

Lower-case letters indicate a variety of permafrost-induced effects. Boils (b), caused by an upward breakthrough of water and silt slurry under pressure that develops a quagmire, appear as small white specks on airphotos. Cave-in slopes (c), resulting from melting of ground ice along shorelines, occur around thaw lakes and along banks of some streams. Drainage courses (d), affected by permafrost, are characterized in photos by a beaded or buttonhole pattern. Frost polygons (f), also called ice-wedge polygons, may in airphotos appear as dark-centered polygons surrounded by a light-toned, weblike network of lines. They are called low- or depressed-center polygons. Normally they are associated with poorly drained fine-grained soils. On the other hand, light-toned polygons surrounded by a darker weblike network usually indicate high- or raised-center polygons. These light-toned polygons usually reflect better drained sites. A very coarse polygon pattern suggests coarser (i.e., stratified fine to medium sand) glaciofluvial deposits. In general, the smaller the polygon size the finer the size of soil particles expected. Inferred tundra mudflows (i), formed by a sudden viscous flow of slide material from scarp faces, appear as hummocky flow-debris situated downslope from a semi-circular niche in a scarp face. Lakes (l), caused by thaw of ground ice, are also called thermokarst lakes. Smoothly rounded mass-wasting surfaces (m), produced by solifluction and other colluvial processes, are easily identified. Original constructional topography is often nearly obliterated on some glaciofluvial deposits, and this expression is marked "Gm" on aerial photographs.

Nival or nivation hollows (n) appear as year-round snow patches retained in niches and hollows. Poorly drained, wet organic materials (p) are often associated with a permafrost table near ground surface. Used as a subscript, "p" may occur with any terrain type except F. Areas indicated by "p" are believed to contain high ice contents. They are often indicated by low-center, ice-wedge polygons (dark centers surrounded by light-toned marginal ridges). Seeps and springs (s) show up in photos as places where fine materials have been washed away, leaving coarse rubble and large blocks. Tilted silty sand terraces (t) occur as slight depressional tracts back from the better drained frontal edge of terraces. These lower lying "backlands" are believed due largely to degradation of permafrost on the back of the terrace. Undifferentiated small-scale permafrost microforms (u) such as polygonal surface markings, various sorted nets and ring-shaped soil structures, soil stripes, frost-heaved mounds and pimples, frost blisters, etc., are associated with severe frost conditions. Individual microforms are too small to be reliably differentiated on airphotos having an approximate scale of 1 in. = 1000 ft.

FIELDWORK

After classifying terrain conditions and selecting a general route in (1 in. = 3333 ft) airphotos, initial field checks were made. Surface features shown in the pictures were readily identified on the barren landscape. Subsurface observations were made using shallow test pits and probes. Deeper explorations were made at potential borrow material locations mapped on airphotos. These explorations consisted mainly of boreholes; but sidehill trenches and deep test pits were also dug.

Assessment of terrain types and appraisal of the quality and quantity of available construction materials mapped from the photos permitted a route to be staked out. The final phase involved making minor adjustments in vertical and horizontal alignment, determining the minimum amount of fill needed to maintain permafrost at or near ground surface and increasing

this fill where snow drifting is likely to occur, and locating culverts and sidehill ditches.

CONCLUSIONS

Airphoto interpretation techniques were invaluable in locating a 40 mile road in an isolated and unmapped area in the northern tip of Ungava Peninsula. The sequence of steps followed and airphoto techniques used greatly aided in selecting a route and in the engineering appraisal of terrain in a continuous permafrost area. Field investigations were

greatly facilitated and could be carried out quickly during the short season available for work. Office airphoto and field-work tended to complement each other.

ACKNOWLEDGMENT

Work described in this paper was done for the Asbestos Corp., Ltd., F. E. Thurston, Project Manager. Individual acknowledgments to the many who participated in the project are not possible and so our appreciation must be recorded collectively. Airphotos were taken by Canadian Aero Service, Ltd.

PRELIMINARY SITE INVESTIGATION FOR THE FOUNDATION OF STRUCTURES AND PAVEMENTS IN PERMAFROST

G. Y. SEBASTYAN, Department of Transport, Canada

There are about 50 sites in the Canadian North where the Canadian Department of Transport maintains facilities for air transportation ranging from airports to telecommunications stations, navigational aids for air and water transportation, and weather stations. The design and construction of these facilities are the responsibility of the Construction Branch, Air Services, Department of Transport.

During the last two decades thousands of structures of various types and sizes have been built at sites in the Canadian North. On the basis of this experience, the preliminary investigation and design principles of the Construction

Branch have been established. The three major factors influencing the design and construction of foundation or pavement structures in permafrost areas are soil, climatic conditions, and construction materials.

SOIL CONDITIONS

Basic design principles used by the Department of Transport for the design of pavement facilities and foundation structures in permafrost subgrade areas are described elsewhere [1]. These design principles govern the type and the extent of

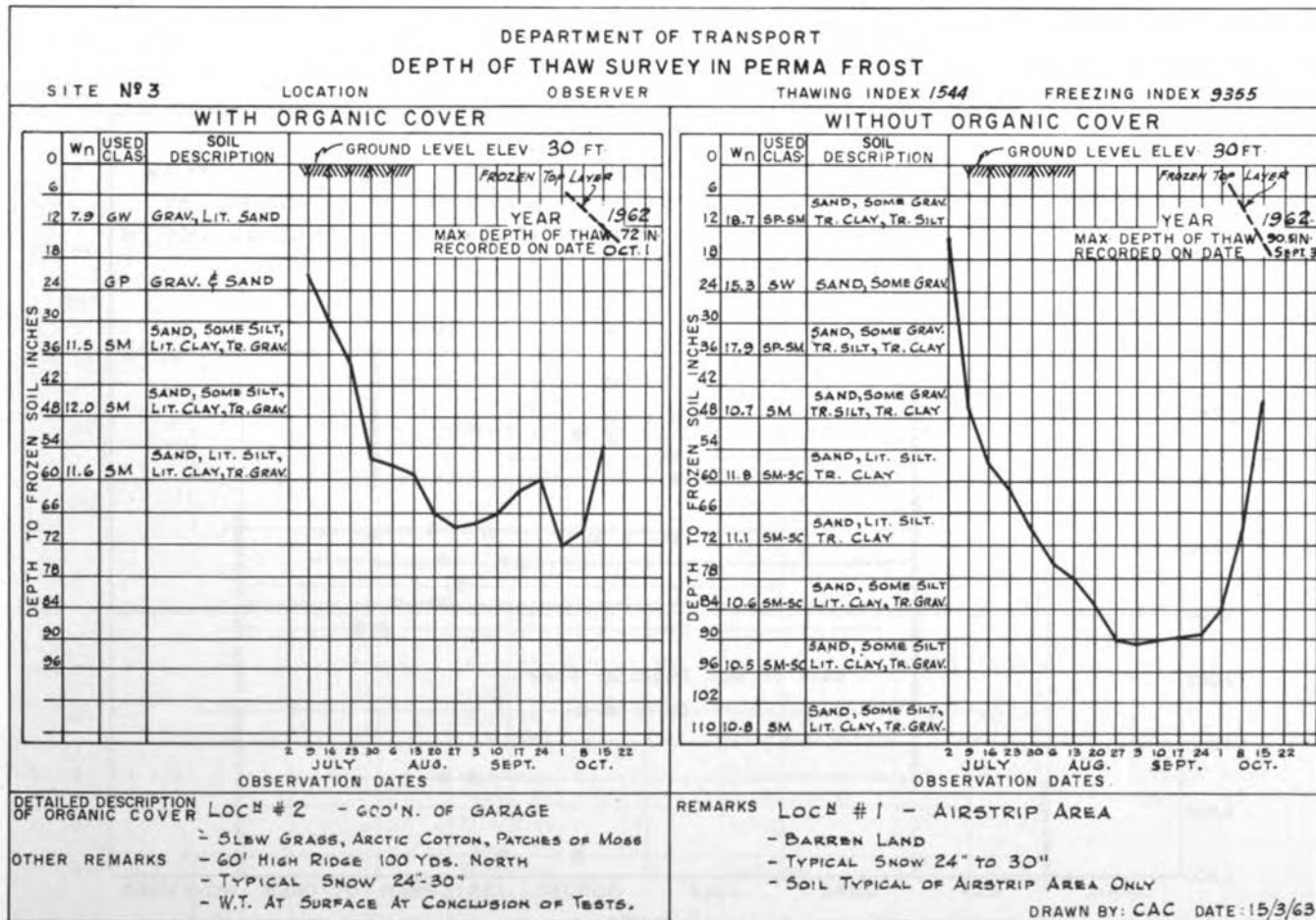

Fig. 1. Depth of thaw survey in permafrost

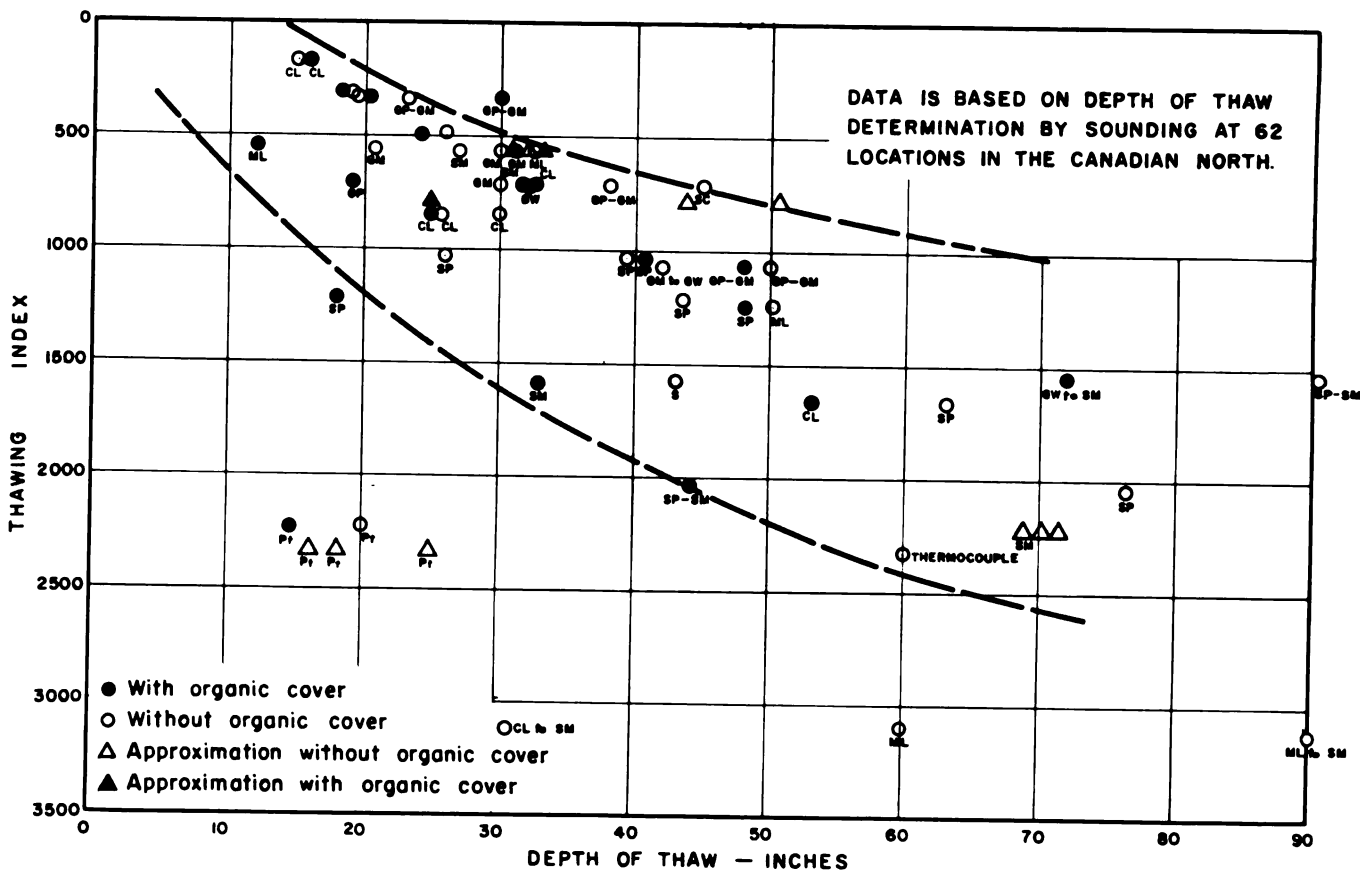

Fig. 2. Depth of thaw-thawing index

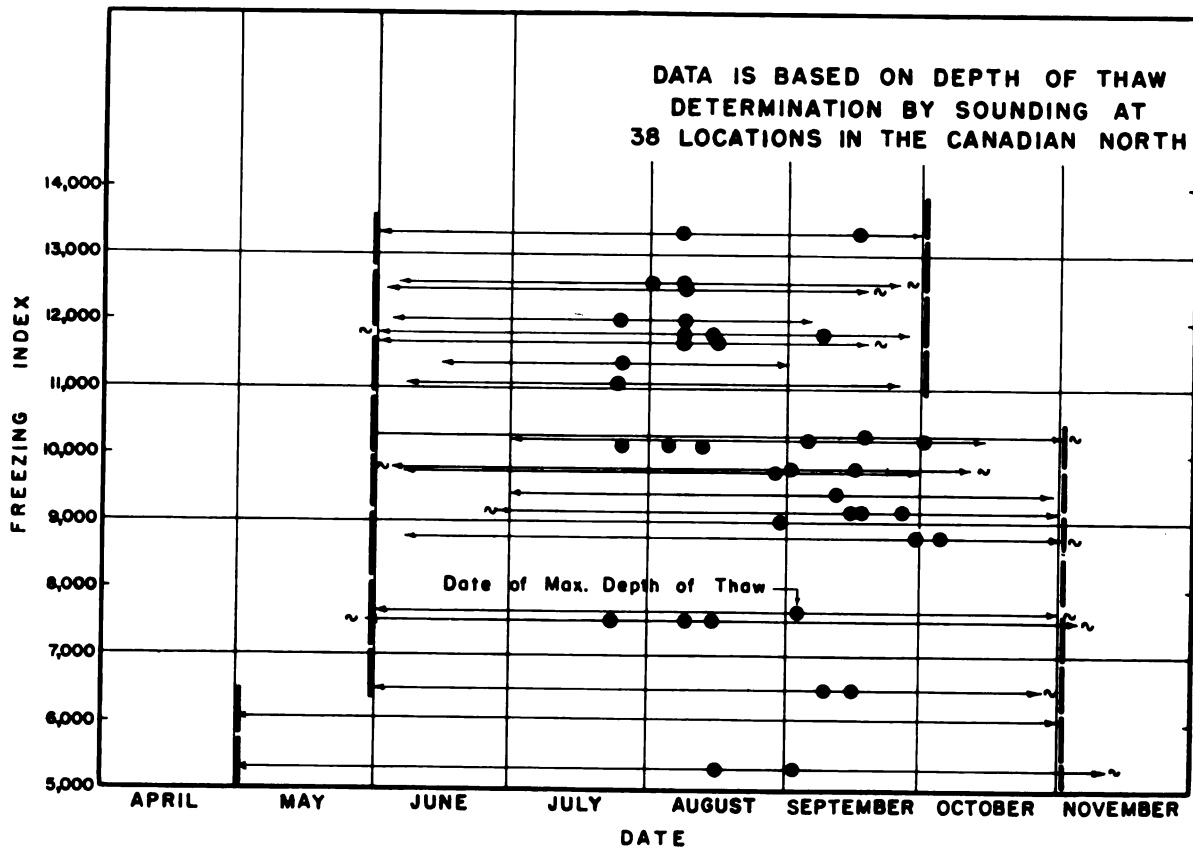

Fig. 3. Period of thaw-freezing index

Table I. Sample of data collected during 1961-1962

Site	Freezing Index		Thawing Index		Soil Type Description and Engr. Class	Moist. Content %	Organic Cover Type	Max. Depth Thaw (in.)	Date Max. Thaw	Thaw Period (Cal. days)	Remarks
	10-yr. Av.	Given Year	10-yr. Av.	Given Year							
1962	5 310	5 995	2 412	2 129	Sand, lit. silt, lit. gravel	2-13	Grass	>84	After 26/6	125	Locations: 3 with organic cover
1962 #1	12 061	11 852	382	528	Gravel, silt, & clay (GM)	7.0	None on site	21	7/8		
#2					Gravel, silt, & clay (GM)	10		29.7	14/8		
#3					Gravel, (shale), silt, & clay	7.4 7.4		30.7	8/9	91 ⁺	
1961 #1		12 545		329			Present	20	1/8		
#2							Nil	20.3	15/8		
1962 #1	9 355	10 233	1 515	1 544	Sand, some grav. tr. silt, tr. clay (SP-SM)	17	Barren land	90.5	3/9	64 ⁺	
#2					Gravel & sand, lit. silt (GW to SM)	10	Moss patches & slew grass	72	1/10	92 ⁺	
1962	9 044 (3-yr av.)	9 443	844 (6-yr av.)	1 155	Silty sand	7.5-18	Thin grass poppies	>42	28/8		Locations: 3 show rock at 42 in.
1962 #A	8 748	9 395	1 321	1 211	Sand, fine to med. (SP)	25	Moss: 3 in. over 2 in. decayed matter	18	18/9	47	Snow: 1960-12 in. 1961-22 in. 1962-48 (Max.) W. T. 28 in.
#B					Sand, fine to coarse (SP)	16.5	Barren area	43.7	11/9	71	
1962 #1	8 882	9 748	1 362	1 608	Sand		Thin grass	43	28/8	75	Snow = 1-3 ft Water Table (W.T.) 34 in. (24 hr) W. T. 18 in. (24 hr)
#2					Silty sand		Decayed grass dense grass 4 in.	33	28/8	75	
1961 #1	8 882	9 788	1 362	1 657	Fine sand to clay (SM to CL)		Moss: 4-6 in.	53	16/9		
#2B					Sand to fine gravel			63	2/9		
1962 #A	8 489	8 992	1 175	1 068	Grav., some sand, tr. silt (GW to GM)	05	Barren land	41.7	4/9	77 ⁺	
#B					Grav., some sand, tr. silt (GP-GM)	08	Sparse scrub grass	50	28/8	78 ⁺	
#C					Grav., some sand, tr. silt (GP-GM) (some orig. cover)	08	Scrub grass, flowers, willows	48.3	28/8	78 ⁺	
1962	6 495	7 092	3 211	3 097	Gravel, some sand		Trees, shrubs grass	>84	11/5		Locations: 3
1962 #1	8 051	9 172	1 977	2 030	Washed sand (SP)	03	Barren	76.3	25/9		
#2					Sand, tr. silt (SP-SM)	25	Decayed matter 8 in.	44	18/9		
1962 #1	13 322		701	848	Silty clay, tr. sand (CL)	30	Scattered wheat, goose grass	26	15/9		Typical snow depth, 10 in.
#2					Silty clay, tr. sand (CL)	23	Removed	26	15/9		
#3					Silty clay, tr. sand	28	Removed	29.7	7/8	71	
1961 #1	13 322	13 139	701	484				>24	29/8	78 ⁺	
#2								>25.7	29/8	78 ⁺	

Table I. (continued)

Site	Freezing Index		Thawing Index		Soil Type Description and Engr. Class	Moist. Content %	Organic Cover Type	Max. Depth Thaw (in.)	Date Max. Thaw	Thaw Period (Cal. days)	Remarks
	10-yr. Av.	Given Year	10-yr. Av.	Given Year							
1962 #1	5 331	5 283	2 122	2 221			Decayed grass, 1-2 in.	>70	15/8		Typical snow depth: 12 in. W.T. (3.0 ft)
#2					Sand, damp (SM)	13-16	Patches of grass	>70	2/9		
#3							Nil	>70	3/9		
1962 #1	7 840	8 186	2 908	2 986	Sand-clay		Caribou, 6-8 in., moss	>72	10/7		Typical snow 4 ft W.T. 20 in., (24 hr)
#2					Clay, some silt		Lawn	>72	1/7		
1962 #1	6 040	6 615	3 476	3 471	Silt, clay		Dense Grass: 8-12 in.	>120	26/6		Typical snow 30-40 in.
#2											
1962 #A	7 043	6 449	1 262	1 020	Sand, gravel (SP)	3.2-12.5	Nil	26.3	11/9	92 ⁺	Typical snow 24 in.
#B					Sand, tr. silt tr. gravel (SM)	18.8	Nil	39	18/9	99 ⁺	
#C					Sand, tr. silt (SP)	8.3-38.4	Moss, Lichen	40.7	18/9	99 ⁺	
1961 #1	7 043	7 644	1 262	1 246	Sand, tr. silt (SW, SP, SM)	4.0-15.4		48	11/9		
#2					Sand, silt (SM, ML)	12.3		50	11/9		
1961 #1	9 790 (3-yr av.)	10 282	742 (5-yr av.)	784	Built-up gravel around air-strip		Nil	>44	18/9		Typical snow 6-40 in.
#2							Moss, lichen on natural tundra	>25	18/9		
#3					Gravel pad 4 ft deep		Nil	>50.6	18/9	103 ⁺	
1961 #1	9 790 (3-yr av.)			710	Gravel (GP)	2.8	3 in.	>19	19/8		
#2					Gravel, tr. silt (GP-GM)	3.5		>38	19/8		
1962 #1	5 548	6 737	3 171	3 131	Silt, clay (ML)	37.7-46.3	Dense grass, trees	>62	19/7		Typical snow 3 ft
#2					OL for 3 ft to silt, some clay	36.3-49.9	Topsoil, decaying matter	>62	10/7		
#3					Silt, clay (ML, CL) to 3 ft, then sand, some silt (SM)	11.0-	Scattered grass	>62	10/7		
1962 #1	8 086	8 777	2 252	2 329	Over 20 in. organic		Decay matter 2 in.	18	3/10	127 ⁺	Typical snow 25 in. Trees shading test area Swampy area
#2					Over 20 in. organic	450.0	6-10 in. moss, lichen	16	26/9	127 ⁺	
#3					Over 20 in. organic		6 in. moss lichen, 2 in. decay matter	>25	17/10	127 ⁺	
1961 #1		9 223		2 252	Organic		6-in. moss	>14	29/9		W.T. very high
#2					Organic		Cleared	20	15/9		
1962 #A	12 671	12 409	375	528			Nil	32	10/8		Center of runway
#B							Nil	31	10/8		
#C								32	10/8		
1961 #1	12 671	12 535	375	166	CL to MH	14.9-23.7		16	8/8	58 ⁺	
#2					CL	12.5-17.1		15	16/8	65 ⁺	
1962 #1	11 911 (8-yr av.)	11 996	421 (9-yr av.)	575	Sandy silt, tr. clay (ML)	7.2-19.2	Nil	33	24/7	26 ⁺	Typical snow 6-12 in.
#2					Silty sand (SP to SM)	9.1-16.8	Nil	27	24/7	26 ⁺	
#3					Sandy silt (ML)	24.1	Present	12	7/8	57 ⁺	

Table I. (continued)

Site	Freezing Index		Thawing Index		Soil Type Description and Engr. Class	Moist. Content %	Organic Cover Type	Max. Depth Thaw (in.)	Date Max. Thaw	Thaw Period (Cal. days)	Remarks
	10-yr. Av.	Given Year	10-yr. Av.	Given Year							
1961 #1	11 911 (8-yr av.)	11 773	421 (9-yr av.)	296			Present	19.3	15/8	64 ⁺	
#2							Nil	18.7	8/8	57 ⁺	
1962 #A	7 169	7 529	3 000	3 119	Sand and silt, lit. clay	20-43	Nil	90	6/8		
#B					Clayey silt to sand (CL to SM)	12-26	Nil	31	23/7		
#C					Silt, some clay (ML)	30-43	Nil	60	13/8		
1962 #1	11 204	11 069	536	708	Silty gravel (GW-GM to GM)	6.1-10.1	Nil	30	24/7	35 ⁺	
#2					Gravel (GW)	7.0-11.1	Nil	32	24/7	35 ⁺	
1961 #1	11 204	11 384	536	378	GM (GM to GP-GM)		Present	30.2	25/7	43 ⁺	
#2							Nil	22.6	25/7	43 ⁺	
1962 #1	10 096 (5-yr av.)	10 162	754 (5-yr av.)	715			Nil	>34	9/7		Typical snow 10 in.
#2							Nil	>36	9/7		
#3							Nil	>46	12/7		
#4								>42	12/7		
#5								>36	12/7		
1961 #A	10 096 (5-yr av.)	10 200	754 (5-yr av.)	715	GM, SM, SC		Nil	>45	25/7		
#B					CL		5% moss	33	10/8		
#C					SM-SC to SM		90% moss covered	32	10/8		
1962 #1	5 049	5 598	3 388	3 092	Gravel, sand (GP)	3.0	Nil	>72	1/7		Annual snow 40-50 in.
#2					Sand, some gravel (SP)	3.5	Grass	>72	1/7		
#3					Sand, lit. gravel (SP)	2.3	Grass, 2-3 in., decayed matter	>72	1/7		

preliminary site investigations necessary for the design and construction of the various structures built by the Department.

In principle those soils, which do not undergo strength and volume change during cyclical freezing and thawing, do not require any special investigation because of permafrost conditions. Preliminary investigation studies are performed according to well established soil mechanics principles.

For those soils where strength and volume change is a major design consideration, determination of expected maximum depths and physical characteristics of the layer undergoing cyclical freezing and thawing is of primary importance.

GENERAL CLIMATIC CONDITIONS

For the determination of climatic conditions influencing design and construction considerations, the Construction Branch relies on climatological data collected by the Meteorological Branch.

Surface Weather Data

Data on air temperature, air pressure, humidity, precipitation (amount and type), surface wind direction and velocity, visibility, and ice observation (both fresh and salt) are reported from weather stations in the Canadian Arctic. The formation, decay, and movement of ice is noted.

Upper Air Weather Data

Observations on air temperature, air pressure, humidity, wind

direction and velocity are made to an altitude of approximately 60,000 ft.

Climatic environmental conditions concerning temperature conditions are expressed in terms of freezing index and thawing index [2, 3].

For design purposes, the Department of Transport uses the 10-year average values of both indexes.

CONSTRUCTION MATERIAL

Design and construction at a given site are influenced to a considerable degree by the type and amount of construction material locally available. This is especially true where permafrost subgrade soil conditions exist. In such a case the transportation of materials can be of primary economic importance. Consequently, a search for construction materials at permafrost sites is an integral part of any preliminary site investigation.

The extent and type of preliminary site investigations are governed by the following design principles:

1. The foundation of any structure is designed from a structural and practical standpoint to give support to the superstructure at an allowable maximum design deformation.
2. For any given type of structure the same safety factor is maintained in design and construction of the foundation as established for the superstructure.
3. For permanent structures a minimum maintenance is to be provided for during the design life of the structure.

POSITION OF THE FROST LINE (MAXIMUM DEPTH OF THAW)
 BEFORE AND AFTER CONSTRUCTION

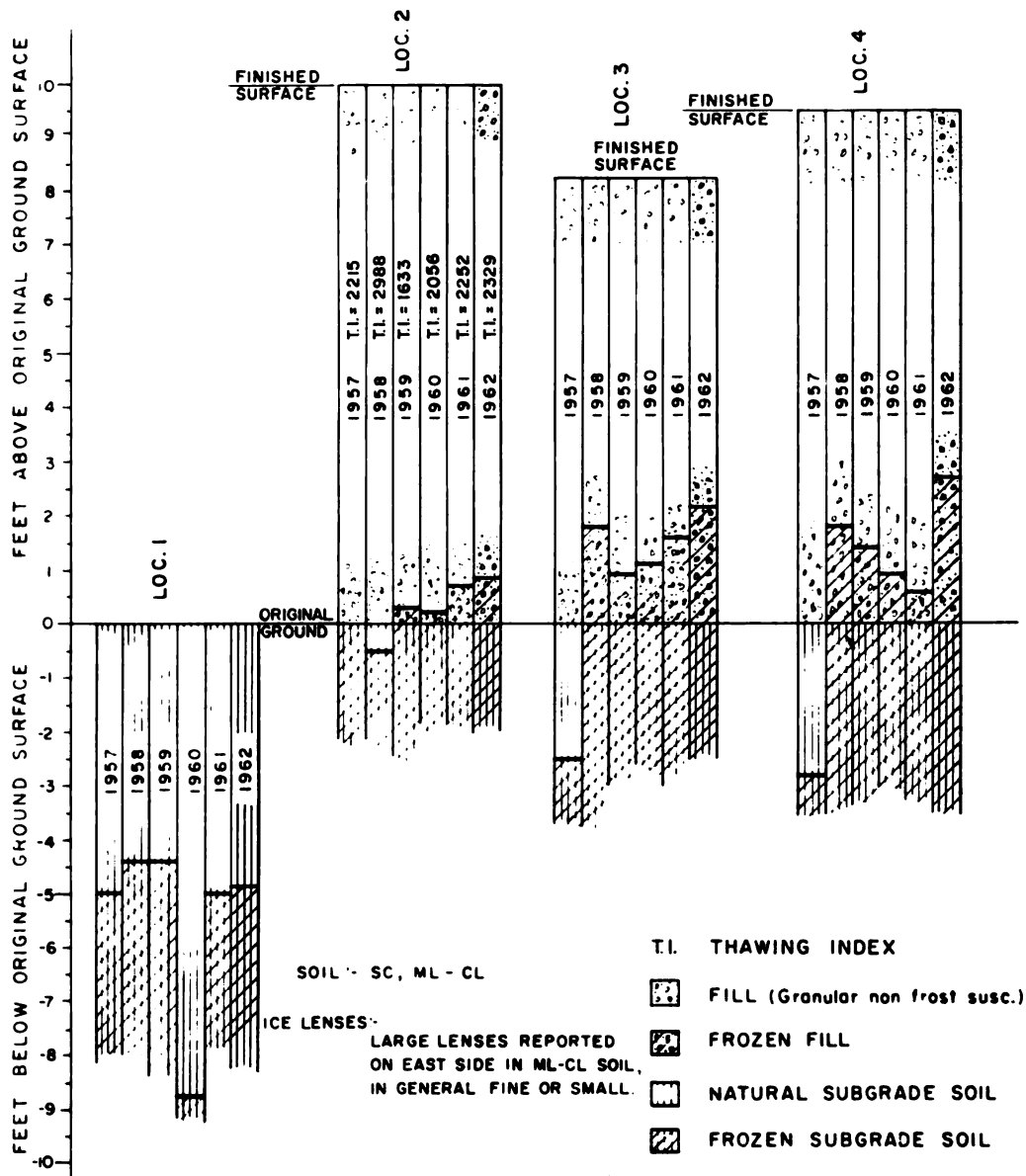

Fig. 4. Runway construction in permafrost

General conditions encountered at any given site are established by a preliminary survey where the Department of Transport investigates the site as a whole. This phase of the investigation includes: (a) literature search and search of the files of the Department of Transport and other government agencies for data which could be helpful to the designer; (b) depths of thaw determined under various climatic, soil, and ground cover conditions; (c) condition survey of existing structure; and (d) site search for construction materials.

For reference purposes, the Construction Branch maintains information files where all published technical information and collected engineering reports are filed for Department of Transport stations in the North.

In general, the depth of the active layer (depth of thaw) is measured by a sounding method. Information is collected on soil type (engineering description and classification), mois-

ture content, type of organic cover, freezing-thawing index data, maximum depth of thaw in inches, the date of maximum depth of thaw, and number of days of thaw.

Determinations in Fig. 1 show the rate of thaw penetration and the time and rate of freezeup for a given condition. The depth of thaw-thawing index data are based on soundings of the active layer at 38 sites in the Canadian North.

An example of the data collected during 1961-62 is given in Table I. These data are used to approximate the conditions at any given site and are extrapolated for varying environmental conditions. The test results are useful in predicting the depth of thaw penetration for sites where the physical conditions are similar to the site investigated. The data are also used for determining length of the construction season, and for establishing the period during which the ground can be negotiated by construction equipment. The data are also use-

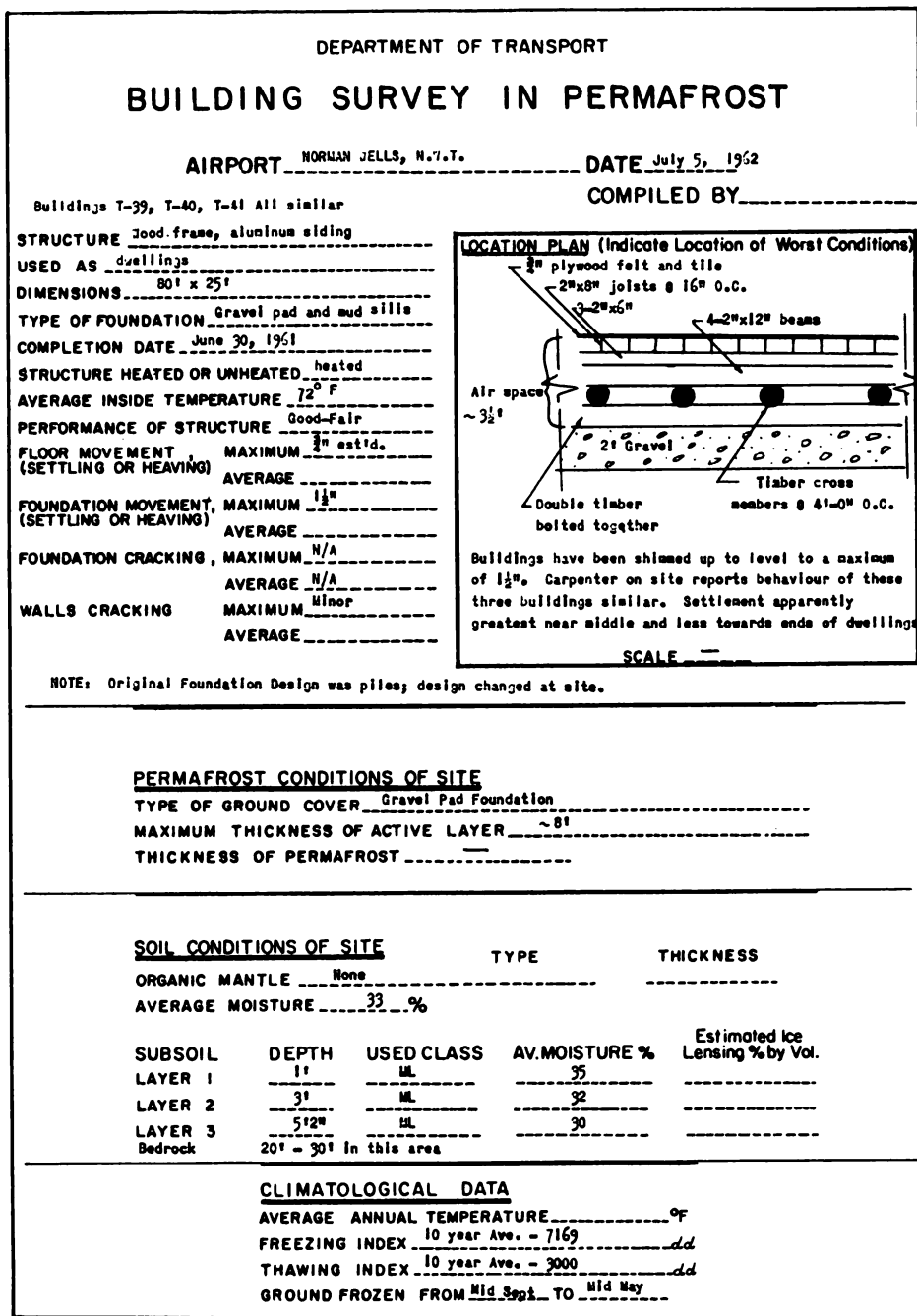

Fig. 5. Building survey in permafrost

ful for determining the time of freezeup of temporary landing strips built on subgrade soils. In thawed condition, the strips are too low in bearing; they can only be used when the subgrade soil is frozen. Experimental data are summarized in Figs. 2 and 3. Fig. 3 gives an approximate correlation between the observed period of thaw and the freezing index, together with the maximum depth of thaw reached.

Depth of thaw penetration into pavements has also been investigated at one location by means of a thermocouple installation. The results are summarized in Fig. 4. The design principle of maintaining the unstable subgrade material in a permanently frozen condition was achieved here.

Because most engineering considerations are based in engineering experience, the performance of existing structures is of major importance to the designer. A systematic collection of such performance data has been organized by the Construc-

tion Branch. Fig. 5 shows an example of the type of data collected.

Site search for construction materials is done from air-photo interpretation (Fig. 6) [4] with help from engineering consultants having wide experience in this field. Department of Transport personnel follow up airphoto interpretations with a ground search at the site.

The type and extent of preliminary soils investigation depend on the size, importance, and function of the structure and on soil conditions encountered.

Physical information collected includes strength parameters of the soil in its frozen and thawed state, type of ground cover, depth of the active layer, and moisture content and ice formation.

Initially, the number of boreholes is based on adequately representing the area of construction. Additional boreholes



Fig. 6. Airphoto interpretation for construction materials in permafrost

might be necessary, however, for a variable soil condition.

The depth of the soils investigation is directly related to the type of structure to be erected and the soil conditions encountered. Purely granular soils do not change their strength and volume characteristics during freezing and thawing; consequently, only the extent, depth, and quality of the granular material is investigated.

For those cohesive soils that do not undergo detrimental volume change during freezing and thawing, the soil investigation should determine the uniformity of the condition and the minimum strength of the materials.

For foundations where soil volume changes upon freezing and thawing, it is necessary to determine depth of the active layer and capacity of the permafrost for carrying the load of the superimposed structure.

The department uses many types of equipment for drilling with varying degrees of success. Portable equipment is generally inadequate, and in most instances the transportation

of heavy equipment is difficult. Good results have been achieved, however, by using on-site construction equipment. Examination of soil of the active layer by the open-test pit method was very successful where conventional drilling methods were inconclusive.

REFERENCES

- [1] G. Y. Sebastyan. "The Canadian Department of Transport Procedures for the Design of Pavement and Foundation Structures in Permafrost Subgrade Areas," 1st Can. Conf. Permafrost, Natl. Res. Coun., April 1962.
- [2] H. A. Thompson. "Freezing and Thawing Indices in Northern Canada," *ibid.*
- [3] E. B. Wilkins, W. C. Dujay. "Freezing Index Data Influencing Frost Action," Natl. Res. Coun. Tech. Mem. 33, Ottawa, 1954, pp. 36-39.
- [4] J. R. Mollard, consulting engineer. Unpubl. data, Dept. of Transport, internal rept., 1961.

EXCAVATION OF FROZEN SOILS

V. P. BAKAKIN, Obruchev Permafrost Research Institute, Moscow
A. N. ZELENIN, Moscow Automotive Institute

CURRENT STATUS

Perennial or seasonal frozen ground covers more than 90% of the Soviet Union. Throughout this territory frozen rocks and soils are excavated when mineral deposits are stripped, hydropower and other large projects are built, or various engineering utilities are laid. This is usually preceded by technological preparation and with considerable mechanization.

Less mechanization is found with "digging" processes in civil engineering and ordinary industrial construction work. When small-scale work is done, hard ground hinders the use of normal mechanization procedures, especially considering builders' demands for preliminary preparation. In mining and construction, well over 500 million cu m of frozen ground is excavated in the Soviet Union annually.

The difficulty of working and excavating frozen ground is the extra energy needed to disintegrate it. For ice-cemented soils this added power consumption at low temperature is so great that preliminary soil preparation is needed for full use of modern machinery [1].

The insignificant digging of trenches and individual pits in seasonally frozen ground layers is the only exception. Digging trenches in comparatively homogeneous fine-grained soils of this layer is done well enough with bar cutters mounted on tractors or excavators. It takes about 6 to 7 kw hours to disintegrate and excavate 1 cu m of frozen ground. Occasionally, heavy rippers towed by powerful tractors are used to disintegrate seasonally frozen ground. Blocks cut by bars or rippers are further removed by specially fitting excavators. Disintegrating the ground by machines reduces the costs by 50% as compared with the drill and blast methods [2].

In mining modern machinery is used after preliminary treatment of the frozen ground which can be prepared by disintegration (blasting) or thawing.

In the northern Soviet Union frozen ground is thawed by steam, electricity, and, occasionally, by thermochemical (artificial heat) sources. Thawing by solar heat is generally effected by well point and well methods and is common in excavating placer deposits. A combination of methods is frequently the most efficient for best use of modern machinery.

In today's technology the efficiency of equipment is about 60 to 80% with thawing by water under natural temperatures; 60% with thawing by electricity; 40 to 50% with thawing by steam, and 20 to 30% with thawing by thermochemical methods.

If general energy consumption indexes are compared, processing untreated frozen ground with machinery appears to be least expensive; next is thawing with natural and artificial heat sources, and third is preliminary disintegration of the ground. Economic indexes of today's preliminary treatment vary with the degree of organization, availability of machinery, scope of work, and thickness of the layer prepared for excavation (Fig. 1). Expensive preliminary preparation is encountered in construction where treatment often costs 500% more than excavation. In mining, the cost of disintegration doubles over-all excavation expenses even with adequate organization and machine drilling of blast holes. The cost of well-organized thawing of frozen ground in mass, including required preliminary development and amortization of installations, is not generally less than 100% of the remaining operation expenses.

High expenses and labor costs underline the need for research and further progress in preliminary treatment and excavation of frozen ground as a national problem.

RESEARCH ON DISINTEGRATING FROZEN GROUND

Effective excavating machines are scarce because basic data for calculation and design are not available.

Extensive experimental and theoretical research on disintegrating frozen ground by cutting, dynamic (impact) loads, vibrating-cutting devices, and vibration-percussion were made from 1951 to 1955, under the direction of Zelenin, in various institutions. The purpose was to develop scientific principles for calculation and the design of new machines for effective and direct excavation of frozen ground without preliminary thawing or loosening.

Research methods were mainly directed to studying the physics of disintegration, so that research data and principles could be stated mathematically.

Field and laboratory studies included more than 6000 tests performed on special test beds with commercial machines.

Tests were conducted on a variety of soils from sand to heavy clay over a wide range of ground temperatures (-0.5° to -40° C) and range of water contents (6 to 60%).

CUTTING GROUND

Experiments were performed under field conditions using 19 different devices, of which 15 were elementary profiles and 4 were cutting perimeters. Width (S) of elementary profiles varied from 1 to 20 cm.

Cutting force (P) in kg and specific resistance to cutting (K) in kg/sq cm were considered the main features of permafrost disintegration during cutting. The value $K = P/hS^2$, i.e., K is cutting force divided by cross-sectional area of the cut (depth h and width S).

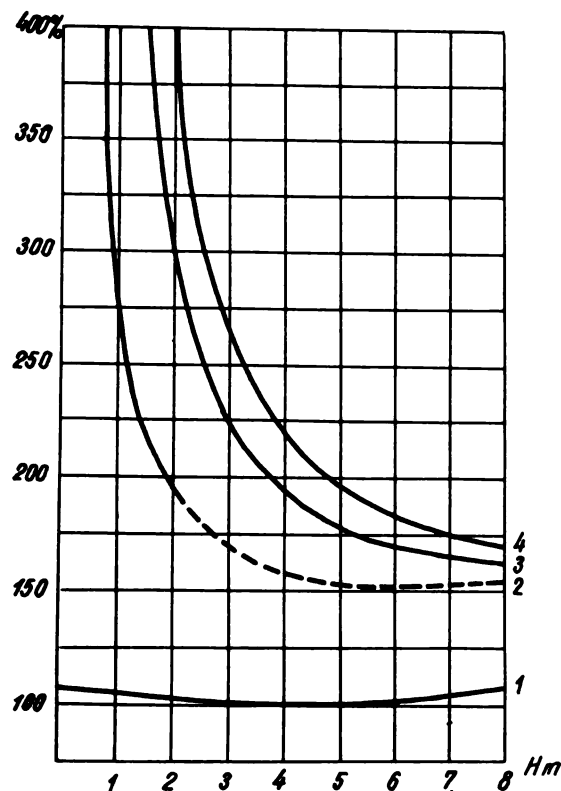

Fig. 1. Cost of excavating frozen soils as related to thickness of layer and preliminary treatments
1 Heat amelioration
2 Loosening by blast in shot holes
3 Loosening by blast in wells
4 Mine shafts

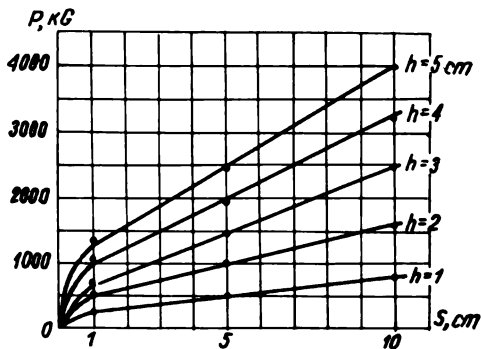
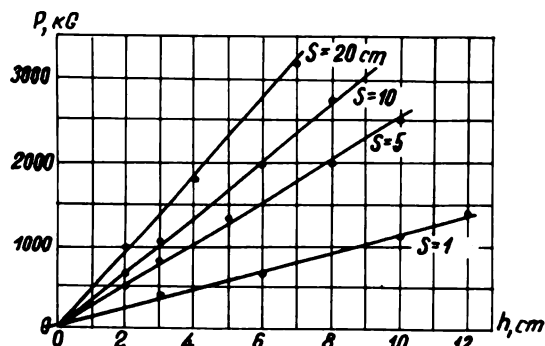

Fig. 2. Forces of cutting as related to depth of cutting and width of cutter

Results of complex experiments provided these data:
 1. Cutting force (P) undergoes linear changes in direct proportion to cutting depth, disregarding temperature and water content of the soil.

2. Variation of P due to width S of the profile (Fig. 2) when cutting sandy loam, with $t = -3^\circ\text{C}$ and water content (w) = 17 to 19%, is qualitatively similar to that of cutting non-frozen ground and is characterized by the equation $P = AS^n$ where (A) is a coefficient characterizing the physical state of the soil.

Plotting curves (Fig. 2) in double logarithmic coordinates shows that index (n) is 0.5 as it is in cutting nonfrozen ground.

3. Value K does not depend on h if S is constant. When S increases, K decreases. Hence, with the cutting of equal cross-sectional areas ($F = hS$) in "blocked" cutting, less force is required to shear cuttings of larger width and less depth. This conclusion fully conforms with the law: $P = f(h)$

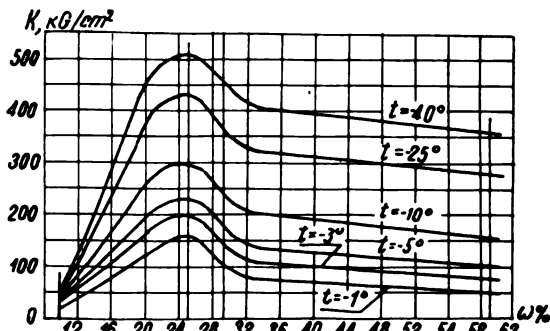

Fig. 3. Influence of moisture content on specific resistance to cutting

Table I. Frozen soil cutting resistance scale

Numerator is number of strikes C
 Denominator is specific resistance to cutting (K) in kg/sq cm

Soil	Water Content, %	Temperature, °C				
		-1°	-3°	-5°	-10°	-15°
1	2	3	4	5	6	7
Sandy loam	12.0	40-50	55-70	90-95	130-145	170-185
		45-60	65-70	85-90	130-140	165-175
	15.0	80-90	120-140	170-180	200-225	240-255
		85-90	120-140	160-170	220-230	170-280
19.0	120-150	140-180	210-230	270-390	340-360	
	120-160	160-190	225-240	280-315	360-375	
28.0	120-135	140-160	190-195	225-250	280-300	
	120-130	150-170	180-200	250-270	310-325	
Clayey loam	10.0	28-33	37-43	43-50	43-50	43-50
		30-40	40-45	45-50	45-50	45-50
	20.0	100-110	145-155	185-195	225-240	265-275
		110-120	150-160	195-210	250-265	300-310
	25.0	145-155	190-195	210-230	265-275	330-340
150-160		200-210	225-240	300-315	350-360	
30.0	95-105	130-145	155-165	220-235	265-275	
	90-100	130-140	165-175	235-245	280-295	
59.0	43-50	80-90	95-105	170-180	195-205	
	45-50	70-85	100-110	160-170	210-220	
Clay	17.0	43-47	80-90	100-110	160-165	190-195
		45-50	80-85	110-120	160-175	200-210
	24.0	75-85	120-125	145-155	185-195	210-230
		70-80	120-130	140-150	200-210	230-240
	31.0	95-105	145-155	160-165	200-215	220-235
100-105		140-150	170-175	215-225	240-250	
49.0	28-33	63-70	90-100	135-145	165-175	
	35-40	70-75	95-100	135-140	175-180	

for "blocked" cutting of nonfrozen soils and various rocks [3].

4. If the angle of cutting (α) is decreased from 90 to 30°, the cutting force changes almost linearly and with the angle of cutting ($\alpha = 30^\circ$), P becomes 45 to 50% smaller for various cutting conditions.

5. With increasing water content, the specific resistance to cutting in all soils rises to a certain maximum value corresponding to a moisture content close to full saturation of soil pores with ice (Fig. 3). A further increase in ice content of the soil decreases K, which gradually approaches the value of specific resistance to cutting pure ice at the same temperature and cutting parameters.

6. If (X) is the generalized resistance of frozen soil to different types of disintegration, and (t) is soil temperature, then the relation $X = f(t)$ becomes $X = At^n = A\sqrt{t}$ where only A varies, and whose relationship does not depend on ground temperature for all kinds of disintegration.

Assuming that value of rupture (σ) is 100%, the following relations are obtained for frozen ground resistance to destruction at any given temperature: Uniaxial tension (σ_t) is 100%, uniaxial compression (σ_c) is 300%, specific resistance to cutting (K) when S = 3 cm is 1100%, and static penetration q is 2100%.

In disintegrating frozen ground, methods should be used in which tensile stresses predominate. Such methods are a combination of shearing and tearing [2] as well as soil loosening with a single-tooth ripper of special design mounted on a powerful tractor.

7. In evaluating the stressed state of frozen soil when plotting the envelope of limiting stress, consideration should be given to tensile stresses (σ_2) and (σ_3) which occur in uniaxial compression of samples [4], because of the formation of compact wedges.

8. Granulometric composition influences the strength of frozen soil considerably less than water content and temperature.

9. Rapid field evaluation of resistance of frozen soil to cutting can be determined from readings of a dynamic densimeter used by Zelenin.

The instrument is extremely simple: A weight of 2.5 kg falls along the stem upon the washer of the end piece (screwed to the stem and set up vertically on the ground), and in one blow does work equal to 1 kg m. The number of blows (C) required to ram this flat cylindrical end-piece of cross-sectional area (F) = 1 sq cm to a depth (h) = 10 cm, characterizes the energy consumption for dynamic penetration.

The number of blows (C) is an expedient for placing a particular soil in the cutting resistance scale, since it accounts for all physical and mechanical properties of the soil that influence ground resistance to cutting.

10. The value of specific cutting forces (equaling C for cross section of cuttings S = 3 cm and h = 1 cm), depending on water content and temperature, can be taken from Table I.

11. The table is a basis for classifying soils according to their cutting resistance by the value of C (Table II).

Table II. Soil classification

Nonfrozen soil		Frozen soil	
Category	No. of blows	Category	No. of blows
I	1-7	VI	100-160
II	8-15	VII	160-220
III	16-23	VIII	220-280
IV	24-30	IX	280-360
V	30-100	X	> 360

This classification is continuous, since the upper limit [5] for nonfrozen soil (C = 30) is at the same time the lower limit for frozen soil.

The All-Union Conference on excavating frozen ground held in Moscow in 1962 recommended that this classification, developed by Zelenin, should be used because it determines the capacity of machines under various actual conditions simply and accurately.

12. To calculate the cutting force when using teeth of various cutters, buckets of rotor and chair excavators, tools of mining machines, and other cutting parts of similar design, the following, deduced from the summarized data of the above-mentioned experiments, is recommended

$$P = Ch (1 + 0.55 S) \left(1 - \frac{90 - \alpha}{150} \right) \mu \quad (1)$$

where μ is 1 for blocked cutting; 0.75 for semiblocked cutting; and 0.5 for free (unblocked) cutting.

Equation (1) applies to cutting tools of 1 to 10 cm width. For these conditions the calculations provide data close to actual results.

DISINTEGRATION BY DYNAMIC LOADING

Research on frozen ground disintegration by impact load was conducted under laboratory conditions with one blow ranging from 1 to 20 kg-m and under field conditions with one blow ranging from 100 to 3000 kg [2]. Specific energy consumption (F) in kg/cu m (or kw-hr/cu m), i.e., the amount of energy needed to disintegrate 1 cu m of soil was adopted as the index of effectiveness for this method of disintegration.

The amount of work performed with one blow is a major factor influencing energy consumption of frozen soil disintegration. Specific energy consumption is almost inversely proportional to the energy of one blow.

The shape of the active working part also substantially influences specific energy consumption and over-all productivity.

Under field conditions experiments were made using a wedge having combinations of teeth illustrated in Fig. 4. The wedge's total width was 50 cm, while that of each tooth was 10 cm. A wedge furnished with two extreme teeth (1 to 5 with optimum wedge angle $\alpha = 30^\circ$) had twice the capacity of the continuous wedge (of 1, 2, 3, 4, 5 design).

Resistance to percussion disintegration depends on the physical characteristics of frozen soil, such as water content, temperature, and granulometric composition. The influence of water content on the energy consumption of percussion disintegration is qualitatively similar to the relationship shown in Fig. 3.

The most effective distance of the active working part from the forefield (working face) (Fig. 5) varies with the temperature of the soil and the shape of the active working part. The direction of the blow and the incidence angle of the active working part greatly influence energy consumption.

For tractor-mounted equipment, the work performed at one blow must range from 1000 to 3000 kg m.

When the wedge is forced into frozen ground, from 80 to 85% of the power is spent in crushing the frozen ground and only 15 to 20% is consumed in separating the frozen ground from the forefield.

When frozen ground is disintegrated by rupture, a wedge with a bevel angle of 15 to 20° facing the forefield or a symmetric wedge with the tool angle of 10 to 15° is practicable. Wedges with the above angles are driven in with small power consumption, and a slight added effort toward the open wall of the forefield is needed to tear off the soil. With such a

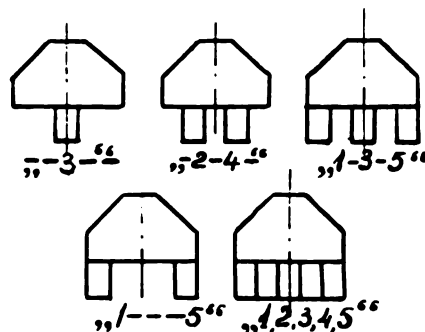

Fig. 4. Experimental working parts with different tooth arrangements

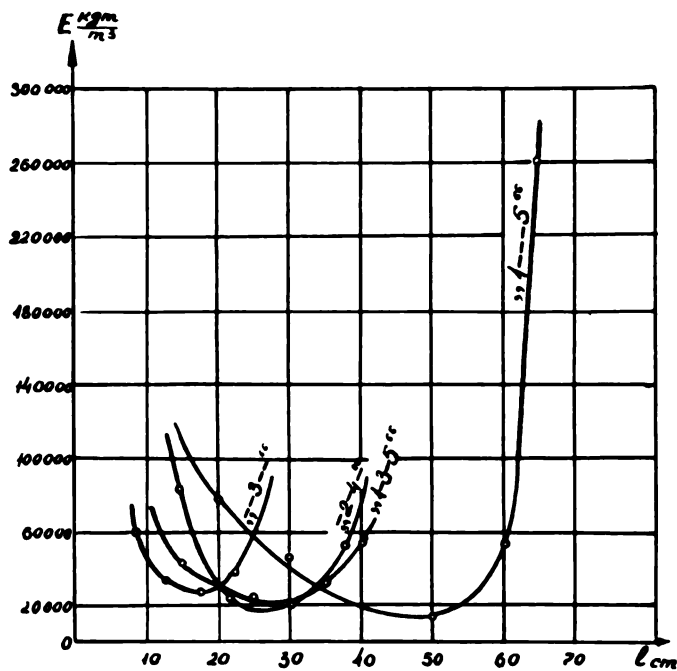

Fig. 5. Relationship between specific shearing energy consumption and distance (l) of different working parts from open wall

combination of shearing and tearing, energy consumption for disintegration decreases 1.5 to 3.0 times.

The vibration method of frozen ground disintegration is ineffective and impractical if the speed of the active working part exceeds 20 to 30 cm/sec. The vibration-percussion method permits working at higher amplitudes and energy of a blow, though it is easier to effect a blow of 1000 to 3000 kg m of energy under multiblow conditions than in the vibration-percussion method. With the vibration-cutting method, vibrations should be directed along the axis of movement of the working part. Lateral vibrations considerably reduce the cutting effect.

When translating disturbing force (P) of the vibro-hammer into the energy (A) of one blow, the following formula is recommended.

$$P = \frac{\omega A}{v} \quad (2)$$

where (ω) is the circular frequency of the disturbing force, and (v) is speed at impact.

Average energy consumption (E) in kw hour/cu m in working frozen soils at temperature $t = -5^{\circ}\text{C}$ and with energy of the blow $A > 500 \text{ kg m}$ follows:

- E = 1.5 to 2.0 in continuous cutting of forefield
- E = 0.7 in chipping with a continuous wedge
- E = 0.3 in chipping with a double-tooth wedge
- E = 0.17 in chipping and tearing with a narrow wedge
- E = 1.2 in chipping with a blow of low energy
- E = 25 with electric and steam heating

These data along with the frozen ground cutting resistance scale and the formula for calculating cutting force are a basis for the calculation and design of effective machines for use in excavating frozen soils.

STUDIES FOR EFFECTIVE PREPARATION OF FROZEN DEPOSITS FOR EXCAVATION

Detailed studies of preparatory treatments for particular methods of excavation were started in the Soviet Union as early as 1938, supervised by V. P. Bakakin, and continued, with some interruptions, by him and other scientists in the north and

northeast of the Soviet Union, until 1958 [6]. The results of these complex studies are given in the rest of this section.

Periodic cooling of the surface and formation of a mantle of frozen soils continues on the earth's surface in the process of nonstationary surface heat exchange. Higher losses of radiant solar energy and higher heat waste causing change in the state of water in the mantle soils are highly characteristic of northern regions where supercooling is encountered more frequently. Within the total energy balance these losses reduce considerably to proportion of heat radiation from the surface, which mainly influences thermal conditions of the mantle layer of soils to be excavated.

Under natural conditions the thermal regime of frozen mantle deposits is determined by heat exchange components of the boundary layer where radiant energy is transformed into heat.

Heat exchange in the active surface varies under certain geographic conditions, without sufficiently broad limits, influenced by exclusively local factors and the radiation microclimate. By effectively using natural conditions and modern equipment one can control changes in individual components of heat exchange, active influences including radiant heat exchange and thermal processes in the soil (Fig. 6).

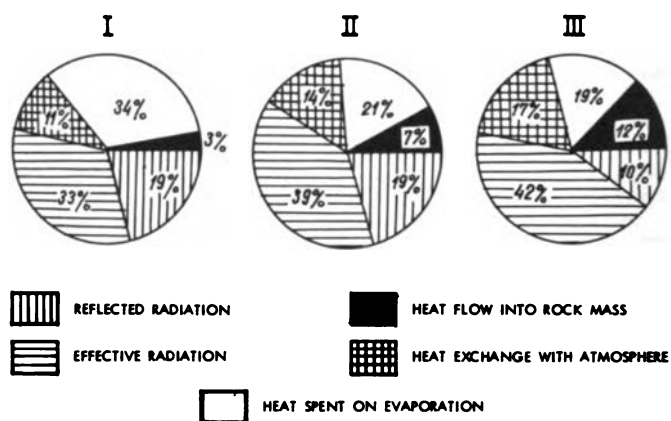

Fig. 6. Variations in balance components controlling radiant heat exchange and thermal processes

Within limits, controlling radiant heat exchange is effected by controlling reflection and long-wave radiation. This is done by using film covers, warming, screening, and other methods—some rather complex.

These methods of controlling natural heat exchange processes are especially effective: Controlling water content, and using artificial structures and film covers. Intensity of surface heat exchange decreases by using barriers to local advection and by using insulating covers.

Artificial control of moisture conditions is one of the best means of thermal control in the mantle layer. A 1% decrease in the over-all moisture content reduces the specific heat of frozen soils by 800 to 850 kg-cal/cu m. Protecting the surface with heat-transparent films is universal for thermal amelioration, but it is not yet perfected sufficiently for wide use.

The methods of controlling radiant heat exchange and thermal processes were experimentally tested in the northern USSR and are partly applied in engineering practice. As part of a rational complex, they make it possible to reach the following results within one warm season: To reduce the moisture content of the soils by 50 to 60%, to increase the heat content of the surface layer three to four times, and to increase the depth of seasonal thaw two to five times.

PROSPECTS OF DEVELOPMENT

In view of increased effectiveness of stripping large deposits

by removing thick layers of frozen Quaternary soils on a large scale in building large projects, Soviet specialists concentrated on rationalizing the methods of preliminary treatment of frozen soils for excavation. Great difficulties arise when frozen soil masses are penetrated.

Boring holes to place explosives for depth heat sources (water for thawing) and lowering the water table by machine drilling are laborious and expensive processes in the North. Drilling by slightly modernized available standard equipment cannot fully sustain the scope of work and volume of development necessary for highly efficient modern mining equipment. Thus, various thermal-drilling methods have been widely tested lately and are already partly practiced in Soviet industry. For drilling holes of 1.5 m, thermopneumatic drills are effective. Drilling in sandy-loamy soils and clays can reach a speed of 20 to 40 m/hour with the thermopneumatic drill designed by the Kharkov Mining Equipment Institute. To drill deeper holes, gas-jet drills have been used, in which a stream of gas flows faster than sound, at temperatures up to 1100°C, and disintegrates the soil, in some cases, very effectively. High over-all energy consumption and comparatively high costs are characteristic of thermopneumatic drilling, however.

When deposits covered by a thick series of frozen Quaternary soils are stripped in high benches, a sharp improvement of general technical and economic indexes (10 to 15%) is possible by using preliminary holes. Machine emplacement of jet points and pipes produces the same effect. Deep winter freezing of the ground also hinders open-cut working in northern regions.

Higher heat radiation during the cold season in the North produces deep frost penetration through moist loose soils. To prevent seasonal freezing, various protective covers are frequently used rather late in winter, when the mantle has lost most of the heat accumulated during the warm season. Properly used insulating covers, made of materials at hand, decrease the depth of frost penetration up to 50% [1]. Seasonal freezing of loose soils on the surface is almost completely prevented by covering with materials in sheets when temporary electric heating is used during the first snowless period of frost. The heating is effected by low-voltage currents in large-mesh networks of thin bare wires laid between the warmed surface and the cover.

Besides heating, Soviet practices often include expensive thawing and, less frequently, chemicals. Thawing of a seasonally frozen layer by using short needles (well points), vertical electrodes, and other devices with all inherent limitations are adequately described elsewhere; hence, only physiochemical protection is stressed.

To resist seasonal freezing, Soviet specialists used NaCl, KCl, MgCl₂, MgSO₄, and other chemicals that protect only to -15°C with considerable (up to 8 kg/cu m) specific consumption. Aqueous solutions of silicones have been tried lately to prevent seasonal freezing. Scant knowledge of the nature of interaction between chemical agents and frozen loose soils and uncoordinated research are the main difficulties in preventing seasonal freezing by physiochemical methods.

Much more definite and satisfactory technical and economic results are shown by aqueous-thermal ameliorations [1, 6]. The simplest are in general use for Soviet mining; they add considerably to preliminary disintegration and thawing and, significantly, they can greatly improve mining equipment by decreasing strength caused by the freezing of loose soils. Heat consumption for thawing rises with ice saturation within the following limits:

Ice saturation of the soil, %	10	20	30	40	50
Heat needed to thaw 1 cu m of soil, 1000 kg-cal	16	24	33	42	50

A complex of amelioration measures suitable for local conditions makes it possible, within practicable periods, to reduce ice saturation of the upper strata of soils to a minimum corresponding to the optimum moisture content for the adopted

method of preparing for excavation. Artificial reduction of water content by amelioration shows the remarkable effectiveness of the method of protection from seasonal freezing. While moisture content increases and approaches the optimum figure, thermal resistance of the soil rises, which allows better use of insulating covers on previously drained land.

Even more important is obtaining the optimum moisture content to get lower heat consumption for depth thawing and reduced resistance of frozen soils to cutting and other kinds of mechanical disintegration. The latter statement is significant, as mining equipment produced today is not generally suitable for northern climatic conditions as regards power capacity, design or materials, and, in particular, for excavating very hard frozen soils.

Most powerful excavators produced in the Soviet Union and abroad have a cutting stress up to 300 kg for 1 cm of the lip's edge. Most bulldozers, graders, and other mining machinery have a considerably smaller stress, while a specific stress up to 1000 kg/cm and more is needed to work in massive frozen rocks referred to in M. M. Protodyakonov's firmness scale as categories 4 and 5.

Besides inadequate power capacity, other drawbacks occur. New mining equipment for open-cut working—basic and auxiliary assemblies of roadmaking, building and mining machinery that are unfit for arctic conditions—are too often considered basic. The basic design is provided with a new working part of improved strength. Lack of strength in mining machines is not the only drawback hindering their use in northern regions. Most modern excavators, tractors, bulldozers, and scrapers have systems of greasing, cooling, ignition, and flexible connections which cannot operate at low temperatures. An even worse mistake is using ordinary low carbon steels that are fast wearing and brittle at low temperatures.

In designing mining equipment for excavating frozen soils, major emphasis should be placed on: 1. Raising power capacity and strengthening the construction of rock and earth machinery, and 2. designing economical, energy saving, mining machines in which physical principles of disintegrating frozen soils known today are more fully applied.

Advantages of powerful mining equipment specifically designed for excavating frozen soils have been discussed widely enough. Less known are results of work aimed at designing mining machinery based on physical principles of soil disintegration, which are still not applied in mining practices. The effect of vibroshock is especially noteworthy.

Data from the Urals Polytechnical Institute show that power consumption by vibroshock machines working in frozen soils does not exceed 0.45 kw-hour/cu m, while the capacity of some experimental machines, far from perfect, is 2.2 cu m/hour per kw of nominal power. Vibroshock, though, is not the only promising method for efficiently disintegrating frozen soils in mass; no less interesting results are provided by thermal cutting by circular friction saws, and chipping in large blocks.

In the future, while designing machinery specifically for excavating frozen ground, studies must consider dynamic loads as applied to mining equipment, which up to now have not been studied adequately.

Some Soviet and foreign enterprises adapt a machine for heavier loads temporarily by replacing the active part with one that is stronger and smaller. Such replacement allows the specific force to increase within the same nominal power capacity, thus enabling one to run the machine under heavier operating conditions. New designs of mining machinery should ease maintenance by incorporating simple devices to improve insulation, and local greasing assembly heating systems. Cooling and feed systems should be modernized and the working place of the operator should be made more comfortable.

Replacing low-carbon, low-alloy steel by frost-resistant manganese steel with adequate addition of vanadium in important structural assemblies is indispensable for progress in designing new mining equipment for open-pit excavation in the North. Replacing ropes and rubber, now often used, which become nonelastic at low temperatures, by flexible and frost-

resistant kinds specifically adjusted for northern conditions is no less necessary.

In conclusion, specialized mining machinery is needed for frozen soils. Further improvement of energy saving bar type machines are recommended for digging narrow trenches in a layer of soil (sand, sandy loam, clayey loam, clay) seasonally frozen on the surface, which contain a few large inclusions. When large inclusions hinder cutting (or when it is necessary to excavate very coarse grained Quaternary deposits frozen to a considerable depth), it is possibly sufficiently effective to apply the principle of force loosening. This principle, according to some Soviet and foreign data, is technologically and economically acceptable.

Also needed under northern conditions are self-propelled, powerful, combined vibropercussion machine loaders, adjusted for excavating both seasonally and perennially frozen soils in a continuous face [7].

With improved design and well-organized production and maintenance, this mining machinery (bar type, heavy rippers, and vibropercussion machine loaders) will adequately meet the demand for mechanization in excavating frozen rocks while constructing installations, laying utilities and drainage systems, and exploiting small and medium sized mineral deposits.

Development of more precise estimates of energy consumption in the process of disintegration with various simple forms of deformation will provide still more accurate estimates of basic design deformations while designing mining equipment on principles of physics and mechanics. Studies and further progress in thermopneumatic hole drilling and electrothermic methods, and artificial snow-cover formation to resist freezing, should, in our opinion, also be promoted. Further studies of

heat amelioration should produce wider and better use of natural thermal processes for reducing power consumption in excavating frozen soils. Most promising for heat amelioration of frozen soils is the method of covering the surface with heat transparent films, but its technology is not yet adequately developed.

"Current Status," which is the first part of this paper, was written by V. P. Bakakin. The rest of the paper was the work of A. N. Zelenin.

REFERENCES

- [1] V. P. Bakakin. Osnovy Vedeniya Gornykh Rabot v Usloviyakh Vechnoy Merzloty, Metallurgizdat, Moscow, 1958.
- [2] A. N. Zelenin. Razrusheniye Merzlykh Gruntov Rezaniyem, Udaram, i Vibratsiyey, TsINTIAM, Moscow, 1962.
- [3] A. N. Zelenin. Fizicheskiye Osnovy Teorii Rezaniya Gruntov, Acad. Sci. USSR, Moscow, 1950.
- [4] I. Z. Petukhov, M. A. Gurin. "Vibratsionnye mashiny dlya razrabotki merzlykh gruntov," Sverdlovskiy Prom. Ekon. Byul., No. 4, 1961.
- [5] A. N. Zelenin. Rezaniye Gruntov, Acad. Sci. USSR, Moscow, 1959.
- [6] V. P. Bakakin. Opyt Upravleniya Teploobmenom Deyatel'nogo Sloya Merzlykh Gornykh Porod v Tselyakh Povysheniya Effektivnosti ikh Razrabotki, Acad. Sci. USSR, Moscow, 1955.
- [7] A. N. Zelenin, G. M. Lomize. "The Compressive Strength of Soil Samples in Relation to Limited Plastic Soil Deformation," Proc. 5th Intern. Conf. Soil Mech. Foundation Engr., Paris, 1961, Dunod.

ENGINEERING GEOCRYOLOGICAL RESEARCH

V. P. USHKALOV, A. M. PCHELINTSEV, A. I. YEFIMOV, Obruchev Permafrost Research Institute
A. I. DEMENTYEV, Municipal Economic Academy, Moscow

The study of ground in permafrost areas differs from that in other areas because of phase transition of water and change of ground temperature throughout the year. The main properties of soils change, i.e., bearing capacity, ice content, cryogenic structure, rheological properties, slumping subsidence behavior, etc.

Usually, the study of frozen soils is conducted at construction sites together with geological, geomorphological, and hydrogeological prospecting of the region. Frozen soils are studied not only for various physicochemical and thermal properties, structure, temperature, and depth of thawing, but also for definite genetic relationships of frozen soils to some phenomena usually accompanying them i.e., thermokarst depressions, frost-heaving mounds, frost cracks, icing, solifluction, etc.

Much attention is being paid to study of seasonally frozen ground. Geocryological engineering research involves the following problems:

1. Determination of the suitability of the surveyed site for construction considering subsidence of the active layer, heaving of the active layer, icing, etc.
2. Selection of a method for the use of foundation soils, types of foundations, and types of buildings and structures.
3. Determination of physicochemical and thermophysical properties of frozen soil to make it possible to design the foundation according to limiting conditions.
4. Development of methods for construction of foundations.
5. Development of reclaiming, constructive, physicochemical, thermophysical, and physicochemical measures to prevent subsidence, heave and icing, and to control the hydraulic and temperature regime of the active layer.
6. Consideration of possible changes in the frozen soil at the time of construction and maintenance of buildings and units.

7. Determination of drainage conditions of the construction site, surface runoff, diversion of sewage and industrial wastes, etc.

When construction is undertaken at new sites, investigation is carried out in three stages: (a) General layout, (b) project plan, and (c) working drawings.

With the data required for the general layout stage available, the investigation comprises stages (b) and (c) only.

Research at the stage of general layout preparation is carried out to obtain the general characteristic of construction conditions at the site as well as to make it possible to select the most favorable sites for construction.

For the purpose of obtaining data characterizing the geological and frozen ground conditions, it is advisable that in the general layout research there should be wide use of airphotos, aerovisual and aerohydrometrical observations, as well as geological interpretation of airphotos. To ensure more precise and detailed interpretation of vegetation, frozen ground forms, and microrelief, in addition to the usual aerial survey, it is advisable to perform perspective and spectrozonal photographic surveys. The content and sequence of the aerial photography survey are specified in pertinent instructions.

Research work for the project plan stage is performed at the most technically and economically favorable sites. During this research, the amount and composition of additional frozen-ground study to be made when implementing the working drawings should be specified.

Investigations at the "blueprint" stage are carried out at a previously selected site or in a building to obtain data necessary for preparation of the working drawings.

These investigations are required for detailed and final coordination of available data on frozen-ground conditions

obtained by the surveys performed at the preceding stage as well as for specifying possible changes of these conditions during construction and operation.

The study of permafrost and associated phenomena depends on the time factor. Actually, if the geological properties of the ground beyond the permafrost area are not subjected to changes within a year, or change only insignificantly, the changes in the permafrost area proper may be very considerable due to water phase transitions and rock temperature changes during the year. These changes of ground characteristics are change of bearing capacity within a year, compressibility, heave, icing, cryogenous texture, rheological properties, appearance and disappearance of frost fissures, ice bodies, cryogenous pressure in seasonally frozen ground-water table, and seasonal frost mounds.

Therefore, the geocryological site survey is performed steadily for a year, or in yearly cycles, or during the most characteristic period, i.e., the period of maximum freezing and thawing. The aim of the surveys is to determine the range of time-qualitative and -quantitative changes of the soils at the site.

The amount of seasonal thawing and freezing is determined in the period of the maximum thawing by soundings, geophysical methods using electrical profiling, microseismics, and cryopedometers of various designs. Cryopedometers operating on a principle of electrical resistance variation of frozen and thawed ground are widely used in investigations.

In recent geocryological surveys, a method of determining seasonal thawing depth of the soils by their cryogenous texture was developed. Detailed study of the depth of soil by its texture makes it possible at any time to determine precisely the depth of thawing for preceding years. The best results have been obtained for loamy ground with clearly differentiated texture of seasonally frozen ground and of ground frozen for several years.

The relationship between physical and mechanical properties of the loose soil and phase condition of water contained in it requires special study of soils in their natural frozen state. Therefore, it is very important that the main soil characteristics necessary for design work be obtained at the site. Design work includes manufacturing of portable instruments and devices to study the properties of the frozen ground, i.e., unit weight, ice content, thaw consolidation, bearing capacity, etc. Equally important is the development of the most effective method for prospecting boring to take the soil samples. Recently, core-drilling of frozen ground by precooled compressed air has been widely practiced.

Comprehensive study of permafrost and seasonally frozen ground should result in determination of those characteristics required for designing structural foundations.

The following characteristics of the ground are necessary for design on the principle of limiting structural deformations: Coefficients of thawing, consolidation, pressure distribution, and thermophysical coefficients, etc. [3].

By correlating the results of many tests for the physical properties of soils when determining the above coefficients and factors, relationships and formulas have been established for determining the coefficients indirectly, without laboratory or field tests.

It is necessary to know four main physical characteristics of the soils: (a) Unit weight of mineral particles (γ_1); (b) total water content (W_1) with respect to the weight of dry soil; (c) amount of unfrozen water (W_2); and (d) unit weight of frozen undisturbed soil (γ_2).

These characteristics are of great importance because they determine thermophysical and mechanical properties of the ground. However, the characteristics can be determined by a more rapid and simple method based on known relationships: The specific weight (γ_1) can be determined from tabulated average values (Table I); the total water content of the soil (W_1), from unit weight data; amount of unfrozen water (W_2), from water content at the plastic limit and maximum molecular moisture capacity; and unit weight of soil (γ_2) from its water content.

Table I. Mean values of grain unit weight (γ_1)

Soil Type	γ_1 (g/cu cm)		Standard Deviations	
	Mode	Mean	(g/cm)	(%)
Clayey loams	2.71	2.71	± 0.0087	± 0.32
Sandy loams	2.70	2.70	± 0.0097	± 0.36
Sand	2.66	2.67	± 0.0055	± 0.21
Sandy gravel	2.66	2.67	± 0.0079	± 0.29

Degree of subsidence of permafrost e_1 is determined from the value of its relative thaw consolidation at a pressure of $p_1 = 1$ kg/sq cm by

$$e_1 = \frac{\gamma_3 - \gamma_4}{\gamma_3} \quad (1)$$

where γ_3 is the experimentally determined value of dry unit weight of frozen soil in kg/cu cm on thawing at a pressure of $p = 1$ kg/sq cm; and γ_4 is dry unit weight of the same soil in a frozen condition.

The soil is considered to be nonsubsident at a value of $e_1 \leq 0.03$, subsident at $0.03 < e_1 \leq 0.1$, and strongly subsident at $e_1 > 0.1$.

Degree of heave of the active layer is conventionally determined from

$$e_2 = \frac{\gamma'' - \gamma'}{\gamma''} \quad (2)$$

where γ' is the experimentally determined value of dry unit weight of frozen soil in heaved condition; and γ'' is dry unit weight of the same soil, thawed without load.

With $e_2 \leq 0.01$, the ground is considered to be practically nonheaving, with $0.01 < e_2 \leq 0.04$, heaving, and with $e_2 > 0.04$, strongly heaving.

The standard deformation value of the frost heave of foundations is determined in cm by

$$\Delta \tau = m e_2^* h_g^1 \quad (3)$$

where e_2^* is the standard relative foundation heave (Table II); h_g^1 is relative heave of active layer: Equal to standard thickness of active layer h_g^2 with a reduction coefficient for sandy soils of 0.7 and for clay soils, of 0.8; value h_g^2 is determined according to the current standard SN 91-60.

The limiting value of foundation heave is determined from the strength and operation tolerance of structures; and m is the coefficient of working conditions: Equal to 1.2 for structures sensitive to differential settlements, and equal to 1 for structures of low sensitivity to differential settlements.

Table II. Standard relative heave of foundations (e_2^*) (in fractions of thickness of heaving active layer)

Soil type ^a	Heave (e_2^*) at a standard pressure of p_T in % of its standard value τ'					
	0	20	40	60	80	100
Clayey loams	0.1	0.075	0.05	0.035	0.015	0
Sandy loams and sands, fine and silty	0.06	0.03	0.02	0.015	0.01	0

^a soil is saturated at a high water content; permafrost is continuous; mean annual air temperature in January is -25°C ; length of heave period is 4 months/year; average temperature of the active layer in the heave period is -3°C ; displacement difference is ≤ 0.5 of the value e_2^* . Heave deformations (e_2^*) are given in fractions of general thickness of heaving active layer for conditions of the open site; if thermohydraulic insulation is used on the ground surface, its effect is determined by calculation.

Relationships are obtained by the correlation of experimental data for determining W_1 and γ_2 . The characteristic values are listed in Table III.

$$W_1 = a - \frac{\ln \gamma_2}{b} \quad (4)$$

$$\gamma_2 = e^{b(a-W_1)} \quad (5)$$

Table III. Values of parameters a and b in (4) and (5)

Soil type	Very wet soil		Fully saturated soil	
	a	b	a	b
Clayey loams	0.87	0.91	1.05	0.84
Sandy loams	0.72	1.29	0.91	1.01
Sand	0.83	0.98	1.02	0.80
Sandy gravel	0.66	1.43	0.95	0.88

The reliability factor of calculated values of water content and unit weight of soils $K_d = 0.78$ to 1.23 . Values of W_2 may be determined by means of the calorimetric method.

By analyzing the results of geocryological research, the laws of relationship of thermal and physical properties of soils have been established and techniques for rapid determination of the thermophysical factors have been developed: Thermal conductivity (λ), thermal diffusivity (α), and volumetric heat capacity (C), according to their physical characteristics: Unit weight, water content, and degree of saturation (SN91-60).

The stated physical parameters determine the corresponding values of soil thermophysical factors. A root mean square error of rated values of ground thermophysical factors is up to $\pm 8\%$. Quantitative expressions of the relationship are presented as tables, formulas, and curves. Factors λ_1 and λ_2 are of exponential form given by

$$\lambda_w = ae^{b\gamma_2} - C \quad (6)$$

The mean values of a, b, and C of the above relationship are given in Table IV.

The volumetric heat capacity can also be determined by the method of addition.

Based on generalization of geocryological research data, an engineering method for determination of depth (h_1) and rate of thawing (v) of the frozen soil base has been developed.

Table IV. Value of parameters a, b and C in (6)

	W_1	Thawed soil			Frozen soil		
		a	b	C	a	b	C
Sandy soil	4	0.059	1.691	0.012	0.068	1.857	0.009
	8	0.094	1.509	0.013	0.105	1.611	0.010
	16	0.140	1.279	0.007	0.166	1.412	0.005
	20	0.205	1.107	-0.013	0.199	1.358	-0.007
	25	0.220	1.112	-0.024	0.259	1.241	-0.014
Clayey soil	8	0.038	1.989	0.018	0.084	1.426	0.017
	18	0.101	1.378	0.006	0.114	1.449	0.008
	27	0.158	1.162	0.004	0.191	1.242	-0.018
	40	0.221	1.012	-0.009	0.311	1.017	0.007

This method shows accurately enough, as was proved by comparison with nature, the true conditions of the thawing process.

The following has been proposed for computational purposes:

$$h_1 = k_\tau \left[\sqrt{\frac{2\lambda t_n \tau}{q - C_2 (1.9 t_o + 0.5 t_2) + 0.5 C_1 t_n} + \delta_n^2} - \delta_n \right] \quad (7)$$

where k_τ is the correction coefficient allowing for the thermal conditions of the building or structure depending on size; t_n is the estimated temperature of air at the level of the floor surface ($^{\circ}\text{C}$); t_o is the steady temperature of the frozen ground at the level of zero annual amplitude ($^{\circ}\text{C}$) as determined by observation; t_2 is the average annual temperature of the permafrost stratum from the top surface to the depth of the zero annual amplitude ($^{\circ}\text{C}$); τ is the time of the thawing of the base soil from the beginning of the use of the building or structure

(hour); q is the latent heat of the thawing frozen soil; $C_{1,2}$ is the volumetric heat capacity of the frozen and unfrozen ground in Kcal/cum ($^{\circ}\text{C}$); and δ_n is the thickness in meters of the soil layer having the same thermal resistance as the floor structure.

Equation (7) considers the effects of the structure size and plan shape.

The rate of thaw is the thawing depth beneath a foundation during a year of structure use. It is determined by the following for $\tau_1 = 1$ year (8760 hours).

$$v = \frac{h_{2n+1} - h_{2n}}{\tau_{n+1} - \tau_n} \quad \text{in m/year} \quad (8)$$

The depth of thaw h_2 under the edge of the structure is roughly determined by

$$h_2 = Kh_1 \quad (9)$$

where K is an empirical coefficient.

The time for thawing of the soil under the structure for a predetermined depth in terms of a two- or three-dimensional problem is determined by

$$\tau = \frac{h_1}{2k_\tau \lambda_2 t_n} \left[\frac{h_1}{k_\tau} + 2\delta_n \right] \left[q - C_2 (1.9 t_o + 0.5 t_2) + 0.5 C_1 t_n \right] \quad \text{hour} \quad (10)$$

as derived from (7).

So that differential settlements of the buildings and structures do not exceed allowed values, it is necessary to decrease the depth and rate of base thawing by changing the thermal interaction of base soils with the structure either by varying the insulation of the protective structure or cooling by ventilation.

The modified thickness of thermal insulation sufficient to decrease the depth of thawed soil under the structure to the predetermined allowed value h_{1r} in terms of a two- or three-dimensional problem is determined by

$$\delta_{nr} = \frac{\lambda t_n \tau k_\tau}{[q - C_2 (1.9 t_o + 0.5 t_2) + 0.5 C_1 t_n] h_{1r}} - \frac{h_{1r}}{2k_\tau} \quad (11)$$

as derived from (7).

The basic parameters of thaw consolidation under pressure are the consolidation coefficient a_o and thawing coefficient A_o .

The method of rapid determination of consolidation coefficients for soil thawed at a pressure of up to 3 kg/sq cm according to their physical characteristics has been developed, based on the results of consolidation tests with large soil specimens in an insulated oedometer, $d = 200 \text{ mm}$. These tests were carried out at two pressures, p_1 and p_2 (1 and 3 kg/sq cm), in the course of thawing.

Results of the consolidation tests are

$$e_{c1} = \frac{\epsilon_f' - \epsilon_{c1}}{1 + \epsilon_f'} = A_o + a_o p_1 \quad (12)$$

$$e_{c2} = \frac{\epsilon_f'' - \epsilon_{c2}}{1 + \epsilon_f''} = A_o + a_o p_2 \quad (13)$$

where e_{c1} and e_{c2} are values of relative consolidation of the soil specimens at pressures p_1 and p_2 during thawing; ϵ_f' and ϵ_f'' are the values of the initial void ratios for these soil specimens; and e_{c1} and e_{c2} are the values of the void ratios for the thawed soil specimens.

From (12) and (13), the required consolidation coefficients a_o and A_o were determined

$$a_o = \frac{(\epsilon_f'' - \epsilon_{c2})(1 + \epsilon_f') - (\epsilon_f' - \epsilon_{c1})(1 + \epsilon_f'')}{(1 + \epsilon_f')(1 + \epsilon_f'')(p_2 - p_1)} \quad (14)$$

$$a = \frac{e_{c2} - e_{c1}}{p_2 - p_1} \quad (15)$$

$$A_o = e_{c2} - a_o p_2 \quad (16)$$

Generalization of the test data has resulted in mathematical expressions for determination of the factors a_o and A_o within the pressure range of $p = 1$ to 8 kg/sq cm. These expressions are

$$a_o = (aK_s \epsilon_f + C) + \frac{1}{(\Delta p)_1} \quad (17)$$

$$A_o = aK_s \epsilon_f + C \quad (18)$$

Values of the parameters a_o and A_o are shown in Table V; K_s is the correction coefficient varying from 0.7 to 1.6.

Table V. Values of a_o and A_o for (17) and (18)

Soil type	a_o		A_o	
	a	C	a	C
Clayey loams	0.0116	0.0213	0.0762	-0.0008
Sandy loams	0.0135	0.0194	0.0644	0.0030
Sand	0.0125	0.0138	0.0755	-0.0125
Sandy gravel	0.0122	0.0107	0.0756	-0.0196

For calculation of possible foundation settlements on thawing soil, N. A. Tsytoich proposed the formula based on the method of an equivalent layer.

$$S = \sum A_{oi} h_i + \sum a_{oi} F_{gi} + \frac{p}{2h_s} \sum a_{oi} h_i z_i \quad (19)$$

where A_{oi} and a_{oi} are the reduced coefficients of thawing and thaw-consolidation which determine ground settlement; F_{gi} is the area of the diagram of consolidation pressure due to the weight of soil layers (to the depth of thawing); h_i is the thickness of a layer of thawed soil; h_s is the thickness of the equivalent soil layer; p is external consolidation pressure; and z_i is the distance from the middle of the considered layer of thawed soil to the depth $2h_s$.

To make a more precise calculation of the total foundation settlement S on the thawed solid base, V. P. Ushkalov has proposed

$$S = S_1 + S_2 + S_3 + S_4 \quad \text{in cm} \quad (20)$$

where S_1 is the thaw settlement within the zone of consolidation caused by the foundation; S_2 is the thaw settlement beyond the zone of local consolidation; S_3 is the consolidation caused by the weight of thawing soil; and S_4 is the consolidation caused by the pressure imposed by the foundation.

The settlements S_1 and S_2 occur throughout the thickness of thawing soils, whereby the settlement S_1 occurs within the zone of consolidation caused by the foundation (h_f), and the settlement S_2 occurs below the zone of consolidation caused by the foundation ($h_1 - h_f$). The coefficient of thawing beyond the zone of consolidation is assumed equal to 40% of its value within the said zone according to the test results.

The settlement S_3 is caused by the effect of the steadily growing load of the weight of thawing soils (p_o) within the limits of thawing (h_1). The consolidation coefficient caused by this load is assumed to be 60% of the coefficient of consolidation caused by the simultaneously applied load.

The settlement S_4 is caused by the foundation. The depth of the local consolidation zone is 1.5 to 2.5 times the width of the foundation and may be less than the depth of thaw.

The settlement S_4 proceeds with the limited possibility of the lateral expansion of the ground which is considered with the coefficient x .

Having put the values of the items into (20), the expression for the total settlement of the foundation on the thawing-base soil is obtained.

$$S = \sum_1^n A_{oi} h_{fi} + 0.4 \sum_1^n A_{oi} (h_{1i} - h_{fi}) + 0.6 \sum_1^n a_{oi} p_{gi} h_{1i} + \sum_1^n a_{oi} x_i \alpha_i p_{fi} h_{fi} \quad (21)$$

where α is the coefficient taken from Table VI.

Table VI. Values of coefficient α

z:b	Rectangular foundation base with side ratio a:b								
	Scheme I			Scheme II			Scheme III		
	1	3	10 plus	1	2	10 plus	1	3	10 plus
0	1.00	1.00	1.00	1.00	1.00	1.00	1.00	1.00	1.00
0.125	0.97	0.98	0.98	0.98	0.99	1.01	1.01	1.01	1.01
0.250	0.93	0.95	0.95	0.95	0.97	0.97	1.06	1.03	1.03
0.375	0.83	0.88	0.88	0.80	0.88	0.88	1.08	1.06	1.06
0.500	0.76	0.84	0.84	0.70	0.82	0.82	1.03	1.03	1.03
0.750	0.60	0.73	0.73	0.46	0.68	0.68	0.76	0.91	0.90
1.000	0.46	0.58	0.60	0.34	0.53	0.55	0.54	0.77	0.76
1.250	0.33	0.47	0.51	0.26	0.44	0.48	0.40	0.65	0.64
1.500	0.22	0.37	0.43	0.18	0.35	0.40	0.30	0.55	0.56
2.000	0.09	0.20	0.28	0.11	0.24	0.31	0.19	0.39	0.44
2.500	0.02	0.09	0.18	0.08	0.19	0.26	0.13	0.29	0.36
3.000	0.05	0.12	0.05	0.13	0.21	0.10	0.23	0.31
3.500	0.03	0.08	0.04	0.11	0.19	0.07	0.17	0.26
4.000	0.02	0.06	0.03	0.08	0.16	0.05	0.13	0.23
4.500	0.04	0.03	0.07	0.15	0.04	0.11	0.21
5.000	0.03	0.02	0.05	0.13	0.03	0.09	0.18
6.000	0.02	0.10	0.05	0.14

When the thawing depth lies within the limits of the consolidation zone, the second term of the equation falls out and only three terms remain.

The settlement rate is determined by the amount of settlement in a year of building use.

Table VI presents the value of the α coefficient for three different design schemes to consider the variations of the foundation pressure in the soil depending on the depth of the layer, the shape of the foundation base, and the z to b ratio.

Scheme I has been plotted according to the results of field tests performed by V. P. Ushkalov, scheme II according to NITU 127-55 (for thawed soils), and scheme III according to NITU 118-54 (by M. I. Gorbunov-Posadov).

Our scheme of pressure distribution (scheme I) is useful for sandy soils with density (D) ≤ 0.7 , or clay soils with consistency (B) ≥ 0 and thickness of the compressed layer (z) $>$ the width of the least side of the foundation base (b).

According to scheme II, the value of α can be used for determination of pressure in elastic and compact thawing soils with a rigid grain structure, with thickness (z) $\geq 3b$, at density (D) > 0.7 or consistency (B) < 0 .

With the insignificant thickness of the layer of the elastic and compact sandy thawing soil, where $z \leq 0.5b$, supported by an incompressible (bedrock) base, the pressure distribution may be assumed according to scheme III (concentrated compression).

The area of the diagram of pressure distribution according to scheme I averages 80% less than that according to scheme III, and 20% less than the area according to scheme II.

The values of the total differential water contents of the frozen soils and their unit weights can also be determined by investigating the cryogenous texture of the soils.

The meaning of the "soil cryogenous texture" includes the structure of the soil depending on the transition of water into ice, and defined by (a) the content of ice inclusions which occur during freezing, (b) their shape, size, and location, and (c) the size, shape, and location of mineral layers.

The water content of a frozen soil is composed of three parts: Unfrozen water (W_2), ice cement (W_3), and ice inclusions (W_4). The sum of these is the total water content.

$$W_1 = W_2 + W_3 + W_4; \quad W_5 = W_3 + W_2$$

Only W_1 , W_5 , and W_2 are determined directly; W_3 and W_4 are calculated from

$$W_3 = W_5 - W_2; \quad W_4 = W_1 - W_5$$

W_2 depends mainly on the type of soil and its temperature. Therefore, W_2 is determined at site laboratories by a calorimetric method.

W_5 is determined in the field by specimens taken from frozen mineral layers without ice inclusions.

W_1 is determined at the laboratory by two methods, a mean sample method and pycnometric method. In the mean sample method, the frozen soil specimen (usually from borings) is weighed (g_1), then thawed and mixed into a homogeneous mass and weighed again (g_2). The specimen of the mixed soil is put into sample bottles to determine its water content (W_1).

Total water content is calculated by

$$W_1 = \frac{g_1(100 + W_1) - 100 g_2}{g_2} \text{ in \%} \quad (22)$$

In the pycnometric method, total water content is calculated by

$$W_1 = \left[\frac{m_1(\Delta - 1)}{\Delta(m_2 - \nu - \pi r^2 h)} - 1 \right] 100\% \quad (23)$$

where m_1 is the weight of the frozen soil sample; m_2 is the weight of the soil with water up to the mark on the pycnometer; ν is the volume of the pycnometer; Δ is the specific gravity of mineral particles; r is the radius of the pycnometer tube; and h is the reading of the pycnometer scale.

The unit weight of the frozen soil falls into two categories: Total unit weight, including all its components (γ_2), and unit weight of frozen soil with everything but ice inclusions (γ_3).

Determining γ_3 comprises taking a specimen from the mineral layer and determining its weight and volume.

To determine γ_2 , it is necessary to take the frozen soil specimens in the vertical direction throughout the investigated thickness of ground. γ_2 can be determined from data on total water content (W_1), unfrozen water (W_2), and unit weight of mineral particles (γ_1), using

$$\gamma_2 = \frac{0.9 \gamma_1 (100 + W_1)}{90 + \gamma_1(W_1 - 0.1 W_2)} \quad (24)$$

Engineering-geocryological research should include observation of the state and behavior of buildings and structures, and change of the water and temperature regime of the soil under the foundations.

The scope and nature of these observations are specified depending on the type of building or structure, its economic significance, and conditions of the frozen ground.

To meet the above requirements, stationary frozen ground stations are established. Design and work methods are determined by the special program developed for these stations.

Observations at such a station must be made in accordance with the methods stipulated in the standard documents, strictly observing its principal use requirements (as stated in the project

report of the building or structure) that provide for maintaining or gradual changing of the soil regime. The main results of observations are registered in the certificate of the foundations and bases of the structure. The observations begin with the start of construction.

The work of the station comprises investigations on (a) temperature and hydrogeological regime of the base soils, depth and rate of thaw of the base soils under the middle and edges of the building; (b) temperature regime and depth of freezing of the active layer near the building; (c) amount of ground heaving; (d) heaving of foundation, settlement of foundation under the middle and edge of the building; conformity of the actual conditions of building use with the temperature regime of the base soils as specified in the project; and (e) deformations and state of the building.

Analysis of the results helps prove that the proper structures are used and the methods of construction are sound. These data are used in construction on other sites with the same environment.

To test new methods of design, construction, and use of structures, pilot structures are built and multipurpose observation is established to study their condition and behavior.

The following problems in the field of engineering-geocryological research need further development and improvement:

1. Use of vibration methods in boring holes in high temperature frozen ground.
2. Establishment of mobile installations for complex field investigations on physical properties of frozen soils.
3. Improvement of field investigation methods on temperature and water regime of the base soils.
4. Determination of the degree of accuracy in the laboratory model methods for the study of strain and thermal conditions of frozen, freezing, and thawing soils.
5. Development of rapid, indirect methods of determining physical and thermophysical properties of the frozen soils according to their physical characteristics.
6. Unification and standardization of the equipment and methods of field and laboratory investigations on physical properties of frozen, freezing, and thawing soils.

REFERENCES

- [1] A. M. Pchelintsev. "Some Useful Guides in Determining the Density, Moisture, and Ice Content of Frozen Soils," in Materialy po laboratornym issledovaniyam merzlykh gruntov, Sb. 2, Acad. Sci. USSR, Moscow, 1954.
- [2] Tekhnicheskiye usloviya proyektirovaniya osnovaniy i fundamentov na vechnomerzlykh gruntakh, SN 91-60, State Construction Publ. House, Moscow, 1960. [Technical Considerations in Designing Foundations in Permafrost, Tech. Trans. 1033, NRC, Canada, 1962].
- [3] N. A. Tystovich. Osnovaniya i Fundamenty na merzlykh gruntakh, Acad. Sci. USSR, Moscow, 1958. [Bases and Foundations on Frozen Soil, Highway Res. Bd. Spec. Rept. 58, NAS-NRC, Washington, 1960].
- [4] V. P. Ushkalov. Issledovaniye raboty protaivayushchikh osnovaniy i ikh raschet po predel'nykh deformatsiyam sooruzheniy, Acad. Sci. USSR, Moscow, 1962.
- [5] V. P. Ushkalov, R. A. Tokar, D. E. Polshin, V. V. Mikheyev. "Foundation Design in the USSR," Proc. 5th Intl. Conf. on Soil Mechanics and Foundation Engr., Paris, 1961.

DISCUSSION—SESSION 7

R. M. HARDY, Exploration and Site Selection in Northwest Canada

The general excellence of the papers presented to this session may leave the impression that completely satisfactory methods for site exploration and selection in permafrost areas are available. It is very questionable that such an impression is correct, particularly in zones of sporadic or discontinuous permafrost.

Satisfactory procedures using freezing techniques appear to have been developed for the drilling and sampling of solidly frozen permafrost. However, these methods are not particularly suitable for site exploration at locations where it is not known if permafrost exists. The exploration program at such sites should: (a) Determine the existence of permafrost, (b) establish whether existing permafrost is in a solid or partial frozen state, and (c) determine whether permafrost has recently existed at the site and the extent to which consolidation of recently thawed permafrost has progressed under the overburden load.

Experience in Canada recently has shown that conventional procedures for site exploration cannot be depended upon to even identify permafrost, let alone provide useful data on its condition or whether the ground has recently thawed and is still consolidating. By conventional procedures is meant that an experienced drilling crew with engineering supervision and with modern drilling and sampling equipment is assigned to the site exploration.

A thread of experience can be traced through several papers that indicate discovery of permafrost on the North American continent progressively farther south of what, in recent years, has been taken as the southern boundary of permafrost. This is recognized despite the fact that, geologically, permafrost

is considered to be receding to the north.

Much experience in Northwest Canada now indicates that sporadic permafrost exists over a much wider zone than has been previously suggested. Moreover, experience in zones of sporadic and discontinuous permafrost indicates that only slight disturbance to the surface thermal regime precipitates rapid disintegration of the permafrost. It also indicates that solidly frozen permafrost may exist within a few inches below the surface of organic cover in isolated zones with no evidence of permafrost for several miles in surrounding areas.

Permafrost has also been found below as much as 20 ft of overburden in a solidly or partially frozen layer several feet thick. Remnants of permafrost in the form of isolated ice crystals have been reported at depths of 60 ft in areas many miles from known existing permafrost.

Construction projects in permafrost areas, under the Canadian economy, vary from the comparatively large integrated developments at Inuvik to buildings on single city-sized lots at Thompson, Manitoba. Moreover, recent construction in the fringe areas of permafrost has been much more extensive in Canada than is generally appreciated. Experience with this construction has emphasized the difficult nature of determining characteristics of, designing foundations for, and identifying frozen ground in sporadic and discontinuous zones of permafrost. As far as Canadian conditions are concerned, there is, without question, a need for more research work oriented to the solution of these problems. The interdisciplinary approach that has been emphasized at this conference appears to offer the best prospects for progress.

SESSION VIII SANITARY AND HYDRAULIC ENGINEERING

SANITARY ENGINEERING IN ALASKA

AMOS J. ALTER, Alaska Department of Health and Welfare, Juneau

Alaskan sanitary engineering is the essential force in community development that has made places livable. Isolated dwellings and communities on permafrost were transformed from mere places of existence to modern and comfortable homes. Living in a home or community now without safe and adequate water supply and waste disposal facilities is like using a horse and buggy in the space age. With sanitary engineering, the second largest city in Alaska has been transformed from a city of "honey buckets" and "water bottles" to a modern community.

How was this transformation accomplished? Transformation means placing a value on safe and adequate water and waste systems equal to the value placed on a foundation, walls, or a roof in constructing adequate shelter. Although safe and adequate water and waste systems are as essential for arctic buildings and communities as they are for temperate climate structures, they are often deleted from consideration. In many places it was not considered possible to keep sanitary works from freezing.

Water and waste systems are usually the elements of arctic buildings which are most acutely affected by freezing. Freezing temperatures regularly take their toll of building and community sanitary systems. To prevent freezing and make communities and isolated installations more livable, the successful arctic sanitary engineer has subjected his designs to an extra analysis—to a thermal analysis—as well as to conventional, structural, chemical, biological, aesthetic, feasibility, and functional considerations. He has considered low temperatures, snow, frozen ground, ice, waste heat, and numerous other factors as resources to be utilized rather than resources to be ignored or avoided. Engineers operating in this frame of reference have produced some ingenious systems and works.

Sanitary systems were made to function reliably even under the most adverse conditions through capture of heat from normally waste heat sources, water reuse, improved methods for heat conservation, regulated heat makeup for lost heat, and process substitution.

TYPES OF SYSTEMS DEVELOPED

All sanitary engineering design concepts in use now in Alaska for water and sewage works may be divided into three general categories: (1) Protection from freezing by encapsulation or isolation from damaging temperatures; (2) insulation and heating of facilities wherever they may be located to protect them from damage by low temperature; and (3) utilization of nonfrost-susceptible systems.

Encapsulation for Frost Protection

Complete containment of water supply and waste disposal systems is not possible without full reuse of the water and ultimate disposal of sewage solids within the containment. Otherwise, a source of water supply must be located outside of the containment. In several installations in Alaska, an effort was made to minimize the need for fresh water supply by utilizing recirculating-type toilet systems. Waste water from showers and lavatories was reused as flushing water for toilets. Water use was further reduced by using plumbing fixtures which require only a small quantity of water. With

proper maintenance and control, recirculating-type waste disposal systems and water reuse techniques have met with a moderate degree of success.

Further improvement in waste water reclamation methods will make encapsulation of facilities even more promising. Advancements in space travel have stimulated interest in encapsulated systems. In general, there are smaller quantities of objectionable material to be removed from waste waters in space travel than the quantities of material which must be removed in treating seawater or some highly mineralized waters found at Arctic sites. It will probably be some time before reclaimed waste water will be fully acceptable for general use.

Perhaps the words, modified encapsulation, best describe present Alaska systems in this category. Initial water supply source and ultimate disposal of sewage solids occur outside of the encapsulated area. Water storage space and space for collection of sewage are adequate for extended periods but not adequate for continuous use.

Several Alaskan water and sewage works are encapsulated to the degree possible. They are enclosed in prefabricated structures. The structures are composed of a series of units erected from prefabricated sections. Water supply units, waste disposal units, kitchen, bedroom, recreational area, and utility units are assembled in the order and number desired to produce the finished structure.

Complete encapsulation of waste disposal works was accomplished in a few instances by use of substitute processes and methods as well as encapsulation of facilities. A "dry type" system was tried. This system depends on mechanical collection of solids and incineration of them within the enclosure. Although such systems may be readily enclosed for weather protection, they are not acceptable.

Protection by Insulation and Heating

The first and principal methods for protection of water and sewage works are insulation and heating devices. By retaining available heat in the systems and adding heat as needed, positive protection is provided. The success of such practices depends upon careful selection of structural materials and availability of energy.

Locating water plants near power plants facilitates use of waste heat from power generation. Cooling water and exhaust steam are used to heat sanitary works. Electrical heating devices and warmed air from ventilating systems serve as valuable heat sources. Water pumped from beneath the permafrost and wasted into sewers provides a heat source for some sewers. Waste heat from chemical and physical reactions, solar energy, wind operated power generating equipment and electrical transmission facilities is also used to protect systems.

Utilidors and enclosed ducts or conduits protect utility services from freezing. In some communities heat, water, electricity, telephone, and sewer services are provided through these below-grade ducts. The utilidor is heated by waste heat from the heat distribution lines.

A recirculating-type water system, which provides for recirculation of water throughout the entire system, including house service connections, made water distribution possible in one community, even though distribution lines are placed

directly in permanently frozen ground. In another community, the water supply lines were placed inside a larger pipe, and waste cooling water from power-generating equipment was circulated through the annular space between the water supply line and the outer pipe.

Insulating materials are used throughout all systems in this category. Insulating materials (used with varying degrees of success) were: Asbestos, glass wool, foam glass, chemically expanded organics, lightweight concrete, shavings, sawdust, moss, paper, moist clays, wood, reflective coverings, grasses, sod, cinders, etc.

Utilization of Nonfrost-Susceptible Systems

Application of nonfrost-susceptible system techniques is suitable for waste handling. There is little advantage of this technique in water supply since water is the product which must be transported and used. A substitute material may not be used.

In providing a nonfrost-susceptible waste disposal system, in at least one instance, fuel oil was substituted for water in a liquid carriage system. The fuel oil is used not only for flushing the wastes into the collection system but also for carriage of the wastes to a central point. At the central point the wastes are sufficiently mixed with the fuel oil so that they may be fed into the fuel injection system in the central heating plant. In this way the wastes and fuel are burned and produce heat and electrical power for the installation. Synthetic flushing fluids of a similar nature were utilized in other installations. In some industrial installations almost all plant wastes are incinerated and valuable chemicals are recovered. These chemicals are reused in the plant production process.

Other substitutions of nonfrost-susceptible systems include incinerating-type toilets which incinerate the wastes at the source, and mechanical conveyance of wastes rather than hydraulic carriage. Much effort was directed toward improvement of incinerating-type toilet facilities and in the development of wet-combustion methods and high-temperature oxidation or flameless combustion of atomized wastes.

At seashore sites, where salt water is readily available and corrosion can be avoided, salt water has occasionally been substituted for fresh water in the sewerage system. The salt water was also used as a source of water supply for the installation. Although salt water does not afford a great margin of safety, it does provide some additional margin of safety over fresh water in a sewerage system.

WHICH SYSTEMS HAVE BEEN MOST SUCCESSFUL?

Low temperature emphasizes the importance of adequate, efficient, economical, and simple water and waste systems which are operable under all conditions. Compatible community configuration, buildings, and water and waste systems are essential to installation and operation of successful systems. Beauty, symmetry and appealing innovation are meaningless if water is not available and waste disposal systems are inoperable.

By designing community and housing in a cluster arrangement, exposure of water and sewerage systems to permafrost and low temperatures may be held to a minimum; this arrangement eliminates the need for long runs of water and sewer piping. Some designs are recommended that centralize all utility services in the center of a cluster development. Materials and arrangements which inherently provide fire-breaks and fire protection are adopted to avoid fire hazards that may result from cluster or communal type developments.

Harmony of community and building design with water and waste system design greatly facilitates the economy and reliability of sanitary services under low temperature conditions. A community that is to be served by a recirculating water distribution system must be plotted in a fashion to effectively and efficiently recirculate water throughout the community.

The most successful systems are simple, in harmony with

community configuration, present minimum exposure to possible frost damage, make maximum use of materials and resources at hand, are constructed so they may be taken out of operation during emergency without damage to the system, and make efficient use of manpower and energy. These are requirements for a successful system. Nonfrost-susceptible, insulated, or encapsulated facilities all were successful. Encapsulated facilities were used most extensively for waste disposal; insulated systems, for water supply.

CONSTRUCTION AND OPERATION PROBLEMS

Greatest of the numerous construction and operation problems occurred in providing adequate water supply service. Although corrections were made as the difficulties arose, experience has focused attention on the most vulnerable parts of water and sewage works systems.

Water System Problems

Difficulties occur in all parts of the water system—in procuring an adequate source, in developing the source, in treating the water, and in distributing it. Two source problems are: Providing a stable impoundment on permanently frozen ground, or locating an adequate source of supply where ground water is used. Wells froze when they were not pumped enough to keep them open. Pumping a well too much resulted in restriction of production from the aquifer. Intake structures designed to take water from a reservoir became clogged with ice and unworkable when inadequate attention was given to location and design of the intake structure.

Most water treatment processes are affected by low temperature; in general, it is much more difficult to treat cold water than to treat warm water. Aeration, coagulation, settling, filtration, and disinfection processes are all subject to impairment by low temperatures.

Water distribution systems often freeze with resultant damage to distribution lines. Heat sources designed to keep the distribution system in operation have occasionally failed; insulating material was inadequate or became damaged and allowed the system to freeze. Basins, pumping equipment, and distribution lines were damaged when taken out of service because of inadequate provision for drainage when facilities were not in use.

In instances where every feature of the waterworks system was not considered as a potential heat problem, freezing problems have resulted.

Waste Disposal Problems

The effectiveness and utility of many sewage collection, treatment, and disposal practices are impaired by low temperature. Biological, biochemical, and chemical reactions are generally retarded by low temperature. In some facilities low temperatures have altered the function or the structure to the extent that the unit has become useless.

All parts of waste disposal systems are known to be affected by low temperatures. Venting and gradient are significant factors in collection systems. Severe low temperatures often cause vents on the collection system to close completely with frost. In instances where sewers were placed at minimum grades and without special structural features to retain vertical alignment, settling has occurred. Waste heat caused permafrost to melt and the resulting unstable condition permitted the sewer to settle. Pocketing of sewage left in the sewer later resulted in freezing. The upper end of sewers, containing insufficient flow to supply the heat losses from the sewer, had frozen.

Almost all sewage treatment units are affected by low temperature. Bar screens, comminutors, grit chambers, flow measuring devices, settling tanks, filters, aerating equipment, sludge drying beds, digesters, and miscellaneous sewage treatment units have failed because of low temperature. Exposed control equipment has frozen. Cold air supply to blowers and aeration units has resulted in reduction in sewage

temperatures below temperatures necessary for favorable biological activity.

In enclosed sewage treatment, moisture control is often a problem. Unless provision is made for air conditioning, excess moisture in the air condenses on cold surfaces and forms ice on walls, doors, windows, and exposed metal parts.

Construction Problems

Construction of properly functioning water and waste systems is often more difficult than construction of other engineering works. Water and waste systems must remain stable, at proper elevation, on proper grade, and within a rather narrow range of temperatures suitable for the processes. Sufficient heat must be present in the system to facilitate chemical and biological reaction. The liquids must not freeze. Yet, heat escapes from the systems and it must not be allowed to destroy the stability of foundations, pipelines, storage reservoirs, and buildings. At some sites, heat was allowed to thaw permafrost and the ground became unstable upon thawing.

Poor construction techniques in placing foundations and pipelines were instrumental in later causing failure of the sanitary engineering works. Construction methods resulted in changed ground-water movement which in turn changed the temperature balance of the site.

NEEDED WATER AND WASTE DISPOSAL RESEARCH

There are many unanswered questions concerning arctic water and waste system design, construction, and operation.

U.S. SANITARY AND HYDRAULIC ENGINEERING PRACTICE IN GREENLAND

D. G. BALL AND I. H. CALL, Metcalf & Eddy, Boston, Mass.

U.S. military installations in Greenland are extensive and range in latitude from the southern tip 350 miles below the Arctic Circle to the northern part of the subcontinent. Conditions encountered vary from a moderate nonpermafrost environment to areas with permafrost many hundreds of feet deep. Several rather elaborate installations have been built on the icecap itself. The principal sanitary and hydraulic engineering problems encountered are described.

The largest and best known unit is Thule Air Base, on the remote northwest coast of Greenland, 900 miles from the North Pole. Sondrestrom (BW-8), also on the west coast at the Arctic Circle, and Narsarsuaq (BW-1), near the southern tip, were small U.S. air bases already existing that were extensively developed after 1951 at the time of construction at Thule. Concurrently, several icecap installations were built in the high interior, ranging in location from sites more northerly than Thule south to the subarctic latitudes.

Most of Greenland is covered with a permanent icecap several thousand feet thick in the interior of the island. However, in many areas along the coast, the ice front stops short of the water, leaving a strip of ice-free land, generally barren of substantial vegetation in the arctic latitudes. Thule is situated in such an area.

THULE AIR BASE

The bay at Thule normally freezes in October, and bay ice attains a thickness of about 6 ft. The bay clears in June or July, though icebergs are present throughout the summer season.

Climate

Violent wind storms that sometimes reach 100 mph with gusts of 150 mph occur occasionally between November and April.

Although considerable effort has been exerted in study of such systems, efforts should be redoubled and greater attention directed toward improved system concepts. Further study and research are indicated in all aspects of arctic water supply and waste disposal; the following needs suggest some of the more important unanswered questions:

1. New concepts in water supply and waste handling are needed to provide water acceptable for reuse and to provide improved collection and disposal of wastes.
2. Low temperatures and low temperature phenomena must be used to advantage in water and sewage wastes.
3. Community planning suited to water supply and waste disposal requirements of the Arctic are essential.
4. Concepts for individual housing in the Arctic must be better correlated with characteristics of community and utility service needs and should make use of locally available resources.

ARE SANITARY ENGINEERS MEETING THE CHALLENGE ?

Although sanitary engineers have performed magic in the Arctic in making places livable; further challenge remains. Sanitary engineers are challenged to suggest new concepts; they are challenged to research. They are challenged to cooperation with social scientists, economists, municipal planners, architects, and builders in improving public health and living standards. As research in low temperature sanitary engineering expands, as interdisciplinary approach to problems is made, as interclimatic relationships of environment are noted, and as international teamwork develops, the sanitary engineer is meeting the challenge to better living.

Usually these winds are not accompanied by very low temperatures; however, the wind chill factor often exceeds 1400 and sometimes reaches 2000.

Mean annual rainfall from 1946 to 1949 was 2.55 in., and snowfall was 14.9 in., for a mean annual precipitation of about 4 in. In 1955, a new high was reached, with 2.1 in. of rain as a daily high and a total of 10.45 in. precipitation for the year.

Subsurface

Permafrost is estimated to extend 1600 ft at Thule (Fig. 1). The surface, or active layer, normally thaws from 1 to 6 ft, depending on the nature of the soil, its moisture content, and surface cover. Maximum thaw depth is attained on high, dry, gravelly soils. However, in low areas where melt water accumulates, where fine sand and silt are trapped, and where boggy conditions are produced which have induced the growth of grasses and other low vegetation, thaw penetration is extremely shallow—sometimes as little as 6 in. in a season. In general, finer soils thaw less rapidly, and the presence of melt water tends to delay the thaw rate.

No true ground water table exists, because the high freezing index at this location ensures sufficient back-freeze each winter to preclude unfrozen formations below the active layer. However, a seasonal high moisture layer follows the thaw downward, resulting in a relatively high moisture zone near the bottom of the active layer.

Random deposits of ground ice, frequently in the form of large continuous masses of pure white or clear ice, are generally found throughout the valley.

Water Supply [1]

Two possibilities were considered for the Thule water supply—

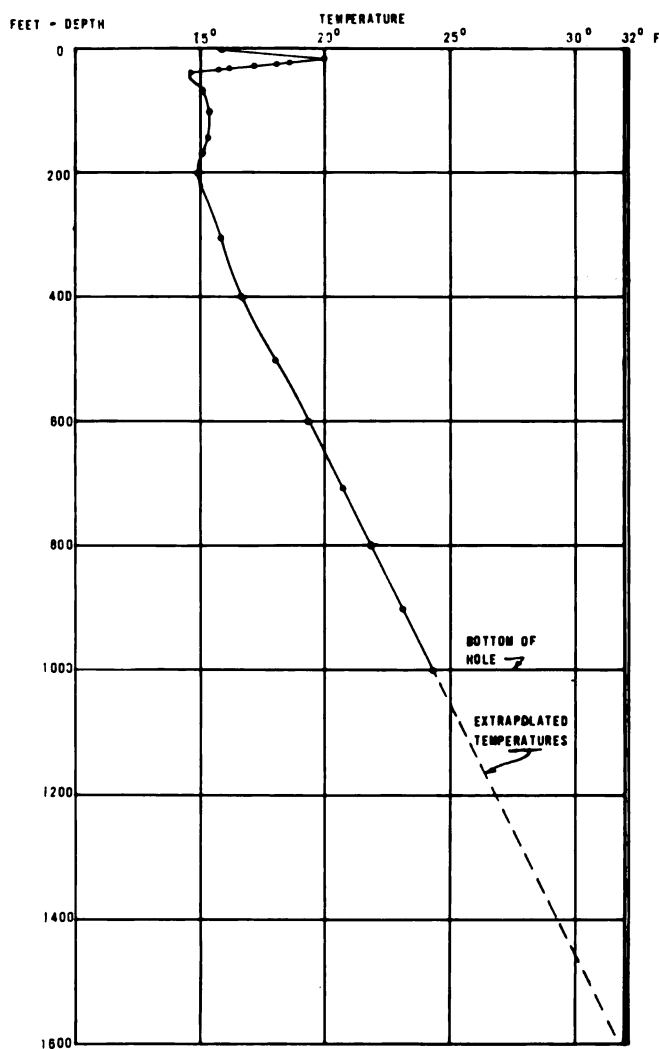

Fig. 1. Subsurface temperatures in rock hole three inches in diameter

surface runoff and sea water distillation. The possibility of ground water existing, particularly near the icecap, was thoroughly explored during the first construction season, when it was found that there is no year-round unfrozen layer above the permafrost.

Because of the requirement for early operational capability and lack of information on surface runoff, a sea water distillation system was initially designed and constructed. As further information was acquired during the first construction season on surface water availability and its character, a water supply system using existing and enlarged lakes for water storage was developed and became the principal system with distillation as a standby.

Average water consumption is about 600,000 gal per day. It was estimated that about 23% of the lake's yearly 220 million gal refill water would come from its runoff area of 7.5 sq miles; the remaining 77% would be diverted from a nearby icecap-fed stream.

The water treatment plant is designed to reduce color from 100 to 0-15 ppm, turbidity from 40 to 0-5 ppm, and iron from 1.6 to 0-0.3 ppm. Water is treated by three solids contact clarifiers, called Erdlators, of a design developed by the Corps of Engineers Engineering Research and Development Laboratories.

Deep well pumps draw water from a point close to the bottom of the storage lake and deliver it via steam heated conduits to the receiving tank. From the receiving tank, as

water enters the Erdlator, pulverized limestone and ferric chloride are added to aid in the flocculation process which takes place in the Erdlator. Chlorine is added as a disinfectant. Pressure sand filters separate the remaining floc particles and fine foreign materials.

The water is heated in two stages during the treatment process. In the first stage, water is withdrawn from the raw water pump discharge and heated in the heat exchanger to approximately 180°F. It is then mixed with raw water entering the receiving tank to maintain a temperature of approximately 40°F. In the second heating stage, a small portion of the filter discharge water is bypassed through a steam heat exchanger. It is remixed with the main water flow from the filters to raise the temperature sufficiently to ensure delivery of water to the base at or above 40°F. The temperature at the mixing valve might have to be as high as 60°F, depending on ambient temperature and rate of flow.

After the second heating stage, the treated water is passed through a totalizing water meter and is delivered to the heated outside storage tank or to the base supply pipeline. Treated water is withdrawn from the plant effluent and stored in the washwater tank until used for backwashing the filters. The washwater waste is returned to the reservoir.

Treated water storage, equal to more than a half day of water usage, is provided by three 125,000 gal heated storage tanks. In addition to providing this much water, these tanks operate as surge tanks to absorb the daily base water usage fluctuations, which allow constant flow through the treatment plant and through the pipeline between lake and base.

Pipeline

The water pipeline between the lake and the base is a heated and insulated 8 in. aqueduct, 5 miles long. Primary heating for this line consists in preheating the water before it enters the pipe at the treatment plant. Secondary and emergency heating is provided by two electric heating cables (one automatic and one a manual standby), which trace the whole line and are designed to maintain the water in the pipe above 40°F.

The distribution system from the on base storage tanks to buildings is also aboveground heated pipelines. These lines, like the steam distribution lines, are run on overhead bridges at road crossings where the depth of nonfrost-susceptible material is not deep enough to prevent thawing of high ice content soils.

Emergency sources of water, such as sea water distillation and an on base small lake, have a combined capacity of approximately 35 gal per capita per day. The distillation system has a rated capacity of about 12 gal per capita per day.

The principle lake storage was first developed by building dams and dikes to raise the water level of the original lake about 8 ft. The dams and dikes were compacted earth fill. After two years they were raised another 6 ft. Some difficulties were encountered with leaking the first year, but a winter's backfreeze raised the level of permafrost within the dams above the trouble area and leaking stopped.

Sewage Disposal [1]

As an expedient, in the first period of base operation, the sewage was pumped from a sewage tank inside each building to heated tank trucks for transportation to the sea. In the buildings, a pneumatic water system, supplied from a water storage tank (fed by tank truck in the early days), delivered water to lavatories, showers, and sinks. These fixtures drained into a sump and then into a wastewater tank, which was the source of water for the toilets. Sewage was manually pumped from the marine-type toilets to the sewage tank.

The system was not only expensive to operate and difficult to maintain, particularly during periods of severe weather, but the use of wastewater for toilet flushing was very objectionable. Wastewater acquires an extremely sour and disagreeable odor while standing in tanks prior to its use for flushing. Calcium hypochlorite was found helpful in reducing odors. Odor escaped from the waste tanks and toilets and soon

permeated the entire building through the ventilating system. The marine-type toilets are designed, in general, for rather infrequent use. At a military installation, consequently, careless and heavy use break or wear out the moving parts of the manually operated pump assembly. Finally, the manual labor required to operate the pumping mechanism results in inadequately flushed toilets, thus creating additional odors.

Marine toilets were eventually supplemented by conventional hydraulic flush toilets, and the marine toilet system was kept in reserve. Because underfloor piping is undesirable in the off-ground insulated floor construction used at Thule, wall-hung blow-out flush toilet fixtures are used. Wastewater and sewage is collected in a sump in the building and discharged into gravity sewer lines by an ejector. The sewer lines are similar to the aboveground, electrically-heated, insulated, steel pipe water lines. After comminution, the sewage is discharged into the bay without treatment. The outlet pipe runs along the bay bottom approximately 2500 ft from shore, where the depth of water is 20 ft at mean low tide.

Electric Heating versus Steam Heating

Since there was ample generating capacity available at Thule to provide the heat necessary for the proposed water and sewage systems, either electricity or steam could have been used. Both methods were considered practical. A cost analysis showed the electric system to be cheaper, since with this system, a much smaller conduit is necessary to enclose the line.

There would be about 50% more metal required for the conduit using the steam heating method than for electric heating. The amount of insulation necessary, being a function of the conduit diameter, would also be greater in the steam heating system.

The heating cable used is mineral insulated, designed to operate at a skin temperature of 185° F. The cable is placed parallel to the axis of the pipe in a small electrical conduit attached to the steel pipe. Heat is regulated by thermostats to maintain the water at 40° F. The conduit and pipe are enclosed in 3 in. of thermal cellular glass insulation. It was necessary to protect this insulation with metal covering to prevent erosion from windborne sand. In other similar installations, considerable care had to be taken in locating the thermostats, lest they become buried in snowdrifts.

Water and sewage pipelines are supported by timbers resting on pads of nonfrost-susceptible material at least 2 ft deep. Where pipes go underground, such as at road crossings, they are installed in corrugated metal pipe, allowing circulation of air to reduce danger of permafrost degradation due to heat loss through the insulation. Three feet of nonfrost-susceptible backfill is placed below the corrugated pipe.

Where ponding would result from pad construction across natural drainage area, ditches or culverts are provided. In view of the small runoff, culverts are sized for maintenance purposes. Snow and ice blockage is a constant problem, and experience has shown that culverts and ditches are seldom given the care required to keep them free of debris. For these reasons, the minimum size culvert selected for drainage was 18 inches.

At all pad crossings where culverts were required instead of an open ditch due to pad depth, a riprapped relief ditch above the culvert was provided as insurance against wash-out, in case the culvert did not thaw before ponding resulted.

Design basis for drainage computations was a modified rational method in which the runoff coefficient "c" and the rainfall intensity "i" are constants. The factor "ci" was taken as 0.03 in./hour/acre for natural areas and 0.04 in./hour/acre for building areas.

All ditch slopes in ditches deeper than 3 ft were surfaced with 2 ft of nonfrost-susceptible material to reduce the danger of slumping.

SONDRESTROM AIR BASE

Sondrestrom Air Base (BW-8) is on the west coast of Greenland,

30 miles above the Arctic Circle at the head of Sondrestromfjord, about 100 miles from its mouth. Sondrestrom is 660 nautical miles south of Thule.

The base is on a high and fairly level terrace of gravel, sand, and silt, believed to be formed by deposits from the melt waters on a receding glacier. This terrace and an adjacent river extend from side to side of the fjord, which is characterized by rather steep slopes on both sides rising to 2000 ft. The outlet glacier of the icecap ends about 10 miles northeast of the airfield.

Seasonal winds blow down from the icecap; however, these "foehn" winds are extremely warm, increasing in temperature as the result of the compression of the air as it drops suddenly from 10,000 ft to near sea level.

Climate

The mean annual temperature is 24° F. Permafrost exists throughout to over 150 ft, with the active layer subject to seasonal thaw extending to a depth of 1.5 to 11.0 ft, depending on the surface cover. The freezing index is 4430 degree-days, and the thawing index is 1980 degree-days. The total precipitation is 5.5 in. These figures represent average values for a 3 year period.

Water and Sewage

At Sondrestrom, the initial design of the water supply system was a simple truck fill stand at a lake about 5 miles from the station. The water was hauled in heated trucks and delivered to storage tanks in each building. The sewage was collected into waste tanks at the buildings, then transported to a disposal area by truck. The truck haul system for water supply and sewage disposal was used for all of the original buildings. For several new permanent buildings, water is supplied by pipeline from a separate water storage building close to the new facilities. The electrically heated and insulated water line is laid on wooden supports above the ground.

Sewage from the new buildings is collected in sumps and discharged in slugs from each building into wood stave pipes. The outlet is in the nearby river. Slug discharge is more effective in retaining heat in the sewage, and the wood stave pipe provides adequate insulation where this type of discharge is possible.

NARSARSSUAK

Narsarssuak Air Base, situated near the southern tip of Greenland, roughly 350 nautical miles south of the Arctic Circle, is in an environment more like the sub-Arctic than the Arctic. The waters off Narsarssuak seldom freeze completely. There is no permafrost, and frost penetration during the winter averages only 8 to 10 ft.

Extreme temperatures range from -17° F to 75° F. Precipitation is high, averaging 27 in./year, with the heaviest, 3.5 in./month, occurring in late summer and autumn.

The winter water supply is pumped from wells in the river bed to a reservoir. The summer supply is gravity-fed from a stream-supplied pond. The sewage is discharged untreated into the fjord.

COMMUNICATION STATIONS

In addition to the principal air bases, several communication stations were built on ice-free mountains near the coast and on the vast icecap plateau in the high interior.

The land-based stations follow the same pattern of either truck haul or heated-insulated water supply line from lake storage as at Thule. Sewage is discharged untreated down the side of the mountain through steam-heated, insulated outfalls.

On the icecap, unique problems, particularly in disposal, were encountered.

Icecap Installations

Structures on the icecap, under successive unmelting snowfalls, become buried within the ice mass itself at a fairly uniform rate of about 3 ft/year near the surface. The rate of burial decreases with depth as the density of the snow increases. Structures intended for continuous use over a period of years must be designed to allow for this gradual subsidence. Some have been built to remain buried. Continued access is attained by telescoping vertical tubes rising to the surface. Others have been built on buried foundations supporting an elevated structure that is periodically jacked to keep it above the snow surface. In either case, any heat put into the snow by sewage disposal must be kept far enough from the structures to prevent influence on the rate of settlement.

The following is a description of the construction camp sanitary facilities for one installation under construction for about 3 months with a peak labor force of about 100 men [2].

On either side of the kitchen was erected a single Attwell, one for water storage and the other for a latrine. The latrine was equipped with four lavatories, four shower stalls, one 90 gal/hr. oil-fired water heater and four toilet stools. Solid waste was caught in cut-down POL barrels and transported frequently to a waste pit some distance downwind of camp. Kitchen and latrine waste water was piped to a point about 25 feet from the kitchen and discharged onto the snow where it eventually made a hole 3 feet in diameter and 60 feet deep.

The water storage Attwell was equipped with one oil-fired water heater, pump, pressure tank, a 75-gallon storage tank and twelve 50-gallon barrels for water storage.

Six delivery barrels mounted on a sled transported water to the storage tanks from a Cleaver Brooks snow melter 500 yds. upwind from camp. A dozer filled the snow melter. The pump in the water storage Attwell both filled and emptied the storage barrels. The camp used approximately 15 to 25 gallons of water per day per man. A washing machine, used by the cooks only, consumed much of the water although it is believed sufficient water could have been supplied for free use of the machine. Water supply required about six man-hours per day.

In general, the permanent installations on the icecap get their water supply from snow melters fed by dozers, and the sewage is discharged untreated through wood stave sewers into the snow.

To determine the depth and lateral extent of the sewage pits, and the extent of snow warming near the pits, a study was made of three installations in use at least a year [3]. One installation had been used 3 years and then abandoned.

The holes thawed vertically down from the sewage outfalls were about 3 to 4 ft in diameter at the outfall and 7 to 12 ft in diameter at the top of the sewage lenses. The lenses were planoconvex, with a nearly plane bottom. Thicknesses of lenses were from 20 to 35 ft at the centers. Diameters ranged from 100 to 200 ft. Tops of lenses were roughly 100 ft below the snow surface.

The summary of the investigation is quoted:

The depth of sewage penetration appears to be more dependent on snow density than snow or sewage temperatures. In all cases the specific gravity of the snow underlying the sewage lenses was approximately 0.80. Snow of this density is impervious (see SIPRE Report No. 37 dated November 1957).

The diameter of the sewage lens is dependent on the rate of flow and the sewage and snow temperatures. The effect of the sewage and snow temperatures is very small compared to that of the rate of flow for volumes of sewage to be expected in camps of 20 men or more. . . .

Significant warming of the snow around the lens is limited to approximately 50 feet in all directions. Sufficient warming to cause enough loss of snow strength to cause possible differential settlement is confined to a distance of less than 10 feet.

Differential settlement, except directly over the liquid pool, if any, is small enough to be insignificant. In fact, no evidence of settlement such as a layer of higher than normal density snow directly above or below the sewage lens was encountered.

The rate of sewage buildup (increase in elevation of surface of sewage) is primarily dependent upon the rate of flow (approximately 36 feet per year for an average rate of 1000 to 1500 gallons per day). . . . The rate of buildup will not be constant unless it happens to roughly equal the snow accumulation rate at the site. Where the mean buildup rate exceeds the snow accumulation rate, it will be greatest early in the life of the sewage pit dropping as the ice-lens rises into less dense snow and the diameter of the lens increases.

ACKNOWLEDGMENT

The information contained in this paper was derived principally from investigational and design work done by the Corps of Engineers, U. S. Army, and Architect-Engineer joint ventures in which Metcalf & Eddy participated. The authors wish to express their appreciation to the Corps of Engineers for permission to present these data.

REFERENCES

- [1] Greenland Completion Report 1951-1953—Metcalf & Eddy and LaPierre, Litchfield & Partners to Corps of Engineers, U. S. Army, pp. I31-I45, II8-II9.
- [2] Project Dog-Sled, Construction Report. Northeast District Corps of Engineers, 1953.
- [3] Technical Report No. 467 by Metcalf & Eddy to East Ocean Division Corps of Engineers, "Ice Cap Sewage Pit Investigations," 1961.

DOMESTIC WATER SUPPLY AND SEWAGE DISPOSAL IN THE CANADIAN NORTH

A. B. YATES, Department of Northern National Resources
D. R. STANLEY, Stanley, Grimble, Robin, Ltd., Ottawa

This paper deals with water supply and sewage disposal in the Yukon (Y. T.) and Northwest Territories (NWT) of northern Canada. These cover 1,511,979 sq miles or 39.3% of the total Canadian land and water mass; lie above 60° latitude, and are populated as far north as Alert at the 83° latitude.

Within this vast area there is a great variety of physical characteristics, ranging from rugged mountains through timbered valleys and plains to the bleak tundra north of the tree line. Lakes and rivers abound.

Climatic conditions, though varied, are characterized by long, cold winters and an almost desertlike lack of precipitation. Temperatures may fall as low as -82° or rise to 95° F. In the high Arctic, winds of over 100 mph are frequently recorded with below zero temperatures. Much of the Territories is covered by permafrost. Fig. 1 shows the line above which permafrost can be expected. Further south, isolated pockets of permafrost may exist and anywhere in the Territories frost conditions must be considered in the design construction, and operation of water supply and sewage disposal systems.

Within this area live fewer than 40,000 persons—14,628 in the Y. T., the balance in the NWT. Indians or Eskimos make up more than 15,000.

The economy of the Territories is based on its resources, both renewable and nonrenewable. Communities have grown up around mines (Yellowknife); transportation centers (Whitehorse); trapping areas (Aklavik), and administrative and education centers (Inuvik).

Communications routes into and within the Territories are shown in Fig. 1. Only the Yukon and the southern parts of the Mackenzie River basins are served by road or rail. The rest is served by water and air or air alone; hence, transportation is costly. Water transportation costs to Spence Bay from railhead at Waterways, Alberta (Alta.), for example, are \$400 per ton. The water shipping season is short, off-loading facilities at most settlements primitive, and goods are often lost or damaged in shipment. Normally, air transportation is more certain although more costly, but only larger settlements are equipped with airstrips capable of handling multiengine aircraft.

The governments of the two Territories are in a transitory stage developing toward full autonomy as provinces. At present the Y. T. is governed by a Commissioner appointed by the Governor General in Council, aided by a fully elected Council of seven. The NWT are governed by a Commissioner, aided by a Council of four elected members and four federally appointed members. The NWT are soon to be split into two, the Mackenzie Territory and Nunassiatq, the Mackenzie Territory moving toward a greater autonomy. Natural resources of the Territories (except game management) are administered by The Federal Government. The Federal Government also has a statutory responsibility for the welfare of the Eskimos and Indians.

Some steps have been taken toward local municipal government in the Territories and a few municipalities exist. Other local governments are in transitory stages (Local Improvement Districts, Villages, etc.) developing toward municipal status.

The establishment of local government is difficult because of the relatively small private as compared to Federal or Territorial assessment in communities.

Isolation

Isolation of settlements is a major factor in the design, construction, and operation of water supply and sewage disposal facilities. Designs must be complete because of this isolation. Project materials are normally shipped in by boat during the summer season. Missing items must be flown in at considerable added cost.

Design simplicity is imperative. Operators at best are

partly skilled and work under the most difficult conditions. The nearest source of technical advice and guidance may be 1000 miles away; thus, duplicating essentials is advisable.

Construction materials and equipment for the job and shelter and food for the crew must be shipped according to a precise plan. The work crew must be very carefully selected—an inefficient man on the crew does perhaps more damage to a project than any other single factor.

Isolation makes repairs on existing systems difficult. Spare parts and skilled tradesmen may have to be flown in. Good design by duplicating essentials or by supplying spare assemblies and simple design by eliminating complicated controls and machinery can greatly reduce operating problems.

Labor

Modern trade skills are being gradually developed by the Canadian Eskimo and Indian. At present, only a very few skilled tradesmen are available.

Most skilled labor for construction projects must be brought in from southern Canada, must be transported to and from the job, fed, and housed, and may cost more than \$1000 per month to support.

Good design in the Arctic, therefore, requires maximum use of local unskilled and semiskilled labor for construction. Not only is this cheaper, but it also develops the latent skills of local people.

THE PROBLEM

The problem of water supply and sewage disposal in northern Canada is twofold: First, to obtain adequate water supplies for drinking, culinary, and minimum sanitation requirements and dispose of human waste, garbage, and wash water in a satisfactory, sanitary manner. Second, to provide modern water and sewerage systems so that inhabitants can enjoy normal amenities at reasonable cost.

MAJOR FACTORS AFFECTING DESIGN

Frost and Permafrost

The design, construction, and operation of water supply and sewage disposal systems are inevitably affected by the site frost conditions.

In permafrost-free areas, annual frost may penetrate 14 to 16 ft, and it is often considered uneconomical to bury pipes below frost level. Systems are designed to operate in totally or partly frozen ground. While a sewerline, because of the heat carried in it, normally operates quite well during the winter if buried to a moderate depth (7 to 10 ft), a waterline readily freezes unless special precautions are taken. Continuous circulation or bleeding to waste alone or coupled with water heating are means commonly used to prevent freezing under these conditions.

In permafrost areas a different approach to design is taken to prevent heat transfer from the system to permafrost. Permafrost can sometimes be used to advantage, for example, by creating a permafrost dam.

Population Density

Most settlements are sparsely populated. Larger towns which have proper sewer and water systems may have 2000 persons or less. Populations of settlements in which some form of organized water supply and sewage disposal facilities exist or are planned range from 500 to 1000. Fewer people means less money to pay for these services.



Fig. 1. Map of Canada

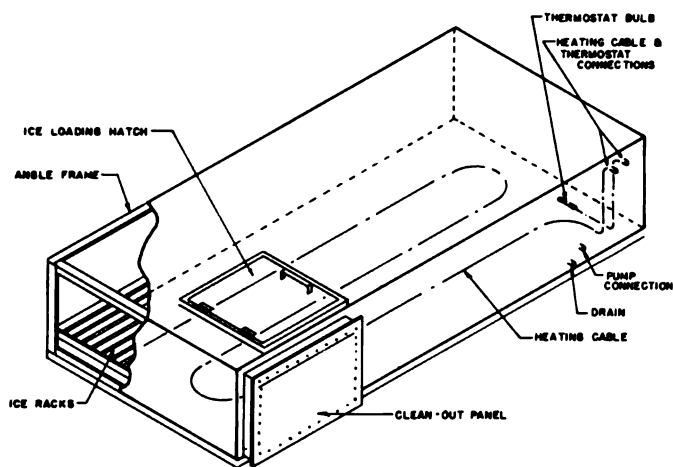

VIEW OF WELDED ALUMINUM ICE MELTING TANK
 (WATER STORAGE)

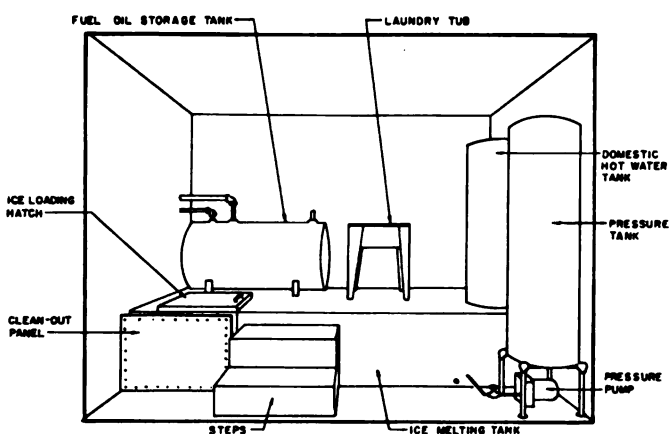

VIEW OF MECHANICAL ROOM
 THREE BEDROOM HOUSE, 1962 MODEL

result in the consumer's paying twice as much as his southern counterpart for relatively primitive facilities.

CURRENT DESIGN APPROACHES

Water Supply and Treatment

Water supply in northern Canada is obtained from surface waters, such as lakes, rivers or streams, or, in a few cases, ground water.

Fortunately, northern Canada is well supplied with rivers, creeks, and lakes which provide adequate sources for domestic water supply. During winter, however, some of these sources may freeze into solid blocks of ice, making conventional means of transporting the water to the consumers impossible.

Many rather large settlements still depend on ice for their winter water supply. Modern technology is used in its harvesting and conversion to water. Ice is cut into blocks by gasoline-powered saws and transported by tractor-drawn sleds. Ice-melting tanks (Fig. 2) are used in buildings to convert ice to water. While natural ice is normally pure, it can become contaminated during cutting, transporting, and long storage outside the home at the mercy of the sled dogs. The householder is encouraged to use chlorination tablets or a liquid chlorinating agent before using the water for drinking or cooking.

Ground-water supplies are used in a few instances in the north to supply individual and in some cases community water supplies. There has been very little exploration for ground water and consequently the potential has not been exploited. At present the Geological Survey of Canada is gathering data and will soon publish a report on ground-water potential in northern Canada.

Most surface waters in northern Canada are of excellent quality and require little, if any, treatment before being used for domestic supply. In some small lakes the water may be colored, and in some of the rivers or streams it may be turbid, colored, or both.

Sewage Disposal

(a) Individual—For individuals and settlements where a piped sewage disposal system is not practical or economical, many different methods are used for sanitary disposal.

Where soil and frost conditions permit, pit privies, cess-pits, and septic tanks are widely used. Low temperatures retard action in septic tanks, hence, larger tanks with longer retention periods are often used. Septic tanks may be buried as much as 10 ft below ground.

Through much of northern Canada, pit privies or septic tanks are not practicable due to permafrost conditions. Here the most widely used form of sewage disposal is the "chemical toilet," with plastic bag insert. This type of toilet (without the plastic bag insert) is widely used in southern Canada in camps and summer cottages. It is manufactured as a utilitarian article and does not fit into the otherwise modern and attractive permanent housing built for the North. The Canadian Department of Northern Affairs and National Resources has designed a more pleasing looking toilet of the same type with a polyethylene bucket, costing about \$30. The plastic bag is made of 2 ml polyethylene and costs about 3.5 cents. The plastic bag with contents is disposed of either individually or through an organized pickup service.

More refined methods of individual sewage disposal are also in limited use in the Canadian North. None has gained general acceptance, partly because of cost and also because of their greater complexity and potential unreliability. One of these uses a recirculating chemical fluid; another type uses propage gas or electricity to burn the excreta; a third is a recirculating aerating unit. A multiple unit of the latter type was design by the Ontario Research Foundation and installed in the school at Cape Dorset, NWT. Sufficient operating experience has not yet been gained to assess this unit.

In some locations where septic tanks have been used, the soil will not absorb the effluent and pump-out tanks are pro-

Fig. 2. Typical ice melting tank

Economics

No new scientific or engineering breakthroughs are required to bring northern people pure water and safe sewage disposal. However, the development of more rational design criteria through practical research and better community planning to facilitate economic servicing could reduce costs substantially.

In southern Canada the source of money for water supply and sewage disposal systems is the municipality. The municipality ultimately recovers the capital and operating costs from the taxpayer but may be helped initially by a grant or a loan from the province.

In northern Canada, few municipalities exist and none has a big enough tax base to afford a water supply and sewage disposal system. Municipalities have been aided by Territorial and Federal Governments to build these facilities. Once built, operating costs are recovered from consumers.

In unorganized settlements, however, operating costs are often too high to be recovered from the limited number of consumers. On the other hand, health conditions make pure water supply and safe sewage disposal mandatory. The Government of the NWT, therefore, pays 50% of the capital and operating costs of these systems, the balance being paid by consumers. Even these generous financial provisions often

vided. A trucking system is set up to periodically haul away and dispose of the septic tank effluent.

(b) **Community**—Where there is a community-piped or a trucked-sewage collection system, there are generally three alternatives for treatment and disposal.

The first is simply discharging into a river or lake without pretreatment. If dilution is not considered satisfactory then some form of pretreatment may be required. This may be any conventional treatment with or without chlorination. It is questionable whether there are any situations in the North where treatment for removal of biochemical oxygen demand (B.O.D.) or suspended solids is justified. In most cases, reducing coliform organisms is the only justification. With large rivers such as the Mackenzie, concentration of coliform organisms is low enough to be within normal standards, except very close to outfall sewers.

Sewage lagoons or stabilization ponds are another method of treatment. Observations made by the Canadian Department of National Health and Welfare indicate that under almost any conditions sewage lagoons provide the safest and most economical sewage disposal for communities and institutions. Research work is necessary, however, to more clearly establish design criteria.

Certain design criteria have been established for sewage lagoons in more populated parts of Canada and in the United States. Some are arbitrary, but more recent ones have been established on the basis of research and experience. Climatic conditions in the North made it rather dangerous to apply these criteria there. It appears that when sewage can be stored over the winter and discharged during the few summer months after the effluent is sufficiently treated, the requirements of good treatment are met.

Depths of 7 to 8 ft should be provided. The lagoon can be operated at a depth of 3 to 5 ft in the summer, but the greater depth is used for winter. Also with ice thickness up to 6 ft there is still some liquid in the lagoon. In general, B.O.D. loading is not a major problem, although if deeper lagoons are provided, B.O.D. loading in the spring may be rather high.

Anaerobic lagoons may have some potential, but the very low temperature retards biological action. Anaerobic lagoons need long retention ponds when used for storage unless the effluent can be discharged into a large enough body of water to dilute the bacteria to a safe count.

Trucked Distribution and Collection Systems

In many northern settlements trucks or trailers supply water and haul away sewage. The use of a truck distribution or a piped system is based on economics. While the operating cost of a piped system is normally cheaper, its capital cost is much higher. The truck system is more practical for the smaller, scattered settlements. In some cases, interest on capital required for a piped system (this included the relocation of several buildings) was sufficient to pay annual operating costs of the truck system.

The truck used is either a conventional two- or four-wheel drive or a tracked vehicle. The latter is necessary where no roads exist and where an oversnow vehicle is required in winter. The same vehicle can haul trailers for water, sewage, and fuel oil.

The water tank truck used is usually fitted with a 1000 gal, two-compartment steel tank. A fire pump of 100 gpm with 50 ft of hose is also carried on the truck as an emergency fire fighting vehicle.

The sewage tank truck used is also normally fitted with a 1000 gal, two-compartment steel tank. A separately powered sewage pump is mounted on the truck.

Insulated tanks have been and are being used in some locations. The extra expense involved does not seem warranted since uninsulated tanks give equally satisfactory service with reasonable care.

Inside buildings, water and sewage tanks are provided and Pullman-type toilets are used to conserve water. A typical plumbing layout for a house is shown in Fig. 3.

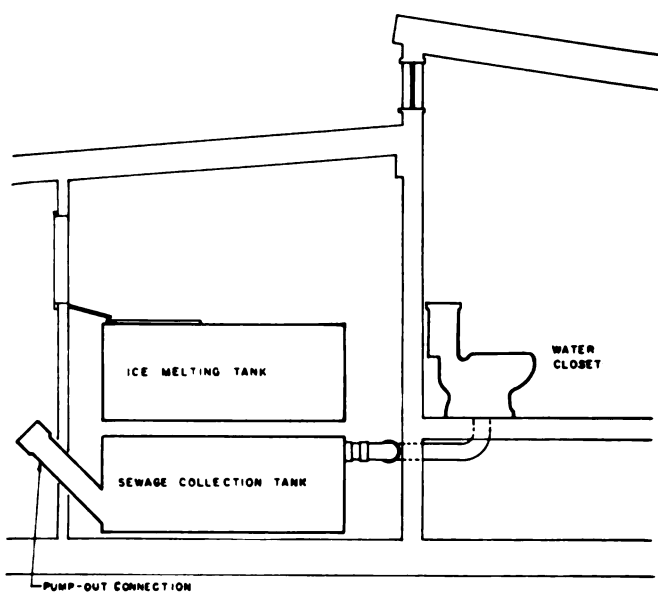
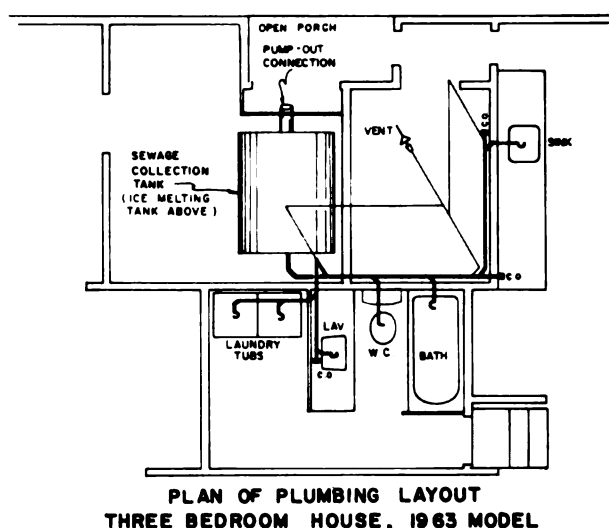

Fig. 3. Typical plumbing layout for trucked system

Piped Water Distribution

To attract personnel needed in northern Canada to administer both government and private operations, it is becoming more apparent that most people, especially those living in larger communities, are demanding modern water and sewerage facilities. In the past few years this demand has resulted in several modern, but expensive, water distribution systems. Essentially five types of piped distribution systems were considered:

1. A conventional piped system is built with the pipe buried below seasonal frost penetration.
2. A conventional piped system is built with the pipe laid within the seasonal frost penetration but with heating and recirculating or wasting to prevent freezing.
3. The pipe is insulated and buried within the seasonal frost penetration. Less heating with recirculation or wasting is required.
4. The pipe is insulated and placed in permafrost areas above, on, or below the ground. Heating and recirculation or wasting is required.
5. A utilidor is used to carry the pipe. This is perhaps best for reliability but because its cost is high, its use should be reserved for high rise or concentrated building schemes.

Piped Sewage Collection

Where there is a demand for modern piped water systems, piped sewerage systems are also needed, except where septic tanks and disposal fields can be provided. Piped sewage collection systems considered were:

1. A conventional gravity system is built below the frost. Because of deep frost penetration in most of the North, this system cannot often be installed. In many cases, however, the system can operate to some extent within seasonal frost penetration. The warm sewage normally coming out of buildings is such that sewers operate satisfactorily even if the normal frost penetration is a few feet below the bottom of the pipe.

2. A gravity system is built within seasonal frost penetration but provided with sufficient flow by bleeding to prevent freezing, or is located close enough to a heated water system to prevent freezing.

3. A gravity system is placed within the seasonal frost layer but insulated to reduce heat loss. In such cases, it may be possible to operate the system on very little bleeding with normal flow in the sewers.

4. A pressure sewer system is devised with recirculation in the system or wasting. Here the pipe could be either insulated or uninsulated, depending on the relative cost of heating and installation. It would be practical to build such a system only if each service contained a septic tank so that effluent from the septic tank could be pumped into the pressure collection system. Pumping raw sewage into such a system would probably not be feasible.

5. Utilidors provide the most reliable sewerage systems but their cost is high. Other systems deserve more study before they are rejected for the more simply designed but more costly utilidor.

A Low Cost Piped System

A minimum standard, low cost, piped system design needs a basic water source and a means of sewage disposal. Instead of a trucked system an insulated plastic pipeline is proposed of 2 or 3 in. in dia. insulated with 1.5 to 2 in. of flexible glass fiber. All of this is completely enclosed in a 6 to 8 in. plastic pipe. This line might be laid as a loop circuit right on the ground, or just under the ground to prevent damage, or perhaps even suspended above the ground on power poles. It will pass through each building to eliminate the danger of frozen building services. Continuous circulation is maintained and heat is added at the pumphouse, if necessary. The cost of this piping is only about \$5/ft with little installation trouble.

For the sewerline a similar looped system can be used. Each house or building is equipped with a septic tank within the heated perimeter and the effluent from the tank will be discharged into the continually circulating, pressurized main sewerline. Since no solids are carried in the sewerline, a 2 or 3 in. dia. pipe can be used.

Hopefully, a prototype of this system will be built at one of the settlements soon, perhaps to supplement a trucked system. If successful and economically feasible, it would be practical for settlements such as Akalavik, Pangnirtung, and Tuktoyaktuk.

EXAMPLES OF SYSTEMS

Six examples of water works and sewerage systems for communities in the NWT and Yukon Territories are discussed below. Each illustrates a unique system and its special problems.

1. Forth Smith, NWT

Fort Smith, on the Slave River at 60° lat. (Fig. 1), is a community of about 1000 persons. The water and sewerage systems are examples of conventional design methods. The community is situated mostly on sand covered with jackpine. Anticipating growth in this community, a long-range town plan was prepared to provide for a population of about 6000.

The waterworks recently completed at Fort Smith includes an intake in the Slave River; a supply line, a water treatment plant with coagulation sedimentation, filtration and chlorination; a water distribution system, and ground and elevated storage.

Although designed and built according to standard practices in many parts of Canada, this system had a few problems unique to the North. The intake and pumphouse were constructed on rock a few feet from the shore and close to some rapids in the Slave River. A serious problem with frazil ice on the inlet screens was anticipated. The intake structure was designed to allow water to be drawn from near the water surface in the summer to obtain water of minimum turbidity and from near the bottom in the winter to minimize a frazil ice problem. Inlet screens are designed so they can be removed from inside the structure. Also, heating facilities are provided in the intake structure so water in the intake well can be heated and hot water can be pumped into the inlets. Both precautions were taken to avoid frazil ice problems. After two years of operation, no difficulty with frazil ice has been experienced.

Another problem was building a supply line from the intake structure up an unstable hillside to the water treatment plant. Experience indicated that the hill would continue to slide a little each year, making a buried pipeline impractical. Consequently, a pipeline was designed using 6 in. cast iron, flexible-joint pipe with Styrofoam insulation and several expansion joints at different locations on the hill. The pipe between expansion joints is held together by cables, and supports at each joint allow longitudinal movement. Most of the movement in the hill occurs in the spring, and adjustments must be made periodically.

The water distribution system is laid with a minimum cover of 11 ft; experience with the system has been very satisfactory. The water distribution system is built of asbestos cement pipe and each service is provided with a copper wire from the corporation stop at the main to the curb stop, so it can be electrically thawed if necessary. There is also provision in the distribution system for heating and circulation through the major loops of the system.

This sewerage system is conventional in design. Asbestos cement pipe was used to reduce grades. The minimum cover for the sewerage system was 9 ft, and operations are satisfactory. Sewage is treated in the lagoon then discharged into the Slave River, which provides ample dilution. Although no treatment could have been argued, the cost of this sewerage lagoon was low.

The cost of providing the equivalent service in the Fort Smith area should be about 35% more than in Canadian prairie provinces.

2. Yellowknife, NWT

Yellowknife is a mining town of about 4000 persons. A modern water and sewerage system constructed in 1947 and 1948 serves 2700.

Yellowknife has an excellent water supply from the Great Slave Lake, and no treatment other than chlorination is required. Water is pumped from the lake, heated, and then pumped to the distribution system through a supply line. Because problems were experienced with the supply line, part of it was laid on the surface and covered with moss for insulation. This is a satisfactory and economical method where pipelines are run through uninhabited areas and there is always a flow in the pipe.

Water is distributed in a two pipe system having a supply and a return line. Water is kept flowing continuously, and returns to the pumphouse at the lake. Waterlines are at a depth of about 5 ft. The sewer system is built mostly of corrugated metal pipe. It is relatively shallow and is kept from freezing by being located close to the waterline and by bleeding.

Sewage is collected and pumped to a small lake used for storing sewage. Overflow from this lake goes into Great Slave Lake, and health authorities are concerned that this overflow may significantly contaminate the lake water. This operation

is being studied to determine the magnitude of this problem.

Building unit costs of the water and sewerage system at Yellowknife were considerably higher than at Fort Smith, only 150 miles to the south. There does not appear to be any permafrost in Yellowknife, although a considerable amount of what appeared to be permafrost was in the area when the system was built. This added greatly to construction cost.

3. Rae, NWT

Rae is a settlement on three low lying rock outcrops on the easterly shore of Marian Lake (Fig. 1) where about 630 persons, 95% Indians, live. In summer, nomadic Indian families add 400 or 500 to the population.

Prior to construction of the new facilities, sanitary conditions at Rae were deplorable. The spring runoff carried waste, garbage, and sewage from the settlement into Marian Lake where residents obtained their water, often not even troubling to take it from the center. Severe dysentery outbreaks resulted in some deaths. Along with the design and construction of low-cost facilities, therefore, a public health program to train leaders from within the community was initiated.

Besides being the only source of water and being contaminated, Marian Lake is shallow near the settlement and freezes to the bottom by March each year.

To use this water source, a reservoir of 2.5 million gallons was built in the lake adjacent to the settlement. Water from the lake is carried into the reservoir by an infiltration gallery. Reservoir depth is adequate to provide sufficient winter storage of water for the settlement underneath the ice.

Water is pumped from the reservoir to a small treatment plant contained in a metal-clad building 28 ft by 24 ft. Water is filtered through a rapid sand filter, chlorinated, and stored in a 5600 gal tank. The plant rating is 25 U.S. gal/min.

Treated water is transported from the plant to most consumers by water truck. Close to the treatment plant, however, an 80-bed hospital, is more economically served by utilidor. This utilidor is a simple, wooden, insulated box that carries water and sewer pipes for the hospital. Warm air, thermostatically controlled, can be blown through the utilidor.

The 1000 gal water truck is equipped with fire pump and hose and thus performs a dual function.

Larger houses are equipped with 200 or 300 gal water storage tanks and pressure systems, but smaller ones have only small 40 gal tanks with spigots.

No area near the settlement was suitable for building a sewage lagoon. It was decided to provide a primary treatment plant to discharge a chlorinated effluent into a slough. The package unit is designed for 5000 gal/day of domestic sewage. It provides for comminution of the sewage solids, continuous aeration of the activated sludge sewage mixture in the aeration compartment, and continuous clarification of the aerated sewage in the settling compartment. Settled activated sludge in the settling compartment is returned to the aeration compartment by airlift pump.

Sewage from the hospital is carried by utilidor to the treatment plant. Sewage from other consumers is carried by a 1000 gal sewage tank truck to the plant. There are, however, problems yet to be resolved in sewage collection from houses. The better houses, those with water tanks and pressure systems, are equipped with 200 or 300 gal sewage tanks. The tank truck has no problem handling these. Other houses are equipped merely with chemical toilets and plastic bag inserts. Handling the plastic bags presents some problems in disposal at the treatment plant.

The contract price for water supply and sewage disposal facilities, including two trucks and a heated garage for them, was \$165,789. Monthly operating cost of the systems is estimated at \$2000. Wages for truck drivers are the major part of this cost.

Payment for services must be simple because no clerical or accounting help is available. A water delivery and sewage pickup schedule is arranged and consumers pay according to the type of building they occupy. For example, the small Indian house equipped with a chemical toilet and 40 gal water tank is charged about \$15 per month. On the other hand, the

3 bedroom house with full plumbing is charged \$45 per month. Similarly scaled are the rates for hospitals, offices, etc. These charges cover 50% of the total cost of owning and operating, which is \$3000 per month. The balance is supplied by the Federal-Territorial subsidy.

The system provided for Rae is rather typical for other settlements of this size. Rae is perhaps unique, however, in using several systems—artificial reservoir, low cost utilidor, etc.

Despite efforts to keep costs down, the consumer with even the most elementary services must pay \$15 per month.

4. Inuvik, NWT

Inuvik is just north of the Arctic Circle on the East Channel of the Mackenzie River (Fig. 1). Its continuous permafrost was a major factor in the development of the townsite. The East Channel of the Mackenzie River supplies water during times when it requires no treatment other than chlorination. During this period water is pumped through the distribution system to a lake located at a high point on the other side of the community. This lake can provide a supply to the community during periods when the quality of the Mackenzie River water is not satisfactory for use. Also, the lake in itself has a supply from the small drainage area which provides part of the water required. The lake water is of good quality except that it contains relatively large suspended particulate matter which is effectively removed by using a microstrainer.

Distribution pipes for the water system are contained in a utilidor which also contains hot water for the central heating system and the sewage collection pipes. Water and sewer pipes are asbestos cement. Sewage is conducted from the townsite by a gravity sewer outfall about 4000 ft long to a lagoon area. The outfall sewer is insulated with Styrofoam and there is provision for heating. Experience over the past few years of operation indicates, however, that insulation is normally sufficient to prevent freezing, and heating is seldom needed.

A cross section of the type of utilidor used at Inuvik is shown in Fig. 4. There was about 15,000 ft of utilidor constructed at a unit cost of about \$224 per ft. Utilidettes that connect utilidors with buildings cost about \$134 per ft and about 5500 ft were built.

The sewage lagoon was built by damming the ends of a slight draw and placing a very small berm along one side. Some vegetation was stripped off the bottom of the lagoon to provide a greater depth by thawing the permafrost. The purpose of the lagoon was essentially to store sewage, for discharge into the East Channel under controlled conditions (at times of the year when there was no danger of contaminating the water supply). The degree of treatment in the lagoon is not too important. Under certain conditions in the winter the flow in the East Channel has reversed. The discharge at this time of any sewage into the river downstream from the townsite might have resulted in contaminating the water system if lake storage had not been provided. Some difficulty has been experienced with the collection of solids at the inlet to the lagoon. However, this could possibly be remedied by providing floating movable inlets or providing greater depth in the lagoon, or both.

5. Hay River, NWT

Located at the mouth of the Hay River on the south side of Great Slave Lake, with about 1000 persons, this community, one of the largest in the NWT, is not served by modern water and sewerage systems. The community is on a deltaic island of silt and sand, underlain mostly by permafrost. The island is subject to flooding. After a severe flood in the spring of 1963, a new residential subdivision was created on the mainland south of the town above flood level, where tests reveal only sporadic permafrost. The soil conditions with frost-heaving and permafrost present some very difficult design problems.

At present, water supply for the community is obtained from very shallow wells which produce water with considerable iron. This iron is removed and the water is delivered by truck. How-

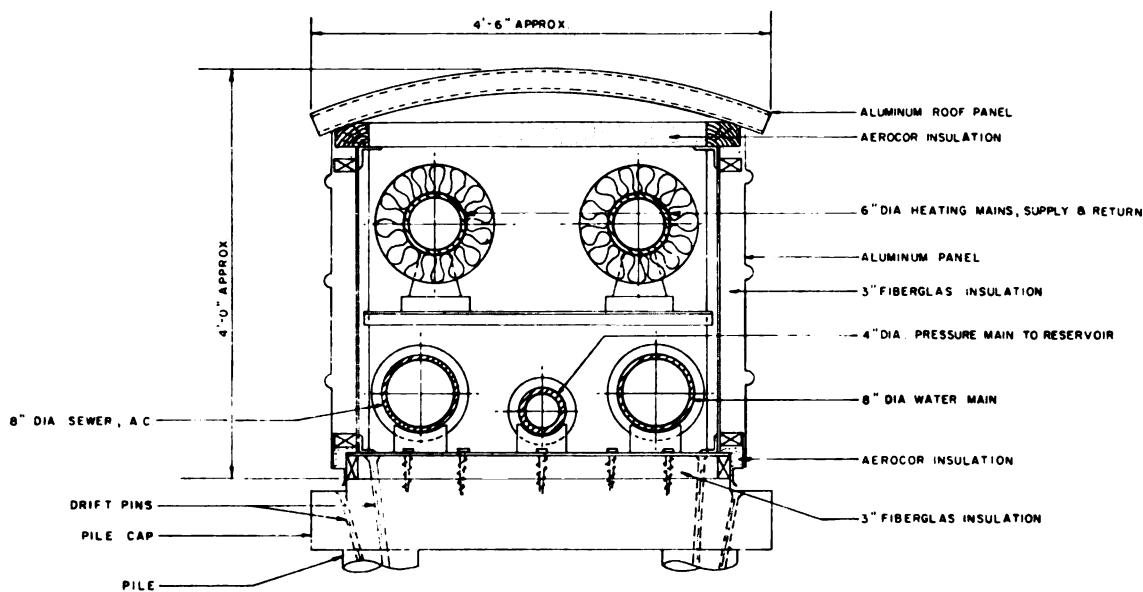

SECTION THROUGH UTILIDOR, INUVIK, N.W.T.

Fig. 4. Inuvik utilidors

ever, the water supply is insufficient for a modern system. The two alternate sources are the Hay River or Great Slave Lake. Water in Hay River is highly colored and would require complete treatment; but water taken from various distances in Great Slave Lake indicate that four miles from shore satisfactory water can be obtained that requires only chlorination. Further tests may substantiate this.

The major problem at Hay River is to build and operate a water distribution system and a sewage collection system on the island. Tests on frost and permafrost show that a conventional system buried below the frost is not feasible. A water distribution system can be built and operated without too much difficulty. It would probably be buried about 4 ft below the surface with heating and recirculation in all lines and waterproof insulation around the pipe. Also because of the soil conditions and the expected frost-heaving, it would be necessary to construct these lines of materials with relatively flexible joints, so that considerable movement in the pipes could be tolerated without damage.

The sewerage system would be a problem because frost-heaving would make a system of the gravity type very difficult to construct. However, other systems have been considered. One is a pressure system with every service, having a septic tank from which the effluent would be pumped into the pressure lines, and then to a lagoon. This system could be kept from freezing either by recirculation and heating or by bleeding. Analyses indicate that the system with bleeding would be more economical. At present such a system has been studied, but none has been built in Canada. With the very difficult soil conditions in Hay River, this system would appear to be the most practical.

Further study may indicate that the gravity system can be built if sufficient foundation material is placed under the pipe. It might also be necessary to insulate the sewer pipe to prevent freezing.

When considering whether to build a water distribution system which bleeds to prevent freezing or uses circulation with no bleeding, consideration must be given to the problem of the sewage. Bleeding of the water system obviously will help keep the sewerage system from freezing.

It is questionable that the Health Department at Hay River would approve placing waterlines and sewerlines in the same ditch. However, if a recirculating water system can be placed close to the sewerage pipes, heat from the water system will keep sewage from freezing, and very little bleeding would be necessary.

6. Dawson City, Y.T.

Dawson City is about 400 miles northwest of Whitehorse at about 64°N and during the Gold Rush of 1898 the population reached 50,000 persons. The winter population is now about 500. Water and sewerage systems are 60 years old. Constructed essentially of wood stave pipe, the water system is generally 4 ft deep, although in some places it is as shallow as 6 in. Dawson City is in a permafrost area, and frozen ground surrounds all pipes in winter. Freezing is prevented by heating the water and bleeding.

There are about 130 year-round consumers—and about 40 more in the summer. The community is sparsely populated, having about one customer to every four lots.

Most heating is provided by electricity produced from a hydroplant with surplus power, so that the increment cost of heating and pumping is not high. However, within the next 2 or 3 years, the hydroplant may be replaced by a diesel plant. This would increase the heating and pumping costs. It has been estimated that the cost of heating the present facilities by conventional means, such as coal, would be about \$90,000 to \$100,000 a year. This is an exorbitant cost for about 130 winter customers and means of cutting this heating cost have been investigated. The solution may be to insulate some of the pipes.

CONCLUSIONS

The effectiveness of any solution to the problem of sewer and water facilities is likely to be judged on its cost in relation to the number of people served. It is seldom possible to achieve the ideal convenience and comfort on the basis of least cost and some compromise must be accepted.

Good town planning in the North needs to avoid long utility runs. Concentration of buildings is difficult to achieve because of the slow rate of growth of most northern communities. The northerner's individuality operates against concentration of buildings. Such concentration seems easiest to achieve in mining and other single enterprise communities.

Many technical questions of northern water supply and sewage disposal systems require a program of practical research. Designers are understandably reluctant to incorporate untried ideas into systems because of the severe consequences of failure on a whole community. They prefer to spend more money to be safe.

WATER SUPPLY AND DRAINAGE IN ALASKA

WARREN GEORGE, Alaska Corps of Engineers, U. S. Army

In recent years, water supply and drainage considerations have received increased attention by all agencies of the Federal and State Governments and citizens' groups interested in water conservation control. It is becoming more apparent each year that what was once assumed to be a resource of inexhaustible supply in areas of ample precipitation and an abundance of flowing streams and clear lakes has become, because of unregulated industrial use and development and large increases in population, a matter for real concern.

Robert E. Jones, Chairman of the Natural Resources and Power Subcommittee, recently stated:

The Natural Resources and Power Subcommittee of the House Committee on Government Operations is initiating a series of wide-range hearings concerning the nation's problems of water pollution control in order to determine how effectively the Federal Government agencies are coping with water pollution problems, and what can be done to improve our techniques for preventing and controlling the ever-increasing pollution of our country's rivers and other water. This Committee stresses the need to conserve and develop adequate water supplies of quality and urges control of pollution now contaminating these resources.

Areas with adequate precipitation are now confronted with the same problems as the arid areas: The need to husband this vital resource. All sections of the country now have a common interest in planning the development of each new project for maximum use. As a result, water use has assumed major importance in all planning efforts. The solution of each situation requires careful, comprehensive analysis, and this planning demands the best efforts of those responsible.

The wide range of disciplines represented in these Proceedings can be a step toward the required controls.

Alaska faces a happier situation than most states, even though climatic influences do present special problems. It is about one-fifth as large as, and stretches over distances equal to, the width and depth of the former 48 states (Fig. 1). Maps, issued by railroads and even the U.S. Government, depict Alaska in the lower left-hand corner of a map in a misleading reduced scale. In fact, Alaska is larger than the states of Texas, California, Oregon, and Washington combined; or to make another comparison, fourteen times the size of Indiana. It has a variable climate, not unlike the Scandinavian countries including Denmark, and an area of 586,000 sq miles contrasted with 294,000 for its European counterpart (Fig. 1). It lies generally within about the same northern latitudes. In water resources, minerals, forest, fish, and potential arable lands and hydropower, it compares most favorably. As the Gulf Stream tempers this European complex, so does the Japanese current affect much of Alaska's coastal and contiguous regions. Its population, now a scant quarter million, cannot fail to grow eventually to the size of the Scandinavian complex of over 15,000,000 and match its economic development—one of the best in the world.

Future growth makes planning for the development of Alaska, including the care and protection of its water resources, an exceptional opportunity. We should be able to do this wisely from experience gained in the industrialized and populous regions of the United States.

An outline map of Alaska (Fig. 2) shows most of the water points engineered by the U. S. Army Engineer District, Alaska, in its work on building facilities for the many military posts, camps, stations, and bases. These features are very important in any such planning, and considerable thought has been given to establishing the best approach. The map also shows, in general outline, the southern limit of permafrost.

Water supply in the earlier days came from—and even now



STATE OF ALASKA AND ORIGINAL 48 STATES
AT THE SAME SCALE

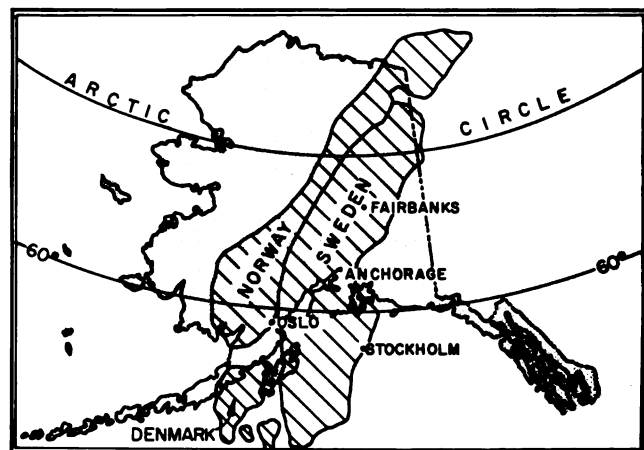

STATE OF ALASKA AND NORWAY, SWEDEN AND DENMARK
AT THE SAME SCALE AND LATITUDE POSITION

Fig. 1. Geographical comparisons

comes from—rivers, streams, and lakes in the open periods of spring, summer, fall, and in winter when water can still be drawn from under the ice mantle. The ice mantle can range from a few inches to a maximum of about 66 in., depending on temperature severity. In the far North, shallow lakes and rivers (used for supply in summer) freeze solid in winter, but melting snow and ice supply the winter needs in most cases.

Because of sparse population, disposal of waste was not then the problem generated today because of subsequent growth of communities.

Serious problems did arise in rapid-growth areas. As an example, in contrast to the present rather complete and modern water intake treatment and distribution system for the city of Anchorage, it was (and still is) common practice in some outlying fringe districts for residents to sink shallow water wells 30 to 40 ft into the gravel mantle generally found above silt and clay deposits in this area. In a few cases, waste disposal was possible via Cook Inlet or creeks emptying into the Inlet; but these exceptions were a small part of the total. Therefore, on these same normal size building sites, a septic tank-type disposal and gravel bed drainage facility for water borne waste were also a common expedient. Health authorities soon realized that a critical situation existed.

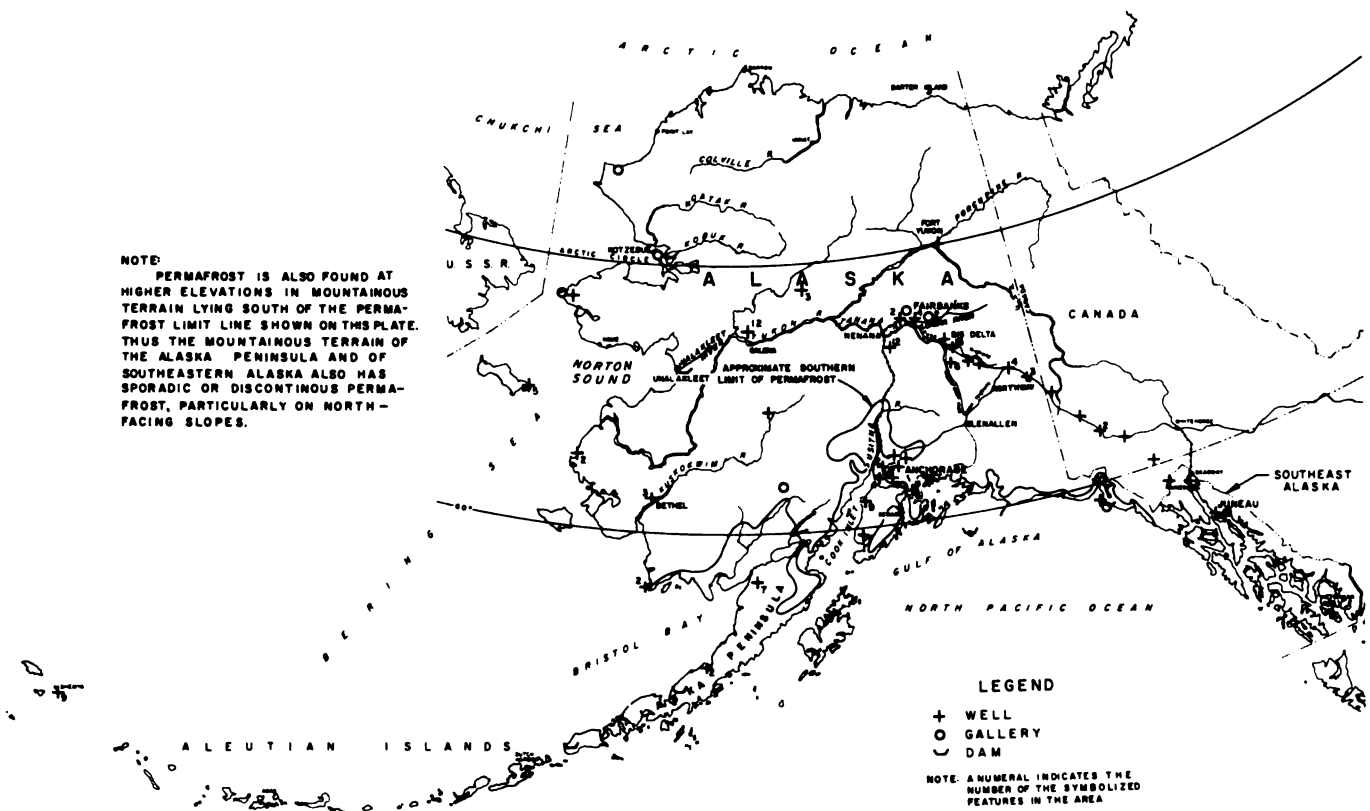

Fig. 2. Water supply points in Alaska

There were several reasons for these shallow wells. First, they were easily and cheaply constructed, and people had a false sense of security and lack of appreciation of the effectiveness of the limited gravel filtration. Secondly, knowledge of ground water supply at greater depth had not been developed. Anchorage is a young town, started as a railroad construction camp in 1915. Ground water geology exploration of the area was not undertaken to any extent until after World War II, where buildup of bases and civilian communities triggered some work.

During World War II, water was provided for the adjacent large military camp of Fort Richardson by piping it from a log dam and intake structure on Ship Creek above the Fort and city. This creek in general separates the city from the reservation. Since the Alaska Railroad headquarters community as well as the city of Anchorage were taking water from the lower reaches of this stream, an agreement was made to share the new water supply point with these groups. In 1947 the intake was improved by a modern dam and headworks structure. Because of the rapid buildup of pollution in the stream as the community grew, the city and the railroad very soon used this new intake.

Water treatment plants for several military bases and Anchorage have since been added to their respective systems, and the quality of water introduced into the mains is excellent. Runoff source is from snowmelt and rainfall in the higher altitudes of the protected watershed.

Prior to filtration for city water supply, only chlorination control at intake existed. This important treatment was carefully watched by the authorities, and no serious health problem occurred.

About 1948 or 1949, further drilling exploration on the military reservation was undertaken to investigate ground water sources for Fort Richardson. Several deeper and more protected water bearing aquifers were found at depths of about 150, 230, and 450 ft. Upon this discovery, outlying residents not yet serviced by the city's distribution system were encouraged to go to deeper wells. Many have done this,

resulting in a safer health situation. However, the entire area has so grown in population, with attendant concentration of septic-tank seepage, that some contamination at the 150 ft level through interconnecting gravel lenses is thought to have occurred (Fig. 3). Much further work is needed to establish aquifer profiles and determine their potentials. Wells close to the shoreline to a datum below mean sea level of 115 ft have encountered saline water; however, deeper wells farther

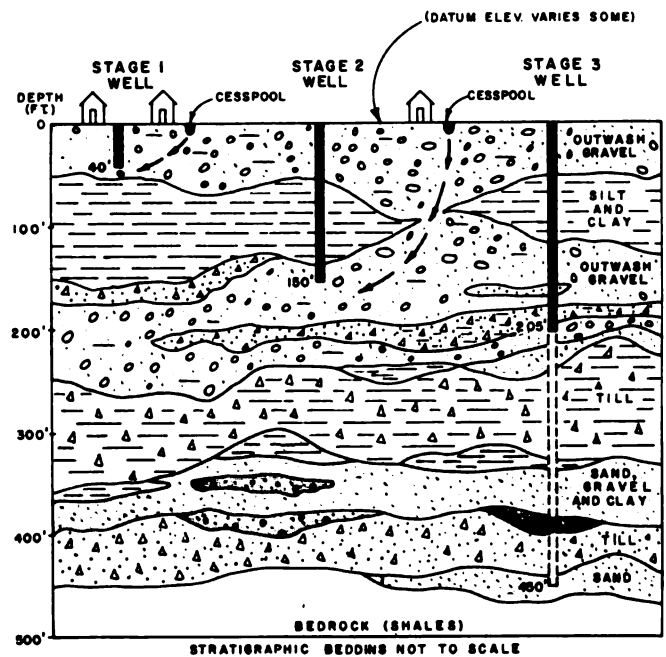

Fig. 3. Well development, Anchorage area (vertical scale, 0.5 in. = 1 ft)

inland have been successful water producers.

Water distribution systems for Fort Richardson and Elmendorf Air Force Base are designed and installed for direct burial at a 9 ft minimum depth. Seasonal frost is deep in this open gravel formation; penetration to depths of 12 to 14 ft where snow cover has been removed is not uncommon. Fig. 2 shows, however, that at least all lowland areas here are free from permafrost. Bypass arrangements are used in fire hydrants to keep dead-end stubs from freezing. Even so, at times in winter the intake water temperatures at the dam are so super-cooled that water heating is necessary. This is done with waste heat from the steam powerplant closed condenser systems. Thus several degrees of heat can be added to the system as required, and freezups eliminated.

Military bases collect their sewage through standard direct-burial collection systems and discharge the effluent through outfalls into the nearby tidal waters of Cook Inlet.

Anchorage now also has an extensive, but not yet complete, collection system. City ordinances provide that these services must be tapped. The city has also a battery of seven or more main sewers connected to a collector system which, in turn, connects to the main outfall carrying sewage out over the tidal flat into the bay below mean low water. Eventually this effluent will need treatment before disposal into tidal waters.

Coastal cities of the Panhandle (Southeastern Alaska) are located in an area of above average precipitation. The country is generally mountainous and dissected with many beautiful bays and fjords (Fig. 2). Its relatively mild climate is comparable to the coastal regions of Washington and Oregon. Water supply is, therefore, abundant from the many mountain streams and lakes. These sources are tapped at a relatively high elevation behind the towns in question and the water piped into distribution systems serving the community. Usually only chlorination treatment is required, as the water is generally of high quality. Permafrost, existing here only at high elevations, is therefore not an influence.

Sewer systems of these towns now generally dump their effluent into the many fjords and bays or the lower reaches of watercourses. Contamination is not a problem now, but treatment will be necessary as the communities grow.

In the large and important Tanana Valley, an early gold dredging operation (Fairbanks Exploration Co.) found water bearing gravels below and between the shallow permafrost in the area. This knowledge has been used by Fairbanks, the nearby military bases of Fort Wainwright (formerly Ladd Air Force Base), Eielson Air Force Base, and the Air Force Base of Clear near Nenana. Water for these installations is pumped from prepacked as well as natural gravel packed wells (Fig. 4) through distribution systems to various technical facilities and housing units.

Many industrial wells constructed in the Tanana and Yukon

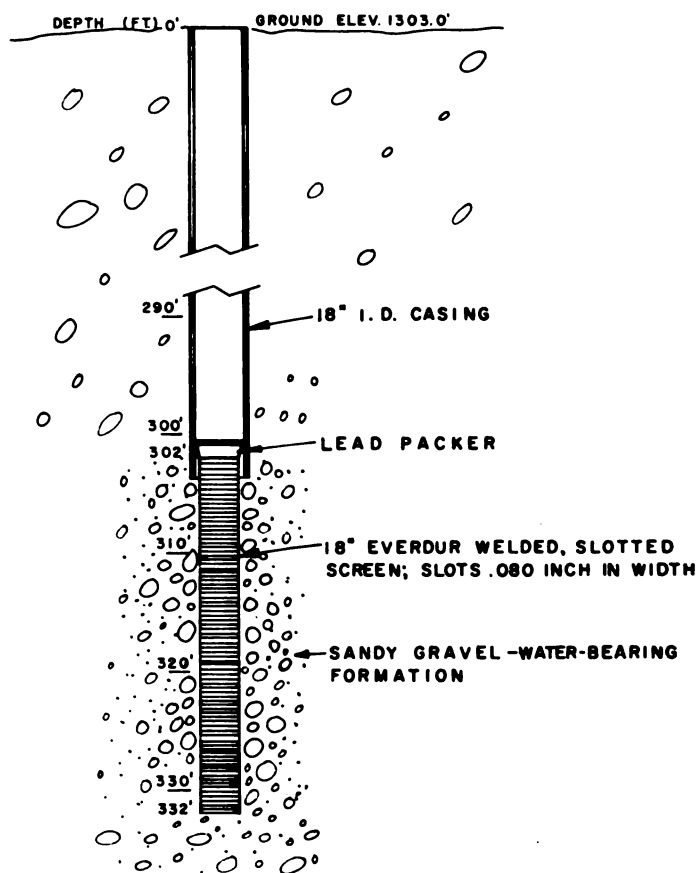

Fig. 4. Typical industrial well of natural gravel pack

alluviums penetrate permafrost from the bottom of seasonal frost to depths of from 80 to 300 ft. The aquifer gravels are found beneath the permafrost. Such wells will freeze in the permafrost zone unless continuously pumped or unless a continuous return of 1 to 2 gpm of 40°F water into the well is provided.

Some of the wells are sized for full fire fighting requirements. These wells are equipped with pressure-electrical responsive controls installed so that, on demand, high capacity auxiliary pumps supply full emergency requirements. All water pumped into the system is automatically chlorinated. Use of ground reservoirs made the expense of elevated water

Table I. Chemical analysis of selected well waters (ppm)^a

Location	pH ^b	Total ^c Solids	Total Iron ^d (Fe)	Silica (SiO ₂)	Sulfate (SO ₄)	Chloride (Cl)	Total Hardness	Carbonate Hardness
Bethel AFB	7.4	145	Trace	Trace	0	5	95	95
Clear AFB	7.6	195	0.3	12	38	5	168	127
Eielson AFB ^e	7.1	170	0.9	18	13	2	137	126
Elmendorf AFB-Anchorage	7.7	160	0.3	10	10	Trace	136	124
Fort Greely	7.4	165	Trace	12	39	3.9	130	115
Fort Richardson	7.7	106	0.2	6	11	1	115	102
Fort Wainwright-Fairbanks	7.2	286	2.0-6.0	4	15	2	140	105
Fort Yukon AFB	7.2		1.0	15	26	Trace	180	144
Galena AFB ^e	7.0	350	5.0-8.0	35	6	4	245	245
Glenallen ACS Sta RRS	7.5	292	0.3	Trace	Trace	4	218	218

^aTabular entries represent an average range for deep wells nearby. Data from Corps of Engineers, Alaska

^bLaboratory sample. Well sample with carbon dioxide gas still entrained is generally close to neutral or slightly acid

^cNitrate as NO₃: Clear, 3.2; Galena, 0.5; others not reported or zero

^dOrganic iron as Fe: Clear, 0.3; Elmendorf, trace; Fort Wainwright, 2.0; Galena, trace; Glenallen, trace; balance, none

^eManganese is found only as a trace

towers and other storage reservoirs unnecessary. In investigating and building these wells, aside from the usual techniques of surging and development of the natural gravel pack, drawdown tests were made and checked by pilot wells to fully establish supply capability. The system has worked very well.

Water-bearing gravels in this particular area contain considerable manganese and iron deposits (Table I), in which the microbe, *Chromatium*, thrives. Such water, if not treated, will cause discoloring to porcelain and be corrosive to iron pipes. The affinity of the microbe for this chemical environment is very great and not a fully understood phenomenon. Measures to eliminate the iron and manganese are necessary to avoid damaging walls of the pipes and destroying them by clogging deposits of iron oxide.

Domestic water is treated to remove most of the iron and manganese, and much of the resulting damage and nuisance have been eliminated. The treatment used was determined from the following considerations: Required domestic use that ranged from 3300 to 3900 gpm, the type of hardness, and the large quantity of iron and manganese, which in this case could be removed by aeration-flocculation and settling. These conditions indicated a conventional cold lime softening. The water is passed through a mechanical aeration chamber, through a reaction chamber where lime and alum are added, then into a flocculation chamber and settlement basin. It is recarbonated to stabilize the calcium carbonate content with the carbonate unit used to heat hot water for the lime slakes; then filtered through rapid sand filters, and chlorinated.

To prevent freezing of water supply and sewage and to simplify maintenance problems, considerable study and evaluation were made of different possibilities for building distribution systems for utility lines in these heavy seasonal frost and permafrost areas. The result was the development of a boxlike conduit, generally of concrete construction, known locally as a utilidor (Fig. 5). These utilidors carry water, sewers, steam mains and condensate returns, and sometimes other utilities to and from the various plants and building structures that they serve. Sufficient heat is transmitted to the box from the insulated steam lines to control freezing. These conduits are sometimes made of treated wood or corrugated pipe. They are generally buried (provided with removable covers) just under the ground surfaces for easy access and maintenance. They vary in size from walk- and crawl-through to a size just large enough to envelop the contained utilities. They are sometimes placed above ground. Much engineering thought goes into their design to care for

such features as lift stations for sewage, expansion sleeves, anchors, reduction, and other valving for the steam lines, pumps for condensate return, support arrangement, etc. They are now successfully used in such areas.

Septic tanks are generally used for sewage treatment in many small outlying military installations. The effluent is sometimes disposed of in leaching wells, sometimes by surface discharge, depending on terrain and ground conditions. Septic tanks were formerly provided with artificial heat to maintain optimum temperature for bacterial action. Experience has shown that sewage can be maintained at satisfactory temperatures against freezing with latent heat and, while less bacteria action takes place, increase of sludge storage compensates. Installations of moderate size such as those at Clear near Nenana, and Fort Greely near Big Delta, use Imhoff tanks satisfactorily. Sewage lagoons, still under study, are not in common use.

Large installations of Eielson Air Force Base and Fort Wainwright provide for primary treatment. After the usual removal of large floating objects, the sewage enters a grease removal unit, then a preparation unit with mechanical aerators, water sprays, and skimmer. A chemical feed pump is provided for alum to aid in flocculation when dilution affecting the sewage requires it. These chemicals are fed ahead of this flotation unit, allowing it to serve as a floc chamber. The sewage then goes through primary clarifiers, and the effluent is chlorinated before discharge to the natural drainage. Digesters of sufficient size are provided for sludge storage.

Fairbanks has a unique system for its utilities which, I believe, is discussed in another paper.

The water-bearing gravel aquifers tapped at Clear Air Force Base do not have the iron manganese problem. Neither does this problem exist in gravels supplying the wells at Fort Greely located near Big Delta. At both of these stations the quality of ground water is excellent (Table I). Water could be obtained from the Tanana River in all these areas but would require much treatment. The river is very silt laden.

High production wells at these locations were driven through varying depths of permafrost to water-bearing gravels below these formations. At Clear this depth is at 80 to 100 ft, while at Fort Greely the best aquifer is found at 250 to 350 ft. Several wells at Fort Greely have features of unusual interest. One of the developmental nuclear powerplants under study by the Corps was built and is in operation at this site. It supplies all the steam heat and most of the electrical requirements for this post. When the steam turbine is operating-condensing, much cooling water is required. This supply from a high capacity well, with water of 34° to 40° F, is put through the condenser and returned to ground water through a recharge well. The system has operated very well. Wells were spaced to prevent recirculation. Tests were made with dye compounds in the exploration phase of construction to check this possibility.

Another aspect of the nuclear plant dealing with water supply may be of interest. There is a certain amount of waste product from such a plant, which is slightly radioactive. This liquid is kept in tanks for periods of time to permit maximum radiological decay. This waste is then piped to a nearby stream and heavily diluted with the addition of ground water to a radiological background count as low as or lower than that of the water of the stream into which it is discharged at flood runoff time.

Although in the Kuskokwim Delta area water can always be obtained from the Kuskokwim River, the heavy silt conditions there made wells more successful. One of the wells (Tables I and II) at Bethel, was drilled 600 ft through permafrost to obtain good quality water from sands at that depth.

Another development was the tapping of a water-bearing fracture in a granite formation near Northway on the Alaska Highway to supply water for an important pump station on the oil products pipeline from Haines to Fairbanks (Fig. 6). A special sealing process was undertaken here to prevent contamination.

Further north in the Yukon Valley are military installations at Galena and Fort Yukon. Galena is supplied from a ground

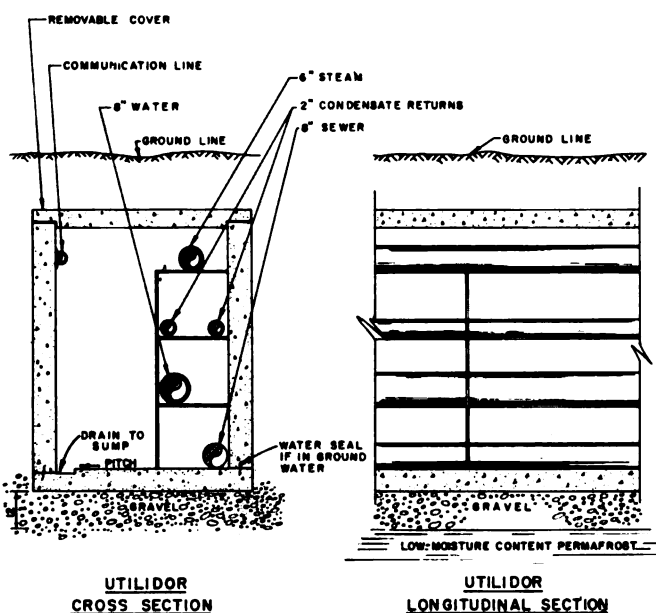

Fig. 5. Arctic and subarctic utilidor construction

Table II. Depth of industrial-type wells^a

Location	Av. Depth (ft)	Aquifer Formation
Bethel AFB	280-650	Alluvial or beach sands under permafrost
Clear AFB	80-120	Glacial gravels, very strong aquifer
Eielson AFB	80-130	River valley gravels, sometimes under permafrost; fairly strong aquifer
Elmendorf AFB Anchorage	180-460	Glacial sands and gravels
Fort Greely	250-350	Glacial gravels, strong aquifer
Fort Richardson	120-200	Glacial gravels
Fort Wainwright Fairbanks	80-120	River valley gravels, sometimes under permafrost; fairly strong aquifer
Fort Yukon AFB	20-30	Seepage well on river bank; permafrost is about 400 ft deep with silty sands beneath
Galena AFB	160-210	River valley gravels under permafrost
Glenallen ACS Sta RRS	180	Glacial sands and gravels under permafrost. Salt water below

^aData from Corps of Engineers, Alaska

water aquifer 200 ft under the permafrost. Here again, iron, manganese, and obnoxious gases are contaminants and must be treated (Tables I and II). Well water at this site is hard, and the amount used is not large. Water is passed through a degasifier which removes carbon dioxide, removes other gases, and oxidizes the ferrous iron to the insoluble ferric state. It is then passed through a bank of pressure filters that remove the iron and through a bank of sodium zeolite softeners to the storage tanks.

At Fort Yukon, a small Athabascan Indian community above the Arctic Circle located at the junction of the Porcupine and Yukon Rivers, there is another military installation. Water is supplied by wells drilled into thawed gravels adjacent to an old river channel. These wells are relatively shallow. Waste disposal from the military installation is by septic tank.

It is believed that the tapping of aquifers below permafrost would make possible the existence of deep wells, but to date no such wells have been established. Further exploration is necessary. An exploratory drill hole by the Corps at this station (60 ft below permafrost and 460 ft deep) did not reveal water. The Yukon River, of course, has winter flow beneath its ice mantle. The town gets its water from the school well which is similar in construction to the one described.

Water supply for airbase facilities near the Eskimo Village of Unalakleet on Norton Sound off the Bering Sea is supplied from a man-made lake formed by damming a very small stream, actively flowing only in summer. This reservoir is supplemented by a large heated storage tank at the site (Fig. 7). This dam, while small, is built on permafrost with an interesting partial permafrost core. Wells were explored and may still be possible but were given up, since this system is more certain and less costly.

It is possible that ground water from wells along the Unalakleet River could be developed. The Eskimo village gets its water from the river and from some very shallow wells in the river valley. Sewage disposal for this base is by septic tank. The town has no disposal system.

The town of Nome obtains most of its water from a spring by the romantic name of Moonlight. This is a year-round, ground water supply located about 3.5 miles from the town, with a seasonal flow of 300 gpm. The Snake and Nome Rivers

nearby also have flow under the ice mantle. In summer, water is piped to town from this spring and distributed by above-ground pipes to all paid-up customers. In winter, because of low temperatures and the unprotected nature of pipe, tank truck operations are necessary, and water is sold by container measure, posing severe use limitation. Sewage disposal, except for buildings facing the waterfront, is by tank truck.

An airbase near the Eskimo town of Kotzebue, also is above the Arctic Circle on Kotzebue Sound off the Chukchi Sea. This base is literally built on piles frozen into a permafrost formation containing large masses of ice. Development of this very successful technique by the Corps has been the subject of several papers and will not be discussed here. Water for this base is supplied by tapping a small creek which drains several small lakes and discharges into Kotzebue Sound. Sufficient flow is maintained to supply the base during summer months, but tank storage is necessary for winter needs. Waste disposal is carried by aboveground insulated septic tank and pipeline discharge into Kotzebue Sound.

For a proposed but abandoned development near the Navy's oil exploration camp at Umiat, the bank gravels of the Coville River (a sizeable stream nearby flowing northward from the foothills of the Brooks Range into the Arctic Ocean) were examined in winter during the exploration phase of this development. These gravels contained sufficient water to be considered as a most probable source of water. Extensive tests, however, were not made, as the project was not built.

Water to installations at Point Barrow and Barter Island on the Arctic Ocean is supplied summer and winter by tank truck from relatively shallow lakes. At Barrow and Barter Islands, a tank truck carries sewage to an open pit.

One section not yet discussed is the Aleutian Chain (Fig. 2). The Alaska Peninsula and the Aleutian Chain extend

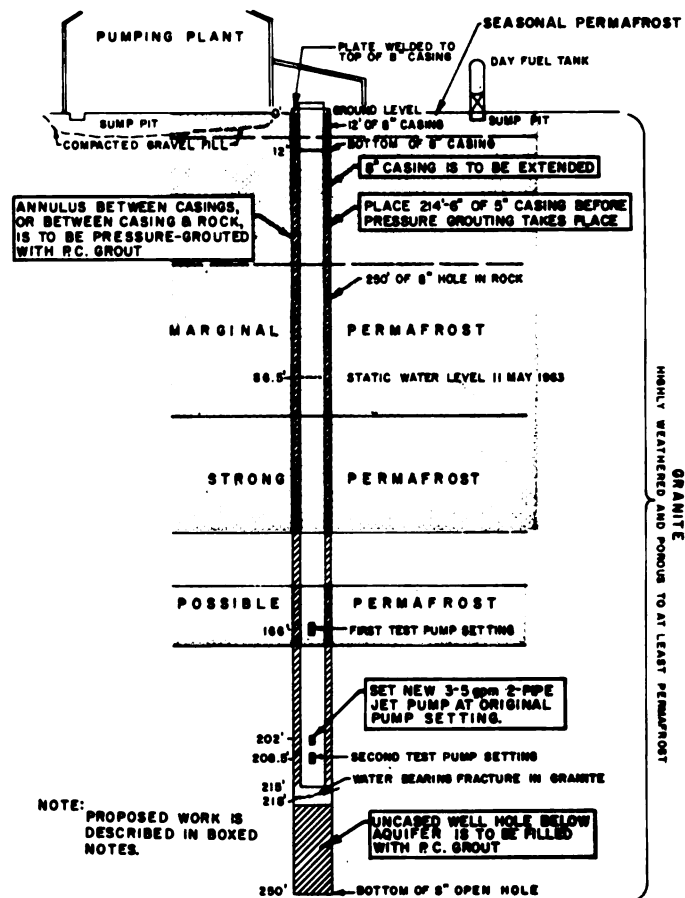

Fig. 6. Diagrammatic sketch of casing and cement (vertical scale, 1 in. = 30 ft)

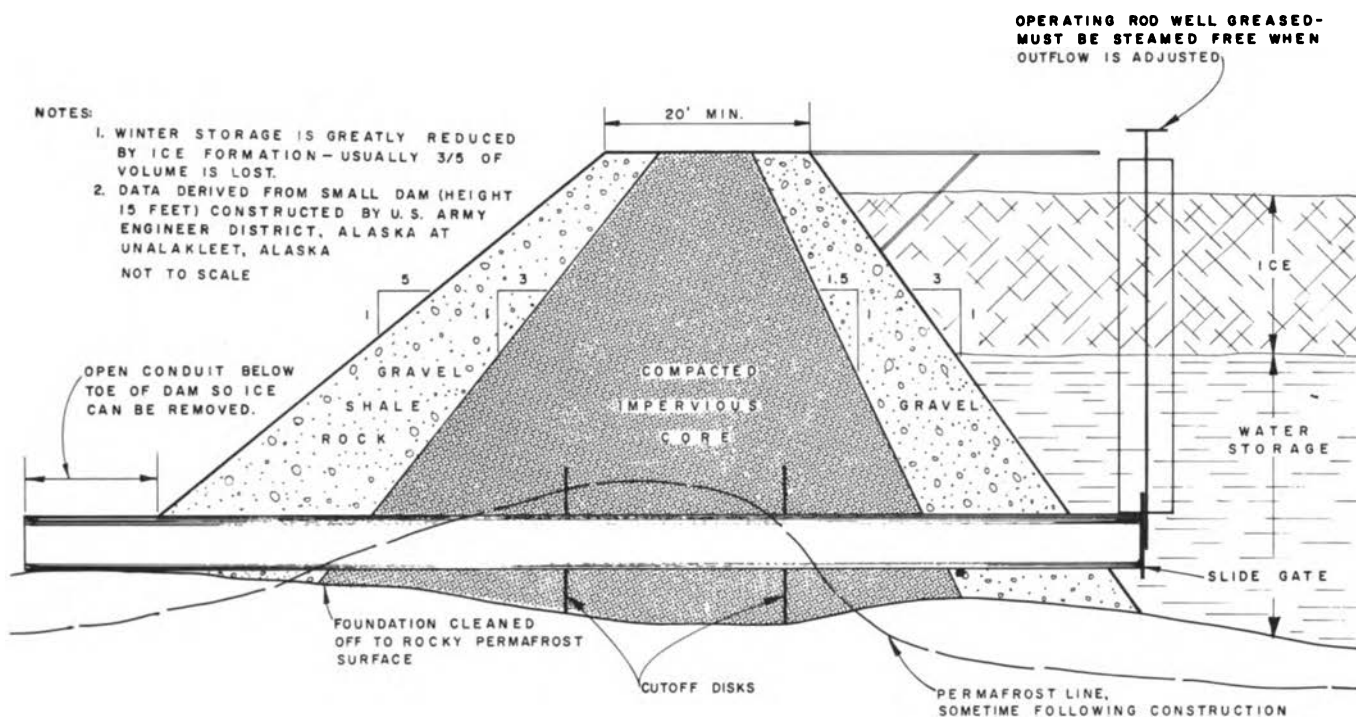

Fig. 7. Small water supply dam, permafrost location

some 1600 miles out into the Pacific Ocean. The area is thinly populated with villages generally close to military stations and fish canneries. Water for both is obtained from many streams and lakes, some man-made with earth dams. These are all supplied by heavy precipitation. Wells are used at Shemya. Permafrost exists only in relatively high mountain areas near the base of the Peninsula. Sewage disposal for military installations is generally carried through outfall pipes to tidal flats.

While this paper does not discuss the long-range planning given to water resources in our civil works river basin and survey programs, this subject has most careful consideration. River basins of all Alaska have been studied (Corps of Engineers 308 Study) with only one report yet to be published as Congressional Documents. The major planning studies now under way for the great Rampart Dam Project and the important Chena River Flood Protection Study, about completed, carefully

appraise future water supply and provide for maximum use and conservation of this vital resource.

ACKNOWLEDGMENTS

Material for this paper was developed from many design memorandums and unpublished exploration findings and investigations, reports, and design documents prepared by various staff groups of the Alaska District, U.S. Army Engineers, Corps of Engineers, Anchorage, Alaska. Acknowledgment is to the Alaska District Engineering staff for assistance in preparing this paper, particularly the figures and tables. All figures were prepared from data of U.S. Army District, Alaska.

Appreciation is also expressed for data supplied on native villages by the Environmental Sanitation Section of the Arctic Health Research Center, U.S. Department of Health, Education and Welfare, Anchorage, Alaska.

WATER SUPPLY SYSTEMS IN PERMAFROST AREAS

G. L. HUBBS, Arctic Health Research Center, Alaska

Adequate water supply is basic for the continued growth of any community. In permafrost areas the attendant difficulties in providing this supply are numerous and complicated. The main concern here is to find workable solutions for safe and plentiful water supplies that are economically feasible for both large and small communities.

BACKGROUND

The North American Arctic is still sparsely populated. In recent years a few population centers have mushroomed with a resultant demand for modern conveniences—among them adequate water distribution systems.

In Alaska most problems with existing systems result from misapplication of Temperate Zone methods. According to Zhukov [1] heating, sewage collection, and water distribution mains in permafrost regions affect the stability of buildings more than anything else. Because 60% of Alaska is underlain with permafrost and because of population growth potential, the need for discovering effective means of providing these systems becomes increasingly important.

WATER SOURCES

Surface sources provide most of the water used domestically. Despite a limited annual precipitation in some areas, varying from about 37 cm in Anchorage (lat. 61°) to 30 cm in Fairbanks (lat. 65°) and to 11 cm in Barrow (lat. 71°), few places actually experience water shortage. True, the high cost of collection, treatment, and distribution drastically curtails consumption; and water may exist as ice and snow during half the year.

Many small communities still use primitive methods of water handling. During summer, water is hauled in buckets; during winter, ice and snow are carried on sleds, or water is dipped from holes cut through ice. Chlorination is widely used, but boiling is the most common method of disinfection.

In recent years wells have been dug and drilled in Arctic communities with varying success. Grainge [2] reports a number of wells in northern Canada that tap water sources through permafrost. Continuous pumping or electric heating cables are required to keep these wells from freezing. In Alaska, the Bureau of Indian Affairs (BIA) is conducting a well-drilling program for BIA schools in native villages. The BIA is also drilling community wells in many of the same villages with funds provided by the U. S. Public Health Service (PHS). This is part of a general sanitation improvement program to elevate health standards of aboriginal groups throughout the United States. Where wells are drilled through permafrost, freezing problems arise. The magnitude of the problem depends on the quantity of water pumped, the temperature of both the water and the soil surrounding the casing, and the time between pumping operations.

Several methods for thawing frozen wells have been used with varying degrees of success. Steam, hot water, and even cool water have been introduced into the top of the casing by a flexible hose which is lowered as the ice melts. The overflow is usually wasted but may be trapped and reheated. Electrical heating elements have been lowered into the ice to melt it. Brine has been tried often.

One of the most successful methods employs an insulated double-conductor cable with its lower ends joined together and sealed. Its upper ends are connected to a low-voltage transformer. The cable is placed between the drop pipe and the casing and extends below the permafrost zone. Wire size and voltage output are selected to provide about 1 w/ft of wire. One well so equipped [3] was left unused for over a year. Within only a few hours of applying electrical energy to the

drop wire, the pump was started and water was obtained.

TREATMENT

Extensive chemical analyses of surface and ground waters in Alaska have been made by the U. S. Geological Survey (USGS) [4] and the Arctic Health Research Center (AHRC) [5]. An AHRC study of waters used in 81 Alaskan villages reveals that the waters are generally of good to excellent chemical quality except for iron and color. As expected, ground water is more highly mineralized than surface water. Among the villages tested, extensive use of ground water was found only in the Tanana River area. Waters in coastal areas have a higher mineral content and more problems of color and iron than those of interior areas. About one-third of the waters in both areas show excessive color. Nearly two-thirds of the villages in coastal regions and about one-fourth of the villages in the interior have excessive iron with some ground waters having over 100 mg/liter. Very few have total solids above 500 mg/liter and only one has excessive fluorides.

Experiments conducted by the AHRC on highly mineralized ground water from a village in Western Alaska indicate that such waters are amenable to iron-removal treatment by the fill-and-draw method using soda ash and superchlorination. Agitation and mixing are done with compressed air and a diffusor stone. By this method iron is reduced from over 100 to about 1 mg/liter. Other methods of iron removal are being investigated.

Chlorination is now practiced widely. Larger villages use chlorine gas; smaller ones use chlorine in the form of hypochlorite. Some larger cities have installed conventional treatment plants in heated buildings. The plants in general use chemical flocculation for removing turbidity, followed by rapid sand filtration and chlorination. The U. S. PHS hospital in one town north of the Arctic Circle uses a vapor-compression distillation unit to treat sea water at about \$7 per thousand gallons. This water is far superior to the creek water containing over 70 units of color which is sold by a local purveyor for about \$40 per thousand gallons.

Most waters in northern areas, with their extreme low temperature, require more chemicals and longer treatment time. Consumption rates, on the other hand, are considerably less.

DISTRIBUTION

Methods of distributing potable water range from primitive hand carrying to highly sophisticated pipe systems. Ice and snow are still frequently hauled during winter and melted on the cookstove with obvious danger of contamination. Some small villages use a summer water distribution point consisting of several converted 55 gal drums from which people haul their own water. The drums are usually filled intermittently by small gasoline-engine driven pumps. For winter operation, a few villages hand carry their water from a centrally heated water supply building. Where such central supplies are used, chlorination and iron removal can be accomplished.

For year-round operation a few institutions and villages use pipeline laid on a continuous grade from a surface water source to storage tanks located inside various buildings. Pumping can usually be done at temperatures above about -10°C. After the tank is filled the pipe is drained to prevent freezing. Since most northern areas have warm periods even in midwinter, this system has much to offer where adequate storage can be provided. If pipe of low heat conductivity is used, little trouble results. Exposed metal connectors between pipe lengths, however, are a source of ice plugging and must be insulated.

In larger villages and towns, where finances permit,

continuously operating distribution systems are used. The AHRC has noted temperatures of -9°C more than 2 m deep in the soil beneath some of the streets of Fairbanks. Seasonal frost depths greater than 4 m exist nearby. In permafrost areas it is futile to attempt to place a conventional distribution system below the seasonal frostline since in many sections the seasonal frost and the permafrost meet, leaving an unbroken layer of frozen soil from the surface to great depths. There are two alternatives: Either the distribution system must be heated somehow, or the water must be removed from the system before it freezes.

Three devices used in preventing freezing in a distribution system are the utilidor, the steam tracer, and the electric heat tape. The utilidor is a heated passageway built either below grade or supported on posts above grade. The latter has the advantage of not disturbing the permafrost equilibrium. A utilidor usually contains all utility services that in non-permafrost areas are generally buried. This method keeps temperatures around the mains above freezing, but construction costs are so high that the average community finds utilidors uneconomical.

Steam tracer systems, as well as electric heat tapes, are suitable for smaller installations. Here again, however, the cost of producing steam, the attendant problems of collecting the condensate, and the cost of electrical energy make such systems impractical for a community of any size. For very small communities having no steam and only intermittent electric power, such methods are impossible.

There are also three methods generally used for removing residual water from a distribution system before it freezes. The first method involves intermittent pumping, previously mentioned. Either the pipes are disconnected and allowed to drain, or compressed air is introduced to force the water downgrade and, in the case of a supply line, to hold it below the ice level of the water source [6]. The latter method is particularly adaptable to the intake line of a pumping station. Fig. 1 illustrates a mechanical version of this method for a small installation. The pumping cycle in Fig. 1 consists of an open supply line valve and a closed pressure regulator valve. The holding cycle consists of a closed supply line valve and a pressure regulator that is adjusted to hold the air-water interface below the ice at a depth indicated by a gage. A more sophisticated operation is possible by using relays and solenoid operated valves; such a system is in operation at Barrow, Alaska.

The second and third methods for removing water depend on constant circulation of the water. The first of these methods (Fig. 2) is a dual-main recirculating system [7]. This construction uses both high pressure and low pressure mains laid in the same trench. Heated water from the treatment plant or pumping station is forced out through the high pressure main and returns through the low pressure main for reheating and the addition of makeup water. House services are built in

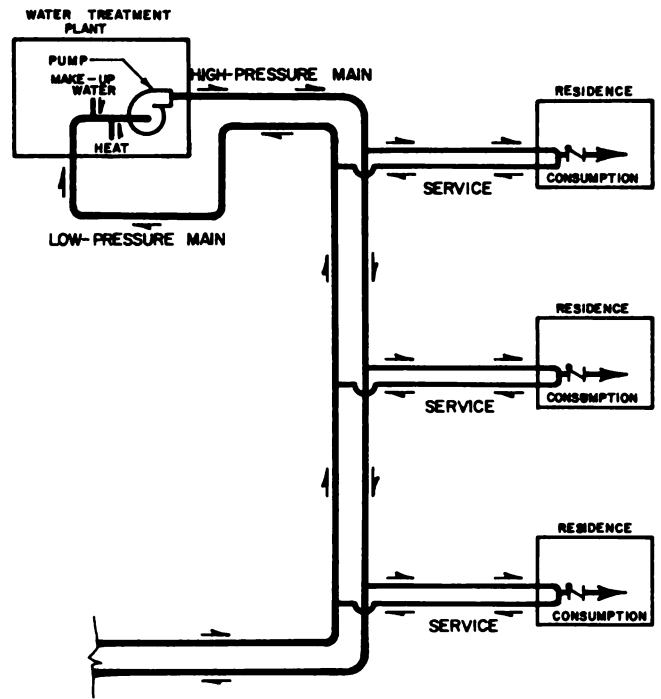
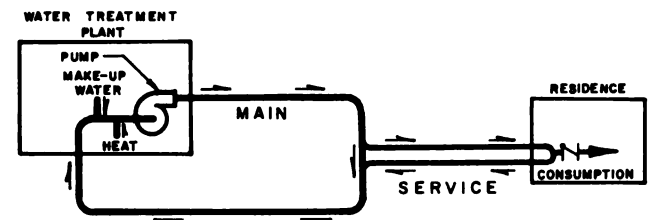
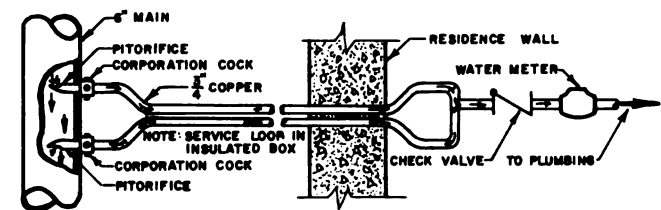

Fig. 2. Dual-main recirculating water system



DISTRIBUTION SYSTEM



SERVICE CONNECTION

Fig. 3. Single-main recirculating water system

the form of a loop, one end of which is attached to the high pressure main and the other to the low pressure main. The house plumbing itself is connected to the midpoint of the loop where a check valve minimizes, although it does not guarantee against, the possibility of a cross connection. Thus water flows continuously through the house service regardless of use within the house.

The other circulating method is the single-main recirculating system and uses only one high pressure main (Fig. 3). As in the dual-main system the house service is laid in the form of a loop, but water is forced through the service line because of a velocity head in the main. Special fittings, permitting

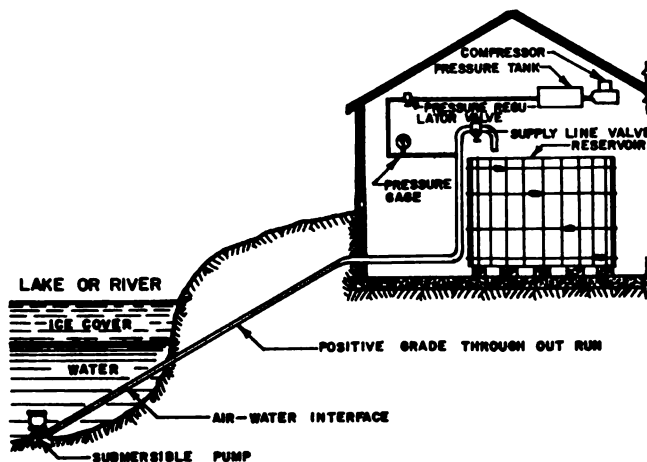

Fig. 1. Air-lock water pump supply for intermittent operation

use of the velocity head, were developed by engineers at AHRC and a consulting firm (R. W. Beck and Associates, Seattle, Washington) [8, 9]. The city of Fairbanks uses this method, which in its initial phase saved the city about \$900,000 over the cost of building a dual-main system. Because pumping costs are high, recirculation is used only during those months when house service lines are likely to freeze.

Experiments conducted by the AHRC with a service loop, using 100 ft of 0.75 in. copper pipe, disproved the theory that heat of fusion could be used to permit supercooling of the buried service line without freezing. Sufficient heat must be provided to offset heat loss to the ground; a velocity of somewhat less than 0.2 ft/sec in water only a few degrees above freezing is sufficient in Fairbanks. This condition occurs when the velocity in the main is about 3 ft/sec.

SUMMARY AND CONCLUSION

Technical problems relating to operation of utilities are being solved in Arctic environments, but many answers have not yet been found.

Cold winters, permafrost, and transportation difficulties result in costly utility services. Expanded research is needed to provide safe and economical water supplies for growing communities in northern regions.

REFERENCES

- [1] V. F. Zhukov. "Installation of Sanitary Engineering Utilities in Permafrost Regions," Trans. V. A. Institute of Frostology, Vol. 14, Acad. Sci. USSR, 1958, pp. 96-103.
- [2] J. W. Grainge. "Water Supplies in the Central and Western Canadian North," J. Am. Water Works Assn., Vol. 51, No. 1, Jan. 1959, pp. 55-66.
- [3] E. M. Lamphere. "Study of Well Construction and Operations in Permafrost Areas," 1954, priv. comm.
- [4] Quantity and Quality of Surface Waters of Alaska, U.S. Geol. Surv. Water Supply Papers - 1466 (1950-53), 1486 (1953-56), 1500 (1957), 1570 (1958), 1640 (1959), 1720 (1960).
- [5] G. M. Arnow, G. L. Hubbs. "Characteristics of Surface and Ground Waters in Selected Villages of Alaska," Parts 1 and 2, Arctic Health Res. Center Rept., 1962.
- [6] J. A. Anderegg, G. L. Hubbs, E. R. Eaton. "Ice-free Intermittent Pumping of Surface Water Supplies," Sci. in Alaska: Proc. 10th Alaskan Sci. Conf., 1959, abs.
- [7] S. S. Copp, C. B. Crawford, J. W. Grainge. "Protection of Utilities Against Permafrost in Northern Canada," J. Am. Water Works Assn., Vol. 48, No. 9, Sept. 1956, pp. 1155-1168.
- [8] W. B. Page. "Design of Water Distribution Systems for Service in Arctic Regions; Experimental Study of New Dual-main House Service Connection," Water and Sewage Works, Vol. 101, No. 8, Aug. 1954, pp. 333-337.
- [9] H. C. Westfall. "Battling Permafrost, Subarctic Weather and Tough Soil to Give Fairbanks Water," Water Works Eng., Vol. 111, No. 2, Feb. 1958, pp. 128-131, 154-155.

READING GUIDE

Alaska Dept. Health, Div. Sanitation and Eng. Private Premise Water Supply Systems - Drilled Wells, Document HSE-6-6.

Alaska Dept. Health, Div. Sanitation and Eng. Private Premise Water Supply Systems - Driven Wells, ibid., 6-5.

Alaska Dept. Health, Div. Sanitation and Eng. Private Premise Water Supply Systems - Dug Wells, ibid., 6-4.

Alaska Dept. Health, Div. Sanitation and Eng. Private Premise Water Supply Systems - Springs, ibid., 6-2.

Alaska Dept. Health, Div. Sanitation and Eng. Willing Water Describes Cistern Water Supplies, ibid., 6-3.

A. J. Alter. "A Guide to Arctic Water Works Thermology," Consulting Engr., Vol. 9, No. 4, 1957, pp. 84-88.

A. J. Alter. "Alaska Water Pollution Control Investigations," Sci. in Alaska: Proc. 3rd Alaskan Sci. Conf., 1952, pp. 19-20, abs.

A. J. Alter. Arctic Sanitary Engineering, Federal Housing Administration, Washington, D.C., 1950.

A. J. Alter. "Low-temperature Problems in Alaska," J. Am. Water Works Assn., Vol. 47, No. 8, 1955, pp. 763-767.

A. J. Alter. "Relationships of Permafrost to Environmental Sanitation," Selected Papers: Alaskan Sci. Conf., ed. H. B. Collins, 1952, pp. 240-253.

A. J. Alter. "Water Supply in Alaska," J. Am. Water Works Assn., Vol. 42, No. 6, 1950, pp. 519-532.

A. J. Alter. "Water Supply Problems of the Arctic," Alaska's Health, Vol. 7, No. 3, 1949, pp. 1-3.

A. J. Alter. "Water Supply Problems in Low Temperature Areas," Selected Papers: Alaskan Sci. Conf., ed. H. B. Collins, 1952, pp. 219-240.

T. K. Anderson. "Maintaining Water Supply Lines at Zero Temperature," Water and Sewage Works, Vol. 106, No. 5, 1959.

Arctic Eng.: Tech. Publications Dept. Navy, Bureau of Yards and Docks, U.S. Office of Naval Operations, Washington, D.C., 1955.

Arctic Health Res. Center. Polar Record, Vol. 7, No. 47, Anchorage, 1954, pp. 70-72.

D. J. Baumgartner. "Water Supply and Waste Disposal Problems at Remote Air Force Sites in Alaska," Sci. in Alaska: Proc. 11th Alaskan Sci. Conf., 1960, abs.

K. D. Bielman. "Water Demands in Southeastern Alaska," ibid., pp. 39-50.

C. H. Billings. "Protecting Underground Utilities Located in Arctic Regions," Water and Sewage Works, Vol. 100, No. 11, 1953, pp. 441-447.

W. L. Boyd, J. W. Boyd. "Water Supply Problems at Point Barrow," J. Am. Water Works Assn., Vol. 51, No. 7, 1959, pp. 890-896.

W. L. Boyd. "Limnology of Selected Arctic Lakes in Relation to Water Supply Problems," Ecology, Vol. 40, No. 1, 1959, pp. 49-54.

D. J. Cederstrom, P. M. Johnston, S. Subitzky. Occurrence and Development of Ground Water in Permafrost Regions, U.S. Geol. Surv. Circular 275, Washington, D.C., 1953.

D. J. Cederstrom. Summary of Ground Water Development in Alaska, 1950, U.S. Geol. Surv. Circular 169, Washington, D.C., 1952.

M. J. Chernyshoff. "Water Services in Regions with Perpetually Frozen Ground," J. Am. Water Works Assn., Vol. 22, No. 7, 1930, pp. 899-911.

L. K. Clark, A. J. Alter. "Water Supply in Arctic Areas: Design Features," Am. Soc. Civil Engrs., Sanitary Eng. J., SA2 (Paper 931), Vol. 82, 1956.

L. K. Clark. "Some Aspects of Sanitation and Water Supply in the Arctic," U.S. Naval Civil Eng. Res. and Evaluation Laboratory: Rept. Symp. Advanced Base Water Supply and Sanitation, Oct. 1953, Port Hueneme, Calif., 1954.

S. S. Copp, C. B. Crawford, J. W. Grainge. "Protection of Utilities Against Permafrost in Northern Canada," J. Am. Water Works Assn., Vol. 48, No. 9, 1956, pp. 1155-1168.

S. S. Copp. "Two Water Supply Systems of Northwestern Canada," Sci. in Alaska: Proc. 3rd Alaskan Sci. Conf., 1952, abs.

R. L. Crow. "Cold Weather Public Works," Civil Eng., Vol. 29, No. 9, 1959.

- E. K. Day. "Environmental Sanitation Problems in Alaska and Their Solution," Harvard Public Health Alumni Bull., Vol. 9, No. 1, 1952, pp. 3-8.
- "Design of Intake Structures for an Arctic Water Supply," Am. Concrete Inst. J., Vol. 22, 1950.
- H. B. Dickens. "Water Supply and Sewage Disposal in Permafrost Areas of Northern Canada," Polar Record, Vol. 9, No. 62, 1959, pp. 421-432.
- The Dynamic North, OP-O3A3, U. S. Office of Naval Operations, Washington, D. C., 1956.
- B. M. Ellis. "A Water Distribution System for the Town of Thompson," Canadian Municipal Utilities, 1962.
- W. S. Foster. "Anchorage, Alaska: a City on the Move," Am. City, Vol. 69, No. 12, 1954, pp. 80-83.
- "Fairbanks, Alaska: a Subarctic City Moves Forward," ibid., No. 11, 1954, pp. 81-83.
- H. J. Fournelle. "Determining Potability of Water Supplies in the Field," U. S. Armed Forces Medical J., Vol. 8, No. 5, 1957, pp. 713-717.
- H. J. Fournelle, E. K. Day, W. B. Page. "Experimental Ground Water Pollution at Anchorage, Alaska," Public Health Rept., U. S. Public Health Service, Vol. 72, No. 3, 1957, pp. 203-209.
- A. H. Freeberg, D. E. Morey, R. J. Stanton. "Water Quality and Purification at Ketchikan Pulp Co.," Sci. in Alaska: Proc. 9th Alaskan Sci. Conf., 1958, abs.
- F. W. Galbraith. "The Distribution of Utilities in Arctic Advanced Bases," Military Engr., 1950, pp. 42, 121-122.
- J. W. Grainge. "Water and Sewer Facilities in Permafrost Regions," Municipal Utilities Magazine, Vol. 96, No. 10, 1958, pp. 29, 62-67.
- J. W. Grainge. "Water Supplies in the Central and Western Canadian North," J. Am. Water Works Assn., Vol. 51, No. 1, 1959, pp. 55-66.
- A. R. Gruehr. "Electric Heating Prevents Freezing of Exposed Waterline," Eng. News Record, Vol. 135, 1945.
- G. W. Grupp. "Man and Materials in the Polar Regions," U. S. Naval Inst. Proc., Vol. 75, No. 8, 1949, pp. 864-871.
- W. A. Hardenberg. "Arctic Sanitation," Am. J. Public Health, Vol. 39, 1949, pp. 202-204.
- Hostrup, Lyons, and Associates. Study of the Mechanical Engineering Features of Polar Water Supply, (prepared for U. S. Naval Civil Eng. Res. and Evaluation Laboratory, Port Hueneme, Calif.), Los Angeles, 1953.
- "How Good is Your Frost Protection?" Water Works Eng., Vol. 93, 1940, pp. 114-118.
- G. L. Hubbs. Water Supply and Waste Disposal in Northern Canada and Alaska (unpubl. paper presented at World Health Organization Conf. Medicine and Public Health in the Arctic and Antarctic), Geneva, Aug. 28-Sept. 1, 1962.
- W. L. Hyland, G. M. Reece. "Water Supplies for Army Bases in Alaska," New England Water Works J., Vol. 65, No. 1, 1951, pp. 1-16.
- C. L. Johannessen. "Anti-freezing Hoods for V-notch Weirs," J. Forestry, Vol. 55, 1953.
- M. Lantis. "Traditional Home Doctoring and Sanitation, Lower Kuskokwim Valley, Nelson and Nunivak Islands," Sci. in Alaska: Proc. 9th Alaskan Sci. Conf., 1958, pp. 132-150.
- E. W. Lingel. "How Chlorination Helps Water Conditioning at Alaskan Bases," Public Works, Vol. 89, No. 8, 1958, pp. 119-120.
- "Long Hard Winter Takes Toll of Alaska's Water Systems," Alaska's Health, Vol. 8, Nos. 3, 4, 1950.
- Low Temperature Sanitation, U. S. Office of Naval Operations, Washington, D. C., 1954.
- M. E. McConnell. "W. E. Engineering for the DEW Line," Vol. 5; "Water and Waste Systems," Western Electric Engr., Vol. 11, No. 3, pp. 35-37.
- M. Mitchell. "A Continued Search for Small Water Supplies in Alaska," Sci. in Alaska: Proc. 9th Alaskan Sci. Conf., 1958, abs.
- M. Mitchell. "Water Supply Management for Alaska," Sci. in Alaska: Proc. 11th Alaskan Sci. Conf., 1960, abs.
- M. R. C. Mitchell. "Water and Sewage at Sherridon, Man.," Public Works, Vol. 79, No. 8, 1948, pp. 22-24.
- E. W. Moore. A Summary of Available Data on Quality of Arctic Waters, Natl. Res. Coun., Committee on Sanitary Eng. and Environment, Div. Medical Sci., 1949.
- W. R. Nehlsen. "Use of Sea Water for Water Supply and Waste Disposal in Arctic Coastal Areas," Sci. in Alaska: Proc. 11th Alaskan Sci. Conf., 1960, pp. 52-53, abs.
- F. Nyman. "Anchorage Cuts Freezeups 85%," Pacific Builder and Engr., 1957, pp. 112-114.
- F. Nyman. "Experiences in Design and Operation of Water Wells for Anchorage, Alaska," Sci. in Alaska: Proc. 8th Alaskan Sci. Conf., 1957, pp. 72-73, abs.
- W. B. Page. "Arctic Sewer and Soil Temperatures," Water and Sewage Works, Vol. 102, No. 8, 1955, pp. 304-308.
- W. B. Page. "Arctic Water Supply: It Must Circulate or Freeze," Eng. News Record, Vol. 4, Feb. 1954, pp. 30-31.
- W. B. Page. "Design of Water Distribution Systems for Arctic Regions," Sci. in Alaska: Proc. 3rd Alaskan Sci. Conf., 1952, pp. 56-61.
- W. B. Page. "Design of Water Distribution Systems for Service in Arctic Regions. Experimental Study of the New Dual-main House Service Connection," Water and Sewage Works, Vol. 101, No. 8, 1954, pp. 333-337.
- I. M. Reed. "How Dawson Keeps Its Water Mains from Freezing," Pacific Builder, Vol. 49, 1943.
- M. A. Roche. "Waterworks and Sewerage in the Far North," Public Works, Vol. 79, No. 8, 1948, pp. 21-22, 24.
- H. G. Rogers. "Investigation of Sanitary Features of Utilidor Construction and Substitutes Therefor in Arctic Installations: Rept. to the Subcommittee on Waste Disposal," Natl. Res. Coun., Committee on Sanitary Eng. and Environment Bulletin, 1949, pp. 111-115.
- F. Shepperd. "Thawing Water Pipes Electrically," Water Works Eng., Vol. 87, No. 11, 1934.
- C. R. Silversides. "Winter Maintenance of Camp Water Supply," Pulp and Paper Magazine, Vol. 55, 1954, pp. 253-260.
- M. I. Sumgin, N. N. Geniev, A. M. Chekotillo. Water Supply of Railroads in Permafrost Regions, Wilmette, Ill., SIPRE, Oct. 1955.
- J. F. J. Thomas. Water Quality for Some Canadian Military Establishments, 1956-1957, Can. Dept. Mines and Tech. Surv., Mines Branch 865, Water Surv. Rept. 12, Ottawa, Queen's Printer, 1959.
- R. F. Thompson. "Water Treatment - Ladd Air Force Base," Sci. in Alaska: Proc. 11th Alaskan Sci. Conf., 1952, abs.
- "Water Supply Systems in the Frigid North," Compressed Air Magazine, Vol. 59, No. 10, 1954.
- H. C. Westfall. "Battling Permafrost, Subarctic Weather and Tough Soil to Give Fairbanks Water," Water Works Eng., Vol. 111, No. 2, 1958, pp. 128-131, 154-155.
- H. C. Westfall. "Research and Design of a Single-main Recirculating System," Sci. in Alaska: Proc. 4th Alaskan Sci. Conf., 1953, pp. 48-53.

WATER SUPPLY SYSTEMS IN FROZEN GROUND

LARS-ERIC JANSON, Consulting Engineer, Stockholm, Sweden

Consideration must be given to several factors when determining an underground layout depth for water pipelines and sewers. In northern Sweden, the zero-isotherm or frost-free depth, is in most cases the only determining factor.

In these areas, the frost depth is very uncertain, and, to a large extent, extremely sensitive to variations in the mean annual temperature, especially in snow-cleared ground. As stated in an earlier publication [1], a succession of years with cold winters, and with cool summers and autumns, or little precipitation, may result in an obvious lowering of the mean annual temperature of the ground to 0°C or below. This implies that the frost depth may, at a certain critical mean annual temperature in the ground, suddenly go much deeper than normal.

Mean temperature variations in these areas make it difficult to establish a frost depth which will be decisive in choosing a laying depth for water pipelines. A 2.4 to 2.6 m laying depth has been adopted for the present; it corresponds to the frost depth of most cold winters. Because frost depth may be considerably greater, freezing in pipelines will be fairly frequent. This is confirmed by the fact that every year large sums are spent on repair and thawing of frozen water pipelines and sewers.

LAYING DEPTH AND FROST DEPTH

Using a laying depth greater than that cited above would be both uneconomical and impractical, since completely frost-free ground does not occur until a depth of 4 to 5 m has been reached. It may then be more advisable to fit pipes with artificial heating devices when they are placed in the ground, since thaw-incurred expense is likely in any case. This would also permit reduction of the current laying depth.

An account follows of tests made using electric heating cables placed along pipes to compensate for heat losses which otherwise might cause ice formation within the pipe. In addition, the possibility of reducing laying depth by backfilling with a highly frost-resistant material (in this case, water-retaining peat) also has been examined.

Investigations were carried out at a small plant at Nattavara (lat. 66°46'N, 325 m above sea level) during the winters 1960-1961 and 1961-1962, as well as at a research station at Gällivare (lat. 67°10'N, 415 m above sea level; mean annual air temperature -0.7°C), during the winter 1961-1962. Additional tests were conducted during the winter 1962-1963.

HEAT LOSSES FROM BURIED PIPELINES

In determining the laying depth it was assumed that pipelines would, at times, lie above the frost limit, i.e., in frozen ground. Then, the quantity of heat supplied to the pipeline to prevent water freezing in the pipes (other conditions being constant) would be a function of the laying depth. Heat loss from water in pipes is proportional to the temperature difference between inside and outside pipe walls. The smaller the laying depth, the lower will be the ground temperature at the conduit level in winter, and consequently, the greater the heat loss from the pipeline.

Heat loss (q_1) from a linear, circular heat source of radius (r), at depth (h) below ground level may be calculated from

$$q_1 = (\vartheta_u - \vartheta_o) \frac{2\pi\lambda}{\ln \left[\frac{h}{r} + \sqrt{\left(\frac{h}{r}\right)^2 - 1} \right]} \quad (1)$$

where λ is thermal conductivity of the soil, ϑ_u is temperature of the outside pipe wall, and ϑ_o is temperature of the ground surface (assumed to be constant). Equation (1) applies when the temperature at the initial moment is ϑ_o in the soil and

along the ground surface. Thus, the expression only approximates actual conditions. A more comprehensive solution, which is also valid when heat loss takes place from ground surface to air of constant temperature, has been presented elsewhere [2]. However, for high values of the ratio h/r , as in this case, (1) will give sufficient accuracy.

If a temperature gradient occurs in the ground, the superposition principle is adopted for pipeline and ground, each representing a separate heat generating system. If the heat flow in the ground is regarded as stationary, the expression ϑ_o in (1) should be replaced by the ground temperature (ϑ_x) at the level of the pipeline, which is the case when there is no heat loss from the pipe.

If the heat flow in the ground is nonstationary, a term should be added to (1) which expresses the difference between heat flows above and below the pipe and recognizes the curvature of the temperature gradient at the pipe level. Assuming the ratio h/r to be great, the following expression is thus obtained

$$q_1 = (\vartheta_u - \vartheta_x) \frac{2\pi\lambda}{\ln \frac{2h}{r}} + \lambda \left[\left(\frac{\partial \vartheta}{\partial x} \right)_o - \left(\frac{\partial \vartheta}{\partial x} \right)_u \right] D \quad (2)$$

The last term in (2) can, in most cases, be neglected. However, this term is significant when pipes lie just below ground level, since at this depth, variations in temperature will closely follow the fairly rapid and significant temperature variations of the air.

For stationary heat flow through walls of outer and inner diameters of D and d , respectively, the following applies

$$q_2 = 2\pi\lambda' \frac{\vartheta_i - \vartheta_u}{\ln D/d} \quad (3)$$

ϑ_i and ϑ_u are, respectively, the inside and outside wall temperatures, and λ' , the thermal conductivity of the pipe material.

When water passes through a pipe, heating or cooling of the water takes place, depending on whether the surrounding ground temperature is higher or lower than the circulating water. A change in water temperature of $\Delta\vartheta$ per unit length of pipe is caused by the transport of heat quantity per unit of time of

$$q_3 = QC\Delta\vartheta \quad (4)$$

where Q is water flow in the pipe and C is specific heat of the water.

During a steady state, the following applies to any point along the pipe

$$q_1 = q_2 = q_3 \quad (5)$$

In (5), q_3 is constant, if $q_1 = q_2 = \text{constant}$. Consequently, in (4), if the water flow (Q) decreases, the change in temperature ($\Delta\vartheta$) increases at the same time.

In practice, significant cooling of pipe water occurs when the water ceases to flow. If ground temperature outside the pipe is below zero, this implies that the water in the pipe will eventually freeze. It is, therefore, most important to establish the lowest ground temperature (ϑ_{xe}) at the pipe level. This is established from the ground-surface amplitude ($\vartheta_{oe} - \vartheta_{om}$), multiplied by a moderation factor according to

$$\vartheta_{xe} = (\vartheta_{oe} - \vartheta_{om}) e^{-x\beta\sqrt{\pi/aT}} + Af(x) + \vartheta_{om} \quad (6)$$

where x is depth below ground level, a is thermal diffusivity, and T is time period.

The second term and the factor β are inserted to illustrate that condition where the temperature gradient is larger above

than below the frost limit due to the latent heat generated at the freezing line.

ECONOMICAL AND PRACTICAL LAYING DEPTH

To study the need for heating as a function of laying depth, the frost depth in natural ground at Nattavara has been calculated. The frost depth for different freezing indexes and snow conditions has been determined; the method of calculation being shown elsewhere [1]. According to (2), heat loss is governed by the difference between pipe surface temperature (θ_{p}) and ground temperature at the pipe level (θ_{g}). The extreme value of θ_{g} has been determined for calculated frost depths at different levels in the ground in accordance with (6). At the same time, the duration of temperature conditions at the respective levels that make heating necessary has been determined. The relation thus calculated between power input, laying depth, and frost depth is shown in Fig. 1.

If it is assumed that the power input given in Fig. 1 is chosen so that the cables will be used only during the night, or during 8 of 24 hours, the energy consumption may be estimated. Cost of electric energy is calculated at a normal rate of 0.10 Sw. cr./kw-hour. Present heating costs are estimated over a period of 40 years at 4% interest. To this is added the cost for heating cable, which (including connection cables, installations, and a connection fee of 12.50 Sw. cr./kw) is estimated at 8 Sw. cr./m. The heating cable used for the tests was intended for a maximum power input of 30 w/m and a resistance of 1.0 ohm/m. For a power demand higher than 30 w/m, double cables were figured.

By reducing laying depth, the probability of encountering rock is reduced. The risk of having to resort to extraordinary measures, such as sheet piling, draining of water, are also reduced. Therefore, if two different laying depths at the same location are compared, the probable saving in cost resulting from a reduction of these risks should be considered. To illustrate this point, a simplified assumption has been made to the effect that, as a mean value, 10% of the excavated material at a 3.0 m laying depth will consist of rock, and that rock occurrence will decrease linearly to zero at a zero laying depth.

Fig. 2 shows, on the one hand, the relations between cost of trenches and laying depth and, on the other hand, between cost for heating and laying depth at different frost depths (the calculation is made for polyethylene pipes 70 by 56 mm). By summing up the curves of cost, a laying depth is obtained that gives the lowest total cost for each frost depth. As shown by the curves, absolute savings increase with frost depth, and cost will drop when laying depth is about half the frost depth. In the diagram, thermal conductivity of the frozen soil is assumed to be 1.6 kcal/m-h-°C. For soil with a higher thermal conductivity but with the same frost depth, minimum costs will occur at greater laying depths. A reduction in thermal con-

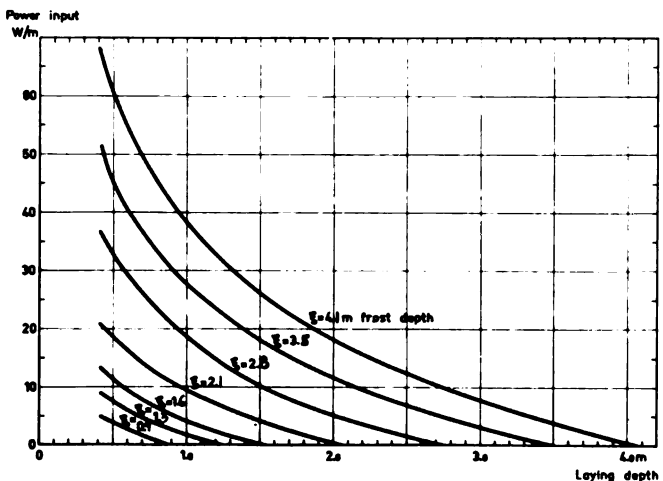

Fig. 1. Relation between power input, laying depth and frost depth

ductivity or in cost of electric energy, either per unit or by shortening amortization time, will result in minimum costs being displaced toward a smaller laying depth.

When choosing a laying depth in snow-cleared ground, the frost depth is selected that corresponds to the mean freezing index for the soil and location. At the same time, the capacity of the cable must be sufficient to keep the water line free from ice, during a prolonged period at a frost depth which corresponds to the maximum freezing index. In snow-covered ground, the same procedure is used, except that the mean and maximum freezing indexes must be related to mean and minimum thicknesses of snow cover. For a frost-depth penetration between 2.8 and 3.5 m in snow-cleared ground at Nattavara, costs were minimum at a laying depth of 1.6 m.

As mentioned above, the calculation is based on a normal power rate. The night power rate may be assumed, if a laying depth is chosen at which the pipe-level temperature does not fall appreciably below zero, i.e., heat loss from the pipe must be such that the water in the pipe will not freeze in the daytime, when it is flowing and the heating cable is shut off. This implies that it may be economically justifiable to choose a laying depth with a displacement to the right of the flat segment of the "summing-up" curve, so as to arrive at the summing-up curve shown by dotted lines in Fig. 2 for a night power rate of 0.05 Sw. cr./kw-hour.

In snow-covered ground, minimum costs are obtained at frost depths of 2.1 and 1.6 m and laying depths of 0.9 and 0.75 m, respectively. Since a considerable portion of pipelines (in spite of attempts made to place them within areas covered with snow) will lie in ground close to roads and farms, it may be assumed that, in most cases, it will not be possible to achieve economically beneficial, shallow laying depths for the whole plant as would be determined by conditions prevailing in snow-covered ground. The possibility of using low night power rates, therefore, would also be considerably reduced. Furthermore, in most cases, if laying depths were too shallow, it would not be possible to install sewers beneath cellars; or to prevent formation of surge ice in sewers; or to insulate sewage wells, etc., in an effective manner; or to avoid pipeline damage due to frost-heaving.

On the basis of these considerations, the laying depth at the test plant at Nattavara was fixed at 1.6 m, measured from the pipe-trench bottom. Practical considerations favoring this laying depth have thus far taken precedence over experiments to explore means for improving the economy of pipelines located near the ground surface in areas covered with snow.

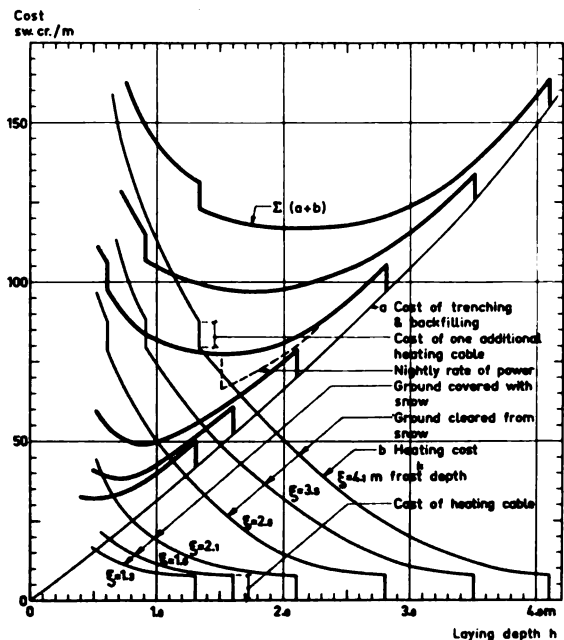

Fig. 2. Relation between cost, laying depth and frost depth in sandy-silty moraine

COST SAVINGS

The Plant at Nattavara

When comparing costs of two plants with different laying depths, it is obvious that the cost saving which can be achieved by reducing laying depth depends, to a large extent, on soil type. In rocky terrain, the saving will be considerable, while in easily excavated ground it will be small.

Excavations made at Nattavara indicate the soil to be hard (Class C). According to conventional design procedure, sewers are thus placed at a 3.0 m depth and water pipelines, 2.4 m below the snow-cleared ground surface. In snow-covered ground, pipelines can be placed at 0.2 m less depth. At a 1.6 m laying depth in snow-cleared ground the saving will be 26%, and for snow-covered ground, 38%, calculated on the basis of conventional construction.

Pipeline in Snow Covered Terrain

The mean frost depth is assumed to be 1.3 m. It will be seen from Fig. 2 that minimum cost is obtained at a 0.5 m laying depth. However, because of frost depth and likely traffic loading due to local winter roads intersecting pipeline trenches, it is advisable to increase laying depth somewhat. It may also be advisable to increase safety of operation by reducing power input to the cable; cost of feeders would also thus be reduced. If a 0.75 m laying depth is chosen, measured from the pipeline-trench bottom, the power input required will be about 5 w/m. If a comparison of cost is made with the common 2.2 m laying depth, the saving will amount to 40 Sw.cr./m or 54%, when calculated on the basis of the cost of the pipeline trench given in the more expensive alternative.

Pipeline in Rock

It is not economically feasible, under the climatic conditions prevailing in the north of Sweden, to place pipelines in rock beneath snow-cleared ground at a frost-free depth. In the absence of artificial heating, the fill around the pipeline must

provide sufficient insulation so that the heat content of the flowing water will prevent freezing.

In this case, power input required is calculated, assuming that the pipeline is surrounded by 20 cm of material having a fairly low thermal conductivity. As in the previous case, it is assumed that the temperature outside the pipeline is not allowed to fall below zero (stagnant water during the night). The temperature at different levels in the rock is calculated by (6). Duration of temperatures that require heating is also calculated. Thermal conductivity of the material around the pipeline, which can consist of peat, slag, crushed light concrete, etc., is assumed to be $\lambda' = 0.8 \text{ kcal/m-h-}^\circ\text{C}$, corresponding to the value of wet material in a frozen state. By using (2) and (3), temperature outside the insulation is determined, and heat losses from the pipeline may then be calculated as a function of the laying depth.

The relation between laying depth and heating cost for a 70 by 56 mm polyethylene pipeline is shown Fig. 3; excavation costs have also been inserted. It may be observed that minimum cost is incurred at a 0.75 m excavation depth. Due regard has been given to the fact that the pipe-trench depth is about 0.25 m greater than the laying depth, because of the insulated material around the pipeline. The power input required will be 30 w/m. In the diagram, cost comparison is made for laying depths between 2.4 and 0.5 m. In the former, the pipeline-trench cost will be 325 Sw.cr./m, and in the latter, 170 Sw.cr./m.

When comparing these costs, it should be recognized that the pipeline is of the cheaper alternative antifreeze type and does not apply to the more expensive type. In general, if the pipeline, because of a great water circulation, does not freeze at a laying depth of 2.4 m, heating cost at the lesser laying depth will, in reality, be less as well.

Consequently, the saving amounts to 155 Sw.cr./m or 48% as calculated on the basis of the pipeline-trench cost in the more expensive alternative. If the pipeline is surrounded by material with a lower thermal conductivity than that assumed, heating costs will, of course, be less. The reduced heating cost will then have to be expressed in relation to insulation cost. Heating costs will be lower also, if the ground is snow covered. In both cases of increased insulation, minimum cost will occur at laying depths less than 0.5 m. From a practical point of view, it would be unsuitable, however, to reduce foundation depth further.

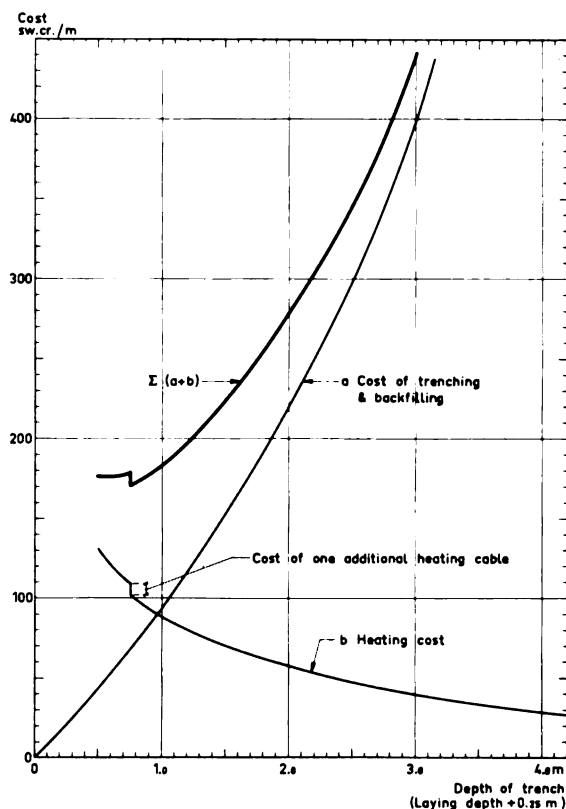

Fig. 3. Relation between cost and laying depth in rock

TEST PLANTS

In the autumn of 1960, six houses (for about 25 persons) at Nattavara were provided with water and sewage systems. The least depth at which a pipeline trench was laid was 1.6 m. The pipeline is polyethylene, and the dimension of the main pipeline is 70 by 56 mm, with that of the service pipes, 28 by 22 mm. The sewers are concrete, and the dimension of the service pipes is 150 mm, with that of the main sewer, 225 mm. The plant was in operation during the winters of 1960-1961 and 1961-1962, the intention being to study the practical consequences of a reduced foundation depth. The results of electric heating at Nattavara are illustrated in Fig. 4. Frost-depth variations beneath a snow-cleared road are evident, as is thawing due to different power inputs in the ground surrounding the pipelines.

In order to more accurately verify theoretical calculations regarding the need for pipeline heating in frozen ground, a research station was constructed at the water works at Gällivare in the summer of 1961. The intention was to study different methods of heating to thaw frozen pipelines, as well as to prevent freezing.

The plant consists of four test coils (No. 1-4); two lie in snow-covered ground and two in snow-cleared ground. For No. 1 (snow-cleared) and No. 2 (snow-covered), pipeline trenches are backfilled with peat; for No. 3 (snow-cleared) and No. 4 (snow-covered), trenches are backfilled with the original sandy/ or gravelly/silty moraine.

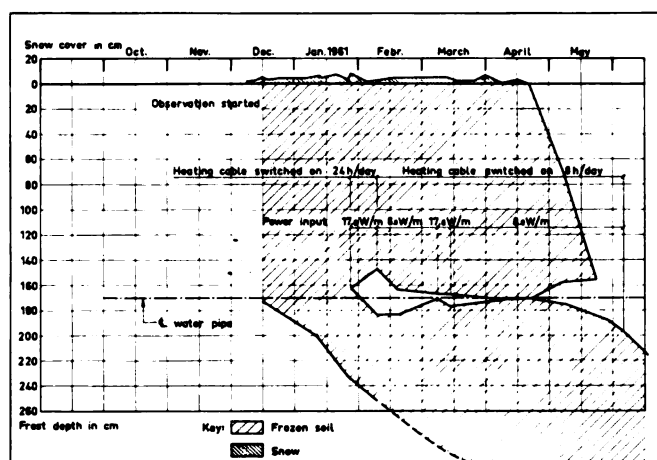

Fig. 4. Frost depth and snow cover at Nattavara

RESULTS

Work carried out at the test plants has shown that the results of the theoretical and experimental studies agree satisfactorily. It is concluded, therefore, that it is economical to place pipelines of the kind referred to, in frozen ground (i.e., above the frost limit) and to compensate for heat loss which causes freezing by providing electric heating cables. The economical laying depth (i.e., the pipeline-trench depth) is 1.6 m in sandy/silty moraine for the region under investigation. In this case, the power input required was approximately 10 w/m in snow-cleared ground. For the plant at Nattavara, saving amounted to about 30%, calculated on cost of conventional construction.

This calculation is based on the normal power rate. The experimental investigation has shown that, with a power input of not less than 10 w/m, it is necessary, during most winters, to heat only during the night. During winters of exceptionally deep frost (combination of a large freezing index, low moisture content, and unfavorable annual heat balance in the ground), it may be necessary to supply heat both night and day. It is assumed that water will be taken from a ground-water supply or from a lake with deeply located intakes. Daytime heat loss from pipelines is reduced by dissipation of heat from sewers, or by excess heat supplied by the heating cable during the previous night. In each individual case, the balance of heat from the pipeline must be calculated in such a way that no freezing occurs in the daytime. During the night, the heating cable is coupled to an automatic timer, to permit use of the night power rate. The saving mentioned thus will be further increased by about 5%.

In rock and in snow-covered ground, the economical pipeline-trench depth is 0.75 m. In this case, savings of up to 50% can be realized, calculated on the basis of conventional cost of the pipeline trench.

As the heat producer, heating cables of different dimensions can be used or, for long pipe lengths, ordinary electric cable. In the latter case, the number of connection points otherwise necessary will be considerably reduced.

In a snow-covered terrain, the use of a heating cable is not required for main pipelines placed at a 1.6 m depth in the kind of soil discussed. As a precaution against future local clearing of snow, a heating cable of ordinary electric cable can, of course, be installed if such is deemed appropriate.

A heating cable can also be used to thaw frozen service pipelines. Bare conductors of copper which are drawn into

the water pipeline may give more rapid results, but the disadvantages are significant. These consist, principally, of difficulties associated with applying a bare, uninsulated conductor that must be connected to a transformer. It is more advantageous, therefore, to use a heating cable that can be connected directly to the 220 V line of the building. The power input for thawing must not be below 15 w/m. The heating preferably should be regulated by thermostats, with the tactile body of the thermostats placed on the external surface of a cutoff valve. The valve should be carefully insulated, and the thermostat adjusted to start heating at $\pm 0^{\circ}\text{C}$. The adjustment is achieved by calibrating the tactile body of the thermostat against melting ice. In order to reduce the risk of freezing in service pipes, it is important to use welded plastic couplings insofar as possible. It would be well if the cutoff valve were of plastic as well. Heat dissipation from service sewers is of great importance in reducing the risk of freezing in water pipelines. Therefore, these pipelines should be placed close to each other.

The supply of current to the main pipeline heating cables (power input not less than 10 w/m) should be thermostat regulated. Its tactile body should be placed at the most sensitive point, with respect to frost depth within the area in question, e.g., on a long stretch of road. Here, the tactile body of the thermostat should be fastened diametrically onto the outside wall of the pipeline, opposite the heating cable, with electric adhesive tape, so as to obtain insulation against the surrounding soil.

If points in the remaining part of the plant have a considerably greater frost depth, the heating cable should either be doubled, or the pipeline provided with extra insulation at these points, so that the rest of the net is not heated for an unnecessarily long time. At large plants, several thermostats should be used, each independent of the other.

Backfilling around the pipeline should be done with great care with respect to insulation, preferably by using materials with a constant low thermal conductivity close to the pipeline. This is most important, since the power input required for the heating cable is directly proportional to the thermal conductivity of the surrounding material. The additional cost of the backfill material selected to be placed close to the pipeline should then be compared with the saving made from the reduced need for power input.

The tests made with a reduced 1.1 m laying depth and peat backfill have proved that, to the extent required, peat cannot prevent frost from penetrating into the ground. Thus, the additional cost of peat taken from the side borrows is not counterbalanced by any noticeable saving as compared with the alternative of having a 1.6 m laying depth and using natural soil backfill.

At the plants under investigation, water pipelines and sewers made of polyethylene or concrete have not suffered any damage as a result of frost-heave. In spite of the fact that the ground-water level at Nattavara was unusually high during the winter of 1961-62, the pipelines do not seem to have been damaged by frost. Here, the soil is classified as normally frost-susceptible. However, at high ground-water levels, every precaution should be taken with respect to soils classified as highly frost-susceptible, e.g., silt, loam, and loose clay.

Under no circumstances should rigid pipelines be used.

REFERENCES

- [1] L.-E. Janson. "Tjälens nedträngande i sand jämte tillämpning på rörgravar," (Penetration of Frost in Sand), Inst. Vattenbyggnad, KTH, 1959, *Väg- och vattengygaren 1960*, pp. 47-51; (also in *Trans. Royal Inst. Tech.*, Stockholm, Sweden, No. 231, 1964).
- [2] Rydberg, Huber. *Värmeavgivning från rör i betong eller mark*, SVSFs Handl. IX, 1955.

ARCTIC WATER SUPPLY AND WIND ENERGY

W. B. PAGE, U. S. Public Health Service

The story of attempts to achieve the most effective management of heat energy in design and operation of arctic water systems is a history of the development of this specialized technology [1]. In the past and at the present time, engineers have utilized various means of applying heat energy to maintain water in its liquid state under conditions of low temperature which would normally cause a change to the solid state (ice).

It has been common practice to add heat directly to the water at the treatment plant or pumping station and transport it in the water throughout the distribution system. This is accomplished by steam injectors, heat exchangers, immersion heaters, and by mixing with warm ground water [2 to 7].

Another practice is to establish a heat envelope around a volume of water to reduce the rate of heat transfer to a surrounding zone of lower temperature. This technique is illustrated by placing waterlines adjacent to sewers, by placing steam tracer lines adjacent to water mains within utility corridors, by installing electric heating wires adjacent to a house service line surrounded by insulation, and by using storage reservoirs excavated from solid rock. In the latter case, the rock absorbs heat from warm water during summer months and returns the heat during winter when the water is at a lower temperature [4, 8].

Electric power has been used more frequently in recent years to provide heat energy at strategic points in the heat balance of water systems. Low voltage electric heating has been used to maintain temperatures above freezing around house service lines and to prevent freezing of wells drilled through permafrost. Lead-covered and plastic-covered electric heating cables have been available from commercial sources for several years for use on exposed water pipes serving domiciles or farm buildings. A major advantage of electrical heating is the ease with which heat energy can be made available when the prime source of energy is located some distance from the point of heat-energy deficit. The greater expense of generating electric power may be compensated for by the convenience to the user and by avoiding heat losses that occur when heat is transferred by steam or water systems.

Heat energy supplied by electric power is commonly based on the use of petroleum products, natural gas, coal, or hydroelectric energy to generate the electricity. All of these are common sources of energy at lower latitudes; but in many areas of the Arctic, supply of energy by natural resources is limited. It is often necessary to transport the energy fuel to the site of the water system or to use extremely long transmission lines. In both instances, costs have been so high that electrical energy has been carefully hoarded for such uses as lighting and pumping power. Generally, it has been considered more practical to use the coal and petroleum fuels to produce heat directly in the water [2]. However, in such arctic regions as the northwestern and northern coasts of Alaska where fuel shipments can be delivered by ship during a brief ice-free period only and transportation cost per pound of fuel is very high, a local source of electric power energy is extremely desirable. A major source of such energy that has been used in the past in small amounts for radio receivers and household illumination is wind energy.

The present status of the technology of wind-powered electric generators is impressive. A 1250 kw windmill generator plant was constructed and operated in Vermont in 1941-45 [9]. Power cost was only 50% higher than low-cost hydroelectric power in Vermont. A number of 70 to 100 kw machines have been built and operated in Europe, Russia, and the United States. In 1957 a 200 kw ac windmill was erected at Gedser, Denmark. This machine had a rotor diameter of 80 ft, equal to that of an earlier 70 kw dc machine. Several new machines with a maximum power output in hundreds of kw are under construction in France and Germany [9]. As a part of a 7-year plan for developing water supplies, the

USSR hopes to install 65,000 windmills for pumping water [10]. This is probably a direct application of windpower to mechanics of water hydraulics rather than to electric power generation, but it reminds us that the wind has long been a favorite source of power for water supply systems.

These examples of tested windmill generators indicate that energy costs competitive with the more common methods of producing electric power have been reached, and the rotor may be compared to the water wheel as a producer of cheap electric energy. Utilizing the power output from winds occurring at random times creates a problem in electrical power networks because, for economy, all energy becoming available must be effectively used. For this reason the electrical power industry must find a method of distributing the random power automatically to various loads that do not have a precise time schedule [11].

The heat energy requirements of an arctic water supply system should provide opportunities for using electric energy that is available on a random basis according to the velocity of the wind. This power can be transported by wire transmission line and converted to heat energy by electrical resistance heaters at the point of heat deficit. Since the heat energy will be available on a random basis, it can best be stored as follows:

1. Storage reservoirs—The addition of heat to reservoirs at the lowest depths will enable the storage of the heat for days and possibly weeks depending on the geometrical shape of the reservoir and the insulation at the surface.
2. House service lines—Heat could be dissipated into the material surrounding the house service pipes. If these pipes are surrounded with material having a high thermal capacity, the added heat will be essentially stored for dissipation over a time period when the wind is providing little or no heat energy.
3. Wells through permafrost—Heat could be used to a limited degree in wells through the permafrost layer, if care is observed to control the maximum temperature within the casing to avoid thawing of the frozen zone in the vicinity of the well casing where artesian conditions exist.
4. Waste disposal systems—Heat could also be utilized for the waste water lines, tanks, and waste treatment units associated with individual homes or housing developments.
5. Household storage tanks—In those instances where water is delivered by tank truck, heat could be added to the household storage tank and thus reduce the heat load on the domestic heating system.
6. Distribution reservoirs—Heat can be stored by periodic electric heating of water in insulated distribution reservoirs. A significant consideration is the fact that in the Arctic, major heat losses occur in winter months during periods of high wind velocity. At such times a maximum production of heat energy could be expected from wind rotor generators.

The amount of heat energy that can be extracted from the wind is directly related to the electrical power from the wind rotor generator. This has been calculated [12] as follows: The power (P) in a wind stream can be expressed by

$$P = \frac{1}{2} \rho (AV) V^2 = \frac{1}{2} \rho AV^3 \quad (1)$$

where ρ is density of air, A is cross-section area of air stream, and V is velocity of air.

The power (P) can be calculated in kilowatts if certain conditions are assumed.

$$P = \frac{5}{10^6} \rho AV^3 \quad (2)$$

P is energy in kilowatts per hour, ρ is density of air at standard value of 1.201 g/M³ (at a barometric pressure of 1000 millibars and 290°K), A is cross-sectional area of the air

stream in sq ft, and V is velocity of the air stream in miles per hour.

The rotor cannot extract all available energy from the wind; the fraction that can be extracted, called the power coefficient (C_p), has a maximum value of 16/26 or 59.3%. Mechanical losses and those in generator and control gear reduce the over-all power coefficient C_p to 40% or less [12].

Of course the wind driven generator depends on the wind characteristics of the site and the operating range of wind speeds chosen in designing the machine. A velocity-duration curve for the site can be drawn from the measured hourly wind speeds and gives the number of hours of the year during which the wind equals or exceeds any selected value. The power-duration curve is obtained by cubing the ordinates of the velocity-duration curve [12].

A cursory review of the weather records for Barrow, Alaska, provided by the National Weather Records Center [13] for 1945 to 1954 indicates a mean wind speed of 10 to 14 mph; 37% of the observations were in the range of 13 to 24 mph. The approximate energy available at selected wind speeds is illustrated by Table I.

Table I. Wind-driven electric generator (rotor, 50 ft dia.)

Wind Speed (mph)	Power (kw) ^a	Available kw at 40% Efficiency	Btu/hour
10	9.8	4	13 640
15	33.1	13	45 025
20	78.5	31	107 105
25	153.1	61	208 750
30	257.1	103	350 650

^aCalculated from (2)

A small distribution reservoir serving eight 4-family apartments designed to contain a 24-hour supply would have a volume of 8000 gal based on 50 gal/day/capita and five members for each family. This is equal to 1000 cu ft or 66,500 lbs of water. The energy (Table I) from a wind of 20 mph would supply approximately 107,000 Btu/hour or sufficient heat to raise the temperature of the water in the reservoir one degree in less than one hour. If adequate insulation is provided for the distribution reservoir, the major portion of the wind energy should be available for adding heat to the central main distribution line, the central supply reservoir, house service lines, and the waste disposal systems.

The quantity of heat flowing through a material can be calculated by

$$Q = K \frac{(t_2 - t_1)}{d} a T \quad (3)$$

where Q is heat loss in Btu/hour, K is coefficient of thermal conductivity in Btu/hour/sq ft/°F/in., t is in °F, T is in hours, d is in inches, and a is in square feet.

Q = 600 Btu/hour from (3) if a reservoir of 1000 cu ft is constructed as a cube, insulated with the equivalent of Styrofoam plastic to a thickness of 6 in., and the following conditions are assumed: Wind speed equals zero at the exterior surface of tank insulation due to a wind screen wall; t_1 is 40°F, reservoir water temperature; t_2 is -20°F, outside air temperature; K is 0.10 for plastic foam insulation

(assumed); a is area of cube surface (600 sq ft); and d is thickness of insulation (6 in.).

Under these conditions a wind speed of 10 mph (Table I) would provide sufficient heat to replace heat losses from the reservoir, and the balance of about 13,000 Btu/hour could be used for the apartment service lines and waste disposal system.

A distribution reservoir constructed to serve as a heat storage device and to adequately serve adjacent apartments would need certain characteristics. These should include excellent insulation such as Styrofoam plastic, maximum volume per surface area ratio, minimum length of service lines, and a continuous low volume supply from the system source to prevent freezing of the lines supplying the distribution reservoir.

The combination of wind-energy electric power and continuous flow, single, main, central supply systems (having insulated distribution reservoirs that are surrounded by several apartment units) appears to be a practical approach to modern housing and water supplies in arctic communities.

The use of wind energy for providing heat at random times can be coordinated with the heat storage capabilities of this water supply system. The distribution reservoir concept can permit continuous flow through the main distribution system to prevent freezing of the mains without wasting high-cost water. The small insulated distribution reservoirs placed in the center of a cluster of apartment units, provide fire protection, heat storage, and minimum length of house service lines.

REFERENCES

- [1] Amos J. Alter. "A Guide to Arctic Water Works Thermology," Consulting Engr., April, 1957.
- [2] Staff Reporter. "How the Canadians Successfully Stop Townsite Water Pipe Freeze-up," Eng. Mining J., May, 1958.
- [3] Thomas M. Riddick. "How to Prevent Pipeline Freezing," Eng. News-Record, Nov., 1950.
- [4] H. P. Klassen. "Water Supply and Sewerage at Uranium City," Eng. J., Sept., 1960.
- [5] Hostrup, Lyons & Associates, Consulting Engineers. "Study of the Mechanical Engineering Features of Polar Water Supply," Rept. U.S. Naval Eng. Res. Evaluation Lab., Port Hueneme, 1953.
- [6] H. C. Westfall. "Battling Permafrost Sub-Arctic Weather and Tough Soil to Give Fairbanks Water," Water Works Eng., Jan., 1958.
- [7] S. S. Copp, C. B. Crawford, J. W. Grainge. "Protection of Utilities Against Permafrost in Northern Canada," J. Am. Water Works Assoc., Sept., 1956.
- [8] A. J. Alter. "Low Temperature Problems in Alaska," ibid., Aug., 1955.
- [9] G. Gimpell. "The Windmill Today," Eng., May 30, 1958.
- [10] E. W. Goldberg. "Solar and Wind Energy," Res., March, 1957.
- [11] E. W. Goldberg. "Three Unconventional Sources of Energy," Eng., Aug. 18, 1961.
- [12] E. W. Goldberg. "Electrical Energy from the Wind," Eng. J., June, 1957.
- [13] U. S. Air Force Weather Records Center. "Uniform Summary of Surface Weather Observations," Barrow, Alaska, unpubl. data.

THE HESS CREEK DAM

E. F. RICE, University of Alaska
O. W. SIMONI, U.S. Army CRREL

Occasionally, in developing water collection projects, dams must be placed over permafrost. When placed on material which would be unstable or unduly permeable if thawed, such dams must have means of maintaining subfreezing temperatures. This paper concerns only those dams whose stability requires frozen foundation material, and particularly refers to the Hess Creek Dam.

Experience in the Western Hemisphere with dams on frozen ground is quite limited; most such structures have been small diversion dams built of wood or metal, whose possible failure would not cause extensive downstream danger or damage. The Hess Creek Dam, near Livengood in central Alaska, is one of the very few sizeable earth dams ever built on frozen material in this hemisphere.

The Hess Creek Dam is located at N 65° 30', W 148° 23', near the headwaters of the South Fork of Hess Creek, a tributary of the Yukon River [1]. Mean annual air temperature is about -4°C as derived from a 6 year record at the Weather Bureau Office. It was designed and built to divert water from the Hess Creek watershed to gold mining areas in the valley of the Tolovana River, through a tunnel excavated in frozen silt and gravel near the upstream end of the reservoir. Fig. 1 is a schematic plan of the project.

A brief hydrologic study was made to ensure that sufficient water was available and to determine required storage and spillway capacity.

Table I. Statistical summary

Reservoir volume	9.5(10) cm
Dam height	24 m
Crest length	485 m
"Fill" volume	3.66(10) ⁵ cm
Surface area of reservoir	154 hectares
Watershed area	8000 hectares, 80 sq km

DESIGN

Designed by W. A. Kraner in 1939, the dam was begun as a conventional hydraulic-fill structure that was to be kept frozen by a coolant circulating within the dam itself and by exposing the structure to winter weather. For the latter purpose, the reservoir was to be emptied each fall, and kept dry throughout the winter, allowing the winter weather to augment cooling from the circulating system [2].

It was believed that, after construction was completed, artificial cooling of the dam could be discontinued, since the mass of the dam is similar to that of the surrounding land, which remains frozen perennially under natural conditions. Depending on surface cover, terrain, exposure, and mean annual temperature, permafrost could exist to a depth of about 61 m. Artificial freezing has now been discontinued. Current studies by the Alaska Field Station of the U.S. Army CRREL are expected to reveal the internal temperatures of the dam, and to assess the need for continued artificial freezing in similar structures.

The dam is typical of hydraulic-fill structures, in that coarse material predominates in the outer portions of the cross section, with a less permeable core toward the dam center. A steel sheet-pile cutoff wall was placed in a steam-thawed trench along the centerline of the dam's core, ensuring keying and bonding of the fill with the underlying material [3].

Through the base of the dam is a steel pipe 1.46 m in dia., whose inlet is controlled by a gate valve operated by a hydraulic cylinder and protected by an ordinary trash rack. The downstream end of this outlet sluice pipe discharges into a covered wooden flume 2 m square and about 15 m long. Out-

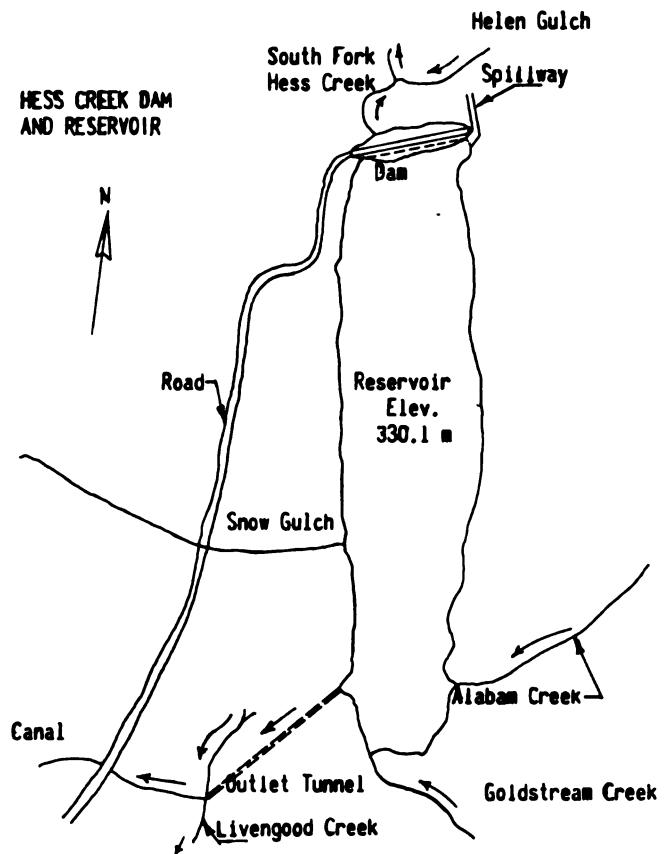

Fig. 1. Schematic plan of project

flow then discharges into the streambed downstream from the dam. This sluiceway is designed to drain the reservoir or to control its surface elevation.

For flood passage, a spillway channel was provided to the right (east) of the dam. It was excavated as a plain earth channel with a wooden protective apron and a steel sheet-pile cutoff wall near its downstream end, where it discharged into a natural tributary valley of Hess Creek. (In 1962, failure of the spillway control apron by underscoring caused the spillway channel to erode to a depth averaging 12 m below design elevation after which the reservoir was abandoned [4, 5].)

At the southern end of the reservoir, near the divide leading to the Tolovana watershed, a tunnel was driven through frozen gravel and frozen organic silt. Within the timbered tunnel, now abandoned and collapsed, was placed a wood-stave pipe 1.08 m in dia. to convey the stored water to placer workings near Livengood.

CONSTRUCTION

Stripping—Initial plans to start stripping the site and begin construction in summer 1940 and complete the project by fall 1941 [2] were not realized. Work was halted early in 1942 and not resumed until spring 1946 after the end of World War II. The project was completed by the end of summer 1946.

Stripping of overburden (consisting of vegetation, organic silt, ice, and other debris) to a depth approaching 12 m was done hydraulically, using streams of water from high-pressure nozzles.

Cutoff Wall—Upon stripping to foundation level, a cutoff wall was made by driving 6.5 m steel sheet-piles into a steam-thawed trench in the frozen material beneath the central core of the dam. The trench was refrozen in the winter of 1941 by circulating a coolant in pipes buried near the cutoff wall, which was built mainly during the previous winter.

Cofferdams—At each toe of the dam, cofferdams were built with mechanical equipment up to about 13 m above the lowest part of the stripped area. Through these cofferdams, between which hydraulic fill was to be placed, a wooden sluiceway was prepared to divert the stream during construction.

Foundation—The ground was stripped to inorganic silt, which is underlaid by gravel 10 to 12 m thick. Below the gravel is chert bedrock [6]. Gravel showed interstices filled up to 50% of its gross volume with ice [7].

To ensure bonding and prevent forming a slippage plane beneath the dam, the base near the toes (as well as adjacent to the cutoff wall) was refrozen rapidly by circulating a fluid through 3.8-cm iron pipe, spaced in parallel rows 2.5 m apart and buried beneath the fill. During winter when the air temperature was below freezing, Stoddard Solvent was used. This proprietary petroleum product (a mineral spirit of high flash point, low viscosity, and low freezing point with a specific heat of about 0.5, and specific gravity about 0.78) was pumped through pipes in a circuit that included two arrays, each 90 m long, of 26 similar pipes arranged above ground, serving as a heat exchanger.

Hydraulic Fill—In early 1941, equipment was installed to sluice material from adjacent borrow areas into the dam embankment. As in most hydraulic-fill projects, fill material was waterborne through pipes that discharged at the inner edges of the shoulder of the rising dam. Upon settling of fill material of the central pool, excess water was drained away through a centrally located vertical pipe which was lengthened periodically as the dam grew. This sort of operation assures "hydraulic sorting" of materials, leaving coarse and free-draining material at the outer faces of the dam, with fine-grained material settling nearer the central area of the dam, forming a relatively impervious core.

Shoulders of coarse material were shaped with a tractor to assure that they remained level and higher than the central core pool. Fig. 2 shows schematically the approximate zones

into which the material may be divided. Obviously, there is continuous grading of one zone into another, and no sharp distinctions exist between gravel of the outer shell and silts and clays of the core. Records are inconclusive on the need to augment fines in the core, but probably fine material was separately added to the pool from silt found on, or adjacent to, regular borrow areas.

When work was suspended during the winter of 1941, the hydraulically placed shoulders were 14 m high at the upstream face, 16 m high at the downstream face, and 13.5 m high in the core zone. At this stage, construction halted until spring of 1946.

Rolled Fill—The remaining fill in the dam, about 10 m high and 64,000 cu m in volume, was mechanically placed and compacted during the summer of 1946 by standard methods for rolled-fill dams. Work was begun late enough in the season to encounter thawing in the core. Considerable difficulty in equipment operation was caused by liquefaction of the core material, which was fine-grained and was saturated with an accumulation of water from rain and snow of previous months. As a result, several vertical pipes intended for monitoring temperatures throughout the mass of the dam were lost or destroyed, and a valuable opportunity for studies of heat transfer through soils of known characteristics was lost [5].

Materials—Nine soil samples from seven test shafts were submitted to Pacific Hydrologic Laboratories (San Francisco, Calif.) for laboratory tests. Tests included specific gravities, mineralogical composition, gradation (mechanical and hydrometer), settling tests, shear strength of representative shoulder material, and densities of material as hydraulically deposited and representative of outer shoulders, beach, and core.

Soil minerals were hard angular rock fragments of white, black, and yellow siliceous chert with grains of quartz, chalcedony, jasper, and other siliceous minerals—all with an adhering cover and admixture of yellow fines consisting of sand, silt, and clay sizes. Liquid and plastic limit tests were not run.

Soils from borrow pits ranged from silt, near the surface, to skip-graded silty sands and gravels. Sand and gravel from 0.02 to 0.2 mm were deficient. A shear test, on beach materials passing No. 4 screen and larger than 0.045 mm, showed a coefficient of internal friction, $\tan \phi = 0.86$, indicating adequate slope stability for this material when placed to design contours [8].

Table II. Soils deposited from water suspension values adopted for design [8]

Location	Density (g/cu cm)	Porosity Vol. (%)
Shoulders	1.60 (drained)	40
Beach	2.00 (drained)	36
Core	1.68 (saturated)	50-60

OPERATION AND PERFORMANCE

No serious problems were encountered in operation or performance of the dam structure. Seepage of about 0.21 cu m per sec was fairly constant throughout the summer. Seepage water, flowing through open-graded material along the steel sluiceway, proved clear and harmless.

Shrinkage cracks, similar to temperature cracks in highway fills during cold weather, appeared in top and downstream faces of the dam. Possibly they also existed in the upstream face, but the rip-rap protection effectively disguised them. Wherever encountered, these cracks were hand-excavated and backfilled with impervious soil, to avoid leakage and consequent damage to the crest of the dam. Observable cracks extended only about 3 m down from the surface.

Two minor slides appeared at the base of the upstream face, near the cofferdam constructed during 1940. The slides were observed after the reservoir emptied subsequent to spillway failure. They did not appear to have been active recently.

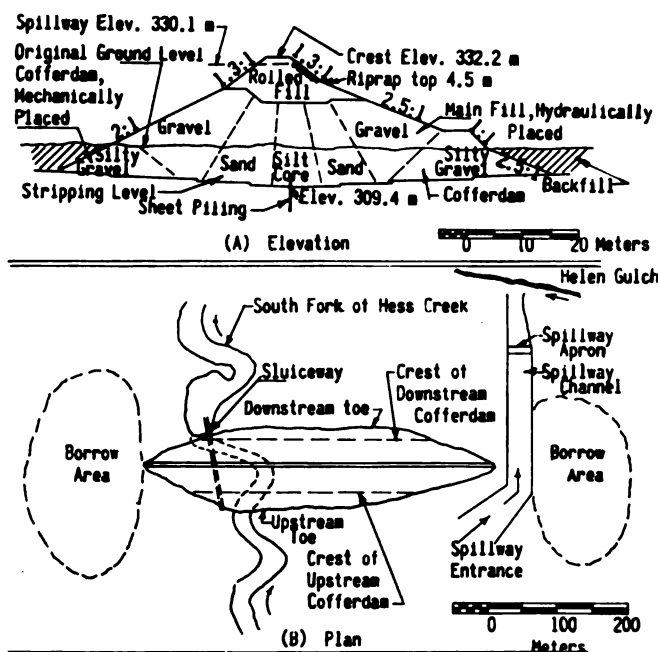

Fig. 2. Plan and typical elevation of Hess Creek Dam

The cause for the failure is unknown; further analysis must await proposed studies (by U.S. Army CRREL Alaska Field Station, Fairbanks) which should reveal conditions within and beneath the dam. Small slides are not considered prejudicial to safety of the dam; their anomalous presence may be a symptom of distress, however, perhaps because of temporary thawing of foundation material soon after initial filling of the reservoir.

Although project men believed that the dam was frozen throughout or would eventually become so, such freezing did not occur greatly during the 6-year interval from initial construction to completion, nor for some time thereafter. The uncompleted dam settled over 0.5 m during the years from 1941, when hydraulic fill was placed, to 1946, when the rolled-fill top was placed [9]. From 1950 to 1955, the completed dam settled another meter (Fig. 3). This settlement is considered typical for unfrozen hydraulic-fill dams; freezing has not been a factor in retarding settlement [10].

In 1946, temperature profiles indicated that the core of the dam had cooled from the 16°C of construction temperature to 0°C, near the base of the dam. Monthly mean temperatures for June, July, and August are 14°, 15°, and 12°C, respectively. No present evidence shows that freezing had taken place in that region, though low temperatures indicate little or no thawing of foundation silts.

SPILLWAY DESTRUCTION

The spillway was not adequate for continued operation at high flows. In spring 1962, watershed-runoff overflowed the reservoir and flowed in the spillway channel to a reported depth of about a meter. This inevitably caused gulley erosion where water discharged into Helen Gulch. Subsequent headward extension of the gully quickly undermined the wooden apron and steel sheet-pile cutoff wall (Fig. 4). The spillway control works were destroyed. Gulleying continued upstream into the reservoir itself and discharged the stored water through the now completely eroded spillway channel. Elevation of channel is now about 318.5 m.

OUTLET WORKS FAILURE

At the reservoir head, where water was delivered through a tunnel to placer workings near Livengood, there was a history of continued trouble including successive failures and subsequent high maintenance costs. A schematic section along the tunnel axis shows the general arrangement of the outlet works (Fig. 5).

Near each tunnel end, thawing caused caving of earth over the portal. In some cases, "daylighting" or corrective open-

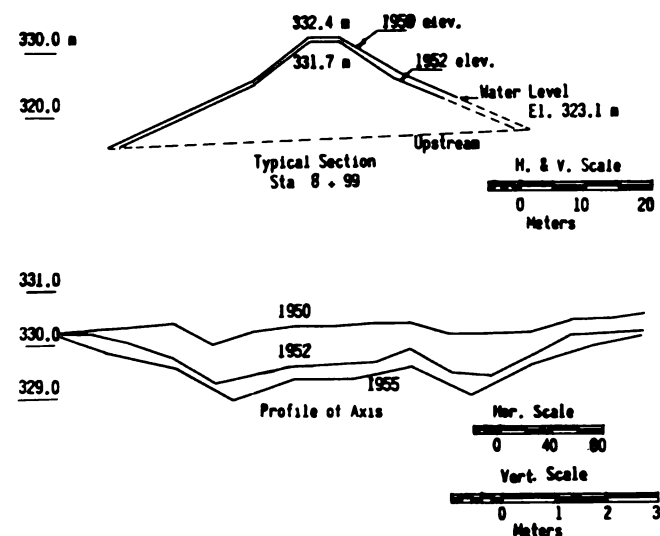

Fig. 3. Settling of Hess Creek Dam

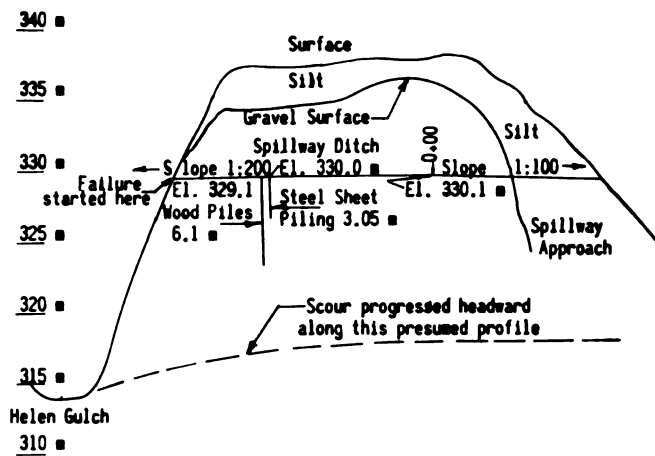

Fig. 4. Profile along spillway

ing of the tunnel to an open-cut section was required to continue operation of the wooden pipe within. Thawing also extended radially outward from the tunnel to from 1.5 to 2 m causing trouble especially where the tunnel penetrated areas of previously frozen supersaturated organic silt [5].

During winters, when the reservoir was emptied, the tunnel was exposed to cold air to refreeze the thawed portions. Even this caused trouble, because frost-heave in surrounding silt exerted sufficient pressure to break the sills upward and the columns, inward; this invited collapse and required periodic retimbering. Various attempts were made to seal the tunnel against leakage outside the pipe, and to protect it from caving, with only temporary success. The tunnel has now largely caved in and has been abandoned for the past five years [4, 5].

SUMMARY AND CONCLUSIONS

According to available facts, earth dams are acceptably stable, even when founded largely on frozen ground of poor quality and near-thawing temperatures. No problems assail the dam structure itself that are not common to all earth-fill dams—except that perhaps greater maintenance attention is required for dams in severely cold regions than is necessary in warmer areas.

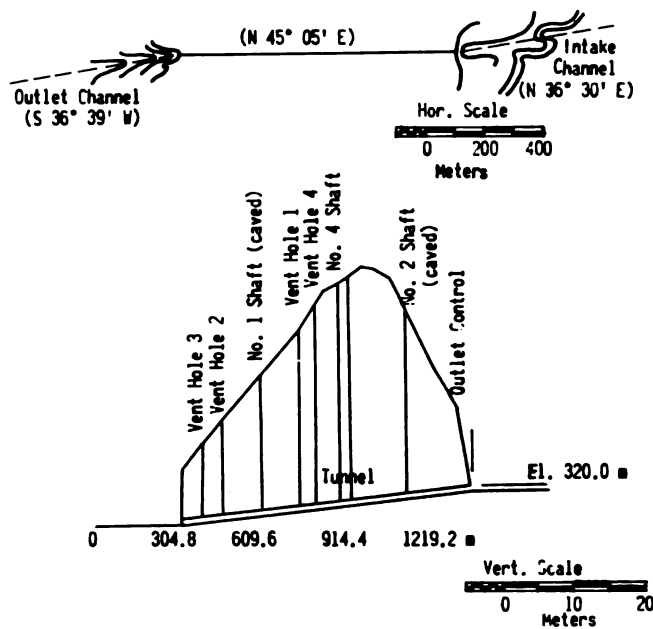

Fig. 5. Longitudinal profile through outlet tunnel



Fig. 6. General view of Hess Creek Dam from the west borrow area showing eroded spillway channel in the background



Fig. 7. View upstream in eroded spillway channel. Flat center area is at original elevation of the spillway apron

Stability of a dam, however, does not apply to control works and spillways. The dam of Hess Creek was little or no trouble after completion, but the outlet tunnel was a source of constant trouble and expense. A more careful, possibly more expensive, design of outlet control works than this one is necessary for reservoirs built in permafrost areas. (The high cost of maintaining the tunnel, however, was not the main reason for the virtual abandonment of the Hess Creek operation: Low gold recovery and financial difficulties, of which tunnel maintenance costs were but a part, resulted in the decision. Major failures occurred after this decision.) For such works it appears basic for future designs to ensure that structural integrity is not affected by either the presence or absence of frozen ground. Where frozen stability is essential, artificial refrigeration must be considered.

Spillways, in particular, must be built as if the ground were erodable, whether or not it is frozen at time of construction. To keep either a spillway or any active aqueduct permanently frozen is both expensive and troublesome. Where outlet works are built with material whose stability depends on its frozen condition, considerable ingenuity in design is required to ensure success and economy.

Construction, use, and abandonment of the Hess Creek Dam demonstrates, therefore, the following observations:

- (a) Dams may be founded satisfactorily on frozen ground, even where ground temperature is near the thawing point.
- (b) Outlet and water control works require both careful design and regular maintenance.
- (c) Study of the general problem of heat transfer through soils of varying composition helps establish criteria for future designs.
- (d) Permafrost need not be considered a major deterrent to the building of dams [11, 12].

ACKNOWLEDGMENT

The Hess Creek Dam described in this paper was designed and constructed by private interests. Permission was obtained from the owners for representatives of the University of Alaska and U.S. Army CRREL to investigate this project to gain technical information. Knowledge obtained will be valuable in development of engineering criteria for construction on permafrost foundations.

REFERENCES

- [1] U.S. Geol. Survey. Livengood (C-3) Quadrangle 1:63,360 Series, Topog., 1954.
- [2] W. A. Kraner. "Revised Report and Estimate of Hess Creek Dam Construction," unpubl. rept. to Livengood Placers, Inc., March 1940.
- [3] W. A. Kraner. "General Plan and Elevations of Hess Creek Dam," Drawing No. S-116, Dec. 1939, corrected to Aug. 1946.
- [4] Carl Heflinger. priv. comm., Livengood, June 1963.
- [5] Bruce Thomas. Callahan Mining Co., N.Y., priv. comm., June 1963.
- [6] Livengood Placers, Inc., unpubl. field repts., 1939.
- [7] W. A. Kraner. "Construction Progress Report on Hess Creek Dam During 1940," unpubl., Callahan Mining Co., N.Y.
- [8] C. H. Lee. "Soil Tests and Studies, Hess Creek Dam," unpubl. rept., Callahan Mining Co., N.Y., Oct. 1939.
- [9] W. A. Kraner. Unpubl. notes, Callahan Mining Co., N.Y., June 1946.
- [10] W. P. Creager, J. D. Justin. Hydroelectric Handbook, 2nd ed. John Wiley & Sons, N.Y., 1951, p. 441.
- [11] "Livengood - A Daring Attack on an Arctic Mining Problem." Mining World, May 1942, pp. 25-29.
- [12] Ralph Monson. "Permafrost Frozen Core for a Gravel Fill Dam," Contractors Engrs., Vol. 58, Dec. 1961, pp. 48-52.

WATER WORKS SUPPLY SYSTEMS IN PERMAFROST AREAS

CHARLES SARGENT, University of Alaska

Abundant potable water is necessary to comfortable living in any environment; a population's health depends on pure water for all domestic uses, and almost any modern industry uses water in quantities equal to or exceeding the tonnage of its product. Civilization cannot thrive where an adequate supply of good water cannot be made available.

In about one-fifth of the land area of the world, the ground remains at a temperature below the freezing point of water throughout the year. Where such a condition exists, the area is classified as a permafrost area in this paper, regardless of whether ice exists in the ground.

Industrial, commercial, or domestic habitation of permafrost areas requires special consideration of water supply and distribution problems beyond those necessary in more temperate areas. The water source may be frozen, water may freeze in the distribution system, or both. Available water may be of such poor quality that special conditions must be considered for its treatment. The availability of a water supply may be the greatest single factor in selecting community sites in permafrost areas.

WATER SOURCES

Permafrost areas have the same natural sources of water as other areas, but may have additional sources, in the form of ice, unavailable elsewhere.

Fresh water streams are a possible source, but usually large streams are silty because of normal erosion or glacial action; small streams may freeze completely and cease to flow in the winter. Impoundment of streams can create quiet water for desilting by sedimentation or for increasing the depth to allow water withdrawal below the ice.

Natural lakes that have an ample supply of good water are a good and prevalent source. Shallow lakes have the same disadvantage as small streams and, in addition, may become brackish in winter. Formation of an ice cover results in freezing out of dissolved salts. Natural lakes in high latitudes, because of long hours of sunlight, tend to become highly organic with algae and peat moss; therefore, brown water is often found in natural lakes in the Far North.

Ground water is available in permafrost areas where frost depth is not too great. Quality in these regions is extremely variable; the water is very apt to have a high mineral content, organic content, or both; water may have dissolved methane, hydrogen sulfide, and, sometimes, even oily scums.

The reason for such highly contaminated water is probably the frost itself. Alluvium may be frozen in blocks, permitting water to enter from the surface, but blocking the exit because of frost. Water has been found perched above frost, high above the base rock of the area.

Along the coast of the Arctic Ocean, ground water in the liquid state has such a high saline content that it stays liquid at much below the normal freezing point; this water may provide fire protection, but it is not adequate for domestic use.

Highly contaminated water usually has a low pH indicating that acids have been leached from the organic material of the surface which, in turn, permits taking available minerals in the soil below into solution. The lack of movement, due to frost blocking, permits acidic ground water to remain in contact with the minerals for great periods of time, providing very long contact periods for leaching.

Ice and snow from glaciers and icecaps may be the only source of water in some northern regions such as Greenland. These sources, when available, are ample and quality is nearly always good. The energy needed to convert these sources to usable water is high; only when cheap fuel is available would such a source be advisable for a settlement of any size.

Sea water is always a possibility when other sources are not available. The energy requirement for conversion is extremely high and the conversion equipment necessary would make selection of another source highly advisable.

Water from included ground ice is another, but very remote, possible source of water in permafrost regions.

Whatever the water source may be in northern regions, treatment will probably be required for clarification, sterilization, mineral and hardness removal, and decoloration.

WATER EXTRACTION

In permafrost zones, water is taken from common sources in the usual manner by pumps and gravity systems; special care is needed to keep equipment free from ice and freezing. The problem is usually solved by a combination of heating, insulating, and judicious location of facilities.

Water taken from ice and snow requires melting vats and a heat source. Since such systems are normally small, equipment is usually expedient and crude. The water produced is usually stored at home in makeshift containers, built from whatever is available.

CONTAMINANTS AND TREATMENT

Water in permafrost areas invariably need some treatment to assure a safe and usable supply. Water that contains pathogens is now rather rare, but settlement of the land will create increasing hazards. Other contaminants, while not all detrimental to human health, are unsightly and cause staining of clothing, plumbing, and even of human skin. Boilers, water heaters, and piping are often damaged because of mineral contaminants.

Silt which is found in large quantities in water of glacial streams can be treated by standard methods. A system that permits presettling of heavy particles, flocculation and settling, filtering, and subsequent chlorination can produce potable water. Sometimes these waters, after clarification, still contain high quantities of color; if so, breakpoint chlorination and secondary filtering can be used. Because of the problem of preventing such a system from freezing, its high operating cost, and the prevalence of other sources, the necessarily large plants of this type would seldom be used. A possible solution is impoundment of streams wherever large deep sites occur, permitting natural desilting and oxidation to remove color and suspended matter.

Organic color is a common contaminant in permafrost areas due to the many peat-filled lakes and the algae. Simple mechanical filtration and ion-exchange systems may help, but do not completely solve this problem. Oxidation, which is one answer to decoloration, usually needs huge doses of chlorine and long detention times. Chlorine doses of 20 to 25 ppm and detention as long as eight days may be required to remove color. A plant able to treat any large quantity of water this way would be economically unfeasible for any settlement; again, relocation or a different water source would be a better course.

Water from ground beneath permafrost or contained in permafrost usually has a high mineral content. Wells in Alaska were tested where iron content exceeded 300 ppm, and calcium carbonate hardness was as high as 1200 ppm. Such waters may also contain organic color and dissolved nitrates, as well as dissolved methane and hydrogen sulfide.

Iron can be readily removed by several methods: Aeration, pH increase, flocculation and sedimentation, or combinations of these, followed by mechanical filtration. Sometimes, where iron content is very low, iron can be removed by ion-exchange systems, but iron content here should not exceed 4 to 5 ppm.

Dissolved gases are removed by aeration with considerable success.

Adjustment of pH can be made by adding lime, soda ash, or caustic; lime is good in the very cold waters of permafrost regions because its solubility is greater in cold water. However, heating lime-treated water may cause precipitation and damage to boilers and pumps, and lime also increases hardness. Excess lime can be removed with CO_2 , but in small installations such treatment is very expensive. Sodium hydroxide (caustic) is excellent for pH adjustment as it also softens the water considerably; care should be used, however, as the concentrated chemical can be dangerous and is expensive.

Water can be softened by the lime-soda ash process for large quantities and by ion-exchange systems for small quantities. The use of ion-exchange softeners can be expensive because of high transportation cost.

Where ground water contains nitrates, there is no practical treatment; such waters should be avoided as they are very detrimental to health.

All ground water in the permafrost region should be chlorinated. Chlorine destroys any existing pathogens and prevents such contamination; it also aids removal of other contaminants. Breakpoint chlorination and filtration generally remove all iron and organic matter, and sometimes chlorine may be the only chemical needed. Excess chlorine can be removed by activated carbon filters, if necessary.

Depending on temperature and detention time required, several flocculating agents can be used. Iron contained naturally in water may be sufficient; alum has been used, as has ferric sulfate, activated silica, and combinations of these.

Ground water in permafrost regions is extremely variable. Wells a few feet apart either horizontally or vertically show extreme changes in quality of water. There is no standard method of treatment, even for a small area, because of the variability. Each source should be examined and tested by someone qualified to design a system particularly adapted to the situation, or much money can be wasted for equipment.

WATER STORAGE IN PERMAFROST AREAS

Due to the probability of freezing, water storage in permafrost areas is always a problem. Whatever system is used, special consideration of thermal conditions must be made.

Impounded water, such as reservoirs behind dams and natural lakes, can be used effectively if certain precautions are taken. Freezing depth must be considerably less than the total depth of the reservoir to assure adequate storage beneath the ice. In most habitable areas, this would not exceed 10 to 12 ft, usually less. Outlet works must be designed so that water is always drawn from the unfrozen region, and provision must be made to permit removal of any ice that may form in the outlet system. Heating or mechanical devices may have to be provided at reservoir outlets. Outlet size must be large to maintain capacity.

Elevated tanks in areas where mean annual temperature is below freezing must be designed and operated to prevent complete freezeup. Tanks may be heavily insulated and have added heat to prevent freezing. The same treatment must be applied to standpipes.

Using elevated tanks simply as a device to provide head and peak load water is not advisable. Water should be supplied continually to the tank and used from the tank to reduce exposure time to a minimum. This requires separate supply and service lines to the tank. The reasoning is obvious: Water exposed to the cold for only a short time is less likely to freeze than if it is exposed for a longer time. If supply temperature is only a few degrees above freezing point, enough heat will be supplied to prevent a well-insulated tank from freezing. A large volume of water requires considerable time and a rather low temperature to freeze completely—because of high latent heat. If elevated tanks are built oversize to accommodate some ice and are well insulated, artificial heat may not be required to prevent complete freezing.

Water storage in tanks underground is possible in permafrost areas, particularly in zones where ground temperature is near freezing. Because of the high latent heat of water, a considerable heat loss can be tolerated before change of state. If the supply is a few degrees above freezing and continuous, a large reservoir tends to build up a heat supply around itself by raising the temperature or even thawing permafrost near the walls; this heat is then available to prevent freezing within the reservoir itself. In very cold ground, artificial heat may be required until a heat reserve is established. Heat supplied in the summer may be retained well into the winter because of low heat transfer rates through frozen ground. Perhaps solar heat, collected during the year, can be made available to keep underground water systems from freezing.

In general, a storage system for water should be large so that heat in the water itself helps prevent freezing. Exposed reservoirs should amply allow for ice accumulation, and water exposed to sunlight should be treated to prevent algae growth.

DISTRIBUTION

Water distribution in permafrost areas is probably the most important phase of the system. The quantity of water within the lines is small compared with the surface exposed to cold temperatures. Burying lines below frost is not possible as permafrost often extends to great depths. There are several ways in which distribution can be done effectively: Utilidors or tunnels can be built underground for all utility distribution in a community. Above-ground utilidors can be built but these tend to interfere with traffic and communication; constantly circulating water systems can be used and insulation is not necessary. Fairbanks, Alaska, where ground temperatures are only slightly below freezing, has a circulating system and a provision to supply waste heat from a power plant. This system functions very effectively and little or no heat is required, even though water is but a few degrees above freezing.

In Anuvik, NWT, Canada, an above-ground utilidor is used. These heavily insulated boxes carry all utilities, and special provision is made to cross streets.

Several military bases in Alaska have underground utilidors providing all utility distribution—even sewers; although expensive, these ductways are very efficient and provide great maintenance savings as they permit ready access to all utilities. In some cases, they provide pedestrian passageways during inclement weather.

A system of wooden utilidors has been designed for Nome, Alaska. Its artificial environment prevents the water distribution system of utilidors from freezing. Such systems usually carry power, steam, and sometimes sewer distribution, and may serve as protected walkways for traffic so the entire cost does not have to be charged off to water distribution.

Utilidors carrying several utilities can use up heat that might otherwise be wasted. If utilidors carry sewers, some heat is always wasted with the sewage; this may be enough to prevent freezing. If central heating is used and utilidors carry steam and condensate lines, heat losses from steamlines may be more than sufficient; it may even be necessary to insulate waterlines to keep the water cool. Extraordinary precautions must be made in utilidors carrying sewers to prevent cross connections; some systems carry sewers below the utilidor floor, rather than inside, to maintain sanitary conditions.

Utilidor costs are high initially as excavation is extensive; concrete costs will be high in the permafrost regions until cement plants are located in the far northern areas. Metal utilidors should be cheaper than concrete, but alternate bids by contractors do not bear this out.

If utilidors are to be built, it is false economy to make them small. Height should be enough to permit a man to walk upright, and width should be great enough to provide all foreseeable utilities and still leave room to work on lines. Frequent access should be made, and knockout panels should be provided at all azimuth changes to permit installation and removal of long pipe lengths.

Circulating systems operate in frozen ground by virtue of heat carried into the ground by the water itself, and careful design of these systems is necessary to prevent dead spots where water may remain stationary long enough to freeze.

Circulation cost should not be high, as velocities need only be great enough to prevent freezing. Temperature recorders on return can indicate when heat must be added or when excessive heat has been added. Circulating systems should require more heat when first installed because as long as water is flowing, heat is being added to surrounding permafrost. A system that requires heat to get started may, after a few years, require no heat at all to keep in operation.

Connections from a circulating system to a user can also be made circulating by installing a return line from the service to the main and by creating a head loss in the main by an orifice; the return can also serve to bring a small amount of heat into the system from the user's building. Double mains can also be used. In general, enough experience has developed in the design of distribution systems to assure confidence in their operation.

Special precautions must be taken in frozen ground to prevent settling or heaving of structures. Some soils exhibit large magnitude settlements on thawing and may heave considerably on refreezing. Here, utility lines placed either in or above ground, are subject to movement. Movement must be considered in design. Annual ground movement, due to freezing and thawing, is greatest at ground surface and reduces to zero at permafrost surface. Permafrost thawing in fine soils usually causes a subsidence, and refreezing, a heaving. Coarse soils, such as gravel and sand, exhibit little change in volume during freezing and thawing while fine sand and silt undergo greatest change. Removal of the frost-susceptible soil and replacement with the nonfrost-susceptible material may sometimes be necessary to maintain stability of line and grade of utilities.

If subsidence is anticipated, utilidors or pipelines can be supported on piles. They should be placed, driven or drilled in, to a depth below possible thaw. Moisture content of soils is also important in the rate of thaw and freeze and the amounts of settling and heave. Work is in progress to determine the interrelation of these factors, but reliable design data is not yet available.

REQUIRED RESEARCH

To more adequately design water systems in permafrost zones,

there should be further research in several areas:

- (a) Thermal properties of soils should be studied to determine heat exchange values under various conditions.
- (b) Heat sources such as the sun, waste from power plants, etc., and economy of use should be evaluated.
- (c) Contaminants in permafrost waters should be identified and their effects on humans studied.
- (d) Most effective and economical methods of treating permafrost waters should be ascertained.
- (e) Construction materials and methods should be ascertained with respect to economy.
- (f) Desalination research should continue with emphasis on arctic applications.

In general, water supply should be studied from an arctic engineering viewpoint; the mere importation of ideas and methods from temperate zones with expedient modifications does not always provide the most effective nor most economical solution to engineering problems in permafrost regions.

Length restrictions do not permit a detailed list of the literature or of the various problems; detailed studies have been presented in reports of projects mentioned here. The Engineering Index gives sources of the detailed reports.

Mention should be made of isolated systems that supply only one or very few houses. Delivering potable water to cisterns may be the most economical method if a reliable source and delivery system is available. The cost of drilling wells, installing pumps, and providing treatment, often makes the individual system very expensive.

The possibility of pathogenic contamination continues to grow, because of the increasing population in northern areas, making the individual system a continually increasing risk. Adequate treatment of individual supplies is difficult as sources vary greatly, and treatment systems, to be adequate, must be designed for each source.

Providing water systems in permafrost areas is not difficult. High cost of water systems in northern regions are not due so much to permafrost as to the lack of economical transportation and labor and the great distances from the source of equipment supply. Water systems in permafrost regions should be engineered by arctic specialists or consultants should be retained; overdesign of a system to prevent freezing has been the rule, rather than the exception, by engineers inexperienced in permafrost work.

SANITARY AND HYDRAULIC ENGINEERING IN THE ANTARCTIC

M. J. SASSANI, U.S. Department of the Navy

Safe and adequate water supply, sewage, and waste disposal systems are as essential in the Antarctic as elsewhere. Temperature is the principle variant distinguishing sanitary and hydraulic engineering in antarctic installations from that used in other regions. Low temperatures, together with snow and continuous high winds, result in a changed exhibition of certain common engineering, physical, chemical, and biological principles.

Biological and chemical reactions are retarded and the physical state of fluid, soil, metal, plastics, and other materials is appreciably different. Solubility (of gases in liquid), humidity, heat transfer, and other physical phenomena are affected. In general, all chemical reactions used in environmental control, such as oxidation, reduction, coagulation, solubility, vaporization, and precipitation are retarded by lowering the temperatures. At low temperatures the oxidation of organic material is slowed appreciably. Temperature affects coagulation and filtration in water and sewage treatment. Research has shown that the polar environment may preserve rather than destroy bacteria and that adequate sanitary environment is a necessity [1].

Heat conservation, humidity, light, building and operating costs and efficient use of materials and resources are important in antarctic sanitary engineering. Planning must be thorough, workmanship good, tolerances small, and safety factors high.

Facility requirements for stations in the Antarctic are based on two different site conditions—coastal on permafrost and inland on the icecap, below the surface.

Coastal stations are: McMurdo Station, located on Ross Island, about 100 ft above sea level and about 820 miles from the South Pole; Cape Hallett Station, about 1200 miles from the South Pole; and Wilkes Station on the Knox Coast, about 1620 miles from the South Pole.

Inland stations on the icecap are: South Pole Station; Byrd Station in Maria Byrd Land, about 700 miles from the South Pole; and Eight Station, in Ellsworth Highland, about 900 miles from the South Pole.

In the past, most camps were only temporary and water and waste disposal were not considered a problem. Little America, the first semipermanent base, established by Admiral Byrd in 1928, did not include special provisions for waste disposal,

other than for comfort. Stations built for the International Geophysical Year (IGY) Program (July 1957 to December 1958) had only the simplest and most primitive water and sewer facilities. Since they were designed for only a 3-year life, costly and elaborate utility systems were not warranted. Stations on the icecap have had little difficulty collecting clean snow for melting without going too far from the site, whereas the station on permafrost encountered great difficulty in obtaining clean snow.

CONSTRUCTION PROGRAM

The scientific program in Antarctica, begun under the IGY, is being continued on an international basis. The United States Antarctic Research Program is under the direction of the National Science Foundation. In conjunction with this program, the United States is continuing to operate four stations which were built for use during the IGY. These stations are: South Pole, McMurdo, Byrd, and Cape Hallett. The United States also operates several facilities (Little America, Wilkes, and Beardmore stations) on a limited and intermittent basis. In addition to these activities, Eight Station, an air transportable scientific station, was established in Ellsworth Highland during the summer of 1962-63.

In the original planning it was thought that IGY facilities would be abandoned at the end of the IGY Program; their design and construction, therefore, was based on this premise. Revised missions and increased scope of the scientific program in recent years have made these facilities inadequate in some respects.

EFFECTS OF ANTARCTIC ENVIRONMENT

Climate

Construction at the following sites is confined to the months of October through March. Maximum average wind velocity at McMurdo Station is 65 mph. Average monthly velocities and temperatures are as follows: McMurdo Station, 11.5 mph and 13.0°F; at South Pole Station, 12 mph and -31°F; at Byrd Station, 14 mph and -5°F; at Cape Hallett Station, 10 mph and 19°F.

Daylight

Continuous daylight exists at McMurdo from late October to late February. During this time, favorable weather and ground conditions permit around-the-clock operations. From late February to late April, the transition from continuous daylight to continuous winter nights occurs. Thereafter, until late August, darkness is broken only by short periods of civil and astronomical twilight. Then, daylight periods become progressively longer until continuous daylight returns in late October.

Due to topography of surrounding hills, McMurdo Station does not get much effect of twilight, whereas Byrd and Pole, in the open, benefit greatly from twilight periods.

Site Conditions

"Active" or "passive" construction methods may be used in the Antarctic. Active methods imply thawing and keeping the site thawed, while passive methods imply neither disturbance nor alteration of frozen material at the site. In the Antarctic it is more economical to use passive construction methods in ice or soils existing at a temperature several degrees below the freezing point [1].

Evaluation of site conditions in locations of Antarctica indicate that low subsurface temperatures require insulation of all fluid-carrying conduits which would be damaged by freezing or cause damage through loss of heat. Most sites are of material liable to damage by excessive waste heat.

Transportation

Transporting supplies, equipment, and personnel to the Antarctic is a most serious aspect of construction which requires

special equipment, proper timing for movement of equipment and supplies, and added manpower. Air access has decreased the transportation problem, but distances and costs involved in reaching remote sites remain the same. Of all cargo delivered to the South Pole Station, 62% was fuel oil.

Movement of freight by ship is not as expensive as movement by air, but many areas are not accessible by ship and sometimes all resupply must be by air or sled. Scheduling projects for Antarctica is very important and designers are hard pressed to prepare complete detail plans, bills of materials, packaging and handling instructions, and tests when necessary so materials can be purchased for dockside loading to McMurdo Station, to be flown to other bases by October, the start of the construction season.

Manpower

Manpower resources for building and operating sanitary works in the Antarctic are limited. Often by the time a man becomes familiar with his job his tour of duty or assignment is completed. Properly trained or experienced personnel are not available so there is a tendency to use unskilled labor. It is therefore imperative that all future equipment be simplified as much as possible.

Individual productivity is also reduced at low temperatures, so added manpower is required, increasing supply and housing requirements. Costs of sanitation facilities is increased because of the modification of conventional facilities, increased insulation and heating requirements, and added structural provisions.

Energy Requirements

Energy requirements are of prime consideration in designing water supply and waste disposal systems in Antarctica. Conservation of heat, use of waste heat, and use of areas heated for other uses must be considered. Nuclear power will play an important part in sanitary and hydraulic engineering in Antarctica.

Health and Welfare Implications

Individual and group health is important, but there is a general tendency, predicated both on cold expectancy and the Antarctic tradition of small expeditions to pay little regard to sanitation problems. The absence of flies, mosquitoes, and other vectors tends to lull the Antarctic resident into a false security.

In any inhabited area, care must be exercised in the collection and disposal of human waste to eliminate the spread of sewageborne, disease-producing organisms. In low temperature areas, this problem is compounded by the need for communal or quasi-communal living and also by the preservation of pathogenic organisms under lowered temperatures.

Construction Materials

Rigid climatic conditions in the Antarctic make it necessary to use materials of weight and size that require the least time with the least equipment and the fewest persons for construction. Wherever possible, prefabrication, consistent with transportability, installation, maintenance, and repair, must be used. All outdoor construction is affected by continuous low temperatures and constant high winds, which preclude the use of lightweight materials that would require anchoring or weighing down, up to installation time. Where terrain is rugged (because of grade and surface material such as rock, ice and snow which exist at the coastal station), most materials should be of a size and weight that can be manually transported by two to four men.

WATER SYSTEMS

McMurdo Station

This station, located on permafrost, is the main supply base for all stations in the Antarctic operated by the United States.

In 1956 a peak population of 170 persons was anticipated. Today it has a summer population of from 800 to 1100 persons, including transients, and a winter population of about 250 persons.

Existing facilities—Snow here is collected from an area between hills about 0.5 mile from the station using a tractor with a scoop. This snow contains much volcanic ash, especially in summer when the available snow is depleted because of higher temperatures and continuous sunlight. This volcanic ash imparts high turbidity and color to the water which is difficult to remove.

Water consumption of about 20 gal/person/day is considered sufficient as the cold climate requires fewer showers, less water for drinking and a central laundry and mess, in which economy of water use is practiced. Drinking and cooking water is filtered and chlorinated. A vacuum-diatomaceous earth filter is used, having a filter area of 42 sq ft. It is built entirely of plastic, including shell, filter media, and supporting elements.

Without control over the rate of snow melting, the raw water temperature is normally between 120° to 140°F. These high temperatures shrink and distort the filter elements, thereby reducing the filter area, filter runs, and filter efficiency in removing turbidity. There is also an oily taste due to soot from the exhaust stacks of oil-burning heaters in the buildings settling over the entire area, including open-top snow melters.

The water is distributed to storage tanks in three main buildings once a day by a 1-in. hose line for distances up to 150 ft. Water is distributed to other buildings in 1-gal bottles for drinking. The high turbidity, color, and strong taste of the water shift drinking habits to fruit juices, milk, and coffee.

All other water used is not filtered or chlorinated. Water is available at each building that requires water such as washrooms, showers, laundry, and photographic laboratories; and each is provided with a separate snow melter. Snow melters are designed to use waste heat from the jacket water of diesel generator units, from the galley, or from space heaters. Auxiliary electric immersion heaters are also provided for use when station power demand is low.

This type snow melter has proven to be both adequate and satisfactory for small stations with not more than 25 persons. For larger stations where the water demand is 1000 gal per day or more, standard commercial-type asphalt kettles are used. Although this type of snow melter is quite effective, it requires large quantities of costly Arctic diesel oil. Tests indicated that 1 gal of fuel burned produces 70 gal of water. The use of numerous snow melters, together with storage tanks, pumps, and burners, each located at various points in the station, requires considerably more manpower to operate and added maintenance over that required for a centrally-located water treatment facility. In view of this and because of the treatment necessary for the highly turbid water from snow melt, distillation of sea water was selected as the more economical method of obtaining fresh water.

New construction—The sea water distillation plant using steam as fuel from the nuclear powerplant will reduce the manpower required, eliminate the large amount of fuel to be transported, and furnish acceptable potable water to many more buildings than are now receiving it. A heavy, electrically-heated hose will supply sea water to the distillation unit from a salt water intake through the 8- to 12-ft ice thickness at the shoreline.

Sea water is pumped to the salt water storage tank in the water treatment plant building 300 ft above the shoreline where the distillation plant is located. Salt water supply and brine return lines will be insulated and electrically traced. The distillation plant, with a capacity of 14,400 gal per day of fresh water, will be supplemented with a duplicate unit, for a total of 28,800 gal per day. The distillation plant building contains a 55,000-gal sea water and a 55,000-gal distilled water storage tank which is adequate for 3.5 days in summer and about 13 days in winter. These large tanks are covered to

prevent condensation from freezing on the walls and roofs of the buildings. Tanks will be above the floor to provide space for warm air circulation, and prevent water in the tank bottom from freezing.

Fresh water will be distributed from the distillation plant on the hill to the station, 0.75 of a mile away, by a 4-in. copper pipe, above ground, flanged, and in 21-ft sections, insulated with 3.25 in. of polyurethane foam, with a steel jacket on the outside. The pipe will have an electric tracer, thermostatically controlled. Everything is prefabricated for quick installation on timber supports above grade.

Surface material at McMurdo is nonhomogeneous basalt, ranging from large boulders to particles that remain in suspension more than 24 hours. The site is gently rolling terrain, volcanic in origin. Permafrost is about 6 in. below surface; consequently, earthfill or rockfill is obtained by scraping only a few inches off an area each day in summer as the sun warms the rocky surface. This water utility, in the initial phase of construction, will supply the mess hall and galley, laundry, laboratories, and toilet buildings.

Later, a water-main loop around the station will be built with recirculation pumps in the line, to keep water in the pipe continuously moving, especially during low usage. This recirculation will prevent the freezing of pipe should the electric tape in the sections be out of service. Buildings are serviced through walls, above the floor for ease of construction and accessibility for repair. The entire distribution system slopes down to low points so, should an electrical outage occur, the entire system may be drained immediately, before damage from freezing occurs.

Byrd Station

Existing facilities—Where stations are located below snow in tunnels such as Byrd Station and South Pole Station, all water is obtained from snow melting. Byrd Station, with about 60 persons in summer and 30 persons in winter requires 20 to 30 gal per capita per day in summer and 10 gal per capita per day in winter. The old Byrd Station which was constructed in 1956 for the IGY Program was temporary and abandoned when the new Byrd Station, about five miles away, was completed in 1961.

Snow is collected from a marked-off area 0.25 mile upwind from the station and hauled by sled to the centrally located hopper at the surface which feeds the snow melter in the power and utility building in the tunnel below. The snow is dumped into the hopper and is taken on an inclined belt conveyor to the melter. The closed-engine cooling water system of diesel electric generators is circulated through the snow melter. The water is then filtered through diatomaceous earth filters and stored in large steel tanks.

A looped distribution system is installed in each tunnel and runs through each building near the ceiling. Distribution system piping has 2-in. premolded glass fiber insulation, with factory-applied kraft, aluminum-laminated jacket on the outside, and electrically traced for piping between buildings. Piping inside the buildings is exposed to absorb heat from each building. Connections to all plumbing fixtures in each building are taken from the main as water passes through.

Water in the looped main is continuously circulated to distribute heat and prevent freezing. Expansion loops of flexible metallic bronze hose are provided at each building connection to prevent breakage due to building movement. Temperatures in tunnels below surface are more uniform than those above surface, thus permitting better heat control of waterlines and sewerlines. Air blowers, taking suction from snow wells, are used in the tunnels to maintain a maximum temperature of 0°F and to prevent melting of tunnel snow walls.

New construction—A Rodriguez Well unit to furnish water for the entire station is planned. This well will be about 500 ft from the nearest tunnel and 1200 ft from sewage disposal pits. Access will be by a tunnel 7 ft wide by 9 ft high, connected to the main tunnel. This well will have a shaft 42 in. in diameter, using a melting bit 36 in. in diameter. Snow is melted by melting-bit nozzles supplied with saturated steam

at 165 psig at 373°F.

When the shaft is about 150 ft deep, snowmelt no longer permeates the surrounding snow, but accumulates at the shaft bottom. When snowmelt is about 4.5 ft deep, the melting bit is replaced with a combination melting-pumping bit (pump being the submersible type). This permits continuous injection of steam simultaneous with pumping of water to the surface to storage tanks. When storage tanks are full, the melting-pumping bit may be withdrawn from the well after all water is blown out by compressed air to prevent freezing.

With controlled melting and pumping, a cylindrical-shaped cavity is formed; its diameter will be about 50 ft. In this type of well development at Camp Century, Greenland, the shaft and cavity were found to be lined with an impermeable ice coating [2]. Water can be stored in this cavity as long as there is sufficient heat available and it is adequately distributed to prevent freezing. This stored water may be used for firefighting in an emergency.

The maximum diameter of the cavity, because of lateral undermining, is established by structural requirements of surface loads. Well depth will be 600 ft, as this is considered most economical. When this depth is reached, added wells spaced not less than 150 ft on centers will be installed. Based on present population requirements, the well should furnish sufficient water for 12 years.

South Pole Station

Water supply at the South Pole Station is obtained by snow melting. This is done using hot exhaust from diesel electric generators. Water is pumped to a 940-gal main storage tank adjacent to the melter and then to 180-gal toilet room water tank through a 0.75-in. hose. A 1-in. pipe is used to fill the 225-gal overhead tank in the galley, and is immediately drained after the tank is full. Despite low tunnel temperatures and the length of unprotected tunnel runs, the line froze only once in 1957. During the summer, water consumption is 20 to 30 gal/man/day, and about 10 gal/man/day in winter.

Hallett Station

The absence of any continued snow cover at Cape Hallett, which is on rock, and contamination by penguin wastes made snow melting as a water source impracticable. During the summer, water is obtained from a large glacier about 1 mile from the station. When temperature is above 30°F, melt water from this glacier is collected in a basin and piped down a slope to a 1000-gal water wagon, which hauls it to the station where it is pumped into various storage tanks in the buildings.

During the winter, sea water is converted to fresh water by two 85-gal/hour distillation units. Access to sea water is obtained by repeated ice coring over a small area. This eliminates the previous need for blasting. From 4000 gal of sea water, 1500 gal of fresh water is obtained for a ratio of about 2.6 to 1. The water is clean but does not taste as good as glacier water.

Water distribution systems, whether in snow tunnels or above permafrost, must be a looped system, wherever possible, to prevent periods of nonflow with possible line freezing. Water velocity in the distribution system should be maintained at about 6 ft/sec to equalize heat losses throughout the system. This prevents the freezeup of any section or sections of pipe should the electric tracer in a section of the system be out.

In the initial operation of a system, after prolonged inactivity, or after the system has been drained, pipes are appreciably chilled. When water is turned on again, pipes absorb considerable heat, requiring added heating of water at the source. Water warmed above 68°F, however, may damage the pipeline by excessive expansion, particularly at the joints. Under normal operation of a distribution system, water temperature at the terminal point during static (nonflow) periods is generally kept between 37° and 41°F.

SEWERAGE SYSTEMS

McMurdo Station

Existing facilities—Sewage at coastal stations such as McMurdo is collected and disposed of by the "box and can" method in three toilet buildings at the station. With a large summer population that includes many transients and others working at the same time during normal daylight hours, facilities are overcrowded. These limited facilities plus the discomfort tend to lower morale. The ten showers for the entire station are located five in each toilet building at each end of the station. Due to the limited water supply, their use is restricted to certain hours of the day. As some quarters are up to 500 ft from the nearest toilet building, most buildings have a small trough-type urinal fastened to the inside face of an outside wall, with a discharge hose through the wall spilling to the grade on the outside. Hot waste water discharged from galley and laundry buildings also discharge outside, adjacent to each building, creating a crevasse in the permafrost which becomes deeper each summer.

In toilet buildings, drains from the lavatories and the trough-urinal collect in a 180-gal retainer box which is emptied through a rubber hose immediately outside the building when the box is full. This full flow discharge prevents hose freezing which occurs when small quantities of liquid waste are discharged. This discharge on grade freezes and remains until summer thaw, at which time it becomes unsightly, unsanitary, and odorous. Privy-type latrines in toilet buildings use half sections of 55-gal fuel drums outside, which are allowed to freeze and then dumped on bay ice, in hopes that summer thaw will dispose of them.

New construction—The improved sewerage system that is planned will consist of a 6-in. copper pipe, insulated and electrically traced, to collect waterborne sewage from the three toilet buildings (which will be converted to use 1-gal flush-type water closets and water-supplied urinals) and waste water from the laundry and galley and discharge it on grade at the coastline. The discharge line will end with a weighted check valve inside an insulated box. The check valve will not open until a head of 50 ft is reached in the sewerline from the buildings. This head is built up in 300 ft of pipeline. An added 800 ft of line plus a head of 50 ft is available. The check valve will prevent cold air from entering the sewerline during low flows and also cause the discharge from the outfall to be at full flow and high velocity, thus preventing line freezing. The discharge line will end 5 ft above grade to prevent ice buildup which would clog the outlet.

Byrd Station

Existing facilities—Sewage and waste disposal at stations on the icecap, such as the old Byrd Station, used pits dug beneath buildings. Interior waste tanks were provided for the collection of water from showers, lavatories, and galley. These waste tanks had immersion heaters, and when tanks were filled and heated, waste water was immediately released to the sewage pits, causing the pits to grow deeper—rather than wider, which would jeopardize building foundations. Privy-type latrines were placed over the pits for waste disposal.

New construction—The sewage from each building at the station will be emptied (using 4-in. pipe at the side wall of the building near the floor) into a heated, insulated, central steel sump tank below the tunnel floor. It will then be pumped about 1100 ft through a 4-in. force main in the tunnels to two disposal pits.

The pits are created by using a 24-in. melting bit and combination melting-pumping bit assembly (Rodríguez Well unit) [2] which is lowered by steel cable using an A-frame at the tunnel floor. Water is pumped out on the snow surface. Shafts from tunnel floor to pit tops are corrugated metal, 30 in. wide and 100 ft deep; each shaft contains a steel pipe air duct 16 in. in diameter and a 4-in. insulated and

electrically traced sewage discharge line.

Pits are 50 ft apart with the cavity 100 ft in diameter below the 100-ft depth so that the cavities join and become one pit, 150 ft in diameter. This prevents warm sewage from spreading laterally; cold air is injected by blower into one pit while sewage is discharged into the other, creating a counterflow system. This process is reversed after a time interval. Based on the present summer and winter population, these double pits should be adequate for about four years.

The sewerage system is 4-in. copper pipe with 4-in. flexible metallic hose at all building connections, sump tank, and all direction changes in the tunnels. Snow plasticity causes all structures to move in different directions, so that rigid pipe connections or one- or two-way flexible joints are not satisfactory. The pipe is insulated with 2-in. glass fiber and electrically traced at 7 watts per ft, thermostatically controlled, with a steel jacket on the outside.

PIPELINE CONSTRUCTION

All pipelines installed in the Antarctic at the coastal station on permafrost are of copper, type K, flanged 21 ft long, having polyurethane foam insulation and electric tracer tape or tapes—all encased in a corrugated or smooth wall galvanized steel, prefabricated before shipment. These prefabricated 21-ft sections will reduce labor and construction time.

Replacing a frozen section is very much simplified by removing the collar over the joint at each end, unbolting the flanges, and slipping out the entire section. The electrical tracer for the section is disconnected from the plug on the main cable feedline, which runs along the entire length of the pipeline.

The 2-in. waterline has insulation of 2.75 in., electrical tracer of 7 w/ft, and diameter casing of 8 in. The 4-in. water and 4-in. sewer has insulation of 3.25 in., electrical tracer of 14 w/ft (two 7-w tapes), and diameter casing of 11.125 in. The 5-in. sea waterline has insulation of 3.25 in., electric tracer of 14 w/ft (two 7-w tapes), and diameter casing of 12 in. The 6-in. sewerline has insulation of 4 in., electric tracer of 14 w/ft (two 7-w tapes), and diameter casing of 15 in.

All water and sewer building connections are made with a flexible metallic hose, electrically traced, insulated, and provided with flanged connections for building service.

The water and sewerage systems on rocky terrain are on wood supports at each end of each section, usually without anchorage to the ground. Where slopes are steep (above 20%) pipe anchoring is required. This is done by scraping slots in the top 6 in. of permafrost (about 2 in. per day) and by bolting the pipe flange to two 12 by 12-in. timbers. Due to steep ground, minimum velocities in the sewerage system of 2 ft/sec are usually exceeded. Where waterlines and sewerlines cross, they are placed in timber culvert boxes. This is done by scraping the ground as much as possible to create some depression, laying the timber box under earthfill, and ramping the road 20 ft on each side.

INTERIOR PLUMBING

All inside plumbing is copper with sweated joint fittings. This has been very successful. Plastic pipe for water and waste is not recommended because of low temperatures encountered in transportation, storage, or in temporary inactivation. Although the strength of plastic increases with decreased temperature, it tends to become brittle at low temperatures.

The 4-in. vents of the plumbing system for tunnel buildings in snow extend above the building roof. A flexible metallic hose, 2 ft long to compensate for any movement between building and tunnel arch, is attached to the vent end; a pipe from there is extended through the metal tunnel arch to a point 4 ft above the snow surface. This vent is placed inside a pipe sleeve 5 in. in diameter that is welded to the metal tunnel arch. A rubberized canvas sleeve, 18 in. long is clamped to the 4-in. vent pipe above the metal tunnel arch and to the 5-in. pipe sleeve to prevent snow melting on the 4-in. vent from entering tunnel or building.

All water closets are 1-gal flush-type to conserve water. They are wall hung to keep all drain lines above or between floor joists wherever possible for accessibility in repair and for use of building heat to prevent freezing. When possible, shower floors are raised above the main floor for the same reason.

Toilet rooms should be clean, warm, well lighted, ventilated, and conveniently located throughout the station. Small fans should be placed at each water closet, behind or to one side, with an exhaust duct directed outside to eliminate odors. Although ventilation in cold regions has always been minimized (due to the large amount of heat required to warm incoming cold air), adequate ventilation is necessary in all toilet rooms.

GARBAGE AND TRASH

Trash at McMurdo Station is hauled to an adjacent area and dumped on the ground. Garbage is placed in 55-gal drums, frozen, and dumped on the shore where the sea carries it away with seasonal ice. Trash and garbage at Byrd Station is placed in an auxiliary tunnel about 20 ft wide by 25 ft high by 300 ft long. This arrangement eliminates the need for hauling and burying outside. Trash at South Pole Station is burned in an incinerator at the end of a tunnel. Garbage grinders in galleys are not feasible where a waterborne sewerage system has a water supply too limited to keep solids from settling out in the line.

CONCLUSIONS

Climatic conditions in the Antarctic, because of low temperature and short construction time with intervening darkness, require that sanitary and hydraulic facilities be designed for construction and maintenance with minimum personnel and equipment, and with maximum prefabrication. The advent of large stations (over 25 persons) makes obsolete the expedition concept in Antarctica, where both scientific and logistic support personnel spent most of their time on survival.

With a personnel increase, duty assignments should be more specialized for efficient operation, both scientifically and logistically. Facilities must be provided that require only occasional attendance by experienced personnel for efficient operation. Dedicated scientific or logistics personnel, who continually cut into their leisure hours, merit relief from snow collection or waste disposal duties.

Fresh, potable water must be available to satisfy all needs. In coastal areas on permafrost, where abundant clean snow is not available, converting sea water to fresh water is considered the most satisfactory solution. Using the Rodriguez Well unit at inland stations, where unlimited clean snow is available, reduces the costly manpower requirements to a minimum. Most economical distribution of fresh water is by insulated pipeline—electrically traced, protected against low temperatures, and accessible in its entire length for repair or replacement.

Communal or quasi-communal living in the Antarctic requires sanitation of the highest order. Showers, lavatories, and water closets must be located in a clean, warm, well lighted, and well ventilated environment. To do this at minimum cost, sufficient centrally-located toilet buildings within easy reach of all personnel should be provided. To further facilitate this, the installation of a waterborne sewerage system, serving these centrally-located toilet buildings, is necessary.

Although this system is more costly to construct than the present "box and can" method, it eliminates the disagreeable work of removal and disposal of waste containers, reduces cleaning operations with attendant reduction of manpower, and improves morale. A minimum amount of pumps, valves, controllers, and meters should be used. Equipment should be simple and located, whenever feasible, in heated buildings to ease operation and repair. The materials must be the best available to reduce man-hours of work for repair or replacement. The Antarctic is no place to test materials or equipment that is essential to proper operation of the station.

REFERENCES

[1] W. W. Clark, G. Groff. "Sanitary Waste Disposal for Navy Camps in Polar Regions," Part III, Final Rept., May

1962.

[2] R. P. Schmitt, R. Rodriguez. "Glacier Water Supply and Sewage Disposal Systems," Symp. Antarctic Logistics, 1963.

WATER-FREEZING PROBLEMS IN MOUNTAIN COMMUNITIES

KENNETH R. WRIGHT and ORREN W. FRICKE, Wright Water Engineers, Denver, Colorado

The problems that arise from frozen water systems can be described best in the experience of four mountain towns in Colorado where elevations range from 8000 to more than 10,000 feet.

FOUR MUNICIPAL WATER SYSTEMS

Frisco (9100 ft)

Freezing problems at Frisco began shortly after a central water system was installed in 1956. The water was taken directly from a cold mountain stream, and the mains were laid with only about 5 ft of cover. In addition, asbestos-cement pipes were used for the distribution system. Electrical generators could not be used to thaw the nonconducting asbestos-cement pipes. When localized main freezeups occurred, these had to be left until spring. The townspeople, knowing that moving water is less apt to freeze than still water, would open bleeders on all mains for the winter. This reduced operating-line pressures so much that many consumers were nearly out of water before the mains began to freeze.

Finally, in February 1961, a severe cold period proved too much for the system. The rapid flow of the mountain stream stopped as ice dams up to 4 ft high formed in the stream channel. One main froze, then another, and by the time the usual bonfires could be built, generators brought into action, and a steam boiler purchased, the town distribution system was frozen from one end to the other. Nothing could be done except to drill individual wells in the business district, to haul water to fill bathtubs and other containers, and to wait until spring for the thaw.

The next summer during the short construction season, steps were taken to make sure that a major freezeup would not occur again. Ice-fractured, asbestos-cement water mains were replaced with electrically-conductive castiron pipe. The original intake on North Fork Tenmile Creek was abandoned, and a new intake was constructed off to one side of a small off stream pond under about 15 ft of gravel. The new intake provided filtration, took the warmest water from the stream, and strained out floating ice particles. This water, however, while better than direct stream water, could not be depended upon for antifreeze protection. Therefore, a municipal well was drilled and a pump house constructed so that "warm" 40° F ground water was available for the winter period.

After the new supply system was constructed, the past habits of excessive bleeding were not easily overcome. During the first winter, the operating pressures dropped very low as the turbine pump attempted to keep up with the demand. This was corrected the following winter after an intensive program of informing the residents of proper bleeding procedure and after the water superintendent was convinced that the mainline bleeders did not have to be in operation at all times. Through the last winter, one of the most severe on record, Frisco was able to operate its water system without any significant problems.

Blue Spruce (8600 ft)

This town (actual name not used here), which depends on a direct stream diversion for its water supply, uses mainline bleeders to keep the water in the distribution system moving fast enough to prevent freezing during the winter. While the mains are kept free of ice blockage by this technique, the

fire hydrant laterals, where no water flows, are still susceptible to freezing. In February 1963, an automobile garage caught fire. The fire department responded quickly, but no water was available from the nearby fire hydrant. Hose was laid to another hydrant, but again no water flowed. This showed that a frozen hydrant lateral problem existed in the community. While nothing has been done to date to correct this situation, because of a lack of funds, it is evident to the town fathers that antifreeze work is necessary.

Granby (8000 ft)

Granby has had a central municipal water system for many years; while heating the exposed steel water tank each winter was expensive and troublesome, most winters passed with only localized water main freezeups. An unusual technique to combat freezing was to raise the street elevations over troublesome mains so that these mains would finally have enough cover to be generally safe from freezing.

Enough freezeups did occur, however, to make the town undertake a program that included:

- (a) Development of a warm water well supply;
- (b) construction of a new underground reinforced-concrete water tank, covered with 1.5 in. of fiber glass insulation and 2 ft of earth;
- (c) installation of main loops to reduce bleeding requirements and yet keep warm water circulating in the town;
- (d) isolation and emptying of the exposed steel tank during winter periods;
- (e) installation of artificial circulation devices on all new fire hydrant laterals, and
- (f) construction of new mains with at least 8 ft of earth cover.

The beneficial results of these improvements will not be proven for several years, but such a coordinated effort can be expected to almost eliminate basic freezing problems in this community.

City of Leadville (10,200 ft)

The highest city in the United States is Leadville. The municipal water service (furnished by the Leadville Water Co.) has always had major freezing problems as testified to by the large steam generators spaced around the city. Fire hydrants were kept operative by flushing every one or two days. An interesting aspect of the situation here, however, different from the municipally owned water systems in other mountain communities, is that the company took preventive measures rather than merely meeting the crises as they occurred. Boilers injected live steam and crews of men flushed hydrants. Although these preventive measures were expensive, they protected the large investment from possible irreparable damage.

In 1958 a program was begun to attack the freezing problem methodically rather than to depend on the force of live-steam generators and manpower. The first step was to develop a warm source of water which flowed the year around at 50° F from an old mining tunnel. Collection facilities, a pumping plant, and a 2-mile pipeline brought this water into the distribution system. This source, capable of furnishing about 60% of the city's winter needs, has completely eliminated

the basic problem in about one-half of the distribution system. The 20 ft hydrant laterals in this portion of the distribution system have not frozen, even though no special precaution is now taken to protect these laterals. Evidently, enough heat is conducted from the "warm" main to prevent the laterals from freezing.

The next step in Leadville was to protect the hydrant laterals in the "cold" portion of the system without regular flushing. This phase includes the installation of thermostatically controlled heating cables buried next to the lateral. Where satisfactory flow in the main exists, pitorifices are inserted into the main and connected to the hydrant base with piping through which a constant flow is maintained to exchange the water in the lateral.

In addition, mains have been looped and regulating valves installed to create more favorable flow conditions. Bleeding of water mains is still practiced. The company now plans to increase the amount of warmer ground water available to the system for winter use.

All communities plagued with unsolved problems of freezing water mains, hydrants, and services suffer in many ways. Excessive time and energy can be expended in combating the freezing. In addition, there are other undesirable aspects:

- (a) Water is not dependably available for firefighting;
- (b) emergency replacement water, usually hauled in, is often not up to minimum health standards;
- (c) water is not available in sufficient quantities to flush away human wastes from household fixtures or in the sewers themselves;
- (d) businesses are hampered in their operation;
- (e) septic tanks and leaching fields may freeze up;
- (f) residents who drill wells are often lost to the system as customers;
- (g) reputation for undependable water service often leads to a poor reputation for the town, discouraging new residents as well as new businesses;
- (h) a frozen water main often means that a cracked or ruptured pipe must be replaced or repaired.

DESIGN ASPECTS FOR NEW COMMUNITY WATER SYSTEMS

The healthy population growth in Colorado's mountains requires designing a water system relatively free from freezing problems. Design aspects that should be considered and incorporated into the system are listed.

Cover Depth

If water mains and services can be laid with from 7 to 8 ft of cover, the time that they are within the frost zone (ranging to 10 or 11 ft) is shortened; thus, the freezing hazard is lessened.

Warm Water Supply

The ground-water temperature is usually found to be approximately equal to the mean annual air temperature. A water supply of about 38° to 40°F will provide enough inherent heat so that the safe heat content is readily measurable throughout the distribution system. The heat content can then be used as an operation criterion in that circulation needs can be determined more accurately by the regular use of a thermometer.

Double Service Lines

Two pitorifices can be used to a service line. (A pitorifice is a pitot tube-like projection for insertion into a water main to scoop up flowing water so that it can be piped to the base of a fire hydrant and create circulation through the hydrant branch back to the main.) They face opposite directions and each is connected to a service line pipe, which in turn is connected at the curb stop. The flow in the main will create flow in the double service lines whether the curb stop is open or closed. The service line beyond the curb stop can be drained either from the residence or by using a stop-and-drain curb stop when the service slopes toward the main.

Hydrant Lateral Pitorifices

Artificial circulation in the hydrant laterals, where adequate main flows exist, can be maintained by using pitorifices inserted in the mains and connected to the hydrant base or lateral end by adequately sized tubing. Water main velocities of about 0.5 to 0.7 ft/sec would be satisfactory minimums for protecting laterals of normal lengths.

Hydrant Lateral Heating Cables

In locations on the distribution system where flow characteristics are not satisfactory for the operation of artificial circulation devices, hydrant laterals may be protected by laying buried heating cables next to the lateral with one-half of the loop on each side of the pipe. A thermostat can be placed on the pipe to reduce power consumption, set to begin heating at 34°F and to turn off at about 36°F.

Main Bleeders

The presence of planned bleeders at critical points on the distribution system is convenient when it is determined that water must be wasted to replace cold water with warm water. Bleeding through hydrants is not satisfactory because the waste water causes icing of the streets.

Properly Looped Mains

Flow diagrams of the proposed distribution system will indicate where main loops should be placed to ensure against still water or very slowly moving water in the mains. Regulating valves are useful in controlling flows in the various loops where the main sizes are dictated by other considerations.

Design techniques must be economical if they are to be successful in their application to freezing problems. Pipe covers of 7 or 8 ft are, of course, more expensive than a more normal pipe cover of 5 ft. Indicated differences in contractor prices of these covers have ranged from about \$0.25 to \$1.25 per linear foot of trench.

Developing an alternate warm ground-water source for winter use may at first appear to be uneconomical. When the heat content is considered, however, a supply of 500 gal/min might be found equivalent in heat benefits to burning nearly 500 tons of coal in a boiler per season for steam injection purposes.

Pitorifices, double service lines, buried tanks, and other techniques have shown their economy in practice and are readily accepted by cost-conscious businessmen and city councils. Even the use of hydrant-lateral heating cables, when annual power costs are considered, is more economical than manual flushing at regular intervals.

Of antifreeze methods the most uneconomical for Colorado communities has been that of heating water by centralized steam generators. In this same category is the use of heating cables to heat moving water in main lines. Probably just as uneconomical, however, is to permit a freezeup and then attempt to thaw the ice. In one small community, where total cost of the water system was \$60,000, the freezing problems in a single winter cost the community directly at least \$25,000 in replacement of mains, drilling of emergency wells, and ineffective thawing attempts. In another community, a frozen 400 ft section of 6 in. main in frozen ground cost about \$5000 to replace.

FIELD OBSERVATIONS

During field construction and inspections or special investigations, certain observations have been made. Some of these data are listed below in the event that they might be of value to other designers of water systems in cold regions.

Heating Cable Power Consumption

A total of 13 heating cable units are presently installed in Leadville to protect fire hydrant laterals during the period generally ranging from January 1 through about April 15 of each

year. The average depth of cover is 6 ft, and the soil consists of well drained sand and gravel containing some clay. The laterals are laid under asphalt road surfaces and generally are not shaded by buildings. The roads are kept clear of snow. The average power bill is \$23.68, representing an average of 462 kw-hours of power. Each heating cable is equipped with a thermostat set to turn on at 34°F and off at 36°F. Half of the units were in operation all the time, while the remainder ranged from 19 to 91% operation time. It has not been determined why such a large range of operation time exists, and furthermore, why the hydrant lateral requiring only 19% operation time was originally the lateral most subject to freezing problems. Some of the heating cables have been in operation for four winter seasons, and to date no hydrant equipped with a heating cable has been troubled with freezing.

Water Transmission Line Heat Loss

Leadville's Canterbury Tunnel Pipeline is cast iron; it consists of 2000 ft of 8 in. pipe and 8000 ft of 12 in. pipe laid with 7 ft of cover. The pipeline is bedded on 6 in. of sand with 12 in. of sand directly over the top of the pipe. The soil is well-drained glacial debris, largely cobbles. About 60% of the pipeline is laid in an open right-of-way passing through a heavily timbered forest, while the remainder lies adjacent to a highway in open country.

The water begins its flow in the pipeline at a constant 50°F. Tests were performed on the pipeline in early February 1960, following a January when the average minimum temperature was 4.8°F and the average maximum was 28.6°F. The average preceding December temperature was 22.9°F. The reported frost depth in the forest was 3 ft; at the time of the observation, approximately 1 ft of snowpack was on the ground. Several observations showed that with a flow of 580 gal/min in the pipeline, the temperature change from beginning to end of the line was from 50.0° to 49.5°F.

Hydrant Lateral Pitorifice Flow

A one-in. Mueller Pitorifice installed in a 6 in. cast iron main at Leadville, and connected to the hydrant base with 1 in. copper tubing, was tested for effectiveness in circulating water through a hydrant lateral 20 ft long and 4 in. in dia. A 3 ft section of clear Lucite pipe was installed in the 1 in. copper tube line. With a flow of approximately 80 gal/min in the 6 in. main, vegetable dye was injected into the Lucite tube and the velocity was measured. It indicated a flow of 0.43 gal/min. This flow through the hydrant lateral was computed to be approximately 15 times that necessary to safely eliminate the lateral freezing hazard.

Frisco Water Temperature Change

At Frisco, water at 40°F enters an 8 in. asbestos-cement supply line approximately 2600 ft from the distribution system. The supply line is buried at an average depth of 2 ft; at time of observation, the supply line had a snow cover of about 2 ft. The distribution system has an average soil cover of about 5 ft of gravel and cobbles under gravel-surfaced streets kept clear of snow.

Water temperatures were observed at a hydrant at the far end of the distribution system. In addition to the 2600 ft through the supply line, the water had traveled through a 6 in. and two 4 in. loops in the distribution system, having a total length of one-half mile. A temperature change from the original 40° to 36°F was observed while flushing the hydrant. The estimated water travel time from the well to the hydrant was about 67 min under existing flow conditions.

Fort Collins Supply Line Temperatures

An old 10 in. Kalomain water supply line from a storage reservoir, 18 ft in depth, to the city's distribution system was laid through agricultural land at a depth ranging from 3.5 to 4 ft. The line is about three miles long. Farm leveling reduced the cover for about 500 ft to an average of approximately 22 in., with a minimum cover of 17 in.

The flow in the pipeline is a relatively constant 0.5 million gal/day during the winter. An analytical study of the hazard, using a cylindrical shell heat flow approach, indicated that the water temperature would not drop below 34.2°F under operating conditions and that the line could be shut off for up to four days before it would freeze.

Water temperatures in the pipeline were measured during January and February of 1963. The average air temperature for January was 17°F with minimums for the month reaching -25°F. Experience with similar reservoirs indicated that water temperatures at the outlet toward the end of January were between 36° and 38°F. On February 6 a low temperature of 35°F was recorded at the minimum cover section, indicating a water temperature drop in the pipeline of from 1° to 3°F.

Ground Temperature Observation on Berthoud Pass, Colorado

The Berthoud Pass avalanche station, 11,315 ft high, was visited during the first week of January after a small snowfall. With one ft of snow on the ground, the temperature between the soil and the snow was measured at 15°F. Two weeks later the snowpack increased to three ft and interface temperature, to 32°F.

COMPUTING FREEZING HAZARD IN PIPELINES

The problem in Colorado of determining what design steps should safeguard proposed water pipelines or protect existing pipelines has been handled by an empirical approach. For instance, the amount of power required by a heating cable to prevent a 4 to 6 in. hydrant lateral from freezing under certain air temperature and soil conditions is used to approximate other heat-loss rates. Records of the time between hydrant flushings necessary to just reach a slush ice flow from the hydrant have also been helpful, as have the temperature drop observations on operating pipelines.

$$H = \frac{2LK(t_a - t_b)}{\ln b/a} \quad (1)$$

where H is heat flow in Btu/hour, L is length of pipeline in ft, K is thermal conductivity in Btu/hour times ft times °F, t_a is °F of water, t_b is °F of ground at outside of temperature gradient, b is radius of outside perimeter of temperature gradient in ft, and a is nominal radius of pipeline.

Equation (1) for heat current through a cylindrical shell is utilized for basic relationships between the empirical data and the prognostications on freezing hazard on a proposed pipeline. The equation leaves adequate opportunity for engineering judgment by permitting the choice of the parameters (K, t_b , and b) in its use. Use of the equation for gravelly and well-drained soil in Colorado's mountains indicates that conservative results are obtained by a K of about one Btu/hour times ft times °F, and by a difference between a and b of about 0.5 ft for pipeline sizes from 4 to 10 in. The values of t_a and t_b are, of course, determined by engineering investigations and judgment and often are in the magnitude of 36°F and 25°F, respectively.

Direct conversion relationships are useful from one community to another by utilizing known heat-loss factors in terms of Btu/sq ft times hour, where the area dimension is the outside area of the pipeline per unit of length. Judgment changes can easily be made, depending on somewhat different soil conditions, depth, or surface vegetation.

Some analytical approaches to freezing problems depend primarily upon a freezing index computed from the mean of the daily maximum and minimum air temperatures. The freezing effect for the day is measured by the number of degrees of frost, which is the difference between the mean and the freezing points. For any period, the running total of these daily degrees of frost gives degree-days of frost, and the total for a winter gives the freezing index.

Measurement of frost depths in Colorado's mountains indicate that other factors to be considered are: Whether a pavement is asphalt- or gravel-surfaced; whether the area is subject to high winds; whether the snow is cleared; or whether vege-

tation cover includes trees, bushes, or weeds. These factors, as well as soil type and moisture content, seem to have an effect.

Many factors are related to radiation characteristics for both long-wave and short-wave radiation. In Colorado, where the skies are usually clear, both positive and negative radiation are apparently important in forecasting frost depths. A published frost nomograph, for instance, shows frost depth of about 5.5 ft for a freezing index of 1500 in a pavement surface with well-drained sand and gravel subsoil. In Leadville, where the freezing index usually runs from 1400 to perhaps 1600 from year-to-year, the depth of frost under asphalt roadways reaches 10 or 11 ft.

Where it is impractical to install water mains below the frost line, the temperature gradient between the frost line and the ground surface is important in determining ground temperatures surrounding the pipeline. Soil temperature data collected at Fort Collins and generally observed in the mountains, indicate that a temperature gradient of 2° F/ft occurs. This, of course, varies with soil characteristics.

WINTER OPERATION PROCEDURES

The most elaborately designed water system to obviate freezing problems has little chance to function properly with improper operation. It is the duty of the design engineer to make sure that once the system or improvements are put into operation, the operating personnel know exactly how and why certain functions are to be performed. The engineer should keep in

touch with the project for at least several winter seasons to determine the effectiveness of the antifreeze techniques and to make tests and observations to collect valuable data for use on other systems and to increase generally the recorded information on this subject.

Temperature readings must be taken and recorded at critical points in the system on a regularly scheduled basis. These readings forewarn the operator of impending freezing problems and provide for preventive measures.

As the cold winter months approach, and where an alternate source is available, the operator must place the auxiliary warm-water supply into operation and shut down the cold-water supply that is not required for these months. Valves should be set to obtain the desired circulation pattern in the system. Bleeders should be inspected to ensure their operational readiness. Regulating valves must be adjusted so that proper flow is obtained in each branch of looped lines.

Throughout the winter, flow and water temperatures at bleeders must be monitored. Ice accumulations at bleeders should be removed to lessen the danger of the bleeder itself freezing and so endangering the portions of the system protected by the bleeder. Should the water drop to 32° F or the flow lessen appreciably, the water lines must be flushed immediately to remove any slush ice, and the regulating valves must be adjusted for rapid replacement of cold water with warmer water.

Each system, of course, has its individual operational problems. However, in all cases, the key to successful operation is regular surveillance and data-recording by the water-system operator.

DAMS IN PERMAFROST REGIONS

P. A. BOGOSLOVSKIY, Gor'ki Engineering-Construction Institute
V. A. VESELOV and S. B. UKHOV, Moscow Engineering-Construction Institute
A. V. STOTSENKO and A. A. TSVID, Far East Scientific-Research Construction Institute, Moscow

At present, experience with the construction of dams and other hydrotechnical structures in permafrost areas is lacking when compared with experience on civilian, industrial, transport, and other engineering constructions.

Though the first dam built in Russia on the Mykyrt River at Petrovsk-Transbaikal [1, 2] in 1792, is still operating, there has long existed the belief that dam construction on permafrost must inevitably present insuperable difficulties. This misconception arises from several unsuccessful attempts to construct and operate dams in those regions [2-5].

In 1916, A. V. L'vov [3] summed up and suggested considerations concerning the basic principles of dam construction on permafrost. In 1937, E. V. Bliznyak [6] clearly formulated those principles.

Later they were developed by investigators and engineers, who agree that dams should be built by either the "warm" or the "cold" method, but not both because of possible damage. The warm method is much the same as building under normal conditions; but the inevitable thawing of frozen ground in the dam foundation and banks of the storage reservoir must always be considered, noting all possible effects, including water percolation under and around the dam body. In the cold method, both foundation and body of the dam (when built of local earth, rockfills, etc.) or the foundation alone (when the dam consists of concrete, reinforced concrete, etc.) should be kept frozen for the duration of the dam. Here the frozen ground, having high bearing capacity and impermeability, can be used successfully as a dam foundation, impervious core, or screen. Meanwhile, measures are taken to prevent ice melting or possible water seepage through storage reservoir banks. Various dams in north and northeast USSR have been built by both methods and are successfully operated.

Factors that determine the type and design of a dam are ground and foundation conditions, transportation difficulties such as delivery of building material to the site, character of

runoff, climatic conditions, and thermal conditions of the structure and its foundation.

Part of the dam foundation is subjected to thaw by the reservoir water heat. If the frozen ground of the thawing sub-base is not subjected to considerable and unequal settlement while keeping its bearing capacity, and if its impermeability does not decrease substantially, the warm method of dam construction can be used successfully for foundation construction. Moreover, such dams will closely resemble in design those built in temperate regions. If thawing of the foundation leads to substantial deformation, the dam should be built by the cold method, using a specially designed dam and a specially prepared foundation.

Both types of dam are built chiefly with local rock, soil, peat, moss, ice, and snow because transportation makes other materials very expensive.

Dams built by the warm method are illustrated by two earth-fill dams built in 1932 to supply the stations of Skovorodino and Magdagachi [2, 4] with water. These dams were constructed long before basic principles were specified, i.e., by ordinary construction rules known then. Accidents were frequent and builders were worried as well as the operating staff. With normal operating conditions, deformations became stable, and since then operation has been faultless.

The first dam, 7 m high, was built on the Pravaya Magdagacha River. A vertical concrete diaphragm runs across the center of the dam. The dam in Skovorodino was built in a dry ravine with a clay puddle core. At first, water leakage was a common drawback for both dams; therefore, water takeoff galleries were provided from the downstream side.

The special feature of dams built with local materials (earthfill, rockfill, or both) and by the cold method is that the frozen ground or ice in them is a stable and impermeable material (Fig. 1a) [7].

Examples of design and faultless operation of such dams

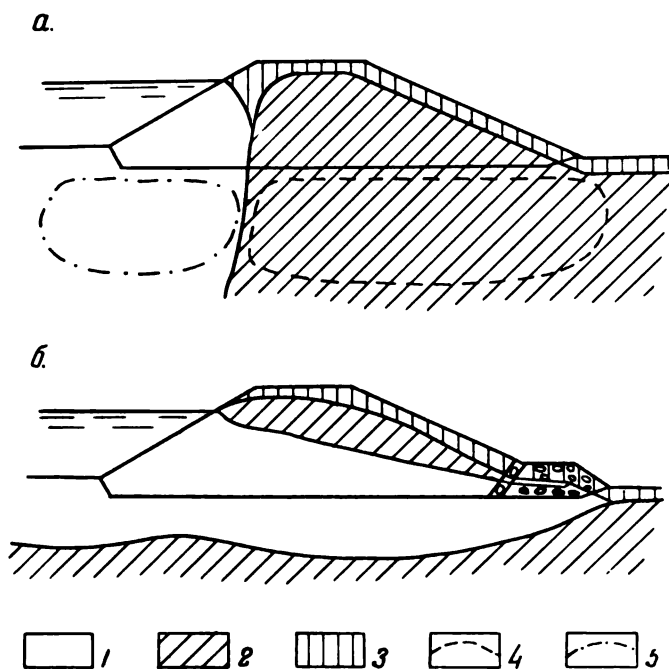

Fig. 1. Typical diagrams of earth dams
 a. Impervious dam with frozen soil for stability and water tightness. b. pervious dam. 1—zone of permanently thawed soil; 2—zone of permanently frozen soil; 3—zone of alternating thawing and freezing; 4—zone in which it is necessary to freeze naturally unfrozen ground; and 5—zone in which it is desirable to thaw previously

are the earth structures in Noril'sk (10 m high [5] and 8 m high [2] on the Mfaunjo River in the basin of the Kolyma River). Both were filled with frozen soil. Special refrigerating installations kept underground flows and body of the dam frozen during construction and the initial years of operation. As soon as the given temperature was reached, operation of the installations was stopped, and since then the frozen state of the core and dam body has been maintained by two different methods. On the downstream slope of the Noril'sk Dam, ice galleries very similar to ice stores, were built using M. M. Krylov's method. In winter, natural ventilation was provided in the ice galleries, whereas in summer they were effectively insulated. To maintain the required temperature of the Mfaunjo Dam, the cooling system remained after dam freezing was finished. This system consists of several vertical pipes and manifolds. Cold air is blown through the system in winter.

The thermal inertia of the dam is sufficient to retain winter cooling during the summer. The climate in these regions is favorable for normal operation of the dams. A dam of similar design, 44 m high and 427 m long, was scheduled to be constructed in 1963-64 on the Chatanika River (approximately 37 km northwest of Fairbanks) as pointed out by R. Monson [8]. Designing and operating such dams provides data to formulate some principles of design and arrangement of cold dams.

In such a dam the permafrost area occupies the downstream side of the dam, whereas the zone of permanently thawed soil occupies the upstream side (Fig. 1a). The frozen downstream side (dam core) is an impermeable screen that withstands water pressure.

Water retention arrangements should not be placed in the melted upstream side and especially not along the upstream slope of the dam because deformation of the thawed zone soils may cause damage.

The upper zone of the dam serves as a thermal insulation layer. Thermal insulating screens are recommended along the upstream slope [9] to protect the frozen zone from the heat of the stored water. Close contact between frozen and melted materials of the dam is achieved by such a slope of the

boundary surface so that the two zones, thawed and frozen, overlap.

Dam strength is determined by the shape of the interface of thawed and frozen materials and also by the volume of the frozen area compared with the total volume of the dam.

The necessary temperature of the dam should be established during construction. The dam foundation under the frozen zone should be reliably frozen. Underflow taliks must be frozen together with the foundation. The section of the foundation under the melted part of the dam should melt beforehand in order to decrease subsequent settlements (soil replacement is also possible).

By the time the storage reservoir is filled, the frozen zone should be fully or partially formed so as to make the dam impermeable during the initial years of operation.

Control of the dam temperature should keep the frozen zone within dimensions that prevent seepage. Cooling from inside is achieved by using vertical pipes through which cold air is pumped in winter. A refrigeration plant has been used successfully. Cooling is also possible by using horizontal pipes wells, and galleries.

Cooling from the downstream slope is done by removing the snow from the slope and building a wooden shelter to prevent: (a) Heating by radiant energy in summer, and (b) thermal insulation by snow cover in winter. The best effect is obtained by building snow and ice galleries on the downstream slope covered from above with moss, peat, and sawdust. These galleries are ventilated in winter and are protected from penetration of warm air in summer. With this the zone of changeable thawing and freezing (Fig. 1a) is eliminated or decreased, and this lessens deformation of the dam surface.

In most cases, the thermal inertia keeps the dam cool over the next summer. Therefore, arrangements to ensure added thermal inertia (stocks of ice, especially, salty ice) are not required.

The dam abutment to the valley flanks should provide direct contact between the frozen zone of the dam body and the permafrost of the slopes. The line of cooling boreholes in the dam should, therefore, continue toward the valley flank.

The storage reservoir water will necessarily thaw the ground by washing the valley flanks, causing a thawed zone. To decrease the undesirable deformation caused by thawing of upper layers of the valley flank (fissures, thermokarsts, landslides, etc.), it is useful to cover the valley flank in the dam embankment with a layer of soil (insulating screen). The thawed zone of the dam and that of the valley flank should merge.

Adjoining the impervious dams with other, pervious, structures is inherent to hydroelectric stations on large rivers with continuous taliks. In such cases the impervious earthfill dams sited on terraces above the flood plain should be connected to the pervious earthfill dams, spillways, powerhouses, or navigable locks located on the nonfreezing riverbed. All the built-in cooling elements of the structures (boreholes, wells, galleries, etc.) should guide the heat brought by infiltration to the junction.

Any seepage in a dam in which the frozen soil is used as a stable and impermeable material is dangerous and, therefore, should be avoided. To lessen damage by sudden infiltration, it is well to use a loam core and drainage in the frozen zone.

For emergency, it is also advisable to have a boring machine, a mobile refrigeration plant and pipes in reserve to freeze any sudden infiltration. A postsettlement repair of the dam may be needed to backfill the upper thawed zone in which settlement is most likely to occur.

Construction and long time operation of earth dams in which frozen soil is used as a strong, impermeable foundation proves that silty, ice-saturated soils with ice-lenses can serve as the foundation [5, 7, 10]. This practice pertains mainly to small dams with heads of about 10 m.

Generally, rockfill dams have the same temperature regime as earth ones. Therefore, the impermeable diaphragm in them should be built in the middle or on the downstream side. For an impermeable diaphragm, rockfill cavities should be filled with ice either partly or entirely over the zone of negative

temperatures. For better reliability a loam core should be used.

Cavities in the rockfill of the upper zone should be filled with crushed stone or soil to avoid convection which diminishes the zone's use as thermal insulation. Earthfill and rockfill dams appear to be more expedient than rockfill dams. The conditions under which they operate are rather close to those for earth and pervious dams. Unlike dams built for ordinary conditions in a temperate climate, the earth screen of earthfill and rockfill dams is a thermal insulator.

There has been much damage to dams built on permafrost, often resulting in complete ruin. Sometimes damage occurred because specific permafrost conditions were not considered. Until recently spillway and water outlets were the weakest points of any hydropower plant.

Fewer data are available on the design of spillways and water outlets than on the design of fixed earth dams; so developing basic principles for them still represents certain difficulties. Nevertheless, some general principles on these spillway structures can be stated.

It is preferable to place spillways outside the dam, and to use side channels for rapid flow. Rapid flow is best obtained by a flume on piles (Fig. 2). This decreases thawing under the flume from water heat during spillway operation and from radiant energy. Applying the rapid flow flume is also useful for a spillway arrangement in the dam body.

Outlets should be planned without gates. This considerably decreases warming of the spillway by storage reservoir water and by water that leaks through the gates.

Frozen and thawed zones of spillway dams, in which frozen ground is strong and impermeable, should join correspondingly with frozen and thawed zones of the adjacent dam built of local materials or of the valley flanks. With a concrete or crib spillway dam, the fill at the base of the upstream slope requires special attention. This fill is the thermal insulation of the dam foundation (Fig. 2a).

Stilling wells, cones of pressure relief, and other depressions in the downstream side should be avoided because they

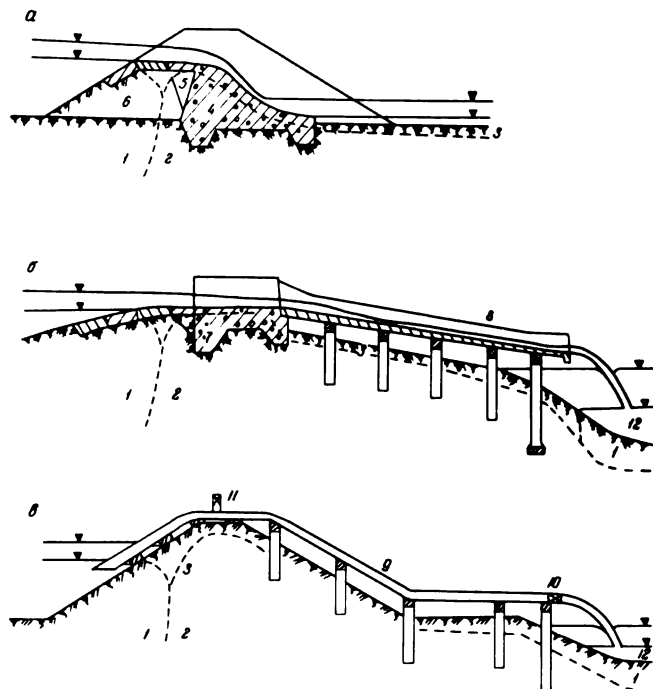

Fig. 2. Diagrams of spillways: a. Overflow dam. b. chute. c. siphon spillway. 1—zone of permanently thawed ground; 2—zone of permanently frozen ground; 3—zone of alternating thawing and freezing; 4—body of dam; 5—beam for strengthening surface of fill to prevent washing away; 6—fill, serving as heat insulation; 7—rim of chute; 8—trough of chute on piles; 9—conduit of siphon spillway; 10—downstream gate; 11—valve for shutting off siphon; and 12—erosion funnel

hinder proper cooling of the spillway structure in winter and may cause diminishing of the frozen zone for an inevitable decrease in dam strength. If these depressions cannot be avoided, water should be pumped from these depressions in autumn, i.e., before the freezing period.

Shelters above spillway dams help in cooling. In summer they protect the structure from sunrays, whereas in winter they prevent the warming effect of the snow cover.

It is advisable to use pipes for the spillway structure only when water is spilled from the reservoir by comparatively small discharges for a long time. The pipes should have a siphon at the inlet and valve at the outlet (Fig. 2a). Charging the siphon is done either by filling it or pumping air from it. The pipes, whether waste, water outlet, or water intake, should never cross the frozen zone of the dam. If it becomes impossible to carry the siphon through the dam (e.g., the crest of the dam is too high above the storage reservoir water level), water should be pumped through pipes. Water outflow from the pipes should be as far as possible from the dam.

To study the feasibility of building and operating a frozen dam built of local materials under particular climatic conditions, to develop thoroughly its design, and to control its thermal regime, it is necessary to predict the thermal conditions and regime of both the dam and its foundation.

Various methods have been suggested for predicting temperature fields of the dam and foundation. Thus for a steady state, calculations using conformal representation [11, 12] are suggested; while for a nonsteady state of homogeneous, pervious and impervious dams and foundations, the method of finite differences [13] and others are recommended.

An example of an approximate method for calculating dam temperature conditions is suggested by the Department of Soil Mechanics and Foundations headed by N. A. Tsytoich [14, 15]. N. V. Styrova took part in the development and calculations.

The method permits calculation of a nonsteady-state temperature field for homogeneous and heterogenous dams and foundations under any given boundary conditions with no seepage. A calculation chart of the dam and its foundation is shown in Fig. 3. The initial temperature of a heterogeneous dam (with three zones) is assumed to be 0°C.

Boundary conditions are determined by the natural conditions of the construction region.

The general solution of the temperature field of the dam and its foundation at any time involves solving equations (eight linear and one plane) from the theory of heat conduction. For linear problems the solution of the cooling of semi-infinite bar with side insulation [16] was used in sections 4-4 and 6-6 (Fig. 3).

For the linear problem, the depth of thawing in section 2-2 was determined on the basis of the work of J. Stefan and L. S. Leibenson [16].

Shifting the zero isotherm from the foundation toward the upper wedge, core, and lower wedges was determined by making up the thermal balance in the assumed time interval.

If the temperature field in the same zone but from different sides deals with different signs (thawing and cooling), then when the distance between zero isotherms becomes very small, the interface between thawed and frozen soils is corrected by calculation for each subsequent period of time.

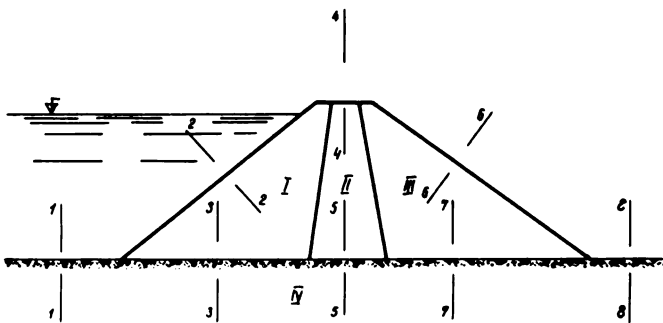

Fig. 3. Design of dam and foundation

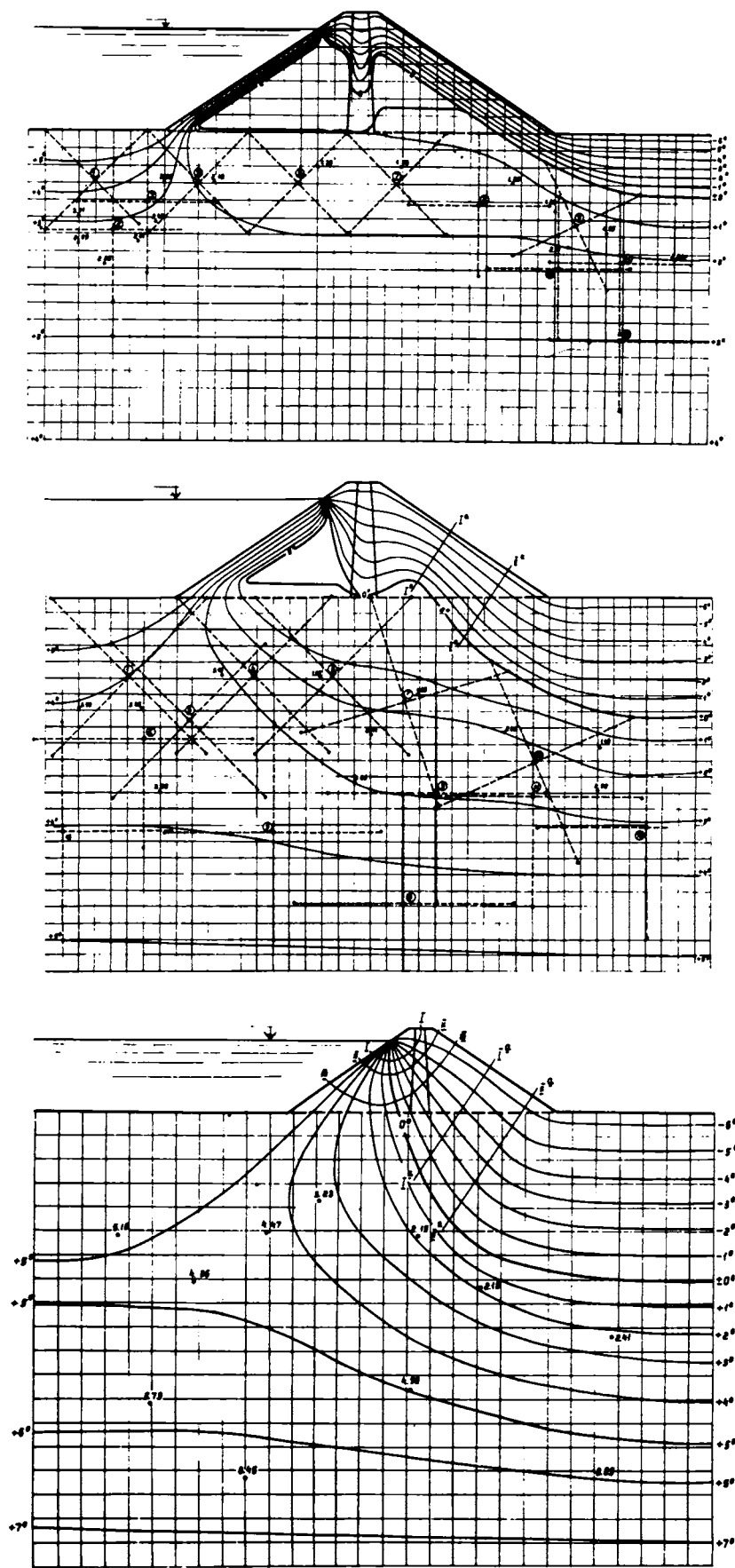

Fig. 4. Temperature changes in the body of the dam and foundation at various times after reservoir filling: I—5 years, II—20 years, III—75 years

Temperature distribution in the dam foundation was determined by the method of finite differences [17] using cross profiles.

The general outline of the nonsteady-state temperature field for each period of time is constructed graphically with curvilinear interpolation between points obtained from particular solutions (Fig. 4).

When calculating temperature fields of frozen earth dams, the mathematical method of the thermal conduction theory is sufficient.

When calculating temperature fields of frozen rock-fill dams, the formation of a temperature field is determined not only by laws of thermal conduction, but also by those of convective heat transfer. In this case the effective thermal and physical characteristics should be substituted in the above mentioned formulas, when these characteristics are determined experimentally for the dam and its foundation material for conduction and convection.

Illustrating the suggested method of calculation for periods of time ($\tau = 5; 20; 75$ years) since the storage reservoir was filled and on the basis of Styrova's calculation, temperature fields of a rockfill dam consisting of three zones were constructed as follows: Zone 1, rockfill and cavities filled with ice; zone 2, ice core; and zone 3, rockfill.

Analysis of these data shows that thawing of the lower part of the ice-core should be expected during the initial period of dam operation. Having derived, if required, an equation of thermal balance of the core thawing area and frozen part of the rockfill, the capacity can be determined of the auxiliary refrigeration plant required to keep the core frozen. With these data, designing the cooling system offers no difficulties.

The method of calculation is checked by modeling the temperature field of the dam and the foundation on the electrical or hydraulic analog computer and on physical models. The discrepancy between the nonsteady-state temperature field ($\tau = 75$ years) and the steady-state field obtained on an analog computer was no more than 1.5 to 2.0%.

The experiment with the physical model (Fig. 5) was conducted in a refrigerating chamber of the Moscow Institute of Construction Engineering.

Temperature was read using thermocouples frozen into the dam body and its foundation. The experimentally obtained temperature field was practically the same as the calculated one.

Most dams built in permafrost areas are low dams: Their height seldom exceeds 10 m. However, much bigger dams are urgently needed. Hydroelectric stations have already been built in Canada (on the Nelson River) and in the USSR (on the Mamakan River) [18]. The hydroelectric station on the Viluy River (USSR) [11] is now being built. Other dams are under design and construction in the USSR [7, 11], Canada [19], and Alaska [8].

The problems of building large dams on permafrost have not yet been studied sufficiently; thus, in such regions dams are built mainly on rock, when specific features of these regions are less obvious.

However, sometimes dams must be built on the subbase typical for permafrost areas, i.e., on silty, ice-saturated soils with ice-lenses. Although experience gained from small dam construction has advanced dam construction under northern conditions, present experience is still meager; both theory and practice of dam construction on permafrost urgently need development.

These are some of the many problems involved in building large dams: Dams planned on large rivers are frequently constructed on unfrozen ground that has been under water; in addition, such rivers have considerable underflow. The ground of the banks and in the area of the future storage reservoir is generally frozen. Under such complicated geocryological and hydrotechnical conditions of the frozen ground, the choice of the method of dam construction is of utmost importance. Problems concerning the design of the dam abutment to storage reservoir banks and prevention of water seepage around the dam should also be solved. Careful study is needed in design of spillway structures, locks, head- and tail-race channels, and their abutment to dams built by the cold method with

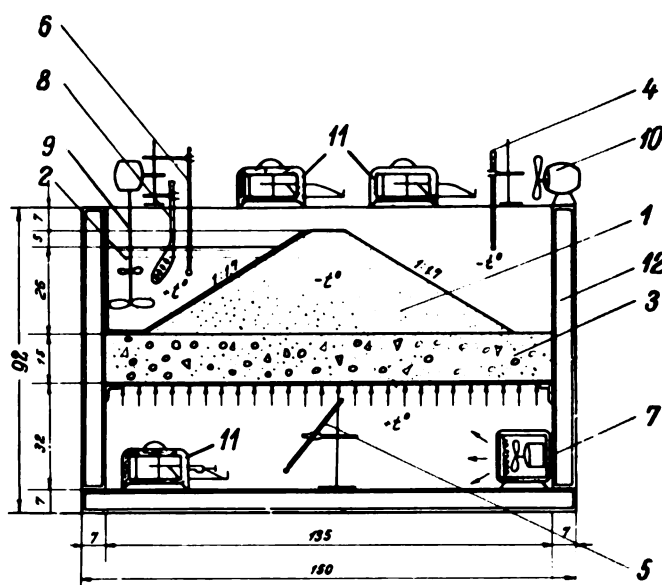

Fig. 5. Diagram of dam model: 1—body of dam made of fine-grained sand; 2—water; 3—concrete; 4—thermometer for air; 5—base plate thermometer; 6—water thermometer; 7—heat ventilator; 8—electric heater for water; 9—mixer for water; 10—ventilator for mixing air in chamber; 11—thermographs; and 12—foam plastic

frozen body and foundations.

Particularly important problems needing special attention are calculations on slope stability at the bottom of the side slopes of dams built according to the cold method (as well as for the warm method) and an understanding of the processes involved. For example, during construction of the dam by the cold method, lower layers placed at a flatter slope are recommended. For large dams a correctly designed slope has significant economic effects. Here, calculating the thermal regime of the dam is necessary. To solve really important problems in designing and building very large dams and hydro stations in extremely cold areas, an organization for the construction and operation of hydro stations built on permafrost should be consulted.

REFERENCES

- [1] Vodonasbzhenniye Zheleznikh Dorog v Rayonakh Vechnoy Merzloty, (edited by M. I. Sumgin, N. S. Geniyeva, A. M. Chekotiollo), Moscow, Transzheldorizdat, 1939. ["Water Supply of Railroads in Permafrost Regions," Transl. 28, USA Snow, Ice and Permafrost Res. Est. (now USA CRREL) 1955.]
- [2] S. G. Tsvetkova. "Experience with the Construction of Dams in Regions of Permanently Frozen Ground," in Materialy k Osnovam Ucheniya o Merzlykh Zonakh Zemnoy Kory, No. VI: Voprosy Inzhenernoy Geokriologii, Acad. Sci. USSR, Moscow, 1960, pp. 87-112.
- [3] A. V. L'vov. Poiski i Ispytaniya Vodoistochnikov Vodonasbzheniya na Zapadnoy Chasti Amurskoy Zheleznoy Dorogi v Usloviyakh Vechnoy Merzloty Pochvy, Irkutsk, 1916.
- [4] N. I. Bykov, P. N. Kapterev. Vechnaya Merzlota i Stroitel'stvo na Ney, Moscow, Transzheldorizdat, 1940.
- [5] G. A. Borisov, G. Ya. Shamshura. "Opit proektirovaniya, stroitel'stva i explanatatsii zemlyanykh plotin v Noril'ske," Sbornik Ma-lov po Inzhenernomu Merzlotovedeniyu, Acad. Sci. USSR, Moscow, 1959.
- [6] Ye. V. Bliznyak. "O proektirovanii i stroitel'stve plotin v usloviyakh vechnoy merzloty," Gidrotekhnicheskoye Stroitel'stvo, No. 9, 1937.
- [7] M. M. Grishin. Gidrotekhnicheskkiye Sooruzheniya, Moscow, Gosstroyizdat, 1962.
- [8] R. Monson. "Permanently Frozen Core for a Gravel Fill Dam," Contractors and Engineers, Dec. 1961.

- [9] D. Krynine, W. R. Judd. Principles of Engineering Geology and Geotechnics, McGraw-Hill Book Co., New York, Toronto, and London, 1957.
- [10] A. V. Stotsenko. "Ocbennosti Krupnogo gidrotekhnicheskogo stroitel'stva v zone vechnoy i sezonnoy merzloty na vostoke SSSR," Materialy po Inzhenernomu Merzlotovedeniyu, Acad. Sci. USSR, Moscow, 1959.
- [11] P. A. Bogoslovskiy. "Issledovaniya ya temperaturnogo rezhima zemlyanykh plotin v usloviyakh rasprostraneniya mnogoletnermerzlykh gruntov," Nauchnyye Doklady Vyshey Shkoly, Razdel "Stroitel'stvo", Moscow, No. 1, 1958, pp. 228-238.
- [12] P. A. Bogoslovskiy. "Raschet mnogoletnikh izmeneniy temperatury zemlyanykh plotin, osnovannykh na tolshe merzlykh gruntov." Trudy Gor'kovskogo Inzhenerno-Stroitel'nogo Instituta, No. 27, 1957.
- [13] I. S. Moiseyev. "Raschet temperaturnogo rezhima zemlyanykh plotin v rayonakh rasprostraneniya mnogoletney merzloty," Trudy Moskovskogo Inzhenerno-Stroitel'nogo Instituta, No. 29, 1959.
- [14] N. V. Styrova. "Vozmozhnost' stroitel'stva kamennykh plotin na vechnomerzlykh gruntakh," Trudy Soveshchaniya po Obmenu Opytom Stroitel'stve na Vechnomerzlykh Gruntakh v. g. Noril'ske v Noiyabre 1962, 1963.
- [15] N. A. Tsytoich, V. A. Vesselov, N. V. Styrova. "Issledovaniya vozmozhnosti explutatsii L'da po vodenepronit'soy pregradoy," Trudy Soveshchaniya po Voprosam Izucheniya Fiziko-Mekhanicheskikh Svoystv L'da v Gidrotekhnicheskome Stroitel'stve; Trudy Vasesoyuznogo Nauchno-Issledovatel'skogo In-ta Gidrotekhniki im. B. Ye. Vedeneyeva, 1963.
- [16] A. V. Lykov. Teoriya Teploprovodnosti, Moscow, Gostekhizdat, 1952.
- [17] N. S. Ivanov. "K voprosu o modelirovani teplotykh protsessov v pochvakh i gornykh porodakh," Teplo-1 Massobmen v Merzlykh Pochvakh i Gornykh Porodakh, Acad. Sci. USSR, Moscow, 1961, p. 5.
- [18] Bol'shiye Plotiny SSSR, Moscow-Leningrad, Gosenergoizdat, 1962.
- [19] Gidrotekhnicheskoye Stroitel'stvo, No. 2, 1963.
- [20] M. M. Krylov. Zamorozhennyye Plotiny, Merzlotovedeniye, Vol. 1, No. 1, 1946.
- [21] A. A. Sereda. "Opyt proektirovaniya gidrotekhnicheskikh cooruzheniy c dolgovremennym zamorazhivaniem grunta," Materialy po Inzhenernomu Merzlotovedeniyu, Acad. Sci. USSR, Moscow, 1959.
- [22] G. S. Shardin. "Modelirovanie teplovykh protsessov Soprovozhdayushchikhsya izmeneniyam agregatnogo sostoyaniya v sloistoyse," Ledotermicheskiye Voprosy v Gidroenergetike, Moscow-Leningrad, Gosenergoizdat, 1954, pp. 243-264.
- [23] "Western Construction," Alaska Newsletter, Nov. 1954, p. 90.

UTILITY NETWORKS IN PERMAFROST REGIONS

M. M. PORFIR'YEV, Academy of Public Utilities, Moscow-Leningrad
G. V. PORKHAYEV, Obruchev Permafrost Research Institute, Moscow

The severe climate in permafrost areas makes it necessary to provide maximum comforts for human habitation. Therefore, all modern facilities—water works, sewerage, central heating, power, as well as gas supply in a number of localities—are widely used. In some areas where natural fuels are scarce, all domestic needs, including heating systems, are electric.

The main problems in designing utility nets are dependability and continuous operation. Accordingly, their design and operating conditions must be chosen to prevent damage to the networks by soil subsidence after thawing, heaving, frost cracks, icing, and solifluction processes, and to preclude the possibility of freezing of fluids in pipes [1].

Construction costs in permafrost zones are three to four times higher than under usual conditions, and operation costs increase accordingly. Therefore, the economics of construction and the operation of these facilities warrant keenest attention.

Soil properties when frozen and after thawing, temperature conditions, intensity of the freezing and thawing processes, and specific climatic features of separate regions are extremely varied [2] over the enormous expanse of permafrost areas in the USSR.

There are no uniform answers for all construction problems of utility networks. Nevertheless, on the basis of research and practical experience, it has been possible to formulate the principle methods that consider local conditions, and specific technological features of the utility nets, warranting the application of particular designs.

Apart from the properties of the underlying soils, it is necessary to consider the possibility of damage to networks from heaving, frost cracks, icing, solifluction processes, etc. [2].

Construction methods for utility nets depend on the properties of the underlying soils and the type of the nets. If the mechanical properties of permafrost do not change upon thawing, the design must prevent the conduits from freezing.

In permafrost whose properties change abruptly on thawing, one of the following methods may be used, depending on intensity of the change and type of utility: (a) Maintaining the

ground in the frozen condition; (b) permitting the frozen ground to thaw during operation, within definite precalculated limits; and (c) thawing the frozen ground before construction, and subsequent consolidation or replacement of the soil by a calculated amount to preclude the possibility of pipeline deformation during operation.

Three principal methods of laying systems are applied. The method of laying also depends on the architectural and planning factors affecting the layout of the system in the building area, and in the last analysis, is determined by the combined technical and economical appraisal of the construction and operation factors [1].

Separate types of system are coordinated in a combined layout in passable (i. e., large enough to walk through), semipassable, and impassable channels (utilidors). Sometimes each net is laid separately, along the optimum route, and by the method most expedient for each.

Use of combined utilities in permafrost zones greatly reduces construction costs and increases dependability and operation costs. Separate systems may be recommended only when it is technologically impossible to combine them or when this would make the networks unjustifiably long.

Heat, water, low-pressure gas pipelines, power cables of up to 10 kV, communication cables, and air and product conduits are combined in common utilidors. For sanitary reasons, sewers may be laid only in separate compartments of the utilidors or outside in the zone of thaw produced by the utilidor.

The combined systems may be buried, laid on ground, or carried overhead on trestles. Ground-level and overhead nets are usually made with circumferential heat insulation. Sometimes ground-level nets are laid in reinforced concrete utilidors incorporated in sidewalks. Combined buried systems are laid in utilidors with a pathway made of prefabricated reinforced concrete elements.

Underground utilidors are laid at minimum depths to reduce the effect of heat on the soil during operation and reduce the amount of earthwork, and they must be provided with dependable waterproofing and water drainoff facilities. If there are many pipelines and cables, the utilidor is partitioned by a

vertical wall, i.e., divided into two sections, one for cables and one for sewers.

Without detailing the construction of utilidors, shafts, chambers, and control posts, we shall note the need for dependable ventilation of the utilidors in winter as the principal way to minimize the thawing effect of the utilidors on the frozen soil, with all its consequences.

In both combined and separate systems of utilities, it is essential to ensure the stability of ground support. In overhead systems, lines are carried on piles or trestles, although in certain specific instances, use is made of the constructional elements of buildings. In such cases, the methods are the same as for any other construction job.

Foundationless ("pulsating") supports are widely used in ground-level laying systems. These supports are either laid on the ground or sunk into it slightly. The "pulsating" supports repeat the movement of the ground surface due to seasonal freezing and thawing of the active layer. Pulsating supports may be used only if this does not endanger the safe operation of insulated steel pipelines [1].

Preparation of the support is the most difficult problem in laying buried utilities. When laid in subsiding soils, pipeline (utilidor) length and the possibility of nonuniform subsidence must be considered. Measures to prevent subsidence may vary along the length of the pipeline.

The permissible magnitude and nonuniformity of subsidence of pipelines depend on the material and diameter of the pipes (utilidor dimensions), and on the types of insulation and structural elements. If calculated deformations exceed the permissible value, measures should be taken to reduce or to eliminate them altogether. These measures can be preliminary thawing and compaction of the underlying soil to the depth of thawing at stable thermal conditions; removal of slumping soil and its replacement by non-slumping soil and additional laying of "clay-concrete" bedding; and in especially complex conditions, piles or other artificial supports are constructed.

The interdependence between building plan and network layout becomes especially critical when dwellings must be built on permafrost.

To improve operation conditions and reduce construction costs, the design of residential areas and neighborhoods should ensure maximum load on the length of any pipeline. Therefore, the length of each system and their aggregate lengths should be kept at a minimum.

A number of architectural and building methods, mostly of the perimetral type, have been developed to meet this demand and to ensure compactness of building with a general increase of its density. This reduces the number of branch and building connections, the weakest operational link.

When different planning variants and routes of utility networks are considered, especially such as water supply and sewerage lines, the layout should ensure that the greatest water consumers have constant circulation of water supply and adequate disposal of waste liquids. This creates stable hydraulic and thermal conditions in the pipelines.

When buried networks are laid in populated areas, their thermal effect on public roads and especially on basements of adjacent buildings must be considered.

The most important prerequisite for proper design of utility networks in permafrost zones is sound heat-engineering calculations. These calculations permit determining the temperature of the heat carrier along different pipelines laid by different methods, the temperature conditions in the utilidors, the conditions of the thawing and freezing of soil under the pipe (or under the utilidor with buried networks). Results of the calculations clarify and substantiate the adopted design and also determine the operating conditions.

Many researchers have investigated the interaction of pipelines and ground. As early as the last century, V. F. Zhukov developed a formula for determining the variation of the temperature of a fluid along the length of a pipeline. Zhukov's design formula includes an empirical [heat conductivity] factor (K). This factor is used to adjust for all the complex, unstable, thermal processes occurring in the soils, the thermal properties of soils, changes in the phase composition of water, the instability of thermal processes in pipelines, etc.

Later studies were concerned with a more precise definition of this factor. The heat conductivity factor varies, however, depending on the specific technological features of the transportation of fluids, the depth of the pipeline, its diameter and insulation, the thermophysical properties of the soils and their moisture, the heat conductivity conditions at the surface, and other factors.

For each combination of factors, a corresponding heat conductivity factor must exist; otherwise, the values of the heat conductivity factor (K) are of a particular nature, and may be applied in the thermal calculations of pipelines only when laying conditions, depth and diameter of pipelines, soil and hydraulic conditions, etc., are similar to the experimental conditions under which the heat conductivity factor was determined.

Many analytical solutions exist for determining K , however, based on the well-known Forchheimer's formula [2]. Because the design failed to consider fully enough certain factors (insulation, thermal gradient of the soil, etc.) computed results did not coincide with the data obtained by many researchers. This prompted studies aimed at a more precise definition of Forchheimer's formula, and resulted in the development of numerous variants.

The formula and its modifications give the mean value of heat losses, but do not reflect the dynamics of the process against time, which is sometimes essential for calculations. The formula for the radius of the thawed soil obtained on the basis of Forchheimer's formula also gives some mean value.

Heat loss from a buried pipeline may also be determined by the method of hydraulic and electric analogs or by direct simulation of thermal processes. Heat calculations by simulation methods are laborious and require special models and instruments.

The main tasks are determining temperature variation of the heat carrier along the pipeline length and the soil thawing and freezing around it. There are substantial differences in posing these problems and in their solution in seasonally or perennially frozen soils. Moreover, in view of the specific technological features of different types of utility networks, it is necessary to solve some specific problems.

SOME OF THE PROBLEMS

The following principal problems may be specified for different types of system.

1. For all water supply systems, it is essential to determine the variation of water temperature along the length of the pipeline. Specific features of water consumption involve solving heat engineering problems such as: Continuous and intermittent flows; determining maximum permissible stoppage time, optimal water heating temperature, and length of sections with independent heating facilities; and calculating initial conditions in the pipeline. Also important is calculating the aureole or depth of thaw around either pipes or utilidors when the conduits are laid directly in the soil. The heat calculations are based on the flow established by hydraulic calculations, but may need correction to allow for the necessary circulation and for additional runoff of water into the sewerage network.

2. For sewerage systems laid in permafrost zones either in soil or in utilidors, the amount of runoff from the hot water supply systems must be determined in order to prevent the freezing of liquid wastes. The specific feature of the heat conditions of sewerage networks is that the pipes do not run full because most systems operate by gravity.

3. Conditions must be determined to ensure minimum thawing of soils beneath the heat conduit or utilidor and to ensure minimum heat losses at optimum insulation thickness.

4. When gas pipelines (which now carry dehydrated gas) are used, it is necessary to establish upper-boundary dynamics of permafrost above buried pipes along the "hot" and "cold" sections. Determination of the upper surface of permafrost along the "cold" sections in isothermal gas flow is an auxiliary calculation designed to establish the effect of normal heaving forces on the pipeline.

5. When a drop in temperature is computed for oil along the length of its buried pipeline, the variation in oil viscosity and possibility of heavy-fraction deposits on the pipes at a freezing temperature must be considered. When oil pipelines are used to carry viscous oils, it is also necessary to compute heating temperature and thaw depth of the soil beneath the pipes.

6. For weak-current cables laid in frozen soils, computations should establish temperature fluctuations at the probable depth of the cable. For power cables, the halo of thawing around them must be computed.

A special problem is encountered if the period of pressure testing of various pipelines is done with water during the cold season.

Solution of the problems posed above is very difficult due to the great complexity of the process of heat propagation in soil. This is an unstable process, complicated by the phase transitions of the water contained in the soil. It is not now possible to solve the problem by strictly mathematical methods or by computers; it is necessary to seek ways to simplify the problem for each specific case. It is possible, however, to formulate certain general points common to solving most of the problems [3].

These points are:

1. Temperature fields in the frozen and thawed zones are quasi-steady state although their isotherms are moving.

2. Heat flux in the horizontal direction along the pipe (utilidor) is equal to the half-sum of heat fluxes directed upward and downward from the utilidor.

3. Heat transfer in the thawed and frozen zones of the soil is by conduction.

4. When heat is carried in the pipes by turbulent flow, the effect of its physical properties on the transmission of heat to the soil is determined by the internal heat conductivity factor.

5. Thermal gradients along the utilidor axis are many times lower than the thermal gradients in the direction normal to the axis.

These points have been largely confirmed by observation of thermal conditions in the soils around pipelines and serve as the basis for developing simple and sufficiently reliable methods of heat engineering calculations [3].

Besides these general points, special demands must be satisfied in the construction of individual types of utility systems.

When laid separately, a water system may be buried, laid on the ground, or carried overhead. With ground-level and overhead pipes, insulation is used. With buried pipelines, the zone of thaw formed around the pipes serves as insulation. It is assumed that the pipes are buried 0.8 m deep. Regardless of the type, the water pipeline must be protected from freezing. This is achieved by heating the water at pumping stations, as well as at intermediate points (in very long lines) and also by circulating water in all network sections. Appropriate pipeline layout and installation of gate valves provide for this.

Forced water circulation is achieved by redistributing flows over the different sections of the system, by directing water into reservoirs with subsequent heating, and by special circulation pumps that are switched on when consumption is low.

These intervals when water flow in the pipes may be interrupted are determined by calculation. The need to preserve the zone of thaw around the pipe must be considered in the calculations. In most cases, steel pipes with special freeze-proof fittings are used.

Generally, sewerage systems in populated areas are buried. Outside the building area, pipelines may be laid by any method. The sewerage network layout and the location of buildings discharging a great amount of liquid wastes are so designed as to ensure a constant flow of water.

When there is danger of water freezing in the pipes, warm return water is run off from the water supply or heat conduit lines into the sewerage system. The pipes are usually 0.8 m deep.

Manholes along the networks are made of prefabricated reinforced concrete components and are made monolithic and

further anchored in heaving soils. Steel pipes with welded joints and bell-flanged cast-iron pipes are used most commonly.

Heat networks have the greatest effect on permafrost. This must be considered in selecting the heat-carrier temperature, the pipeline system, and the design features. Circumferential insulation is used with ground-level and overhead pipelines. Buried pipelines must always be laid in utilidors; in slumping soils especially, utilidors must be made either passable or semipassable. In view of this, it is most desirable to combine the heat network with other systems.

Design of building connections depends on the method of construction (whether with or without maintaining the soils beneath the foundation in a frozen condition). Usually, the connections of heat and water conduits, and also of the sewage discharge connections, are combined in a single conduit. Overhead gas pipelines are the most expedient for the delivery of dehydrated gas.

Efficient operation is necessary for uninterrupted functioning of networks in the extreme north.

The design of utility systems should include instructions for the operation of individual facilities to ensure the required hydrological and thermal conditions by:

- (a) Incorporating appropriate gate valves and pumps.
- (b) Raising the temperature of the heat carrier.
- (c) Intensifying the circulation of water in the systems.
- (d) Controlling the pipeline seals and leaks.
- (e) Controlling temperature conditions in the utilidors when conduits and cables of different destination are laid in them.
- (f) Periodically checking and regulating operation of the ventilation of the utilidors.
- (g) Organizing maintenance and emergency work.
- (h) Operating the networks during emergency conditions.

In extensive utility networks, systematic observation of the soil temperature around the pipelines and utilidors is conducted to prevent breakdowns and damage, to establish the best operating conditions, and to gather data needed for further development. Maintenance personnel receive special training in construction and maintenance of structures on permafrost and in any special construction and operation features.

Rigorous and complicated conditions of permafrost zones lend special importance to an efficient management system for the operation of networks and reliable automated control by remote control devices. Such management increases operating efficiency by centralized control; by prompt reorganization of the system or its individual facilities; and by prevention, localization and elimination of breakdown in the shortest time possible. All systems should have a common control station for operating and relaying control signals.

The equipment of separate systems depends on volume and destination. The most complex and critical is the equipment of the water supply systems. In addition to the usual automation devices at the pumping stations where the water is heated, the pumping units should have automatic controls to adjust pressure variations in the network and water temperature at critical points. Moreover, the control room regulates the heating of the water and the gate valves in the hot water conduits. At water runoff points, gate valves must be automatically regulated.

Information on water temperature and flow velocity are automatically transmitted to the control station from all pumping stations, from water runoff points, from redistribution manholes, and from the most critical and dangerous sections of conduits and nets. In certain instances, the thickness of the ice formed on the wall within the pipes of big water conduits is monitored by remote control. Provision must be made for transmitting commands and signals by remote control. The information is recorded autographically. The maximum range of all telemetering systems is about 30 km.

All instruments (pickups) installed on the pipes and gate valves operate under heavy duty conditions. In view of the difficulty of preventive maintenance and checks, they must be extra sturdy and resistant to the effects of sharp tempera-

ture fluctuations and to high moisture. Similar remote control devices for temperature measurements and regulation of gate valves and pumping units can be used on sewers, heat conduits, and in utilidors. Moreover, automation in heating systems permits increased reliability through use of networks with bilateral supply to consumers and automatic regulation on connections, depending on heat consumption.

In view of the complexity of the construction and operation of utility networks in permafrost zones and the relatively scanty experience, it cannot be said that all problems have been solved. Many things still require additional research, prolonged observations, and design work.

Undoubtedly, the combined efforts of scientists and practical workers will yield positive results for the most effective

development of utility networks to ensure more comfort for human habitation in the extreme north.

REFERENCES

- [1] Inzhenernyye seti v usloviyakh vechnoy merzloty. Sb. Nauchnykh rabot pod redaktsiyey M. M. Porfir'yev, (Acad. Communal Economy), Moscow-Leningrad, 1962.
- [2] Osnovy geokriologii (merzlotovedeniya. Ch. II, Inzhenernaya geokriologiya, Acad. Sci. USSR, Moscow, 1959.
- [3] G. V. Porkhayev. "Method of Thermal Computations for Oil and Gas Pipelines in Freezing and Thawing Soils," Materialy k ucheniyu o merzlykh zonakh zemnoy kory, No. 8, Acad. Sci. USSR, Moscow, 1962.

HYDROGEOLOGY IN PERMAFROST REGIONS OF THE USSR

N. I. TOLSTIKHIN, G. V. Plekhanov Institute, Moscow

N. A. VEL'MINA and A. I. YEFIMOV, Obruchev Permafrost Research Institute, Moscow

Hydrogeology of permafrost areas has certain general, regional, and local features.

GENERAL FEATURES

These features develop under the following conditions:

1. Existence of the solid phase of underground waters, i.e., subsurface ice types, which differ in mode of occurrence and genesis. Frozen water bearing strata and separating impermeable beds are the most significant types. Veined, segregated, injected, buried, and other ice types are less important.

2. Division of ground water in the liquid phase relative to permafrost can be classified into water that appears (a) above the frozen zone, (b) immediately below the lower surface of the frozen zone, and (c) an intermediate category in the taliks within the range of the frozen zone. All three categories of the liquid phase of ground water are interrelated and governed by general hydrogeological laws.

3. Those conditions differing from the usual exchange between the surface and ground water because of permafrost. In circulating, ground water interacts closely with permafrost. Both intensity and character of the process are governed mainly by geological and structural peculiarities of the region and by relief and climatic conditions.

4. Variations of the existing correlations of frozen and unfrozen rocks and, consequently, the solid and liquid phases of ground water in time and space, are influenced by both natural and artificial factors. Of the many general natural factors, the thermal balance of the earth, conditioned by the life and activity of the sun, should be emphasized. Also a powerful thermal factor is natural water, both underground and surface. Human activity is considered as one of the most essential artificial factors. Natural and artificial factors radically change the basic hydrogeological indexes, e.g., redistribution of water in aquiferous horizons, changing of supply conditions, circulation and discharge of ground water, chemical composition, etc.

5. Permafrost distribution as well as its thickness and discontinuity by taliks (i.e., discontinuity of the frozen zone) develops differently in northern, central, and southern regions and is regulated by the laws of latitudinal zoning common for the earth and specific for the particular area. Latitudinal zoning appears here in that thickness and area of the frozen zone generally decrease from the north toward the south; therefore, the discontinuity increases in the same direction. This distribution of taliks by area and section is determined by hydrogeological conditions, geographical situation, climatic conditions, and history of the frozen zone formation. It is also different in platform areas (highlands, plains) and in geosynclinal regions (mountainous and folded regions).

6. Peculiar hydraulic and temperature conditions of ground water.

7. Chemical and gas composition of ground water.

REGIONAL FEATURES

Regions have the following geostructural features:

1. Platform areas and the fringing downwarps are characterized by the advantageous development of artesian basins of subpermafrost water connected with interstitial strata, fracture strata, and karst strata. On the whole, platform areas and the surrounding downwarps form systems of artesian basins, i.e., artesian areas containing basins of subpermafrost water of hydrogeological rock massifs.

2. Geosynclinal regions differ from platform regions in the broad development of basins or subpermafrost fracture-pressure and -veined waters of hydrogeological rock massifs. Inter-montane and other artesian basins, as well as superbasins of volcanic origin, are less important. On the whole, this system of various basins of fracture water with other dependent basins form hydrogeological folded areas.

Artesian areas differ from hydrogeological folded areas in peculiar frost-hydrogeological (geocryological) and hydrogeological conditions sustained regionally. This peculiarity is determined by different geological, topographical, physico-geographical and other factors, including geohistorical factors, which distinguish the artesian areas from those of hydrogeological folded ones. Detailed description of these areas can be found in recent literature.

LOCAL FEATURES

Local conditions influence geological structure of separate areas, thickness and cover composition of Quaternary deposits (alluvial deposits, etc.), impermeability of rocks, existence of recent deep faults, "karsting" of rocks, character of relief in the particular area, and climatic and other conditions.

COMBINED FEATURES

Combinations of general, regional, and local features extremely complicate the frost-hydrogeological situation of particular areas of the earth's frozen zone and general features of its latitudinal and vertical zoning.

Thus, the frost-hydrogeological conditions of some mountainous areas in southern Yakutia ASSR and in northern Transbaikalia are more severe than in some northern and north-eastern areas of the USSR. In the more southern regions, the frozen zone is rather thick and the subpermafrost water is found only at a depth of about 100 m. In some northern and northeastern regions of the USSR, however, subpermafrost

water is found rather close to or flowing on the surface—forming gigantic icings.

The whole complex of general, regional, and local factors considerably affects the supply of ground water and its circulation above and below frozen rocks and within the range of the zone. In addition, this complex also determines the intensity and character of the circulation and helps form the chemical composition of ground water and its discharge.

It is presently accepted that underground water in permafrost areas comes mainly from above, i.e., by penetration of atmospheric precipitation and ground water deep into the earth. Atmospheric precipitation forms suprapermafrost water and ground water in both mountainous and plain areas. Penetration of ground water into the deep-seated subpermafrost water-bearing horizons, i.e., water absorption, depends on distribution of frozen and thawed rocks (taliks) and is determined by general, regional, and local conditions.

The very deep subpermafrost water-bearing horizons are fed mainly by infiltration of surface water under large rivers and lakes and of sea water under seashores. The most favorable conditions for river-water absorption are created when the river possesses a powerful flow throughout the year and when the sedimentary rocks composing the river banks and the bed are permeable enough to provide adequate water circulation. This, in turn, will prevent formation of permafrost in rock massifs. Under-river bed taliks formed on those sections function all year. The most favorable sections of river-water absorption are fault zones, especially in karst rocks with accompanying fractures extending in different directions. Circulation of this water in rock-fracture zones forms the most stable and permanent taliks. By a combination of fractured tectonic zones and zones of permeable alluvial deposits covering the fractured tectonic zones, optimum conditions are created in river beds to feed the very deep water-bearing horizons. Even without these conditions, permafrost can exist under large rivers. For example, Lena River borings revealed perforating taliks on the sections with a favorable combination of conditions, whereas, permafrost occurred on other sections at a depth of 30 to 50 m.

When other conditions are equal, the number of taliks under small rivers (inflows of second order) tends to be limited. Under such conditions, the inundated tectonic faults become very significant in absorption of river water. If there are no favorable conditions for the under-river bed flow, then the rocks under small rivers are frozen, and there cannot be subsurface drainage in winter.

The main areas of ground-water discharge, together with those of absorption (supply), occur in river valleys, especially where deep downcutting of valleys exists. Optimum conditions for discharge will be at intersections of valleys with tectonic fractures.

In the permafrost area, tectonic fractures drain the very deep ground water more effectively than outside the frozen zone.

The subaqueous type of ground-water discharge is characteristic of valleys in all regions. In this case, polynyas, i.e., nonfreezing sections of a river with open water, are formed in winter. Even when the discharge of subaqueous springs is small and there is a thick series of deposits, the ground water can drain under the river ice or penetrate into alluvium. If the combination of surrounding conditions does not favor preservation of under-river bed flow (thin layer of alluvium, low air temperatures, etc.), ground water will flow onto the surface of the river ice or bank (when ground-water discharge occurs on the valley slope), forming icings. Thus, many subaqueous discharges of ground water, hidden by a layer of river water in summer, are revealed in winter. Ground-water discharge in mountainous regions also occurs at the contacts of rocks of different ages, composition, and permeability.

The similarity of optimum conditions for supply and discharge of ground water is not spontaneous. All conditions favorable for supply and circulation of ground water are also suitable for their discharge. Therefore, supply and discharge of ground water often proceed in the same section or within

the same valley. Supply of ground water near the southern border of the permafrost zone also proceeds by the watershed taliks. Meanwhile, the discharge runs more freely because the taliks, except those on the valley bottom and river bed, encroach on terraces and sections of valley slopes.

Interaction of sea water and the land is characteristic of the sea coast of northern regions. Both rate and character of this interaction depend on geological and tectonic conditions, rock composition, and other factors. Penetration of sea water deep into the shore can be seen for many kilometers, and is extremely high in the zones of great, Recent tectonic faults.

ARTESIAN AREAS

Frozen zones are developing within the following artesian areas of the USSR: (a) The east European area, covering the extreme northeast; (b) the Pechorsky area, which occupies more than half of its territory (on the north); (c) the west Siberian area, on the north of the region within the range of the Prikrask artesian basin; (d) the east Siberian area, ranging all over the territory; and (e) the entire Yano-Kolymsk area.

Each artesian area comprises a combination of open-type artesian basins and differs from other artesian areas in its specific geocryological features. Each artesian basin within the area has "regional" similarity with other basins of the area but differs in some aspects.

Distribution and characteristics of permafrost depend very much on hydrogeological features of the artesian basin. The presence of frozen rocks exerts a considerable and different influence on supply, circulation, and discharge of ground water. This influence is manifested in many ways; due to freezing, the supply and discharge areas of the ground water are sometimes eliminated completely or decreased substantially. Small storage areas of ground water can stop functioning (become completely frozen), and thus force the powerful storage areas to retain more water. Partial freezing of water-bearing horizons can change the value of the former pressure.

Temperature of water-bearing horizons will probably influence the hydrodynamic and hydrochemical features of ground water because water density, viscosity, and solvent abilities will change considerably within the range of 0° to 4°C.

The specific character of the influence of permafrost on ground water is different for artesian basins in various areas. Thus, artesian basins south of the permafrost area are characterized by a thickness of the permafrost within the range of 25 to 100 m and rock temperatures from 0° to -1°C. Within the area of these basins, the permafrost zone is intermittent, and the taliks downcut the permafrost not only under river beds and lakes but also on some watersheds. Downcutting of frozen strata on water divides is characteristic where plain surfaces of watersheds are composed of an insufficiently thick or very permeable layer of loose eluvium or talus with underlying porous or fissured sedimentary rocks in which water-bearing horizons occur.

Summer atmospheric precipitation falling on such watersheds infiltrates sedimentary rocks, warms them, and either prevents them from deep freezing or considerably decreases freezing. With sufficiently deep erosive cutting, the existence of intermittent permafrost in the upper hydrodynamic zone of intensive water exchange does not prevent its normal operation. Therefore, water-bearing horizons can be supplied over a wide area at the expense of (a) surface water by under-river bed and under-lake bed taliks and (b) atmospheric water by the watershed taliks. Here the total supply area of artesian horizons is somewhat decreased. These fields become more concentrated, and the importance of tectonics is more evident.

Numerous subaqueous ground-water storage areas lead to the formation of icings or of nonfreezing polynyas. Runoff from artesian basins and intensity of water exchange are considerable. Many constantly active springs of fresh water and highly bicarbonated water in the USSR attest to this, despite the presence of a frozen zone of 100 to 150 m. The aquiferous state of some of these springs exceeds that of the

springs under similar hydrogeological conditions outside the permafrost area. The discharge of such a spring reaches 6 to 10 cu m/sec during the "critical point" of the year, i.e., during the period of maximum freezing of the ground, before the spring thaw.

The degree of intermittency of the permafrost zone influences the chemical zone. Where the zone is less intermittent, and therefore, the intensity of exchange between surface and ground water is slightly decreased, mineralized waters—including the sodium-chloride ones—usually occur rather close to the surface. In areas with a considerable water exchange, the fresh water zone reaches about 100 m.

In the central and northern parts of the permafrost area, where the thickness of the frozen zone reaches 300 to 500 m and sometimes even 600 m and where the temperature at a depth of 15 to 20 m drops as low as -4 to -8°C or lower, the intermittency of the frozen zone will be substantially decreased. In most cases, the continuous talik sections will become concentrated mainly under the beds of large rivers and lakes, if the beds are composed of permeable rocks. Bed-rocks composing the artesian basin are frozen; therefore, the circulation conditions of the water-bearing horizons, especially of those located immediately under the permafrost, will become worse. The effect of the cryogenous head, caused by the freezing of very deep water-bearing rocks, acquires special significance. Meanwhile, there is considerable inundation of water-bearing horizons and their associated deep freezing. In regions characterized by aquiferous, fissured, or heavily karsted rocks, the frozen zone has a thickness considerably less than that expected. In wide areas of central Yakutia, where permafrost thickness reaches 300 to 400 m, there are sections in which fresh water-bearing horizons are found as deep as 50 to 100 m. This is due to the closeness to the surface of water-bearing strata of fissured, porous Cambrian limestone.

Wide distribution of very thick, impermeable permafrost makes the discharge of ground water acquire some special features. Most discharge areas in the south zone are connected with sections where deep erosive downcutting of river valleys is associated with considerable tectonic disturbance.

A very interesting phenomenon, not yet fully studied, is observed within the Yakutsk artesian basin. The piezometric level of subpermafrost water is broken up by boreholes well below the nearest large river level and even lower than sea level. A suggestion has been proposed that at present the frozen zone of the region is being degraded, a modern filling of artesian basins occurs, and the water of some water-bearing seams does not discharge onto the surface of the ground. This is explained by the thaw of former thick layers of frozen rocks from below.

The subpermafrost water occurring next to the permafrost and also in nonsaliferous rocks is usually characterized by a slight mineralization (up to 1 to 2 g/liter) with sodium bicarbonate, or bicarbonate-sulphate mixture.

The presence of saliferous strata sharply changes permafrost conditions. Thus, in many regions of east Siberian artesian areas, where Paleozoic depositions with high salt and gypsum content are widespread, the ground water possesses an increased and high mineralization, often reaching dozens (at depths, even hundreds) of grams per liter.

The cold belt of the earth is remarkable in having two zones within it: The upper-frozen zone, sometimes reaching 300 m, where all the rock pores and fissures are filled with ice and are therefore impermeable, and the lower zone about 100 m thick and more where rocks are cooled from 2° or 3°C below zero to 0°C . Considering that the ground water is highly mineralized, the rocks are not cemented with ice, and therefore still possess water-bearing features. Availability of negative-temperature ground water in the liquid phase is one of the specific features of some regions of the area under consideration.

HYDROGEOLOGICAL FOLDED AREAS

Hydrogeological folded areas of east Siberia, north and north-

east of the Asiatic part of the USSR, are completely included in the frozen zones. Besides, there are separate frost-bound areas of different size in Altai, Tien-Shan, and the Pamirs. Depending on the intensity of rock freezing, the ground water of Quaternary deposits, fractured zones, and crusts of weathering, fissured as well as veined fault water, provides transition from the liquid into the solid phase, and thus is excluded from water circulation. According to the most recent data, freezing is believed to have penetrated to about 900 m. Freezing of hydrogeological folded areas closely affects ground water, disturbing its relation to surface water, water exchange, etc. Except for atmospheric and surface water supply, mountainous areas are characterized by supply at the expense of condensation of water vapor in large-blocked hillside wastes formed where exceptionally high rock disintegration, caused by sharp air temperature fluctuations, exists.

The most favorable conditions for circulation, supply, and discharge of subpermafrost ground water are related to the fractured rocks located in the zones of Recent tectonic movements.

The hydrogeological folded areas, where intermontane and other artesian basins of various types and sizes are located, differ considerably from the area without artesian basins. The contacts of such inland basins with their bordering crystalline and metamorphic rocks of hydrogeological massifs are often of tectonic nature—by the full perimeter or in one or two basic directions. They are accompanied by thrusts or faults. Water is abundant within the zone of tectonic rock jointing. The tectonic fractured zones with feathered joints often extend down into the hydrogeological massif. In this case, supply of the marginal rocks of the massif will most frequently proceed at the expense of the artesian basin waters. For instance, water from the Chulman artesian basin supplies a large rift zone, passing along the south border of the Aldan crystalline massif. Here, at a distance of several kilometers within the range of crystalline rocks, the discharge of fracture sulphate water, formed in the bowels of the Chulman artesian basin and migrating within the overlap zone of Jurassic and Archean rocks, can be observed.

Discharge of subaqueous springs in this area may often reach hundreds of liters (several cubic meters per second) during the critical period of the year. The karst basins of the Verkhoyansk-Kolyma hydrogeological folded area probably play a similar function in supplying the fracture and vein water of tectonic faults cross-cutting rocks of the Paleozoic and surface complex.

Abundant water in crystalline and other rocks, with no relation to the basins, is in many cases similar to what was mentioned above and is associated with the zones of rock crushing and also to nonfreezing taliks under river beds, oxbows, and flood-plain terraces. As a rule, the aquiferous state of the rocks is not the same. This is proved by the heterogeneous composition of rocks and is distinctly manifested in sections where rocks of different permeability change one into another. In such a case, discharge of the springs is about 30 to 60 liter/sec. Valleys composed of fissured bedrock and under-river bed alluvium freezing in winter are characterized only by temporary seasonal springs that supply the icings at the very beginning of winter (October to November).

Under-river bed flows of such valleys are extremely small or absent. Water abundance on the contact of the crystalline and sedimentary rocks may be relatively increased. In the mountainous areas of the northeast USSR composed of rocks of the Verkhoyansk complex representing a sandy-schistose stratum and effusive rocks, the discharge of springs under the most favorable conditions may reach 1000 to 3000 liter/sec. In winter, a considerable portion of the flow adds to the growth of the perennial icings that have a thickness of 3 to 5 m, are many kilometers long, and have an area of dozens of square kilometers. The water source of the gigantic icings in northwest USSR is being discussed at present.

Water temperature of the ground-water storage areas in winter, as a rule, is close to zero and does not exceed 1°C , except in some large storage areas where it reaches 5° to 6°C .

A high water temperature with small spring discharge is indicative of the presence of well-washed and relatively straight routes of water circulation at great depths. Of course, it is not a question of thermal springs where high temperature is caused by the presence of Recent faults and also by their close location to Recent volcanic foci.

When other conditions are equal, the temperature of the majority of the northern subpermafrost springs is below 0.2° to 0.6°C, whereas in the south of the permafrost rocks, the temperature is above 0.4° to 1°C.

Artesian water systems of joints are formed during freezing of hydrogeological massifs, wherein the frozen zone serves as an impermeable roof. Such impermeable joints form the basins of subpermafrost water somewhat similar to the artesian basins. Therefore, there is every reason to distinguish such permafrost hydrogeological structures as cryogenous joint pressure-head basins. Among the cryogenous basins of joint pressure-head water of the Verkhoyano-Kolymsk hydrogeological folded area, the large and complicated basin of the Momo-Selenyakhsk depression should be noted along with others smaller in size. These basins are now being studied.

The stated features of the hydrogeological conditions of the artesian basins and hydrogeological folded areas located within the permafrost region should always be considered when prospecting or using ground water.

Within the permafrost region of the USSR, ground water of various origins is distinguished, such as that of surface recharge. This occurs at the expense of atmospheric precipitation, river, lake, and sea water, as well as sedimentation, juvenile and condensation water. Ground water can be either old or recent water.

Interaction of solid and liquid phases of ground water throughout the development of permafrost (repeated freezing and thawing of rocks) changes the water features of rocks, water redistribution in aquifers, and separating rock masses. In addition, it also leads to the change of pressure and piezometric levels, chemical composition, and physical properties of ground water. All these processes proceed against the general background of the development of water exchange between ground and surface water and also between the permanently and seasonally frozen rocks. In addition, they

determine distribution of ground-water storage areas (the temporarily stationary solid phase and nonstationary liquid phase) and their change in time and space.

Basic theoretical principles of hydrogeology on USSR permafrost areas are briefly covered in this report. Although we are not familiar with the American generalized works on hydrogeology in which the laws of supply, circulation, and discharge of ground water have been presented, consideration of the following items would be interesting and important:

1. To what extent the hydrogeological laws of the USSR areas of permafrost correspond to those in North America;
2. To discuss the principles of hydrogeological zoning and function of the frozen zone in formation of the hydrogeological features of the defined structural units;
3. To consider the problems of prospecting and exploring ground water in the defined hydrogeological structures and basins.

REFERENCES

- [1] N. A. Vel'mina, V. V. Uzemblo. Gidrogeologiya tsentral'noy chasti Yuzhnoy Yakutii, Acad. Sci. USSR Publ. House, Moscow, 1957.
- [2] A. I. Yefimov. "Podzemnye vody v mnogoletnemerzlykh porod vostochnoy chasti Sibirskoy platformy," from the collection Doklady k sobraniyu mezhdunarodnoy assotsiatsii gidrogeologov, State Geol.-Tech. Publ. House, Moscow, 1960.
- [3] A. I. Kalabin. "Vechnaya merzlota i gidrogeologiya Severa-vostoka CCCP," Trudy Vsesoyuzn. nauchno issled. in-ta, t XVIII, Magadan, 1960.
- [4] Osnovy geokriologii (merzlotovedeniya). Chast' 1, Obshchaya geokriologiya, Acad. Sci., USSR Publ. House, Moscow, 1959.
- [5] V. M. Ponomarev. Podzemnyye vody territorii s moshchnoy tolshchey mnogoletnemerzlykh gornykh porod, Acad. Sci. USSR, Moscow, 1960.
- [6] N. I. Tolstikhin. Podzemnyye vody merzloy zony litosfery, Geol. Publ. House, Moscow, 1941.
- [7] P. F. Shvetsov. Verkhoyansko-Kolymskaya gornaya strana kak osobaya merzlotnaya gidrogeologicheskaya provintsiya, Publ. House All-Union Geogr. Soc., Vol. 79, No. 6, Moscow, 1947.

DISCUSSION—SESSION 8

SANITARY AND HYDRAULIC ENGINEERING

LARS-ERIC JANSON—For people working on sanitary and hydraulic engineering projects in cold regions, it is often necessary to try to solve basic research problems, because the problems are fairly new and little research has been done in this field.

The intention here is to deal with water supply systems in cold regions with special reference to distribution systems and to relate this subject to Swedish conditions.

Sweden is situated (between lat. 55° and 69° N.) in the same latitudes as Alaska. In spite of the latitude, we have no actual permafrost regions. This effect, *inter alia*, is due to warming by the Gulf Stream. However, in the north of Sweden the seasonal frost in ground which is kept clear of snow penetrates to such a depth that resulting problems are very closely related to those occurring in permafrost regions.

The problem may be divided into three parts, depending upon the climate of the region. In the middle parts of the temperate zones, the problem is insignificant, since it is both practical and economical to lay the pipes at a depth which is below the greatest seasonal frost penetration.

Within permafrost regions, the problem is not so simple, for, as is well known, the ground is frozen to a very great depth during the winter. Nonrunning water cannot exist as a liquid, and it is necessary to compensate artificially for the heat losses which otherwise would cause formation of ice in the pipelines.

However, the problem is even more complicated in areas situated between these two regions, *i.e.*, within regions where the mean annual air temperature is close to freezing point. Normally, the seasonal frost penetrates between 2 and 3 m below a snowfree ground surface. In such cases, my investigation shows that only a slight and transient change in annual heat balance of the ground may displace the annual mean ground temperature; consequently, the frost depth may increase from the normal depth of 2 to 3 m to considerably larger values. Such a change in the heat balance may be due to a transient change of climate—*e.g.*, cooler summers and more severe winters. It may, however, also be due to a seasonal change in the heat constants of the soil. The heat transfer to and from the ground is proportional to the square root of the thermal conductivity and the specific heat of the soil. Thus, if the soil is dry during summer, thermal conductivity and specific heat will be low; consequently, heat transfer to the ground will also be reduced. If soil is moist during the following autumn due to extensive precipitation, the thermal conductivity and the specific heat will become greater;

consequently, heat losses from the ground will be greater.

The result is that within areas where water pipes normally do not freeze, if they are laid with a cover of 2 to 3 m, considerable trouble may arise, since under unfavorable conditions, the pipes will freeze. Such conditions may occur at any time.

Thus, large areas bordering the permafrost regions need artificial power to keep water pipes from freezing during unfavorable conditions. Either recirculation or electrical heating can be used.

To analyze these problems in Sweden, measurements of ground temperatures and soil constants are being made at 21 Swedish stations. Temperature is measured with resistance thermometers; thermal conductivity is measured according to the nonstationary heat flow method by thermal conductivity probes. The purpose is to draw frost depth maps for Sweden, especially with regard to the economical depth for laying water mains. At each station, frost depth, thermal conductivity, and moisture content of the soil are measured in four different verticals (two in bare soil and two in snow-covered soil). The relations between thermal conductivity, moisture content, and density for current soil material are determined at the laboratory. In each measurement section, there are 5 to 10 probes placed horizontally, from the ground surface to a depth of 2 to 3 m below the ground surface. At certain stations probes are also placed in position above the ground surface making it possible to determine the temperature and thermal conductivity of the snow. The temperature is determined once a week and the thermal conductivity, as well as the moisture content, four to five times per year. As a rule, the stations are situated near the meteorological stations of the Swedish Meteorological and Hydrological Institute (SMHI) from which the climate describing magnitudes are obtained. By determining the lowest temperature of the ground as a function of the depth below the ground surface, as well as the duration of these temperatures, the most important factors are obtained concerning the calculation of heat losses from a water pipe at any depth whatever below the ground surface in all types of cold regions.

When the amount of compensating heat that must be added to the water pipe is known, we will have to choose an adequate heating system. The simplest way is to keep the water running in the pipes by bleeding at certain points of the distribution system. Other methods are forms of recirculation (with or without artificial heating of water) and heating of water pipes by electrical heating cables or electrical distribution wires. Many papers presented for Session 8 gave descriptions of these methods.

SESSION IX EARTHWORK AND FOUNDATION ENGINEERING

PLACER MINING IN FROZEN GROUND

E. H. BEISTLINE, University of Alaska

Gold, won from the frozen placer deposits of the Klondike, Yukon Territory, Canada, touched off a stampede of men into the Northland in 1898 that seldom has been equaled. Prospectors and miners searching for gold and other valuable minerals and metals in buried alluvial deposits of sand and gravel (placer deposits) encountered new and unusual mining conditions in the winter cold, short summer season, and permafrost [1]. Miners could not bypass permafrost if they were to recover gold from the frozen deposits.

During and after the rush to the Yukon Territory and Alaska, permafrost proved to be an asset. Its good ground support to walls and roofs of the openings permitted deposits to be exploited where difficult ground-support conditions existed.

High-cost underground methods have been replaced by revolutionary surface earth-moving equipment in placer mining. Permafrost adds to cost of surface mining, although often it is helpful in giving better prospect drill results and mining control. Modern placer mining includes thawing of deposits before excavation because machines have not yet been developed that will dig frozen placer gravel economically.

Phases of placer mining affected by permafrost are reviewed rather than mining methods which may be found in mining literature. The following generalized description of placer mining aims at providing a perspective from which to view various phases of such mining.

A typical, buried, frozen placer deposit in interior and northwestern Alaska is illustrated in Fig. 1. The overburden often has passed through several cycles of freezing and thawing, is usually loess made up of fine-grained particles (84 to 88% are finer than 250 mesh [2]), and does not contain precious metals. Some loess, grayish black in color and rich in organic material, is termed muck [1, 2]. Some samples of overburden have as much as 75% moisture although many samples from the Klondike indicated an average of about 44% by weight. However, the amount is variable and ice masses are common [3, 4]. Overburden depth is usually less than 100 ft although greater depths do exist.

Heavy mineral concentrations are not found in the overburden, but remains of Pleistocene animals such as the mammoth, mastodon, and saber-tooth tiger exist. Beneath the overburden is frozen gold-bearing creek gravel that contains

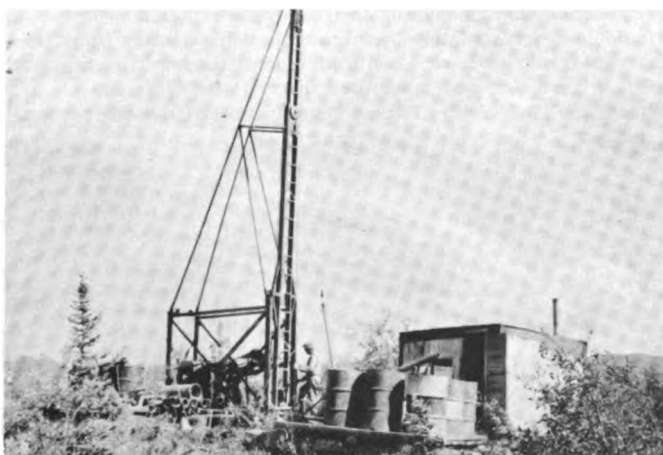

Fig. 1. A churn drill used for exploration of placer deposits

varying amounts of ice (10 to 12% by weight [4]) which is usually less than 100 ft deep although some deeper deposits have been mined. Heavy metals and minerals may be found in the gravel, but often a concentration (paystreak) is found on or just above bedrock.

Mining the deposit consists of outlining economic mining limits by exploration (usually drilling); obtaining and developing a water supply; removing the overburden (stripping) from the deposit by hydraulic or mechanical means; thawing the gold-bearing gravels by cold water, steam, or solar methods; and excavating, transporting, and washing the gravels to recover the heavy metals by mechanical (tractors, draglines, pumps, sluice boxes), and hydraulic methods or dredges, or both. Underground placer mining, known as "drift" mining, consists of sinking a vertical shaft to bedrock, thawing a relatively small depth of gravel and bedrock, perhaps to 6 ft, mining by long wall retreating, hoisting the material to the surface, and sluicing it to recover the valuable products.

PROSPECTING AND EXPLORATION

Basic data to determine feasibility of mining is usually obtained from frozen placer deposits by drilling, shaft sinking, or surface trenching. Drilling and shaft sinking may be done throughout the year except during very cold and severe weather. Frozen surfaces facilitate the movement of equipment.

Drilling

Churn drilling that does not use circulating water still is the conventional method of sampling frozen placer deposits in Alaska (Fig. 1). Advantages of churn drilling in frozen ground are: (a) Casing is not required; (b) there is less sloughing and "salting" of samples, and (c) volumes may be measured accurately.

The technique used to measure the volume of drill holes in frozen gravel consists of adding known increments of cold water (0.25 cu ft) to the vertical section of the drill hole through a hose to prevent wall sloughing, measuring the rise of the water with a float fastened to a surveyor's chain; again adding water, then continuing the cycle until the water reaches the top of the pay horizon. In the volume and value calculations, adjustments are made for water seepage entering the hole during the time of measurement.

Rotary drilling (using liquid or air for removing cuttings) and augering have been in limited use for prospecting frozen ground. Recent successful use of such types of drilling by research agencies and industry indicates the possibility of using such techniques in placer exploration.

Shaft Sinking

Prospect shafts, 4 ft by 5 ft, wood cribbed, are sunk through frozen material by breaking the permafrost through hand picking, thawing, blasting, or boring holes of large diameter. Thawing, with steam, often generated in small prospect boilers, has been used more than other methods. A minimum of timber for ground support is required.

Trenching

Excavating trenches in alluvial deposits by hand, mechanical

equipment, or hydraulicking allows complete vertical sections to be exposed and sampled. When surface overburden on the trench area is removed, the gravel thaws by heat or the atmosphere. Thawed material is excavated and a fresh face is exposed for thawing. Economic trenching depends upon exposing sufficient frozen material to the atmosphere to provide enough thawed material to keep equipment working at maximum capacity.

WATER SUPPLY

A copious water supply, essential to placer mining, is brought into the mining area by pumps and pipelines, or by ditch systems from streams, rivers, or reservoirs.

Ditch

Miners avoid permafrost whenever possible during ditch construction. They can do this somewhat by locating the excavation on southern slopes exposed to the sun. A system cut in frozen material can become insulated by the thawing and compacting of site material. Sealing and added insulation may be increased by precipitating solid particles of soil added upstream. Water velocity must be sufficiently slow to prevent erosion [5].

Ice masses in ditch systems are conducive to ditch breaks because a small trickle of water cuts the ice and surrounding frozen material and causes the destruction of large sections of ditches in a short time. When ice masses are encountered, they are excavated to a depth of several feet, then the ditch bottom is filled to grade level with alternate layers of moss and gravel. Continuous surveillance is necessary to prevent ditch breaks.

Flume

Flumes or pipelines may be used to bridge difficult permafrost areas. Provisions must be made to prevent water leaks from undermining supports by cutting permafrost.

Reservoirs

Dams are used to store water for stripping, thawing, and mining. Many are earth dams that are easy to construct, have relatively small capacity, and are seasonal or temporary in nature. Ice masses as well as structures (penstocks, waste gates, and spillways) that rest on frozen ground should be insulated against thawing.

An exception is an earth fill, frozen core dam that has a usable capacity of 6000 acre-ft, length of 1640 ft, height of 75 ft, and top and bottom widths of 22 and 340 ft, respectively. Such a reservoir was a part of a \$1.3 million water system (built by Callahan Zinc and Lead Co.) for placer mining operations on Livengood Creek. Construction began in 1941, was interrupted by World War II, but was completed in 1946. Hess Creek dam was built on a permafrost foundation of gravel and bedrock and was anchored to the frozen material by freezing a center core [6, 7]. This was done by removing the overburden to foundation grade and installing pipes in the mass of the dam on both sides of a center longitudinal line of sheet piling to carry a low freezing liquid. Freezing was done by circulating a low freezing liquid (Stoddard) during winter months and thus using winter winds to keep the Stoddard below 32°F.

Freezing rate was determined by thermistors during the initial hydraulic fill, but these became unusable during the final stages of roll-fill construction. The dam was entirely satisfactory for water storage although occasional ice-wedges developed in tension cracks in the upper portion of the dam to depths below water level in the frozen core. These were removed by hand excavation and the voids were filled with dam-site material.

Water was transported to the mining area by a 3300 ft tunnel that was constructed through about 300 ft of frozen muck and 3000 ft of frozen gravel. The tunnel was excavated by sinking three shafts (maximum depth 150 ft) along the centerline of the tunnel and driving tunnel openings at both ends. Conventional drift-mining methods were used. These con-

sisted of steam-thawing the gravel and hauling thawed material to the surface through shafts and drifts. A 42 in. dia. redwood pipe was installed in the tunnel to carry the water. Tunnel portals were sealed during summer and opened in winter to allow cold air to circulate and refreeze gravels that thawed during summer. Water leaks and caving in the intake end of the tunnel, which was in frozen muck, required alteration in construction and continued maintenance. The portion of the tunnel in gravel required added maintenance only because of conditions created at the intake.

Design features of the dam are being presented at this conference by O. W. Simoni in this volume.

REMOVAL OF OVERBURDEN (STRIPPING)

The frozen loess-muck overburden can be removed by water and mechanical equipment during thawing at summer temperatures.

Water Stripping

Hydraulicking—Hydraulicking uses water under pressure which usually flows through steel pipelines and nozzles for caving and transporting muck and gravel (Fig. 2).

Efficient removal of frozen overburden requires that a large area be cleared of vegetation and exposed for thawing. About every 24 hours the thawed material is washed and carried away in suspension by water.

For large-scale operation, a series of nozzles with tips of 2.5 to 4 in. in dia. and with working pressures of 50 to 120 psi are arranged so that the working radius of each nozzle does not overlap others. If considerable ice is present, a continuous spray of water may be used [5]. During the 1963 mining season, Harold Schmidt (Ballerette Mines, Yukon Territory) used a typical irrigation spray for removing muck with apparent success.

Field tests on thaw rate of muck in the Fairbanks area show the following results, although such rates vary greatly with the composition of the material and temperature [5]: Depth of natural thaw was 1 in. for 1 hour, 2 in. for 4 hours, 3 in. for 12 hours, and 4 in. for 24 hours.

Best water duty (cubic yards of material moved per unit of water) is obtained when about 4 in. of muck is available for transporting. Water duty varies greatly, but may average about 20 cu yd per miner-in./day [5]. In Alaska one miner-in./day equals 1.5 cu ft/min flowing for 24 hours. Hydraulic stripping is usually confined to five months (May to October) in interior Alaska.

Blasting of muck overburden (at operations of U.S. Smelting, Refining, and Mining Co. near Fairbanks) is somewhat advantageous in conjunction with hydraulic stripping. More surface area is created by blasting large chunks and hence thawing is expedited. The average water duty, in cubic yards of material broken per pound of explosive (40% gelatin) for large pieces, was 9.91 cu yd in interior Alaska during one season. Distributing explosives in several small charges rather than in a single large charge gave best results. Holes in the muck for the explosives were made with a conventional cold water point of 0.75 in. using water supplied from nearby hydraulic lines [5]. The depth of holes varied to place the charge near



Fig. 2. Hydraulic stripping of muck overburden to expose underlying frozen gravel and sand

the center of the large chunks of muck and usually were less than 20 ft deep.

Drains to carry overburden in suspension from stripping areas to major river drainages are essential and usually are cut by removing surface vegetation from the drain line and then controlling a water flow on the permafrost. Generally, the drain is cut through the frozen overburden in a series of falls that retreat toward the intake of the drain, setting the final grade on the underlying gravels. Blasting and picking may be necessary to control the direction and width of the finished cut. Preferably, the drain should be straight, with long radii where curves are necessary, and a minimum grade of 0.15%. Small, crooked, existing streams should not be used [5, 8]. If sand is carried in the drain with the muck, it must be prevented from entering river channels. This is done by collecting the sand in a sump in the drain form where it is removed by a scraper or dragline.

Ground sluicing—Ground sluicing uses flowing water not under pressure to cave and transport muck and gravel. Water from a stream or reservoir may be confined to cutting a narrow channel to gravel as in constructing a drain. Flowing water is then directed toward the overburden face, causing the muck to cave into the stream. The method may be adapted to meet local conditions of water supply, frozen material, and type of overburden.

MECHANICAL

Excavating permafrost overburden, per se, is not practical for placer mining in Alaska. Surface vegetation is usually removed, allowing a thin layer of permafrost to thaw; then thawed material is removed so that thawing can continue more rapidly. This is done with various combinations of tractors and dozers, draglines, shovels, conveyors, etc. As with hydraulic stripping, a large area must be exposed to allow maximum equipment use.

In recent years, tractor-mounted or tractor-pulled rippers have been used by several mine operators to break the overburden and thus increase the stripping rate.

Combination

It is possible to use various combinations of excavating material with mechanical equipment and then perform the hydraulic lifting. As an example, an open-cut coal mining operator blasts the frozen sandstone and then hydraulicks the material from the area. Often, some overlying gravel is pushed into the drain, and this requires mechanical equipment to help the water transport the sandstone and gravel.

THAWING

Frozen placer deposits must be thawed before pay gravels can be excavated and valuable metals and minerals released and recovered. Thawing methods first began with wood fires and developed through hot rocks, steam, water at natural temperatures, and solar thawing.

Heat requirements for thawing gravel—The practical miner soon recognized that some types of frozen ground could be thawed faster than others. Charles Janin's analysis [9] shows the importance of ice content with reference to energy required for thawing. About 81.3% of the total energy required to raise a typical sample of frozen gravel (12.1% ice content by weight) from 20° to 36°F was used in converting ice to water at 32°F.

Besides ice content, other factors affecting the energy required are particle size, insulating qualities of the thawed material, and temperature of the thawing media. If conditions are equal generally, frozen gravel can be thawed much faster than frozen muck.

Wood fires—Originally, wood fires were used to thaw overburden and gravel while sinking and driving prospect shafts and drifts in northern Canada and Alaska [10]. Usually a fire

was set next to the face to be thawed, and heat was directed by green wood or mucking plates to give maximum thaw and minimum sloughing of walls and roofs. Time for thaws depended upon physical characteristics of the ground, but often fires were set to burn through the night and provide a maximum thaw of about 20 in. Although thawing with wood fires was crude and relatively inefficient, it did stimulate the mining of frozen gold placer deposits.

Hot rocks—Miners heated rocks on the surface and lowered or threw them into the opening to thaw the surrounding material when conditions of excess ice and poor ventilation would not allow thawing by wood fires. The cooled rocks were hoisted to the surface for reheating while the thawed gravel was excavated. The method was used only as a final expedient because of the increased work involved in heating and placing the hot rocks and hoisting the cooled rocks to the surface [10].

Hot water—Hot water was used in several ways for thawing frozen gravel. One method was to force hot water through conventional steam points which were driven deeper into the gravel as the water performed its thawing effect. Driving of drifts was facilitated by forcing hot water through nozzles toward frozen faces of gravel, causing thawing and sloughing of the material [10]. Hot water is used in pilot points to punch holes for lighter pipe called "steam sweaters." Advantages claimed are less sloughing of roofs and more rapid thawing rates [11]. Hot water was also poured into a shaft to thaw the gravel. For example, one shaft was sunk at the rate of 2 ft/day using three thaws, each thaw requiring 15 gal of water. Water is left in the hole for about 2 hours before excavating the thawed material [12].

Steam thawing—The wood-burning boiler that produced steam for thawing, hoisting, and some power, was the principal unit of underground as well as surface placer mining plants during early gold-rush days. Some miners still use this process.

Underground [4, 10]—The first steam points in the Klondike were developed after miners observed the rapid rate of thaw of frozen overburden caused by steam escaping from a hoist engine. Initially, rifle barrels were used as steam points because of their immediate availability and sturdiness, but by 1899, in Dawson, more efficient points were designed and became widely used [10].

Steam was commonly generated at boiler pressures varying from 90 to 110 psi and transmitted through insulated pipe lines (2 to 4 in. dia.) down the shaft and through the main drifts to the working faces in the crosscuts.

Points spaced 2 to 4 ft apart and driven horizontally into the face by sledge hammers were usually 10 ft long and 0.75 to 1 in. in dia. At some mines pilot points were used to penetrate the permafrost and then were replaced with 0.25 to 0.375 in. sweaters. Steam pressure for driving was usually about 80 psi, while steam pressure for sweating was often about 40 psi. Time required for steaming varied with ground and plant conditions, but many operators steamed for 9 to 12 hours and then allowed more thawing to occur by soaking for another 12 hours.

Surface—Steam was used to thaw surface deposits for dredging in Alaska and the Yukon Territory, but this method has been replaced by the cheaper cold water thawing technique. Points as long as 40 ft were used for deep surface thawing and were arranged in batteries of 150 points and supplied with steam from boilers rated as high as 150 hp [9].

Current practice for early spring dredging often requires shallow steam thawing of seasonal frost for several weeks. Points and sweaters used in units of 30 to 60 points are 7 to 10 ft in length and are spaced in equilateral triangles about 7 ft on a side. Steaming for 8 to 12 hours is usually required, with steam being furnished from shore or dredge boilers of 40 to 90 hp.

Cold water thawing [3, 8]—About 1915, experiments consisting of thawing frozen gravel with water at natural temperatures were begun in the Yukon Territory and Alaska. The results of these experiments indicated that two methods, the Miles and Pearce, offered excellent possibilities for thawing frozen gravel at relatively low cost because artificial heat is not supplied to the ground. Of these two, the Miles method has become standard with dredging companies.

Miles method—Essentially, this method circulates water through a network of pipes and points that penetrate the frozen gravel (Fig. 3). Water enters the ground at about 50°F and returns to the surface at about 35° to 38°F; it is warmed by the atmosphere before being returned to the points.

In a typical operation a centrifugal pump is used to circulate water, although water is obtained under pressure from a ditch system occasionally so that a return circulatory system is not required. Each point uses about 5.5 gal/min of water at a pressure of 20 to 40 psi.

The points are usually of extra heavy wrought iron pipe 10 ft long, 0.75 in. ID, with a chisel bit and a water outlet on each face of the bit. Additional 5 or 10 ft sections are coupled to give the desired depth, which can be 60 ft. Points are arranged in 16 ft equilateral triangles and are usually hand driven. A clamp is fastened to the pipe and a 24 lb hammer slides up and down around the pipe, striking a blow to the clamp. Water flows through the point during driving and each point is driven periodically through the thawed material and not forced against permafrost. Driving rates may average 10 ft/manhour.

Point-driving machines that use a 0.5 hp electric motor to raise a weight by a cam have been successfully used (USSR & M. Co., Fairbanks, Alaska) in mining operations. This method requires stronger pipe couplings and points because the bit is always working against frozen material.

When thawing begins, water is returned to the surface adjacent to the point. As thawing progresses, the thawed gravel tends to pack around the pipe, causing a "free" zone to form at the contact of frozen and thawed ground. Water flowing in this zone is in direct contact with the frozen face and hence increases thawing rate. The water cycle is maintained until the thawed ground from one point reaches the area of influence of other points.

Complete thawing is determined by checking the centers of certain triangles. This is done by probing with a 0.75 in. steel bar, or by using temperature pipes and thermocouples. A rule for estimating gravel thaw time in the Fairbanks area is that each foot of depth requires about 1.25 to 1.5 days [8].

When thaw is complete, the points are removed, straightened, sharpened, and redriven in other areas.

Gravel has been successfully thawed in the Fairbanks area to depths of 110 ft by drilling holes with churn drills to bed-

rock during the winter [8]. Pipes 1.5 in. in dia. are placed in the holes which are in a pattern of equilateral triangles from 25 to 32 ft on a side. During the summer months, water is pumped into the point, and thawing occurs. Often, three seasons of pumping are required to adequately thaw the frozen ground.

Pearce method—This method has had limited use, although initial experiments were favorable. A shaft is sunk into bedrock near the downstream side of a deposit at the lowest elevation. Water is spread over the surface and tends to flow on the frozen-thawed contact and to collect in the shaft. A few points driven to shallow depths are sometimes used to add water to the ground, especially at the extremities of the area to be thawed. Water that collects in the shaft is pumped to the limits of the area to be thawed, from whence it again runs toward the collection point.

Solar thawing—Solar thawing has been effectively used by both dredge and small-scale operators in Alaska [13]. Essentially, the method requires the removal of all muck overburden to expose frozen gravel to the atmosphere for one or several seasons. Gravels to depths of 20 ft have been thawed successfully for dredging, but layers of clay on the surface of the gravel may inhibit thawing.

Solar thawing is used exclusively in small-scale operations. Overburden is removed and pay gravel is pushed into sluice boxes as it thaws.

Thawing techniques—Charles Janin [9] presents gravel-thawing experiments conducted by J. H. Miles and described by W. S. Weeks. Miles compared efficiency of thawing frozen gravel by superheated steam, saturated steam, warm water, and cold water. Four holes were drilled to depths of about 40 ft, and then the respective thawing media were introduced at the bottom of each hole by conventional methods. Upon completion of thawing, shafts were sunk on each drill hole and the thawed material was excavated and measured. Results showed that of the total heat applied in each experiment, the following percentage of useful thawing was accomplished: Superheated steam 4%, saturated steam 6%, hot water 12%, and cold water 57%.

Cold water thawing has proven to be the most economical method for large-scale thawing of frozen gravel in Alaska.

UNDERGROUND HYDRAULICKING

An excellent experiment by USSR & M. Co. in mining a frozen placer deposit was conducted near Fairbanks by underground hydraulicking in 1936 and 1937 [14].

The mine was developed in a conventional manner, and stopes were mined using water under an average pressure of 40 psi to thaw and carry the pay gravel through the sluice box. Coarse tailings were hoisted to the surface, and fine tailings were pumped out of the mine. Water was recirculated underground. The results of the experiment indicated:

(a) Water could be used to thaw, mine, and transport the material in one step, and considerable steam thawing could be eliminated.

(b) Water temperatures could be controlled so that water at 43° to 45°F would break the frozen material from the face, and water at 35° to 37°F would transport the material and at the same time add wall support by decreasing roof slough.

(c) Stopes opened for an excessive period of time may have roof caving because of zones of weakness in the gravel from thin layers of muck and sand and a minimum of ice. Local subsidence began when an area of 5000 to 6000 sq ft was opened.

FUTURE RESEARCH

Methods must be found that allow more volume to be moved at lower cost if placer mining operations are to be expanded in scope and number. Research is essential and should be directed toward both underground and surface methods of exca-

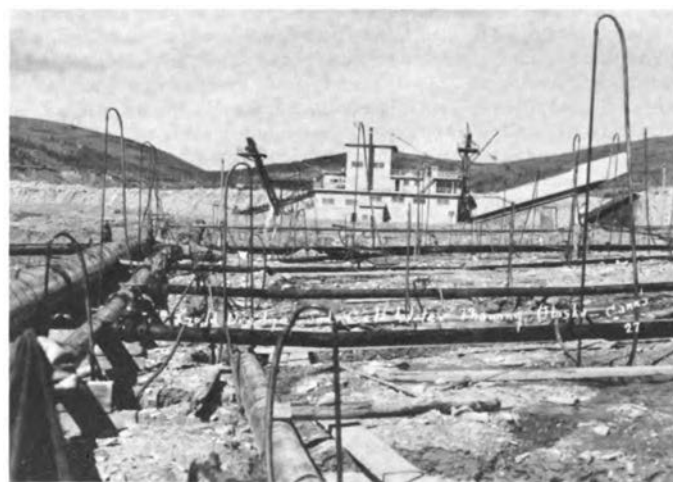

Fig. 3. Cold water thawing of frozen material by circulating water at normal summer temperature (dredge in background)

vating large volumes of frozen gravel and overburden at low cost. Thawing cost, by use of water at atmospheric temperatures, could be greatly reduced if more efficient methods of inserting points into frozen ground could be developed.

Forward-looking research programs today will allow many permanently frozen submarginal placer deposits to be mined tomorrow.

REFERENCES

- [1] T. L. Péwé. "Permafrost and Its Effect on Life in the North," 18th Biol. Coll., 1957.
- [2] "Stripping Frozen Muck," Mining World, Aug. 1942, pp. 14-19.
- [3] A. D. Roberts. "Preparation of Frozen Alluvium of Interior Alaska for Gold Dredging," unpubl. thesis, Univ. Alaska, May 16, 1932, p. 10.
- [4] U.S. Bureau of Mines. "Placer Mining Methods and Costs in Alaska," Bur. Mines Bull. 259, 1927.
- [5] J. C. Johnston. "Planning and Operation of Hydraulic

Stripping Plants," unpubl. thesis, Univ. Alaska, May 1948.

- [6] B. I. Thomas. Priv. comm. June 1963. U.S. Bur. Mines, Fairbanks.
- [7] "Livengood, A Daring Attack upon an Arctic Mining Problem," Mining World, May 1942, pp. 25-29.
- [8] "F. E. Company Thawing," ibid., Dec. 1942, pp. 13-17.
- [9] C. Janin. "Recent Progress in the Thawing of Frozen Gravel in Placer Mining," Bur. Mines Tech. Paper 309, 1922.
- [10] G. A. Metcalfe. "The Evolution of Placer Mining Methods in Alaska," unpubl. thesis, Univ. Alaska, June 1, 1929.
- [11] W. Vuicich. Priv. comm. April 1963.
- [12] E. Wolff. Unpubl. data, Univ. Alaska, 1956.
- [13] E. N. Patty. "Some Placer Mining Methods in the Subarctic," Eng. Mining J., Vol. 146, No. 4, April 1945.
- [14] T. A. Loftus, J. M. Andregg, H. B. Harris. "Report on Underground Hydraulic Licking, Chatanika Flats, Shaft #1, #2930," USSR & M. Co., permission from J. D. Crawford, 1937.
- [15] T. A. Loftus. "Cold Water Thawing," 5th Alaska Sci. Conf., Alaska Division, AAAS, 1954, pp. 112-115.

PILE FOUNDATIONS IN PERMAFROST

FREDERICK E. CRORY, U.S. Army Cold Regions Research and Engineering Laboratory

Foundation design in permafrost areas must differ in many important respects from foundation design in temperate climate because foundations in these regions, when constructed on frost-susceptible soils, are subject to considerable heaving and subsidence caused by the freezing and thawing of the underlying soil. Of the considerations essential to the design of building foundations in permafrost areas, many are applicable to all foundation types; but particular emphasis is given to the development of design criteria for pile foundations. Results of field tests and observations from which the design criteria were derived are briefly presented, where appropriate.

FOUNDATION REQUIREMENTS

Two major considerations in the design of foundations in permafrost are: (a) Minimizing disturbances in the thermal regime, and (b) providing for the heave and subsidence from the freeze and thaw cycles of the active layer and any degenerate thawing of the permafrost. The disturbance of the normal thermal regime beneath and adjacent to a foundation on frozen soil depends on disturbances to the surface cover, construction methods, drainage, exposure, heat loss from the structure, and many other factors peculiar to each location and foundation design.

These factors [1, 2] are responsible for the immediate and long-term effects of the structure on the permafrost. Changes in the thermal regime produce corresponding changes in the strength properties of the soils supporting the structure. Unfortunately, uniform settlement of the structure is rare because of variations in the soil and ice conditions and differential thawing resulting from surficial factors. Differential settlements associated with nonuniform thawing and heaving are the major cause of damage to plant equipment and structures in permafrost areas.

Transfer of building heat can be reduced effectively by an air space between floor and ground surface through which outside air circulates either naturally or artificially. Buildings with an air space may be supported by posts founded on footings or pads, ventilated rafts or mats, or piling. Gravel or other nonfrost-susceptible fill may be used beneath and around the footing or raft to maintain thermal balance of the underlying permafrost and to reduce thawing of underlying frost-susceptible soils. Under certain conditions, a gravel fill, with an air space, can limit the seasonal thawing and freezing to its own thickness, thereby raising the permafrost table and eliminating frost-heave displacements.

Ventilated pile foundations have been demonstrated to be an effective foundation type in potentially troublesome permafrost, particularly in fine-textured soils that frequently contain large amounts of ice. Such soils, in contrast to clean sands and gravels, usually have very large void volume changes and little or no strength upon thawing. However, a pile foundation adequately embedded in underlying permafrost is a stable support and is unaffected by vertical displacements associated with the freezing and thawing of an unstable active layer.

The supporting capacity of piles in permafrost is attained by the adfreeze bond developed between the soil and the pile surface. However, the adhesion and corresponding load capacity of piles in permafrost is temperature-dependent, unlike foundation piles in unfrozen ground. Although piles in frozen soil can be end-bearing, on bedrock or consolidated sands or gravel, evidence to date indicates such support is negligible in fine-textured frozen soils having a high ice content.

Construction examples that effectively use principles of permafrost preservation are the 230 by 260 ft ventilated pile foundations for the Composite Buildings at Bethel and Kotzebue, Alaska. These structures were built by the U.S. Army Engineer District, Alaska, in 1955-1956 and are each founded on more than 900 timber piles; Bethel in relatively warm, 30°F, silty sand and Kotzebue in cold, 25°F, silt with large ice masses. The design, construction, and performance of these structures are given references [3-7].

INSTALLATION METHODS

Pile foundations have been used for more than half a century in the Arctic, but the evolution of installation methods to minimize permafrost disturbance is recent. Most of the earlier piles were local timber, installed in steam- or water-thawed holes. The normal depth of embedment, however, rarely exceeded 20 ft. Equipment used to thaw the holes consisted of 3/4 to 1 in. pipe, fitted with various nozzles. Generally, piles were merely pushed or lightly driven into place. In some cases, restraint was required to prevent the flotation of the piles in the mud-like soil until freezeback began. Spacing of piles in many early structures appears to have been dictated by unit pile load structural requirements of the building rather than by ability of permafrost to absorb the heat evolved in the installation.

Installation of piles by steam thawing is seldom used today in Alaskan building except by the Alaska Railroad [8] and at

some remote areas, although it is widely used in many parts of Canada [1]. Test piles installed with steam at the Alaska Field Station at Fairbanks have yielded sufficient data to assess these former construction practices. Today, soil exploration and ground temperature observations provide data necessary to evaluate building design and performance for rate of freezeback and long-term changes in thermal regime. Such investigations and observations were unheard of 20 years ago.

Present-day pile installation techniques in Alaska utilize the most modern drilling equipment and effectively control permafrost disturbance. Installation methods are determined by the type, temperature, and ice content of soils and the embedment depth necessary for each pile type. Installation methods that can be selected to match the foundation requirements and the soil conditions are:

1. Steam thawing—pre-thawing a hole in permafrost, either larger or smaller than the pile, and "driving" the pile in place [1, 8, 9].

2. Bored hole—rotary drilled holes, formed by various bits, barrels, etc., using air or water, and "driving" piles in undersized holes or "slurring" back in oversized holes [9, 10].

3. Dry augering—similar to above; but holes, either undersized or oversized, are formed using augers with special bits capable of holes to 4 ft dia. to depths in excess of 75 ft [3, 4, 5, 9, 11].

4. Driving—conventional or modified temperate zone pile-driving techniques (including the use of vibratory hammers) without hole preparation [9, 12, 13].

5. Various combinations and modifications of the above—for example, steaming pilot holes and driving or driving piles in dry-augered holes previously filled with selected soil.

Each method has special merit in relation to permafrost conditions, unit costs, and the ultimate or sustained adfreeze bond strengths. Evaluation of each method should consider the amount of heat (both sensible and latent) that must be absorbed from the slurry or steamed hole and its relation to pile spacing. When using steam or slurry in relatively warm permafrost, it may be necessary to use artificial refrigeration for freezeback by circulating suitable fluids or gases through pipes or tubing attached to the piles.

Normally, positive artificial freezeback can be achieved in less than two days by careful control of the slurry temperature and water content, and time permitted between augering, slurry placement, and start of refrigeration. With conventional driving, construction can be continuous because of the negligible amount of heat evolved. Under certain soil and temperature conditions, open-ended pipe and H-sections can be readily driven in permafrost, even to depths of 50 ft [9, 12].

PILE TESTS

The need for a comprehensive study in foundation design and construction in permafrost became clear during World War II when unsuitability of temperate-zone techniques were demonstrated. Systematic studies of piles in permafrost were initiated just after the war, at the Alaska Field Station, Fairbanks, using timber piles in steam-thawed holes. However, this early study produced little conclusive data, because most test piles failed structurally during extraction, and little information existed as to the ground temperatures during the test periods [14].

The first comprehensive investigation of piles in frozen ground was initiated by the Corps of Engineers at the Alaska Field Station in 1952. Four pile types were used: Timber, steel pipe, reinforced concrete, and structural steel sections. Although about one-fourth of the test piles were first installed with steam, most were installed in wash-bored holes. This was the first attempt to control both the amount of heat introduced by the installation method and the type and condition of the soil immediately surrounding the pile. Wash boring was done by the use of a special core barrel operated with a circulating water system on a conventional rotary drill [9]. In this method, holes of preselected diameters were advanced to the desired depth and then bailed dry.

The test piles were positioned in the holes and a soil-water

mixture or slurry, was placed in the annulus between the pile and the reformed hole. Thermocouple assemblies attached to the outer surface of the piles were used to measure ground temperature during freezeback, testing periods, and at various times throughout the following years in each of two identical test areas. Sixty-four piles were installed and the results obtained have been presented in interim reports [15, 16].

Although considerable information was accumulated from these two test areas, many aspects of the performance of piles in frozen ground still remained obscure. A large number of test piles failed structurally at the higher extraction loads rather than by a progressive soil-pile bond failure. Similarly, insufficient data were derived for correlation with sustained loads since most of the extraction tests were conducted relatively fast (many of the tests were completed in less than a day). The need for further pile tests was apparent long before the completion of tests in these sites.

More elaborate studies of installation techniques, freeze-back, frost heave, and pile capacity were initiated in 1957 with installation of Pile Site C at the Alaska Field Station [11]. Potentialities of natural freezeback were systematically explored by utilizing the maximum cold penetration in permafrost during early spring. Thermocouple assemblies attached to piles were observed daily for a month or more after installation to provide the necessary data on the rate of freezeback for various hole sizes, slurry types, and pile shapes. All of the 97 piles in this site were installed in dry-augered holes and backfilled with silt- or clay-water slurries, water (ice), or dry sand. Hole diameters were at least 2 in. greater than the pile size to permit the use of a concrete vibratory for slurry placement. As in pile sites A and B, the spacing between piles was 20 ft to minimize the interference of nearby piles during freezeback.

The development of design criteria for piles in permafrost began with tests to either isolate or correlate the factors affecting load capacity. These factors were installation method, soil type, pile type, length and shape, point bearing, permafrost temperature, and effects of rate of load application.

The factors were considered in the following manner: First, the various pile types and sizes—creosoted timber (either butt or tip down), 6 and 8 in. pipe, 6 and 10 in. H-sections—were divided into groups and installed in dry-augered holes using various backfill materials. Before the control groups were tested, another group of piles installed in exactly the same way was subjected to failure loads at different rates of load application. This series of tests was necessary to establish a proper rate of loading that would provide data directly applicable for design and which could be standardized for use in pile tests at other sites in support of construction.

To isolate the effect of loading, the 12 piles were subjected to 10 kip load increments at intervals of 0.1, 2.5, 24, 72 hours, and 7.5 kips/week to failure. Half of the group was tested at an average permafrost temperature of 30.5°F, the other half at 25.1°F. These tests formed the basis of the

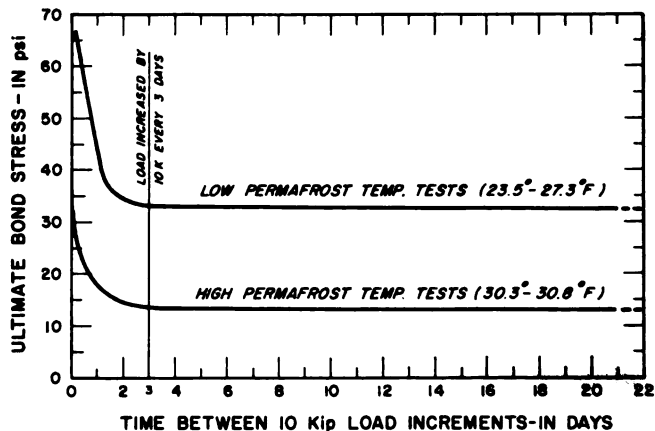

Fig. 1. Effect of rate of loading and temperature on adfreeze strength



Fig. 2. Pile load tests in Site C, Fairbanks, Alaska

family of temperature curves which define the relationship of rate of loading with ultimate adfreeze bond. To establish that at each temperature there was a distinct sustained adfreeze strength, unaffected by rate of loading, further tests were conducted at rates of 5 kips/4 days and over sustained periods of three weeks, three months, and two years; three piles have been under sustained loads for four years.

Based on the results of these preliminary tests, load settlement tests in each of the four backfill groups were initiated at a rate of load application of 10 kips/day. This standardized rate of testing was believed slow enough for proper analysis of load settlement test data to determine both the ultimate and sustained adfreeze bond strengths.

Load tests were performed using a hydraulic jack bearing against a platform loaded with concrete blocks. Two platforms were used simultaneously, one of which is shown in Fig. 2. Settlements were observed by the use of deflection gages, accurate to 0.001 in., supported by a frame on pipes driven well into the permafrost and cased against possible frost-heave or other surficial disturbances.

Ambient air temperatures and deflections were observed at

frequent intervals, and often around the clock, to record all conditions affecting the test and to permit evaluation of gross settlement and time settlement under each load increment. Typical load-settlement plots of a comparative group of 8 in. pipe piles installed with silt-water slurry are shown in Fig. 3. Note the characteristic excessive settlement, or plunging, at loads exceeding the yield point.

To evaluate point bearing, two 8 in. open-ended pipe piles, C44 and C55, with embedded lengths of 18 and 22 ft were installed in silt-water backfilled holes. Both piles were equipped with basketballs at the bottom (Fig. 4). The basketballs, broken just prior to loading, effectively provided the desired void so difficult to form when using open-ended pipes in slurried holes. The two piles were loaded to failure at the 10/kips/day rate of loading, and results were compared to those from two adjacent piles, C60 and C61, which were identical in every respect, except for 0.5 in. plates welded to the bottom of the pile.

These "mates" were installed by the same method, to the same depth and, most importantly, were tested at essentially the same ground temperatures as the basketball piles. There is no significant difference in the performance of the piles with plates and those with basketballs (Fig. 3). The low point-bearing capacity is caused by the difference between the relative strains of the adfrozen soil along the pile length and of the soil beneath the plate; this is in agreement with the very large plastic strains observed at loads of less than 4 kips on plates of 8 in. dia. on frozen silt [17].

Slow rebound measurements after complete failure (gross settlement in excess of 1.5 in.) disclose that point bearing and normal friction (not adfreeze) along the pile length have a combined capacity of less than half the previous ultimate capacity in adhesion. This same effect was seen during the load settlement tests performed on piles which previously failed as a result of frost-heaving. These tests, some of which were performed months after the piles had heaved, indicate that the adfreeze bond does not readily mend, perhaps not completely until the pile has been thawed and refrozen. This loss of maximum strength from frost-heave may be of particular significance during the first winter, when permafrost tempera-

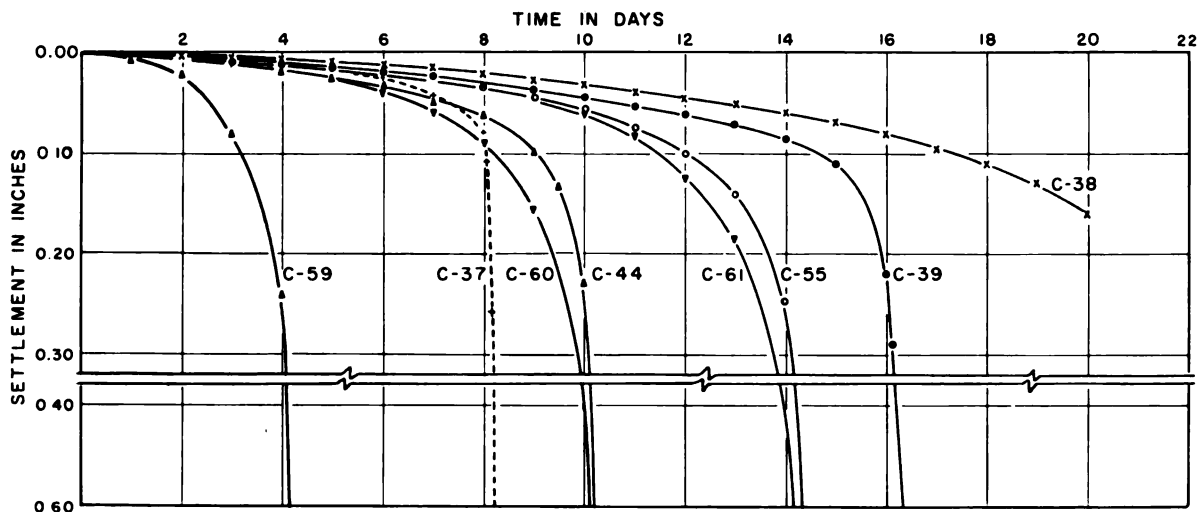

PILE SYMBOL	DATE TESTED	DEPTH IN P.F.	AVE. TEMP	ULT. AD STR. (psi)
C-37	5-14 May 1960	12.25'	29.9°F	23.6
C-38	29 May - 19 June 1958	14.8'	28.5°F	43.5
C-39	8-29 July 1958	16.3	28.7°F	33.6
C-44	6-20 July 1959	14.0'	30.1°F	25.3
C-55	23 July - 10 Aug 1959	16.0'	30.6°F	30.2
C-59	29 June - 5 July 1960	10.0'	31.2°F	16.1
C-60	16-28 June 1960	13.4'	30.0°F	26.5
C-61	29 June - 15 July 1960	16.28'	29.9°F	29.6

NOTE:
 All piles are 8-inch pipes installed in silt-water slurried, dry-augered holes. All piles loaded in increments of 10 kips per day.

Fig. 3. Load settlement tests of piles in permafrost

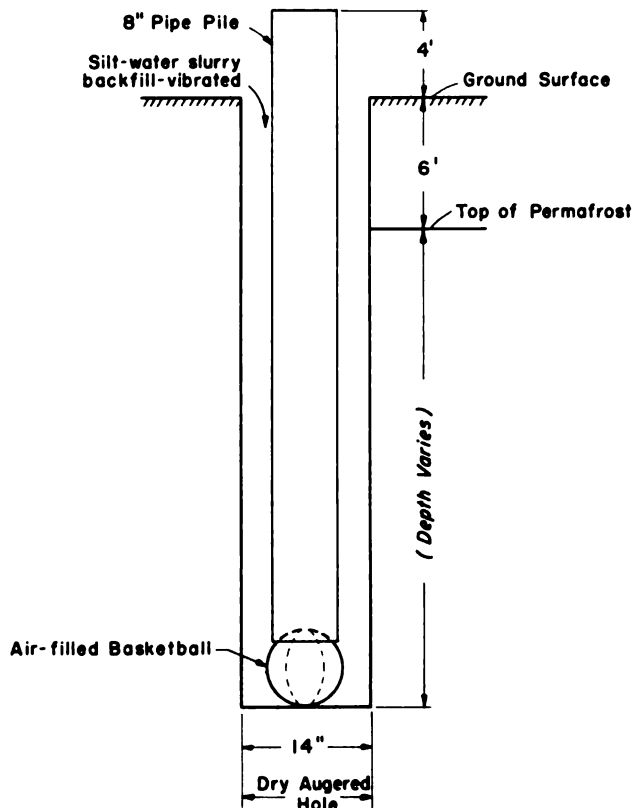

Fig. 4. Typical bond test pile

tures have been disturbed by the installation.

The effect of different permafrost temperatures was found by performing load tests in each group during a preselected period to achieve a certain average temperature. At various times of the year, significantly different temperatures exist at each depth [2]. The fluctuation of near surface temperatures, as well as the temperatures at depth would, of course, be dif-

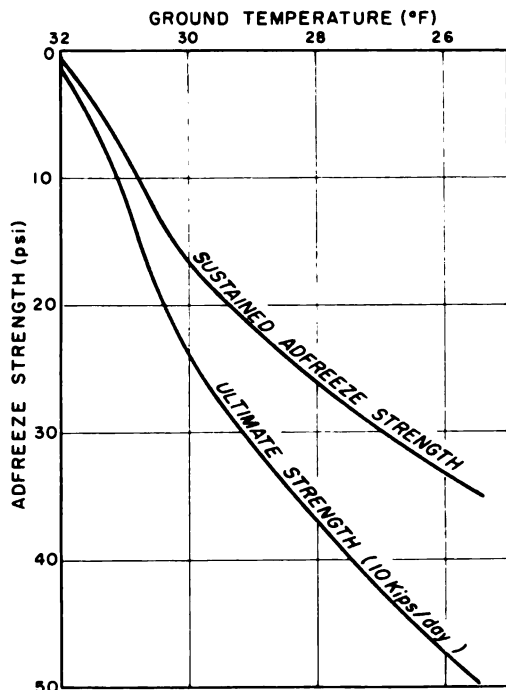

Fig. 5. Adfreeze strength versus temperature for slurried 8 in. pipe piles in permafrost silt-water

ferent at other sites. The support (contributed by extremely cold soil near the surface and frost thrust during the winter) was eliminated by casing selected piles from the ground surface to depths of about 6 ft.

To ascertain how the pile load was transferred to the soil, pipe and H-sections were instrumented with SR4 strain gages for extraction and load settlement tests [18, 19]. Analysis of each load-settlement test [18] was based on the potential adfreeze strength at the temperatures recorded by thermocouples during the test. A method was devised to calculate ultimate capacity of the pile by a summation process using the temperature dependent adfreeze strength along the pile length. Elastic deflection of pile and soil were separated from gross settlement to derive plastic yielding of the frozen soil. This analysis led to the empirical development for each pile and slurry type of curves giving sustained, and ultimate, adfreeze bond strengths versus temperature. The standard, or reference curves (Fig. 5) were based on 8 in. pipe piles in silt-water slurry. Similar curves for clay, dry and saturated sand, ice, and for various pile shapes and methods of installation were also developed.

In general, the effects of backfill types may be summarized as follows: Clay-water slurries, which are difficult to mix and place, have adfreeze strengths approaching that of ice, and have an ultimate strength of approximately half that of silt. The behavior of frozen dry sand backfill is like that of thawed sand and is apparently related to its in-place density.

In contrast, recent tests at the low-temperature pile test at Kotzebue disclose that saturated well-graded sand slurry, vibrated in place, has an adfreeze strength at least 50% higher than its silt counterpart at the same temperature. The contrasting effects of various sand types, installation methods, and permafrost temperatures are illustrated in Fig. 6. Pile BR2 is an 8BP36 section, conventionally driven with a diesel hammer, at Bethel, Alaska. Piles K2 and C65 were installed in augered holes 14 in. in dia. at Kotzebue and Fairbanks, respectively, using saturated- and dry-sand backfills.

PILE HEAVE

In addition to the study of performance of different pile types with increasing depths of embedment in permafrost to resist pile heave, supplementary tests have also been conducted since 1956 to actually measure the frost thrust imposed on piles, posts, or piers in frost-susceptible Fairbanks silt. Short pile lengths were installed through the active layer to the top of permafrost, and the force generated on the pile during the winter was observed with a proving ring. The force of frost-heave on both 8 in. pipes and creosoted timber piles and the distribution of frost-heave stresses along standard I-beams have been recorded. Recent observations at Fairbanks, using the device shown in Fig. 7, indicate that under sustained cold periods in the early winter a force of 50,000 lb can be imposed on 8 in. pipe piles when the frost has attained a depth of less than 4.0 ft. Similar observations on creosoted timber piles show significantly less thrust (22,000 lb max).

The mechanics of the supporting capacity of piles in permafrost during summer and winter is illustrated in Fig. 8. During spring and early summer (right of Fig. 8) piles have greatest potential strength in adhesion owing to the colder permafrost during this period. When the active layer is in the process of freezing (left of Fig. 8), the extreme temperatures near the ground surface cause much higher adfreeze strengths. During this period of frost-heaving, ground temperatures along the pile length in permafrost are at their warmest and the corresponding adfreeze strengths at their weakest. Unless pile is adequately embedded in the permafrost and capable of mobilizing sufficient adhesion, the pile will heave when the upward force of frost thrust exceeds the weight of the pile, the load on the pile, the negative skin friction in the thawed zone, and the adhesion in the permafrost. Simple equations for stability during the summer and early winter, using the adfreeze strengths from Fig. 5, can be readily derived.

During winter the potential adfreeze strength of each frozen sector depends on temperature so that normally

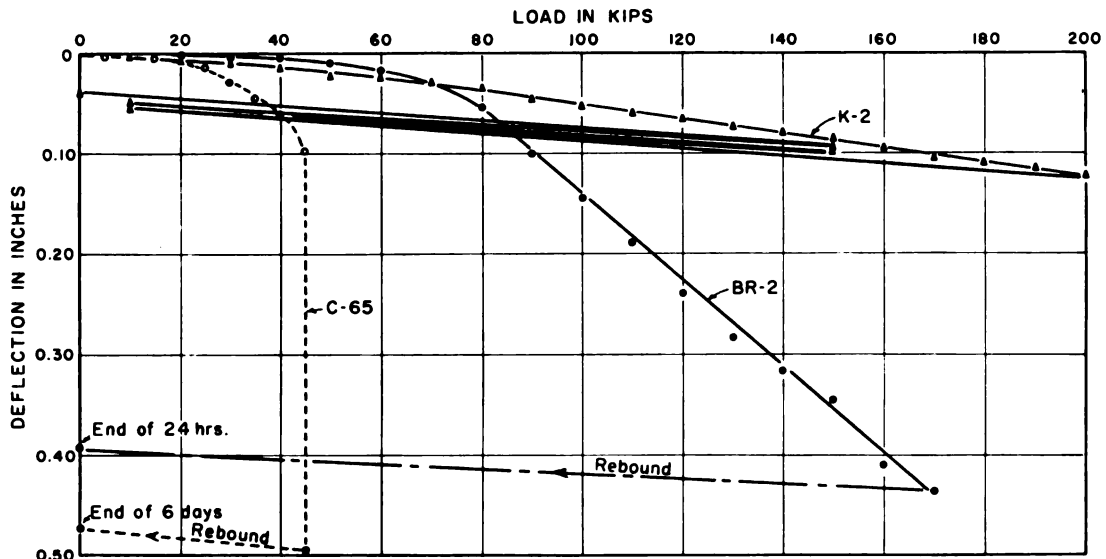

<p>C-65 (FAIRBANKS) Dry sand backfilled 6W25. Length in permafrost 10.0ft. Ave. permafrost temp. 30.4°F. Loaded at 5 k/4 days, 45 kip load held total of 22 days. Unloaded in one minute.</p>	<p>BR-2 (BETHEL) Driven 8BP36 section in fine silty sand. Length in permafrost 16.5ft. Ave. permafrost temp. 30.9°F. Rate of loading 10^k/day. Unloaded in 5 minutes.</p>	<p>K-2 (KOTZEBUE) Sand-slurried 8-inch pipe. Length in permafrost 11.0 ft. Ave. permafrost temp. 27.8°F. Load initially at 10^k/day. Unloaded and loaded in 10 minute cycles.</p>
---	---	---

Fig. 6. Load settlement tests in frozen sand

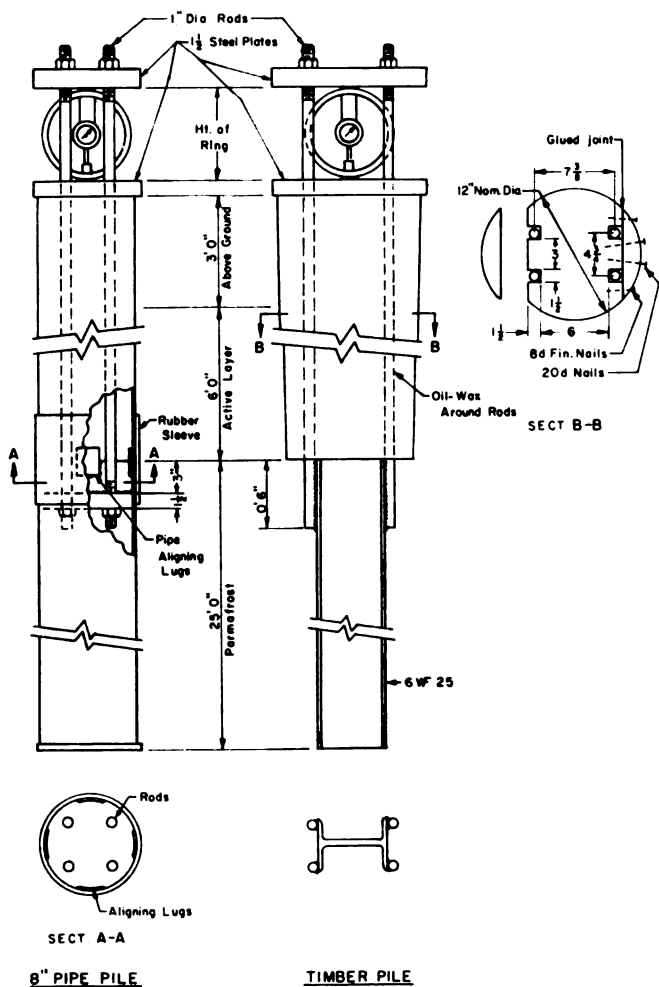
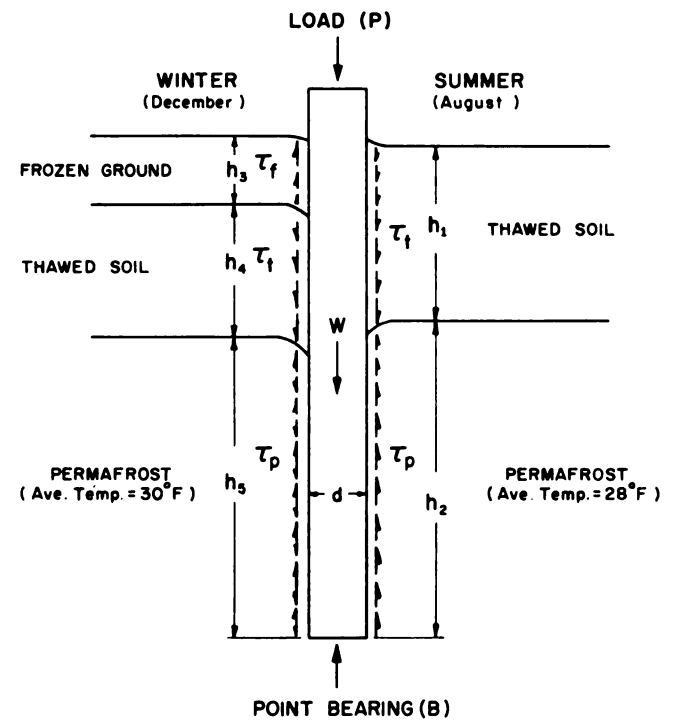

Fig. 7. Construction details of test piles for measurement of frost thrust

$$\tau_f > \tau_p(28^\circ) > \tau_p(30^\circ) > \tau_t$$

The adfreeze stress (τ_p) at low temperatures near the ground surface can exceed 100 psi, if rate of heave exceeds the flow rate of the soil immediately surrounding the pile. Conversely, during periods of higher surface temperatures (not necessarily thawing), the relaxation rate near the pile may exceed the heave rate and the frost thrust on the pile is quickly reduced.



NOTE

Arrow lengths denote relative magnitude of forces along pile.
 Average permafrost temperature based on pile length in permafrost.

Fig. 8. Forces applied to piling

Inasmuch as frost thrust can exceed nominal design load, piles in frost-susceptible soils must be stabilized by adequate embedment or by use of antiheave devices. More detailed descriptions of the field tests on frost-heaving of piles can be found in recently prepared reports [11, 20].

PILE DESIGN CRITERIA

The results of the last ten years of observations and pile testing in permafrost at various sites in Alaska, particularly at the pile-test areas at Fairbanks and Kotzebue, were incorporated in a recently revised engineering manual [21]. Requirements are given for preconstruction investigations (soil and temperature), permafrost preservation and construction techniques, pile installation and freezeback, long-term thermal regime changes, and design strengths appropriate for foundations in arctic and subarctic areas. The design criteria for pile foundations in this manual are based on the sustained and ultimate adfreeze bond strength of the various soil types at the expected long-term temperature of the permafrost. Safety factors are related to the soil type, ice conditions, and permafrost temperatures. Design considerations and construction techniques that can counteract or reduce frost-heaving effects are also presented.

REFERENCES

- [1] J. A. Pihlainen. "Pile Construction in Permafrost," Proc. ASCE, Vol. 85, No. SM6, December 1959, pp. 75-95.
- [2] F. E. Crory. "Discussion by J. A. Pihlainen," ibid., Vol. 86, No. SM4, Aug. 1960, pp. 87-94.
- [3] H. Pearson. "How Raber and Kief Drilled 900 Holes in Permafrost in the Arctic in Midwinter," Pacific Builder and Engr., Nov. 1956, pp. 58-59.
- [4] "Freezeback Control and Pile Testing, Kotzebue Air Force Station, Alaska," Tech. Rept. 66, ACFEL, New England Div., Corps of Engineers, U.S. Army, May 1957, unpubl. data.
- [5] Tech. Rept. 142, U.S. Army CRREL, ibid., Hanover, N. H., 1963, unpubl. data.
- [6] "Freezeback Control and Pile Testing, Bethel Air Force Station, Alaska," Tech. Rept. 143, U.S. Army CRREL, 1963, unpubl. data.
- [7] "Frozen in Place Piles Support Air Force Building in Alaska," Construction Methods and Equipment, June 1956, pp. 62-64.
- [8] T. L. Péwé, R. A. Paige. "Frost Heaving of Piles with an Example from Fairbanks, Alaska," Geol. Survey Bull., No. 1111-1, Washington, D. C., 1963.
- [9] F. F. Kitze. "Installation of Piles in Permafrost," ACFEL MP-18, 8th Alaskan Sci. Conf., Anchorage, 1957.
- [10] "Core Drilling in Frozen Ground," WES, Tech. Rept. 3-534, U.S. Army Engr. Waterways Experiment Station, Vicksburg, Miss., Jan. 1960.
- [11] F. E. Crory. "Installation and Testing of Piles in Permafrost—Pile Site C," U.S. Army CRREL Tech. Rept. 140, Vol. 1, 1963.
- [12] F. E. Crory. "Installation of Driven Test Piles in Permafrost at Bethel Air Force Station, Alaska," U.S. Army CRREL Tech. Rept. 139, 1963.
- [13] E. L. Long. "Permafrost Design and Construction Within the Alaska District Corps of Engineers," ASCE Conf., Fairbanks, Alaska, Oct. 1957.
- [14] "Timber Pile Stability Tests, Permafrost Research Area, Fairbanks, Alaska," ACFEL, U.S. Army Corps of Engineers, Feb. 1950.
- [15] "Pile Extraction Tests, Fairbanks Research Area," ACFEL Tech. Rept. 59, Nos. 1-2, Corps of Engineers, June 1955.
- [16] K. A. Linell. "Interim Report on Load Tests of Piles in Permafrost," ACFEL Tech. Rept. 58, June 1955.
- [17] "Plate Bearing Tests Permafrost," ACFEL Inter-office Rept., Corps of Engineers, Nov. 1955.
- [18] F. E. Crory. "Installation and Testing of Piles in Permafrost—Pile Site C," U.S. Army CRREL Tech. Rept. 140, Vol. 2, 1963.
- [19] R. E. Reed. "Strain Gage Instrumented Piles in Permafrost," U.S. Army CRREL Tech. Rept. 144, 1963.
- [20] F. E. Crory, R. E. Reed. "Study of Frost Action on Piles," U.S. Army CRREL Tech. Rept. 145, 1963.
- [21] "Arctic and Subarctic Construction: Building Foundations," Eng. Manual for Military Constr., Part 15, Chap. 4, 1963.

Studies were directed by the Civil Engineering Branch, Engineering Division, Office of the Chief of Engineers.

- [22] H. S. Carslaw, J. C. Jaeger. "Conduction of Heat in Solids," Oxford Univ. Press, 2nd ed., London, 1959.
- [23] G. Y. Leung. "An Analytical Study of Freezing of Slurry Around Piles," Tech. Note, ACFEL, New England Div., July 1958.
- [24] T. M. Lee. "Freezeback Time of Slurry Around Piles in Permafrost," Tech. Note, U.S. Army CRREL, Jan. 1962.
- [25] G. B. Pritchard. "Foundations in Permafrost Areas," in this volume.

DISCUSSION

WILLIAM C. DIAS, Pacific Missile Range, Point Mugu, Calif., and SIDNEY FREEDMAN, National Concrete Masonry Association, Washington, D.C.—The author has presented a discussion on installation methods that requires further study into variables other than the "amount of heat (both sensible and latent) that must be absorbed from the slurry or steamed hole and its effect on pile spacing." Additional variables affecting pile installation and freezeback are analyzed and a working equation established. Although data are still needed, by using the variables studied, foundation design may take full advantage of natural refrigeration without risk of foundation failure due to slow refreezing of piles.

The installation problem is considered using data from the Alaska Field Station at Fairbanks. Fundamentally, the variables affecting freezeback time are similar: (a) Annual temperature changes in permafrost; (b) initial permafrost temperature; (c) thermal properties of permafrost; (d) pile spacing; (e) latent heat of freezing of the backfills; and (f) hole diameter.

Pile placement methods that introduce a minimum of heat into permafrost during installation are preferable. The boundary surface of the permafrost at the perimeter of a dry-augered hole might increase in temperature because of augering, but since there is no continuing source of heat within the hole, initial permafrost temperatures around the hole are essentially unchanged. At the instant of backfill placement, however, the permafrost-backfill interface changes temperature to 32°F. At a short radial distance from the hole, there is no instantaneous change in permafrost temperature, and the initial temperature, below 32°F, persists for some time. Heat then flows radially from the interface at 32°F toward the colder temperatures in the surrounding permafrost; in time the radius of effect increases and the permafrost warms. Finally, with the backfill fully frozen and its latent heat exhausted, temperatures around the pile drop toward the initial permafrost temperature.

If the volume of permafrost involved were limited, and if the diffused heat of backfill freezing were not extracted from the permafrost, final average temperature of backfill would be higher than the initial. Washed and steamed holes are at a disadvantage because steam and water provide a continuing source of heat within the hole while the hole is being put down, and as long as it stands open, before the pile is set.

A boundary temperature of 32°F is created in the permafrost as soon as water or steam is applied, and heat flows from the hole into the permafrost as long as there is a heat source in the water, i.e., as long as some water in the hole is not frozen and permafrost temperatures are not increased to 32°F. When the pile is placed, backfill refreezing is slowed down or eliminated, since permafrost temperatures around the hole are higher than they were originally. This reasoning is based on refreezing observations of test piles but not on direct measurements of the effects discussed. If piles can be driven without holes, backfilling and refreezing are eliminated.

ANNUAL TEMPERATURE CHANGES IN PERMAFROST

The curves of temperature versus depth as indicated by a thermocouple string on a timber pile at Fairbanks, Alaska, are shown in Fig. A-1. Curve shapes are basically a function of the season and also of conditions at the pile site and can therefore be used as a general example of the effects of the seasonal changes in temperature conditions.

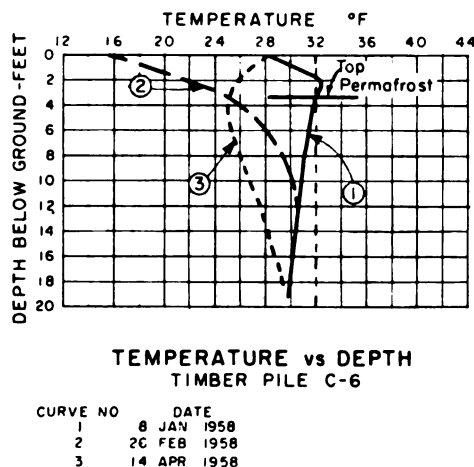

Fig. A-1.

Curve 1 shows temperatures on 8 Jan. 1958, when the annual zone was only partly frozen. Permafrost temperatures were high, ranging from 32°F at the top of permafrost, down to about 30°F at 19 ft. The thermal gradient indicated heat flow from the upper levels of permafrost downward as temperatures slowly adjusted to the 32°F boundary at the top of permafrost. Heat flow from ground to air is limited to the annual frost zone and there is no flow of heat from the permafrost. This temperature distribution is not favorable for natural freezeback. Piles are frozen most quickly to the annual zone and tend to be heaved by the annual zone before freezeback in the permafrost is completed.

Even during summer when the annual zone is thawed, temperatures within permafrost tend to approach those shown by this curve, with resultant slow freezeback. At colder sites, such as Kotzebue, Alaska, temperatures of 23° to 25°F might be found at 20 ft depths in summer instead of the indicated 30°F temperature. At such cold locations, piles could be installed with successful natural freezeback, even during summer, with pile spacing the only limitation. For such an installation, as the latent heat of freezing is diffused from the backfill to the permafrost, its temperature increases proportionately, since there is no heat flow from the permafrost itself under the Curve 1 gradient.

Curve 2 shows temperatures on 26 Feb. 1958. By then the annual frost zone had frozen solid and heat was flowing from the permafrost to the cold air. Pile installation under these conditions is favorable for natural freezeback. Piles freeze quickly within 10 ft of ground surface and more slowly at greater depths as the permafrost temperature drops with the penetrating cold. Pile spacing here is less important than under conditions of Curve 1 since the diffused heat of freezing tends to flow from the permafrost to the air, and the permafrost is not the sole source of refrigeration, with the temperature gradients as shown in Curve 2.

Curve 3 shows temperatures on 14 April 1958. By then there was a sharp temperature drop to a 19 ft depth. The temperatures shown allow quick refreezing of piles if the piles are not too closely spaced. The minimum temperature, 25°F, occurs at a 4 ft depth, with heat flowing downward from the ground surface into the permafrost. Since heat flow from the permafrost to the air is cut off, diffused latent heat can no longer flow to the air, and allowable pile spacings are therefore restricted under such a condition. Permafrost gradually

becomes warmer and temperatures approach those shown by Curve 1 but with annual zone thawing.

Consideration of these basic temperature curves is important for any site. At any location where the annual zone does not freeze solid each year, there can be no annual extraction of heat from the permafrost in the vertical direction, and permafrost temperatures must approach 32°F. This temperature condition might be found in any geographical area, although it is most common in sporadic permafrost areas.

This condition might be found in generally continuous permafrost areas beneath bodies of water, deep fills or, presumably, wherever steam thawing or any other construction operation had lowered the permafrost table significantly, so that the thawed zone over the permafrost would not freeze solid for one or more years. Heat flow in a roughly horizontal direction could lower permafrost temperatures somewhat, even below a layer that was not fully frozen each year, but vertical heat flow is most effective since its path of heat flow is shortest.

INITIAL PERMAFROST TEMPERATURES

When piles were installed in Pile Site C, Fairbanks, [A-1] during April 1957, permafrost temperatures varied from about 25°F to about 30°F throughout most of the area. Where backfill is placed around piles at low temperatures, refreezing is significantly faster than if initial permafrost temperatures are higher and other conditions identical. The wide range of temperatures encountered in the field, up to 32°F, affect the success of any installation.

THERMAL PROPERTIES OF PERMAFROST

Volumetric heat capacities and thermal conductivities of permafrost vary among sites or even at the same site with significant effects on refreezing times.

PILE SPACING

Latent heat of freezing diffused from piles at close spacings may increase permafrost temperatures. Assume that numerous piles are put in at 20 ft spacings, with latent heat of freezing of backfill at about 6200 Btu/ft of pile length. If during refreezing heat flows radially from the piles, and heat is not extracted from the permafrost at the site, average temperature increase in permafrost at volumetric heat capacity of 31 Btu/cu ft °F is only 0.5°F. At 10 ft spacings, average increase in permafrost temperature due to heat flow from the backfill is 2°F; at 5 ft spacings, 8°F.

Refreezing is delayed or eliminated as average permafrost temperatures approach 32°F. In practice, temperature increase in permafrost might be less, since some heat could be conducted away from the immediate vicinity of the piles, but spacings must be considered since heat flow away from the vicinity of the piles may occur slowly.

REFREEZING TIME

The relationship between refreezing time and the variables discussed is shown in Fig. A-2. This relationship was developed from field studies [A-1] using various pile types installed in dry-augered holes of 10 to 18 in. dia. at 20 ft spacings. Backfill types included silt-water slurry, dry sand (less than 2% moisture content), clay-water slurry and water. Latent heat of freezing varied as a function of content water and amount of backfill placed in pile holes. The range was about 3000 to 10,000 Btu/ft of pile length for slurry and water backfills and negligible for dry sand. A slurry is better than plain water because less latent heat must be extracted in a slurry mixture.

The equation shown on Fig. A-2 for freezeback time is an approximation that fits the field data for conditions of radial heat flow with negligible vertical heat flow. An assumed coefficient of thermal conductivity Btu/ft hour°F of permafrost of 1.5 was used in all computations.

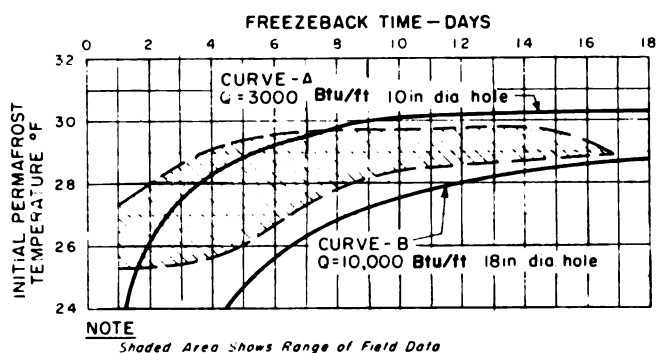

NOTE
 Shaded Area Shows Range of Field Data

t = Freezeback time, hours; C = Volumetric heat capacity of permafrost, $\frac{\text{Btu}}{3\text{cu ft } ^\circ\text{F}}$; K = Coefficient of thermal conductivity of permafrost, $\frac{\text{Btu}}{\text{ft hr } ^\circ\text{F}}$; Q = Latent heat of freezing of backfill, Btu per foot of pile length; r_o = Initial radius of pile hole, ft; $\Delta T = 32^\circ\text{F}$ minus initial permafrost temperature, $^\circ\text{F}$; $t = \frac{1}{180} \left(\frac{C}{K r_o} \right) \left(\frac{6Q}{C \pi \Delta T} \right)^{\frac{3}{2}}$

Fig. A-2.

The range of field data is shown by the shaded area of Fig. A-2 for silt-water slurry backfill with latent heat content of 3000 to 10,000 Btu/ft of pile length. The coldest initial permafrost temperatures at the site were about 25°F. No data were obtained for initial permafrost temperatures above about 29.5°F.

Curves A and B were computed from the equation shown. Curve A was computed for latent heat of freezing of 3000 Btu/ft in a 10 in. dia. dry-augered hole; Curve B for a 10,000 Btu/ft 18 in. dia. hole.

At 26°F, refrigeration capacity of the permafrost is adequate to refreeze piles within less than a week, even with very high latent heat of freezing (Curve B). At initial permafrost temperatures of 28°F, high latent heat of refreezing causes a marked increase in refreezing time. The difference between the extreme curves with respect to critical temperatures at which freezing times become prolonged shows the significant effect of increased latent heat of backfill. For example, in 14 in. holes at 29°F permafrost temperature, an increase of latent heat of backfill from 5000 to 8000 Btu/ft of pile length caused freezeback time to increase from eight to eighteen days, according to the equation

$$t = \frac{1}{180} \left(\frac{C}{K r_o} \right) \left(\frac{6Q}{C \pi \Delta T} \right)^{\frac{3}{2}}$$

The field data showed about the same effect.

If possible variations in thermal conductivity among various sites, limitations on field control, and effects of other important variables are considered, widely different refreezing times may be encountered in the field, even under superficially similar conditions. The foundation designer should therefore consider the variables discussed to avoid overestimating the natural refrigeration capacity of permafrost and air, and also to take full advantage of both.

Fig. A-2 also can be used as an approximate indication of the rate at which heat flows from a steamed or washed hole into the surrounding permafrost. Curve A, for example, shows that 3000 Btu may flow from such a hole into permafrost within one or two days at initial permafrost temperatures of 26°F.

The equation approximates freezeback times satisfactorily (usual scatter \pm two to four days) within the permafrost temperature range of about 30 to 25°F. At permafrost temperatures above 30°F or at longer refreezing times than those shown in the shaded area of Fig. A-2, the equation is not applicable. As shown in Fig. A-1 permafrost temperatures tend to change with time, and conditions might vary widely from the initial state. The equation does show that permafrost temperature is the most significant variable because at temperatures of 26°F

freezeback times ranged from one to five days, while at temperatures of 29 to 30°F freezeback times greatly increased.

EFFECTS OF MINOR VARIABLES

Effects of minor variables such as thermal conductivity of piles and pile shapes were not apparent from field studies. Steel pipe and wood piles refroze in similar periods of time under similar permafrost temperatures. The high thermal conductivity of steel as contrasted to wood did not appreciably affect the results.

The type of pile used can directly affect freezeback time because an H-section occupies less volume than a pile of circular cross-section for the same size hole. Hence, the amount of backfill needed to fill around an H-section is greater. Both curves developed from the equation (Fig. A-2) and field data show that any increase in latent heat of freezing of backfill leads to an increase of freezeback time, where hole size and initial permafrost temperatures are the same.

Freezeback curves for some H-piles tended to show development of secondary isotherms below 32°F. Also the data showed that hole diameter greatly affects the time rate of heat flow from the hole to the permafrost, with heat flowing more slowly from smaller holes. It then appears that H-sections should freeze more slowly than circular cross-sections. During slurry freezing, the radius of the thawed material around an H-pile decreases to the center point of the hole, whereas the radius of thawed soil around a circular section such as a pipe decreases only until it reaches the pipe radius whereupon freezeback is complete. Thus, it seems that during the later stages of freezeback, heat flow from around an H-pile occurs through a hole of very small radius; some breaks in the freezeback curves developing at this type of pile could be explained on this basis.

It is believed that any decision on methods of pile installations according to general permafrost conditions (sporadic or continuous) or geographical location (north or south) is only a preliminary step. Consideration of basic ground temperature curves for permafrost, pile spacing, and variables (Fig. A-2) in planning an installation at any foundation site could result in eliminating or minimizing the costly use of artificial refrigeration for freezing pile backfills.

This discussion is mainly an enlargement of points made by the author on the importance of a thorough site survey and of variables involved in refreezing of piles.

REFERENCE

[A-1] F. C. Crory. "Installation and Testing of Piles in Permafrost—Pile Site C," U.S. Army CRREL Tech. Rept. 140, 1963.

CLOSURE

The author appreciates the interesting discussion of W. C. Dias and S. Freedman on the natural freezeback of piles in permafrost. Because an adequate dissertation on natural freezeback was too lengthy for inclusion in the paper, and reported elsewhere [11], it was only briefly mentioned. Since the subject has been discussed, however, a brief summary of natural freezeback is thought to be appropriate.

Piles backfilled with soil-water slurries in drilled or augered holes introduce both latent and sensible heat, which is conducted into the surrounding permafrost. The sensible heat of the water, soil, and pile can be computed, if the water content of the slurry is known [11]. Present practice is to place the slurry at a temperature slightly above freezing, so that under normal conditions the sensible heat is less than 200 Btu/cu ft, or small enough to be merely approximated and added to the latent heat.

The latent heat per foot length of pile embedment is computed by the equations shown in Fig. B-1. Note that latent heat is governed only by the volume of slurry, the water content (w) and the dry unit weight (γ_d). Thus the heat input can be diminished by control of the dimensions of the annulus and

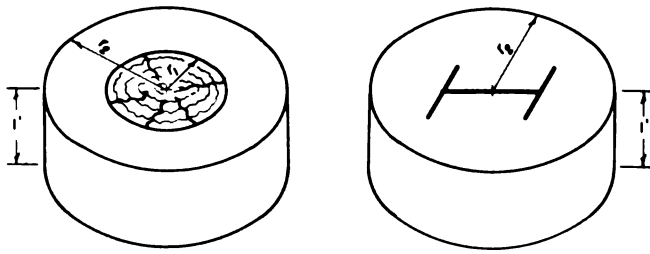

$$Q = \pi L (r_2^2 - r_1^2) w \gamma_d \text{ or } Q = L (\pi r_2^2 - A) w \gamma_d$$

where L = Latent heat of water
 r_2 = Radius of hole
 r_1 = Radius of pile
 A = Cross sectional area of H-pile
 w = Water content, % dry weight
 γ_d = Dry unit weight of slurry

Fig. B-1. Latent heat of slurry backfill

the water content and dry unit weight of the backfill material.

Normally the radius of the pile hole is at least two inches greater than the pile radius. This permits the use of a concrete vibrator and rodding to consolidate the material and to ensure that bridging or air pockets are not formed during the backfilling operation. Although a minimum hole diameter for the pile type is desirable, specifications must also be realistic and provide for the positioning and alignment of the pile within the normal tolerances encountered in drilling the hole.

When the volume of slurry per foot of pile length has been established, the temperature, water content, and dry unit weight of the slurry are the only remaining variables that can be field controlled. The present practice is to mix the soil-water slurry in a concrete mixer, with the soil completely saturated, at temperatures of less than 45°F. Using the relationship of grain specific gravity, water content, and dry unit weight, simple comparisons of the amount of heat per unit volume at different water contents can be made. For instance, the water content of the silt-water slurries used at the Alaska Field Station normally range between 40 and 80%. Thus the volumetric latent heats are:

$$Q = L w \gamma_d$$

where L is latent heat, 144 Btu/lb of water; w is water content, expressed as decimal; γ_d is dry unit weight, lb/cu ft;

$$144 (0.80) (53) = 6100 \text{ Btu/cu ft (for } w = 80\%)$$

$$144 (0.40) (80) = 4600 \text{ Btu/cu ft (for } w = 40\%)$$

$$\text{Difference} = 1500 \text{ Btu/cu ft}$$

Maintaining field control of the slurry water content could thus effect a substantial reduction (25%) of the heat introduced around the pile. A high water content (>45% for silt), in addition to lengthening the freezeback time and increasing the over-all rise in permafrost temperatures, has other pronounced effects: (a) An annular coating of ice, in some cases as much as an inch thick, forms on the wall of the hole or the pile surface. Such an ice layer has a significant effect on the lateral stress distribution from the slurry to the natural ground. (b) If the freezeback time is rapid (less than two days), silt- and clay-water slurries, when frozen, will attain strengths comparable to ice rather than frozen dense soils. (c) Should the freezeback time be greater than a few days, the soil particles will settle out and proceed to consolidate, even while freezing is occurring at the wall of the hole. Depending on the type of soil and the water content of the slurry, considerable lengths of the upper section of the pile will with time be surrounded by only water (ice). Such areas, because of the much higher latent heat of water, will refreeze at much slower rates. If the piles are installed in the summer, freezeback of these upper sections, which are surrounded by water only, may not be completed until the next spring.

Complete knowledge of ground temperatures that exist with

depth throughout the year is essential to estimate the freezeback time and over-all effect of the installation on the permafrost. Isotherms [2] or plots of temperatures with depth (as discussed by the writers) may be used to select the optimum installation period for rapid freezeback. Present methods [11] of computing natural freezeback of piles in permafrost assume the slurried pile to be a finite cylindrical heat source inside a semi-infinite medium, with a suddenly applied constant temperature (32°F) source which dissipates heat only in a radial direction.

The solution to the natural freezeback problem was adapted from Carslaw and Jaeger [22], by Leung [23], and Lee [24]. The general solution appears in Fig. B-2. To determine the time required for freezeback at different temperatures, nor-

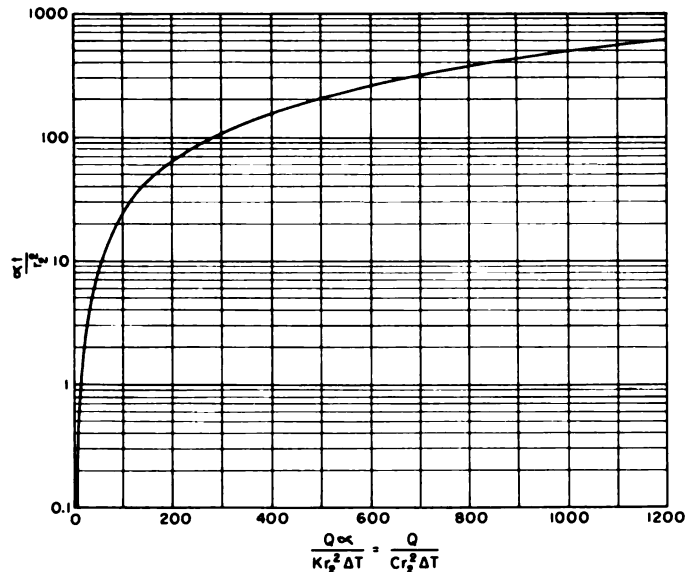

where t = Freezeback time, hrs.

K = Conductivity of permafrost, BTU/hr ft²°F.

C = Volumetric heat capacity of permafrost, BTU/ft³°F.

α = Diffusivity of permafrost, ft²/hr = $\frac{K}{C}$

Q = Latent heat of slurry per foot of pile length, BTU/ft.

ΔT = Initial temperature of permafrost, expressed as number of °F below freezing (32° - T_p)

r_2 = Radius of pile hole, ft.

Fig. B-2. General solution of slurry freezeback

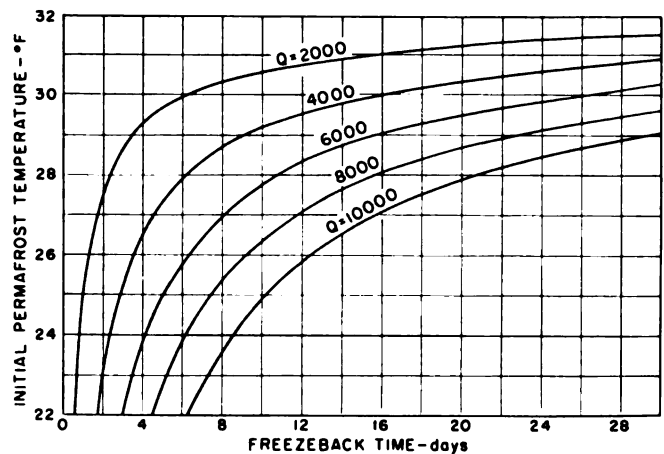

where C = 30 BTU/ft³ °F

K = 1.4 BTU/ft hr °F

r_2 = 0.75 ft

Q = Latent heat of slurry per ft of pile length, BTU/ft

Fig. B-3. Specific solution of slurry freezeback

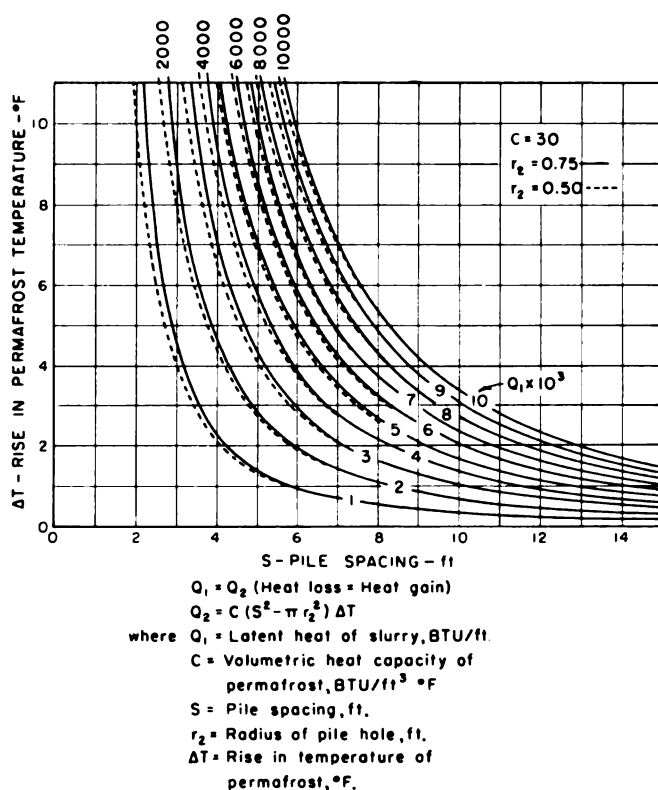

Fig. B-4. Influence of slurry on surrounding permafrost

mally it is easier to prepare, from the general solution, a specific solution similar to that shown in Fig. B-3. The specific solution is based on the existing conductivity and volumetric heat capacity of the permafrost and the diameter of hole to be used. The specific solution shown in Fig. B-3 is comparable to the approximate solution presented by the writers in Fig. A-2.

The effect of pile spacing on over-all rise of permafrost temperature as a result of the pile-installation heat is shown in Fig. B-4. The relationship between spacing and temperature rise is based on the "method of mixtures" as shown by the equations below the nomograph. Similar plots, using the actual volumetric heat capacity of the permafrost, are prepared during design to approximate the permafrost temperatures after freezeback with respect to potential adfreeze strengths at various pile spacings. Since the temperature of the slurry quickly cools to 32°F, the heat introduced by the slurry cannot raise the permafrost temperature above 32°F. Should the rise in permafrost temperature (ΔT), in Fig. B-4, exceed the difference between the freezing point and the initial permafrost temperature ($32 - T_p$), the permafrost will absorb only that amount of the slurry heat to raise the permafrost temperature

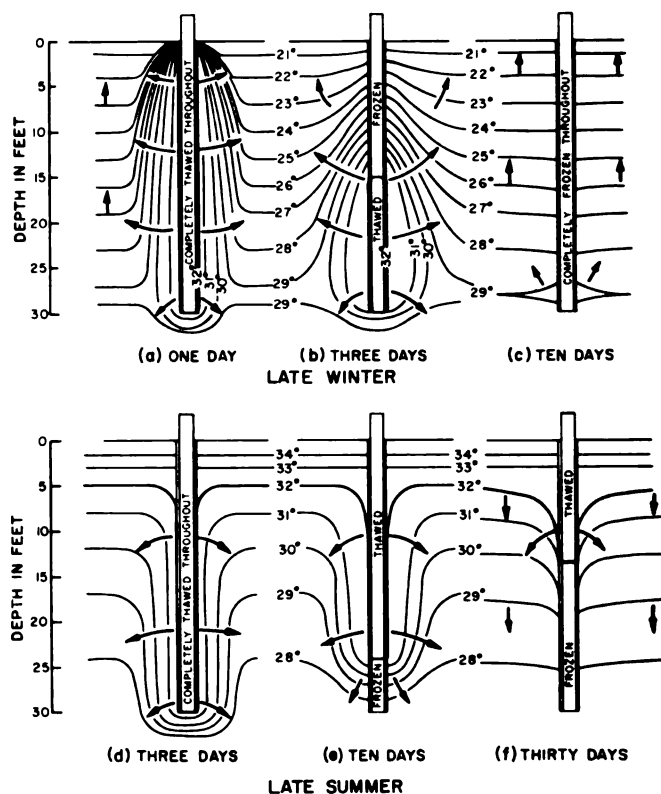

Fig. B-5. Natural freezeback of piles in permafrost during winter and summer

to the freezing point. The remaining latent heat of the slurry will not freeze until the surrounding permafrost is made colder. Thus the plastic flow of partly thawed permafrost, leaving the pile clusters for the maintenance garage at Inuvik without lateral support, as described by Pritchard [25], is quite understandable.

Although the freezeback solutions presented by the author and the writers are based on only radial conduction of the slurry heat, the actual heat path is always toward colder permafrost than actually exists at the depth considered. Supplementing the thermal regime described by the writers, illustrations of the heat paths during summer and winter are shown in Fig. B-5. When undisturbed ground temperatures at the time of installation are known, an "effective" temperature of the permafrost, over the time and distance of the heat path, can be approximated to account for the amount of vertical heat flow.

No factor of safety is incorporated in either of the freezeback methods discussed. Whenever possible, thermocouple assemblies, or other temperature-indicating devices, should be installed to verify the theoretical freezeback times before the piles are actually loaded.

PILE CONSTRUCTION IN PERMAFROST

G. H. JOHNSTON, Division of Building Research, NRC, Canada

Permafrost underlies approximately 20% of the land area of the world. Its extensive occurrence in northern regions, including almost one-half of the USSR and Canada and much of Alaska, is of considerable concern to engineers particularly with regard to the foundations for various structures. Although permafrost provides excellent bearing for a structure, it may lose its strength to such an extent when thawed that it will not support even light loads. Substantial settlement can occur when these frozen materials thaw, and differential movements usually result in serious damage or even complete failure of the structure.

Prior to the last war, construction in the Canadian North mainly involved the erection of isolated small buildings and limited engineering facilities. Most structures were supported by foundations which extended to or slightly into permafrost or were placed on the ground surface [1]. Some movement had to be tolerated, therefore, due to frost action and thawing of the frozen ground. Increased northern development in recent years has required the construction of more extensive facilities that made previously used foundation designs unsuitable.

Present construction techniques for large structures favor the use of foundations, such as piles, which are embedded in permafrost. They are particularly useful, and may be the only type of foundation suitable, for sites underlain by materials containing large quantities of ice. Piles are anchored in permafrost thus providing resistance to frost action forces. In addition, because they are well embedded, some thawing of the frozen ground can occur without detriment to the foundation or structure.

Several accounts describing the design and performance of pile foundations in permafrost areas have been published [2, 3, 4]. Studies have also been conducted to determine factors affecting the use and design of piles in frozen ground [5, 6, 7, 8]. There is a great need, however, for additional information on the design of pile foundations.

The development of the new townsite of Inuvik, NWT, in an area of continuous permafrost offered a unique opportunity for members of the Division of Building Research, National Research Council, Canada, to conduct studies of many aspects of construction on permafrost. Pile foundations were used extensively at Inuvik and the experience gained and some observations on their use are reported.

HISTORY

The development of the new townsite of Inuvik near the mouth of the Mackenzie River (68° 21' N, 133° 44' W) resulted from a decision of the Canadian Government in 1953 to concentrate and enlarge its educational and administrative facilities for the Northwestern Arctic at or near the old settlement of Aklavik located in the Mackenzie River Delta. Aklavik was not a suitable location for the expansion proposed for several reasons including poor subsurface conditions [9]. During 1954, therefore, potential sites for a new town were surveyed [10]. The most favorable site, originally known as East Three but officially named Inuvik in July 1958, was recommended; by a decision of the Federal Cabinet in November 1954, development of the new townsite was approved.

During 1955 and 1956, construction activity was limited to site preparation (building access roads, hand clearing of brush, stripping of borrow pits), stockpiling materials and the erection of a large equipment maintenance garage, some warehouses, and a wharf. The main construction period was from early 1957 to the late fall of 1960 when all major contract work was completed [11]. All major buildings (including most housing) and engineering facilities such as heated oil tanks and utilidors are supported by pile foundations (Fig. 1). All pile foundations were placed, in advance of building construction, by the Federal Department of Public Works.



Fig. 1. Air view of Inuvik under construction, June 1959

DESCRIPTION OF SITE

Inuvik is located on a terrace immediately adjacent to the East Channel which forms the eastern boundary of the Mackenzie Delta [12]. The relief of the area is one of flats at varying elevations, gentle undulations separated by shallow swales, rounded knolls, hummocky hills, and ridges of varying heights and lengths. Spruce and birch are the dominant tree types with secondary stands of willow and alder. The ground is generally hummocky and covered everywhere with moss from 4 to 6 in. thick.

Below the living moss cover a brown to black peat (average depth about 2 ft) occurs over much of the site. At a few locations it may be as deep as 13 ft. Underlying the peat there is usually a brown gravel with sand or silt which varies in thickness from 1 to 14 ft. This material is, in turn, underlain by a grey gravel with sand, silt or clay. Granular deposits are underlain by various combinations of grey, fine-grained soils, mostly silt size. A typical sequence of subsurface materials found at the Inuvik townsite is shown in Fig. 2.

Ice segregation varies considerably over the site but has been observed in all soils, ranging from fine-hairline lenses or coatings on particles to massive ice concentrations several feet thick. The higher ice contents occur in the peat and the fine-grained soils, generally in the form of thin lenses. The larger ice masses are also chiefly associated with peat and fine-grained soils although some have been observed in granular materials (Fig. 3).

Permafrost occurs everywhere under the ground surface at Inuvik to depths exceeding 300 ft. The mean annual ground temperature at depths of from 15 to 100 ft is approximately 26°F. The maximum depth of thaw observed in the late summer of 1954 (during the site survey), i.e., prior to occupation and disturbance of the area, averaged 1.5 to 2 ft, ranging from 1 ft in peat to about 4 ft in gravel having a 4 in. moss cover.

FOUNDATION SELECTION

It was realized that because of the variable soil and permafrost conditions at Inuvik, every precaution would have to be taken to prevent thawing of the underlying permafrost, or at least to keep thawing to an absolute minimum. In addition, the erection of several very large buildings and important facilities at the site made foundation design particularly critical; the selection of one foundation type that would serve all or

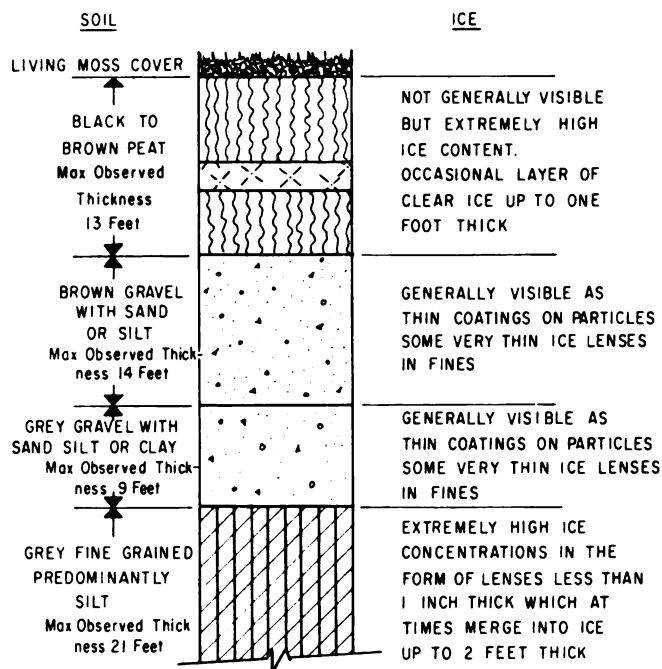

Fig. 2. Typical sequence of subsurface materials at Inuvik, NWT

most structures was most desirable. Under these circumstances it was decided to place all structures on pile foundations.

Five major factors had to be considered with regard to the use of piles in permafrost at Inuvik. These were: Site preparation, type of pile, pile placement methods, depth of embedment, and refreezing characteristics.

PILE FOUNDATIONS

Site Preparation

It was imperative that individual construction sites as well as the area as a whole be disturbed as little as possible in order to maintain the frozen ground condition. Under no circumstances was the insulating moss cover to be disturbed and therefore movement of construction equipment and clearing of brush was under strict control. Any necessary clearing of trees and undergrowth was done by hand methods.

At each construction site a gravel pad from 18 to 24 in. thick was laid over the whole area. For access the pad was connected to an adjacent main road by a gravel fill. Heavy equipment thus moved easily about the site and construction materials were stockpiled on the gravel pads with little disturbance of the moss cover.

Type of Pile

More than 20,000 piles were placed for the foundations of buildings (Figs. 4, 5), utilidors, oil tanks, and road bridges (Fig. 6). Because spruce timber was available from the adjacent delta area and thus would affect a substantial saving in cost over material brought in, wood piles were used for the majority of the foundations. Although some timber in 24 and 30 ft lengths was available in the delta, most of the spruce piles obtained locally had a maximum length of 20 to 22 ft with a minimum diameter of 6 in. About 800 pressure-croseted Douglas Fir piles (30 to 40 ft long), were brought in from Edmonton, Alta., for the foundations for the powerhouse and the two 35,000-barrel heated oil storage tanks. Some 200 reinforced concrete piles (about 20 ft long and 15 in. square) were cast on the site and used for road bridges over the utilidor lines. Approximately 300 steel piles were used, primarily for corners and anchor points along the utilidor lines. Some of these piles were 9 in. dia. pipe and others were wide



Fig. 3. Massive ice deposit in gravel



Fig. 4. Pile foundations for house

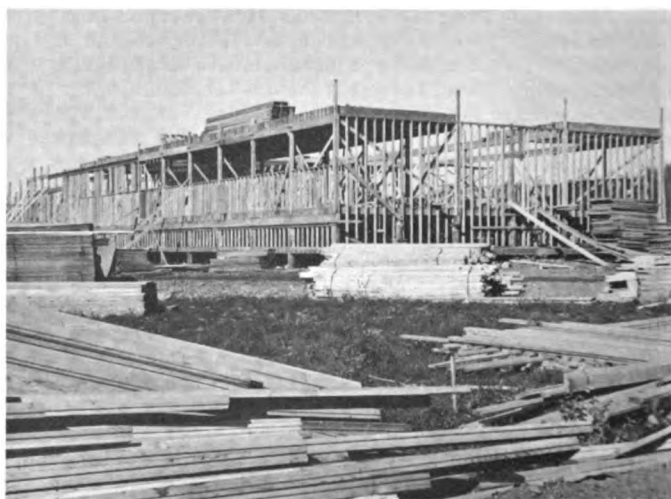

Fig. 5. Pile foundations for hostel. Note airspace, false floor, and crawl space

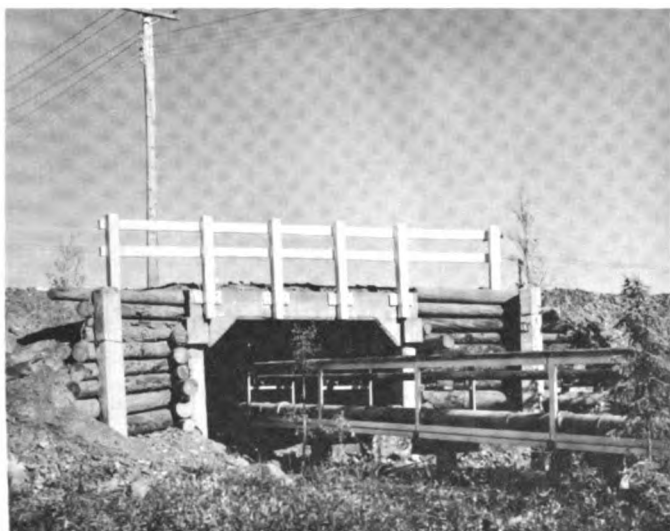

Fig. 6. Concrete and wood piling for bridge and utilidor foundations



Fig. 7. Pile steaming and driving

flange beams (approximately 12 by 15 in.) about 24 ft long.

Preservative treatment of wood piles is necessary to prevent deterioration of the upper portion of the pile which is in thawed soil. All wooden piles, except the pressure-creosoted ones, were treated at the site using a diffusion process. The bark was stripped from the top 6 to 10 ft of each pile, although initially the first few hundred piles were treated for their full length, and the preservative applied by brush to the timber in the form of a paste.

Pile Placement

Satisfactory performance of pile foundations depends upon adequate anchorage of the pile in permafrost. The method by which piles are placed in the ground can have an appreciable effect on refreezing conditions and ultimately on their performance. Normal procedures entail either steam thawing or drilling a hole into which the pile can be driven. At Inuvik, steam thawing of pile locations was used for virtually all foundations. For the two large oil storage tanks and the powerhouse, however, where the piles were closely spaced because of the heavy loads, the piles were placed in drilled holes.

Drilling— At the location of the structures previously noted a truck-mounted seismic "shot-hole" rig was used to drill pile holes. The gravel pad and active layer were penetrated with a 24 in. auger, and a casing, made of 45 gal gas drums, placed in the hole. From the permafrost table, holes were bored with 18 in. dia. augers, having special, hard metal-faced cutting edges, to depths of about 30 ft. Frozen fine-grained soils and ice were readily penetrated by the augers (e.g., 23 ft in 1.5 to 2 hours) but at many locations concentrations of boulders and, at the 23 ft depth, a cemented layer of gravel, prevented, or caused very slow, penetration. When stones were encountered, carefully controlled steaming (10 to 20 psi) was used in order to enlarge the hole so that the stones could be pushed to the side and thus allow passage of the auger.

Steaming— All other piling, e.g., utilidor and building foundations, were placed in steam-thawed holes (Fig. 7). A 50 hp oil-fired portable boiler supplied steam to as many as five 0.75 in. jetting pipes. Boiler gage pressure varied from 100 to 130 psi but was usually maintained at about 115 to 120 psi. Pile locations were steamed from 10 to 20 ft in depth and averaged about 14 ft. The depth and rate of penetration of the steam jets varied considerably and were directly dependant on soil type. Organic material or massive ice was penetrated so

rapidly that the jets had to be held up until the hole exceeded the pile in diameter. In granular materials, which contained many stones, and dense sandy silt the jets had to be forced into the ground. At times stones prevented jet penetration to the depth desired. In these cases a new hole was started immediately adjacent to the old location, or the pile was driven to the depth steamed if the hole was considered deep enough. In some townsite areas, gravels were cemented, at a depth of 8 to 10 ft, by an iron oxide coating which made steaming very difficult.

The difficult steaming conditions encountered in the gravels often resulted in excessive steaming of pile locations at some sites. This oversteaming substantially enlarged the pile holes near the surface (as well as at depth) and caused subsidence of the ground surface due to the thawing of massive ice deposits. The thawed zone surrounding each pile varied, but generally was from 2 to 4 ft in diameter.

Very stony soils also caused trouble during pile driving. Stones were frequently loosened by pile driving and these deflected the pile out of line (as much as 3 ft). In some cases stones were forced to the bottom of the hole so that the pile could not be driven to full depth. A steaming technique was developed by which the steam jet was left at the bottom of the hole to "bell out" or enlarge a thawed area into which stones and boulders could be pushed by the pile as it was driven.

Steaming intervals varied widely over the townsite and even from one pile location to another at one construction site. Observations of steaming intervals, including the time taken for the jet to penetrate to the hole bottom ("sinking" time), the "belling-out" time and the total time, were made during the construction period. Total steaming times for a 14 ft hole ranged from about 1 hour under good steaming conditions in fine-grained soils to about 8 hours at a few locations where steaming was most difficult because of heavy concentrations of stones. In the latter case, because of the excessive steaming, the jet pipe was pulled to the surface without "belling out" the bottom of the hole. Some of the steel piles for utilidor corners and anchor points were placed to a depth of 20 ft and these holes generally required steaming for 4 to 6 hours.

Driving— At the powerhouse and the heated oil storage tanks where holes were drilled, the piles were simply dropped into the hole and a silt- and sand-slurry backfill placed around the pile. At steamed locations a 2000 lb drop hammer was used to drive piles. In most cases the hammer weight was sufficient to force the pile to a depth of from 4 to 8 ft in the steamed hole, and the pile was then driven to refusal. As the pile was driven, the soil slurry resulting from the steam thaw-

ing was forced to the surface. Those piles deflected by stones during driving (some more than 12 in.) had to be realigned. The "straightening" operation consisted of resteaming the hole beside the pile, pulling the pile into line with a winch and then inserting long wooden wedges beside the pile to hold it in position until refrozen (Fig. 8). Although many piles were realigned immediately after placement, some piles had to be straightened from 2 to 4 weeks after the pile had been driven, because wedging was ineffective, until the large thawed zone surrounding the pile at the surface had refrozen.

In an attempt to provide additional anchorage against frost-heave, piles were driven butt-end down for the foundations of the first structures erected. Great difficulty was experienced in driving because the local timber tapered greatly from butt to tip, and stones in the hole wall prevented penetration of the pile. Consequently, except for about 200 piles, all piles were driven tip down.

Depth of Embedment

Only limited information is available with regard to the required depth of embedment of a pile in permafrost. Although some of the load on the pile may be taken by end bearing, it is believed that when the pile is completely frozen into the surrounding soil much of the load is transferred to the permafrost by the tangential adfreezing strength developed between the soil and the surface of the pile. Not only does the adfreezing bond distribute the load to the permafrost but it must also resist frost-heave forces in the active layer. Two factors influence the embedment depth: The depth of the active layer resulting from the presence of the structure over a period of years and the adfreezing strength that will be mobilized by surrounding frozen soil. Because of the information lack on these factors the following "rule of thumb" for embedment of piles in permafrost has generally been followed: "Piles should be embedded in permafrost to a depth equal to at least twice the depth of seasonal freezing and thawing during the life of the building" [13].

Only a qualitative assessment of the potential depth of expected thaw under a building at Inuvik could be made. For design purposes, therefore, some increased thawing was assumed that would result in a maximum depth of thaw of between 4 and 5 ft over a period of years. Thus, using the "rule of thumb," piles should be anchored at least 10 ft in permafrost; i.e., placed to a minimum depth of about 15 ft below ground surface.

For most buildings, holes were steamed to a depth of about 15 ft and the piles were generally driven to within 1 ft of the steamed depth. Steel anchor piles for the utilidor were placed to depths of 15 to 24 ft in steamed holes. Wood piles for oil tanks and powerhouse were placed to a minimum depth of 25 ft in drilled holes.

Pile Refreezing

The refreezing period required for piles placed in permafrost is of utmost importance to a construction schedule. Superstructures cannot be erected until the foundations are adequately anchored in permafrost. Refreezing of piles is dependant on many variables, including the time of year when piles are placed, steaming interval, ground temperatures, soil type, and soil moisture content. Of these, perhaps the most important factor is the steaming interval.

Refreezing observations made at Aklavik in 1953 and at Inuvik in 1955 [2] indicated that, with average or moderate steaming, piles would be refrozen at the 20 ft depth within a few days and at the 10 to 14 ft depths within one month. Shallower depths normally took longer than one month to refreeze depending on the time of year. Excessive steaming prolonged the refreezing period considerably—by as much as several weeks. The need for carefully controlled steaming was therefore emphasized.

Observations made at Inuvik during the construction period showed that piles should not be loaded for from 2 to 6 months, or longer, depending on the time of year they were placed. In particular, a full winter period (at least 6 months) was



Fig. 8. Straightened piles. Note variability of driven depth, wedges, and ground subsidence

required to ensure that piles placed in the fall were adequately anchored and free of movements caused by freezing of the active layer.

CONCLUSION

Pile foundations have long been used with great success in temperate climates to provide support for structures located on materials that are relatively unstable or have low bearing capacity. They have also had considerable application in permafrost areas where they are used to transfer building loads through the unstable active layer to the more suitable and stable permafrost. Certain aspects of pile placement techniques and design criteria differ considerably for foundations in permafrost however.

Methods of placing piles in permafrost (e.g., by steaming or drilling holes) can have an appreciable effect on their performance. Major design considerations include predicting the effect, with respect to thawing, that a structure will have on permafrost and determining what tangential adfreezing strength can be assumed for distributing the load to permafrost and resisting frost-heaving forces. Factors considered in the use of pile foundations at Inuvik, NWT, have been described as an example of the approach taken at that location.

Pile foundations at Inuvik have performed exceedingly well to date. Observations on pile-placing techniques and refreezing characteristics have shown that careful steaming control, particularly during the latter part of the year, is required because of difficult soil conditions. Excessive steaming of pile locations can result in greatly increased refreezing times. Piles placed early in the year (January to May) can usually be loaded within 2 to 3 months. Those placed later in the year may not be adequately anchored (to resist frost-heave occurring in the active layer during the late fall and winter) for periods of six months or more, depending on steaming conditions and refreezing characteristics of the soils encountered.

The large construction program recently completed at Inuvik has shown the success of preplanning the time of foundation placement so as to allow time for refreezing of piles before the superstructure is erected. Construction schedules were rarely disrupted by pile foundations not being ready for loading.

The selection and use of piles as the most suitable foundation type for the majority of the buildings and facilities erected at Inuvik has been justified. Observations are continuing to assess their long term performance.

ACKNOWLEDGEMENT

This paper summarizes the results of field observations by the Division of Building Research and of discussions with many people who have contributed greatly by making available their valuable experience in northern construction.

The interest and cooperation of C. L. Merrill, Project Manager, at Inuvik (1955-57), Department of Northern Affairs and National Resources, is gratefully acknowledged. Sincere thanks are also due Ray Oancia, Department of Public Works Resident Engineer (1957-61) for his assistance and cooperation.

This is a contribution from the Division of Building Research, National Research Council, Canada, and is published with the approval of the Director of the Division.

REFERENCES

- [1] J. A. Pihlainen. "Building Foundations on Permafrost, Mackenzie Valley, NWT, NRC, Canada, Div. Bldg. Res., Tech. Paper No. 8, June 1951.
- [2] J. A. Pihlainen. "Pile Construction in Permafrost," Proc. Am. Soc. Civil Engrs., J. Soil Mech. Foundations Div., Vol. 85, No. SM 1, Part 1, Dec. 1959, pp. 75-95.
- [3] M. E. Essoglov. "Piling Operations in Alaska," Military Engineer, July-August, 1957, pp. 282-287.
- [4] "Frozen-in-Place Piles Support Air Force Building in Alaska," Construction Methods and Equipment, June 1956, pp. 62-64.
- [5] L. A. Meister, P. I. Mel'nikov. "Determinations of

Adfreezing Strength of Wood and Concrete to Ground and Shear Strength of Frozen Ground under Field Conditions," Comm. on Permafrost, Acad. Sci., Moscow, Trudy, Vol. 10, 1940, pp. 85-107.

- [6] L. A. Nees. "Pile Foundations for Large Towers on Permafrost," Proc. Am. Soc. Civil Engrs., Vol. 77, Separate No. 103, Nov. 1951.
- [7] K. A. Linell. "Interim Report on Load Tests of Piles in Permafrost," Proc. 6th and 7th Alaska Sci. Conf., 1955-56, pp. 24-40.
- [8] P. D. Bondarev. "Pile Driving in Frozen Sandy Gravel by Steaming and the Speed of the Re-establishment of the Frozen Condition," Materialy k Osnovam Ucheniia o Merzlykh Zonakh Zemnoy Kory, Vol. 4, 1958, pp. 158-165.
- [9] J. A. Pihlainen, G. H. Johnston. "Permafrost Investigations at Aklavik (drilling and sampling) 1953," NRC, Canada, Div. Bldg. Res., Tech. Paper No. 16, Jan. 1954.
- [10] C. L. Merrill, J. A. Pihlainen, R. F. Legget. "The New Aklavik: Search for the Site," J. Eng. Inst. Canada, Vol. 43, No. 1, Jan. 1960, pp. 52-57.
- [11] G. B. Pritchard. "Inuvik, Canada's New Arctic Town," Polar Record, Vol. 11, No. 71, May 1962, pp. 145-154.
- [12] J. A. Pihlainen. "Inuvik, NWT - Engineering Site Information," NRC, Canada, Div. Bldg. Res. Tech. Paper No. 135, Aug. 1962.
- [13] S. W. Muller. "Permafrost or Permanently Frozen Ground and Related Engineering Problems," U. S. Army, Office of Chief Engineers, Spec. Rept. Strategic Eng. Study No. 62, Aug. 1945.

DESCRIPTION AND CLASSIFICATION OF FROZEN SOILS

K. A. LINELL and C. W. KAPLAR, U. S. Army Cold Regions Research and Engineering Laboratory.

When the Unified Soil Classification System [1] is extended to classification of frozen soils, special expansion of the system is required in order to meet engineering and scientific needs for adequate and concise identification of the materials. Identification of seasonally frozen soil or permafrost according to structural divisions caused by freezing and thawing such as "suprapermafrost" or "annual frost zone," illustrated in Fig. 1, provides no information on those factors of appearance and physical properties that are essential guides to the nature and behavior of the materials in the frozen state and to the changes that may occur on thawing. Also, such identification is not applicable to specimens frozen in the laboratory. Therefore, a frozen soil description and classification system independent of the geologic history or mode of origin of the material is needed. This system should also be flexible enough to provide any desired degree of detail. Such a system is described.

The system can be used with any types of samples that show the natural structure of the material, such as specimens recovered from drill holes or test pits, or frozen in the laboratory. It may sometimes be found that a slightly different classification will be assigned if the material is inspected in full face in a test pit than when a small sample removed from the same location is used, but this will generally have little practical significance.

FEATURES OF THE CLASSIFICATION SYSTEM

The system for describing and classifying frozen soil is shown in Fig. 2. As indicated in the first column of Fig. 2, the frozen soil is identified in three steps denoted as Parts I, II, and III. Under Part I the soil phase is identified independently of the frozen state; the Unified Soil Classification System is used, a summary of which is shown in Fig. 3. Under Part II, the soil characteristics resulting from the frozen state of the material are added to the soil description. Under Part III important ice strata found in the soil are described.

Major Groups

As shown in columns (2) and (3) of Fig. 2, under Part II, frozen soils are divided into two major groups: Soils in which segregated ice is not visible to the unaided eye (designation N), and soils in which segregated ice is visible (designation V). Since, as will be described below, ice layers exceeding 1 in. in thickness are identified separately, the latter major grouping is applied only to soil containing ice layers 1 in. or less in thickness.

Frozen soils in the N group will commonly, on inspection by the unaided eye, reveal the presence of ice within the soil voids by crystalline reflections or by a sheen on fractured or trimmed surfaces; however, the appearance is given that the water has frozen within the original voids in the soil, without segregation. Frozen soils in the V group give the opposite impression, and segregated ice is visible not merely as pin-point crystalline reflections or a diffuse sheen but as separate ice inclusions of measurable dimensions.

Frozen Soils in which Segregated Ice is not Visible

As shown in columns (4) and (5) of Fig. 2, materials in which segregated ice is not visible to the unaided eye are divided into two types:

Nf (friable)—This is poorly bonded or friable material in which segregated ice is not visible to the unaided eye. This condition exists when the degree of saturation is low. This type of frozen soil is illustrated in the lower portions of photographs 1 and 2 of Fig. 4.

Nb (bonded)—This is well bonded frozen soil in which the ice cements the material into a hard solid mass, but segregated ice is not visible to the unaided eye. Soils showing this characteristic are at a moderate to high degree of saturation. When at high degree of saturation, they may or may not contain substantial quantities of microscopic segregated ice. On the basis of detailed examinations and tests this subgroup

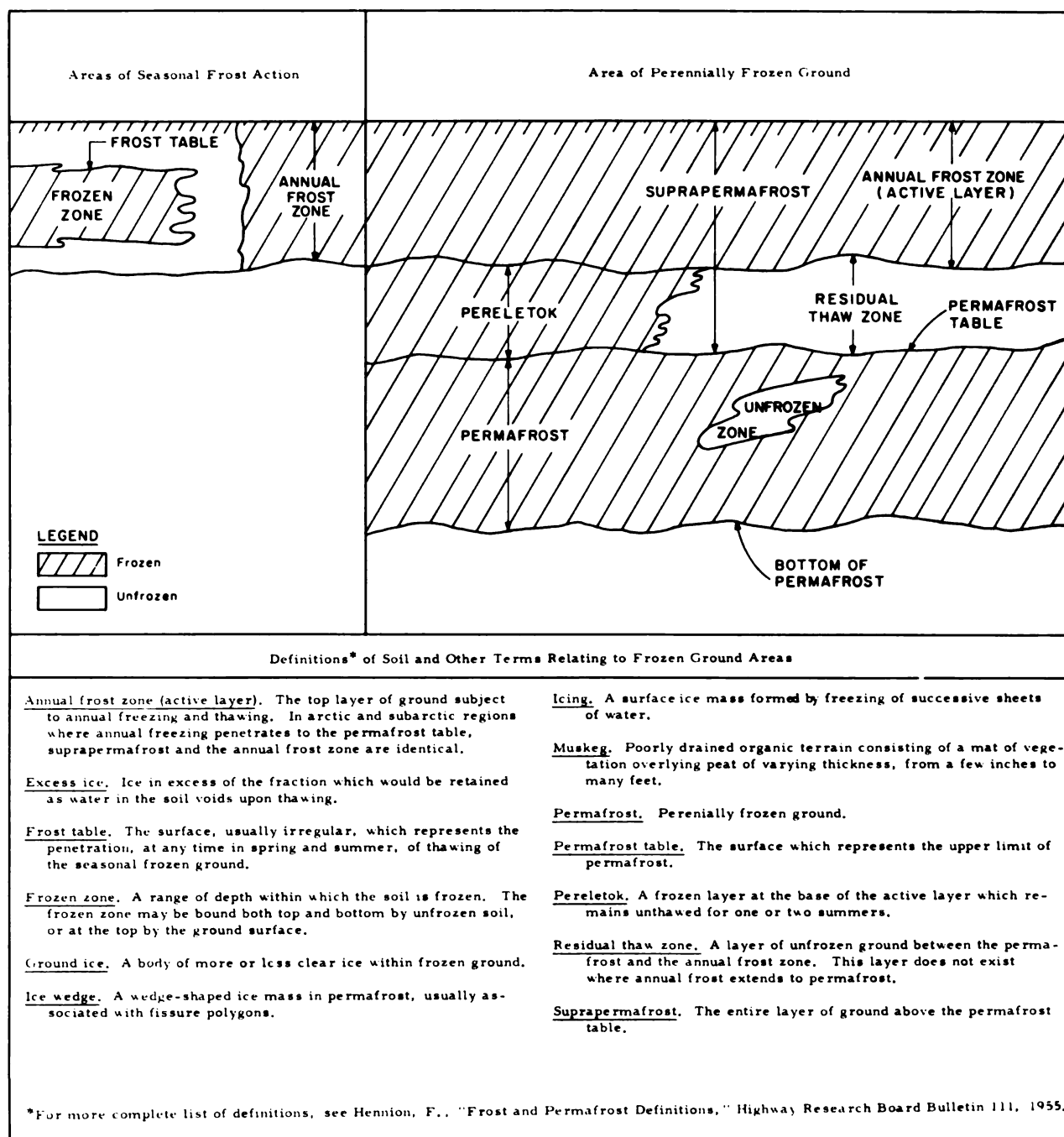

Fig. 1. Illustration of frozen soil terminology

may be further divided into the following subcategories:

Nbn (without excess ice)—No segregated ice is present, either visible to the unaided eye or microscopic. This type of frozen soil is illustrated in photographs 1 and 3, Fig. 4.

Nbe (contains excess ice, microscopic)—This condition may occur in very fine silty sands or coarse silts where excess ice is present but is so uniformly distributed that it is not readily apparent to the unaided eye. Appreciable settlement may occur in such soils upon thawing. This type of frozen soil is illustrated in photograph 4, Fig. 4.

Frozen Soils in which Ice is Visible

The soils in which significant segregated ice is visible to the unaided eye (designation V) are divided into the following four subgroups, arranged approximately in sequence of

increasing ice content as commonly encountered: Vx (individual ice crystals or inclusions), Vc (ice coatings on particles), Vr (random or irregularly oriented ice formations), and Vs (stratified or distinctly oriented ice formations). The Vc type of frozen soil is shown in photograph 5, Fig. 4; Vr types of frozen soils are illustrated in photographs 6 and 7, Fig. 5, and Vs types in photographs 8, 9, and 10, Fig. 5.

Description of Substantial Ice Strata

Referring to columns (2) and (3) of Fig. 2, under Part III, substantial ice strata greater than 1 in. in thickness are designated separately as ICE. As shown in columns (4) and (5), the identification may fall into either of the following two broad categories: ICE plus Soil Type (ice with soil inclusions) and ICE (ice without soil inclusions).

Classify Soil Phase by the Unified Soil Classification System									
(1) DESCRIPTION OF SOIL SAMPLE (Include State of Freeze State)	Major Group		Sub-Group		(6) Field Identification	(7) Pertinent Properties of Frozen Materials Which May Be Measured by Physical Tests to Supplement Field Identification	(8) The Characteristics	(9) Criteria	(10) Guide for Construction on Soils Subject to Freezing and Thawing
	(2) Description	(3) Designation	(4) Description	(5) Designation					
PART II DESCRIPTION OF FROZEN SOIL	Soreacted ice is visible by eye (b)	H	Poorly bonded or friable	MF	Identify by visual examination. To determine presence of excess ice, use procedure under note (c) below and hand magnifying lens as necessary. For soils not fully saturated, estimate degree of ice saturation: Medium, low, or none. Record presence of ice crystals, or of ice coatings around larger particles.	In-place Temperature Density and Void Ratio a. In Frozen State b. After Thawing in Place Water Content (total H ₂ O, including ice) a. Average b. Distribution Strength a. Compressive b. Shear c. Adhesive d. Adhesive Elastic Properties Plastic Properties Thermal Properties Ice Crystal Structure (using optical instruments) a. Crystal Size b. Crystal Shape c. Crystal Arrangement d. Pattern of Arrangement	Ideally thaw-stable	The potential intensity of ice segregation in a soil is dependent on its pore space and the amount of water. The purpose may be expressed as an empirical function of grain size as follows: Most inorganic soils containing 3 percent or more of grains finer than 0.02 mm in diameter by weight are frost-susceptible for pavement design purposes. Gravels, well-graded sands and silts, and silty sands are frost-susceptible for structural applications. Soils with a maximum dry density curve which contains 1/2 to 3 percent finer by weight than 0.02 mm size should be considered as possibly frost-susceptible and should be subjected to a standard laboratory frost susceptibility test to evaluate actual behavior. For soils with a maximum dry density curve which contains 10 percent or more finer by weight than 0.02 mm size, frost-susceptibility is considered as highly frost-susceptible. However, their tendency to occur interbedded with other soils usually makes it impractical to consider them separately. Soils classified as frost-susceptible under the above pavement design criteria are likely to develop significant frost heave if frozen at normal rates with free water readily available. Soils so frozen will fall into the thaw-stable category. However, they may also be classified as thaw-stable if frozen with insufficient water to permit ice segregation.	Guide for Construction on Soils Subject to Freezing and Thawing
			Individual ice crystals or inclusions	Vh					
	Ice coatings on particles	V	Ice coatings on particles	Vc	Estimate volume of visible segregated ice present as percent of total sample volume.	Same as Part II above, as applicable, with special emphasis on Ice Crystal Structure.	Ideally thaw-stable	Soils classified as non-frost-susceptible under the above criteria usually occur without significant ice segregation and are usually thaw-stable for pavement applications. However, the criteria are not exact and may be inadequate for some structure applications; exceptions may also result from prior soil variations. In permafrost areas, ice wedges, pockets, veins, or other ice bodies may be found whose mode of origin is different from that described above. Such ice may be the result of long-time surface expansion and contraction phenomena or may be glacial or other ice which has been buried under a protective earth cover.	
				Random or irregularly oriented ice formations	Vr				Designate material as ICE (d) and use descriptive terms as follows, usually one item from each group, as applicable: Hardness Structure Color Remarks (Examples): (Example): HARD CLOUDY SOFT CONCRETE POORLY GRANULAR CRYSTALLINE STRATIFIED
PART III DESCRIPTION OF SUBSTRATE ICE STRATA	Ice (greater than 1 inch thickness)	ICE	Ice with soil inclusions	Ice + soil type	Designate material as ICE (d) and use descriptive terms as follows, usually one item from each group, as applicable: Hardness Structure Color Remarks (Examples): (Example): HARD CLOUDY SOFT CONCRETE POORLY GRANULAR CRYSTALLINE STRATIFIED	Poorly-bonded simulates that the soil particles are weakly held together by the ice and that the frozen soil consequently has poor resistance to chipping or breaking. Friable denotes extremely weak bond between soil particles. Material is easily broken up. Thaw-stable frozen soils do not, on thawing, show loss of strength below normal. Long-time thaw values may produce detrimental settlement. Normal, long-time thaw values and/or significant settlement, as a direct result of the melting of the excess ice in the soil.	The letter symbols above are to be affixed to the Unified Soil Classification letter designations or may be used in conjunction with graphic symbols, as shown in the log-log or geotechnical profiles. Examples - a lean clay with essentially horizontal ice lenses.	The descriptive name of the frozen soil type and a complete description of the frozen material are the fundamental elements of this classification scheme. Additional descriptive data should be added where necessary. The letter symbols are secondary and are intended only for convenience in preparing graphical presentations. Since it is frequently impractical to describe ice formations in frozen soils by means of words alone, sketches and photographs should be used where appropriate, to supplement descriptions. The abbreviation n/s is commonly used to designate non-frost-susceptible materials on exploration logs and drawings.	
			Ice without soil inclusions	Ice					When rock is encountered, standard rock classification terminology should be used. Frozen soils in the H group may, on close examination, indicate presence of ice within the voids of the material by crystalline reflections or by sheen on fractured or broken surfaces. In such cases, the presence of ice should be noted in the field notes. The frozen water occupies space in excess of the original voids in the soil. The opposite is true of frozen soils in the V group. (c) When visual methods may be inadequate, a simple field test to aid evaluation of volume of excess ice can be made by placing some frozen soil in a small jar, allowing it to melt and observing the quantity of supernatant water as a percent of total volume. (d) Where special forms of ice, such as hair frost, can be distinguished, more detailed description should be given. (e) Observer should be careful to avoid being misled by surface scratches or frost coating on the ice.

Fig. 2. Description and classification of frozen soils

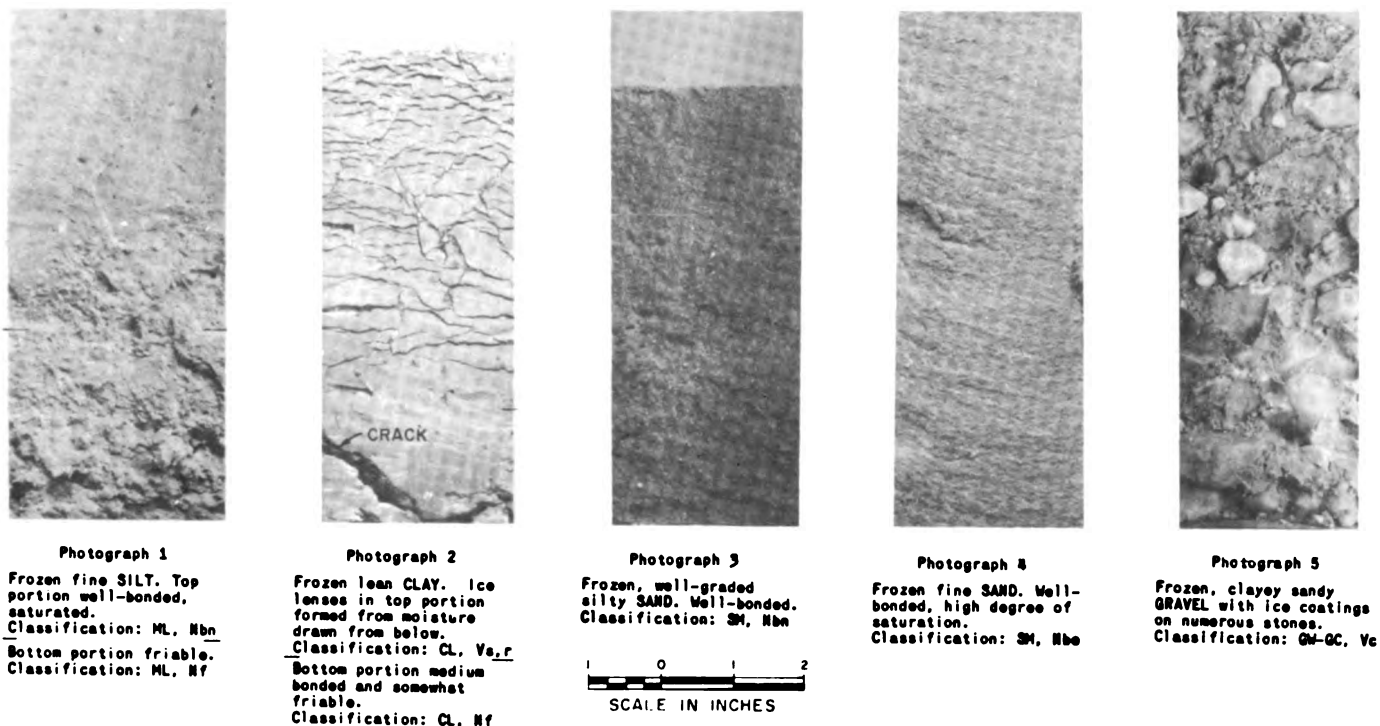

Fig. 4. Frozen soil types

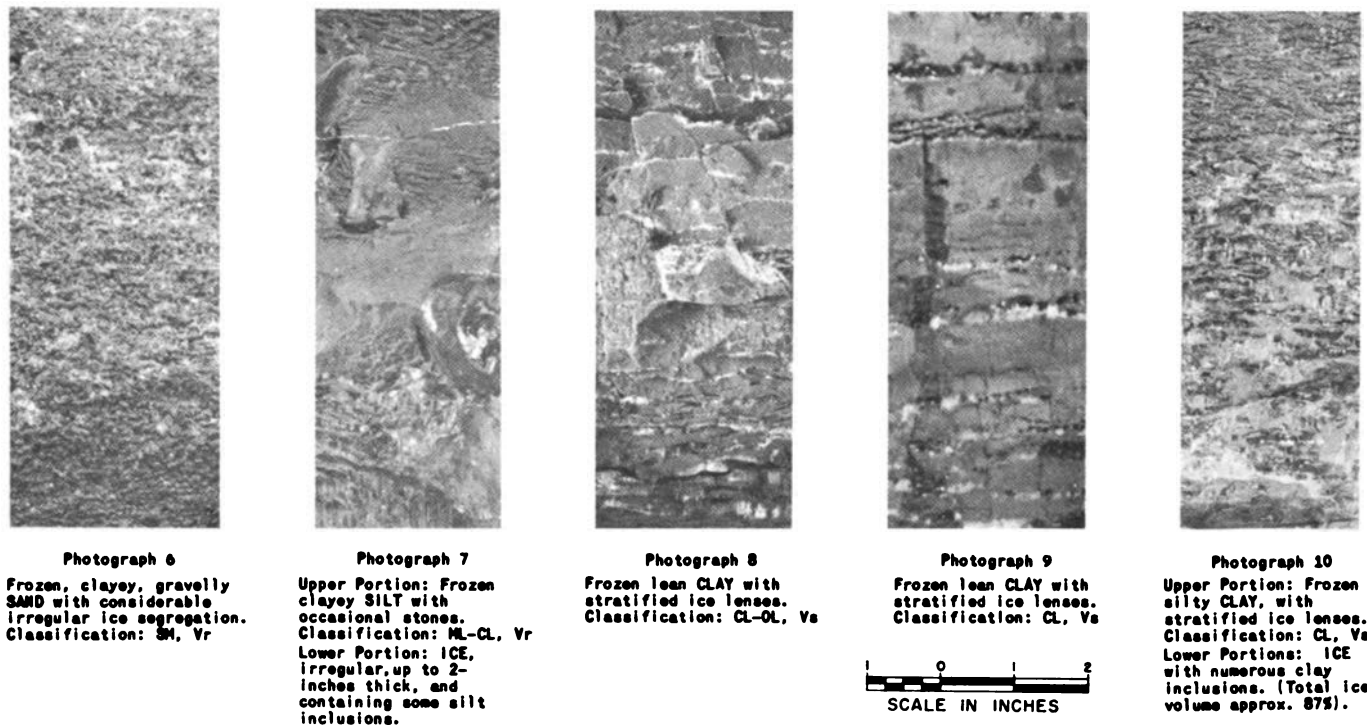

Fig. 5. Frozen soil types

Identification and Description

Field identification guidance is presented in column (6) of Fig. 2. In addition to determination of major group and subgroup in accordance with columns (2) through (5) of Fig. 2, additional descriptive terms and data may be used as indicated. Some of the soils found in permafrost regions may also be described in exploration logs by special terms (such as "muskeg") for additional clarification.

When more than one subgroup characteristic is present in the same material, multiple subgroup designations may be used, as Vs,r. Photograph 2, Fig. 4, shows an example of frozen soil of the latter type.

When more detail and specific information is desired than from visual inspection, frozen soil can be tested and properties measured as indicated in column (7) of Fig. 2. A camera, a small-power hand magnifying lens, and graduated jars should be standard items of field equipment for soil and survey

crews. To obtain a rough estimate of the possible presence of excess ice, a simple field test can be made by placing a lump of frozen soil in a jar, allowing it to melt, and observing the relative volume of supernatant or free water standing above the soil after the lump has melted. By initially testing on specimens of known ice content, a basis for field judgement can be established. Since proportions of ice and soil may vary widely, it may sometimes be difficult to decide without such a test whether a given material falls, for example, in the category of frozen soil or of ice with soil inclusions. Material containing as much as 80% ice by volume and only 20% soil can sometimes give the appearance of being mostly soil. When more exact evaluation of presence of excess ice is required, specimens may be thawed in the laboratory in consolidometers or rubber membranes, or material may be thawed in place in the field.

Only needed portions of the detail and descriptive material outlined in columns (4) through (7) of Fig. 2 should be used. In many of the simpler engineering applications, only a few of the most important elements need be recorded. For many investigations it will be found satisfactory to use the Nb designation without breakdown into Nbn or Nbe categories, or it might even be sufficient to use only the N and V major group designations, to indicate whether or not segregated ice is visible. On the other hand, in many scientific studies very detailed records may be necessary.

Thaw Characteristics

For engineering purposes, it is very important to know whether significant settlement will take place upon thawing of the frozen soil. If the amount of ice present will produce more water upon melting than can be held in the voids of the soil, then it is thaw-unstable material to a degree dependent on amount of excess ice and soil density. If all the melt water can be absorbed by the soil voids without significant settlement, then it can be considered thaw-stable soil. Columns (8) and (9) of Fig. 2 present guides for construction on soils subject to freezing and thawing. The thaw characteristics shown in column (8) are particularly significant. Nf and Nbn are usually thaw-stable soils; that is, no detrimental settlement of structures would normally be anticipated if thawing occurred. All other subgroups are potentially thaw-unstable soils, and significant settlement of structures founded on them may occur.

Frozen openwork gravel is a special type of material which often proves difficult to evaluate as to its thaw-settlement potential. Although substantial amounts of pure ice are apparent in the voids of such material, sufficient point contacts between particles may exist to limit settlement on thaw to minor amounts. In critical cases, field thaw-settlement tests, using loaded plates and steam thawing, may be necessary.

Frozen bedrock does not always provide a thaw-safe foundation. Therefore, when bedrock is encountered in subfreezing temperatures, careful observations should be made to determine the quantity and mode of occurrence of all ice formations in bedding planes, fissures, or other spaces.

ICE OR WATER CONTENT OF FROZEN SATURATED SOILS

In considerations involving frozen soils, the generally prevailing conditions include complete saturation of the soil phase and all of the water frozen. For these conditions, and assuming a specific gravity of the soil particles of 2.70, the relationships between the unit dry weight of soil, water content, and ice volume are shown in Fig. 6. This chart may be used by designers or field engineers for rapid estimation of the relationships between these variables. Use of the chart is indicated by the following example and illustrated by lines and arrows on Fig. 6. Assume a specimen of frozen silt with excess ice estimated at approximately 60%. Based on the appearance of the silt layers in the core, it is estimated that the normal dry unit weight of the silt is fairly high, say 95 pcf. The chart is then entered at 95 pcf on the left and a horizontal

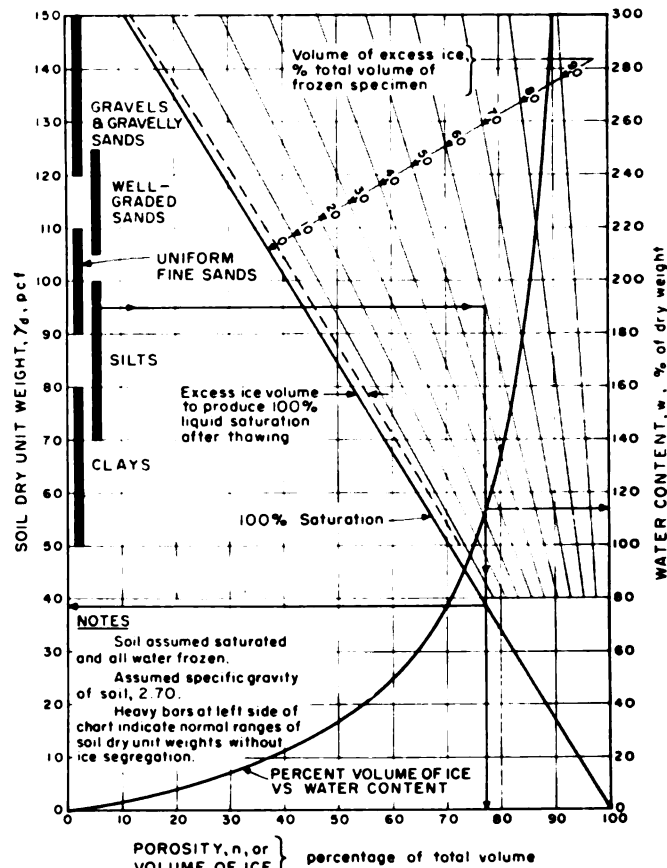

Fig. 6. Soil dry unit weight, ice volume, and water content relationships

Depth	Symbol	SOIL DESCRIPTION	ICE FEATURES
0.0 ft	OL	Organic, sandy SILT, not frozen	None
0.5	GW	Brown, well-graded, sandy GRAVEL, medium compact, moist, not frozen	None
1.8	GW Nf	Brown well-graded, sandy GRAVEL, frozen, poorly bonded	No visible segregation, negligible thin ice film on gravel sizes and within larger voids
1.7	GW Nbn	Brown, well-graded, sandy GRAVEL, frozen, well bonded	No visible segregation
5.4	ML V _s	Black, micaceous, sandy SILT, frozen	Stratified horizontal ice lenses averaging 4 inches in horizontal extent, hairline to 1/2 inch thickness, 1/2 to 1 inch spacing. Visible excess ice ~ 20% of total volume. Ice lenses hard, clear, colorless.
7.7	ICE		Hard, slightly cloudy, colorless, few scattered inclusions of silty SAND
9.1		Dark brown PEAT, frozen, well bonded, high degree of saturation	~ 5% visible ice
10.5	MH V _r	Light brown SILT, frozen	Irregularly oriented ice lenses and layers 1/2 to 1 inch thick on random pattern grid approx. 1/2 to 4 inch spacing. Visible ice ~ 10% of total volume. Ice moderately soft, porous, gray-white.
14.3			
16.0		Bedrock. Laminated SHALE Top few feet weathered	1/16 inch thick ice lenses in fissures to 16.0 ft. None below
20.6		Bottom of exploration	

* Surface elevation 961.2 ft

Fig. 7. Frozen soil classification system in typical exploration

line is extended to the intersection of the sloping 60% excess ice line. The total porosity (n) which in this case equals the proportion of ice volume of the total specimen, is then observed on the scale at the bottom of the plot (77%). The intersection of the vertical line (77% porosity) with the 100% saturation line indicates on the left side scale the equivalent over-all dry unit weight of the frozen specimen, i.e., 38 pcf. The curve in Fig. 6 marked "Percent Volume of Ice vs Water Content" shows the relationship between water content of a frozen specimen and total volume of ice or porosity (n). For a porosity of 77% in the above example, the water content indicated by the right side scale would be approximately 114%.

GRAPHICAL PRESENTATION OF SOILS DATA

It is customary to present the results of soils explorations on drawings as schematic representations of the borings or test pits; various soils are shown by appropriate symbols. The recommended procedure for graphical presentation of frozen soil classification consists of showing the applicable letter symbols for the soil phase in accordance with the Unified Soil Classification System for unfrozen soils, followed by the frozen soil designation (Fig. 7). For readily identifying the frozen soil zones, a wide line is drawn down the left side of the graphic log of the exploration within the ranges that the

frozen materials occur.

REFERENCE

[1] U. S. Army Waterways Experiment Station. "The Unified Soil Classification System," *Tech. Mem. No. 3-357*, Vol. 1 and Appendixes A and B, March 1953 (revised April 1960).

ACKNOWLEDGMENT

Columns (1) through (6) of Fig. 2 represent joint efforts of the Bldg. Res. Div. (NRC of Canada) and of the ACFEL, U. S. Army Engineering Div., New England. It is based on several years' experience with various forms of a system devised in 1952 by ACFEL. The remainder of Fig. 2, and of the paper, is a contribution of the former Arctic Construction and Frost Effects Laboratory (combined in 1962 with the U. S. Army SIPRE to form the U. S. Army CRREL). This is part of a program of studies being conducted for the Chief of Engineers, Dept. of the Army. The program is aimed at developing engineering criteria for design and construction in arctic and subarctic regions and in areas of seasonal frost. The authors are grateful for help from H. Brian Dickens and John A. Pihlainen, Canada; A. Casagrande, Harvard Univ.; Prof. K. B. Woods, Purdue Univ.; and Thomas Pringle and Frank Hennion, Office, Chief of Engineers.

THE LONG THERMOPILE

E. L. LONG, Alaska Corps of Engineers

The Long thermopile is a seasonal self-refrigerating foundation support or anchor with a high conductivity of heat out of the ground and a high resistance to heat flow into the ground. When properly used, the Long thermopile will maintain a permanently frozen soil condition near the pile.

The thermopile depends on rapid withdrawal of heat from a foundation area during periods of below freezing weather by vaporization-condensation cycling. A thermal inversion prevents vaporization of the charging liquid whenever the column or condensation area becomes warmer than the liquid containing portion of the pile.

ADVANTAGES

The greatest advantage in using a thermopile for a foundation is to prevent degradation of frozen soil that has a low dimensional freeze-thaw stability or has an unsatisfactory bearing capacity in the thawed condition. Piles are designed to provide additional refrigeration individually or the supercooling necessary to prevent permafrost degradation.

Increased bearing can be obtained by maintaining frozen soil at lower temperatures. Tsytoich and Sumgin [1], Tsytoich [2], Khomichevskaja [3], Kersten and Cox [4], and Frost Effects Laboratory [5] generally show compressive strength gains of 2 to 7 tons/sq ft for each Fahrenheit degree of reduction in temperature. Creep effect will reduce to some degree the long term strength gain from reduced temperatures [5].

"Frost jacking" of piles can be eliminated without requiring deep foundations. The portion of the pile column in the active frost layer acts as a condensation area warming the adjoining soil (Fig. 3) and, in a permeable material, actually causes the moisture to move away from the column toward the colder adjoining frost, weakening the adfreeze bond at that point. Soil freezing also occurs radially from the pile surface leaving no expanding soils adjacent to the pipe column shortly after the start of the winter season (Fig. 6).

Changes in elevation are generally limited to thermal expansion and contraction of the pile or soil. In fine-grained clay soils, small movements can result from below 32°F

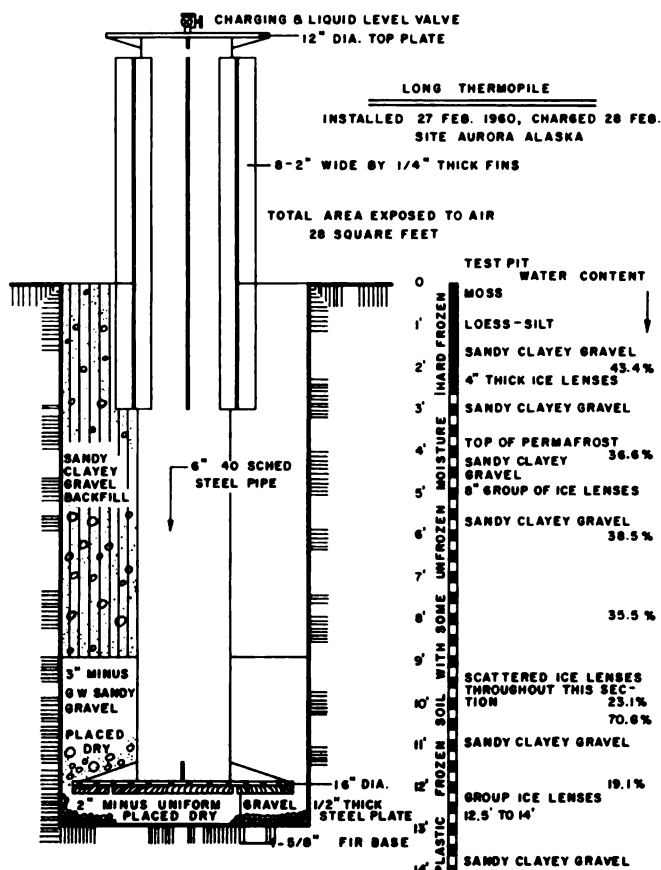

Fig. 1. Long thermopile at Aurora, Alaska

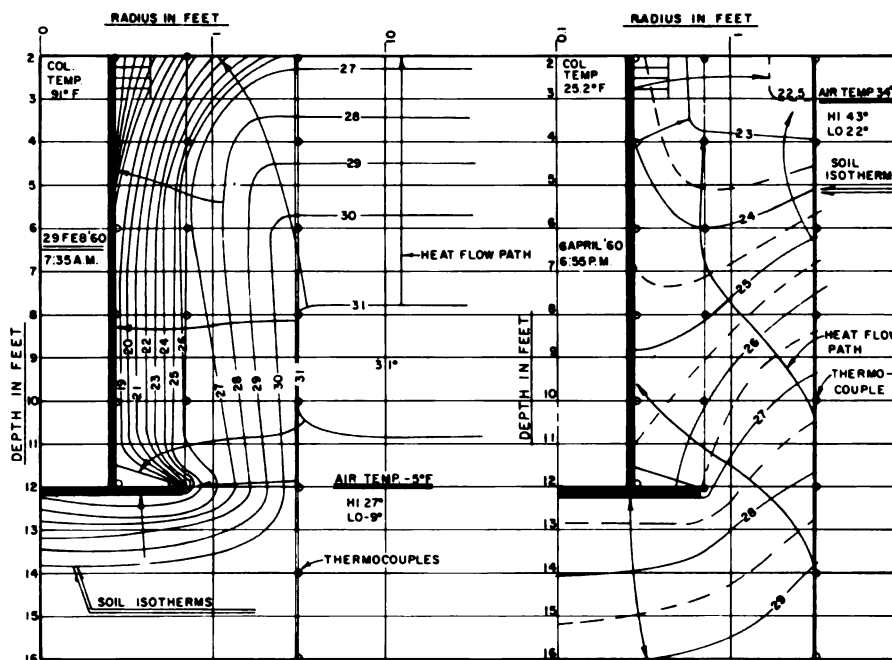

Fig. 2. Soil isotherms of 29 Feb. 1960

Fig. 3. Soil isotherms of 6 April 1960

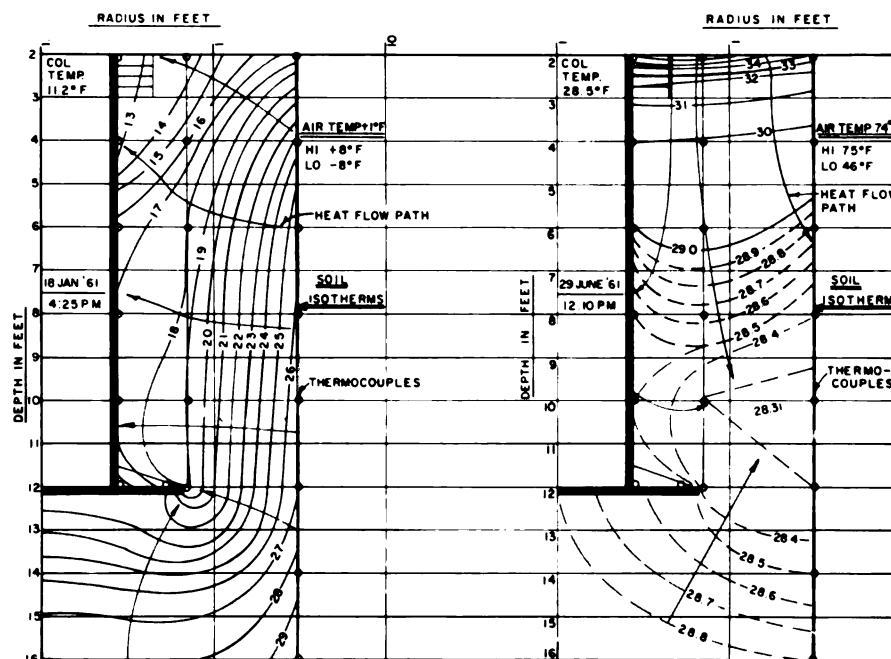

Fig. 4. Soil isotherms of 18 Jan. 1961

Fig. 5. Soil isotherms of 29 June 1961

temperature change causing a variation in the quantity of unfrozen water in the generally frozen soil. The greatest stability is obtained at the lowest practical permafrost temperature.

EXISTING INSTALLATIONS

Piles constructed to date have varied from 2 in. pipe, with frictional bearing, to three pipe clusters of 12 in. pipe attached to and bearing on a 3 in. thick, 5 ft square base plate. Condensation areas on thermopiles have been provided by the exposed portion of the piles and by connected finned radiation. Most installations in marginal permafrost areas are more economical when designed for end bearing. They

then eliminate the need for separate refrigeration of the piles when constructed below the top of permafrost in above freezing weather. Propane has been the charging liquid. Economical and readily available, this refrigerant can operate efficiently in the required range of 32° to -60° F with maximum pressures of less than 60 psi. Excess charging liquid has been discharged to the atmosphere from some installations to effect freezing prior to the first winter season. The gas is burned as it is discharged. The propane can also be cycled as a normal refrigerant to stabilize friction piles rapidly in warm weather in order to accelerate construction.

Pile installations using end bearing have been constructed entirely of steel as well as of concrete or timber attached to the bottom face of steel column end plates.

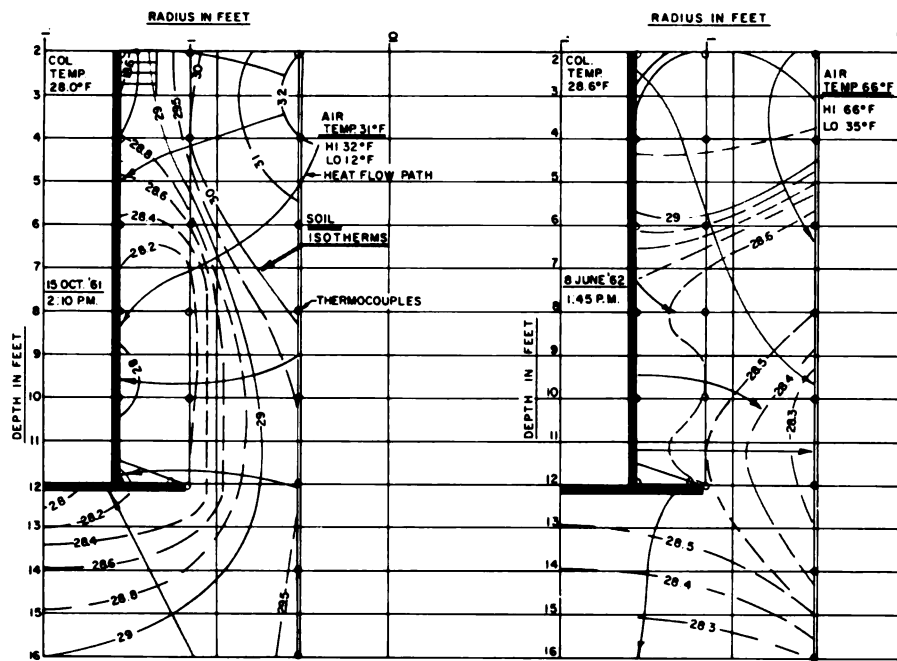

Fig. 6. Soil isotherms of 15 Oct. 1961

Fig. 7. Soil isotherms of 8 June 1962

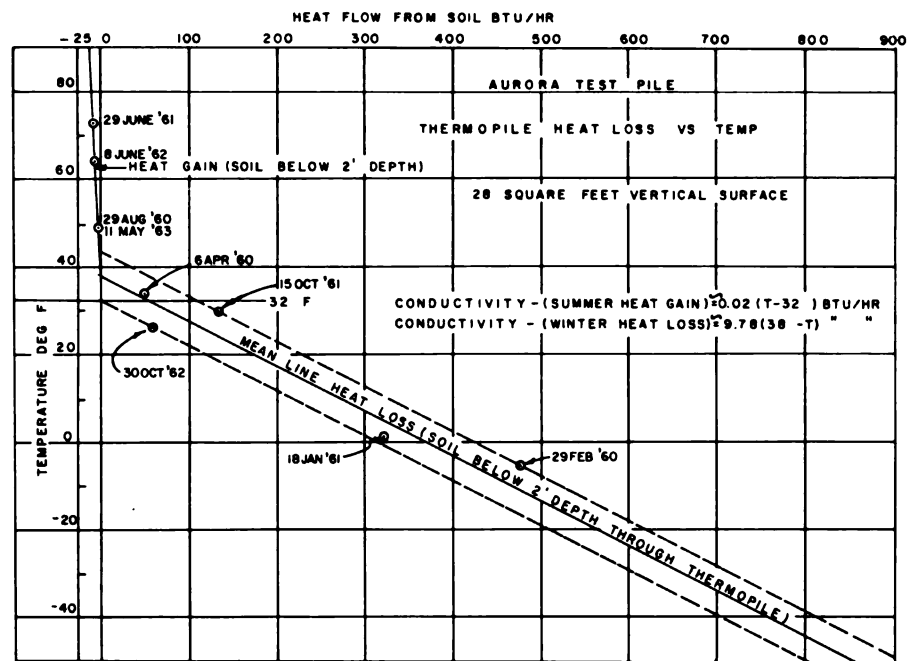

Fig. 8. Aurora test pile of thermopile heat loss versus temperature

The Aurora and Glennallen communication sites constructed by the Corps of Engineers in 1960 used the Long thermopile for tower, wave guide, and building foundations as the most promising foundation for the soil conditions encountered. This thermopile was used with the knowledge that, if the amount of cooling was inadequate, the natural vapor method could be converted to a refrigeration cycle by adding refrigeration units without altering the constructed foundations. All foundations were satisfactory except one tower footing located within 20 ft of a buried uninsulated steam manhole. Two of the three 12 in. columns acting as thermopiles continued operating while the third was purged of propane and modified to a Freon refrigeration cycle to provide the additional cooling required at that location. The building foundations at Aurora

were scheduled to be nonthermopile installations with provisions for converting if necessary. The discovery, however, of a thawed aquifer 13 ft below ground surface, with a water temperature of 34°F, dictated that all piles be converted to thermopile design. The footing area has remained frozen since the winter of 1961-1962 with no noticeable building movement.

THERMAL ANALYSIS

A test pile constructed by the Alaska District Corps of Engineers in February 1960 and installed at Aurora is used here to analyze the heat flow to and from a thermopile. Fig. 1 is a sketch of the Aurora test pile with a log of the nearest test pit. Fig. 2 shows the soil isotherms and direction of heat

flow immediately after installation and activation of the thermopile. The formula for resistance due to cylindrical heat flow is used; thermal conductivity of frozen, sandy, clayey gravel is 2.0 [6].

$$R = \frac{\log_e r_o / r_i}{2 \pi K N} \quad (1)$$

The thermal conductivity of the backfilled dry sand, gravel, and compacted frozen chunks of the excavated material was approximately 0.78, which is a reasonable value. Inward heat flow was 439 Btu/hour plus 34 Btu/hour change in specific heat content. Fig. 3 shows the continuation of the cooling process below ground level at 34°F (air temperature).

The soil isotherms of Fig. 4, 11 months after the original installation, show a lower temperature gradient in the back-filled soils and a higher temperature gradient in the *in situ* soils. Comparison with Fig. 2 shows that moisture contents of the backfill would have to increase while the in-place soil moisture decreased. Adjusted conductivities for uniform flow give a K of 2.5 for the backfill and 0.85 for the *in situ* material between the two outer thermocouple strings. Heat flow was determined from

$$q = \frac{\Delta T}{R} \quad (2)$$

with ΔT being the temperature across the soil layers analyzed. Figs. 5 and 7 on June of 1961 and 1962, respectively, show the heat flow into the ground through the steel shell of the thermopile. The heat flow was approximately 10 Btu/hour. A separate determination for 11 May 1963 gave 7 Btu/hour at 46°F (air temperature). Fig. 6 shows the soil isotherms and direction of heat flow prior to refreezing of the active soil layer. The heat flow determinations are plotted against ambient air temperatures in Fig. 8 with envelope and mean line curves. Heat conduction from the soil in winter is approximated as

$$q = 9.78(38 - T) \quad (3)$$

Heat conduction to the soil in summer is approximated by

$$q = 0.02(T - 32) \quad (4)$$

Temperatures from copper-constantan thermocouples were calculated to 0.01°F for determination of isotherm locations.

Mean temperatures (°F) based on Gulkana Airport weather are as follows:

	Av. Temp.	No. Days Above or Below 32°F
Winter '60-61	8.0	186 below
Summer '61	48.5	173 above
Winter '61-62	2.8	185 below
Summer '62	47.3	193 above
Winter '62-63	9.5	193 below

Using empirical equations (3) and (4) and the above weather data, the following (Btu) is obtained:

	Heat Loss	Heat Gain
Summer '60	. . .	1.43 x 10 ³
Winter '60-61	1.31 x 10 ⁶	. . .
Summer '61	. . .	1.37 x 10 ³
Winter '61-62	1.43 x 10 ⁶	. . .
Summer '62	. . .	1.27 x 10 ³
Winter '62-63	1.29 x 10 ⁶	. . .
Average	1.34 x 10 ⁶	1.33 x 10 ³

Ratio of heat outflow to heat inflow through thermopile equals 1000. Yearly net heat outflow (1.34 x 10⁶/28 sq ft) equals 47,500 Btu/sq ft of exposed surface.

Fig. 9 presents footing base plate temperatures of thermopile units under the Glennallen, Alaska, Communication System (ACS) Station Boiler Plant. The temperature obtained can serve as a guide for greater refinement in the sizing of future thermo-

pile units due to their varying exposure to the sun and to their location under a structure.

Ground temperatures obtained at the base of the thermopile units are controlled by the surrounding soil temperature, amount of heat withdrawn by each thermopile unit, number and spacing of the thermopile units, and soil conductivity. During a warm winter or one of high snow cover, general soil temperature will rise; during winters of low snow cover or lower than normal temperatures soil temperature will fall. The cooler temperatures maintained under a thermopile-supported building will permit lower temperatures than the same number and capacity of thermopile units supporting antennas or other structures that do not shade the ground. Thermopile units installed to date have shown reduction in ground temperature from 1° to 5.3°F when measured during continuously thawing weather with air temperatures in excess of 45°F.

SURFACE EMISSIVITY AND CONVECTION HEAT LOSSES

Calculated heat loss of the Aurora test pile based on column temperature is from 1.1 to 1.2 Btu/(hour)(sq ft)(ΔT). Test column surface coating is one brush coat of white lead paint.

Data obtained by the author based on emissivity of water-filled tin cans (painted white and having insulated bases and caps) showed heat losses of 1.8 to 2.0 Btu/(hour)(sq ft)(ΔT) at temperatures ranging from -4° to -9°F and with test units located 10 ft from a heated insulated house.

A pipe 5 ft long and 2 in. in dia. (24 fins, each 4.25 in. by 4.25 in. per foot of pipe, sprayed with one coat of titanium paint) gave a heat loss of 1.2 Btu/(hour)(sq ft)(ΔT) at 19°F with no measurable air movement.

All service installations of the thermopile constructed in 1960 and 1961 were painted with a 6 mil min thickness of white lead paint while more recent installations have required a titanium oxide formulation.

Thermopile units at Glennallen ACS Station Boiler Plant were unpainted during the period for which tests results of Fig. 9 were obtained.

THERMOPILE OPERATING PRESSURES

All thermopile units operate at constant volume. The test pile used a fairly pure commercial propane. Measured pressures of 33.1 to 50.6 psi have been recorded. This will compare to 46.8 to 64.3 psi at the site elevation of 1884 ft. The test pile has operated through all cold weather since its initial installation.

Several wave guide and building thermopile supports have lost their charge through leaky fittings. Correction of the

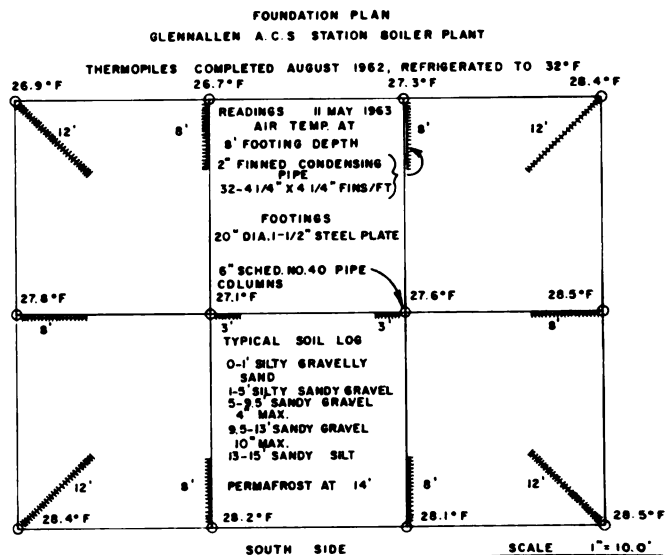

Fig. 9. Foundation plan of ACS station boiler plant at Glennallen

Figure 10: Absolute Pressure versus Temperature
 (minus 32° to plus 32° F)

30 17.12	31 17.27	32 17.43	33 17.60	34 17.77	35 17.94	36 18.12	37 18.30	38 18.48	39 18.66
20 57.84	21 58.05	22 58.27	23 58.50	24 58.74	25 58.98	26 59.23	27 59.48	28 59.74	29 60.00
10 46.10	11 46.36	12 46.63	13 46.91	14 47.19	15 47.48	16 47.77	17 48.07	18 48.37	19 48.68
0 34.90	1 35.17	2 35.45	3 35.73	4 36.02	5 36.31	6 36.61	7 36.91	8 37.21	9 37.52
-10 23.94	-9 24.19	-8 24.45	-7 24.72	-6 24.99	-5 25.27	-4 25.55	-3 25.83	-2 26.12	-1 26.41
-20 12.60	-19 12.91	-18 13.23	-17 13.56	-16 13.89	-15 14.23	-14 14.57	-13 14.92	-12 15.28	-11 15.63
-30 9.75	-29 10.01	-28 10.28	-27 10.56	-26 10.84	-25 11.12	-24 11.41	-23 11.70	-22 11.99	-21 12.29
-40 7.45	-39 7.65	-38 7.86	-37 8.08	-36 8.30	-35 8.52	-34 8.74	-33 8.96	-32 9.18	-31 9.41
-50 5.70	-49 5.85	-48 6.01	-47 6.18	-46 6.35	-45 6.52	-44 6.70	-43 6.87	-42 7.05	-41 7.23

Fig. 10. The upper number in each square is the temperature (°F) and the lower number is the pressure (psi). A less pure product will show higher pressures

fitting has remedied the problem in each case. The loss of propane through leakage does provide additional temporary cooling. Leaks that occur are too small to provide a hazard. The ventilated type of raised structure configuration used in permafrost foundation design prevents any accumulation of gases near the structure.

All thermopile units using liquified petroleum products are constructed to meet the standards of the National Board of Fire Underwriters for the Storage and Handling of Liquified Petroleum Gases and the ASME Boiler and Pressure Vessel Code for Unfired Pressure Vessels. All installations are required to be tested along all joints, fittings, and valves with a soap solution to detect any leak.

Several installations have used a commercial grade of propane that gave approximately 5 to 8 psi greater pressure for a given temperature than that shown in Fig. 10. Although purging of the units will get rid of air and some of the contaminating gas, it cannot all be eliminated. Recent installation restricts the use of propane, which does not check within ± 1 psi of that shown in Fig. 10, as a better assurance of maximum efficiency.

Carbon dioxide can be used with many other materials in lieu of propane as a charging fluid; however, the characteristics of propane combined with its cost and availability have made it the preferred charging fluid to date. Very thin shell structures could use butane to greater advantage, while units of very small diameter could use carbon dioxide to greater advantage.

CONCLUSIONS

The Aurora thermopile test unit showed a heat loss capability about 500 times the soil heat inflow through the steel column for each degree Fahrenheit differential.

For the period from 15 April 1960 through 1 May 1963 the calculated amount of heat withdrawn during below-freezing weather is about 1000 times the heat inflow during above-freezing weather through the thermopile unit. The calculated yearly net average heat loss of 1.34 million Btu for the Aurora test pile unit gives 47,500 Btu/sq ft of exposed surface/year.

The unit heat loss conductivity of the test pile is about 9.78/28 ΔT sq ft or 0.35 Btu/(hour)(sq ft)(ΔT) where ΔT is equal to 38 - T(air). The heat gain conductivity of the test pile is 0.02 ΔT Btu/hour (ΔT) where ΔT is equal to T(air) - 32.

Thermopile units have shown reductions in soil temperature over adjoining uncooled areas from 1° to 5.3°F when measured during continuously thawing weather with the air temperature in excess of 45°F.

The measured operating pressure of the test thermopile has been below 63.9 psia and 50.6 psig. The only operational maintenance of installed thermopile units have been the correction of leaky fittings or valves and the recharging of those units.

White paints that show high reflectivity at short solar wavelengths and high emissivity in long low temperature wavelengths should be used for maximum unit efficiency. Periodic repainting of the pile surface would be required for maximum efficiency.

As the data presented are calculated rather than directly measured, they could be in error by ± 25%. The primary source of error would be the conductivity of the soil; this would vary the heat inflow and heat outflow proportionally.

Use and design of a thermopile foundation depends on net heat balance requirements of the soil around and under a proposed structure [7].

ACKNOWLEDGMENT

The author wishes to thank Alaska District personnel that contributed data from the Aurora and Glennallen Communications Facilities and Support Structures.

NOTATIONS

K	Thermal conductivity
N	Length of cylinder in ft
Q	Total quantity of heat transferred (Btu)
q	Thermal transmission
R	Thermal resistance
r	Radius
r ₀	Inner radius
r ₁	Outer radius
T	Temperature (F)
ΔT	Temperature (F) difference between two specified points, lines, or surfaces

REFERENCES

- [1] N. A. Tsytoich, M. I. Sumgin. "The Principles of the Mechanics of Frozen Ground," Acad. Sci. USSR, Moscow, 1937.
- [2] N. A. Tsytoich. "An Investigation of the Elastic and Plastic Deformation in Frozen Ground," Acad. Sci. USSR, Trans. Comm. Permafrost, Vol. 10, Moscow, 1937.
- [3] L. S. Khomichevskaja. "The Compressive Strength of Permafrost and Ice as Found in Nature," ibid., 1940, pp. 37-83.
- [4] M. S. Kersten, A. E. Cox. "The Effect of Temperature on the Bearing Value of Frozen Soils," Highway Res. Bd. Publ., Bull. No. 40.
- [5] Frost Effects Laboratory Fiscal Year 1951 Rept., "Investigation of Descriptive, Classification, and Strength Properties of Frozen Soils," SIPRE Rept. No. 8, June 1952.
- [6] M. S. Kersten. "Laboratory Research for Determination of the Thermal Properties of Soils," Corps of Engineers, U. S. Army, St. Paul, Minn., June 1949.
- [7] "Arctic and Subarctic Construction, Calculation Method for the Determination of Depths of Freeze & Thawing Soils," Engineering Manual for Military Construction No. 1110-345-375, 1954.

DESIGN OF KELSEY DIKES

D. H. MACDONALD, H. G. Acres and Co. Ltd., Consulting Engineers

The Kelsey Generating Station is a hydroelectric power development situated on the Nelson River about 425 miles north of Winnipeg, Manitoba. The station is owned by Manitoba Hydro, and was constructed to supply power to The International Nickel Co. of Canada, Ltd., at Thompson, Man. (Fig. 1). It was created at a site on the Nelson River where natural rapids allowed a head of some 50 ft to be developed by the construction of a small dam and some low dikes. The plant is a run-of-the-river station with an initial installed capacity of 210,000 hp and a possible ultimate capacity of 420,000 hp.

The general arrangement of the development is shown in Fig. 2. At the site, the northward flowing Nelson River orig-

inally turned to the east, dropped about 20 ft, then turned through 180 degrees to flow westward for almost a mile before continuing northward. As a result, a small rock-controlled isthmus was formed through which the intake channel was cut to the powerhouse located on its north side. The river channel was blocked with a dam of about 120 ft maximum height, adjacent to which a gated sluiceway was constructed in a large channel cut through the overburden and rock. Closure was provided for the reservoir by dikes constructed at the low spots in the topography.

The main dam, founded completely on rock, is of the rock-fill type, with an upstream sloping core built with the local

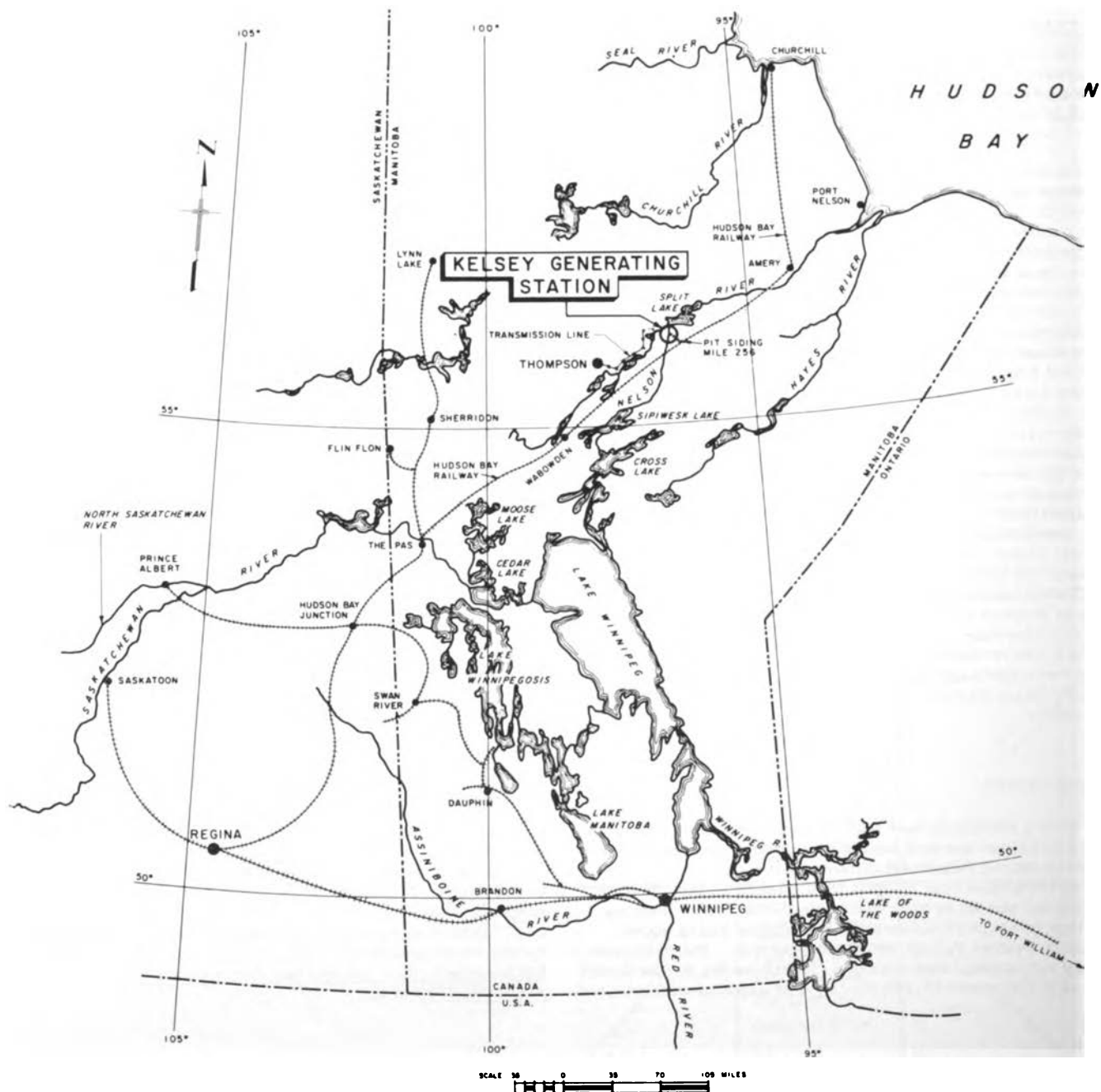

Fig. 1. Location of development

lacustrine clay. Although its design and construction presented some interesting problems, they were only remotely related to the permafrost conditions prevalent in the area. Descriptions of the dam and dikes and of the entire project are contained in previous papers [1, 2].

The Kelsey dikes may be conveniently divided into two types: Clay dikes and sand dikes. The clay dikes are those constructed predominantly of rolled clay fill, such as the center dike and dikes No. 1 east and No. 1 west; they also include the freeboard dikes, identified as No. 3 to 5 and 7 to 10 west in Fig. 2, which are relatively low homogeneous clay-fill structures. The sand dikes, No. 2 east and No. 2 west, consist completely of granular fill.

The Kelsey development was built between 1957 and 1960. The headpond was filled in late November 1960, and the station has operated continuously since.

TOPOGRAPHY, GEOLOGY AND PERMAFROST

The Kelsey site lies within the geological region known as the Canadian Shield, a vast area of low relief that has resulted from a number of glaciations and continued erosion. The rocks are mostly of igneous or metamorphic origin, and these have been covered by a variable assortment of glacial, glaciofluvial, and lacustrine deposits.

These conditions prevail at the Kelsey site where the normal river levels below and above the falls were previously 553 and 573 ft, while the maximum ground elevation in the vicinity was 635 ft. The country rock at the site is a grey paragneiss which has been intruded by granite gneisses, gabbro dikes and

sills, and by minor dikes of diabase, lamprophyre, and pegmatite. The regional strike of the gneissic rocks is in the east-west direction, and its dip is to the south at 50° to 70°. The principal jointing parallels the foliation, and other jointing of a minor nature is present. Rock outcrops are few and are confined to the banks of the river, particularly near the former rapids. Structural weaknesses in the rock are thought to be few in number, although a wide east-west fault is believed to exist in the river immediately to the north of the narrow peninsula.

The overburden consists completely of glacial or postglacial soils. The surface drainage system is poor and generally disorganized, with the result that swampy areas and muskeg are common. Occasionally, the latter reaches a maximum thickness of 15 ft. Covering the entire area, except for the highest ridges, are clays and silts of the glacial Lake Agassiz [3]. These are weathered to a brownish color in the upper 6 ft, and are generally covered by 1 to 3 ft of organic topsoil. These clays usually become less plastic and more silty with depth, and reach maximum thicknesses in excess of 25 ft. Beneath them is a glacially deposited ground moraine of sand, gravel, and granular till, which varies up to 20 ft in thickness. This sequence of organic topsoil, varved clays and silts, and granular moraine may range in thickness from only a few to more than 50 ft; the greater thicknesses occur in depressions in the rock surface.

The Kelsey site is located in the boreal or northern climatic region of Canada. The significant climatic data for the site are as follows [4, 5]:

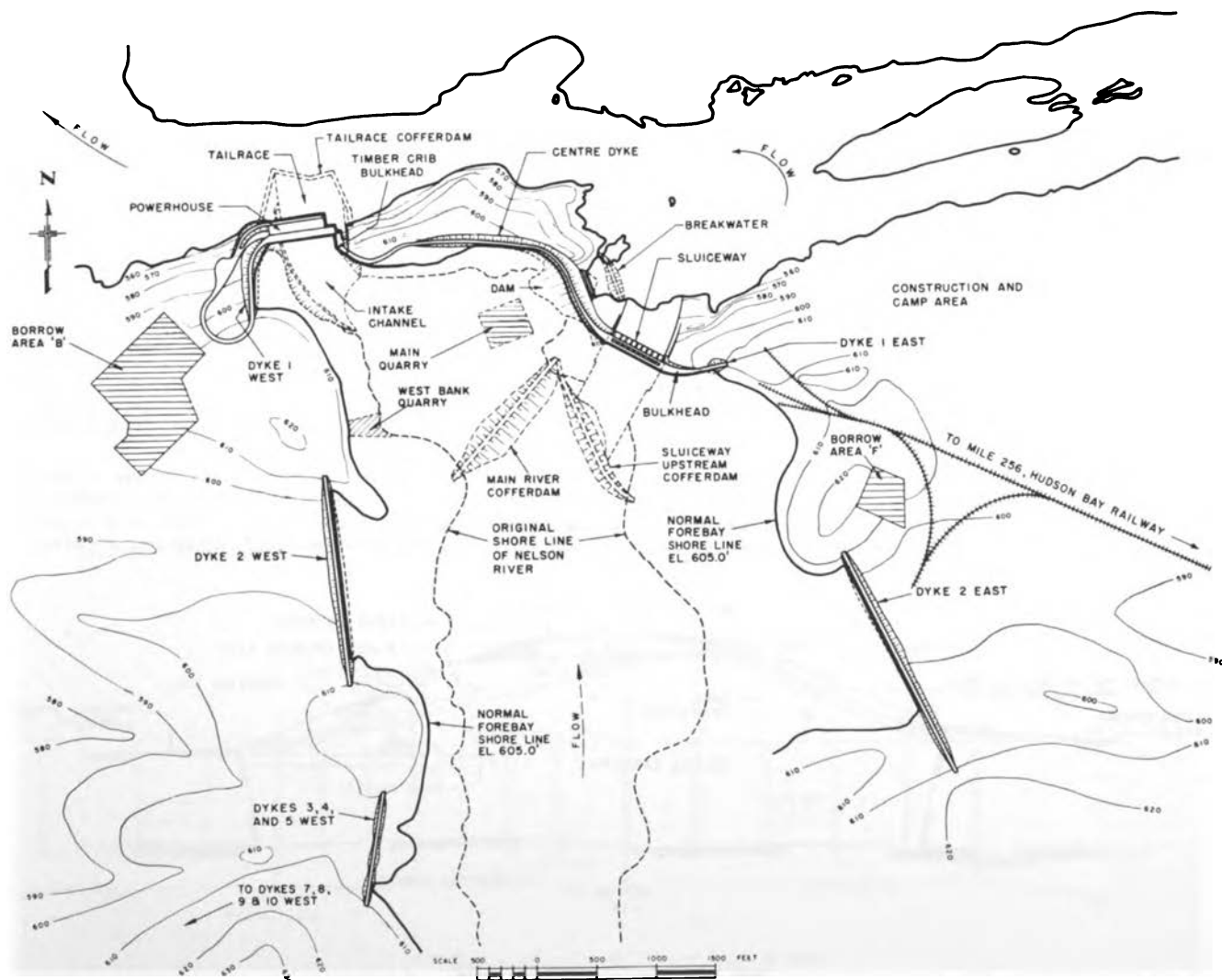

Fig. 2. General arrangement of development

Mean annual temperature	25°F
Mean January daily temperature	-15°F
Mean July daily temperature	59°F
Average frost-free days per year	140
Mean annual total precipitation	16 in.
Mean annual rainfall	12 in.
Mean annual snowfall	60 in.

The site is situated very close to the southerly boundary of the permafrost region. Permafrost was found, in some form during construction, in about 70% of the entire area. In distribution it was sporadic in both the vertical and horizontal directions; in only a small percentage of the area was the soil frozen completely down to rock. The depth of seasonal freezing and thawing was generally 2 to 3 ft in swampy areas and where organic cover existed, and 5 to 6 ft on more exposed higher ground. Varved clay and sandy moraine were found frozen to depths as great as 35 ft below the ground surface; in some areas permafrost was encountered in the rock. In some instances it was found within 25 ft of the Nelson River. In the clays, frozen pore water occurred in several forms from minute ice crystals to lenses of clear ice as thick as 7 in. Lenses of the latter thickness were uncommon and were found mainly in the sluiceway area (Fig. 3). Most frequently, ice occurred as thin threadlike stringers at contacts between the light and dark layers in the varved clay. Temperatures in the permafrost were found to vary between 29.5° and 32°F.

EXPLORATIONS AND NATURAL CONSTRUCTION MATERIALS

Preliminary hand augering and wash borings were first made at the site in 1955 and 1956, and geological mapping was done during the latter year. Photogeologic studies of the power site and the railway route from the main line to the site were made in 1956, while more detailed geological mapping, additional auger borings, and some diamond drilling were carried out intermittently between 1957 and 1959.

Most of the diamond drilling was done by conventional methods, except at the locations of dikes No. 2 east and No. 2 west, where permafrost was known to exist and a reasonably complete picture of the foundation conditions was considered very desirable. At these two structures an attempt was made to obtain continuous frozen core by drilling in winter with a machine having a hydraulic-feed head, utilizing a double-tube, swivel-head core barrel; and using fuel oil for drilling fluid. This method proved to be fairly successful in obtaining good core of the frozen clays.

Near the Kelsey development the only construction materials economically available in quantity were bedrock and varved clays. Suitable rockfill for the dam, dikes, cofferdams, roads, and concrete aggregate and transition materials were obtained from the various excavations and quarries at the site. Glacial till (suitable for use in the impervious zones of the dam, dikes, and cofferdams) could not be found near the site, and the varved clay had to be used. Although this clay was abundant,



Fig. 3. Sluiceway excavation through overburden containing permafrost, August 1957

its high natural water content, its relative thinness in places, and the presence of permafrost, made its use difficult at times. Deposits of suitable granular materials were not found at the site, with the result that sand had to be brought to the site by rail, a minimum distance of 13 miles.

CLAY DIKES

The center dike (Fig. 2) is the westerly continuation of the main dam required to provide closure of the reservoir along the high ground of the small peninsula. Early explorations in this area showed that bedrock was overlain by a thin layer of sand and gravel and varved clay. Extensive zones of permafrost were found in the overburden, and subsequent excavation revealed ice-lenses up to 0.5 in. thick in the clay. It was concluded that filling of the reservoir would change the existing thermal regime sufficiently to produce extensive thawing of the permafrost, and thereby create critical stability conditions. It was, therefore, decided to remove the overburden down to bedrock from beneath the dike and replace it with compacted unfrozen clay. The adopted cross section (Fig. 4) was designed so that a failure of the overburden supporting the dike on the upstream side would not endanger the entire dike. This section was continued until the ground surface reached the normal reservoir elevation of 605 ft, at which point the remaining dike was placed directly upon the stripped overburden.

Excavation for the dike was done in the summer of 1958 with a dragline, after use of a bulldozer proved unsuccessful. Fill placing was completed in the summer of 1959 using conventional equipment and the varved clay, which was slightly

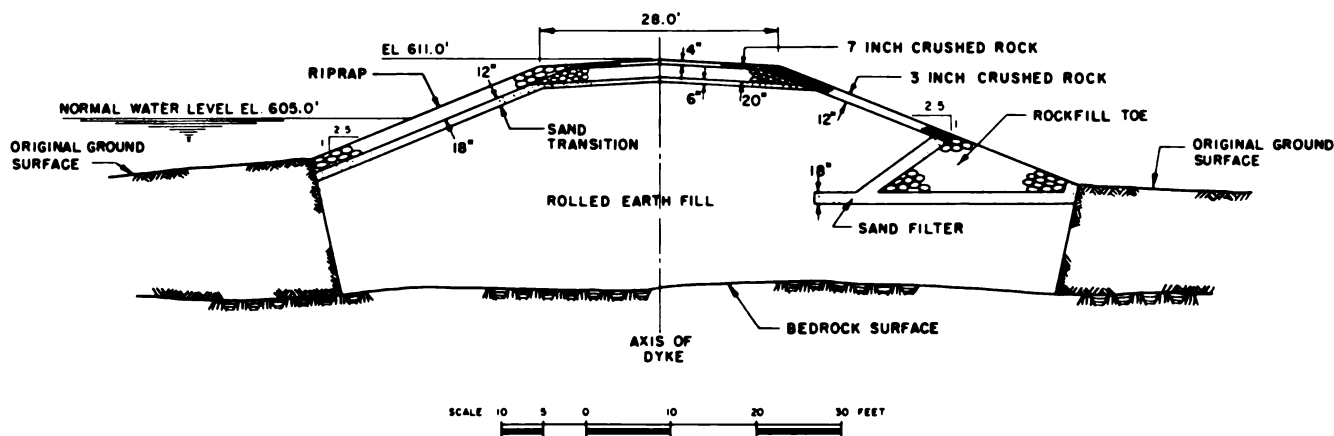

Fig. 4. Typical section through center dike

above optimum water content. Some difficulty with sloughing of the exposed permafrost slopes in the excavation was surmounted by piling temporary insulating fill against the slopes.

At the east end of the sluiceway structure the varved clay overburden contained extensive permafrost and reached a maximum thickness of 30 to 35 ft. It was feared that progressive thawing and sloughing of this overburden might be caused by the raising of the headpond; because such a situation could not be tolerated, it was decided to extend a concrete gravity bulkhead eastward from the sluiceway (a distance of 465 ft to the ground surface contour of 605 ft). From this point to elevation 611 ft, dike No. 1 east, a small homogeneous earthfill, was built directly on the overburden. This was built in October and November, and freezing temperatures required that the dike be completed within a heated enclosure.

Dike No. 1 west provides the closure from the west end of the powerhouse to the higher ground to the south. The overburden in this area consisted of varved clay overlying lenticular sands and gravels and till deposits of local extent. The permafrost there proved to be only sporadic, and the dike was founded directly on bedrock for a distance of only 100 ft from the powerhouse; beyond that the dike was founded on overburden. The dike was constructed according to the cross section shown in Fig. 5, the rolled earthfill being the local varved clay.

Dikes 3 to 5 and 7 to 10 west, fairly low structures with a maximum height of 6 ft, were necessary only to provide closure of the 610 contour around the reservoir. They were all located in low swampy areas where access in the summer with conventional equipment was difficult; consequently, the dikes were constructed in February and March. Dike areas were stripped immediately ahead of the fill placing. Fill was the varved clay, which was compacted into a homogeneous section in an unfrozen state by bulldozers. The stripped organic cover was spread over the dikes afterward for thermal and erosion protection.

Thus far, no difficulty has been experienced with any of the clay dikes. The maximum recorded settlement of No. 1 west

is about 0.3 ft. Settlement up to 1.9 ft has been recorded at center dike in a section near its junction with the main rock-fill dam where a substantial amount of clay fill was placed during freezing weather late in 1959.

SAND DIKES

Upstream from the powerhouse and dam, low-lying swampy areas existed on both sides of the river; closure of the headpond required dikes about 2000 ft in length and 20 ft in maximum height. These dikes are No. 2 east and 2 west, shown in Fig. 2. The soil profile at both locations consisted of 1 to 4 ft of muskeg overlying varved clay, sandy till, and bedrock. The average overburden thickness was 20 to 25 ft and the maximum was 45 ft. Permafrost, in all forms was general throughout both dike areas, although discontinuous pockets of unfrozen soil did occur. Permanently frozen soil extended from within 3 ft of the ground surface into the bedrock.

Concern was felt over the possible loss of shear strength in the soil that might result from the thawing of the soils beneath the dikes, thus precipitating a foundation failure. Various alternative solutions were considered and the adopted one was dikes directly on the permafrost. It was believed, however, that the situation could be materially improved if the excess water were removed from the soil as quickly as it was produced by thawing and the soil allowed to consolidate naturally. To make this possible, sand drains were installed on a grid pattern beneath the dikes from the downstream toes to a distance of about 50 ft beyond the upstream toes (Fig. 6). The sand drains were 14 in. and 16 in. in diameter, and spaced on 10, 15, and 20 ft centers. The holes were generally 25 ft deep, or to bedrock if shallower, except for those along the downstream toe which were drilled to a maximum depth of 40 ft or to bedrock.

Because muskeg made access during summer months both difficult and costly, it was decided to build these dikes in the winter months. As the placing of a rolled clay fill in the winter was considered unsatisfactory, a homogeneous section

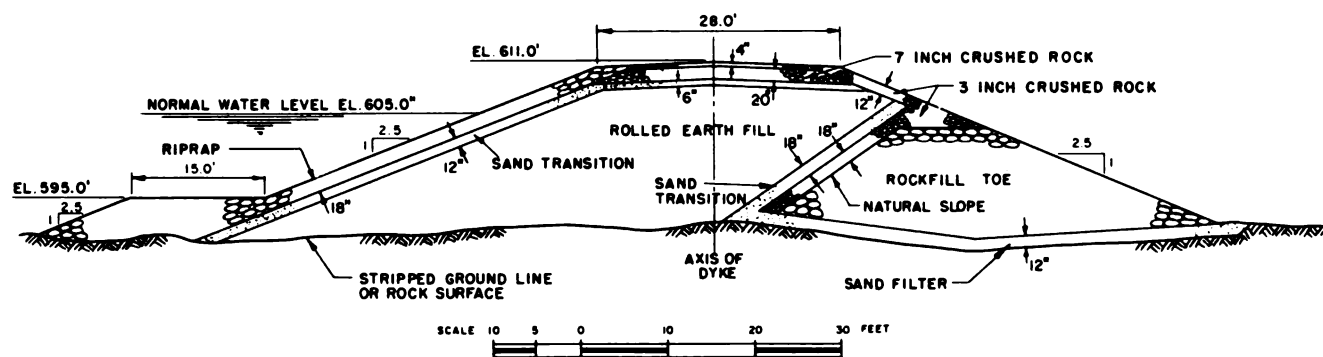

Fig. 5. Typical section through No. 1 west

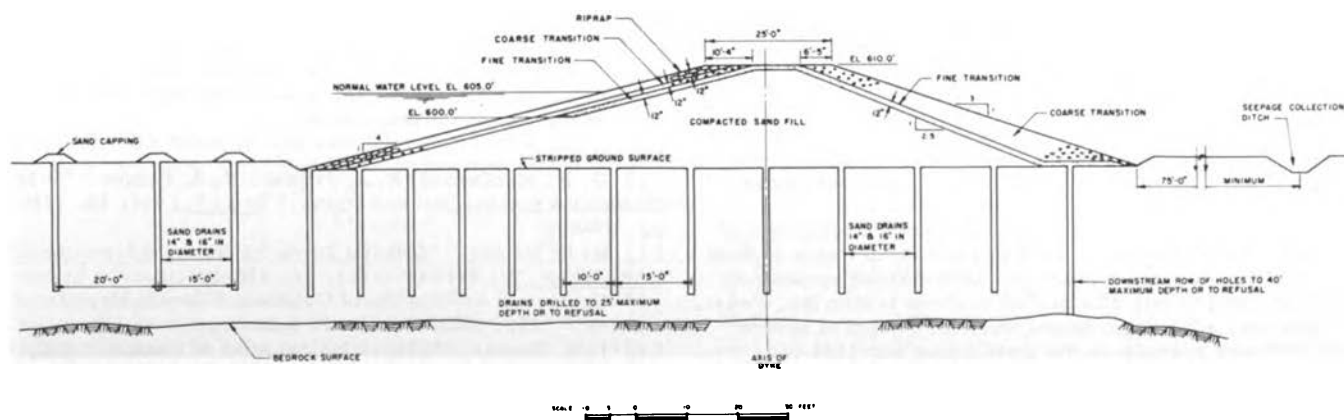

Fig. 6. Typical section through No. 2 east and No. 2 west

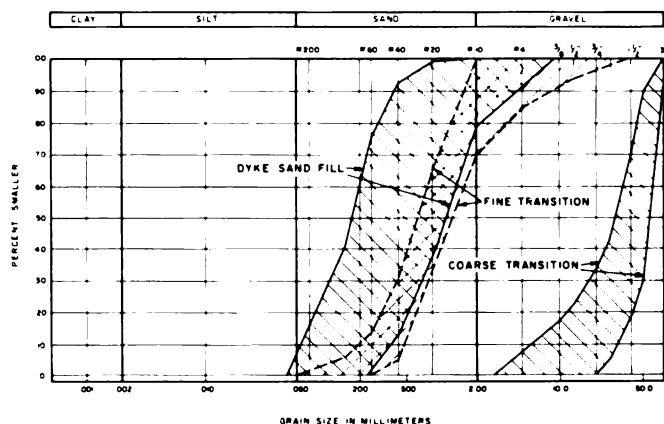

Fig. 7. Particle size distribution for sand fill and transition materials in No. 2 east and No. 2 west

of pit-run sand was adopted. Moreover, it was believed that sand fills would adjust to the inevitable settlement better than clay fill (Fig. 7). Calculations indicated that the maximum ultimate settlement would be about 5 ft. Seepage through the sand fill was estimated to be slightly less than 1 cu ft/sec for each dike, and a downstream drainage system was provided to carry this away safely.

Organic matter and topsoil were stripped during March and December of 1958 by bulldozers. This work was difficult because of the hard nature of the frozen soil and because bulldozers could not operate on swampy areas at each dike. Blasting and a dragline were resorted to finally to strip the swampy areas. Sand drains were easily installed by truck-mounted power augers at an average rate of 38.6 ft/hr for the entire 59,000 feet.

Sand fill was brought to the site by rail, delivered to the dikes by trucks and spread and compacted in 12-in. lifts by bulldozers. Transition and slope protection materials were placed by conventional methods.

Drainage ditches were excavated during the winter by a combination of blasting, dragline, and hand labor. All other work on these dikes was done in the winter, both dikes being completed in the spring of 1959 (Figs. 8 and 9).

Since the construction of earth works, such as these, directly upon permafrost had no known precedent, considerable interest was aroused in their performance. A program of measurements of thermal changes in the permafrost and of consequent settlement was jointly undertaken by the National Research Council of Canada and Manitoba Hydro. This program included the installation of eight thermocouple stations and 15 settlement gauges located beneath and adjacent to dike No. 2 east, and 3 settlement gauges beneath dike No. 2 west.

Although some instrumental difficulties have been experienced with this installation, the observations showed that by late 1962 (two years after reservoir filling), maximum recorded thawing was about 5 ft below the stripped foundation surface beneath the dike, and about 12 ft below ground surface elevation in the reservoir adjacent to dike No. 2 east. The maximum recorded settlement of the crest of dike No. 2 east by the summer of 1962 was approximately 4.2 ft, of which 1.2 ft were measured in the foundation. A number of slight local depressions were observed along the crest and on the downstream slope of this dike, but no difficulty with the structure has been experienced.

On dike No. 2 west, the maximum recorded settlement of the crest by the summer of 1962 was 4.7 ft, of which at least 0.8 ft occurred in the foundation. Dish-shaped settlements have occurred in this dike similar to those in dike No. 2 east. In addition, a localized depression with a depth of several feet occurred suddenly in the crest during July 1961 and extended down the upstream and downstream slopes. Temporary repairs were made in the summer of 1961, and a general raising of the crests of both dikes to elevation 611 ft was completed in the summer of 1962. No other difficulty with



Fig. 8. Construction of No. 2 west, January 1959



Fig. 9. Aerial view showing powerhouse and No. 1 and No. 2 west, Oct. 1960

dike No. 2 west has been experienced.

ACKNOWLEDGMENT

The design and supervision of construction of the project were done by H. G. Acres & Co., Ltd., for Manitoba Hydro. R. Peterson reviewed the designs of the dam and dikes in his capacity of special consultant on soil mechanics to Manitoba Hydro. The general contractor for the project was McNamara-Brown & Root.

Helpful discussions concerning the permafrost aspects of the earthworks were held with the Division of Building Research of the National Research Council of Canada, and with ACFEL, United States Army Corps of Engineers.

The author is grateful to Manitoba Hydro and to H. G. Acres & Co., Ltd., for permission to present this paper, and he wishes to thank his colleagues in these two organizations for their assistance in its preparation.

REFERENCES

- [1] D. H. MacDonald, R. A. Pillman, H. R. Hopper. "Kelsey Generating Station Dam and Dykes," *Engr. J.*, Vol. 43, 1960, pp. 87-98.
- [2] H. R. Hopper. "Kelsey: Power for Northern Manitoba," *Can. Geogr. J.*, Vol. 63, 1961, pp. 170-181.
- [3] Geological Association of Canada. "Glacial Map of Canada," 1958, Scale 1 in. = 60 miles.
- [4] J. K. Thomas. "Climatological Atlas of Canada," *NRC No. 3151*, Department of Transport and National Research Council of Canada, 1953.
- [5] "The Climate of Canada," *Canada Year Book 1948-1949*, Queen's Printer, Ottawa, pp. 41-62.

FROST-HEAVE OF ROADS IN HOKKAIDO, JAPAN

I. MIYAKAWA, M. KOYAMA, and T. TAKAHASHI, Civil Engineering Research Institute, Sapporo, Japan

Frost-heave of roads, essentially caused by cold weather, is one of the greatest problems in cold areas. Since World War II, remarkable progress in snow removal in Hokkaido has improved winter traffic. Snow removal, however, has exposed road surfaces to deep frost penetration. Furthermore, increased automobile traffic has added to road damage caused by heaving and thawing.

Since 1951, the Hokkaido Development Bureau (HDB) has conducted research and studies on frost-heave of roads in cooperation with Hokkaido University, the Hokkaido Prefectural Government, and other organizations concerned.

For new paved roads, the recommended and required method is to replace a frost-susceptible subgrade or to build a nonfrost-susceptible subbase course.

As a measure against frost-heave on gravel roads, as thick a snow layer as is tolerable is left on the road surface at the time of snow removal. Perforation through the residual frozen layer in the thawing season is effective in facilitating drainage. These methods are helpful but no definite counter measures have yet been found.

ROADS OF HOKKAIDO

Compared with the national average, Hokkaido roads still need much improvement. In recent years, however, much has been done to develop and pave roads and build permanent bridges [1].

Of the 58,320 km of roads in Hokkaido, 4,170 km is national highway, 7,733 km is prefectural, and 46,417 km is city or township (Table I).

About 26,000 km of the total length is satisfactory for automobile traffic.

Table II shows the distribution of road length in Hokkaido as compared with the national average. Table III gives the status of improved and paved roads. According to the table, improved national and prefectural roads account for only 20%, and city and township roads for less than 10% of the total length.

National and prefectural roads are paved for a length of 660 km—a rate of 5.5% or one half of the national average of 11%. This is a result of programs planned to improve the pri-

Table I. Length of roads in Hokkaido (March 1961)

Authorities	Kinds	No.	Length (km)
Hokkaido Development Bureau	Primary national highway	7	1 491.760
	Secondary national highway	18	2 678.052
	Designated local road	12	529.221
	Prefectural road	9	349.903
	City and township road	204	1 547.456
	Total		6 596.392
Hokkaido Prefectural government	Designated local road	37	1 105.939
	Prefectural road	348	5 748.518
	Total	385	6 854.457
City, Town, and Village offices	City road		9 789.481
	Others		35 079.765
	Total		44 869.246
	Grand Total		58 320.095

mary national highways up to the level of the national average. The rate of paving on roads other than the primary national highway, however, is extremely low.

Weather Problems

Severe weather is the greatest impediment to road construction and maintenance. Hokkaido has a continental climate with broad differences between summer and winter, day and night, and is an area subject to the most extreme climate changes in our country.

Figure 1 shows the average temperature conditions at representative cities of the island [2]. Regarding the maximum freezing index most closely related to the freezing of ground, the city of Hakodate shows the lowest, with -328°C days, and the city of Obihiro, the highest, with -874°C days, while mountainous parts often go beyond -1000°C days.

Table II. Distribution of roads^a

Kinds	Area, km ² (A)	Population (B)	Length of road, m (C)	Length of road per area, m/km ² (C/A)	Population per lineal km (B/C)	Total length of roads, m (E)	Length of roads per area, m/km ² (E/A)	Population per lineal km (B/E)
National	369 661	93 760 000	147 041 935	397	637	963 444 966	2 607	97
Hokkaido	78 509	5 060 000	11 903 393	151	425	58 320 095	741	84

^aNational statistics—as of March 31, 1960; Hokkaido statistics—as of March 31, 1961

Table III. The roads of Hokkaido (March 31, 1961)

Kinds	Length (A), km	Improved roads		Paved roads		Unpassable for motor vehicles	
		Length (B), km	B/A, %	Length (C), km	C/A, %	Length (D), km	D/A, %
Primary national highway	1 491.760	721.564	48.7	398.216	26.6	...	0
Secondary national highway	2 678.052	498.286	18.6	116.958	4.3	79.215	2.9
Designated prefectural road	1 635.160	470.047	28.7	76.072	4.7	17.274	1.1
Prefectural road	6 098.421	740.821	12.1	68.222	1.1	391.161	6.4
Total	11 903.393	2 430.718	20.4	659.468	5.5	487.650	4.1
City and township roads	46 416.702	3 811.860	8.2	229.987	0.5	6 656.123	14.3
Grand Total	58 320.095	6 242.578	10.7	889.455	1.5	7 143.773	11.9

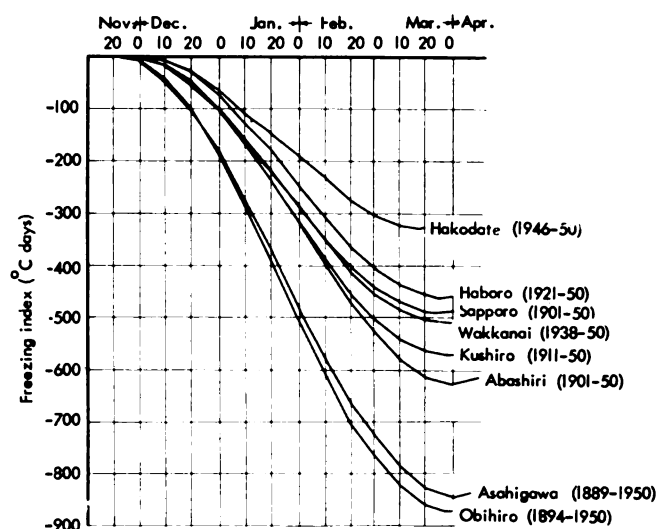

Fig. 1. Freezing index in Hokkaido (statistical value)

Winter Traffic

Before 1945, snow was removed only on a small scale. Full-scale snow removal was begun by order of the Occupation Forces. This increased winter traffic on the island. This service, which was made a public utility about 1948, extended the use of roads for winter traffic to 3000 km by 1950.

In April 1956, a law was enacted which designated important highways to be cleared of snow. Moreover, it provided for initiation of subbase construction to prevent frost damage. Table IV shows the extent of cleared roads by 1962.

Frost-Heave Damage

The roads of Hokkaido, until 1945, had almost no automobile traffic in winter. Travel started again at the spring thawing season, but the volume was small. The road surface heave, therefore, damaged the road little, if at all.

After World War II, however, active snow removal, heavier vehicles, and mounting traffic volume rapidly increased the damage to roads from frost-heaving and thawing.

Table V shows the lengths of those sections in the roads under the administration of the HDB that were blocked to traffic or had traffic difficulties in the spring of 1961.

According to Table V, the length of damaged roads totaled 643 km or 12.7% of the total length. But if the length of paved roads, improved roads, blocked sections, and snowbound

Table IV. Snow removal

Year	Length, km				Total	Expenses 1000 yen	
	Hokkaido Development Bureau	Hokkaido Prefectural Government	National railway (for bus)	Others		Hokkaido Development Bureau	Hokkaido Prefectural Government
1945	...	55	55
46	...	94	94
47	...	112	112
48	...	120	120
49	...	1 632	1 632
50	...	3 237	3 237
51	1 010	2 379	3 389	5 774	29 680
52	1 140	778	390	1 004	3 312	13 708	12 240
53	1 140	850	609	958	3 557	25 933	12 240
54	1 171	922	632	1 388	4 113	33 500	21 620
55	1 414	733	721	2 501	5 369	37 500	27 124
56	1 713	702	791	2 425	5 631	46 509	21 648
57	2 001	876	912	2 187	5 976	80 000	33 650
58	2 348	962	959	4 306	8 575	106 260	33 600
59	2 718	1 130	988	4 412	9 248	129 016	40 000
60	3 127	1 432	853	3 658	9 070	137 199	50 000
61	3 451	1 488	566	4 000	9 505	193 710	62 000
62	3 860	1 688	225 000	74 000

Table V. Length of roads damaged by frost-heave, 1961
 Hokkaido Development Bureau (Unit: m)

Regional Construction Divisions	Primary National Highways	Secondary National Highways	Designated Prefectural Roads	Prefectural Roads	Total	Total Length	
						Length	%
Sapporo	19 200	34 900	22 600	...	72 720	585 066	13.1
Otaru	18 700	20 200	9 500	6 300	54 700	451 608	12.0
Hakodate	5 500	9 800	1 000	600	16 900	667 775	2.5
Muroran	2 500	38 890	41 390	464 452	8.9
Asahigawa	43 510	13 120	56 630	565 468	10.0
Rumoi	25 000	40 950	65 950	292 605	22.5
Wakkanai	22 500	64 500	5 000	...	92 000	288 279	31.9
Abashiri	24 280	35 770	1 700	41 000	102 750	655 289	15.6
Obihiro	37 000	63 000	100 000	382 899	26.1
Kushiro	1 000	24 000	11 000	200	36 200	695 495	5.2
Total	199 180	345 130	50 800	48 100	643 240	5 048 936	12.7
Total length	1 491 760	2 678 052	529 221	349 903			
Percentage	13.3	12.8	9.5	13.7			

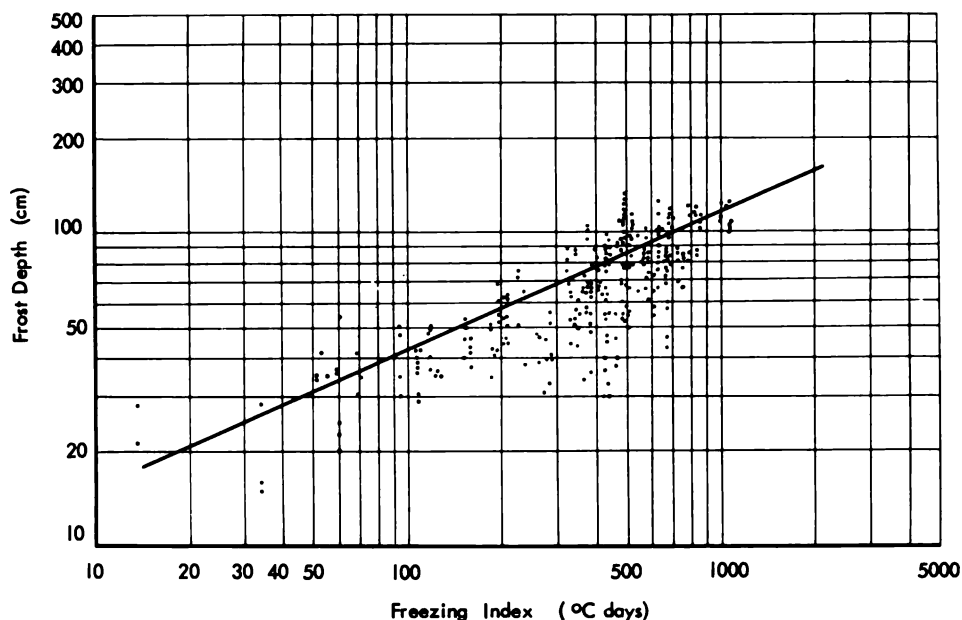

Fig. 2. Freezing index and frost penetration in existing gravel roads

roads is excluded, about 20% has caused traffic paralysis in the spring through traffic blocks and other problems. The thawing season extends from the middle of March to middle or late April, and the mud season extends from early to late April. The opening time and period of the mud season varies according to location.

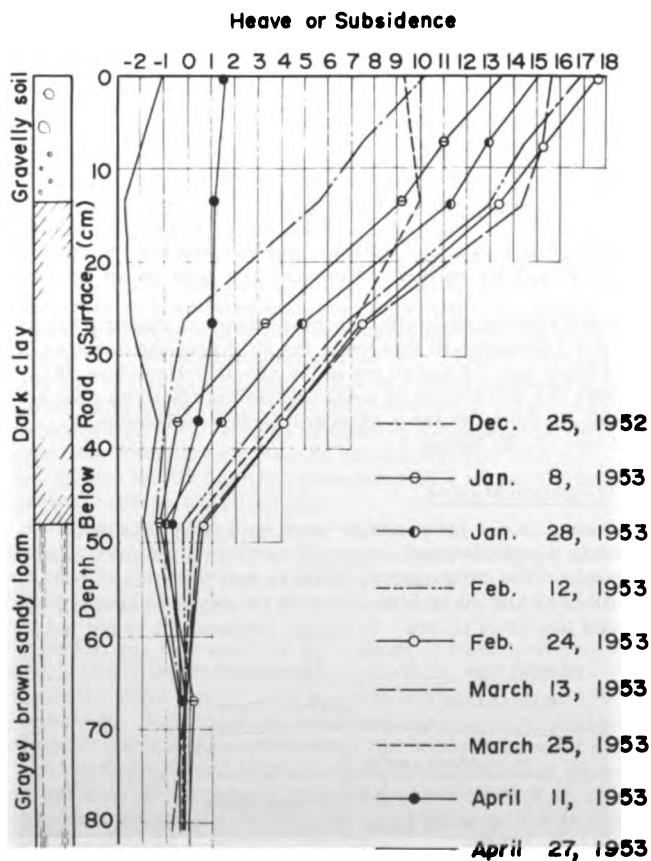

Fig. 3A. Frost-heave profile (tautochrone) at Nina, Hokkaido, 1952-1953

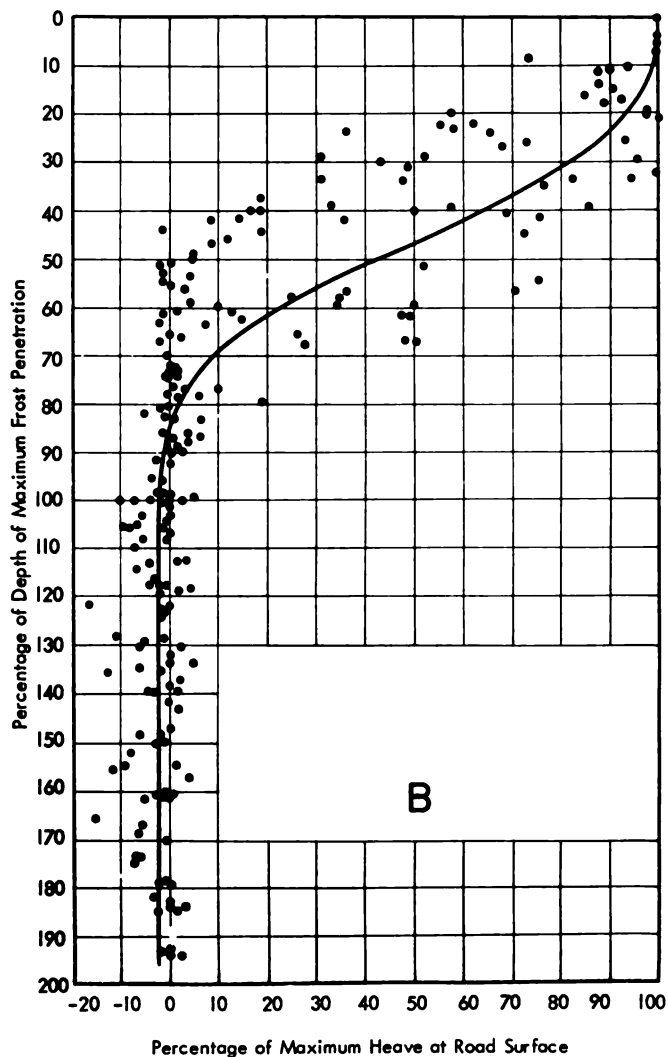

Fig. 3B. Profile of frost-heave at its maximum (existing gravel roads) in Hokkaido, 1952-1954

Frost Data

Figures 2 and 3 show frost data for the island [2, 3]. The temperature drops below 0°C in the middle of November, and the surface layer of the roads is frozen by the middle of December. The frost line drops gradually from around mid-December, when air temperature is -5° to -6°C, and reaches the lowest around mid-March. Frost-heave is usually maximum late in February.

ANTIFROST-HEAVE METHODS

Much has yet to be discovered about the frost-heave mechanism. However, several methods for preventing frost-heave are: Replacement, heat insulation, water interception, and chemical additives. At Hokkaido, the replacement method is the most popular; frost-susceptible subgrade soil is replaced to the freezing depth by nonfrost-susceptible materials. The chemical method is adopted only as a subsidiary step to the replacement method. Heat insulation and water interception methods are not used.

Replacement Method

Depth—Generally, it is uneconomical to replace the whole frost depth. As replacement materials, sand and unscreened gravel are used, but replacement by such coarse-grained materials further lowers the frost line as compared with the existing frost depth of subgrade before replacement, and so more expense is involved if replacement is to be made down to the expected frost depth. In practice, therefore, it becomes important to set the minimum depth of replacement to prevent frost-heave damage—that is, to reduce the frost-heave to an amount that will not damage the surface layer but will secure a necessary subbase bearing capacity at the thawing season.

The requirements of the subbase as to bearing capacity and its uniformity vary according to whether the surface layer is rigid or flexible. Therefore, the replacement depth and the selection of materials are closely related to the kind of pavement. One reason for adoption of flexible pavement in Hokkaido is that this kind of pavement has been found by experience to be best fitted for the partial replacement technique. The HDB recommends a replacement ratio (depth of paved road structure, including antifrost layer, to the original frost depth) of about 80% as reasonable [4].

Only a small percentage of the surface heave of existing gravel roads is attributable to the soil below 80% of the original frost-penetration depth (Fig. 3) and the adopted depth of select fill may provide sufficient bearing capacity, even if the accumulation of extra water and resultant weakening might impair the underlying layer. In districts having a shallow frost depth, therefore, the depth of selected fill may be concerned only with bearing value and is based simply on the necessary capacity as a base course.

Standard depths of paved structure in various districts have been adopted as follows: In Hakodate, 60 cm; Asahigawa, Obihiro, 90-100 cm; and the others, 80 cm. The depths are regarded as reasonable because there have been no serious failures, at least with asphaltic pavement.

Quality of replacement materials—Materials used for the antifrost layer and subbase course should be of such quality that they are not susceptible to frost-heave and should maintain the necessary bearing capacity.

For subbase course including the antifrost layer, the HDB uses sand, unscreened gravel, crusher run, and coarse grained volcanic ash [5].

Unscreened gravel is most commonly used either as a subbase course or as an antifrost layer. Unscreened gravel for the subbase course should be finer than 60 mm in grain size, and must not be greater than 90 mm for an antifrost layer. [Nominal maximum sieve size is 60 mm. Miyakawa writes that 100% of this material passed the 76.2 mm sieve, 85-100% passed 63.5 mm, and 30-60% was finer than 4.76 mm. F. J. Sanger.] It should also have a gradation so that it can be compacted by ordinary compaction equipment and

contain a 30 to 60% sand fraction passing the 4760 μ sieve, irrespective of the maximum grain size. It should also be of good quality and contain no extremely flat or elongated pieces of stone or other deleterious substances. For coarse aggregate retained on the 2380 μ sieve, wear by the Los Angeles test should be less than 45% and weighted loss, after five alternations of the sodium sulfate soundness test, not more than 15%.

Frost susceptibility of unscreened gravel is checked by the amount of the fraction passing the 74 μ sieve in the sand fraction passing the 4760 μ sieve; a weighted amount of less than 9% is tolerable. Crusher run is generally used for the subbase course, and the above specifications are applied correspondingly.

Sand for antifrost layers should be clean, hard, durable, and free from harmful vegetable matter. Frost susceptibility of the sand is decided by the amount of the fraction passing the 74 μ sieve; less than 6% is allowed to be considered nonfrost susceptible.

Volcanic ashes in local areas are so inexpensive and readily available that they are often used. Materials should be hard and coarse, show no signs of efflorescence, have good drainage, have less than 20% passing the 74 μ sieve, and show an ignition loss of less than 4%. Standards for fine fraction and ignition loss were temporarily set as a simple method of judging susceptibility of volcanic ashes. Other materials can be used if they are nonsusceptible by frost-heaving tests.

Subbases—A subbase course consists usually of two layers: A subbase course and an antifrost layer. Since subbase materials are needed in large quantities, it is important to obtain inexpensive materials; to survey the distribution, and determine qualities of various materials—their utilization, transportation, prices, etc. When quality materials are available at low prices, the subbase can be made of the same material for its whole thickness. When more than two kinds of material are needed, they can be selected according to qualities given in the classification (Fig. 4).

In Fig. 4 the subbase consists of layers A, B, and C. For A, which is within the region of severe stress from a wheel load, the most stable and hard materials are needed: Unscreened gravel of good quality is generally used, 15 to 30 cm thick. For B, least expensive materials of various kinds are used: Sand, poorly-graded unscreened gravel, volcanic ashes, etc. For C, in the part adjoining the subgrade, sand or sandy gravel is used, 20 to 30 cm thick, to keep subgrade soil from getting soft and working into the subbase; but this filter layer can be omitted in the case of a bank on an existing road.

For the bearing capacity of subbase courses constructed for asphaltic pavements in this way, the HDB sets the value of K_{30} as more than 28 kg/cu cm in its specification [5]. (K_{30} indicates the coefficient of subgrade reaction derived from a plate 30 cm diameter and a standard central deflection of 0.125 cm. F. J. Sanger.)

Heat Insulation Method

This method is not yet practical because appropriate heat insulating materials have not been found. In northern European countries, there are examples of roads that were built with both subbase and surface constructed on subgrade covered by peat and leaves of plants. In Japan, however, it is not yet

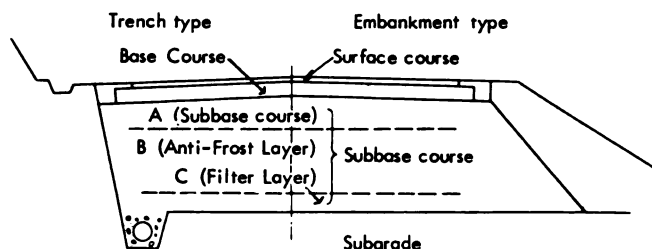

Fig. 4. Trench and embankment types of subbases

practical to use this kind of material for the subbase of especially important roads. A proposal has been made to use porous concrete, but its heat insulation value does not compensate for its higher cost.

At Obihiro, experiments were made on heat insulation by using foamed polystyrene and similar materials. A basic test has also been made on underground heat insulation effects and durability of materials of this kind.

Water-Interception Method

There are two water-interception methods: One cuts off ground-water supply with granular materials having no capillary action; the other cuts off the migration of water with impermeable membranes of metal, vinyl, asphalt, etc. Also, frost-susceptible soil above the water-cutoff layer must be protected from rain water in the same way; water contained in the soil itself must be limited so that it does not contribute to frost-heave. Experiments with this method show that it is difficult to protect the soil from rainfall during construction. It is very doubtful that water can be kept out for any length of time.

Chemical Method

If 2 to 4% sodium or calcium chloride are added to ordinary sandy loam and 1 to 2% chlorides to sandy or gravelly soil with less silt and clay, there will be almost no danger of frost-heave. It is considered effective for five to six years if the processed soil is protected from rain and ground water. This, however, has not been confirmed in Hokkaido. Shortcomings of this method are that it is difficult to mix the chemical with soil uniformly to frost depth and the chemical is expensive. Cost becomes as expensive as replacement, and the effective period is shorter. In Hokkaido a subgrade soil under a comparatively thin subbase is treated; also a liquid chemical is injected into the subgrade soil to eliminate frost-heave left after replacement.

RESEARCH OUTLINE

A survey on frost-heave from 1951 to 1953 [6] was conducted during prefreezing, freezing, and thawing periods on winter snow cleared and former frost-heave areas. The purpose was to make clear the relationship between data on frost damage and such factors as freezing conditions, properties of existing soils, ground-water level, and weather—and thereby to get a guidepost for measures against frost-heave.

A survey, during 1954 and 1955, was made to get the maximum frost depth, freezing conditions, and properties of subgrade soils on the routes that were expected to be paved.

Amount of frost-heave on the Tsukisappu concrete road along primary national highway route No. 36 was surveyed [7]. In 1952 at Tsukisappu, a 500-m concrete pavement was especially designed to prevent frost-heave. A survey was conducted from 1952 to 1954 to observe the amount of frost-heave, the freezing and thawing processes, and also to observe how much concrete pavement with a relatively thin antifrost subbase would crack.

Geologically, this road was built on silty subgrade in the path of surface and underground water from higher elevations. As a result, the road was severely damaged; in 1953 calcium chloride solution (3 kg/sq m) was added to the subbase as a test.

A study was also made of the amount of frost-heave on a section 500 m long at Teine Town, route No. 5, Sapporo-Otaru [8]. This primary national highway was built in 1953 of concrete. Data about the qualities of unscreened gravel and about the thickness needed for the subbase were obtained.

On primary national highway route No. 36 between Sapporo and Chitose, two locations of cutting and banking were chosen to measure subsurface temperatures in 1953 and 1954 to check frost-line drop [8].

Frost-heave at the Bibai section on primary national highway route No. 12 was studied for three successive years, beginning in 1955, to observe the relationship between

replacement depth and antifrost-heave effects [9, 10]. Properties of soils and amount of frost-heave, soil temperatures, and ground water levels were noted. Tests of bearing capacity were also made to check seasonal variations in the pavement capacity.

Tests on Replacement Material

A standard had to be obtained for evaluating frost susceptibility of unscreened gravel to be used as replacement material. Frost-heave tests were made outdoors during the winter of 1954 on specimens having various silt and clay contents [11]. All test specimens, however, showed concrete-like patterns and no significant difference in frost-heave.

Frost-heave tests were conducted in 1955 and 1956 on sand (maximum grain size of 5 mm), one of the typical replacement materials [12]. The artificially prepared specimens had various contents of silt (0.005 to 0.075-mm grain size); the quality of materials and environmental conditions of the test were modified to make a general inquiry into frost patterns and factors closely related to frost-heave.

Frost Control with Chemical Additives

This was a basic experiment on frost-heave prevention by chemicals that are used either as an alternative or a subsidiary procedure of the replacement method. Frost-heave and physical tests were conducted on highly frost-susceptible soils mixed with 1, 2, and 5% of the chemicals [13]. Chemicals tested were calcium chloride, salt, cement, slaked lime, two vinyl-type, high-molecular soil conditioners, two petroleum high-molecular soil conditioners, and one chemical soil stabilizer composed chiefly of magnesium chloride.

Calcium chloride, salt, and the chemical soil stabilizer were effective in comparatively small amounts and less expensive than the other materials. The problem is their solubility and duration of effectiveness. The two vinyl-type, high-molecular soil conditioners are hard to leach out. They are lasting but expensive.

Bibi Frost-Heave Test Road

Since 1960, frost experiments and surveys have been successively conducted on a test road at Bibi, city of Tomakomai, along primary national highway route No. 36, to check, under various weather and traffic conditions, how antifrost-heave effects change according to kind, quality and thickness of replacement materials; to learn what becomes of subbase bearing capacity; and to obtain data for rationally designing a road structure in a cold area [14].

Of the 1250 m road, 480 m was a test section for frost-heave. Eight kinds of material including unscreened gravel, sand, and volcanic ash were used for the antifrost-heave layer. The thicknesses of the road structure are 75, 60, and 45 cm; the test section is divided into 24 blocks; 75 cm is the standard thickness in this district.

Subsurface temperatures are either automatically recorded or regularly measured, and the amount of frost-heave at various depths can be checked without damaging the road surface. Also, the bearing capacity can be measured by the plate-bearing test on the upper surface of the subbase.

SUBJECTS FOR RESEARCH

Wide use of the replacement method in Hokkaido is based partly on experience and partly on the fact that no more appropriate methods have yet been found. The HDB specifications and basic idea were substantially the same as those used abroad. However, shallower replacement depth and full use of local materials influence cost and relative difficulty of the work. These problems made replacement depth and materials quality still subject to research.

An alternative method is needed where it is very difficult to obtain standard quality replacement materials and where frost is too deep to replace economically with nonfrost-susceptible materials.

Replacement Depth and Materials

Frost-heave after replacement is influenced by local weather, subgrade soil properties, ground-water level, and available local materials [15]. Damage to a pavement varies with traffic conditions on the route concerned.

In order to judge frost susceptibility of sand and unscreened gravel, it is important to classify the frost susceptibility of their fine fractions. Laboratory frost-heave tests on sandy soil showed that the more silt and clay the sand contains, the greater its frost susceptibility, and that the physical and chemical properties of these fine fractions have the greatest influence.

According to HDB specifications, frost susceptibility of sand, unscreened gravel, and other materials is judged by the weight percentage of silt and clay contained in the sand fraction. By this standard, silt and clay are considered susceptible to frost-heave, irrespective of their physical and chemical character. Also, their allowable content was decided in view of the fact that differential frost-heaves come from unexpected segregation of fine and coarse grains during construction and that natural traffic during the work increases the fine fractions.

Our experience on construction confirms the reliability of sand and unscreened gravel that conform to the standard. Specifications should be modified where materials are not easily available and where compaction work is difficult.

For unscreened gravel, it is desirable to set a limit on nonfrost susceptibility in consideration of the whole grading, particularly the ratio of sand and gravel fractions, even disregarding the question of silt and clay content.

Volcanic ash is locally available and cheaper than other replacement materials; therefore, it is often used as a nonfrost-susceptible material. Generally, volcanic ash has slight susceptibility to frost-heave. According to HDB specifications, frost susceptibility is judged by silt content and ignition loss. A method that could be used at the site is needed.

The standard of replacement depth in HDB specifications is reliable in most cases for the prevention of frost-heave [3, 16]. Depth of replacement, however, should be fixed by considering both the frost effects following replacement and bearing capacity of the replaced subbase during thawing. Antifrost effects are influenced by the kind of replacement material and its depth; ensured bearing capacity during thawing needs further study.

Chemical Method

Chemical additives are not the chief method used to prevent frost-heave in Hokkaido. Use of chemicals, however, looks promising. More study of the chemical method is needed in the following areas: (a) Effects and duration of measures

against frost-heave; (b) improved methods of applying chemicals for treatment of a subgrade soil; and (c) rational methods of applying chemicals for improving replacement materials.

REFERENCES

- (All references except 2, 14, and 16 are in Japanese)
- [1] The Road in Hokkaido, Hokkaido Development Bureau (HDB), 1962, pp. 8, 10-12, 44, 45.
 - [2] I. Miyakawa, M. Koyama. "On the Residual Frost Subgrade Underneath the Select Fill in the Alleviation Practice for Frost Damage," Soil and Foundation, Vol. 3, No. 1, 1962, pp. 10-18; Highway Research Abstr., Vol. 33, No. 4, 1963.
 - [3] M. Ifukube. "Studies on Frost Heave, Frost Penetration and Depth of Select Fill of Roads in Hokkaido," Research Rept. Civil Engr. Research Inst., HDB., No. 26, 1962, pp. 69-101.
 - [4] Design Standards in Road Construction, Div. of Constr., HDB., 1963, p. 7.
 - [5] Special Spec. on Road Construction, *ibid.*, 1963, pp. 24-26.
 - [6] I. Miyakawa, M. Koyama. "Study on the Prevention of Frost Damage to Roads," Bull. Civil Engr. Research Inst., HDB., No. 8, 1953, pp. 55-66.
 - [7] K. Usui. "An Example of Frost Damage to Concrete Pavement," Rept. 1st Tech. Research Meeting, HDB., 1957, pp. 222-230.
 - [8] K. Furuyama, K. Usui, S. Baba. "Studies on the Prevention of Frost Damage to Roads," Bull. Civil Engr. Research Inst., HDB., No. 11, 1954, pp. 62-73.
 - [9] I. Miyakawa, M. Koyama. "A Survey Concerning Anti-Frost Subbases (1955)," Research Rept., *ibid.*, No. 16, 1957, pp. 1-40.
 - [10] M. Koyama, K. Katsuyama. "A Survey Concerning Anti-Frost Subbases (1956)," *ibid.*, No. 19, 1958, pp. 1-29.
 - [11] K. Furuyama, S. Baba. "On the Quality of Unscreened Gravel Used as Replacement Materials Against Frost Heave in Roads," *ibid.*, No. 14, 1955, pp. 17-34.
 - [12] T. Ogoshi, S. Arai. "An Experimental Study Concerning the Properties of Replacement Materials Against Frost Heave," *ibid.*, No. 16, 1957, pp. 41-73.
 - [13] M. Koyama, T. Takahashi, M. Kawai. "A Frost Test on Soil Mixed with Chemicals," 6th Tech. Research Meeting, HDB., 1963, pp. 257-262.
 - [14] I. Miyakawa, M. Koyama, H. Kono, et al. "Bibi Road Test on Frost Prevention Work," Proc., 2nd Asian Regional Conf., Intern. Conf. on S.M.F.E., 1963 (Tokyo), pp. 373-380.
 - [15] K. Manai. "On the Process of Frost-Heaving of Soil and Some of its Effecting Factors," Bull., Faculty Engr., Hokkaido Univ., No. 6, 1952, pp. 54-67.
 - [16] M. Ifukube. Frost Penetration in the Replacement Method against Frost Damage to Roads, Civil Engr. Research Inst., HDB., 1962.

MINE RAILROADS IN LABRADOR-UNGAVA

R. W. J. PRYER, Quebec North Shore and Labrador Railway Co., Canada

Since World War II the military significance of the Arctic and sub-Arctic has tended to overshadow the economic aspects of northern development. Nevertheless, in the Canadian North the postwar period has been one of steady economic growth based on improved transportation facilities, an expanding mining industry, and an increasing demand for low-cost hydroelectric power.

Until recent years, most mineral discoveries of sufficient importance to justify northern mining operations were made in areas served by existing transportation routes—especially the great arterial waterways of the Mackenzie and Yukon Rivers, and the strategic highways constructed in the north during the war. Areas served by the transcontinental railroads provided some of the most important mineral discoveries, but are now considered to be northern only in the sense that they lie within the northern fringe of continuous settlement. Thus, although the mining industry has always made effective use of available transportation facilities, only rarely has it contributed to the improvement of northern communications.

The pattern has changed during the past 15 years as the mineral industries have become more directly involved with problems of northern access and transportation. Postwar demands for iron ore and petroleum did much to bring about the

change by stimulating mining and exploration activity in areas remote from established routes. Some of the new transportation facilities required to sustain this activity have been developed by the mining industries, notably in the Labrador-Ungava Peninsula where iron ore has been mined since 1954.

The Quebec North Shore and Labrador Railway (Q.N.S. & L.) the first major railroad in this area, has done more than serve a particular mining operation in an isolated location; it has also contributed significantly to regional development by providing access to areas with important mineral and water power resources. As knowledge of the extent and potential value of these resources has increased, so has the demand for more roads, railroads, and airfields. Although all subsequent development has taken place in areas to the south of the northern terminus of Q.N.S. & L. Railway, there are indications that more northerly resources may eventually be exploited. If such developments do materialize, permafrost and seasonally frozen ground will become important economic considerations in the fields of both mining and transportation.

This paper records the extent to which subarctic conditions have already influenced the approach to railroad construction in Labrador-Ungava, and deals briefly with some of the maintenance problems to which frost action has given rise

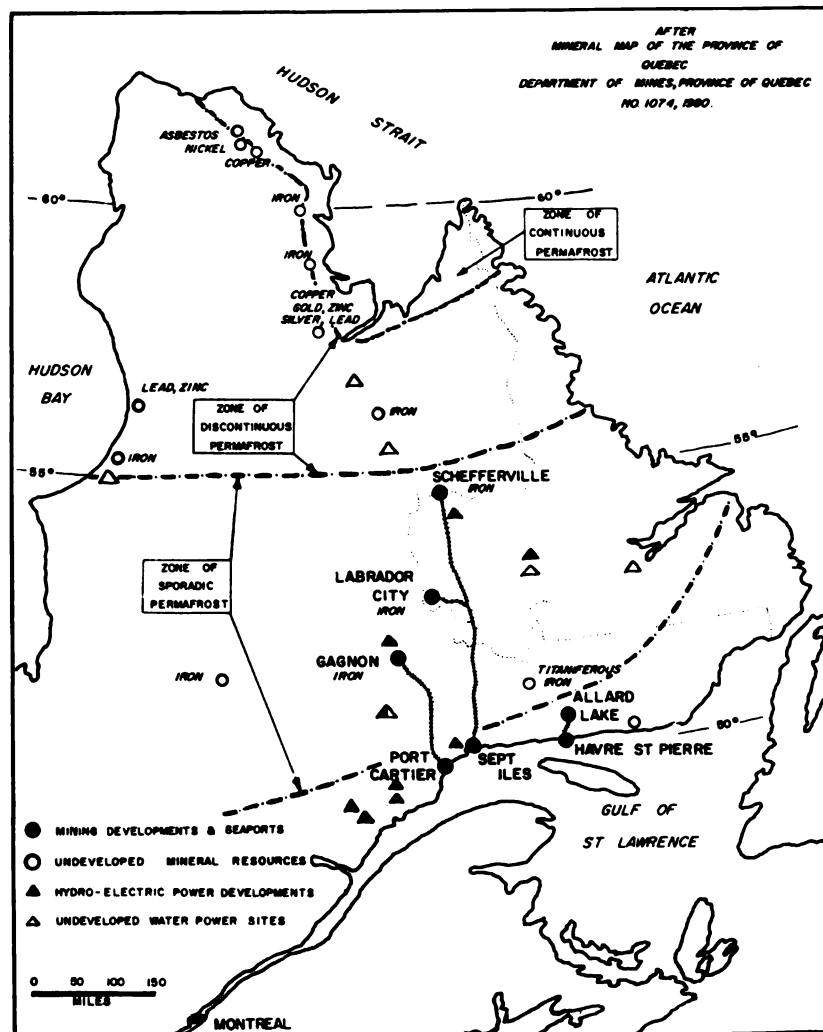

Fig. 1. Labrador-Ungava, resources and transportation facilities

during the past nine years.

HISTORICAL BACKGROUND

Occupying more than one-eighth of the total land area of Canada, the peninsula of Labrador-Ungava extends from the eastern shore of Hudson Bay to the Atlantic Ocean, and from the Gulf of St. Lawrence to Hudson Strait. Politically, it embraces the greater part of the Province of Quebec and the entire mainland (Labrador) section of the Province of Newfoundland. Fig. 1 is a regional map which shows the distribution of resources in the peninsula and their relation to transportation facilities.

In the reports of geological traverses undertaken during the last decade of the 19th century, recognition was given to two features of major importance: The presence of iron-bearing formations in the interior of the peninsula, and the significance of the region as one of the centers of Pleistocene glaciation. Problems of access and communication caused these features to attract little scientific or commercial attention until the advent of the airplane as a practical means of transportation. This stimulated geological exploration to some extent, but it was not until the end of World War II that serious attention was given to the feasibility of exploiting the region's mineral and waterpower resources. At that time, Labrador-Ungava was still virtually unknown. Economic development was restricted to the north shore of the Gulf of St. Lawrence, where pulpwood logging, together with commercial fishing and subsistence farming, supported a number of isolated settlements; field observations recorded some 50 years earlier continued to serve as the most reliable guide to the interior.

By 1949, several years of intensive exploration by mining interests had established the importance of an area close to lat. 55°N as a potential source of direct-shipping iron ore. Construction of a 360 mile railroad system with associated terminal facilities, docks, townsites, and hydroelectric power installations began during the following year. Major steel companies provided the necessary capital for development and the assurance of long-term markets.

Interest in Labrador-Ungava became more diversified with

the start of large-scale construction operations and the consequent improvement in access conditions. Glacial features, physiography, vegetation [1], climate, and other scientific aspects of the region have all received attention and continue to provide subjects for study. An event that served to intensify interest in the exploration and mapping of the Labrador portion of the peninsula occurred in 1949 when Newfoundland became part of the Dominion of Canada.

CLIMATE AND PERMAFROST

If the 50°F isotherm for mean July daily temperature is accepted as the southern boundary of the Canadian Arctic, the only part of Labrador-Ungava lying within this climatic region is the coastal section north of lat. 57°N. South of Hudson Strait and west of Ungava Bay, the Arctic zone extends inland for as much as 100 miles to include an area with important undeveloped mineral resources; elsewhere it is relatively insignificant.

The subarctic region, in which the number of summer months with mean daily temperatures of more than 50°F increases from one to four, extends southward to include the remainder of the peninsula north of lat. 50°N. Lower latitudes and maritime influences, however, cause the climate of Labrador-Ungava to differ in several respects from that of subarctic regions to the west of Hudson Bay. In general, it is a climate more noteworthy for cool summers than for cold winters, and one distinguished by heavier precipitation and fewer hours of summer sunshine.

In contrast to the 40 or 50 in. of snow to which much of the Canadian Northwest is exposed, mean annual snowfall over the greater part of Labrador-Ungava is about 120 in., but ranges from 200 in. in the southeast to 60 in. in the northwest. Mean annual rainfall varies from 5 to 15 in. in the northern half of the peninsula as in other subarctic regions; it increases in the south, however, and amounts to 25 in. along the north shore of the Gulf of St. Lawrence. Shorter daylight hours and the cloudiness associated with heavier precipitation both contribute to a reduction in the total hours of summer sunshine.

An indication of climatological conditions is provided by Fig. 2. Sept Iles is the southern terminus of the Q.N.S. &

	MEAN DAILY TEMPERATURE		PRECIPITATION			
	Schefferville	Sept Iles	RAIN		SNOW	
			Schefferville	Sept Iles	Schefferville	Sept Iles
	°F	°F	inches	inches	inches	inches
JAN	-3.6	6.4	0.26	0.30	18.5	35.1
FEB	-2.6	9.0	0.04	0.19	14.6	34.5
MAR	5.7	20.1	0.11	0.25	10.9	25.8
APR	19.5	31.5	0.15	1.34	15.4	8.9
MAY	33.9	42.4	1.09	2.94	9.8	1.2
JUN	48.0	52.5	3.67	3.46	4.2	Tr.
JUL	52.0	59.3	3.60	4.08	Tr.	N11
AUG	51.4	57.6	4.18	3.19	0.1	N11
SEP	41.8	49.0	2.41	3.95	12.0	N11
OCT	30.5	39.1	1.65	2.78	11.1	3.4
NOV	15.6	27.8	0.14	2.15	21.9	18.2
DEC	-2.4	18.9	0.06	0.89	16.1	28.7
YEAR	24.2	33.9	17.36	25.50	134.6	155.8

Period of Observation: Schefferville - 6 years
 Sept Iles - 18 years

Fig. 2. Climatological data for Sept Iles and Schefferville

L. Railway on the north shore of the Gulf of St. Lawrence; Schefferville is the northern terminus close to the geographic center of the interior plateau at an elevation of 1700 ft above sea level. Average freezing indexes based on 32°F for these localities are 2600 and 5100 respectively. The value for Schefferville is probably representative of a broad area of the interior.

The first practical contributions to knowledge of the extent and distribution of permafrost in Labrador-Ungava were casual observations of frozen ground conditions made during the course of the exploration and development activity that preceded current mining operations. These observations provided a point—the most southerly one in Canada and now the site of the mining town of Schefferville—on a map drawn by Jenness in 1949 to show the "tentative southern limit of continuous permafrost" [2]. In a later map [3], published in 1953, the same boundary line was described less precisely as the "approximate southern limit of permafrost." A note indicated that areas free of permafrost occurred to the north of the boundary but were of limited extent.

In 1950, the same field data had been used by Black to produce another map [4] that showed no continuous permafrost in Labrador-Ungava; instead, it indicated the boundaries of discontinuous and sporadic zones. The southern limit of the discontinuous zone was drawn approximately 100 miles to the north of Schefferville, while the sporadic zone extended southward to within 50 miles of the Gulf of St. Lawrence.

Following the start of mining operations in 1954, it gradually became apparent that permafrost in the vicinity of Schefferville was more widespread than had originally been supposed. Interest in the areal and vertical extent of frozen ground led the Iron Ore Company of Canada to undertake a program of ground temperature measurements which provided the first indication that some permafrost masses extended to depths in excess of 200 ft. The data obtained were of value in connection with the development of new orebodies and provided a foundation for subsequent studies by the McGill Sub-Arctic Research Laboratory at Schefferville. These studies, and those of the Division of Building Research of the National Research Council, Ottawa, have resulted in the publication during the past three years of two maps showing permafrost distribution in the peninsula.

A distribution map of permafrost in Canada was presented by Brown in 1960 [5]. It was based on information derived from field observations and recognized only two categories of permafrost: Continuous and discontinuous. On this map, the zone of continuous permafrost in Labrador-Ungava was restricted to a narrow coastal area along the shores of Hudson Strait and Ungava Bay; the southern boundary of discontinuous permafrost followed the 55th parallel of latitude closely and was drawn only slightly to the north of Schefferville. Both boundaries have been reproduced in a general way on Fig. 1.

A map compiled by Ives in 1962 [6] was based both on field observations and on the results of ground temperature investigations near Schefferville. Concerned primarily with effects of meteorological and surface conditions, these investigations [7] are incomplete, but they have led to interesting observations. It is suggested, for example, that under the subarctic conditions of Labrador-Ungava such secondary factors as relief, snow cover, and vegetation exert a controlling influence on the development and preservation of permafrost that is "compatible with contemporary climatic conditions." Significance is also attached to the effect of surface conditions on the distribution of relic permafrost; the spread of vegetation following deglaciation is concluded to have been the major factor in degeneration of widespread permafrost into scattered patches of frozen ground in a state of unstable equilibrium with the contemporary climate.

The importance of surface conditions is of special significance from an engineering and mining standpoint since such features can generally be mapped. The map prepared by Ives is a preliminary attempt to use this technique to predict the occurrence of contemporary permafrost. Mapping was undertaken largely on the basis of vegetative cover—thus allowing indirectly for the effect of snow accumulation—but considera-

tion was also given to the influence of topography. The zone for which contemporary permafrost is predicted includes most of the region north of lat. 55°N, and also embraces many scattered areas farther south. Areas with favorable meteorological and surface conditions occur even in the extreme south of the peninsula where they generally occupy higher, wind-swept elevations. This southerly region is also regarded as one in which patches of relic permafrost may occur with no apparent relation to existing surface conditions. Encounters with scattered permafrost during the course of mining and construction operations [8] tend to confirm these predictions and suggest that Labrador-Ungava should properly include a zone of sporadic permafrost as originally proposed by Black. The southern boundary of this zone is also indicated in Fig. 1.

MINE RAILROADS

Construction

Reference has been made to financial participation by steel companies in the development of mining operations in the interior of Labrador-Ungava. The investment of large sums of private capital in the railroads, power installations, and other facilities upon which these operations depend causes special emphasis to be placed on construction schedules and completion dates. As a result, economic and logistic considerations are of prime importance and tend to influence the approach to technical matters. This was particularly so in the initial mining development, undertaken when there was a lack of information concerning almost every aspect of the region. Since open-pit mining of a direct-shipping ore was the objective, no beneficiation plant—other than crushing and screening facilities—was involved, and hydroelectric power requirements were relatively modest. In these circumstances, the provision of a 360 mile rail link with the north shore of the Gulf of St. Lawrence represented the most important phase of the development program. With an anticipated production of 10 to 15 million tons annually, there was an obvious need for this link to be completed in the shortest possible time. Construction of the Quebec North Shore and Labrador Railway began in 1950 [9], tracklaying was completed early in 1954, and two million tons of ore were shipped during the first operating season. The average cost of the work was about \$325,000 per mile.

In the traditional approach to railroad location and construction, alignment and grades are established with the object of achieving a satisfactory compromise between minimum distance and curvature, and minimum earthwork volumes. Tracklaying is not necessarily the final stage of construction, since the flexible nature of a track structure permits grade lines to be raised appreciably over a period of time. Generally, the most suitable material for this purpose can be economically hauled by train, and placed with little disruption of traffic. Except in the southern 100 miles of the route, where ruling gradients and rock excavation were controlling factors, this approach was used for the Q.N.S. & L. Railway. It was recognized, however, that the railroad would be required to sustain unusually heavy traffic from the outset, and that an extended program of upgrading was therefore undesirable.

At least during the early stages of the work, little consideration was given to avoiding potentially troublesome materials or conditions, and no subsurface investigations other than exploratory borings at bridge sites preceded construction. The earthwork specification embodied none of the usual requirements covering the selection and placement of materials in subgrades, and no direct reference was made to the unsuitability of frost-susceptible soils.

The most serious frost-related construction difficulties occurred in 1953 when completion of heavy earthwork in more southerly sections of the route released a great deal of earthmoving equipment for use on the interior Lake Plateau, a comparatively flat, drift-covered area characterized by a profusion of lakes and expanses of organic terrain. The spring thaw, a lengthy period of slowly rising air temperatures, was accompanied by the deterioration of haulage roads, airstrips, and roads constructed during the winter to provide access to

working points in muskeg areas. Troublesome conditions were aggravated by persistent rain, melting snow, and a poorly-developed natural drainage system. The resulting distress to construction traffic focused attention on the more silty glacial-drift soils and lacustrine silts that were generally affected and led to recognition of their frost-susceptible nature [10]. It also led to the consideration of such potential maintenance problems as frost damage and icing.

Because a large amount of construction equipment was available for a relatively small volume of earthwork, the difficulties encountered in this area were not reflected as delays in the construction program. North of Milepost 150, where little grading work was undertaken before April 1953, tracklaying began in July and proceeded at an average rate of one mile per day until the northern terminus was reached in February, 1954. Whenever circumstances permitted during this period of rapid construction, the practice of balancing earthwork quantities in shallow cut and fill sections was abandoned in favor of more rational procedures.

Perhaps the most important improvement, certainly the one that contributed most to the elimination of maintenance difficulties in areas where it was adopted, involved the wasting of saturated, frost-susceptible soils in cut sections and their excavation for several feet below subgrade. The presence on the Lake Plateau of abundant sources of nonfrost-susceptible material in eskers, kames, and other granular landforms made this procedure possible. Since long hauls were sometimes involved, however, its use was restricted to situations in which good access roads and heavy haulage units were available.

Another improvement that served to expedite construction and reduce frost damage involved the treatment of embankment foundations. The construction contract included moss removal as a unit price item; and the specification stipulated that removal be carried out—unless otherwise ordered—in cases where the depth of moss was greater than one third of the height of the embankment as measured from hard surface to subgrade. This condition was found to apply more often than not; the depth of moss was usually about 4 ft; it was almost invariably underlain by a loose, silty-textured till or a highly frost-susceptible silt; and its removal was always responsible for distress to construction equipment. Since the material was found to consolidate rapidly even under shallow fills, the practice of allowing its removal was generally discontinued. During the first winter of operation, the presence of a layer of compressed organic material proved to be effective in limiting frost damage, even under embankments with heights of as little as 5 ft. Damage was severe in cases where the removal of organic material had caused equipment to become mired in saturated, fine-grained soils and where such expedients as corduroy had been necessary in order to provide a trafficable road.

Permafrost was not regarded as an important problem during construction of the Q.N.S. & L. Railway, but its presence was often reported in excavations for culvert installations and communication-line poles. Since most of these excavations were shallow, it was sometimes difficult to determine whether the frozen material was permafrost or residual frost from the previous winter. At two sites, however, deeply frozen ground containing a high proportion of segregated ice was responsible for local construction difficulties in shallow cut sections. The sites were a few miles apart and approximately 100 miles south of Schefferville [9]. Both involved silt soils in the vicinity of lakeshores, and both were less than 30 ft above present lake levels. It was necessary to drill and blast to a depth of 6 ft for a distance of 100 ft in one case, and 50 ft in the other.

Experience with ground ice and frost-susceptible soils during grading operations in the northern part of the route stimulated interest in the depth of frost penetration under various conditions of surface cover and in the rate at which frost could be expected to leave the ground during the spring. Ground-temperature installations in adjacent embankment, cut, and "undisturbed" situations were completed immediately in advance of tracklaying operations. These installations were

observed for one freeze-thaw season [11]. The data indicated that the probable frost penetration in nonfrost-susceptible materials would be about 6 ft in a typical cut section and 10 ft in a high embankment. They also indicated that thawing of the subgrade began in mid-May and continued for many weeks: In the case of the cut section, residual frost was present at a depth of 4 ft in the latter part of June; in the embankment it persisted at a depth of 7 ft until mid-July. The ground temperature measurements also provided a useful indication of the extent to which frost penetration is affected by snowplow operations, and by other activities that affect the depth and density of snow cover.

These observations were specially valuable in the final stage of construction when train-haul methods were used to raise grade lines in selected areas. Although the primary object of this work was the elimination of sags and summits that were undesirable from the standpoint of train operations, attention was also given to areas considered vulnerable to frost damage. Grades were raised as much as 4 ft in some locations. In grade-raising and bank-widening, low temperatures proved to be an advantage rather than a handicap; moist pit-run gravels that were difficult to discharge from railroad cars at temperatures between 15° and 32°F becoming progressively more free-flowing and easier to handle at lower temperatures.

In addition to profiting from experience gained during construction of the Q.N.S. & L. Railway, subsequent railroad construction operations in Labrador-Ungava have benefited from advances made in general knowledge of the region and from vastly improved facilities for transportation and communication. They have also been designed to serve mining operations of an entirely different type: One in which the ore is beneficiated before shipment. The time required for the construction of more elaborate facilities at the mine sites and for larger hydroelectric power developments causes some reduction in the emphasis placed on the speed of railroad construction—although rail facilities may still be required well in advance of production. In these circumstances it has been possible to devote particular attention to the formation of roadbeds that are subject to little or no frost damage.

Several operational features of the new mine railroads point to the need for stable roadbeds that require no major upgrading after initial grading, tracklaying, and ballasting operations have been completed. The moisture content of unbeneficiated iron ore causes it to freeze to the inner surfaces of railroad cars during winter operations; this limits the length of the shipping season in Labrador-Ungava to a period of approximately 200 days between early May and late November. Since this limitation does not apply in the case of beneficiated ores, which are free-flowing at all temperatures, the movement of ore by rail has ceased to be a seasonal activity. The change to year-round operations has led to a less tolerant attitude toward frost damaged track with its attendant speed restrictions and costly winter maintenance requirements. Another feature that has contributed to the need for higher construction standards is the increased use of welded rail in place of conventionally jointed track. Although experience has demonstrated the economic advantages of welded rail, maintenance difficulties are increased rather than diminished when excessive lifting and lining are required. The advantages are only realized when roadbeds and ballast sections are stable. The desire to minimize frost damage has resulted in the current policy of designing and constructing roadbeds to modern highway standards, with rigid specifications covering the selection and placement of subgrade soils. The earthwork specification for a 42 mile branch line completed in 1961—using 1000 ft lengths of continuously welded rail—required that excavations in frost-susceptible soils be extended to depths of 8 ft below subgrade. In this case, a frost-susceptible soil was defined for practical purposes as one in which the fraction passing the 200 mesh sieve exceeds 6%.

Operation and Maintenance

During its first nine years of operation, the Q.N.S. & L.

Railway remained in service continuously, but was required to sustain heavy traffic for less than seven months each year. The opening of a new mining area in 1963 modified this pattern; the southern half of the route now carries additional traffic that is more evenly distributed throughout the year. The annual movement of some 25 million gross tons over a single track during a short operating season calls for heavily loaded trains—trailing tonnage of about 16,000 tons and cars with gross weights of 125 tons—and cause's special importance to be attached to the performance of rail and other track components. In these circumstances curvature, gradients, and mechanical and metallurgical aspects of the track structure have emerged as critical factors in maintenance. Although the effects of subgrade support and ballast stability are not underestimated, it is significant that rail damage appears to be more closely related to curvature and grades than to roadbed conditions.

Frost damage to the roadbed of the Q.N.S. & L. Railway is restricted almost entirely to the northern 150 miles of the route, a section which carries no winter ore traffic. A fair indication of the extent to which it affects operations is shown in Fig. 3. This chart refers to a 40 mile section over which frost damage is regarded as severe; the speed restrictions are those applied on a week-to-week basis by authorities responsible for the maintenance of correct surface and line. Since no rigid dimensional tolerances are normally specified in trackwork, "correct surface and line" is understood to mean that track is considered to be in safe condition for the passage of trains at authorized speeds. Permissible speeds are 40 and 50 mph for loaded and empty ore trains respectively, and 60 mph for trains in passenger service. Fig. 2 indicates that speed restrictions were in effect over some part of the track between Milepost 270 and Milepost 310 for a period of 26 weeks in 1961, and that the early part of the ore shipping season was affected. During that year, differential heaving in this area reached a maximum of 0.45 ft, but was generally about 0.25 ft. Rail shimming to

eliminate abrupt changes in elevation was required at many cut-fill transitions, in some cut sections, and on a few low embankments. A continuing program of roadbed improvement involves bank widening, periodical lifting of track, drainage measures, and excavation and backfilling of some of the most severe frost-heave sites. In addition, experimental use has been made of spent sulphite liquor and sodium chloride as means of frost-heave control. In view of the objectionable consequences of saturating a subgrade in which excess moisture is a problem during the greater part of the maintenance season, common highway salt is considered to be the most satisfactory additive; it is now used extensively during the course of ballasting operations, and is applied directly to the roadbed or to the ballast section. Experimental use has also been of asphalt-impregnated ballast with a seal coat designed to prevent the ingress of surface water during the frost-melting period. The maintenance of frost-damaged track treated in this way is troublesome, but the treatment is beneficial in cases where differential heaving does not occur.

Apart from its effect on the roadbed of the Q.N.S. & L. Railway, frost action has been responsible for a number of local difficulties, but few major problems. At sites where isolated masses of permafrost were encountered during construction, experience has indicated that excavation did not result in complete removal of the frozen material. Pronounced subsidence occurred during the first years of operation, and some sites still require from 6 to 12 in. of additional ballast each year.

To expedite railroad construction, temporary timber trestles were used for short river crossings. No attempt was made to protect piles from seasonal frost damage, and the amount of work required to maintain line and grade across these structures led to their removal during the early years of operation. In most cases they were replaced by multiple installations of large diameter corrugated metal pipes or arches; these have performed satisfactorily in all respects. At one long bridge over a shallow water site close to the northern terminus, the penetration of freezing temperatures into highly frost-susceptible riverbed material and the growth of river icings during late winter were responsible for the heaving and tilting of one of the concrete piers. In a typical winter, the track close to the center of the bridge was affected by a short heave of approximately 0.5 ft and was displaced laterally by a similar amount. Remedial measures included excavating material around piles to a depth of 8 ft below the river bottom and incorporating 2 ft of organic material in the backfill as a frost barrier. To reduce difficulties caused by river icings, a batter of 1 to 3 was provided on the sides of the pier. No further heaving has been reported.

Jointed- and fissured-rock formations, high ground-water tables, and subsoil conditions conducive to side-hill seepage present situations in which icing difficulties may develop in Labrador-Ungava. In general, troublesome conditions can be anticipated and corrected by drainage improvements. Icing has been a severe problem for the Q.N.S. & L. Railway only in a few rock cuts and in one tunnel. Heating cables placed longitudinally in side ditches have overcome most of these difficulties. Where seepage is present, ice-lenses develop beneath the surface of cut slopes in banded silty clay soils and may cause troublesome sloughing during the early part of the spring; this condition is relieved by blanketing vulnerable soil formations with granular material.

Ice obstruction of culverts having small diameters is a persistent problem that requires thawing each spring by a portable steam plant. It is current policy to regard 35 in. diameter pipe as the smallest size suitable for any culvert installation.

CONCLUSION

Capital investment in Labrador-Ungava during the past 15 years amounts to almost \$2 billion, a large proportion of which has been used to build transportation facilities. This investment has resulted in improved communications and advances in knowledge that will inevitably lead to further development. It

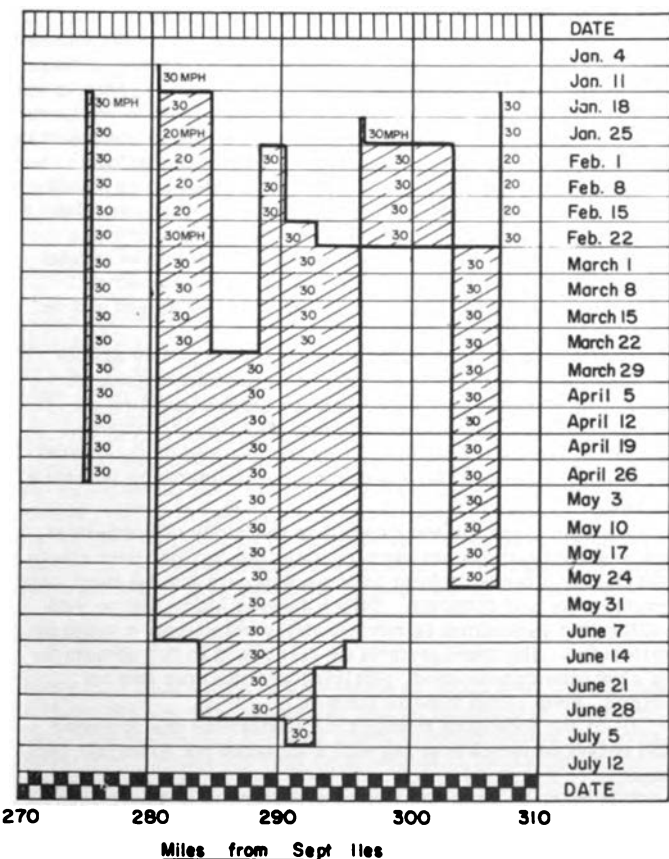

Q.N.S. & L. RAILWAY - MILEPOST 270 TO MILEPOST 310
 Fig. 3. Speed restrictions due to frost damage, 1961

has also diminished the importance of terrain and climate as serious obstacles. The region is thus one of those most likely to benefit from current interest in the improvement of techniques for civil engineering works in permafrost and seasonally frozen ground.

ACKNOWLEDGMENTS

The contributions of the staff of the McGill Sub-Arctic Research Laboratory, Schefferville, to knowledge of the extent and distribution of permafrost in Labrador-Ungava are gratefully acknowledged. Credit is due to K. B. Woods, Civil Engineering Consultant, and to the staff of the Division of Building Research, NRC, Canada, for their assistance in matters associated with permafrost and frost damage. The paper is published with the approval of J. A. Little, General Manager of the Quebec North Shore and Labrador Railway.

REFERENCES

- [1] F. K. Hare. "A Photo-Reconnaissance Survey of Labrador-Ungava," Dept. Mines and Tech. Survey Geog. Mem., No. 6, 1959, pp. 22-56.
- [2] J. L. Jenness. "Permafrost in Canada," Arctic, Vol. 2, 1949, pp. 13-27.
- [3] M. K. Thomas. Climatological Atlas of Canada, NRC, Div. Bldg. Res., Ottawa, 1953, p. 192.
- [4] R. F. Black. "Permafrost," Smithsonian Inst. Rept. 1950, 1951, p. 301.
- [5] R. J. E. Brown. "The Distribution of Permafrost and Its Relation to Air Temperature in Canada and the USSR," Arctic, Vol. 13, No. 3, 1960, p. 169.
- [6] J. D. Ives. "Iron Mining in Permafrost, Central Labrador-Ungava," Geog. Bull. No. 17, Dept. of Mines and Tech. Surveys, Ottawa, May 1962, p. 72.
- [7] J. D. Ives. "A Pilot Project for Permafrost Investigations in Central Labrador-Ungava," Geog. Paper No. 18, Dept. of Mines and Tech. Surveys, Ottawa, 1961.
- [8] J. T. Andrews. "Permafrost in Southern Labrador-Ungava," Geog. Dept., McGill Univ., Misc. Paper No. 1, unpubl., 1961.
- [9] K. B. Woods, R. W. J. Pryer, W. J. Eden. "Soil Engineering Problems on the Quebec North Shore and Labrador Railway," Bull., Am. Railway Engr. Assoc., Vol. 60, No. 549, 1959, pp. 669-688.
- [10] K. B. Woods. "Engineering Evaluation of the Terrain Crossed by the Quebec North Shore and Labrador Railway," Rept. No. 3, Q.N.S.L.R., unpubl., 1953.
- [11] R. W. Pryer. "Frost Action and Railroad Maintenance in the Labrador Peninsula," Bull. 218, Highway Research Board, 1959, pp. 34-48.

GUIDES FOR ENGINEERING PROJECTS ON PERMAFROST

E. S. PHILLEO, Philleo Engineering and Architectural Service, Alaska

Permafrost can present problems to every engineering project in the Arctic or sub-Arctic. To assess and solve these problems the engineer should first investigate, then consider the following possibilities: Vacate, separate, eliminate, insulate, cooperate, and create.

INVESTIGATE

No engineering project in the Arctic of any kind, size, or scope should ever be undertaken without first making a thorough permafrost investigation. Whether it be a satellite-tracking antenna or a fence, the presence of permafrost can make a vast difference in the design, location, permanence, appearance, and cost. Generally, the larger and more complex the project, the more extensive the investigation should be.

There are many ways in which an investigation can be undertaken. In some Arctic areas, detailed maps have been made showing the location of permafrost. This type of map has been prepared by Troy Péwé, University of Alaska, showing occurrence of permafrost in the Fairbanks, Alaska, vicinity. The map, published by the U.S. Geological Survey, has proved useful to both civilian and military engineers in the Fairbanks area. Had such a map been available earlier, many structural failures in this area might have been avoided. Certainly an engineer contemplating a project in the Arctic should seek out and study all available permafrost maps. There is a great need for more such maps especially in populated areas.

Airphotos can be very useful in detecting permafrost. The interpretation of airphotos to spot permafrost, or the lack of it, is complex and requires a trained and experienced eye. Many features that appear in a photo may indicate the existence or absence of permafrost. Permafrost areas on a photo are most easily seen if nonpermafrost areas are contrasted on the same photo.

If permafrost occurs near the surface, it nearly always retards tree growth. This is very evident in east-west valleys, where near-surface permafrost on the shaded south side supports only stunted spruce and other small brush, while the sunny north side, where frost is deep or nonexistent, supports many trees. Often a photo showing an all-permafrost

area, or one showing an all-thawed area, is difficult to read. There is no contrast, and unless the photo shows definite and distinct signs, it cannot be considered conclusive. Deep permafrost is very difficult to identify from photos.

Vegetation is one of the simplest ways to detect permafrost which occurs near the surface. Birch seldom thrives on frozen ground and spruce is usually stunted and scrubby. This is not always true, since birch and big spruce will both do well over deep permafrost. The appearance of sink holes or pot holes is usually very conclusive evidence that permafrost exists. These holes are most often observed in cleared areas where solar heat is allowed to attack the frost. They are usually formed by the melting of ice masses which are buried at a shallow depth and are thawed by solar heat when the insulating vegetation has been removed. The appearance of polygonal structures in an airphoto is very easy to detect and is evidence of permafrost.

Pingos, ice mounds, and peat mounds are easily distinguished on airphotos. They consist of rounded mounds of heaved-up material and are caused by ground swelling or hydrostatic pressure and subsequent buckling. "Drunken forests" are tilted trees caused by the heaving of the ground on which they grow. All these features indicate the presence of frost.

Geologic maps are very useful in the study of permafrost, since some deposits are more susceptible to frost than others, and the occurrence of frost in some deposits can be much more troublesome and difficult. Direct surface study can be very useful, but permafrost is more easily studied from a plane or helicopter. The same criteria as discussed in the paragraph on airphotos can be used. Walking over an area can be helpful, even if the view is limited.

All of the foregoing methods may determine the presence and extent of permafrost but will not reveal its character and depth.

Test pits are useful in locating shallow permafrost deposits. Test pits allow the investigator to observe frost and its in-place condition at close range. Test pits are limited in extent and expensive. It is usually impractical to sink a test pit deeper than 10 to 15 ft, although, early Alaskan gold miners sank shafts in and through frozen muck to depths of 50 or 60 ft.

Gold miners usually steam-thawed shafts by driving steam points into the ground and thawing 5 or 6 ft ahead. Shafts were nearly always cribbed if they were expected to stay open for long or if they passed through any thawed layers. Test pitting is usually replaced by drilling, or probing, which is much faster and simpler, but usually does not offer the advantage of first-hand observation. Drilling or probing will indicate depth to the top of the deposit and extent of the deposit for shallow frost.

Drilling is the most common, dependable, and versatile method for exploring permafrost. Several types of drills may be used in permafrost exploration, but churn and auger drills are the most popular. The auger drill has the advantage of obtaining dry samples more easily, but is limited in depth. A few of the very large auger drills are capable of drilling holes 24 to 30 in. in dia. Such a hole has the advantage of accommodating a man so that the sides of the hole can be examined in place. Samples brought up by an auger drill consist of ground, dry material which can be examined and identified. Some churn drills are equipped with jars and drive sample equipment; when so equipped, the jars can usually obtain dry, unground core samples, depending on hole depth and material. A churn drill must drill in a wet hole. Therefore, if jars and drive samplers are not used, the samples obtained are wet, making moisture content and correct temperature impossible to obtain.

In any drilling program to investigate permafrost, a complete and detailed log of each hole should be kept; all depths should be reduced to elevations above or below a datum, to facilitate comparison of different holes and to relate drill logs to construction drawings and topographic maps. Logs should note all changes in types of materials, grain sizes, moisture content, density changes, colors, and changes from unfrozen to frozen state and vice versa. Each material type should be sampled. Samples should be taken dry, if possible; should be carefully examined in the field when taken; and should be carefully packaged in moisture proof containers and labeled. Temperatures in drill holes should be taken at varying depths. For construction purposes, temperatures are very important, since frozen material near the thawing temperature could thaw and settle. For this reason, complete frost data, to a depth well below the construction foundation depth should be obtained. Samples should be examined carefully, analyzed, and tested in a laboratory, especially for moisture content and grain size. If the soil is used as a foundation material in its thawed state, all ordinary soil tests should be run.

VACATE

Where permafrost is encountered, usually the best advice is to vacate the site, except in rare instances where permafrost can be used to advantage. This will be discussed later. More often permafrost presents difficult and expensive problems.

To vacate may mean a move of only a few feet. A good program of investigation will determine whether a move is feasible. In the case of a highway location, a rerouting of a few miles would increase construction costs, but would pay off many times in savings on maintenance. In this regard, the future is a factor to be considered. Structures should be located to avoid permafrost and oriented so that possible future additions would also avoid the permafrost.

SEPARATE

Where it is impossible or unfeasible to avoid frost completely or to vacate the site, separation can be achieved in other ways. The construction of a building above grade on piling achieves separation. Insulation from frost may also be considered as separation.

The separation principle is used in many permafrost structures. Designing a heated building high enough to prevent heat transfer into the frozen ground has been successful. The structure needs free movement of air under it, even when snow piles high around it. This air helps to dissipate heat lost through the building floor, and the cold air under the building

freezes the ground in winter. The building shades the ground in summer, retards thawing, and keeps the insulating snow layer from building up on the ground, promoting deeper seasonal freezing.

At Ballaine Lake, near the University of Alaska, a satellite tracking station was constructed on steel piles to keep the warm building off the ground. Additional separation was effected by sleeves placed around the piles where they passed through the active frost layer; the annular space between sleeves and piles was filled with an oil-wax mixture. Unheated structures built over permafrost, by their shading and insulating characteristics, may cause permafrost growth and subsequent heaving.

ELIMINATE

Permafrost can be eliminated economically when it occurs in relatively small quantities. Frost-lenses, frequently excavated or thawed, are removed completely from the site. If frost is thawed and the material is left in place, great care must be taken to ensure complete compaction of the thawed material. Elimination can sometimes be combined with separation and insulation.

INSULATE

Frozen earth makes an excellent structural foundation material, but the problem is to preserve it in a frozen state. Insulation or the prevention of heat transfer into frozen material maintains the frost in its original and useful state.

In many Arctic regions moss occurs in thick layers and insulates the soil just below it from summer heat; thus permafrost exists at the moss roots all year around. This frost may often be used as a foundation. Highway engineers have built roads above this moss, taking great care not to disturb it. Often they not only preserve the insulation, but also add to it by piling brush and other debris on top before the gravel is placed. If the moss is to be left, clearing should be done by hand, as wheeled and track vehicles kill the moss. This construction method was used on a small airport project at Noatak, Alaska, with some degree of success. Although the airport did deteriorate, it was apparent that the problem spots occurred first where moss had been disturbed. Separation is also a form of insulation as it prevents heat flow into the frozen ground.

COOPERATE

Perhaps the best, easiest, and often cheapest way to deal with permafrost is to live with it, cooperate with it, and even use it to advantage. Many successful structures have been built on piles driven and frozen into permafrost. Ordinary piling in permafrost requires two precautions: First, to preserve the permafrost; and second, to eliminate seasonal frost action.

Several things may be done when using piling in permafrost to preserve the permafrost. Nonconductive material such as wood can be used for the piling. Surface moss can be kept in place to provide insulation. Structures can be built off the ground to stop heat flow into the ground; this permits free flow of air under buildings and active layer refreezing every winter. Another method which apparently has never been tried, but may be feasible, is to use pipe for piling. The top is arranged so that it is open, or at least so that there are openings to the atmosphere. During below freezing weather a small tube could be dropped down the inside of the pile and a vacuum created at the top of the small tube. This vacuum would exhaust the air from the top of the interior tube and the exhaust air would be replaced by the air below it in the tube, creating an up current in the tube and exhausting the bottom of the large pipe pile, drawing cold air down the large pipe. This would absorb ground heat and freeze the bottom of the pile into the ground. This method could be used to create permafrost in unfrozen ground. A few inconclusive tests were conducted by the author with makeshift equipment in the spring of 1963, and results appeared to warrant further experiments. At outdoor

temperatures of only -12°F , a household vacuum cleaner was used to lower the temperature in the lower end of a 6 ft long, 2 in. dia. pipe from 46 to 30°F . The experiment was set up as shown in Fig. 1.

Many methods have been devised to prevent heaving action on piles by the active layer. This is usually done by providing a sleeve around the pile. A method used several times with success employs an oversized pipe sleeve (Fig. 2).

Care must be taken to eliminate the chance of freezable foreign matter penetrating the annular space between the pile and the sleeve. A mixture of Tervan Wax and Mentor 28 Oil, which can be poured hot and forms a Vaseline consistency jelly, has been used successfully to fill this annular space and thus prevent intrusion of material that might freeze and form a bond. This method was used very successfully in the construction of a satellite tracking station near College, Alaska. Each season the sleeves heaved as much as 1 ft and had to be driven down again, but no pile movement was observed [1].

The thermopile invented and developed by Erwin Long, Anchorage, Alaska, (and discussed in this session) is an excellent example of cooperation with frost.

Refrigerated footings have been used on permafrost employing conventional refrigeration systems; but these have usually been expensive to operate and maintain.

CREATE

For many years, men have been so busy fighting frozen ground and trying to eliminate it that very little thought has been given to creating frozen ground and using it to advantage. Several years ago the U. S. Smelting, Refining, and Mining Co. wanted to excavate a narrow channel through a hill of fine silt. To prevent sloughing of the banks, to keep them steep, and to keep excavation to a minimum, their engineers froze the soil artificially; the operation was very successful. The use of the "Long" pile, or possibly the cold air pile described earlier in this paper, could have accomplished this freezing, perhaps at a considerable saving.

The Fairbanks contracting firm of Reed and Martin had a winter contract to construct a sewer crossing of the Chena River at Fairbanks, Alaska. Arnold J. Hanson, the engineer for the firm, used Stoddard solution as a heat transfer agent, pumping it through the ground in driven pipes and using automobile radiators to remove the heat from the Stoddard solution during subzero weather. By this method, he was successful in freezing coffer dams in the river, which allowed him to excavate and build his pipe line in a dry river bottom. Mr. Hanson also has plans to construct a frozen core, gravel fill hydroelectric dam near Fairbanks [2]. He intends to pump a coolant such as ethylene glycol through well casings driven into the core, to extract the heat from the ground, and dissipate it into the cold winter air with unit heaters used as heat exchangers.

Engineers are still pioneering in finding ways to create frost and to use it as a foundation material, a construction material, or a construction aid. When engineers adopt the principle of cooperation, great projects will be developed using frozen ground, and perhaps even ice, as foundation and construction material.

EXAMPLE

Recently, at the site for an addition to a school near Fairbanks, Alaska, permafrost was encountered in a fine sand at foundation depth. This sand had very high moisture content. Since this structure was to be an addition to an existing structure, there was no opportunity to vacate, and so, after careful and thorough drilling, probing, and testing, a plan was adopted that included these principles: Eliminate, separate, insulate, and tolerate. About 10 ft of frozen sand was excavated; some of it was wasted, and some was stockpiled to drain so that it could be used later for backfill. An added 10 ft was thawed in place by use of steam points and then compacted with roller-type equipment. Excavating and thawing thus eliminated about 20 ft of frozen material. After the 10 ft of

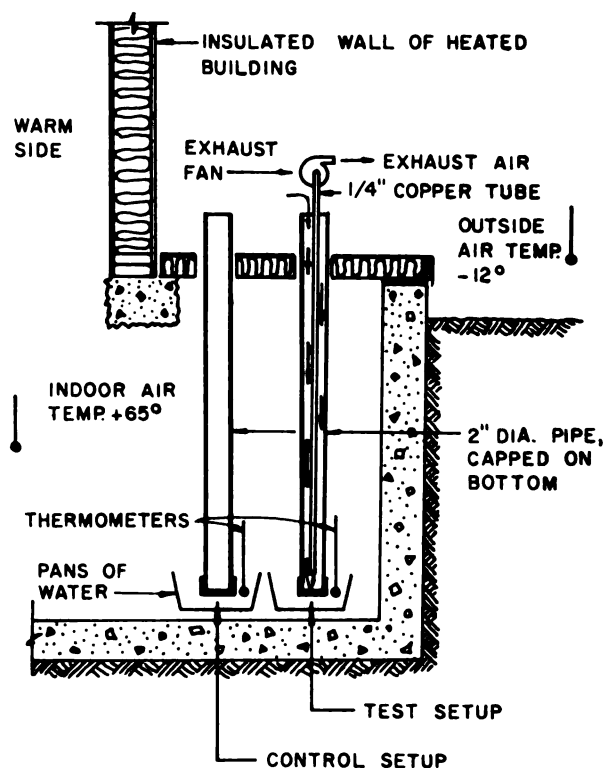

Fig. 1. Experiment in pile freezing using air as heat transfer media

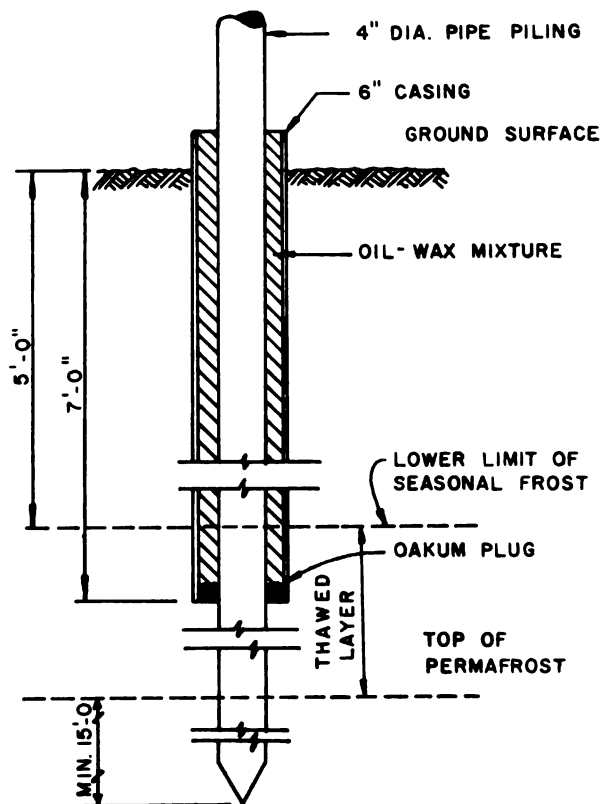

Fig. 2. Sleeves through the active layer around piles in permafrost

excavated material was replaced, an additional 3 ft of backfill was compacted in place. This, with the thawed material, gave a total of 23 ft of separation between the warm building and the permafrost. This separation was filled with gravel which acted as an insulator.

Corthell [3] reports that some building settlement would be encountered, but this could be tolerated. He reports that when the site was excavated, permafrost was encountered in the subgrade. This had previously been found in several of the original test holes, but was not expected to be a serious problem, as excavation was being made to soils of a nonfrost susceptible nature. As the permafrost thawed it was found to have an extremely high moisture content; the contractor was unable to compact the subgrade or place backfill on it satisfactorily. An examination of the existing building showed excessive cracking of block walls and concrete floors, and evidence that doors had required trimming due to shifting of the frames.

During May 1962, 24 additional borings were made in the excavation. In addition, samples of the soils encountered were collected, both in the frozen and thawed materials, for determination of strength and settlement properties. In general the soils found in the drilling and excavating were:

- Elevation (ft) and soils
 430 to 423; silt and fine sand
 423 to 412; fine to medium sand; very loose
 412 to undetermined depth; sand and gravel of moderate to high density

No log of the well drilled for the original building has been obtained, but the driller submitted the following from memory:

- Elevation (ft)
 430 to 415; excavated
 415 to 410; sand
 410 to 365; sand and gravel, frozen down to 380 ft
 365 to undetermined depth; mud

One of the test holes drilled during the week of May 21, 1962, was extended down to elevation 380 and verified this profile and provided additional soil samples for testing.

FOUNDATION FOR ADDITION TO SCHOOL

The problem of providing an adequate foundation for a school addition was considered from two aspects: (a) Damage due to settlement (as occurred in the existing building) was to be prevented; (b) more damage to the existing building had to be avoided as much as possible.

Operations which might have caused damage to the existing building included the generation of shocks or vibrations in the immediate area, lowering of the water table, or undermining existing footings. These considerations limited the use of heavy equipment, pile driving, extensive dewatering, and required strictest care in making a deep excavation adjacent to the existing building.

It was recommended that additional material be excavated to the depth shown on Fig. 3. As much of the soil was clean sand, it was stockpiled near the site, allowed to thaw and drain, and replaced in the backfill. The remainder of the backfill comprised classified material as described in the specifications. The remainder of the layer of loose sand, down to elevation 410, was steam-thawed prior to backfilling. Dewatering of the site was held to the minimum practicable during this work. As the water level was near the subgrade surface at completion of the excavating, the first lifts of backfill material were gravel, which was easy to compact in the extremely wet condition. The excavated sand was then placed in lifts of 8 in. and compacted. All compacting was done with rubber-tired rollers drawn by light rubber-tired or self-propelled tractors. The use of vibratory compactors was avoided in such close proximity to the existing building.

This approach was not expected to eliminate but would control settlement and restrict differential settlement to an acceptable amount. Most settlement occurred during construction, primarily during backfilling, and was harmless. This seemed the most practical solution, in view of the scheduling situation and limitations imposed by the existing building. Some settlement of the existing building was expected from work on the addition—but only settlement that would eventually occur anyway. All operations were planned so as to limit disturbances to the site. Continuous supervision was maintained during excavating and backfilling. Silty material was wasted, as it was difficult to compact in the backfill under high moisture conditions. Pockets of organic material exposed in the subgrade were also excavated as foundation uniformity was essential. As indicated before, methods of predicting the eventual settlement of this structure are not precise, and the recommended foundation revisions were based on the following considerations:

1. Differential settlement between adjacent columns should not be permitted to exceed one inch.
2. Differential settlement of this foundation type does not generally exceed 50% of maximum settlement.
3. In permeable subsoils under consideration, about 75% of the eventual settlement will occur during construction (primarily during backfilling).
4. No appreciable consolidation of the dense material below elevation 410 will occur.
5. Economy, and the present situation with regard to scheduling and existing contracts, must be obtained.
6. Some work operations which might be otherwise desirable are avoided to prevent further damage to the existing building.

SUMMARY

The site had foundation conditions which were somewhat unusual for the Fairbanks area. The very loose sand stratum had inadequate strength to support structures after thawing,

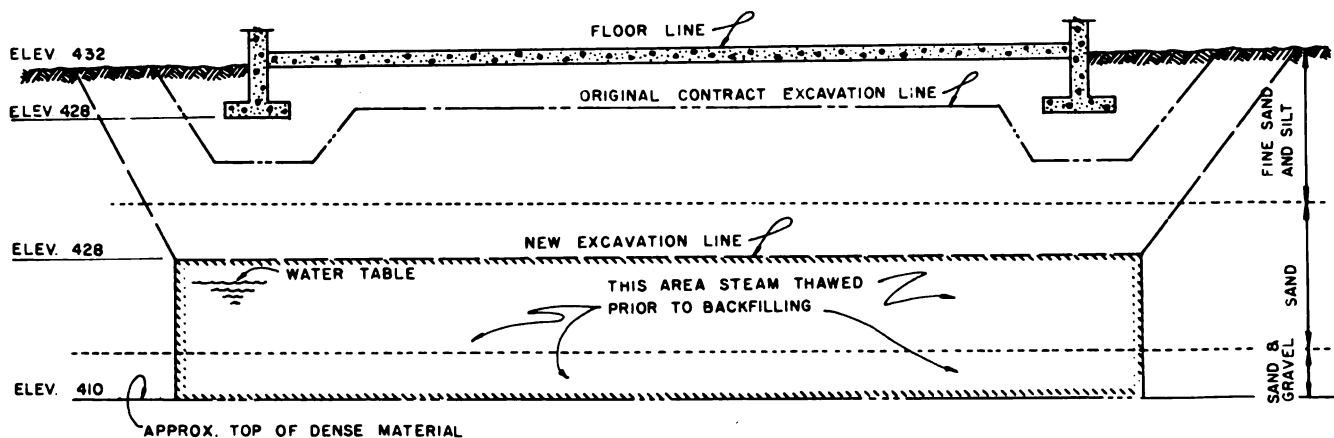

Fig. 3. Section through University Park School foundations

and settlement had caused much cracking of walls and floors of the existing building.

As all previous exploration of these soils was done during the winter, the high moisture content (and hence the loose condition) of this sand was not readily apparent. Proper records of difficulties in the original construction, and resultant changes in plans, were not transmitted to the architect for planning the addition. The floor level of the existing building is actually 1 ft higher than shown on the drawings (with respect to the original test borings), and the gravel fill extends 1 ft lower than shown. The addition was planned with approximately the same foundation as shown on the uncorrected drawings for the original building. This resulted in a design with 2 ft less of gravel fill than the original building.

This loose sand was subject to rather rapid volume changes when subjected to shocks or vibrations, and care was needed during any operations in the area to avoid such disturbance, or the existing building would have suffered further settlement.

It was recommended, on the basis of laboratory and field tests, observations, experience, and literature, to excavate

additional soil, to thaw 10 ft below the excavation, and to construct a compacted soil pad for a foundation. This provided for controlled settlement and caused most of the settlement to occur during construction. Close control of all operations during excavating and backfilling was essential. Additional settlement of the existing building is to be expected for an indeterminate period. The project was completed in September 1962, and to date there has been no indication of settlement.

REFERENCES

- [1] Edgar S. Philleo. "Construction of a Satellite Tracking Station on Permafrost," *Proc. 11th Alaskan Sci. Conf.*, 1961.
- [2] Ralph Nonson. "A Dream Comes True for Arnold J. Hanson Dam with Frozen Core near Fairbanks, Alaska," *Contractors and Engrs.*, Dec. 1961.
- [3] Alan N. Corthell. "Foundation Investigation, University Park School, Fairbanks, Alaska," Philleo Eng. Architectural Service, unpubl. data, May 1962.

MINING IN PERMAFROST

A. E. PIKE, United Keno Hill Mines, Ltd., Canada

Many northern Canadian mining companies have long encountered permafrost zones, but have not collected data on their operations. Problems were solved as they arose, and research has been negligible. Mining in permafrost has been essentially a local rather than a differentiated problem. There are advantages and disadvantages, but an advantage at one site may be a disaster at another.

OBSERVATIONS ON PERMAFROST

Maximum permafrost depth in producing mines (Fig. 1) varies from 60 ft at Eldorado Mining and Refining Ltd. to 900 ft at North Rankin Nickel Mines, Ltd. (Table I).

Permafrost depth at Giant Yellowknife Mines, Ltd. seems to be a function of overburden depth. Overburden is an insulating blanket that has preserved ancient permafrost and consists of lacustrine clays deposited during late Glacial or Recent stage, during which the level of Great Slave Lake was considerably higher than it is at present. Origin of the permafrost may be late Glacial or Interglacial in age [1].

United Keno Hill Mines, Ltd., (UKHM) is in a permafrost region. The permafrost is patchy in distribution and depends on elevation, hillside exposure, overburden depth, amount of vegetation, and flowing underground or surface waters.

Northern slopes of the hills are generally underlain by permafrost, whereas the lower southern slope of Keno Hill is

relatively free of permafrost. Mine workings on the top and northern slope of Keno Hill revealed permafrost 400 ft underground; on Sourdough Hill, frost and ice-lenses were encountered in the Ballekeno Mine workings 250 ft underground. On the lower southern slope of Keno Hill, however, Mount Keno Mine workings show no evidence of permafrost.

Frost action and solifluction have had a marked effect on rocks on the top of Keno Hill and generally in all permafrost areas. Rock and even vein floats are brought to the surface by frost-heaving; solifluction, stone rings, polygons, and stone rivers are widespread. Below 4500 ft, rock outcrops are sparse; slopes are covered with till, soil, rock debris, muck, and muskeg in which conifers, birch, aspen, buckbrush, and other vegetation grow abundantly. Above 4500 ft outcrops are numerous, soil and till are sparse, and the ground is covered with local rock float. The terrain is treeless and vegetation is limited to alpine varieties [2].

Rock types at UKHM are essentially quartzites and schists. Massive ice occurs in veins, stringers, and small irregular pods in vein faults, cross faults, and fractures; as delicate skeletal and stellate forms, and as hoar frost on walls of mine openings in the permafrost zone. Some ice veins form stock-work cementing rock slabs in sheeted zones and occupy solution cavities and other open spaces in the permafrost zone [3].

At the property of Canada Tungsten Mining Corp., Ltd., permafrost occurrences are irregular. Factors influencing

Table I. Summary of data on six Canadian producers

Name of Mine	Location	Permafrost Depth (ft)	Ambient Temp. (°F)	Temp. Gradients	Remarks
Consolidated Discovery Yellowknife	N Lat. 63°15' W Long. 113°50'	300	22	1° per 100 ft	Close to large lake
Giant Yellowknife	N Lat. 62°29' W Long. 114°38'	280	22	Close to lake
North Rankin Nickel	N Lat. 62°49' W Long. 92°05'	900	22	Sea is 1000 ft from head frame
Eldorado Mining and Refining	N Lat. 59°35' W Long. 128°15'	0-60
Canadian Tungsten	N Lat. 62°00' W Long. 128°15' (no deeper test taken)	35	Seasonal frost is 6 ft
United Keno Hill	N Lat. 63°51' W Long. 135°31'	450	26	Varies in each mine	Elevation from 4500 to 6500 ft

occurrences are moss cover, clay beds between gravel layers, and sediment composition. Permafrost has not been noted in their open pit at 4500 ft above sea level [4].

Operations at North Rankin Nickel Mines, Ltd. were entirely within permafrost. One factor influencing permafrost depth is the very low air temperature over much of the year. The location of the mine close to sea water does not seem to have any moderating effect on rock temperature [5].

Mining in permafrost is costly when it involves heating mine air or building roads and plants. Many Canadian mining companies not only mine but also completely operate whole communities.

Many mining problems in a permafrost area are minor and easily solved; they are discussed below at various mining stages.

DRILLING

Drilling efficiency in a permafrost zone varies widely and therefore is difficult to compare to drilling efficiency data compiled on other rock types. Often drill holes with water must be blasted or cleaned with compressed air on the same shift, or the water freezes in the holes. The drilling face may become covered with hoar frost and sometimes water running down the face starts to freeze; the machines may become coated by an ice film. With high humidity, as in summer, any moisture in the compressed air tends to condense once it reaches the lower temperatures of the underground workings and results in frozen air lines and machines. At the North Rankin Nickel Mines, Ltd., a heated salt solution must be used for drilling water; salt corrodes the drills and increases maintenance costs.

BLASTING

In permafrost zones, ammonium nitrate-fuel oil (AN/FO) explosives, if left in a misfire hole, tend to absorb moisture and freeze solid. This sometimes occurs when an attempt is made to wash AN/FO explosives from a hole. Normally, this type of explosive is not used in holes surrounded by an ice concentration.

VENTILATION

Mechanical ventilation with heated air is often the best solution to many permafrost problems.

Many mines in Canada that use mechanical ventilation must heat air before introducing it into the mine because of extreme winter temperatures. This heated air helps control freezing damage, particularly in pipelines and drainage systems. One requirement for heating mine air is preheating fuel oil to prevent gelling under cold conditions.

Ventilation causes permafrost to retreat from the mine opening, but permafrost returns if the air flow is stopped, suggesting very little retreat. Natural ventilation, with heat created by working men and equipment, does not noticeably change permafrost until considerable time has elapsed, and even then the change is small. Surface openings must be regulated to prevent freezing temperatures within the mine during severe cold weather.

UNDERGROUND TRANSPORTATION

At North Rankin Nickel Mines, Ltd., this phase of mining is seriously affected by cold. Diesels require large volumes of

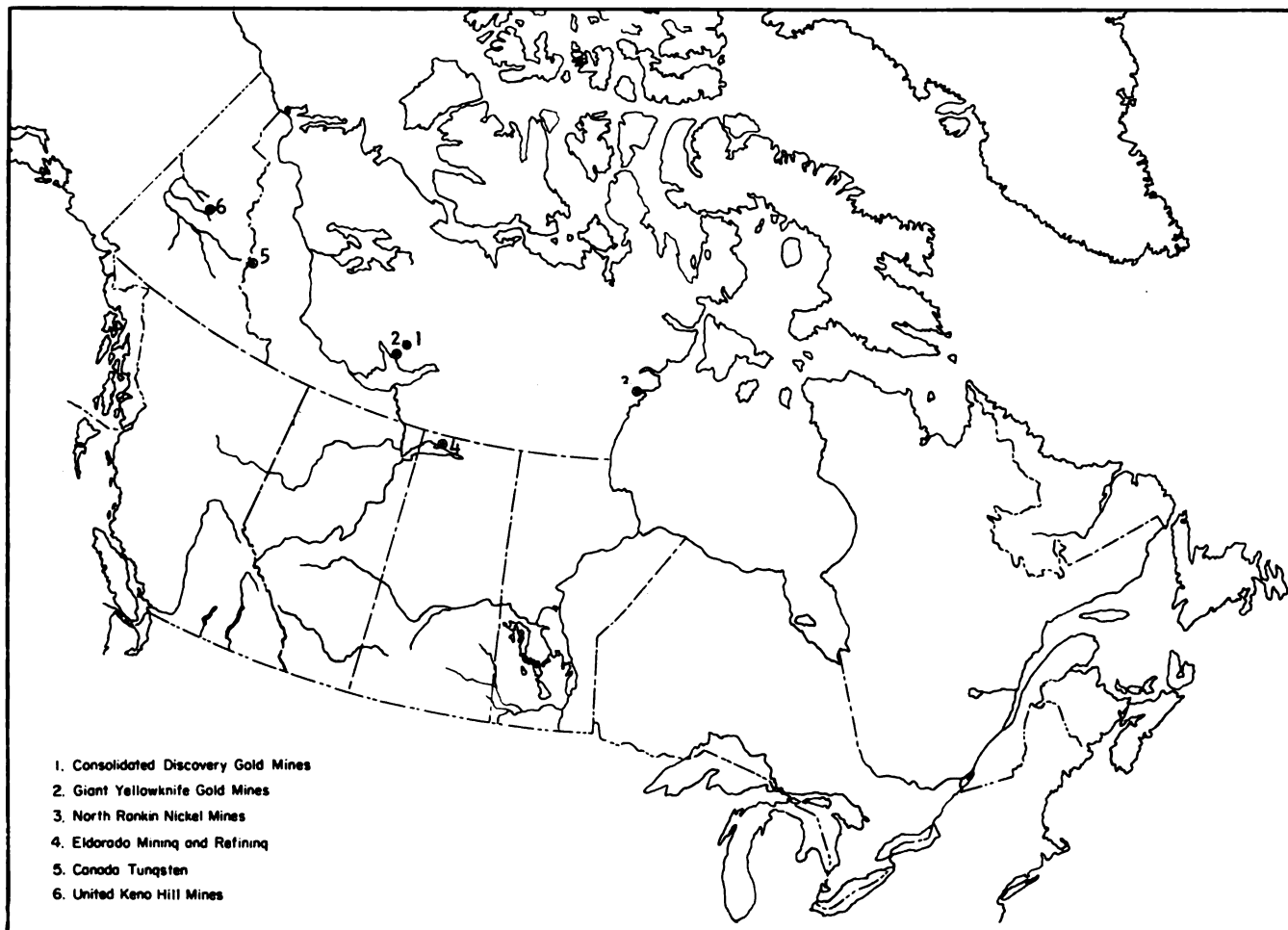

Fig. 1. Locations of six Canadian producers

fresh air in the headings. This entails the heating of large volumes of air at high cost through a wide temperature range.

The only major problem with tramping is caused by water which seeps down from the backs. This tends to build up as slush or ice along the track and affects motor traction. Any water touching machine metal freezes very rapidly, forming an ice covering that must be removed frequently. When seasons change, underground as well as surface equipment must be serviced with suitable oil and grease, depending on existing conditions. Mine cars, especially in adit tramping as at UKHM, require a lighter grade grease in winter. Adit haulage means added cost in keeping tracks ice-free. Sand is used for better locomotive traction.

At Giant Yellowknife Mines, Ltd., ventilation is adequate to cause permafrost retreat so that icing conditions do not occur.

Another problem that arises from permafrost and seasonal changes in temperature is track heaving and sinking. Track ties become loose and must be respiked and retamped. Continuous thawing and freezing rots ties and they must be replaced more often than normally.

GROUND CONTROL AND SUPPORT

At UKHM, frozen ground, despite its apparent competence when first exposed, must be tightly blocked in anticipation of rock conditions after permafrost retreat. Permafrost in certain oxidized, fractured, and crushed ground can aid in preliminary development and production. It acts as a cementing agent, and ground that would otherwise be considered difficult can be mined with a minimum of timber. This type of ground when frozen, tends to be "rubbery" and difficult to break, but proper attention to drilling and blasting practices eliminates this problem.

In permafrost areas any entry subject to seasonal thawing or open to surface drainage gradually fills with ice. In old headings the ice has often been a support and preservative in keeping headings and timber in good condition.

At Eldorado Mining and Refining, Ltd., ore was mined up to the gravel where overburden was frozen. This aided in low-cost recovery of ore under conditions that would have otherwise been very expensive. Sometimes frost did retreat, causing some minor running before the area was mined out and backfilled.

Frozen ground, if left unsupported or partially supported for a long time in a working heading, begins to spall; if this section is not timbered immediately, there is danger of caving. At UKHM, it is sometimes necessary to retimber several times in permafrost areas, especially after each seasonal thaw, as the timber begins to move and rock begins to spall from the ribs and back.

DRAINAGE, PUMPING, AND WATER LINES

There are constant mining problems at UKHM due to permafrost and intensified by extreme winter temperatures. Frozen drainage ditch problems are usually solved at UKHM by building sumps well within the mine and pumping the water out at sufficient velocity to prevent freezing.

At North Rankin Nickel Mines, Ltd., pumping stations are required wherever there is even a small flow of water and must be constantly attended to prevent slush forming around the intake. Unless pumping is continuous the pumps are not left unattended. If the pump shuts down or is shut down because of lack of water, pump lines must be blown out immediately and all water removed, or the lines will freeze solid before the next pumping cycle starts.

Pumps at UKHM are automatically controlled with warning devices set up within the compressor house so that any apparent stoppage is attended to at once. It has been necessary on occasion to install heating lamps near liquid level controls to prevent ice forming around them and to add an antifreeze to lubricators of air-operated pumps.

Pump lines must be installed on an even grade as any dip traps water, which freezes at the low point. It is not desir-

able to change from a 3 to 2 in. line as water freezes at the reducer. Some pump lines at UKHM have glass fiber insulation and, despite the above precautions, there is sometimes a gradual ice buildup on the inside of the pipe which eventually leads to a solid plug. The discharge end of the pipes must be watched in freezing temperatures as water dripping from them freezes and gradually builds up, encircles, and seals the pipes.

Drill waterlines are also a problem. The usual method of overcoming freezing is to install a continuous water circuit. A circulating pump, together with a water heater, usually keeps circuits free and operational. Placing waterlines beside compressed air lines, especially main lines, often helps reduce freezing. Waterlines also freeze at the junction of headers and hoses in some working headings. When this situation occurs, hoses are placed in a warm area at the end of each shift, and lines are drained. The air line must be kept ahead of the waterline when blowing air.

Air lines can become frozen if they are not cleared of moisture. Some lines that lead off into stopes or other headings must be blown out or drained at the end of each shift. Occasionally, adding antifreeze to the lines suffices. This freezing condition is more noticeable in summer when the humidity is high.

Underground air receiver tanks must be bled frequently or condensation in the tank freezes.

Permafrost and low temperature problems of drainage lines, pipelines, and pumping stations are not too difficult to solve, but resultant costs can be high. Installation of steam lines beside drill water and drainage waterlines has also been used to prevent freezing.

BACKFILLING

At UKHM backfill is mainly waste from development headings. If this is left in waste passes in the permafrost zone the muck freezes in place. Backfill therefore must be pulled regularly, and sometimes waste passes must be left empty.

At North Rankin Nickel Mines, Ltd., placing of backfill from surface is restricted to summer when material is thawed and easily handled. Once placed, permafrost is an advantage as the low temperature quickly freezes fill into a solid mass permitting removal of pillars with very little hazard soon after completion of backfilling.

Low temperatures and permafrost conditions markedly affect shaft sinking in the Canadian North. These low temperatures accentuate problems normally encountered in permafrost conditions involving pipelines, drills, pumping, etc., as previously described.

Also, headframes and ore bins must be adequately heated. Special shaft-sinking problems arise from setting foundations and collaring in permafrost. Headframes, hoist installations, and shaft collars must be firmly set to prevent frost-heaving and, where possible, set on bedrock.

Ventilation fans near shaft collars are usually installed horizontally rather than vertically as ice buildup, if permitted to grow, falls onto the blades. Heating elements wound around the air intake prevent ice buildup. If protective screens at intake or exhaust openings are not checked regularly, hoar frost buildup on screens will eventually seal the opening.

Once a shaft has reached the producing stage, ventilation and heating must be designed to minimize icing conditions at the collar and headframe.

CONCRETING

Concreting in permafrost requires special techniques because contact and freezing weakens both the concrete and bond. To prevent this, the rock must be heated for a long time to draw the frost. Heated concrete is then placed to obtain the required set before permafrost again invades the contact area.

SAFETY

Permafrost zones when first opened present little ground

hazard because of the cohesiveness of ice and rock, and ground falls occur far less frequently than under thawed conditions. However, once permafrost begins to retreat, ground falls increase, and support is required. It is safer and more economical at UKHM to do adequate timbering when the ground is first opened.

In permafrost zones, as mentioned, seepage water or drilling water freezes on and between the rails, creating a slipping hazard. This ice buildup is particularly hazardous on ladder rungs in escapeways and manways.

Frozen timber installed in permafrost underground is more difficult to handle; more slipping, falling, and handling accidents result. Under these cold conditions, more back sprains occur than in warmer headings.

DIAMOND DRILLING

Holes drilled in permafrost zones must be blown out with air between shifts to prevent water freezing in them. Even during a shift, diamond drill rods left in a hole without circulating water freeze and become difficult to move. This situation is alleviated by using either heated drilling water or a salt solution, or both.

PROSPECTING

Prospecting in permafrost areas is difficult because of the frozen nature of the ground. The covering of mantle material makes trenching difficult; it is commonly frozen to bedrock, and summer thawing is relatively shallow. For example, stripping is often best done by bulldozing and ripping the thawed material down to permafrost, then leaving the area to thaw further, and returning later to strip again. Sometimes only 6 in. can be removed at each pass.

SPECIAL TECHNIQUES

Experience with permafrost conditions for several years makes unusual problems seem routine. One learns to take advantage of special conditions that exist as well as to develop techniques that overcome disadvantages. For example, at low temperatures UKHM makes use of ice bulkheads in winter to close surface openings and thereby control ventilation and temperatures underground.

The Treadwell Yukon Co., UKHM's predecessor, used shrinkage stoping at the Silver King Mine, but abandoned it

below the permafrost horizon because of increased dilution from the hanging wall. Permafrost was an advantage here, because it consolidated the ground and permitted mining of ore by a cheaper method. Any breakthroughs of workings to surface are usually planned for winter when the ground is more consolidated.

Drilling water at UKHM is heated by electric immersion heaters in mobile water tanks. The tank is then connected to the air lines at the heading, and water is forced to the rock drill machines under air pressure.

Drainage ditches are kept open in some workings by installing electric soil heating cables along the length of the ditches. Immersion heaters are occasionally used to prevent ice formation in sumps. Other ice control methods were previously described.

CONCLUSION

Mining in permafrost differs from normal mining in that freezing temperatures create costly problems and involve many variables. Frozen conditions can also be an advantage. The variables depend upon mining method, heading purpose, equipment availability, and ventilation safety requirements.

Mining companies in the Canadian North have usually developed solutions that served their purposes. Converting permafrost to an advantage is both interesting and challenging work.

REFERENCES

- [1] J. D. Bateman. "Permafrost at Giant Yellowknife," *Transl. Roy. Soc. Can.*, Vol. 43, Ser. 3, Sec. 4, June 1949.
- [2] R. W. Boyle. "Geology and Geochemistry of Silver-Lead-Zinc Deposits of Keno Hill and Sourdough Hill, Yukon Territory," *Geol. Surv. Can.*, Paper 55-30, Ottawa, 1956, pp. 3-4.
- [3] R. W. Boyle. "Current Operations at United Keno Hill Mines," *Can. Mining and Metallurg. Bull.*, Vol. 54, No. 594, Oct. 1961.
- [4] S. J. Hunter. Canada Tungsten Mining Corp., Ltd., Jan. 23, 1963, priv. comm.
- [5] S. S. Teal. North Rankin Nickel Mines, Ltd., Jan. 16, 1963, priv. comm.
- [6] R. W. Boyle. Priv. comm.
- [7] J. M. Douglas. Eldorado Mining and Refining, Ltd., Jan. 29, 1963, priv. comm.
- [8] G. Muscroft. Giant Yellowknife Mines, Ltd., Jan. 22, 1963, priv. comm.

FOUNDATIONS IN PERMAFROST AREAS

GORDON B. PRITCHARD, Department of Public Works, Ottawa, Canada

A study of foundations in permafrost areas clearly reveals that permafrost can only be regarded as a variable. It is cunning, baffling, and powerful, and must be approached with the greatest respect. Permafrost is not so much a material as a condition in which materials exist. These materials may exist, side by side, under the same conditions, reacting to foundations in many different ways, each creating a separate, though related problem in foundation design.

My observations are confined to the Canadian Arctic and sub-Arctic, and to areas in Canada where I have personally examined site conditions and construction of foundations. These areas include permafrost regions from Baffin Island to Alaska, but do not include the islands of the far North.

It is only within the last 10 to 15 years that major construction has taken place in permafrost areas of Canada and consideration given to providing permanent foundations for superstructures. Before this it was known that ground under buildings would thaw and buildings would move; this was an accepted hazard. When it occurred the building was jacked level and wedged into place with wood, stone, or any other

material at hand. It was an annual occurrence and considered to be regular seasonal maintenance. It was only when large sums of money were to be invested in structures that engineering consultants were called in to provide foundation stability; a study of some early site reports and recommendations indicates how little was known even ten years ago.

Half of Canada is underlain by permafrost. This includes almost all of the Northwest Territories, Yukon Territories, and northern parts of some provinces, principally Manitoba and Quebec. Soil conditions involved are like those found elsewhere in Canada, except that the soil is perennially frozen. Some seasonal thawing does occur in the active layer. Maximum depth of thaw varies with locality, climate, and insulating value of the natural moss or brush cover. Below this active layer the soil remains perennially frozen. One of the most spectacular examples was observed at Chesterfield Inlet on the northwest side of Hudson Bay where, in mid-August, it was possible to remove 8 in. of moss covering and to cut a block of clear ice for the refrigerator within 10 ft of a pool of water surrounded by grass and flowers in bloom.

DESIGN PROBLEMS

The occurrence of ice in permafrost creates a major problem in foundation design. The imperviousness to water of many frozen soils is a second major problem. Both problems exist because of the sensitive thermal regime found in permafrost. Soils that contain ice may have very high bearing capacities as long as they remain undisturbed and permanently frozen, but thermal balance is so sensitive that any disturbance produces reactions that can only be assessed by on site observation. Change in natural ground cover affects permafrost stability. Removal of moss may seriously alter the active layer depth and change the approach to foundation design.

Another major problem in designing foundations for permafrost areas in Canada arises from the location of most of our northern settlements. Almost without exception they have been established at mouths of rivers or at river junctions. In many cases island sites have been selected, and on most islands permafrost is found in a variety of materials. Delta and island sites produce the worst possible instability in soil-bearing conditions due to their high percentage of silt; they are also subject to periodic surface flooding such as occurred at Aklavik in 1962 and at Hay River in 1963. The solution to this problem may be that island sites should be abandoned and new towns should be established at carefully selected sites on the mainland. This was done when the major settlement at Aklavik was moved to Inuvik; and it is now planned to locate a new townsite at Hay River.

Sporadic permafrost occurs along the entire southern boundary of the permafrost areas. In these areas, unexpected pockets of permafrost are often found at sites that have been test drilled and pronounced free of permafrost. These pockets vary in depth and thickness. At Thompson, Manitoba, the site for a new federal building was found to be frost free on one side of a diagonal and to have a 20 ft thick layer of permafrost 10 ft below grade on the other half of the lot. Excavations for a school and two hostels at Fort Simpson were frost-free in areas that had been cleared of brush and trees for some years, but in recently cleared areas permafrost was encountered under part of the school and one hostel.

Recent construction at Frobisher Bay on Baffin Island was carried out on solid rock to avoid the variety of soil conditions found during investigation of the proposed townsite. Most of the townsite was overlain with silt, sand, gravel pockets, and large boulders in layers of greatly varying thickness. Solid rock was found as outcroppings and at varying depths as great as 85 ft below the ground surface. The site finally selected was on two large rocky hills having a few small pockets of frozen overburden 8 to 10 ft thick; all foundations were designed to bear on solid rock. The entire townsite was drilled on a 300 ft grid, and actual building sites on a 50 ft grid. All holes were drilled to rock and at least 10 ft into solid rock. Rock cores showed almost 100% recovery and only minor evidence of fracture or water seepage. Inclined holes failed to disclose any evidence that the site was anything but solid rock. Construction proceeded. Running water was encountered in several pier excavations. In one hole a thin stratum of stone was found to overlay several feet of sand.

Observations such as these lead me to believe that nothing can be taken for granted in the design of foundations in permafrost. Each site must be carefully examined both above and below ground to determine proper foundation designs. Site conditions vary not only with each location, but also with each segment of each location.

As buildings in northern Canada progressed from squatters shacks to more substantial buildings of the Hudson Bay Co. Trading Posts, Royal Northwest Mounted Police (now Royal Canadian Mounted Police) Outposts, and missions, foundations changed from mud sills or gravel pads, to piles or piers. As buildings grew in size and value, the problem of adequate foundations had to be solved. The basic question was whether to accept or to prevent movement of the foundation. Generally the decision was to accept some movement in small, unheated buildings of lesser importance, but to prevent movement in large, heated, permanent buildings. To avoid movement it was early learned that underlying permafrost must remain

undisturbed. Thus precautions must be taken to preserve natural moss cover and to prevent large heat transfers from buildings to ground.

In any practical assessment of building techniques in permafrost, matters of economics, availability of local materials, and methods and costs of transportation are of overriding importance. These factors have dictated use of wood piles in western areas of northern Canada, where local timber and river transportation are readily available, but required use of concrete and steel in the barren eastern areas. In the Mackenzie River District and the Yukon Territory where local timber is available, most building sites occur in areas underlain with silt, sand, gravel, and organic materials which simplify the placing of piles; however, concrete foundations are better suited for sites in the eastern rocky barrens.

Fortunately, construction in the north progressed from a few small buildings to a greater number of small buildings; thus valuable experience was gained before the need arose for large buildings. The effects of increased construction activities were carefully watched. Movement of vehicles over moss cover, and ditching of roads turned apparent solid ground into a morass of mud. Excavated shale disintegrated on exposure to air. These observations taught caution, so that when construction of large buildings began, those responsible had learned the need to take precautions when building in permafrost areas.

TYPES OF FOUNDATIONS

Most early foundations were simple mud sills of local timber laid in gravel or sand and leveled with the same material. The sills supported main beams of building and superstructure. During winter, buildings were banked with sand, sods, or snow blocks for protection from the cold and wind. Heat losses through the floor, however, changed the character of permafrost so that shifting and heaving of foundations occurred. To avoid this, buildings were raised above ground so that heat losses would dissipate by free circulation of air. Other buildings were placed on thick gravel pads to prevent heat losses from reaching the permafrost. Later these methods were combined by placing a gravel pad over the natural cover and raising the structure to provide for passage of air between the floor bottom and the gravel-pad top. This foundation design proved very successful and was used extensively in building the new town of Inuvik.

Along the central Arctic coast at Spence Bay in Boothia Peninsula, Cambridge Bay on Victoria Island, and Coppermine on the mainland, it was possible to locate most of the buildings on rock and to use concrete piers having a batter of 2 to 3 in. in 1 ft. Other buildings in these areas are on low-lying, poorly-drained sites; in these cases the site was filled with gravel and squared, cresoted timbers were embedded in the gravel. On these timbers wood posts and beams were erected to support the superstructures. At Old Crow in Yukon Territory this method was used to erect the nursing station but the adjoining school was built on rock-filled log cribs placed directly on the natural cover. These simple foundations have proved effective, and can be used where timber and gravel are close at hand, where suitable bearing for concrete piers cannot be found, or where it is impractical to place piles.

Many foundations have been designed for permafrost areas on the assumption that sand and gravel are readily available at all sites. At Coppermine two methods of obtaining gravel were used. In summer it was hauled seven miles across the bay on a scow pushed by a small outboard-motor boat; in winter it was hauled by dog sled. At Fort McPherson hand-loaded gravel was hauled 30 to 40 miles by river barge. In the James Bay and Hudson Bay areas gravel has been hauled in canoes and carried by Indians with sacks on their backs. At many sites, obtaining gravel for fill is a serious problem; gravel suitable for concrete must often be carried many miles by primitive methods. It is a mistake to base designs on the use of gravel before determining its quality and availability.

The most widely used foundations in permafrost areas of Canada continue to be wood piles set into permafrost which

is permitted to refreeze before the piles are loaded. At Inuvik more than 17,000 wood piles have been placed and more are going in as this paper is being written. Great numbers of wood piles have been used in all settlements of the Mackenzie District and have proved to be a satisfactory solution to the foundation problem.

In northern Canada very few pile holes have been drilled. Nearly all the holes have been steam jetted. This method of placing piles reached a fine degree of excellence during the building of Inuvik, where through trial and error, workmen and supervisors developed a special sense of timing and control.

INUVIK

Inuvik proved to be a valuable testing ground. It was found necessary to control every kind of activity during the construction period. Movement of vehicles and mobile equipment had to be supervised to prevent destruction of the natural moss cover. All traffic lanes were built up with gravel on top of the natural cover; no ditching was permitted. Culverts placed in the gravel fill were used for drainage. Contractors drove over prepared gravel routes and stored building materials on prepared gravel pads. Every movement was planned and strictly controlled.

Some unusual occurrences were observed during construction at Inuvik. On the first hostel building the framing had been completed and the roof was in place when work closed down for winter. In spring, when work recommenced, it was found that the center piles of the south wall had heaved as much as 2 in. with diminishing movement back toward the center of the structure. A crack had opened in the surface of the gravel pad following the same line to the center of the building where it turned an abrupt right angle until it dwindled out. One of the heaved piles was dug out and found to have been frozen in place throughout its entire length. After many discussions, without reaching any firm conclusion, a calculated risk was taken and the heaved piles were cut to the new levels. This happened several years ago; since movement did not recur, it is concluded that the permafrost had not refrozen completely until after the heaving had occurred.

When piling started at Inuvik, it was thought that a complete winter must elapse before placing the superstructure on the pile foundation. It was later learned that this was unnecessary, so freezing-in time became four to six weeks for light loads and slightly longer for heavier loads depending upon the time of year that piles were placed. Piles placed late in the year, at the time of maximum thaw, required a much longer refreezing time than those placed in spring or early summer. Steel piles and pile clusters required a much longer refreezing time. Piles under the powerhouse, placed in November, were not refrozen by March of the following year. Pile clusters under the maintenance garage at the airport were placed on sloping bedrock; the piles were set so close to each other that the steaming process raised the temperature of the entire building area to the point where it became plastic and flowed off the site leaving the piles standing without lateral support.

FORT McPHERSON

At Fort McPherson, some 80 miles south of Inuvik, test pits indicated that the entire building site was underlain by hard shale at a depth of 6 to 7 ft. It was considered that the overburden did not appear deep enough to support wood piles, so concrete footings and piers were used for foundations. By arrangement, as soon as shipping opened, a local shipping company began to bring in gravel for concrete from a deposit some 40 miles downstream. A crew, armed with picks and shovels, was flown in to start excavating for the piers so that concrete could be poured as soon as the gravel arrived. Heavy equipment was scheduled to arrive about the same time as the gravel.

The inadequacy of the site investigation soon became evident. When the piers had been located, the moss stripped back, and excavation started, it was discovered that much of

the soil was more than 50% ice. Thus, large amounts of backfill were needed to replace the melted ice-lenses, but the gravel deposit was not large enough to supply gravel for both concrete and backfill. An attempt to cut into a local shale bank by scraping and thawing failed because the shale also contained large ice-lenses and disintegrated on exposure to air. Fortunately, a second gravel deposit was found some 30 miles upstream. Thus construction proceeded.

When the first river barges arrived, pneumatic hammers replaced picks and shovels and greater progress was made. Again the lack of proper site investigation posed more problems. The hard shale expected at 6 to 8 ft actually occurred at depths of 10, 12, and even 16 ft. Foundation piers had been designed to rest on 4 by 4 ft footings and holes were being excavated to this size. A man had to go down the hole to break out the material with a jack hammer, then load it into buckets for hoisting to the surface.

Delay in delivery of gravel for concrete presented another problem. The period of 24 hours of sunlight was approaching. Open pits in permafrost were becoming wells of water as the sun melted the ice-laden soil. Thus, holes had to be covered with plywood, and moss cover was added to retard melting.

As soon as gravel was delivered to the site, excavations were pumped dry, cleaned down to solid shale, and concrete footings and piers were poured without difficulty. Piers were designed to withstand frost-heave during refreezing of the gravel backfill. The piers were 12 in. square at the top and 18 in. square at the bottom. These foundations are satisfactory but expensive; much time was lost in placing them because of insufficient site investigation and lack of advance coordination of construction.

FORT SIMPSON

Both pile and poured concrete foundations were placed at Fort Simpson, an island settlement at the junction of the Liard and Mackenzie Rivers. Since the school and children's hostels proposed for Fort Simpson were planned during the construction of similar buildings at Inuvik, it was anticipated that the same type of wood pile foundations would be used. Site investigations, however, showed some frost-free and some frozen ground with no evidence of water accumulation in the test pits. The original mission hospital was built on a log mat in 1931; in 1952 an addition was built on a concrete foundation with full basement. No settlement occurred in either part of the building. Several other concrete basements in the area had remained trouble free, so the buildings were designed using concrete piers, spread footings, and partial basements.

Soil samples taken from the basement areas after excavation to the full depth showed ice-lenses at depths from 6 to 9 ft and permafrost in half the school excavation and most of one hostel, while the other hostel had been excavated in an area free of permafrost. The samples revealed that in some areas the soil contained ice-lenses and would not sustain the calculated foundation loads. The area relatively free of permafrost and ice-lenses had been cleared of brush and trees some years before, as was the case in all other areas where full basements had been built without difficulty. Areas where permafrost occurred had been cleared just prior to excavation.

The siting of buildings has been firmly established, the site was limited, and building materials were on hand to start construction. Thus, it was decided to build the buildings as planned but to redesign the foundations. Further test borings indicated a resistive hard stratum 20 ft below the basements; it was decided to drive piles to resistance in these areas. Some 2400 wood piles, 25 ft long, with 12 in. butts and 8 in. tips were driven in clusters; a continuous reinforced pile cap served as the footing for the foundation walls.

HAY RIVER

Hay River, on the southeast shore of Great Slave Lake, is on the fringe of the permafrost area and like Fort Simpson is also on an island. Many of the buildings have been built on wooden piles driven into place without need for drilling or

steam jetting. A new development, however, has recently gained favor in Hay River. A form of pipe pile, being used with great success for foundations, permits use of full basements. Steel pipes 6 in. in diameter are used. Well-drilling equipment is used to drive the pipe through the permafrost to bedrock at depths of 60 to 75 ft. The pipe lengths are welded together and filled with concrete as they are driven. Although its economics has not been studied in detail, this type of foundation is gaining in use at Hay River, which is connected by road to the Alberta oil fields where 6 in. pipe casing and well-drilling equipment are readily available.

HUDSON BAY AREA

A map of Canada shows that there are no settlements in the great barren regions east from Great Slave Lake except on the Arctic coast and the coast of Hudson Bay. Building foundations in permafrost areas of northern Manitoba are similar to other sporadic permafrost areas and are dictated by the presence and thickness of perennially frozen ground. Most buildings in territories north of Churchill on the shore of Hudson Bay have been built on concrete piers on gravel pads or solid rock, or on mud sills set in gravel pads.

FROBISHER BAY

When the new town of Frobisher Bay on Baffin Island was first proposed and the most probable site selected, extensive drilling was undertaken to select sites for specific buildings and the types of foundations best suited to the sites. The results of these tests, the varying depth of overburden, and a question as to whether the overburden was still moving toward the sea, led to the decision to build on solid rock.

The main part of the town was to be built on a plateau formed by blasting solid rock from the top of a hill. The hospital, power plant, and water treatment plant were to be built on a rocky hillside immediately north of the townsite. Rock cores indicated a medium- to coarse-grained granite with some fissures, fractures, and weathering, but with many of the fractured planes strongly cemented together. The high core recovery indicated that ice-lenses were unlikely. A check of previous excavations and several additional test pits all showed seepage immediately on top of the permafrost wherever surface soils existed.

The first building erected was the hospital which was situated partially on bedrock and partially on overburden 7 to 8 ft deep. No free ground water was found in the test pit in this area, but the sand and gravel of the overburden were judged to be susceptible to a ground water condition at certain times of the year. It was therefore recommended that concrete foundations be placed down to bedrock for the entire building. Seepage was expected through the rock faults, so provision was made to bring this seepage through heated weeping tiles to sumps inside the building and to dispose of it through the sewerage lines.

In general this plan is being carried out, but many adaptations to the original plan have had to be made as construction progresses. At the time of writing, the steel frame for the building was in place and concrete floor slabs were poured. The foundation problems, however, have still not been completely resolved. As the excavation proceeded, the solid rock was found to be much more weathered and faulty than anticipated, and the strata dipped from 30 to 60° in different areas of the excavation. Considerable seepage was noted in the excavation walls and in several foundation holes. Difficulty was encountered in obtaining any sort of level bearing for the footings. In several holes, what appeared to be solid rock turned out to be a thin layer of rock over several feet of sand. Eventually all the excavations were probed and deepened where necessary and all concrete footings were poured. Sumps were relocated and deepened and it is now felt they can handle the expected volume of seepage. Special precautions were taken by placing porous backfill covered with asphalt paving around the building to divert surface drainage from being added to subsoil seepage. The seepage problem is expected to be controlled by these precautions.

FORT CHIMO

At Fort Chimo, on Ungava Bay in northern Quebec, a simple refinement of the gravel pad is to be introduced in foundations for the new school. Permafrost at Fort Chimo is considered to be continuous, but there are pockets that appear to be frost-free where the soil is mainly well-drained sand. The active layer at the school site varies from 5 to 7 ft and it was agreed that the permafrost must be preserved. Both gravel and peat are found in the area; it is felt that by including a layer of peat between layers of gravel, a better insulating blanket can be introduced between the foundations and permafrost. The site will be leveled by cut and fill, and the peat and gravel pad will be placed and compacted as quickly thereafter as possible. Foundations will be concrete footings supporting a steel frame. It was expected this building would be started in summer 1963 and completed in 1964.

CONCLUSIONS

A study of foundations in permafrost areas tends to prove that it is impossible to generalize, to predict with certainty, or to assume. Anything can be built, in any soil condition, provided the soil condition is known and understood, and proper design precautions are taken. In dealing with permafrost we know that any disturbance of its natural surroundings will result in changes in the structure of the permafrost. We know that these changes will take place but we do not know with certainty the degree of change that will occur.

How much change takes place in permafrost when large buildings, several hundred feet in length, are built? How much does permafrost recede along the south wall which traps the sun's rays, and what is the rise under the building and along the north wall when the sun's rays are cut off permanently? When some action raises the level of permafrost so as to dam an established water course, where will the new water course appear, and will it damage the foundations of some other building? What happens when piles are dependent on refreezing and refreezing fails to occur?

Some authorities assume that there is no problem in dealing with solid rock, but can this assumption be accepted? What was believed to be solid, hard shale has disintegrated on exposure to air. Seemingly solid granite has broken down into weathered stone and coarse sand when thawed. It is not safe to assume that frozen rock will provide a trouble-free bearing for foundations. Design of foundations must continue to be based on the best available site information coupled with the knowledge that designs will probably be altered to suit on site conditions as these are disclosed.

There is no problem in designing foundations in permafrost areas. There is only the problem of realizing that permafrost exists in a wide variety of forms, and of understanding the particular variety with which you have to deal. This can be simplified only by more thorough site investigations prior to foundation design and by study of the reactions of the many types of foundations built in various types of permafrost in recent years. If this paper accomplishes nothing else, I hope it will underline the need for investigation, vigilance, and flexibility in dealing with foundations in permafrost areas.

ACKNOWLEDGMENTS

Most of the information reported has been collected from building contractors, project engineers, and others engaged in building activities at many sites in northern Canada. Some has been selected from consulting engineers' reports on site investigations. Most, however, has come from on-site inspections and discussions with fellow employees of the Department of Public Works to resolve the many unknowns that keep appearing in our northern construction programs.

Some of the people I am indebted to for assistance are J. A. Pihlainen, Ottawa, and the following co-workers from the Department of Public Works: A. E. Cook, R. Oancia, and C. A. Walrath of Edmonton; H. B. Dickens and R. G. Harding of Ottawa; and J. E. Kellett of Whitehorse, Y. T.

TUNNELING AND SUBSURFACE INSTALLATIONS IN PERMAFROST

GEORGE K. SWINZOW, U.S. Army Cold Regions Research and Engineering Laboratory

Mining and tunneling in permafrost is often done for industrial purposes. Bakakin describes methods of subsurface excavation in permafrost used in several coal and ore mines in the Russian Arctic [1, 2, 3].

There remains, however, a need for further knowledge of the principles and specific conditions affecting subsurface work in permafrost and for formulating criteria for applying mining methods.

For this purpose, the Snow, Ice, and Permafrost Research Establishment (now called the Cold Regions Research and Engineering Laboratory) undertook a full scale program of subsurface excavation in permafrost.

The fact that permafrost varies in temperature, moisture (ice) content, and lithology presented a problem in selecting the environment for the first experimental tunnel. The Thule area (Fig. 1) was selected because needed support was available, permafrost in the area is extremely cold and bouldery, and has a low moisture content.

Tunneling began in summer 1959 and ended in late August 1960. During this time, the period of operation consisted roughly of two 3 month seasons with two shifts a day.

All previous tunneling in permafrost was done for practical purposes only. There is no record of tunneling for research. The work described here pursued the tasks of: (1) Establishing a feasible method for subsurface excavation in the type of permafrost encountered, and (2) investigating physical properties of that type of permafrost.

THE ENVIRONMENT

Permafrost Lithology

The tunnel penetrates a heavy boulder till of characteristic

composition. The matrix is completely fresh, with no visible traces of oxidation. Dark gray and almost black colors prevail. Only igneous and metamorphic rocks are noticeable among the boulders: The first are basic and some ultra basic rocks, with syenite, granite, and granodiorite as exceptions. The metamorphics are black slate, some mica-schist, and a pink quartzite.

The till has two distinct stratigraphic horizons. Excavation beginning 530 ft from the portal revealed a buried land surface similar to that presently exposed. There was evidence of patterned ground, truncated by glacial erosion, boulders, and stream channels. Stream channels consisted either of large boulders, only loosely cemented by clean ice or sand lenses of very uniform mechanical composition. Both are characterized by almost complete absence of the clay size fraction. Till under the ancient surface appeared to be identical to that above it. No organic material was found during excavation.

Moisture Distribution

Moisture content of the active layer varies from zero at the surface (in dry weather) to a permanent 100% filling of the pore space at the top of the permafrost. Below the uppermost layer of permafrost, moisture content drops to a constant ice content of 6 to 10% or about 50% of the pore space. This remains the same regardless of the type of material. However, considering that about 92% of the moisture is retained in the pores of material finer than 149μ , the moisture distribution curve based on this fraction reflects the changes in lithology. Free macroscopic ice could be observed in voids of coarse bouldery material and as a thin layer below large boulders inclosed in till.

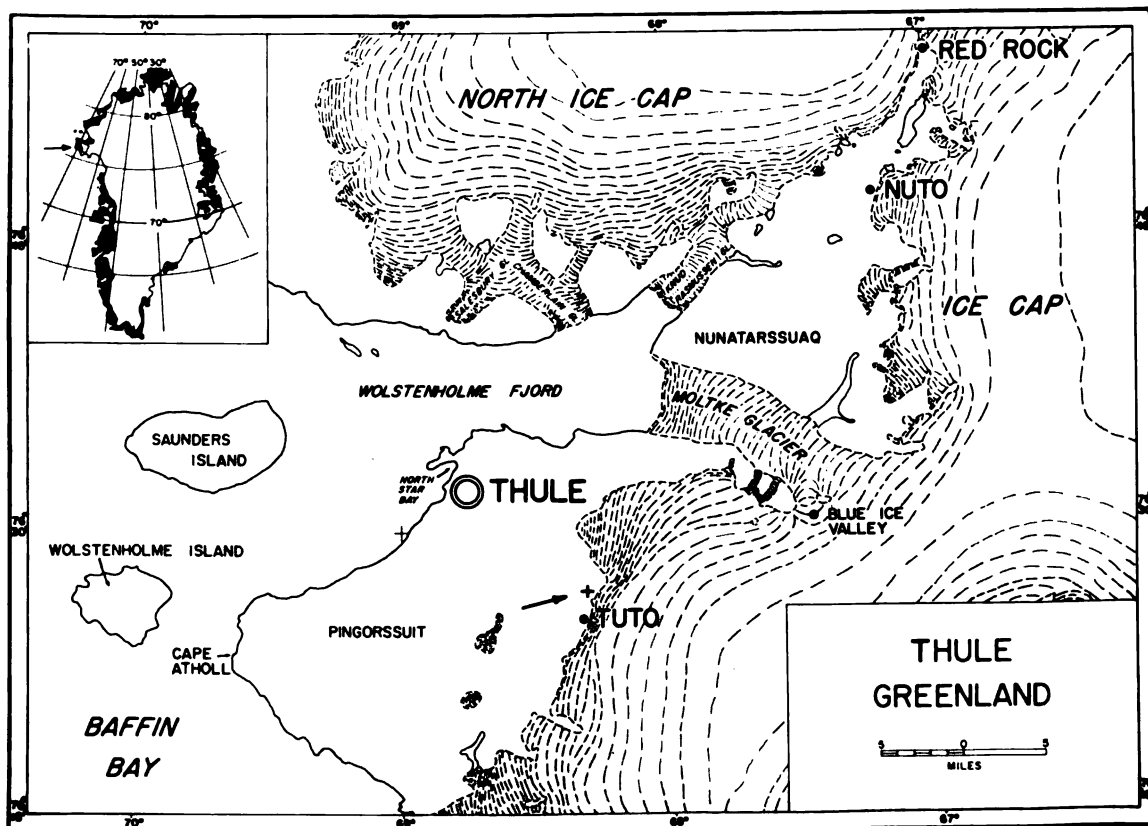

Fig. 1. Plus sign on map shows tunnel one mile north of Tuto and 1/8 mile west of the icecap

A more common phenomenon is exfoliation, manifested by ice filled cracks. Each such fissure is opened to a size from 0.8 to 1.0 cm and is filled with ice throughout its length.

Temperatures

The Thule area permafrost is probably one of the coldest in the world, having temperatures below the annual fluctuation layer that reach -13°C (9°F). The thickest overburden, at the far end of the tunnel, reaches roughly 100 ft. The first reliable data, obtained at a time when tunneling progress did not disturb natural conditions to a large degree, disclosed that the lowest temperature at the end of the arctic summer was at 190 ft (-13°C); at 600 ft a temperature of -10°C was observed. Recalculated to vertical distribution, the measurements constitute the following data: Thickness of active layer—1 to 5 ft (depending on the microclimate ice-wedges, etc.); depth to zero yearly changes—roughly 30 ft; thermal gradient below that layer—roughly 23 ft to 1°C . Subsequent observations indicate that the tunnel air temperatures equalizes at around -11°C .

THE TUNNELING OPERATION

Location

The tunnel is about 12 miles southeast of Thule, Greenland. It is on a ravine slope cutting through coarse boulder till cemented by ice.

The location allowed for horizontal tunneling without an access shaft and for easy disposal of mined debris. The whole area is modified by repeated glacial abrasion. The active layer in the area does not exceed 4 to 5 ft. The proximity of the icecap and northern exposure of the portal of the tunnel assured comparatively little melting and frost movement. This was a help in penetrating the active layer and entering the permafrost. At the site selected, melt water and slumping debris posed only minor difficulties. The road to the tunnel site and the excavated flat pad for surface installations proved to be stable, despite intensive use during the two consecutive seasons. Continuous daylight and comparatively mild temperatures during the summer facilitated a two shift operation during the field seasons.

Tunnel Configuration

The two seasons of excavating resulted in a 605 ft tunnel including three rooms off the main drift. The first room, to the left at the end of a 10 ft long adit, is separated from the main tunnel by a double bulkhead. The room (approximately 10 by 10 by 12 ft) was planned for long-range use in observing the heat properties of permafrost; thus, it is equipped with two mutually perpendicular semiprofiles of thermocouples and heaters which provide a heat source.

Beginning at the 300 ft mark, the tunnel has a 6 by 7 to 7 by 8 ft cross-section. At the 490 ft mark, another room (14 by 18 by 12 ft) was excavated. This room has a smooth, flat, permacrete floor, precast built-in furniture, and a foundation for a seismograph also cast from permacrete. This room was used as a general cold laboratory. From 545 to 605 ft, four cross-cuts to the right lead into a 60 by 50 by 6 ft room. The main drift is protected by three unequal pillars. The purpose of the room is twofold: (1) To investigate the possibility of excavating and maintaining a large opening suitable as a shelter, and (2) to observe long-range deformations over a wide span.

The phenomena of roof stabilization, exfoliation of overloaded pillars, and change of overburden pressure will also be a subject of long-range study.

Summary of Operation

For excavation, the conventional hard-rock tunneling method was modified slightly to meet the low-temperature requirements. The mining cycle consisted of the four routine elements: Drilling, blasting, ventilating, and mucking (removal of debris). Drillability of frozen boulder till, instrument wear, and machine performance on a two-track large opening, were

studied and reported on by Abel [4]. On the basis of his findings, the functions of the four-cycle components were investigated further during the 1960 field season.

Drilling time for one cycle required about 40 min; an extra 20 min was needed when large gneissic boulders had to be penetrated. The drilling fluid (originally gravity fed from the surface) consisted of slightly diluted antifreeze. Significant dilution resulted in line freezeup over night. Later weak solutions of antifreeze (one volume of isopropyl alcohol to 25 volumes of water) were delivered to the drills from a mobile pressurized tank brought into the tunnel shortly before drilling time.

The mucking operation lasted from one to three hours, averaging about seven minutes a car. A normal shift consisted of mucking followed by drilling, then blasting, and would be repeated to form two complete cycles. The two ventilating times fell on the lunch hour and shift change. A typical one-shift day would result in 8 ft of 6.5 by 7.5 ft tunnel. The rate of progress decreased during crosscutting, room excavation, and other nonroutine jobs. The final average productivity of a two-cycle shift came to 5.37 ft of tunnel, or 9.7 cu yd of excavated material.

The seven men per shift employed at the site qualified as follows: One shift boss, one explosives man, one generator and compressor operator, two drillers, one mucker, and one mucker helper. When a particular step in the cycle was in progress, the men in charge conducted the operation with the rest of the crew as helpers.

Attempts to strengthen the crew by adding men did not increase productivity during regular tunneling. The efficiency of tunneling in permafrost may, however, be slightly increased by working four crews on four 6 hour shifts around the clock. Such an operation may be more productive and is recommended in situations where speed is more important than cost.

There was a total of 109 productive shifts with 19 maintenance and construction shifts. Only three shifts were lost due to bad weather. More shifts would have been lost if the work was done at the surface; once begun, tunneling in permafrost is not affected by weather.

The total permafrost excavated was 1056 cu yd in place. Each mine car was filled with an average of 20 cu ft. The excavated material was trammed in 2420 mine cars, which indicates an expansion factor of 1.8. Total footage drilled was 15,245 ft, or an average of 14.43 ft cu yd of permafrost in place.

The 18 in. light mining track system used for tramping was found suitable for the 6.5 by 7.5 ft tunnel.

The operation, conducted on a single track, did not require any turnouts or car transfer operation. Side spurs to the rooms in the tunnel assured an operation without an excess of track work.

Under the given conditions, the Type Z (Denver Equipment Co.) 24 cu ft ore car was found most satisfactory.

The ore cars were hauled by a Mancha storage battery locomotive. Hand-tramping occurred only for a short time at the start of operations. With longer distances, machine-tramping proved to be more efficient.

Mucking was accomplished with an Eimco Model 12b Rocker Shovel (Eimco Corporation, Salt Lake City, Utah). This proved to be a reliable machine, requiring a minimum of maintenance.

The CP-ISL-459 Air Leg Drills (Chicago Pneumatic Tool Company, New York, N.Y.) performed well under the specific conditions.

The compressed air supply was affected by the cold environment. Ice deposited by air entering the subsurface pressure lines occupied as much as 75% of the cross section along the entire length of the pipe. The procedure suggested by Weber (1959) of spraying antifreeze into the pipeline proved to be impractical: The diluted solution accumulates in the lower parts of the pipe and refreezes. The most economical, although radical, solution was to remove the complete pipe system, melt the ice out, and then re-install the pipes; six men could finish such a job in one shift. Under similar conditions, de-icing should be repeated every three to four weeks.

All power needs (including subsurface operations, surface maintenance, battery recharge, etc.) were satisfied by from 30 to 40 kw of AC current and by 300 cu ft/min of 100 psi surface pressurized air.

Miscellaneous Uses of Freezing

In the usual mining procedure, some effort is always needed to lay rails and switches on a flat, stable bed. Additional work for maintenance of the rail system is always required. A permafrost environment simplifies this to a minimum. Railwork laid out on a flat layer of comparatively fine material becomes permanently bonded to the bed and very stable if some moisture is added after the layout is completed. The need for ties is minimized and maintenance is reduced to a negligible amount. Although it is not proven, it is strongly suspected that the useful life of rail systems in permafrost environments becomes almost unlimited. Similar uses of the freezing environment are made in many cases where backfill was needed to prop up equipment, make foundations for machines, etc.

BLASTING AND EXPLOSIVES

Types of Explosives

The selection of appropriate explosives for hard-rock tunneling makes the difference between success and failure. Since there is virtually no record of application of explosives to the particular type of permafrost encountered, nine varieties were used during the 1960 excavation season. Normal production would not tolerate such a variety in strength, velocity, and sensitivity, but it was necessary to find the most suitable explosive for the particular type of permafrost. The explosives used can be roughly divided into three groups: (1) High strength and velocity, (2) medium strength and velocity, and (3) low strength and velocity.

Group 1 included 100% strength Gelatine (Hercules) and malleable Military Demolition Block C-4 (26,379 ft/sec). Group 2 consisted of a variety of explosives including 65% Gelatine (Gelatite 1-X, Hercules), Gelatine Extra 60%, Nitro-Glycerine 60% (Herkomite), and the Military explosive M-1. Group 3 was also of great variety including Nitro-Glycerine 50%, Gelatine Extra 30%, and a 40% Gelatine (DuPont). This division was for the experimenter's use and is not proposed as a standard classification. Generally, for proper understanding of explosive action on the excavating medium, three properties must be considered: Strength, velocity, and brisance. Strength may be defined as volumetric ratio of the explosive to its gaseous product; velocity may be the reaction time (duration of explosion in a given charge), but it is also defined as propagation time of an explosion along the charge; brisance is a measure of time elapsed from the start to maximum force developed. Usually, strength and velocity increase proportionally; brisance depends greatly on the shape, density, and mode of application of a charge.

Results of Observations

The explosives were used under a variety of conditions, such as different stemming, priming, and depth of hole. In addition to the usual safety and stability requirements, the nature of the environment demanded that: (1) Material should be insensitive to low temperature; and (2) it should be insensitive to pressures since wet stemming may freeze back rapidly and exert pressure on the charge.

High-velocity explosives were found to be excellent in their shattering action and were ideal for fracturing large boulders. However, their over-all performance was inferior due to their very limited heaving action. There was also a tendency to blow the stemming. Sensitivity of high-velocity explosives was another item of concern; generally, the higher the strength and velocity, the more the sensitivity drop under the influence of low temperature. For example, Military C-4 explosive became so insensitive that it could be set off only if used with heavy booster charges of high-velocity, Nitro-Glycerine dynamite. High-strength, high-velocity explosives could be used

only when the time between loading and firing was so short that the charge did not cool down notably (e.g., for small jobs of reblasting or safety explosions).

Low-strength, low-velocity explosives required large-diameter holes, cartridges and large charges. This resulted in excessive drilling. The only successful result was obtained by simultaneous setoff of charges of the whole face, since there was the dangerous tendency of charge cutoff.

Contrary to Anderson's recommendations [5], our experiments demonstrated that, medium-velocity, medium-strength explosives produced the best results. Two experimental rounds were fired with high-power, high-velocity explosives in the central holes and medium-velocity powders in the rest of the drill holes (see Figs. 2 and 3a, b). Despite some excessive spread of the muck pile, satisfactory results were obtained.

The usual delay of the fire round (Fig. 2) is applicable only for normal half-second delay caps. The use of millisecond delays was unsuccessful in two respects: (1) Fragmentation was too irregular; and (2) the muck was too highly spread, since, while still in the air, material liberated by the first blast was pushed down the drifts by subsequent explosions. Moreover, several cases of sympathetic explosions were observed while using millisecond delay caps. The cause is obscure. Perhaps the caps became more sensitive or an interference of two or more compression waves set the remaining charges off. In any case, more experimentation is needed before millisecond-delay caps can be successfully applied in permafrost.

Powder Ratio

The powder ratio, as understood here, is the relation of amount of explosive used (in lb) to volume (cu yd) of in-place rock removed. It is influenced by the particular set of conditions (such as lithology, type of work, etc.). Thus, the powder ratio is a highly variable factor. It is also affected by the position of the charge in the hole, manner of priming, stemming, etc. In addition, special conditions are encountered in permafrost: Its low temperature and apparent elasticity (e.g., its resistance to shock of very short duration) decreases the efficiency of the explosion. Brisance is of only moderate value, since any force applied to disintegrate a frozen heterogeneous material should be applied to its weaker portion, the ice bond, rather than to solid boulders.

The advantage of a narrow cone while using high-velocity explosives is that it minimizes cutoff of adjacent charges. However, high-velocity explosives shatter larger boulders, rather than only the matrix; thus, the over-all result is a poor

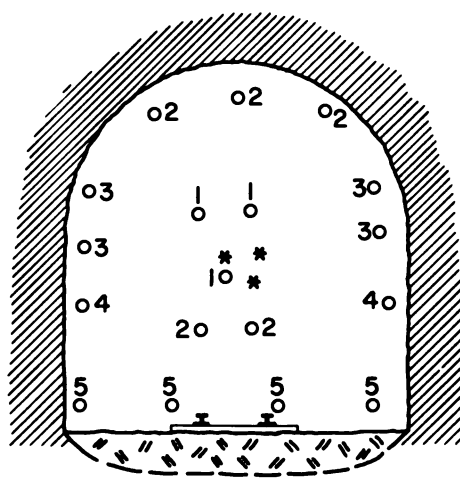

Fig. 2. Tunnel cross section shows the 18 charged holes; numbers indicate firing order; asterisk indicates relief holes; high velocity explosives (indicated by 1) are recommended for use in the burn

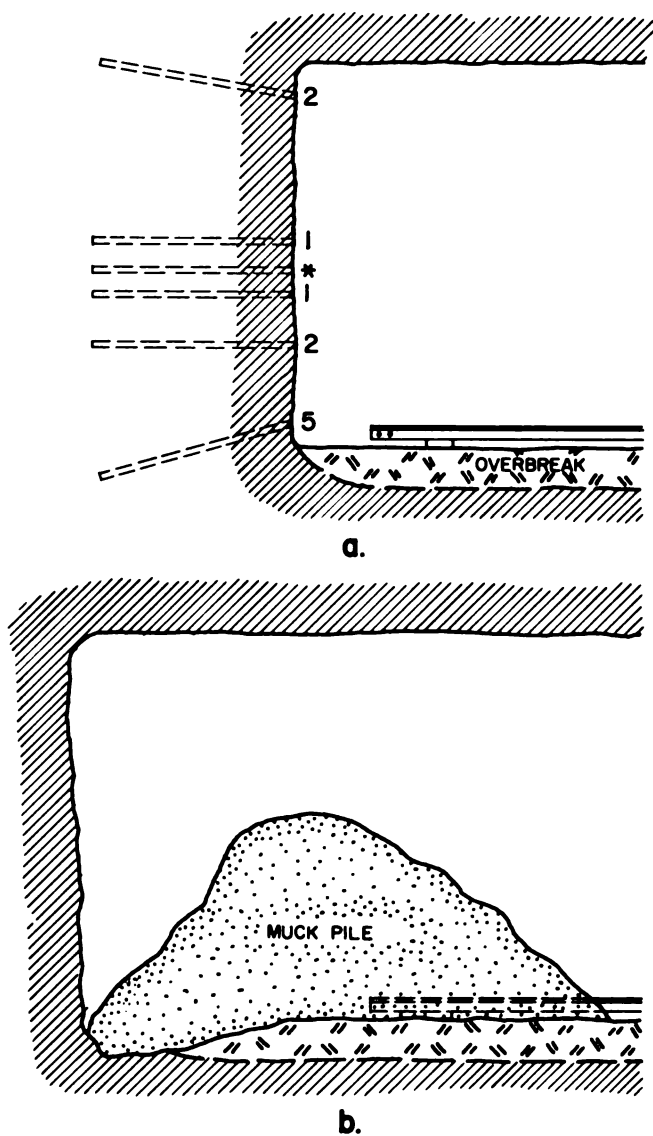

Fig. 3. Delays 3 and 4 not seen in cross section: a. Longitudinal section of drill pattern; b. Action of one round

powder ratio. There is also a tendency to blow the hole to as much as 75% of its length.

By using medium-velocity, medium-strength explosives, the powder ratio could be brought to a minimum value of 3.1 lb/cu yd of permafrost.

Table I shows the results of powder ratio investigation and the influencing circumstances. The table presents a selection of typical cases at various stages of work.

The first case is the conventional application of the explosives with moderate stemming. Each round is two 4 lb blocks of explosive primed at its middle. The table is based on experimental rounds of the same drill pattern. Rock conditions are comparable and so is overburden pressure. The same scheme of normal delay pattern was used.

Data summarized in Table I indicate some success in the improved application of explosives. Despite the fact that explosives are the cheapest source of energy, excessive use of them would present a pitfall in excavation costs, especially under arctic conditions where transportation expense may become prohibitive.

Stemming

Under identical circumstances, stemming becomes a deciding factor in rational use of explosives. A cold environment such

Table I. Powder ratio (blasting of permafrost under convenient use of explosives, 1960 field season)

Date	Type of explosive	Explosive in round (lb)	Powder ratio	Remark on pile	Fragmen-tation	General remarks
10 Jun	Hercules Gel 100%	70	9.7	Spread	Satisfactory	No stemming used
12	Gelamite 1-X 65%	60	8.3	Compact	"	Regular stemming
13	"	120	8.2	Spread	Poor	No stemming used
16	"	63	8.8	"	Very poor	Stemming w/sandy clay
16	"	35	5.6	Extremely compact	Extremely poor	Pile in contact with face
20	"	50	6.9	Compact	Satisfactory	Clay stemming
24	Hercomite 7-X 60%	126	17.5	Spread	Extremely fine	Poor fumes, decomposed explosive
25	"	139	9.6	Compact	Satisfactory	Unskillful loading, loose tamping
26	"	66	9.2	"	Poor	"
13 Jul	M-1 med vel	34	4.7	Satisfactory	Poor	Heavy boulders, delayed blast, fumes
15	Hercules Gel 100%	85	5.9	Spread	Fine	Heavy boulders
19	"	67	4.7	"	"	Heavy boulders
19	"	105	7.3	Satisfactory	Poor/fine	5 cu yd diabase boulder
20	"	42	3.0	"	Satisfactory	Tightly stemmed
20	M-1 med vel	32	4.4	Satisfactory	Satisfactory	Tightly stemmed, some fumes
25	"	36	3.9	"	"	Tightly stemmed, boulder
27	"	32	3.9	"	"	"
28	"	31	3.5	"	"	"
4 Aug	"	30	3.3	"	"	"
6	"	27.5	3.1	"	"	"
	"	27.5	3.1	"	Poor	"
10	DuPont 40% Dynamite	40	3.4	"	Medium	"
17	"	48	3.3	"	"	"

Satisfactory: No fragments larger than 1 cu ft; Unsatisfactory: Fragments of 1 cu ft or larger are noticed. Mucking presents difficulties

as the Tuto permafrost tunnel (-10° to -13°C) presents an excellent opportunity to use a method which could seldom be used otherwise; mud, wet tamped, would adfreeze solidly to the drill hole. It was found that by tamping with freezing

material (0°C) the time for the hole to freeze solidly was as short as 15 min. By experimenting, it was found that a mixture of silt and clay adfreezes better and locks the hole tighter than convenient clay stemming which always remains plastic and only serves to plug the drill hole. The favorable powder ratio which was reached near the end of the season is attributed, in part, to refreezing of the stemming.

One explanation of the high powder consumption during the 1959 season, as well as the beginning of the 1960 season is that there are indications of initial shots in the round cutting off parts of explosive charges in the subsequent holes.

VENTILATION AND AIR FLOW

Natural Air Flow and Its Modification

Natural air flow in the tunnel during the summer is fairly simple to demonstrate. Warmer outdoor air enters the tunnel through the portal and moves slowly inward depositing hoar frost on its walls. The dry, cold, dense air moves along the floor of the tunnel forming a layer 1.5 ft high. That layer is easily recognizable by the absence of hoar frost on the lower part of the tunnel wall (Fig. 4a).

An explosion at the end of the tunnel instantly liberates a large amount of hot fumes and offsets the natural circulation, thus forming dangerous stagnant fume pockets (Fig. 4b). Forced ventilation applied at two points which act parallel with natural convection currents was most effective (see Fig. 4c).

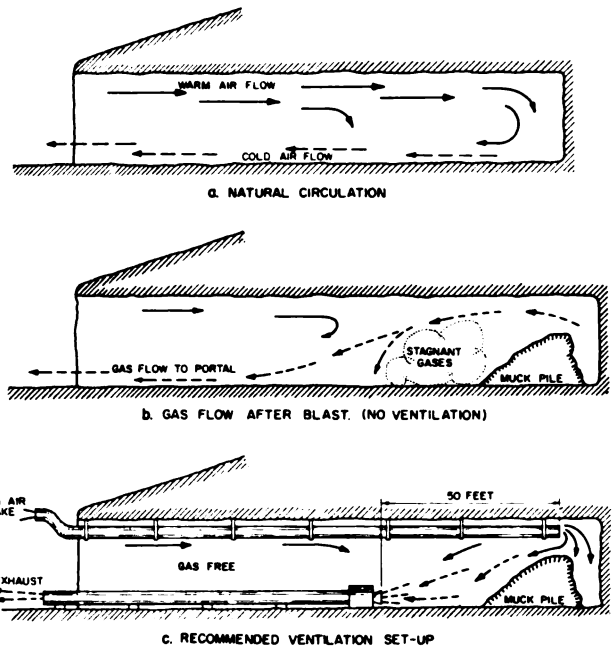

Fig. 4. Summer ventilation in a cold permafrost tunnel

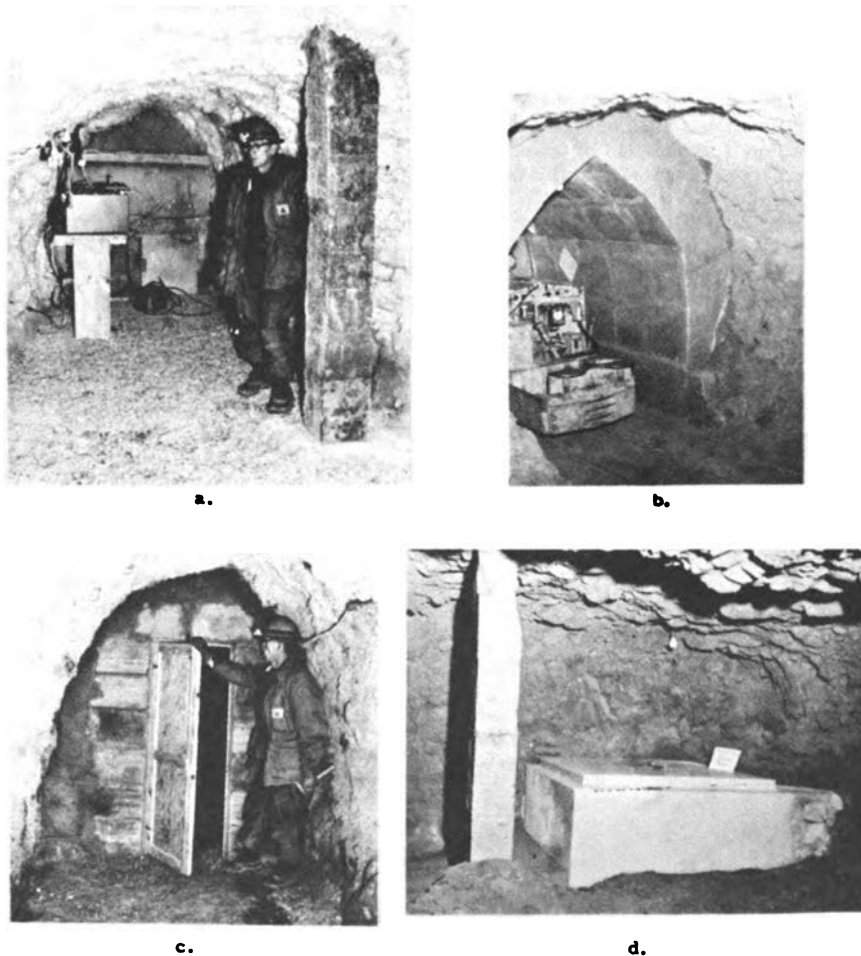

Fig. 5. Application of artificial frozen soil mixtures: a. Column supporting a loose roof slab; b. tunnel section protected by a combination of poured permacrete and pre-cast bricks; c. bulkhead made of large precast bricks; d. diesel fuel storage pit poured in place and lined with fine grain frozen material. Finish: Clay slurry applied with paint brush

With this arrangement, ventilation time was cut down to 15 min, as compared to as long as 65 min using reversed fans.

Effective fan capacity was found to be 1000 cu ft/min in both directions. This figure is based on use of a Joy-Axivane exhaust fan (7.5 hp, 3500 cu ft/min at 4 in. water pressure differential) connected with a canvas flexible ventilation pipe of 24 in. dia. and of a 3.5 hp fan of correspondingly lower capacity on a rigid ventilation pipe carrying in fresh air. (The difference between the estimated and nominal fan capacity was due to line loss along the 550 ft. It was abnormally high due to hoar frost forming in the line.)

PERMACRETE INVESTIGATIONS

Environmental Requirements

Early in the work, the low temperature of the environment was thought to hinder tunneling operations, but very soon temperatures prevailing in the tunnel (between -10° and -13°C) were found to have more advantages than disadvantages. When properly clothed and fed, men could stand 10 and 12 hour shifts without any appearance of fatigue, exposure, sickness, or frostbite. It was found also that low temperature may be utilized for increased safety; cases of unsafe fractured roofs were corrected instantaneously by spraying with water and later with a mud slurry.

When large slabs in the roof became "drummy," they were propped up with columns molded from frozen artificial concrete-like soil mixtures (Fig. 5a). In all cases where applicable, this was safer and better than reblasting to bring the roof down. One section of the tunnel, consisting essentially of large boulders cemented by ice, was lined with bricks made of fine-grained, frozen material (Fig. 5b). Because of the ease of application and comparatively high strength, this approach was used widely for modifications and improvement of the tunnel (e.g., see the bulkhead for a small research laboratory shown in Fig. 5c). For this reason, and because of the difficulties of curing ordinary concrete at low temperatures, the study of permacrete was initiated.

The term "permacrete" is used to describe artificial concrete-like mixtures of soil materials, which, when cemented by ice forming in their pores, form a consolidated aggregate useful as a construction material in cold regions. The result of laboratory and field investigations of permacrete is summarized.

Summary of Permacrete Studies

A detailed account on preliminary work in permacrete during the excavation period was given by Swinow [6]. Subsequent laboratory and field investigations were performed to determine physical properties of the material. Laboratory work was set out to exclude as many unknown variables as possible. Physical properties of a frozen aggregate may vary because of:

- (1) Temperature, (2) moisture or ice content, and (3) mechanical

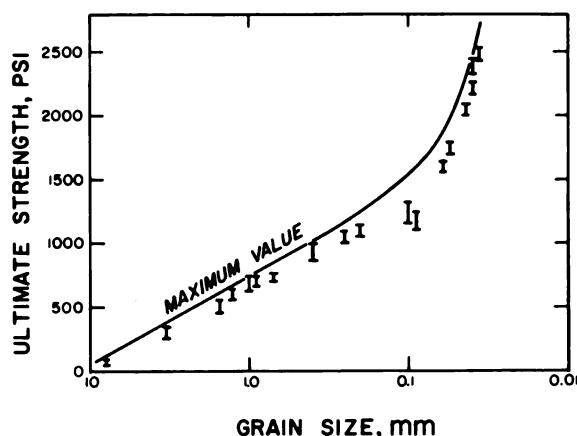

Fig. 6. Relationship is shown on logarithmic scale; all tests at $-5^{\circ} \pm 0.1$

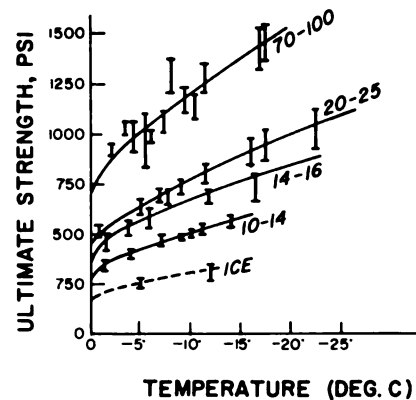

Fig. 7. Relationship of various sieve sizes (U.S. Standard); data (omitted between 0 and -1°C) in negative degrees

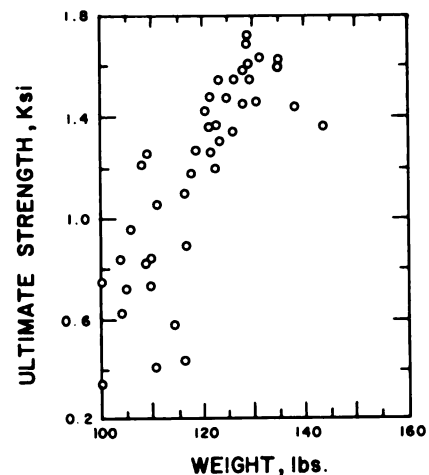

Fig. 8. Relationship between ultimate strength and specimen weight

composition of the soil. A few experiments at the beginning of the laboratory program showed that all tests on materials should be made at saturation. Moisture content thus became a function of porosity. All subsequent experiments were performed with saturated specimens only. Laboratory work was limited, therefore, to investigation of the relation of direct flexural strength to grain size and temperature. A nominal size was that of unconsolidated soils material mass (sand, silt, etc.), which was found between the two adjacent U.S. Standard Sieves after a standard time of sieving (10 min) by means of a mechanical vibrator. Test temperatures were held to a precision closer than $\pm 0.1^{\circ}\text{C}$. Mixtures of various grain sizes were not investigated in the laboratory. Laboratory results are summarized in Figs. 6 and 7. Field investigations were conducted under conditions as close as possible to those under which construction would be performed.

Specimen cylinders of local sand, gravel, and crushed rock were tested with standard concrete testing equipment (located in room areas of the experimental permafrost tunnel). In all cases the material could be treated exactly like concrete, except that it needs no curing time once solidified; the material must be kept below the freezing temperature (which is possible throughout the Arctic); and it can be rewarmed and reused. Some compressive strength data appears in Fig. 8.

The most dense packing principle of composition assured adequate strength. Since weight is proportional to dry density of a concrete-like mixture, heavier specimens (with the same mineralogical composition) showed higher compressive strength.

Highest ultimate strengths under standard conditions of

loading, temperature, freezing history, and moisture content were found among the finest materials. But together with increased ultimate strength, an increase of creep was observed. It was decided, therefore, to investigate two main requirements: (1) The need to know why ultimate strength increases while particle size in the aggregate is decreasing; and (2) the need to find methods of counteracting excessive creep. The first problem was solved in the laboratory. It was found that the ice grown in large pores is polycrystalline with a magnitude of optically resolvable imperfections, but that ice in narrow pores is monocrystalline with a high degree of optical perfection. Presence of crystallographic imperfections appears to decrease the ultimate strength of ice; small crystals appear to grow to a higher degree of perfection.

Increase of creep and plasticity is apparently due to a greater amount of unfrozen water in the pores as their size decreases. If coarse-grained material has a low strength but also displays less creep (which was actually observed), a natural way to make an improved material is to mix coarse and fine material. Still in the laboratory stage, it was realized that addition of small amounts of fine material to a coarse matrix or vice versa only complicates the process: Coarse particles, completely surrounded by a fine matrix, acted as stress-concentrating agents. Fine material filling in pores of coarse aggregate only slightly improves its mechanical properties. It was realized at that stage that the problem consisted in the need to keep the coarse material in contact and, at the same time, to eliminate large pores so that the ice cement will consist only of small crystals.

One way to achieve this is to mix various sizes of materials into a densely-packed aggregate. To explain further: If a uniformly coarse material does have a porosity of 40% (as is usually the case) and a relative bulk density of 0.6, one unit volume may be mixed with 0.4 unit volume of a finer material provided the particles of the second ingredient are small enough to be accommodated in the pores. The resulting density of the mixture will be more than 0.8, and porosity will fall to less than 20%. That mixture mixed with an even finer material renders a further loss of porosity. Figs. 8 and 9 summarize the relation of density to strength and the process of composition of a dense mixture. It is emphasized that:

- (1) A dense mixture eliminates large pores filled with ice;
- (2) it also eliminates pockets of ice and fine frozen material, thus eliminating excessive creep characteristics for the two materials;
- (3) theoretically, the addition of even finer ingredients to a dense mixture will bring it to a point where the moisture is disseminated in such fine pores that it will not freeze at practicable temperatures; and
- (4) although increase of strength was observed to a fourth and fifth ingredient, the

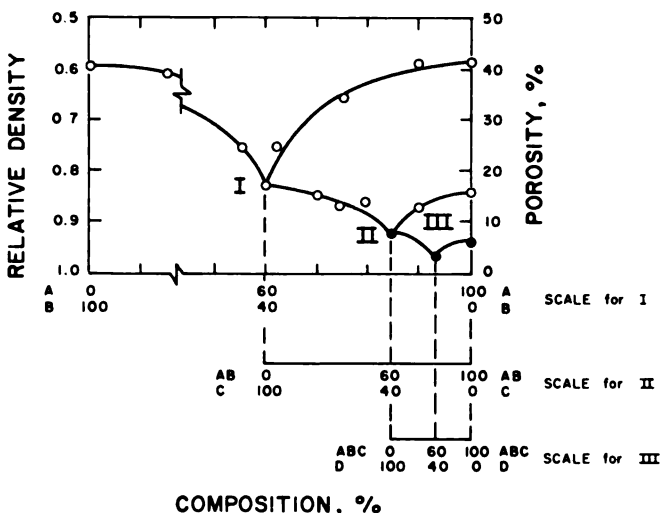

Fig. 9. Schematic graph shows the determination of a dense mixture with low creep properties: "A" Coarse uniform material of arbitrary size; "B" Material fitting into pores of "A"; "C" Material fitting into pores of "B"

limit had not been reached. The number of components constituting a dense mixture is predetermined by the size of the most coarse ingredient; if the part to be cast is large enough, coarse material can be used to start. It was concluded that for compression, a ratio of 1 to 100 of the material size to the cross section is optimal. For shear and flexure, a ratio of 1 to 200 would be better. The computations and results of experiments are given in detail by Swinzow [7].

In conclusion, permacrete may be used in a great variety of endeavors in cold environments (such as shown in Fig. 5). Artificially frozen ground has been used to a very large extent in the past. Large-scale construction has been accomplished using refrigeration, natural air cooling, or both. The feasibility and success of such construction is beyond doubt [8, 9].

Future research should concentrate on further investigations of the physical properties of permacrete and on formulating technical criteria for application of freezing methods, preservation in the frozen state, and limitations of use.

CONCLUSION

Tunneling Techniques

Cold, bouldery permafrost of the type described is characteristic of good roof conditions. Greater ice content would undoubtedly result in greater roof stability, but the powder ratio would be less favorable. The modified hard-rock tunneling technique described is the most advantageous method in the environment. Any other method would be less successful. The best drilling pattern for advancing in permafrost of the type described was found to be a pattern where high-velocity explosives are used in the burn (centrally located holes, labeled "1" in Fig. 2). The depth of drilling on a tunnel face should not exceed two-thirds of its width. The use of medium power and velocity explosives is advantageous since the blast energy tends to disintegrate the matrix rather than to shatter the boulders. The same should hold for working of conglomerates or conglomeratic ores with a comparative strength relation. Best results with stemming are obtained if it is allowed to freeze, sealing the hole completely. Advantages of low subsurface temperatures far outweigh disadvantages.

Permacrete

The use of this material in permafrost tunneling and mining has advantages over concrete and timbering. The material can be used for roof stabilization and direct subsurface construction. Inexpensive, safe, and strong fuel storage containers can be constructed in almost any permafrost environment (not only in tunnels). The best strength is obtained with dense permacrete mixed under the outlined conditions ("well-graded" mixtures creep too much).

Mining Engineers' Classification of Permafrost

The classification suggested in Table II is intended to help the mining engineer who encounters the problem of evaluating a mining or tunneling area. In this case, the proposed area should be compared with another area where both the permafrost properties and the excavation efforts are known. For

Table II. Mining engineers' classification of permafrost,^a (Prediction of mining conditions in a new area)

Temp.	Ice content	Mech. comp.	Remarks
Cold ^b	Dry ^b	Coarse ^b	Low powder consumption
	Dry ^b	Fine	Very low powder consumption
	Saturated	Coarse	Stable roof
	Saturated	Fine	Stable roof
Warm	Dry	Coarse	Dangerous roof
	Dry	Fine	Unstable roof
	Saturated	Coarse	Need refrigeration
	Saturated	Fine	Need refrigeration

^aComparing with more than one area increases accuracy
^bTuto permafrost

precise comparison of two environments, data in Table II can be expanded to any desired extent. For example, permafrost may be not only cold or warm, but it may be precisely 9°F as in Tuto, 31°F as in Fairbanks, or 20°F in another location. The latter figure would be "cold" if compared with Fairbanks, but "warm" if compared with Tuto.

The other two properties may be treated analogously. In this classification a cold, saturated, fine-grained permafrost poses least roof stability problems, but is tougher to excavate. A warm, dry, coarse permafrost poses grave difficulties in roof stability. A fair prediction of mining difficulties to be encountered can be obtained by evaluating a prospective excavation site along the lines suggested.

REFERENCES

- [1] V. P. Bakakin. "Metody povisheniya ratsionalnosti gornogo deia v usloviakh vechnoi merzloty," unpublished data, V. A. Obruchev Permafrost Institute, Moscow, 1954.
- [2] V. P. Bakakin. "Prokhodka i ekspluatatsia shakhtnykh stvolov v Petshorskome ugolnom basseine," Materialy k osnovam uchenia o merzlykh zonakh zemnoi kory, Vol. 4, Moscow, 1958, pp. 195-215.
- [3] V. P. Bakakin. Osnovy vedenia gornykh rabot v usloviakh vechnoi merzloty, Gosud. N. T. izdat. literatury po cherno i tsvetnoi metallurgii, Moscow, 1958.
- [4] J. F. Abel. "Permafrost Tunnel, Camp Tuto, Greenland," U.S. Army SIPRE, Hanover, N.H., Tech. Rept. 73, 1961.
- [5] L. G. Anderson, P. R. Moyer. "Blasting in Surface and Drift Operations in the Far North," The Dynamic North, U.S. Army SIPRE files, Book 2, Chap. 4, 1956.
- [6] G. K. Swinzow. "Tunneling in Permafrost," U.S. Army CRREL, Hanover, N.H., CRREL Tech. Rept. 93, 1963, pp. 14-27.
- [7] G. K. Swinzow. "Preliminary Investigations in Permafrost," CRREL Tech. Rept. 92, 1963, pp. 3-27.
- [8] A. M. Chekotillo. Primenenie snega, l'da i merzlogo grunta v fortifikatsii, Voennoe izdatelstvo narodnogo komissariata obrony, Moscow, 1943.
- [9] A. M. Chekotillo. Primenenie snega l'da i merzlykh gruntov v stroitelnykh tselakh, Izdatelstvo Acad. Sci. USSR, Moscow, 1945.

ICINGS ON THE ALASKA HIGHWAY

S. THOMSON, University of Alberta, Edmonton

A problem unique to winter road maintenance in northern latitudes occurs when successive layers of ice encroach on the roadway. Such ice encroachments create a serious driving hazard (Fig. 1). Ice layers are formed by cumulative freezing of water that originates as ground seepage or from a spring, stream, or river. These encroachments are called "icings" by Muller [1]. He defines an icing as "a mass of surface ice formed during the winter by successive freezing of sheets of water that may seep from the ground, from a river or from a spring." Locally, on the Northwest Highway System (NWHs, Canadian portion of the Alaska Highway), icings are often called "glaciers," but this term should be discouraged for obvious reasons.

This paper is based on the author's experience as the Soils Engineer, Northwest Highway Maintenance Establishment, Canadian Army. The icings described here are those that posed a maintenance problem from about Mile 200 to the Alaskan-Yukon border on the Canadian link of the Alaska Highway, a distance of some 1000 miles.

GENERAL DESCRIPTION

Ice thickness is built up by freezing of thin films of water. As one layer of water freezes, another flows over it and, in turn, freezes. A succession of such layers advances the icing front and increases its thickness. Air temperature and ground slope initially, and later ice surface slope, as well as local topography appear to control the icing rate and manner of growth for a given water supply.

icings tend to spread laterally; but in stream valleys or gullies, lateral growth is restricted and growth is predominantly vertical. Thickening continues until ice spills over stream banks or artificial dikes erected to control or direct ice build-up. Where water feeding the icing issues from a steep bank, an ice slab forms on the face. As winter progresses, horizontal thickening occurs fastest at the foot of the slope.

The gently undulating surface of an icing is occasionally interrupted by humps or mounds. The mounds are generally elliptical in shape; one observed was in the order of 30 ft long by 15 ft wide by 5 ft high. Most icing mounds observed on NWHs are smaller, but they may be many times the size noted [1].

These mounds are believed to be formed by hydrostatic pressure in water which accumulates under the ice and forces



Fig. 1. Encroachment of ice on the road

the surface upward. Most mounds have a tension crack along the top and much water often flows from the crack until water pressure is dissipated. On rare occasions the ice is strong enough to resist cracking until sufficient pressure is built up in the water to cause a sudden, violent rupture. In one instance, cakes of ice roughly 5 ft by 10 ft by 10 in. thick were carried for distances of several tens of feet by the sudden release of water. At one icing site, three such blocks were found close to one another on the road surface. Fortunately, the first vehicle to encounter them was a highway maintenance truck, and they were removed before causing an accident.

icings appear to become more active with colder weather. Water has been observed on the ice surface at air temperatures well below freezing. An amazingly small volume of water from seepage can create a large icing; for example, a simple calculation shows that a flow of seven gal/min will cover about an acre to a depth of one ft in a month.

Streams and large rivers can also provide water for producing large masses of ice that may build up vertically or



Fig. 2. Summer picture of a small stream



Fig. 3. Ice formed on the stream shown in Fig. 2

spread out laterally over a large area. In one instance a small stream in a deep, narrow gully built up ice to a thickness of eight ft in six days (Figs. 2 and 3). The ice lifted the timber deck of a small bridge several inches off the road bearers. Recently, a large river inundated part of a town with two to three ft of ice, forcing several families to vacate their homes.

The area affected by an icing varies with local topography and may be long and narrow, ranging in length from a few feet to a mile or so. Ice spreads over flat topography to cover areas of one or two square miles, particularly if the ice from several seepage areas coalesce. Some icings may be discrete and cover a relatively small area, a few tens of feet square. Thus, the road area affected may range from a few feet to a mile or so.

MAINTENANCE PROBLEMS

Maintenance problems arising from icings fall into two broad categories: (a) The hazard to driving and (b) damage to the road. Ice encroaches on the road and in some cases renders the road impassable. The ice surface is slippery, especially if a film of water exists; it is hummocky and rough to drive over; and usually has a slope transverse to the road. If sufficient water is present, it splashes the underside of the vehicle where it immediately freezes, often with the result that the brakes freeze and cannot be applied. The problem becomes one of preventing ice from encroaching on the road or of removing it.

Road damage may take two forms: (a) Distortion of small bridges and culverts by the ice, and (b) damage caused in the spring when melting ice water soaks into the road's substructure. Water softens the surface and creates mud patches on gravel roads. Ice may clog culverts almost completely and, since ice in the culvert is protected from the sun, it lasts longer. Melt water from ice and snow that cannot drain collects in ditches thus causing further trouble. If icing forms on slopes comprised of silts, spring melt water greatly aids in solifluction with consequent filling of ditches.

TYPES OF ICINGS

Three classifications of icings are used in this report based on the origin of their water supply: (a) Icings resulting from water of rivers and streams, (b) icings resulting from seepage forced to the surface by underlying impermeable strata which may be permafrost, and (c) icings resulting from perennial seepage that issues from the ground or a side hill.

Except for the first classification, a visit to the site during summer may be necessary to classify the situation.

The category including streams and rivers is easily identified. These icings usually affect only a short stretch of road near the stream. In late fall, an ice layer forms on top of the stream, but below this ice cover the stream continues flowing. Subsequent snow cover may provide sufficient insulation to prevent ice cover thickening. Insulation may also be provided by an adjacent bush in the case of small streams. Icing forms when the stream freezes to the bottom and free water is forced to the surface as a result of insufficient insulating cover. Even small streams provide enough water to build up very large masses of ice. Complete freezing of the stream may occur at sudden changes of channel cross-section from narrow to wide or abrupt flattening of the stream gradient. For example, such a change in slope occurs when a small stream runs down a steep slope and then spills out over an alluvial fan.

Careless or unknowing tramping down of the insulating cover on the ice of a stream often results in freezing to the bottom thus forcing water to the surface. This occurred at a site about 200 ft upstream from the road after someone snowshoed across a small stream. Within a week ice had formed some 6 ft thick down to the road and began to encroach on it. A maintenance problem had been created for the remainder of the winter. The insulating cover is also often lost when a stream issues from the bush and flows across the cleared road verges.

The second category, that of seepage forced to the surface, is illustrated by Fig. 4. The zone in which seepages occur is relatively shallow and is underlain by an impermeable strata which is often permafrost. The mechanism causing icing is similar to that for streams, i.e., downward freezing of the ground until contact is made with the impermeable layer. A dam is thus formed and hydrostatic pressure in the seeping water forces it to the surface to create the icing. It is common for seepage of this nature to occur over some distance

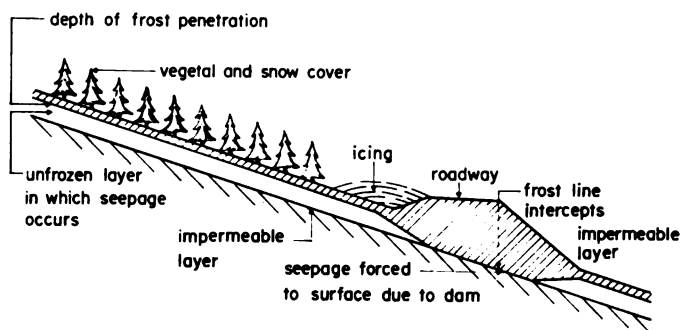

Fig. 4. Formation of an icing due to seepage



Fig. 5. An icing formed by a perennial spring

parallel to the road and, once started, individual icings quickly coalesce and may affect a considerable length of road. Uphill to the road the natural snow cover, vegetation, deadfalls, etc., form an excellent insulating cover preventing frost penetration and ensuring an unfrozen zone through which water may seep. However, the cleared roadway provides a belt in which deep frost penetration occurs; hence the dam often forms under the road and icing forms immediately uphill to the road shoulder. Ditches are quickly filled and ice spills over the road.

The third type of icing develops from a perennially-flowing seepage or spring (Fig. 5). The mechanism consists of water freezing as it issues from the ground. Hydrostatic pressure prevents the water source from being sealed off by freezing. The extent of icing so formed depends on the amount and source of water. In a spring the icing is likely to be discrete; but where seepage is involved, a considerable length parallel to the road is usually affected.

ICING CONTROL AND CORRECTION

The primary goal of control and correction is to keep the road surface free of ice. Measures taken to control or eliminate icing may be either passive or active. Passive measures are those adopted to reduce the hazard to driving, hence are confined to winter. They do not yield lasting results and usually begin when ice threatens to spill onto the road. Active measures are those that eliminate, significantly reduce, or prevent icing encroachment on the road surface. Often corrective work on a site is done in summer.

Passive Measures

Passive measures are costly in maintenance effort and use equipment and manhours that should be expended on other tasks. Passive measures include:

Steaming—This consists of using a mobile steamer at the site to steam narrow slits in the ice and through the culvert to drain off water. These slits are usually effective for only one or two days but may last longer. In some cases a pipe, 1/2 or 3/4 in. in dia., is placed in the culvert and the upstream end turned up above possible ice level. The steam hose is coupled to this and the culvert is partially thawed out. This requires a visit to the site every day or so. Besides being costly, 25° or 35° below zero weather makes the job most unpleasant. The effort demanded can easily be visualized when several such icings occur in a road section.

Hessian cloth dams—A fence of Hessian or sack cloth is often used as a barrier to icing (Fig. 6). It is startling to see a length of sack cloth stretched perhaps 10 to 15 ft between



Fig. 6. An overtopped Hessian cloth fence

slender poles jammed into the snow with several feet of ice built up behind it. One theory advanced to explain this phenomenon is that when water flows across the top of the ice and encounters the cloth, it saturates it to some small height by capillary action. This then freezes and the water backed up freezes, hence the icing grows vertically but not horizontally. Hessian barriers are not always effective but are often helpful, particularly where the water source is in a fairly constant location. Nailing Hessian cloth over the culvert inlet and outlet often prevents ice from forming in the culvert.

Blasting—This technique involves dynamiting the icing as it builds up, then clearing the ice fragments from the road by graders or bulldozers. Blasting is repeated as necessary and can be expensive. Another use of high explosives is illustrated by the following case: Ice had formed to a depth of about 10 ft for a distance of 300 ft upstream from a culvert 10 ft in dia. Both ends of the culvert had been covered with Hessian cloth, hence it was ice free. A line of holes was steamed through the ice to the ground, and a small explosive charge placed in each. The explosion shattered only the ice near the ground surface and opened seepage channels for the water. No further growth of ice was observed during the rest of the winter.

Grading—This requires constant use of a grader, often with the scarifier attachment, and repeated trips to the site to scrape ice off the road (Fig. 7).



Fig. 7. Removal of ice from the road

Fire pots—A 45 gal drum in which a fire is kept burning most of the winter is placed at the mouth of a culvert. This usually keeps the culvert open and prevents ice from encroaching on the road. Obviously the fire pots can only be effective for very small areas: One pot can only control a small icing or a small part of a large icing. Some fire pots burn wood, rubber tires, oily rags, etc.; others burn fuel oil under controlled conditions. In either case the site must be visited frequently.

Active Measures

Active measures should be encouraged. It is only by such steps that icing can be eliminated as a highway problem. Maintenance forces can then concentrate on such tasks as snow clearance, sanding, and equipment overhaul for the ensuing construction season. If the mechanics of icing formation are considered, obvious steps toward elimination or control suggest themselves. To determine a course of action for each icing, the site should be sketched or photographed during the winter with some recognizable features included. During a site examination the following summer, with the aid of the sketch or photo, the icing can be visualized. The cause then usually becomes apparent and a plan for correction can be formulated. Except for freezing belts (which are constructed during early winter), active measures are taken during the summer.

Drainage—Icings are basically a drainage problem, hence possibly the best procedure is to drain the water causing icing formation. Drainage may be effected by surface trenches or subsurface drains, both constructed during the summer. Drainage is particularly effective for muskeg areas, since muskegs provide a steady, year-round water supply. Seepage, if not too deep, can be intercepted and led away from the site. Good drainage cannot be overstressed.

Freezing belts—If an area upslope from the road is cleared of its insulating cover, then frost penetration will increase, cause damming of the seeping water, and force icing to occur where it will not encroach on the road. Snow must be kept off these cleared areas until about January to ensure maximum frost penetration. To be successful there must be an impermeable layer that can be intercepted by downward freezing. If this impermeable layer is permafrost, care must be taken not to let it thaw beneath the cleared area during summer; hence the insulating blanket must be replaced in the spring. Freezing belts have not been very effective in the author's experience, although very few have been tried. The mountainous terrain on the Alaska Highway does not lend itself to freezing belts.

Ponding areas—For some icings there appears to be a maximum growth in a given season. For these, a ponding area which will contain the icing for the winter can be created by excavation or diking or both. On occasion the topography is such

that a dike parallel to the road will divert the direction of horizontal growth of the icing so as to prevent its encroachment on the road. If icing does not overflow the dike or ponding area, it is just ignored. Occasional repair of the dikes is required in summer.

Grade raises—Raising the road grade is akin to diking in that it forces the icing to grow in size before encroaching on the road. The depth to which frost penetrates the original ground is also decreased and damming off of seeping water may not occur.

Road location—If potential icing areas can be recognized during the preliminary survey, the problem can be avoided by road location. Unfortunately, with the present state of knowledge, prediction of icing formation is largely speculative or intuitive and can hardly be a weighty factor in location.

Culverts—Installation of oversize culverts on steep gradients and as deep in the ground as possible will help in icing control. Hessian cloth hung over both ends of the culvert often prevents ice from forming in the culverts.

Channel correction—Where possible, the elimination of stream channel characteristics associated with icings is of value. Narrow, deep channels are preferred; braided channels are to be avoided.

Each particular icing is, in essence, an individual problem. Thus, the corrective action adopted should follow site study. When a more extensive road network is built in northern latitudes, the phenomena of icings will become more well known.

The Canadian portion of the Alaska Highway is operated and maintained by the Canadian Army. The Commander, NWHS, authorized use of the subject matter and the Chief Engineer, Royal Canadian Engineers, granted permission for publication.

REFERENCES

- [1] S. W. Muller. Permafrost or Permanently Frozen Ground and Related Engineering Problems, J. W. Edwards, Inc., Ann Arbor, Mich., 1947.
- [2] A. W. Johnson. "Frost Action in Roads and Airfields, A Review of the Literature," Highway Res. Bd., Spec. Rept. No. 1, Washington, D.C., 1952, pp. 216-233.
- [3] D. P. Krynine, W. R. Judd. Principles of Engineering Geology and Geotechnics, McGraw-Hill, Toronto, 1957, pp. 385-421.
- [4] K. Terzaghi. "Permafrost," Contrib. Soil Mechanics, 1941-1953, Boston Soc. Civil Engrs., Boston, 1953, pp. 319-368.
- [5] G. P. Tschebotarioff. Soil Mechanics, Foundations, and Earth Structures, McGraw-Hill, Toronto, 1952, pp. 612-614.

USE OF INTERNAL BURNERS FOR WORKING PERMAFROST AND ICE

JAMES A. BROWNING and JAMES F. ORDWAY, Thermal Dynamics Corporation, Lebanon, N. H.

Relatively simple techniques are sought for drilling permafrost and ice under the severe conditions in northern areas. Internal burners are in common use for drilling and working solid mineral masses such as granite and taconite. Use of these burners for working free and frozen soils and ice also appears realistic. Since 1955, experiments have shown that frozen minerals can be worked by hot flame jets.

Reference [1], issued in September 1962, conclusively demonstrates that internal burners can be used for working permafrost at significant drilling rates. Based on this information, an experimental program commenced on November 15, 1962. The main goals of the program were to gain a better understanding of principles governing the "cutting" action of jet flames and to evaluate burner designs already available. It was felt that once the process variables were better understood, designs could be optimized.

TEST APPARATUS AND PROCEDURES

Several techniques were considered for holding and advancing the burner for drilling. The simple operation of the system shown in Figs. 1 and 2 appeared to offer a big advantage. The motion of the burner is controlled manually by the operator. As drilling proceeds the operator pays out the support line so as to lower the burner into the hole at the desired rate.

Compressed air and fuel oil are fed into the burner's combustion chamber at a low rate and then ignited by an auxiliary flame or other means. Once combustion starts the ignition source is removed, and the flow of reactants is increased to about a quarter of full output. The burner should be run at this low output for a minute or two in order for the burner tubes to become hot. Then the reactants can be adjusted to desired flow rates.

The weight of the burner and its support rod overcomes the flame jet upward reactive thrust. The burner is easily lowered by gravity. It was found desirable to oscillate the burner about its vertical axis while it is being lowered into the hole. A "spudding" operation was used to determine the location of the bottom of the hole relative to the advancing burner. Every ten seconds or so, the burner is allowed to touch the bottom of the hole and is then immediately raised about 2 in.

When the burner was not rotated and tapped against the bottom of the hole (in a silt soil), a clinker formed on the burner face. In one case this baked mass of soil particles was nearly 3 in. thick. It had the outside diameter of the

burner, but a hole through its center provided a path for the flame jet. This clinker is objectionable and should be avoided.

During the first drilling tests, a complicating factor arose during the first minute or so required to establish equilibrium conditions in the soil. Prior to drilling, the soil is cold. Immediately after flame impingement, heat is transferred to the soil from a source which, for simplicity, can be considered a point on the centerline of the burner. Until the heat is conducted radially from this axis, the hole remains quite narrow. Thus, the initial hole (which can be deepened rapidly) is smaller in diameter than the burner.

Due to these factors, the burner is held above ground for the time required to produce equilibrium conditions (i.e., where the hole is larger than the burner and will be of nearly constant diameter as the burner advances). Fig. 3 illustrates this transient phenomenon. In several cases equilibrium drilling conditions could not be attained before an appreciable amount of frost had been penetrated. The higher the flame jet velocity, the greater the depth attained before the burner could be placed near the hole bottom.

Actual penetration rate can be defined as the average optimum drilling speed. Unfortunately, this important figure could not be directly obtained due to the transient start-up problem and to the fact that steady-state conditions require a spudding of the burner in its downward travel. Moreover, the operator skill required introduces the human factor as another variable. For example, the operator must determine the proper moment to lower the burner into the hole.

To eliminate all variables except flame jet characteristics, the following method was adopted for most of the comparison



Fig. 1. Apparatus in place (KR#192) showing support tripod burner, bottom guide with removable cover plate in place, support rope, and flow control valves for air and fuel

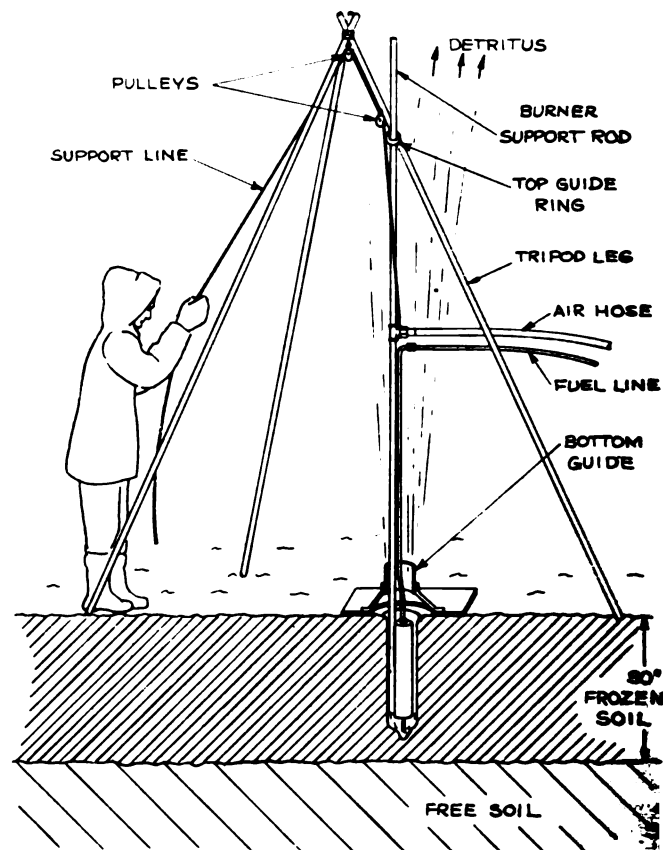

Fig. 2. Sketch of burner apparatus in a drilling operation

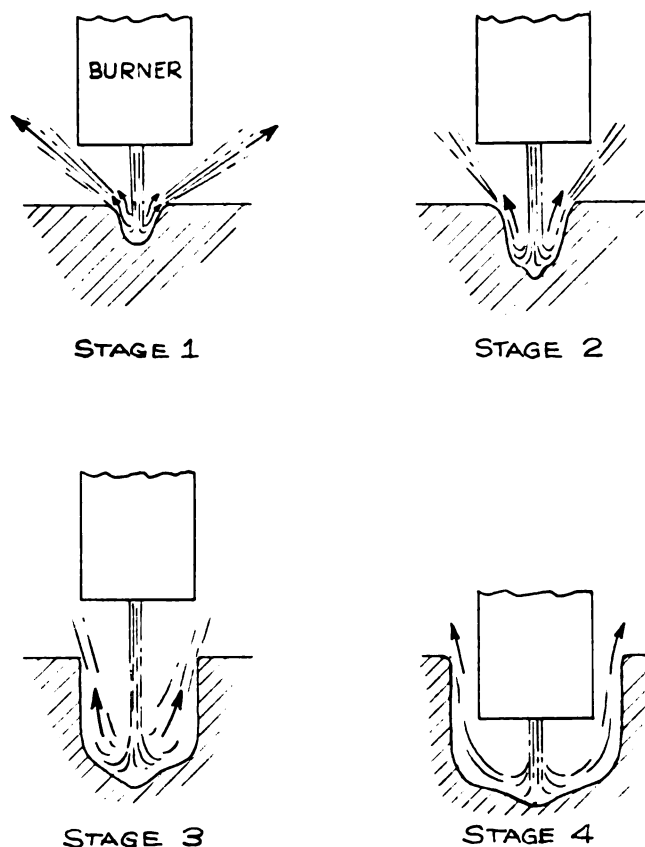

Fig. 3. Illustration of hole diameter increase

tests. The burner was fixed in its downward position and held in the bottom guide with its face 2 in. above ground level. Run time was 30 sec. Hole depth and diameter were measured; the volume of material removed was determined by filling the hole with a known amount of a medium grade sand of nearly spherical particle shape.

THE INTERNAL BURNER

Fig. 4 shows the burner assembly used. Compressed air entering through supply tube 3 is distributed by an annular groove in nozzle piece 1, thus cooling the nozzle. From this groove air passes at high velocity through the annular space between combustor tube 5 and outer casing 4. The air is heated to approximately 500°F and, at the same time, keeps those parts in direct contact with the flame below their fusing temperatures. The hot compressed air is fed through several radial passages (in piece 7) to a well into which fuel oil is sprayed by a conventional whirl-type industrial spray nozzle of 20 gal/hour capacity. Combustion in the chamber creates a jet discharge of hot gas through the nozzle. Jet velocity depends on nozzle diameter and reactant flow rates.

Nozzle diameters of 1.25, 1.52, and 1.75 in. were used in the tests. Each diameter was chosen so that the cross section of the nozzle, between the smallest and largest sizes, would increase by the same amount. The various nozzle sizes selected would guarantee a wide range of jet velocities.

Piece 7 acts as a shoulder stabilizer which provides flow recirculation at the foot of the combustion region, and recirculates hot, partially-combusted reactants into this same critical stabilization region. The over-all ability of a burner to consume large through-puts of reactants depends on this small space where favorable flame-holding and flame-ignition properties exist.

The ability of an internal burner to burn large quantities of reactants in a small volume can be measured in terms of volumetric heat release. For the gas turbine combustor the

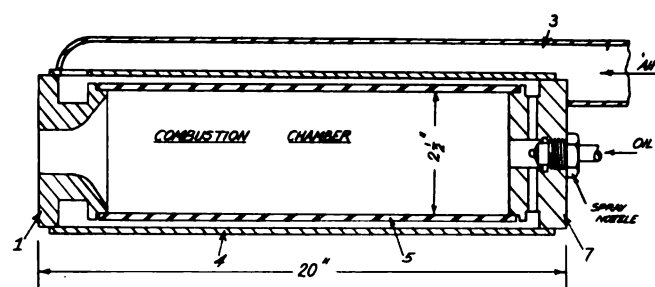

Fig. 4. Internal combustion burner

present maximum heat release rate is in the range of 2 to 10 million Btu/cu ft/hour, whereas for an oil-fired boiler the rate is in the range of 36 to 180 thousand Btu/cu ft/hour [3]. For the gas turbine combustor, maximum heat release is associated with air-fuel ratios greater than 30 to 1 by weight. The present internal burner can reliably burn stoichiometric reactant mixtures because of forced-air cooling of the combustor tube. Thus, it is not surprising that its volumetric heat release ranges up to 22 million.

Flow parameters involved in stabilizing flame reactions are so complex as to be beyond the realm of analytical understanding. All combustors, where a new design of the stabilization region is involved, must be designed on an empirical basis. Scaling laws are often not applicable, although the shoulder-stabilizer appears more amenable to scale-up than the usual perforated can combustor.

Materials used to make this internal burner are not critical except for combustor tube 5 and nozzle 1. These are usually made of a more refractory metal such as a 310 stainless.

TEST RESULTS

Table I presents data on hole depth and hole volume taken after the 30 sec runs. Several calculated quantities are included.

Combustion temperatures (T_c) were calculated by successive trials. For a stoichiometric mixture, assuming the fuel to be closely approximated by dodecane

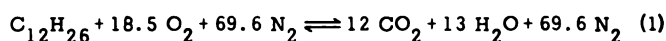

This stoichiometric equation assumes that all reactants are chemically combined to form only the end products: Water vapor, carbon dioxide, and nitrogen. This, of course, is not the true case, but in the absence of applicable dissociation it serves our purposes adequately. The combustion temperature calculated using these approximations is the theoretical flame temperature, which is always higher than that actually attained. The air-fuel ratio is easily determined from the stoichiometric equation. It is 14.9 to 1 for dodecane and represents the number of pounds of air per pound of fuel. Note that in this report the ratio is stated on a weight rather than on a molal basis.

The T_c values obtained for four air-fuel ratios are plotted in Fig. 5. A slight drop-off of the flame temperature occurs for rich mixtures and is so indicated by the dashed portion of the curve which has not been calculated. Fig. 5 has been directly used for filling the combustion temperature column in Table I.

The values shown (in ft/sec) for jet velocity were calculated by the familiar nozzle expansion equation

$$V_j = 223.7 \left\{ C_p T_c \left[1 - \left(\frac{P_3}{P_2} \right)^{(K-1)/K} \right] \right\}^{1/2} \quad (2)$$

where V_j is jet velocity; C_p is average specific heat of the products obtained from the Gas Tables [2]; T_c is combustion temperature in °R; P_3 is atmospheric pressure—15 psia; P_2 is combustion chamber pressure; and, K is ratio of the specific heats as obtained from the Gas Tables. A nozzle efficiency of 90% was used.

Table I. Compilation of 30 second run data (runs made at the CRREL location)

Point	Run No.	Nozzle dia. (in.)	Fuel flow (lb./min)	Air flow		Chamber pressure		Combustion temp. (°F)	Jet temp. (°F)	Jet velocity (ft/sec)	Hole depth (in.)	Hole dia. (in.)	Hole vol. (cu in.)	Air (cu in./100 ft ³)
				(lb./min)	(scfm)	(psig)	A/F							
a	101	1.250	1.92	26.5	354	32	13.8	3370	2530	3650	9.25	5	275	156
b	102	1.250	1.59	26.5	354	28	16.6	3250	2490	3480	8.5	6	275	156
c	103	1.250	1.36	26.5	354	27	19.5	2900	2230	3120	9.5	5	198	112
d	104	1.250	1.10	26.5	354	26	24.1	2320	1775	2940	8	5	198	112
e	105	1.250	1.66	21.5	287	20	13.0	3350	2710	3190	7.5	4.5	168	118
f	106	1.250	1.36	15.2	203	11.5	11.2	3300	2860	2640	6.5	4	168	166
g	107	1.250	0.90	9.5	127	3	10.5	3270	3130	1520	4.5	4	92	164
h	128	1.520	2.04	25.7	344	16	16.0	3300	2750	2960	4.75	-	222	128
i	129	1.520	1.36	25.8	345	13.5	19.0	2950	2510	2660	4	-	198	114
j	130	1.520	0.78	25.0	334	10.5	23.8	2400	2090	2120	5.25	5	122	74
k	132	1.520	1.59	20.2	270	7.5	12.7	3300	2980	2260	4.75	6	107	80
l	133	1.520	1.10	13.5	180	2	12.3	3300	3200	1270	3	5	61	66
m	153	1.750	2.04	27.0	361	8	13.2	3300	3000	2300	3.25	6	71	40
n	154	1.750	1.36	27.0	361	7	19.8	2850	2585	2050	3.75	6	122	68
o	155	1.750	1.59	19.6	262	4.25	12.3	3300	3100	1780	4	5	61	46
p	173	0.875	1.50	20.5	274	55	13.6	3300	2225	4150	9	5	137	100
q	174	0.875	0.70	23.1	309	50	33	1830	1150	2030	8.25	4	92	60

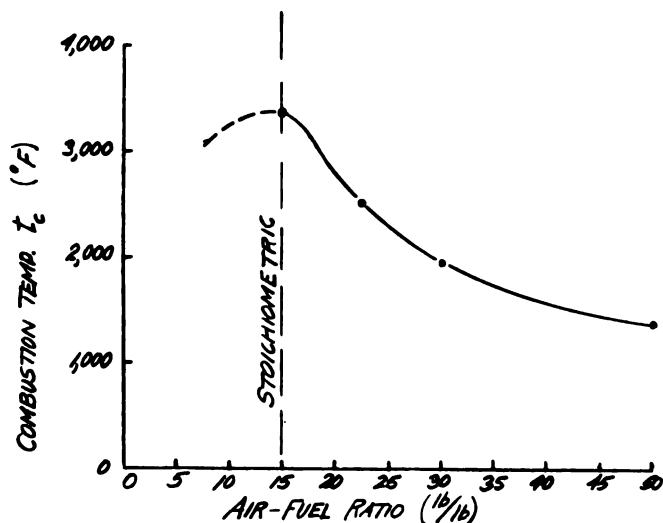

Fig. 5. Curve of T_c as a function of air-fuel ratio

T_j , the jet temperature, may be obtained using the relationship

$$T_j = T_c \left(\frac{P_3}{P_2} \right)^{(K-1)/K} \quad (3)$$

Table I shows that jet temperature ranged between 1150° to 3200° F, while jet velocity limits were 950 ft/sec and 4150 ft/sec.

Two types of soil were investigated: A sandy soil and a fine silt. (Later, more detail is reported on this soil and its frozen properties.)

Table I lists data obtained during the 30 sec runs in fine silt seasonal frost. The most important parameters appear to be air-mass flow and jet velocity. For example, for any given nozzle size, increased air-mass flow results in deeper penetration. Conversely, at any given mass flow rate, the smaller the nozzle diameter, the greater the depth. This is true down to the 1.25 in. nozzle. The 0.875 in. nozzle could not drill an opening of sufficient diameter to permit lowering of the burner into the hole.

The 1.75 and 1.52 in. nozzles are much less effective (both for penetration removal) than the smaller sizes which give higher jet velocity for the same reactant flows.

A unique phenomenon was observed: While drilling holes

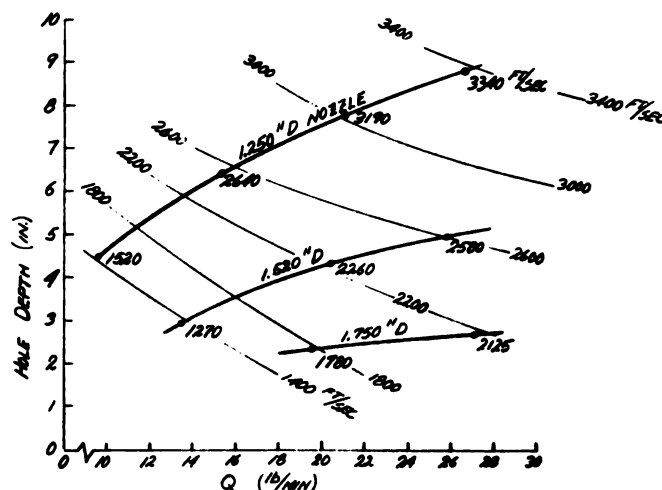

Fig. 6. Hole depth for standard 30 sec run as a function of air-mass flow Q with constant jet velocity lines

to depths of 30 in. and more, lateral flow of the gasses occurred. In one case, a previously drilled hole continuously ejected steam and other vapors during a separate drilling operation conducted more than 6 ft away. This indicates that there were continuous free passages in the soil. Such an effect was not noted in sandy soil.

No correlation was found between depth of cut or removal rate and jet temperature. Unfortunately, for a given combustion temperature, jet temperature depends on jet velocity. The greater the velocity, the lower T_c . It is thus inferred that velocity plays a more dominant part.

An attempt has been made to correlate hole depth against air-mass flow by plotting lines of equal jet velocity. This is shown in Fig. 6. An obvious inference is that jet velocity alone is not governing, but that a jet-scale factor is important. For example, the $V_j = 1520$ ft/sec on the 1.25 in. nozzle line penetrates deeper in 30 sec than the 1780 ft/sec jet of the 1.75 in. nozzle. This factor is important and deserves an explanation.

Penetration rate is a function of the heat transfer rate into the soil and of the scouring ability of the flame jet. Each of these depends, in part, on the gas velocity component parallel to the surface being worked. To simplify the problem, assume the jet to be striking perpendicularly against a plane surface. Compare the action of a relatively small diameter

jet against that of a larger one. The radial velocity gradient measured at the stagnation point is greater for the smaller diameter nozzle. Qualitatively, this results from the fact that the stagnation pressures at the stagnation points are the same, but that the larger the area of impact, the greater the distance the gases must travel to reach the lower static jet pressure. Since the pressure gradient determines the velocity at any point removed slightly from the stagnation point, the smaller jet creates higher radial velocities within this region over the plane surface. A somewhat similar situation has been analyzed in an experiment by Wisniewski [3], who studied a jet impacting against a convex hemispherical surface.

It is seen that the larger the jet size, the lower the heat transfer rate and scouring action at the jet centerline. A similar effect results from lowering the mass flow rate through any single nozzle diameter. The hole bottom has the characteristics shown in Fig. 7: (a) A hole made by a high velocity jet is concave; (b) medium velocities have a flattening effect; and (c) low velocities produce bottoms having a convex central portion.

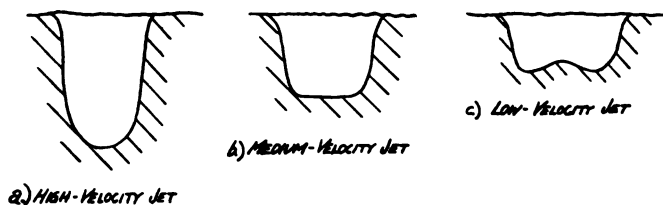

Fig. 7. Hole shape after 30 sec run as function of jet velocity

At the conclusion of each series of tests of 30 sec duration, the burner was used to drill through the full depth of the seasonal frost. The data collected appear in Table II. The data reflect optimum cutting conditions at penetration rates obtained under the difficult transient starting conditions discussed earlier. Thus, the steady-state rate might be expected to be somewhat greater.

Table II. Holes drilled to full frost depth (runs made at CRREL location)

Nozzle dia. (in.)	Hole depth (in.)	Avg. hole dia. (in.)	Drilling time (min sec)	Avg. penetration rate (in./min)
1.25	33	6	2 30	13
1.52	30	7	3 47	8
1.75	27	8	6	4.5

In each case maximum air flow at slightly rich mixture conditions was used

The wall of the drilled hole is characterized by a "dry" layer of soil up to 0.5 in. in thickness immediately backed up by frozen ground. The low heat conductivity of this layer serves as an effective insulator to the further heat flow. In one case, after drilling to a depth of over 2 ft, the burner was held stationary for several minutes to create an enlarged hole. In this case, the diameter of the previously drilled hole did not appear to be affected.

An average speed somewhat greater than one ft/min was attained in drilling the silty soil. Although less experience was gained in working the sandy soil, the rate of penetration was about twice as fast.

Table III gives data obtained in drilling ice. A commercial 300 lb block was used.

Depth in Inches	Bulk Density #/cu ft	Dry Density #/cu ft	Moisture Content % by wt.	Porosity $n = \frac{V_v}{V}$	Saturation	Percent H ₂ O Frozen	Depth in Inches	Bulk Density #/cu ft	Dry Density #/cu ft	Moisture Content % by wt.	Porosity $n = \frac{V_v}{V}$	Saturation	Percent H ₂ O Frozen
6.0	85.0	58.6	44.8	0.65	64.6	88.1	1.0	87.4	57.4	52.0	0.66	73.0	82.6
9.0	91.2	63.1	45.6	0.63	73.4	91.7	3.0	93.0	61.8	50.0	0.63	78.8	85.6
12.0	71.8	55.6	30.0	0.67	39.8	75.2	7.5	93.6	66.4	41.4	0.60	72.9	84.8
18.0	84.9	64.9	31.4	0.61	53.2	88.3	10.5	106.2	77.2	37.4	0.54	86.0	82.2
21.0	101.7	71.2	44.6	0.58	86.5	86.3	11.0	98.9	67.8	46.0	0.60	83.8	87.2
No tests below 26" (Limit of Frost Penetration)							13.0	96.8	72.4	33.5	0.57	68.8	85.8
							14.5	118.0	89.9	31.0	0.46	96.1	74.0
							17.0	94.9	73.7	29.5	0.56	61.7	84.5
							20.0	87.4	69.8	26.8	0.58	50.5	91.7
							21.5	Limit of Frost Penetration					
							23.0	Limit of Frost Penetration					

Fig. 8. Properties of frozen soil, burner test plot

Table III. Drilling of solid ice (Nozzle Size: 1.25 in. dia. at max output)

Time of run (sec)	Hole depth (in.)	Hole dia. (in.)	Vol removed (cu in.)	Avg. penetration rate (in./min)
30	17	7	920	...
15	9.5	7	260	...
34	20	7.5	...	35

The high removal and penetration rates (compared with frozen soil) were a surprise. Each is about three times greater than those attained in drilling the silty soil. These results indicate that the heat conductivity of the material is a major determinant. Although no heat conductivity measurements were made for the two frozen soils or the ice sample, the ice seems to have the highest value. No spalling action was observed in the soil or ice. Thus, drilling can only proceed as the ice is fused.

The surface of the hole in the ice had a scalloped appearance of concave depressions of about 2 in. dia. Such a formation is typical of a diverse range of processes including some forms of a Bunsen flame front.

PROPERTIES OF FINE SILT SOIL

The tests described in this report were made on a terrace (about 110 ft above the Connecticut River), west of CRREL, Hanover, N. H. The soil at the test site consisted of varved silts, probably representing late Pleistocene flood plain river deposits.

Immediately after burner testing, soil in the test plot was sampled so that its properties in the frozen state could be described. A sharpened length of tubing (1.375 in. ID by 0.0625 in. wall) was hammered into the frozen silt. The tube was withdrawn, and samples were extruded after each penetration of from 5 to 7 in. This technique yielded a series of good samples to the full depth of frost penetration (31 in.). The results of these tests appear in Fig. 8. Grain size gradations are shown in Fig. 9.

REFERENCES

- [1] I. P. Goldaev, et al. Use of Jet Burner for Drilling and Excavating Frozen Ground, Publ. House Sci. Tech. Lit. on Mining, Moscow, 1960.
- [2] J. H. Keenan, J. Kaye. Gas Tables, John Wiley & Sons, New York, 1960.
- [3] R. J. Wisniewski. "Methods of Predicting Laminar Heat Rates on Hypersonic Vehicles," NASA, TN D-201, 1959.

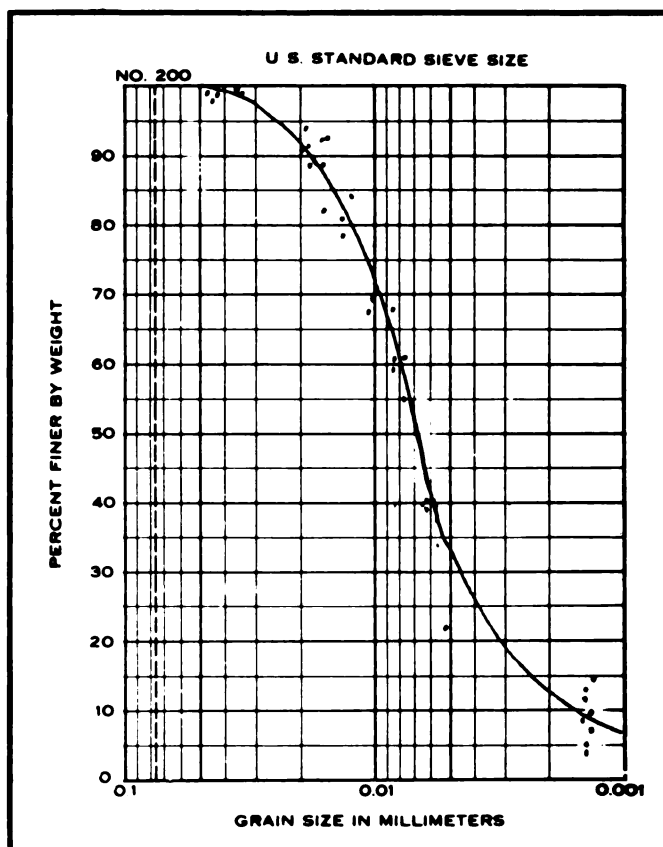

Sample No.	Elev or Depth	Classification
Both Pits	2.0 ft to 5.0 ft Test (10 Samples)	ML
Project		Jet Burner Contract
Area		Hanover, N.H. (CRREL)
Boring No.		Test Pits I & II
Date		Samples taken Oct. 28, 1962

Fig. 9. Grain size gradations, burner test plot

This work was sponsored by the U.S. Army Cold Regions Research and Engineering Laboratory under contract number DA-19-016-ENG-7735.

GRAVEL-FILL ROADS ON PERMAFROST AND GLACIER ICE

ROBERT M. DAVIS, U. S. Army Cold Regions Research and Engineering Laboratory

As part of the Corps of Engineers' investigations in northern Greenland, a project was begun in 1954 to develop methods, techniques, and criteria for constructing roads on both glacial ice surfaces and adjacent ice-free land. About 4.5 miles of roads built on glacier ice included two bridges, and about 6 miles were on the ice-free land. Besides road construction techniques, various factors affecting road performance were studied. These include soil thaw depth, temperature pattern in both ice and soil, surface and subsurface movement of the icecap, and hydrology of melt streams and the icecap.

SITE DESCRIPTION

The site studied extended between a point on the existing road from Thule Air Base to an outlying facility and to Camp Tuto (Fig. 1).

Land formation over the entire area is essentially a rolling or gently undulating boulder plain. Two types of drainage activity are apparent: (a) Drainage of local snow melt and thawing ground, and (b) drainage flow from the icecap. The first type has maximum flow early in summer, thereafter diminishing, and usually completely drying up on the surface by the middle to the end of summer. The second type has maximum flow during the warmest part of summer when maximum melt conditions exist on the icecap. Rapid increases in flow occur during or following unusually warm weather. In many places the land is completely covered with boulders. In a few places finer soils have accumulated or have been deposited to form either frost-susceptible silty or clayey soil, or both. Patterned ground exists over the entire area. Snowfall as measured by temperate climate standards is relatively light; however, wind and dry, cold winter conditions cause drifting and make snow cover a considerable problem. Snow accumulations in the lee of hills often persist through nearly the entire summer season. Snow depths in valleys and especially at the slope break at the very toe of the icecap, are 4 to 5 ft, although hill and ridge tops remain bare.

The part of the icecap on which gravel-fill roads were built was a large tongue of ice located between extensive moraine formations. Ice meets land on a relatively smooth 5% slope. In spring, the snow cover varies in depth; it is from 2 to 8 ft deep at the glacier edge, and from 0 to 2 ft, 3 miles from the edge. Snow conditions also vary from year to year.

BORROW MATERIALS

Prior to construction, all airphotos, ground reconnaissance, and borings were studied, and simple soil tests were made to locate suitable borrow materials.

Two borrow types were required: Coarse, clean, highly permeable material for the base course and a cobble-free, silt-free, gravelly sand for the surface course. There are no outcrops of bedrock in the Tuto area so all borrow comes from the active zone (Fig. 2). As this zone only extends to a maximum depth of 3 to 4 ft, extensive areas are required for sufficient borrow.

Observations were made on the location of various types of borrow material that may be of value for construction on terrain similar to that at Tuto. Airphotos or visual observations from the air result in a reasonable estimation of types of material present. This plus a little ground reconnaissance, provides all necessary data.

Coarse Borrow

Clean cobbles and boulders support only lichens (on the lee side) whereas practically all other areas are covered with a few inches of organic soil supporting moss, lichens, grass, and other small plants. Thus, the areas covered with cobbles



Fig. 1. Camp Tuto and roads on ice and permafrost (U. S. Army photograph)

and boulders can be located from the air by their relatively light tone. On the ground these areas can be located by observing old stream channels, gulleys, and the lee side of ridges. Where annual thaw penetration is shallow, cobbles and boulders are only a thin veneer on the surface and quantities should be estimated on this basis.

Because steam has been used in the Arctic to thaw frozen ground for excavation and especially to thaw a cylinder of ground prior to pile driving, experiments with steam thawing were made in 1957 to determine if the technique could be used to thaw sufficient quantities of permafrost for earth construction. Test results indicated that steam thawing of large areas would be uneconomical and impractical. The test required excessive heat energy. Steam injection together with ice melting in the soil created excessive water. Extensive drainage and drying would be necessary before the thawed soil could be used as borrow material. The "zero curtain" surrounding the steampipe sets a definite limit on the rate of heat transfer into frozen ground. In future studies of artificial thawing procedures, only enough heat should be applied to maintain a reasonable advance rate of the thaw boundary



Fig. 2. Bulldozers stockpiling coarse fill from the active zone

around the heating pipe, and much greater thawing time should be allowed. Simple solar radiation thawing was successful, but scraping up thawed layers for stockpiling demands large areas and ample lead time.

Fine-Grained Borrow

Although fine grained soils can be differentiated from coarse-grained soils, only a specialist in airphoto interpretation can determine if the soil has excessive clay or silt making it unsuitable for borrow material. After possible areas are located by airphotos or observations from an airplane, a few simple borings and tests of soil will determine its suitability. Clean sand deposits are available but rare at Camp Tuto.

Random-Mixed Borrow

Most soil around Tuto falls about halfway between the above two types. A wide range of sizes is available that is too deficient in fine gravel and coarse sand sizes to be uniformly graded. Normally this material is acceptable for road fill; but with heavy melt-water flow, the finer materials wash out and allow slumping. This material is well suited for berm or dike construction.

The following specifications were used to select borrow: (a) For coarse borrow, 95% retained on 0.75 in. sieve, ranging up to 18 in. in diameter; (b) for fine borrow, 10% passing the 200 mesh screen and a maximum size of 2 to 3 in. with good compaction.

ROADS ON PERMAFROST AREAS

The original road across the permafrost was built simply by bulldozing aside the coarsest surface material. Thus, the road tended to be trenched a few inches below the surrounding terrain, causing snow to drift and accumulate in the roadway. Melt water also tended to collect in the road. This softened it, emphasized and prolonged any thaw weakening, and gave poor to bad service during the frost-melting period.

Original road alignment was susceptible to snow drifting and a study was made by airphoto and ground reconnaissance to realign the road, avoiding areas of frost-susceptible soils and heavy snow drifts. Snow drifting was minimized by adding high fill sections across depressions, using substantial embankments wherever necessary to pass to the lee of ridges, and choosing an alignment that considered prevailing wind direction in the area.

As in all road construction, drainage was a major consideration. Intermittent drainage was handled by a cross section of 3 ft of coarse fill consisting of cobbles and boulders that allowed melt water to pass through without damage. As necessary, large diameter steel culverts were placed in water courses. Coarse fill was topped with 6 in. of gravelly sand as a wearing surface. A 30 ft width with side slopes of 1 to 1 was suitable for the amount of traffic. The road has performed very well since its construction with only slight maintenance. Road alignment was not completely successful as the road is occasionally blocked by snowdrifts during winter. This is so infrequent that it is not considered worthwhile to completely change the location.

Road construction on permafrost presents few problems in this area. Fill depth must be such that it prevents thawing of permafrost and of any occasional subsurface ice masses. Fill must be permeable to allow melt water to flow through without damage, and adequate drainage structures must be provided.

ROAD CONSTRUCTION ON GLACIAL ICE

During the Arctic thaw season (the best time for transporting supplies to the interior and other necessary work), travel conditions along the ice edge are at their worst. Icecap snow which is firm and solid during winter becomes soft and slushy, and vehicles move over it with great difficulty. As snow melts, ice is exposed; it is crisscrossed with melt streams up to 4 or 5 ft wide and 2 to 3 ft deep. For access across the ice edge to the flatter interior areas where there is less snow

melt, the road was continued onto the icecap. The road, probably being the first built on a glacier, its problems and their solutions would be of value for military or other reasons.

Basic road design was a continuation of that used on permafrost. The road section was 30 ft wide with 2.5 ft of coarse fill and a 6 in. layer of finer surfacing material. Various test lanes were placed in the road to check the effect of different fill depths. These sections ranged from a total depth of 5.5 ft (5 ft of coarse fill and 6 in. of surface material) to a section with a total depth of 6 in. of crushed rock. The deeper sections performed satisfactorily but had no advantages over a 3 ft fill. The thin sections were an experiment to determine the minimum fill depth usable on ice. The thin section was usable for about one thaw season before differential melting caused failure. Calculations show that 3.5 ft of fill is sufficient at Tuto to protect the underlying ice from melting except during the warmest thaw season. During the 1957 thaw season, when the air thawing index was 25% above average, 0.2 ft of ice melted below the road fill. The flexible gravel fill road can tolerate this much melt with only slight corrective maintenance. The usual procedure is to correct surface depressions by grading. This removes surface material, exposes the coarse fill, and results in differential melting. Surface irregularities should be corrected by adding material in all cases.

The road on the ice was built by stockpiling fill scraped from the active zone by bulldozers. Piled fill was loaded into 10 cu yd trucks and end-dumped where needed; heavy bulldozers spread and compacted it (Fig. 3). Heavy traffic compacted the soil adequately as proven by density and compaction tests; other compaction methods were unnecessary.

With one 2 cu yd shovel, one 0.75 cu yd shovel, six bulldozers, nine 10 cu yd trucks and one grader, a 9.5 hr workday and a 3 to 4 mile haul distance, 890 cu yds of material can be placed or 300 ft of gravel fill road can be built.

Work output is lower than for construction in warmer climates because coarse bouldery material is difficult to handle, and borrowing only from the thin active zones means frequent moves to new areas and extra bulldozer work to stockpile material. Cold high winds, blowing snow, and whiteout conditions also contribute to a lower work output. Experience determined the best equipment ratio so that no item was idle. Rough terrain and unimproved ground made large, heavy models preferable. Repair and maintenance make simple mechanical controls preferable: For example, a mechanical hoist instead of a hydraulic hoist for bulldozers. In remote areas a higher percentage of replacement parts should be kept on hand than in temperate zones; equipment is used for work for which it was not designed and breakdowns are more frequent.

Ablation

The main difficulty of road construction on ice is ablation.



Fig. 3. Bulldozers spreading and compacting fill



Fig. 4. View of original ramp road showing ablation effects (U. S. Army photograph)

Fill protects ice beneath it from melting, but ice on either side of the road melts at an average rate of about 8 ft per year at the edge of the Tuto Ramp. This ablation (Fig. 4), has resulted in sections of the road being up to 70 ft above ice. As ice ablates, road fill sloughs off the side, and eventually results in complete failure at the section (Fig. 4). This ablation of ice next to the road is increased by dust blown from the road surface and by melt streams which usually flow along the toe of the road fill.

The ablation problem was soon apparent; to stop or retard shoulder sloughing, berms were added along sections of the road. These berms are about 1 ft of random mixed fill spread on ice next to the road. The berm width depends on the ablation rate. At the icecap edge, a berm 30 ft wide has been effective because the lower 0.5 mile of the original ramp road is still usable after being in place for 10 years. Measurements have shown that about 1 ft of berm width is lost per 4 ft of ablation so the required berm width for a road section can be calculated. When the new ramp road was built, berms were added at the same time. The new road design consisted of a 50 ft travel way with a 25 ft berm on either side. With the present ablation rate, this road should last over 15 years.

Drainage

The second major problem of road construction on glacier ice was drainage. The original ramp road was installed along a ridge parallel to the drainage pattern so that no drainage structures were required. Dikes of 30 or 40 ft sections of

gravel fill extending from the road at an acute angle to the road alignment in a downhill direction were built. Their purpose was to divert water from the toe of the road fill, but they are also very convenient for turnarounds.

As more roads were built at right angles to the melt stream pattern, various types of culverts and two bridges were incorporated in the roads.

The original culvert design was of 36 in. corrugated iron pipe (CIP). These performed as planned during the first thaw season, but by the end of the next thaw season they were perched above the ice. The most effective type for use on ice consisted of a half round CIP set on wooden sills. This was based on the principle that ice below the culvert would melt at the same rate as exposed ice. While this type has been most effective, it has not been completely satisfactory. Ice beneath the culvert is protected from the sun and is ablated at a slower rate than the exposed ice; more seriously, the stream becomes uncontrolled and undercuts the sills thus leading to sill collapse and culvert destruction.

The most satisfactory water crossing on ice is a short (20 ft) stringer bridge. Such bridges should be placed along the road as necessary. Two types are used at Tuto: A pile bent bridge 80 ft long or a crib abutment with a clear span of 20 ft; U. S. Army steel treadway for bridging is used on both. Life span of the crib abutment bridge has been over five years, but some of the pile tips (placed 15 ft below the ice surface) became exposed in two summer seasons because of erosion by the melt water stream in an unpredictable abnormal discharge.

Movement

As in all glaciers the icecap edge is in constant motion. This horizontal movement varies from 0.1 ft per year at the edge to about 13 ft per year 2.5 miles from the edge. This affects the road only by a slight change of alignment as gravel fill is flexible enough to absorb this much movement. Besides horizontal, there is also vertical movement in the ice. At one point on the road this averaged more than 2.5 ft per year.

SUMMARY

Investigations of the Corps of Engineers since 1954 show it is possible to build semipermanent gravel fill roads for mixed and heavy traffic on permafrost and ice. Roads, with reasonable maintenance, should last for 10 years. It is also practicable to construct all required structures, such as bridges supported entirely on the ice, with remarkably little maintenance.

THAWING AND CONSOLIDATION OF PERMAFROST PRIOR TO CONSTRUCTION

B. A. RZHANITSIN, B. P. GORBUNOV, L. I. KURDENKOV, Scientific Research Institute of Foundations and Underground Structures
V. F. ZHUKOV, V. A. Obruchev Permafrost Research Institute
A. N. KURYACHIN, Northeastern Council of National Economy, USSR

Many years of research into the strength and deformation of permafrost (in the frozen state, in the process of thawing, and in the thawed state) have yielded a wealth of data for developing practical methods of construction in permafrost regions [1]. Widespread application of the scientific inferences and practical suggestions resulting from such research has made it possible to check, correct, and supplement the technical practices, specifications, and procedures for construction in areas affected by permafrost.

Soil temperature under the foundation is a primary factor in designing foundations in permafrost.

Several methods have been used for treating the foundation bed (soil affected by construction and use of the structure). However, all such methods can be divided into two groups based on two different ways of treating the foundation bed. The first method is based on maintaining the foundation bed at subzero temperatures during the entire life-span of the structure. The second method is based on maintaining the foundation bed at temperatures above zero. The choice of method for treating the foundation bed depends on geocryological and engineering features of the site and on design features of the structure. Both methods artificially alter temperature and bearing characteristics of the foundation bed (either by refreezing thawed soil or by thawing frozen soil).

The present paper deals with thawing and (easily realized) consolidation of frozen soils in the foundation bed prior to construction.

Artificial thawing of permafrost prior to construction was suggested long ago (by M. I. Evdokimov-Rokotovskiy in 1931, A. B. Liverovskiy in 1941, V. F. Zhukov in 1958, and others). The main purpose of artificial thawing prior to construction is to provide a more stable foundation bed and to preclude non-uniform settlement of the structure due to soil thawing.

Such factors are especially important where structures are erected on soils having high water content. Such soils occur in the southern part of the permafrost region where it is also difficult to maintain foundation beds at freezing temperatures.

The value of thawing foundation beds prior to construction has been generally acknowledged, and this method of building has been widely adopted in the Soviet Union.

Originally it was thought that thawed soil would become diluted by melt water from the large volume of ice-lenses. However, observations over a long period indicate that not all thawed soils, but only a few of them—mainly clays—swell intensively and lose their cohesive strength. In most cases, excess water freely escapes through macropores formerly occupied by ice-lenses; mineral aggregates thereupon come closer together forming a more compact soil. Some swelling of mineral aggregates may occur from absorption of excess moisture; in some cases this may result in partial or complete breakup of mineral aggregates, but ultimately, there is an increase in the unit weight of the soil.

Fig. 1 shows the texture of a natural frozen soil with a rather large amount of ice-lenses, which is generally representative of the typical texture of frozen loam. It is easy to imagine what may happen to such soil when it thaws. Notice should be taken that ice content in the soil is not uniform along a vertical line; this ice content is expressed in percentage in Fig. 1 b. During thaw, mineral aggregates approach one another, but do not come into close contact, since micropores remain or breakage of mineral layers and aggregates occurs.

Distribution of ice along a horizontal plane is also not uniform (Fig. 1 c). Successive thawing from top to bottom results in different compactness of each soil layer.

Thawed loams compact differently from loams that have not been frozen. This can be easily proved in testing two soil

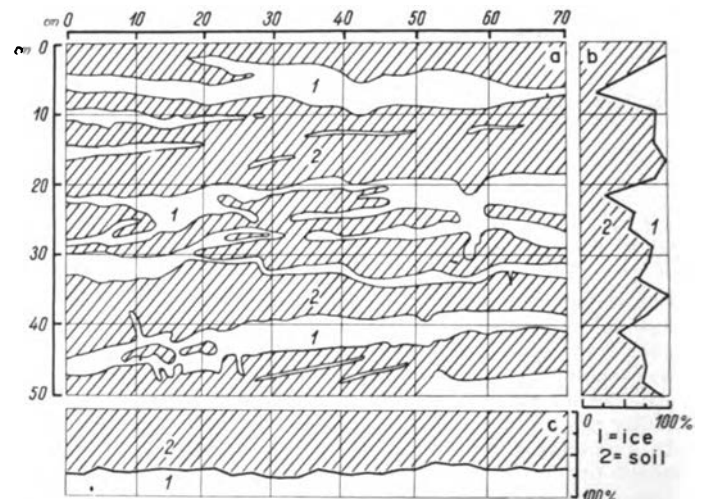

Fig. 1. Typical texture of frozen clay-loam: (a) Distribution of ice-lenses in vertical section; (b) Percentage of ice along vertical; (c) Percentage of ice along horizontal

samples, one of which has been frozen and then thawed. Consolidation of the thawed sample occurs faster and to a greater extent (even under a small load) than does the unfrozen sample.

Although thaw consolidation of frozen soils occurs rapidly and rather easily, as if "spontaneously" under the influence of its own weight, the soil, nevertheless, shows some resistance to this consolidation of the mineral aggregates.

Therefore, to obtain better consolidation and the most satisfactory results, it is necessary to improve drainage and to apply an external pressure. In practice this is realized by vertical drains, mechanical consolidation, electro-osmosis, or other methods, depending on the nature of the soil and peculiarities of the cohesion of its particles.

The study developed the best methods for consolidating thawing soils, and implementation of these methods at construction sites has yielded good results.

In developing a building method based on thawing of the foundation bed prior to construction, it was necessary to determine the minimum thawing depth needed under the foundation.

As a rule, ice inclusions in frozen soil diminish with depth. Hence, the depth of preconstruction thawing is determined first from materials found in engineering and geocryological site examination. Cases where very large amounts of ice occur should be considered separately as such sites might be unfit for building.

When distribution of ice in frozen soil is normal, depth of preconstruction thawing should not exceed the size of the "thawing bowl," which normally forms in frozen soil under a building; size and shape of the thawing bowl depends on the design of the building and the heat-loss characteristics during building use [2].

Building settlement is most rapid and most uneven during the first years of building usage when the thawing bowl begins to form and thawed soil under the foundations is still only a small part of the ultimate depth of the thawing bowl. In time, the rate of formation of the thawing bowl and of building settlement becomes slower; at this time the unevenness of building settlement also diminishes. By taking this into account, it is permissible to decrease the depth of preconstruction thawing for the sake of economy. This can be done in such a manner that building settlement (after thawing of the lower part of the bowl) is held within acceptable limits.

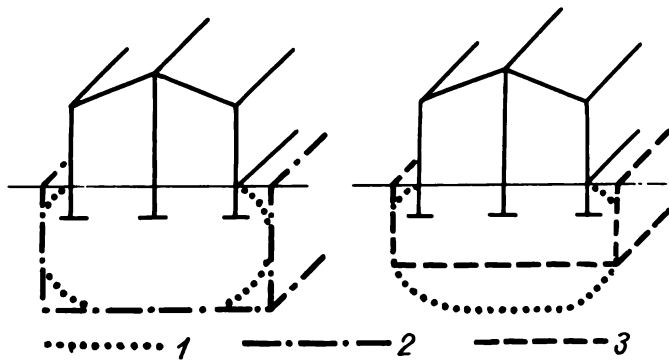

Fig. 2. Volume of preconstruction thawing of foundation beds:
 1. Profile of estimated thawing bowl under the building;
 2. Preconstruction thawing to full depth of thawing bowl;
 3. Preconstruction thawing to partial depth of thawing bowl

Fig. 2 shows schematically the required extent of preconstruction thawing of the foundation bed.

Such a building method is promising and should be further developed. The following section briefly describes the technology applied in the USSR for preconstruction thawing and consolidation of frozen beds in clayey and coarse-grained soils.

ELECTRICAL METHOD OF THAWING AND CONSOLIDATION OF CLAYEY SOILS

The electrical method of thawing and consolidating clayey soil was developed by the Institute of Foundations [3] to prepare foundation beds for heated structures in clayey permafrost. This method can be used in permafrost regions where the frozen state of the foundation bed is unstable and use of other methods of bed treatment is not feasible.

For structures that house hot technological processes, the method can also be used where the frozen condition of the foundation bed is stable.

In the complete program of building operations, treatment of foundations by this method is considered to be an independent pre-zero cycle. With such preparation, the structure can be designed and built in the same way as it is by the code of standards and rules for unfrozen natural beds.

Preparation is accomplished in two stages, each having a specific technology. The first stage involves thawing of soils accompanied by their simultaneous consolidation under the weight of overlying layers. The second stage involves artificial supplementary consolidation of the soils.

Bed preparation may be completed during the first stage if the necessary compaction is obtained.

The technology of the soil-thawing stage (Fig. 3) is based on the use of Joule heat, which originates in the body of the frozen soil when alternating current flows through it. Thawing is accompanied by consolidation caused by the closing of cavities formed after melt water from ice-lenses flows in vertical drains—electrodes.

In the second stage, lowering of water and electro-osmosis create additional pressure on the soil which contributes to supplementary consolidation.

Extent of thawing is controlled to conform with factors

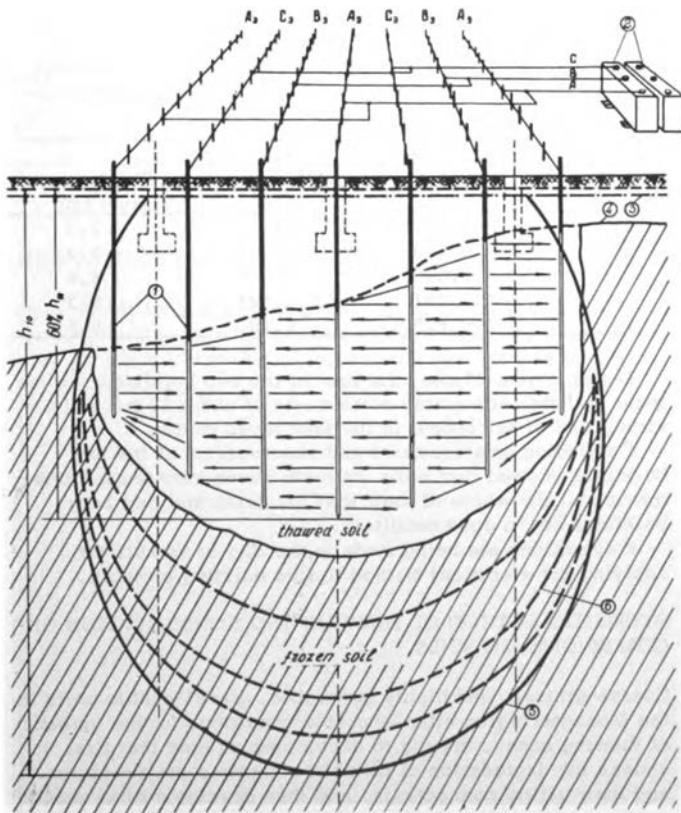

Fig. 3. Bed preparation by the electrical method (thawing stage). A, B, C, are rows of electrodes uniformly distributing the load by phases. 1. Iron pipe electrodes; 2. Step-down transformers; 3. Water table; 4. Upper surface of permafrost; 5. Outline of limit of thawing bowl during the period of use; 6. Changes of the thawing bowl with time

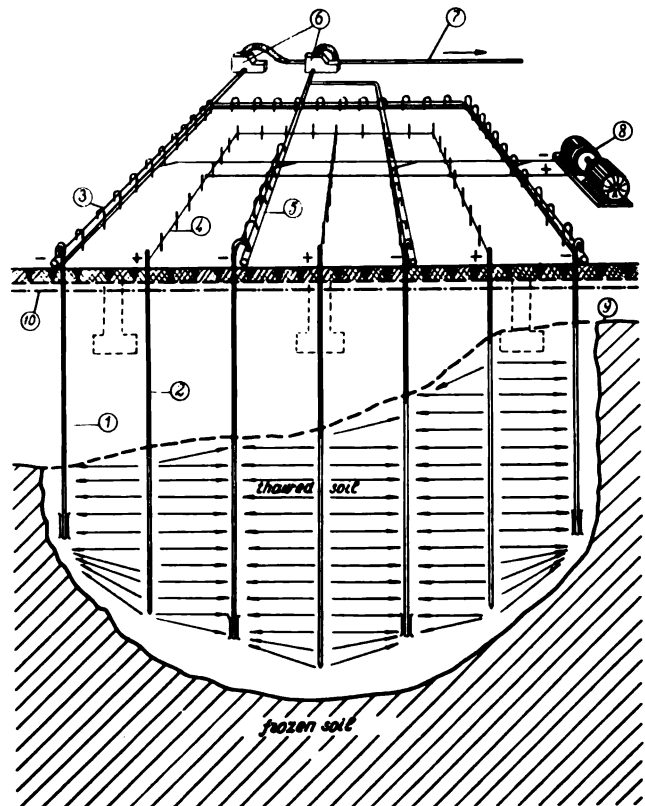

Fig. 4. Bed preparation by the electrical method (consolidation stage). 1. Well point cathode; 2. Anode; 3. Flexible connection hose; 4. Current conductor; 5. Header; 6. Pumps; 7. Discharge; 8. Direct current generator; 9. Upper surface of permafrost; 10. Water table

applied to depth and configuration of the calculated thawing bowl; these factors assure the uniform settlement of a structure due to the deformation of the bowl during its lifetime.

In practice, success is ensured by observing the following specifications: (a) Depth of the thawed body of soils is assumed to be not less than 60% of the depth of the calculated thawing bowl in the center of a structure after a decade of use; (b) width of the thawed soil body is assumed to equal the width of this bowl; (c) configuration of the lower part of the massif is defined by a curved surface resembling the profile of the calculated bowl. Alternating current is fed to frozen soil through vertical electrodes, each of which functions as a vertical drain.

The electrodes consist of gas or water pipes with perforated sections at the ends. These pipes are sunk into bored holes. The electrodes are arranged in rows.

Intervals between rows and distances between electrodes are specified with regard to the depth at which the electrodes are located along the arc resembling the profile of the lower boundary of the calculated thawing bowl after a ten-year life of the structure; maximum depth of electrodes should not be less than 60% of the depth of the calculated bowl at the structure center.

To secure positive contact between the electrodes and frozen soil, the hole should be filled to the level of the frozen surface with a solution of calcium chloride, which does not freeze at temperatures above minus 2-3°C.

Electric heating is attained at the low voltages (not more than 380 volts) widely used in buildings. As the process of frozen soil thawing goes on, there is a drop in the electrical resistance of the soil. That is why the electric heating should be performed with alternating and periodically lowered voltage, calculated on the basis of the capacity of the power source.

The thawing process is controlled by periodic observation of variations in electrical resistance, temperature of the thawing soil, and settlements of the site surface.

The suggested technology of the thawing stage provides for: (a) Maximum concentration of the heat source as well as for uniform thawing of the frozen massif of given configuration with minimum losses of heat; (b) economical use of electric power; (c) considerable consolidation of the thawing soils, and (d) uniform settlement of the structure during deformation of the thawing bowl in the course of building use.

The soil consolidation stage is carried out by means of electro-osmosis in soils [4, 5, 6].

According to the modern conception, the electro-osmotic consolidation is based on the capability of the electric current to cause a change of water head in water-saturated clayey soils and create an effective pressure on the soil grains.

The technology of the bed consolidation involves two variants: The first consists in applying direct current to thawing soils by means of electrodes systematically arranged and connected to the power source. The second involves application of direct current in combination with usual methods of water lowering.

The choice between these two variants is governed by geological conditions at the construction site.

The suggested electrode arrangement and connection includes two closed circuits of electrodes encompassing the construction site and parallel straight lines of electrodes inside each circuit. Electrodes in the external circuit are anodes; poles of inside electrode lines alternate in consecutive order.

If a water-lowering installation is used, all electrodes become well points.

As in the thawing stage, electrodes also function as vertical drains, thus speeding up consolidation.

Electro-osmotic consolidation is carried on with maximum vacuum in the header of the water-lowering installation. Voltage on the electrodes is determined through calculations depending on electro-osmotic properties of the soils and is specified in the project.

Consolidation is checked by periodic inspections of the surface settlement, water table level, and temperature of the soils.

The electrical method is characterized by the following technical and economic parameters. Duration of work: 2 to 3 months. Capacity of electric power source per sq m of the foundation: 0.1 to 0.3 kw. Expenditure of electric power, per cu m of treated soil: 60 to 80 kw hour.

The cost of bed treatment by the electrical method approximately equals the cost of maintaining the permafrozen state of the soil and is half the cost of removing and replacing the frozen soil.

In 1960-61, the described method of bed treatment was used in the city of Vorkuta in building two standard type, three story brick houses with 36 apartments. The beds were highly swollen morainal loamy soils containing silt.

The frozen state of the soils in the construction area was extremely unstable and was characterized by negative temperatures approximating zero. The permafrost surface occurred at various depths below the water table. Both buildings were partially on frozen soils and partially on thawed soils, the permafrozen subsoils being deep below.

During thawing and consolidation of the beds, uneven settlements took place; they ranged from 20 to 700 mm depending on the thickness of the thawed soil.

Most of the settlement (75%) occurred during thawing and the rest (25%) during supplementary consolidation.

The average relative settlement of the soil was approximately 45 mm per m.

Bed treatment by the electrical method in these projects resulted in the following: (a) Uniform thawing of the bed to about 10 m below the footings; (b) consolidation of heaved and thawed soils by eliminating cavities originated by the melting of numerous ice inclusions and reduction in total porosity of the soil (Table I); (c) uniform compressibility of soils under the buildings; (d) normal pressure on the foundation bed of 2.0 and 2.5 kg/sq cm and the feasibility of applying simple and well known methods of design and construction on usual (unfrozen) natural beds.

Table I. Density changes of the mineral part of soil in the bed of house No. 19 according to laboratory investigations

No. of test hole	Void ratio based on mean weight		Thickness of layer (m)
	Before prep.	After prep.	
1	0.497	0.437	7.0
3	0.639	0.519	5.9
5	0.596	0.491	5.6
7	0.781	0.521	5.3
8	0.628	0.490	6.7

During a year of use, the first of the two buildings showed quite uniform, attenuated settlements of about 50 mm and a virtual end of settlement in the last seven months.

Continuing measurements and observations at the two buildings showed that soils maintain above zero temperature throughout the whole of their thawing depth and that both buildings are in good condition.

Preparations are being made in the city of Vorkuta for applying the electrical method to five building projects.

HYDRAULIC METHOD OF THAWING AND CONSOLIDATION OF COARSE-GRAINED SOILS

Coarse-grained, and highly permeable, gravel-pebble soils in the Magadan region offer favorable conditions for the spread of thawing zones, arising in developing an area that first causes the degradation of permafrost under some structures and their utility connections, and then develop a total change in the permafrost-geological conditions.

On the other hand, the high permeability of the soils permits the application of hydraulic thawing with subsequent consolidation of soils by vibrators [7].

The method is attractive to builders because of its relative simplicity, the possibility of broad-scale mechanization of excavation operations, and dependability in use of the

buildings and structures.

The thawing of soils is performed by means of well-points made from hollow drill rods 33 mm in diameter, usually spaced at 3.5 to 4.0 m. Such an arrangement was established after the study of the thawing rate of soil around the points and a chosen effective time for the work.

The sinking of these well points to a depth of 6.5 to 7.0 m and more, if necessary, may be done with boring machines. After the soil around the well points has been thawed, the bar should be pulled for repeated application.

River water is used as a heat carrier in hydraulic thawing. Water is conveyed through mains (300 mm dia.), distribution lines (300 to 130 mm dia.), tapping lines (100 mm dia.), and lastly through rubber hoses connected to the well points.

For instance, preconstruction thawing was used in building a two-story, slag-block structure of 18 by 74 m area. Soil thawing was completed in a month.

All in all, 168 holes of 7 m depth were bored and 21,000 cu m of frozen soils were thawed. On the average, each well point operated 17.5 days and water consumption was 0.38 liters per sec. About 5 cu m of water at 10 to 12°C was needed per cu m of thawed soil.

Points were pulled with the help of vibrators, which reduce the cohesion between soil and pipes during the raising of the points. With that, a consolidation of the thawed soil took place. All thawed soil was consolidated by vibrators. The mean value of the settlement caused by the soil thawing was 150 mm but at certain points it reached 200 to 270 mm.

As a result of preconstruction improvement in bearing capacity of the foundation bed, it was possible to make a footing foundation at a depth of 1.8 to 2.0 m instead of 5 to 6 m for pier foundations suggested earlier. Owing to this innovation, cost of foundations was cut almost by half.

In case thawed soil after vibration maintained its swelling to some extent and could be additionally compacted under the weight of the building, the footing was slightly reinforced.

The building has been in use for over two years without any strain in the foundation.

In the northeastern USSR, three-story houses have been built on hydraulically-thawed foundation beds.

During hydraulic thawing, fine particles of soil are washed out, but this is not important for coarse-grained soils.

However, this method of preconstruction consolidation is not applicable in clayey soils.

HIGH-VOLTAGE ELECTRIC THAWING OF SOILS

Under conditions of the Magadan region the method of high-voltage electric thawing of soils is also used [8]. A pilot plant for electric heating of frozen soil was erected in 1961.

Power of this installation is 1260 kw and voltage 10 kv. By means of this installation, 3000 cu m of frozen soil was thawed and excavated (in building a dam for water storage) in April-May 1962.

The installation was connected to a 380 V transformer sub-station and had a regulating 1000 kva autotransformer. Two 630 kva transformers connected in parallel were used as a source of regulated high voltage. Soil heating was remotely controlled from a special control desk.

All components of the installation were mounted on automobile trailers and could be easily moved from one place to another.

For electrodes, pipes (51 mm dia.) were sunk into bored holes.

Electric heating capacity of the installation reached 100 cu m per shift with an expenditure of 20 kw hour for each cubic meter of coarse grained soil having ice inclusions.

The initial temperature of the frozen soil was -10 to -14°C.

Electric heating can also be used for loamy soils. As an additional advantage over hydraulic thawing, it allows foundation work to be carried out the year round.

REFERENCES

- [1] N. A. Tsytovich, M. I. Sumgin. Osnovaniya mekhaniki merzlykh gruntov, Publ. House, Acad. Sci. USSR, Moscow-Leningrad, 1937.
- [2] V. F. Zhukov. Predpostroyechnoye protaivaniye mnogoletnemerzlykh gornykh porod pri vozvedenii na nikh sooruzheniy, Publ. House, Acad. Sci. USSR, Moscow, 1958.
- [3] B. P. Gorbunov, L. I. Kurdenkov. "An Electrical Method for Preconstruction Thawing and Consolidation of Permanently Frozen Foundation Soils," Collection No. 50, Zakrepleniye gruntov, State Construction Publ. House, Moscow, 1962.
- [4] L. I. Kurdenkov. "Towards the Problem of Compacting Water-Saturated Clayey Soils by Direct Current," from Collection No. 31, Zakrepleniye gruntov, State Construction Publ. House, Moscow, 1957.
- [5] G. M. Lomize. "Basic Laws of Electroosmotic Drainage and Electrocompaction of Soils," Tr. soveshchaniya po inzhenerno-geologicheskim svoistvam gornykh porod i metody ikh izucheniya, Publ. House, Acad. Sci. USSR, Moscow, 1956, Vol. I, pp. 163-177.
- [6] L. Casagrande. "The Electroosmotic Stabilization of Soils," J. Boston Soc. Civil Eng., Vol. 39, No. 1, 1952.
- [7] A. N. Kuryachin. "Modern Methods of Construction and the Conduct of Operations on Permanently Frozen Soils," Kolyma, Magadan, 1963, No. 4.
- [8] M. A. Pokerskiy. Elektroprogreiv merzlogo grunta tokom vysokogo napryazheniya, Publ. House of Magadan Sovnarkhoz, 1963.

PILE FOUNDATIONS IN PERMAFROST

P. I. MEL'NIKOV, Siberian Branch of Permafrost Research Institute, USSR
S. S. VYALOV, V.A. Obruchev Permafrost Research Institute
O. V. SNEZHKO and G. F. SHISHKANOV, Krasnoyarsk Construction Institute

PILE FOUNDATION CONSTRUCTION METHODS

Increased loads on permafrost from multistory buildings and industrial structures have made it necessary to abandon heavy foundation columns with footings and bearing slabs and to adopt bearing piles. Some advantages are: They eliminate hard-earth excavation; industrialize and mechanize foundation construction so that it can be performed throughout the year; make fuller use of strength properties of frozen soils (adfreezing forces); and increase the reliability of the foundation in unexpected differential thaw of a frozen stratum. Pile foundations have come into widespread use in construction on frozen soils in the USSR—particularly where the permafrost can be preserved.

In the USSR, as early as the 1920's, wood piles were installed in frozen soils by steaming, but this was not common practice. Piles were installed mainly for wooden or small stone buildings. But within this decade, first in Yakutsk and later in Noril'sk and other localities, reinforced concrete piling is being used more frequently.

There are two main methods of sinking piles into frozen ground: (a) Preliminary thawing of frozen soils by steam for sinking the piles, and (b) preliminary boring of holes with a diameter larger than the cross-section of the pile and backfilling these holes with a soil suspension. The first method, developed in Yakutsk, is economical and efficient.

During one shift a team of three or four men steam the soil for installation of three piles to accommodate large cross sections (50 by 50 cm or larger) to support loads up to 100 tons or more.

The disadvantage of this method is that considerable heat and water are introduced into the ground as a result of steam condensation; this prolongs the period of adfreezing of the soils and retards restoration of natural negative temperatures. Adfreezing of the soil depends on the surrounding frozen strata and the season and may take from 15 days to a month or more.

This method becomes more complicated as the soil grain size increases, especially when there are gravel-cobble inclusions. Therefore, sinking piles by steaming can be used only in fine-grained soils with a mean temperature in the pile driving zone of -15°C and lower. The main disadvantage of this method—prolonged period of adfreezing—can be eliminated by removing the steamed soil and replacing it with a cooled soil suspension or by artificially cooling the steamed soil before or after pile installation.

In Noril'sk, reinforced concrete piles in boreholes are installed successfully in soils having a low negative temperature but containing coarse soils—ballast, cobbles, gravel—as well as for fine-grained soils when soil pile adfreezing is accelerated or when the temperature of the frozen stratum is not low enough.

The speed of sinking holes, 350 to 450 mm in diameter, by cable tools varies from 7 to 12 m per shift. Sinking speed can be increased by supplying hot water to the hole.

Adfreezing of the soil and pile proceeds fast enough so that in 10 to 15 days the pile can bear almost 75% of the design load.

Square and rectangular piles are used much more frequently than round ones. Shaped-section piles (double T, cross, etc.) [1, 2] have been used in recent years, reducing the volume of concrete and correspondingly the weight of the pile with a simultaneous increase in the lateral surface (adfreezing area) which increases the pile bearing capacity.

These methods of pile driving are successfully applied to a frozen soil with a low temperature. High temperature soils are more difficult because freezing of thawed soil proceeds very slowly and may last several months. When the temperature

of the soil is about 0°C no freezing takes place. Therefore, under these conditions, pile driving with preliminary steaming or boreholes backfilled with soil suspension can be done only if the soil suspension is artificially frozen by brine or cold air (in winter) circulating in specially installed pipes or in the hollow of the pile.

Experiments have shown, however, [3] that for frozen plastic soils, temperatures up to -1°C , piles can be driven into the frozen stratum without preliminary steaming, if soils are sufficiently plastic and contain no coarse-grained inclusions and thick ice-lenses—or into bored leader holes (0.7 to 0.9 of the pile diameter) if soils are more unfavorable. In these cases pile driving is similar to pile driving into non-frozen heavy clays. For example, in pile driving into sandy clay soils at -2°C , the set from one blow was 7.5 mm; the height of hammer fall was 1 m. Bearing capacities of piles driven directly into the soil or small-diameter holes appeared considerably higher than by any other method.

PHYSICAL PROCESSES IN THE GROUND DURING ADFREEZE TO PILE

A study of soil-pile adfreezing [3] shows:

In pile driving with preliminary steaming, water content of the thawed soil increases by 50 to 120%. The suspension put into the boreholes also has increased water content compared with surrounding frozen soil. The question arose as to whether this excess moistening decreases the strength of the frozen soil, thereby reducing the bearing capacity of the pile. However, pits dug near the pile and analyses of frozen soil samples (Fig. 1), as well as special laboratory experiments with pile models, show no decrease in soil strength or pile-bearing capacity. During freezing of thawed soil, moisture migration to the cold front occurs, and all excess moisture is drawn from the pile to the periphery. Thus, the final water content of the frozen soil near the pile appears close to the natural water content of the surrounding permafrost strata, regardless of the initial water content of the soil mass thawed by steam. If in its natural state the frozen soil had considerable ice inclusions and correspondingly high total water content (Fig. 1), the final water content of the frozen soil

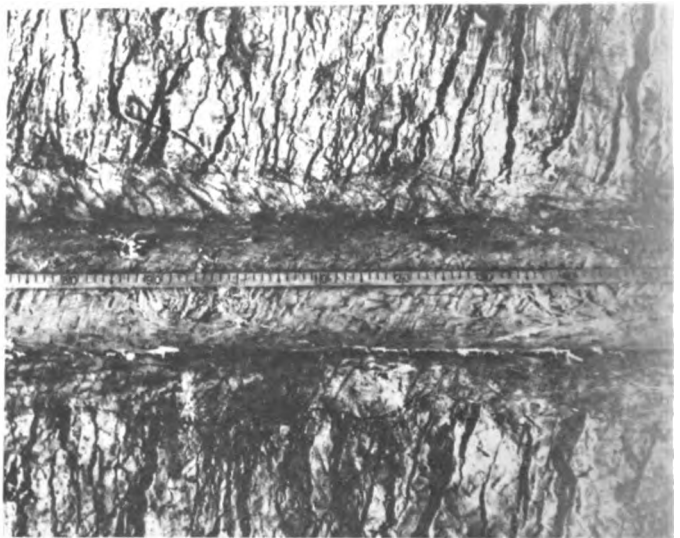

Fig. 1. Soil section near a pile driven after preliminary steaming

mass appears equal to the water content of mineral layers of the surrounding soil. This content is significantly lower than its total amount.

When thawed soil freezes a thin, sometimes discontinuous or continuous film of ice forms on the surface of the pile, reducing the adfreezing strength.

In embedding the pile by this or other methods into the frozen soil, tangential (adfreezing) stresses develop at the contact with its lateral surface.

$$s = c + \sigma_r f \quad (1)$$

where c is adfreeze stress of the frozen soil with the lateral surface of the pile and $\sigma_r f$ is friction force ($\sigma_r =$ lateral pressure).

Cohesion (adfreezing) stresses appear because of adfreezing of the surrounding soil with the body of the pile and depend on the type and temperature of the soil and the pile material. Friction stresses develop under the influence of radial stresses (σ_r) in the surrounding soil and depend on the value of these stresses and the coefficient of friction (f) of soil against pile. Stresses (σ_r) change because of relaxation from initial, maximum, to final values. The relationship between cohesion and friction stresses depends considerably on the method of embedding the pile. In installing piles into steamed holes or bored holes backfilled with soil suspension, the chief forces are adfreezing (cohesion).

Friction stresses develop only from small radial stresses caused by the volumetric expansion of water in the soil mass when it freezes and from lateral pressure of the soil. In driving piles into boreholes smaller than the pile or directly into the frozen stratum, the principal stresses are frictional because, in this method, high radial stresses result from compaction of the surrounding soil. The adfreezing (cohesion) stresses are caused by adfreezing of the thin soil layer adjacent to the pile and thawed as a result of pile driving.

Table I presents data from experiments [3] on the effect of pile driving (into high temperature frozen plastic soils) on shear resistance.

Table I. Ultimate shear resistance of soils s_{∞} along lateral pile surface in sandy-silty soil (-0.2°C and 30 to 35% water content)

Method of pile driving	s_{∞} kg/sq cm
Sunk into steamed borehole (diameter larger than pile)	0.1
Driven by pile driver into steamed hole (diameter smaller than pile)	0.2
Driven by pile driver into a bored hole (diameter smaller than pile)	0.3
Driven by pile driver directly into frozen soil	0.4

Shear resistance of soil along a pile as well as other characteristics of frozen soil depend on the duration of load action. ("Rheology of Frozen Soils," in this volume, Session 6)

Experiments with punching in and withdrawing rods embedded in frozen soil [3] by this or other methods showed that displacement (settlement) of piles under constant loads yields typical creep curves (Fig. 2a). Displacement of a pile proceeds initially with diminishing speed, later with almost constant speed, and finally increases abruptly and the rod collapses completely. The smaller the load is, the later the failure occurs.

The relation between the value of specific load (referred to area of pile lateral surface) and the time when the complete failure occurs is reflected by curves of long term strength (Fig. 2b). The intercept on the ordinate of the plot indicates instantaneous shear resistance (s_0) of the ground along the rod and the asymptotic ordinate indicates maximum long term resistance (s_{∞}). The change in shear resistance (s) as a function of the time of the load action is determined by ("Rheology of Frozen Soils," in this volume, Session 6)

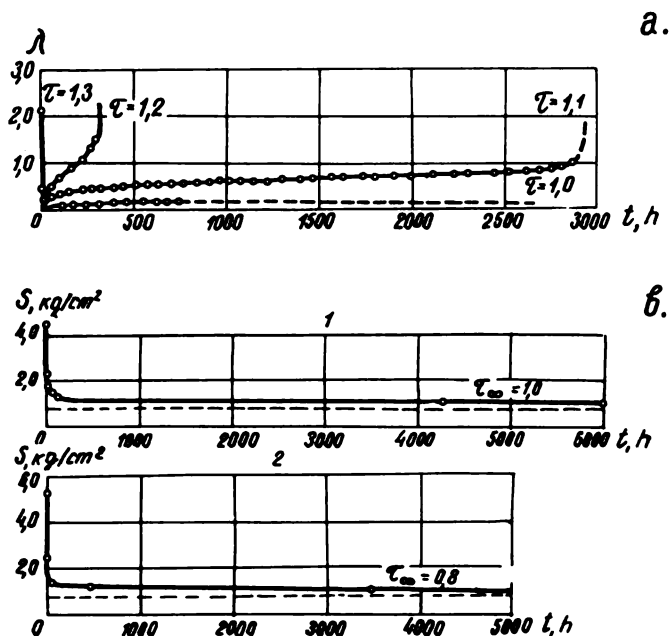

Fig. 2. Pull-out resistance testing of rods embedded in frozen soil: a. Creep curves, b. ultimate strength curves; 1 - silty soil, -0.4°C , rods driven into small diameter boreholes; 2 - the same, rods frozen into soil

$$s(t) = \frac{\beta}{\ln \frac{t}{B}} \quad (2)$$

where β and B are parameters determined by experiment.

Shear resistance depends on geometrical dimensions of the pile; therefore, design values of s should be determined by tests conducted under actual conditions.

PILE PERFORMANCE IN FROZEN SOILS

Piles in frozen soils act as though suspended carrying the load by the resistance to soil shear along the lateral pile surface (T) and by soil resistance under the tip of the latter (R).

Investigations [3] have shown that at first, when the load is insignificant or only slight, damped settlements caused by soil compaction occur, since bonds (cohesion) of soil to lateral pile surface are not broken, and the load is carried by tangential forces (T). As load increases and settlement develops, soil under the pile tip becomes important. At a certain load value, when tangential stresses (τ_r) along the pile exceed the shear resistance of the soil along the pile (s_{∞}), the soil-pile bonds break and the rod slips. A small load is applied to the soil under the pile tip, or the soil wedge formed under the tip, if it is flat, moves aside the surrounding soil, and the pile sinks into the latter as into a viscous plastic medium; the settlement of the pile becomes undamped (Fig. 3). This state is ultimate and determines the bearing

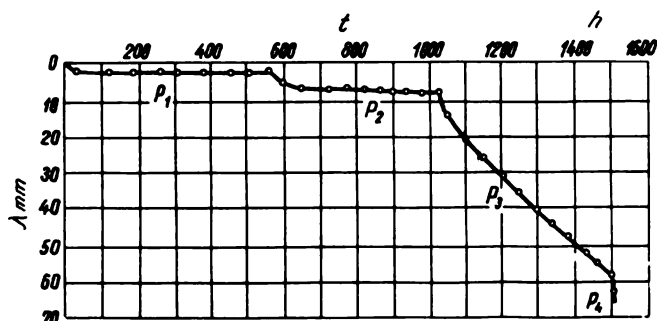

Fig. 3. Settlement versus time curve for incremental load testing of a pile

capacity of a single pile, i.e., its ultimate load.

$$P_{\infty} = T_{\infty} + R_{\infty}$$

where

$$T_{\infty} = \int_0^l \tau \, u \, dy \text{ and } R_{\infty} = \sigma F$$

where τ_y are tangential stresses along the pile; σ are normal stresses under its tip (in the state of limiting equilibrium) l is length of the pile; u is perimeter; and F is cross-sectional area.

The relation between load (P) and settlement of the pile (λ) is nonlinear

$$P = A(t) \lambda^m \quad (4)$$

where A and m are parameters, A depending on the time of load action; function $A(t)$ reflects development of settlement with time. For final stabilized settlements $A = A_{\infty}$ is constant.

When the load exceeds the ultimate value P_{∞} the developing undamped deformations obey the law

$$\frac{d\lambda}{dt} = k (P - P_{\infty})^{\mu} \quad (5)$$

where k and μ are parameters; μ may be close to unity.

To investigate the law of distribution of tangential stresses along the pile, K. E. Yegerev [1] designed a test pile in the form of a hollow pipe modeling a pile. Strain-gage sensing elements attached to this pipe allowed measurement of vertical compressive stresses (σ_y) in the pipe wall. In one variation a continuous duralumin pipe was used; in another, a pipe consisting of reinforced-concrete rings. Tangential stresses (τ_y) are found by solving the equilibrium equation

$$\int_0^y \tau_y \, u \, dy - (P - f \sigma_y) = 0 \quad (6)$$

where P is acting load; u is perimeter of the pipe, and f is cross-sectional area of the pipe (wall).

Experiments performed in Yakutsk show that the curve of distribution of τ_y is nonlinear and changes with an increase in load and in time as a result of stress relaxation. However, because of insufficient knowledge of this problem, practical calculations are based on the average value of τ_y (along the pile length) assuming it to be equal to the ultimate shear resistance of the soil along the lateral surface of the pile (strength of adfreezing), ($\tau_y = s_{\infty}$). Reactive stresses under the tip of the pile are assumed to equal the ultimate resistance of the soil to the sinking of the pile ($\sigma = p_{\infty}$). This assumption is also justified because in the state of limiting equilibrium, which is calculated, the curve of tangential stresses probably flattens out. In this case, of course, one should consider the change in s_{∞} along the pile length caused by the change of soil temperature with depth.

DESIGN OF PILE FOUNDATIONS

As mentioned, the design of pile foundations in frozen soils [3, 4, 5] is based on strength, proceeding from consideration of the state of limiting equilibrium, according to (3).

Design resistance of a single pile subjected to an axial load is determined by

$$P = k (u \sum s_{\infty(i)} l_{(i)} + F p_{\infty} + u q l_q) \quad (7)$$

where $k = 0.7$ to 0.8 (possible heterogeneity of the soil)

u is foundation perimeter on the surface of adfreezing or shear (cm)

$s_{\infty(i)}$ is ultimate shear resistance of frozen soil on the lateral pile surface corresponding to design temperature in the i th layer (kg/sq cm); determined from field data

$\sum l_{(i)}$ is design depth of pile embedment into frozen soil (cm)

F is cross-sectional area of the pile at the tip (cm²)

p_{∞} is ultimate resistance of frozen soil under pile tip (kg/sq cm); determined from field data or, for preliminary calculations, from Table II

q is ultimate resistance to friction of thawed soil along

lateral surface of the foundation within limits of design depth of thawing (kg/sq cm). It is determined from testing or standard data for thawed soils

l_q is length of pile portion above the design depth of upper boundary of the permafrost (cm).

The last term in (7) concerns piles driven directly into the frozen stratum or into small diameter holes in case of non-heaving soils in the active layer. Design resistance of a pile subjected to pulling forces is determined by (7) without considering the first and third terms.

The strength calculation is satisfactory if the load acting on the pile does not exceed the design resistance of the ground.

When the soil is subjected to short-term loads (cranes, rolling stock, wind, etc.), the special frozen soil rheological properties permit the use of a load reduction factor of 0.75 to 0.5 [5].

Since a disturbance of the limiting equilibrium of frozen soils in contrast to thawed soils does not cause sudden settlements (but only development of undamped though slow sinking of the pile), the design load determined by (7) may be somewhat exceeded. Then the calculation should be performed by using equations found in [5].

When piles are driven into high-temperature soils, such calculation is necessary regardless of the design load value. The calculation determines the load at which pile settlement, during use of the structure, does not exceed the maximum permissible value. The latter is determined from standards, depending on the sensitivity of the structures to deformation.

When dealing with an active layer of clay soils, the following equation is used to calculate the forces due to soil heave caused by seasonal freezing.

$$n_1 u \tau - n_2 N \leq u \sum s_{\infty(i)} l_{(i)} \quad (8)$$

where N is vertical component of design load acting on the piles, considering the direction of its action (kg); τ is relative heaving force (kg/cm) assumed without test data to be 90 kg per linear cm of the foundation perimeter for an active layer 1.0 m thick, and 150 kg/cm for an active layer over 1.0 m; n_1 and n_2 are coefficients assumed to be $n_1 = 1.1$ and $n_2 = 0.9$.

The peculiarity of pile calculations in frozen soils is that the resistance of these soils and consequently the bearing capacity of the piles are not constant values but vary during the year, depending on the permafrost temperature and the state of the active layer.

Maximum bearing capacity is achieved in winter when the layer, thawed during the season, freezes fully and soil temperature is lowest. In autumn, when seasonal thawing of the soil ceases, and permafrost in the upper layer reaches its maximum temperature, the bearing capacity of the pile is lowest. This period of maximum thawing of the active layer is adopted as the design period for calculating temperature distribution within the permafrost. Thus, the rated characteristics of frozen soil strength (which depend on temperature) are established.

Soil design temperature (θ_n) is determined from temperature observation data in natural conditions and corrected for the thermal effect of buildings, or determined on the basis of heat engineering calculations.

For approximate calculations of soil design temperature, V. V. Dokuchaev suggested the following empirical equation.

$$\theta_n = 0.17 h \theta_0 \quad (9)$$

where θ_0 is temperature at the depth of the zone with annual zero amplitude of temperature fluctuations, and h is depth from design surface of permafrost to the horizon for which the design temperature is determined.

The equation is applicable only when θ_0 is below -2°C . Design values of s_{∞} and p_{∞} included in (7) are determined from data obtained in testing piles under experimental loads at temperatures corresponding to the design loads or for approximate calculations from tabular data.

Shear resistance of frozen soil along the pile (s_{∞}) depends

on the type of soil, its water content, density, and temperature. The impossibility of considering all these factors as well as their change (depending on pile emplacement method) does not yet allow determination of s_{∞} with sufficient accuracy. In existing USSR standards [4, 5] values of s_{∞} for tentative calculations are assumed to depend only on soil temperature (Table II). These values were obtained by S. S. Vyalov [3] from field data for piles frozen (with steaming) into sandy-clay soils.

Table II. Shear resistance of frozen soil along the lateral surface of pile s_{∞}

Soil temp. (°C)	-0.5	-1.0	-1.5	-2.0	-2.5	-3.0	-3.5	-4.0 and lower
s_{∞} (kg/sq cm)	0.5	1.01	1.25	1.5	1.75	2.0	2.2	2.5

These data may be refined on the basis of s_{∞} from tests or long experience in construction. For sands, values of s_{∞} are probably higher.

In calculating driven and backfilled piles, values of p_{∞} given above decrease by 50% for a soil layer containing ice as laminae and lenses over 20 cm thick and with total thickness of more than 50% of the layer.

Ultimate resistance of frozen soils under the pile tip (p_{∞}) is determined from test data obtained by depth settlement plates, from testing of piles with hydraulic dynamometers on the tips or approximately, using the following equation [3],

$$p_{\infty} = H_{\infty} + \gamma h \quad (10)$$

where $H_{\infty} = \frac{Q}{\pi d \lambda_{\infty}}$ kg/sq cm, ultimate resistance of frozen soil (at the level of the pile tip) to the pressure of the ball indenter by the method of N. A. Tsytoovich; Q is load on the ball (kg); d is diameter of the ball (cm); λ_{∞} is final stabilized depth of impression (settlement) of the ball (cm); γ is unit weight of the soil (kg/cu cm); and h is depth of driven pile from the soil surface (cm).

The share of the load applied to the soil at the pile tip depends on the distribution of soil temperature throughout the depth, the method of pile driving, and the relation between pile length and cross-section. For tentative calculations the value of ultimate resistance of frozen soils under the pile tip may be taken from Table III which is substantiated in [5].

Table III. Ultimate resistances of frozen soils under pile tip (p_{∞})

Types	P_{∞} (kg/sq cm °C near tip)								-4.0 and lower
	-0.5	-1.0	-1.5	-2.0	-2.5	-3.0	-3.5		
Coarse-grained soils	35.0	37.5	40.0	42.5	42.5	42.5	42.5	42.5	
Sandy soils (dense)	25.0	26.0	28.0	30.0	30.0	30.0	30.0	30.0	
Clayey soils and silty sands without visible ice inclusions (layers)	7.0	9.0	11.0	13.0	15.0	20.0	20.0	20.0	
All soils with visible ice (layers) in 0.5 m layer under tip	4.0	4.5	5.0	6.0	7.0	8.0	9.0	10.0	

When the pile rests on an ice layer its resistance is neglected.

In soils with more than 0.1% salt concentration, p_{∞} is determined from special investigations.

DESIGN EXAMPLES

Examples of some designs for using pile foundations in frozen

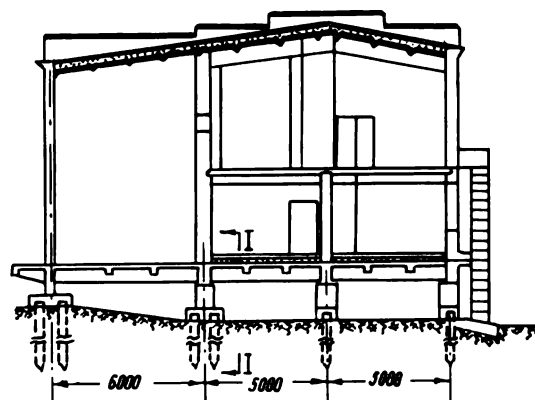

Fig. 4. Water pipeline trestle on pile foundation

soils are given below [2].

Fig. 4 shows the application of piles in erecting a trestle for water pipelines. Trestles for product pipelines, district heating lines, and other engineering utilities are arranged similarly. Piles are effectively used even in special

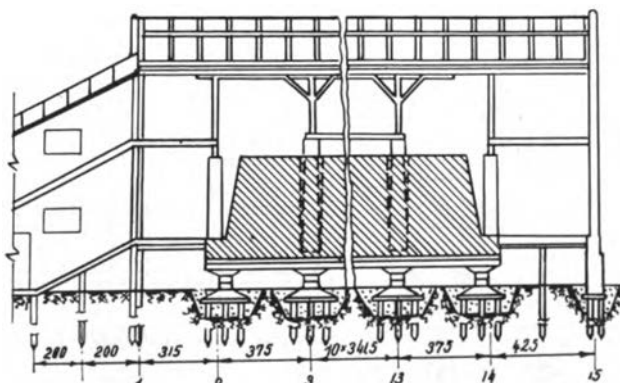

Fig. 5. Brick factory building on pile foundation

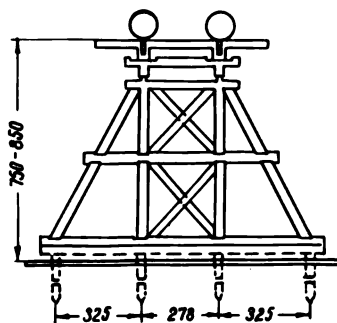

Fig. 6. Industrial structure framework on pile foundation

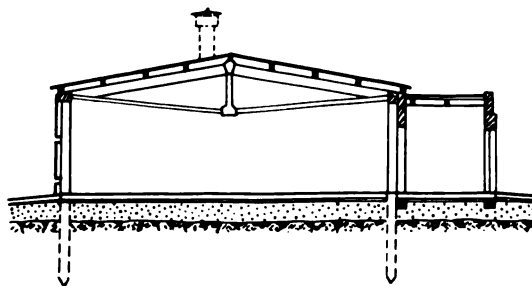

Fig. 7. Stepdown substation on pile foundation

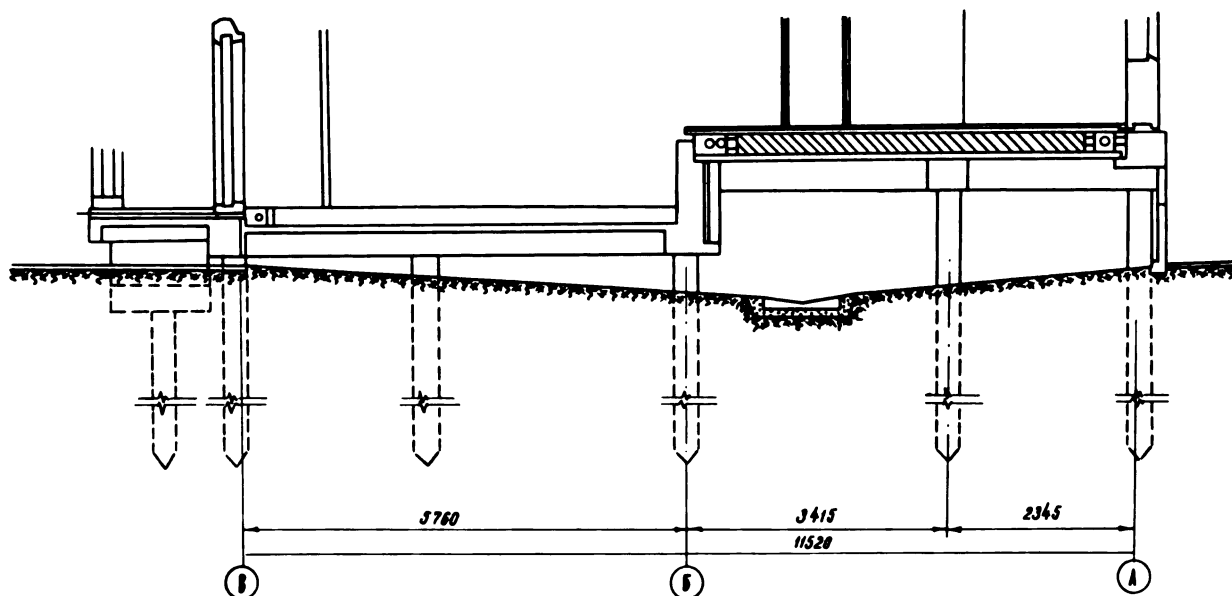

Fig. 8. Pile foundation of a large panel apartment building

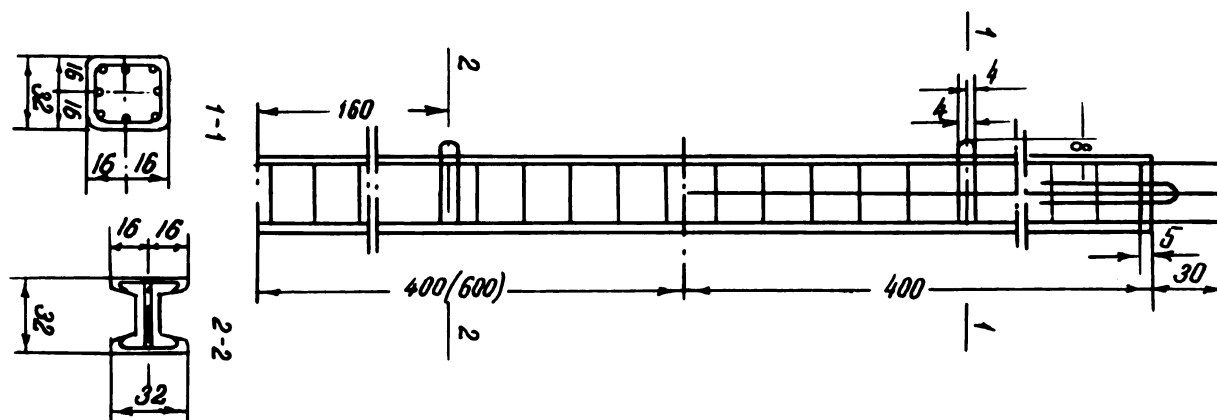

Fig. 9. Square double-T pile

industries involving high temperatures. Fig. 5 shows the schematic section of a brick factory. Noteworthy is the foundation construction for brick-firing furnaces. Although built in the 1930's, no deformations have been noted.

Fig. 6 shows the design of pile foundations for light buildings with internal temperature conditions favorable for preserving the frozen state. In this design, reinforced-concrete piles support the building as well as the suspended wall panels. An example of the structure of a main stepdown power substation on piles frozen into the soil is shown in Fig. 7. The structure was built in a mountain area, on a site formed of broken rocks with ice laminae.

Completely prefabricated industrial buildings of various designs are becoming more and more widespread. Fig. 8 shows the design of a pile foundation for the most popular series of large frameless panel houses with load-bearing outer walls. Piles are arranged under bearing transverse walls—five piles in one transverse row.

Distance between transverse rows is 2.6 to 3.2 m. The load supported by the piles in this arrangement is 40 to 50 tons. For a 5-story house with 80 apartments, 135 piles are required. An original design for utilities provided for a ventilated substructure and waterproofing measures. Such buildings have been erected in Noril'sk since 1962 without problems.

Fig. 9 shows the design of a square double-T pile used in the town of Noril'sk. Using these instead of cylindrical solid

piles lowers costs and permits vibration of the backfill, thus increasing the bearing capacity of the piles.

Pile foundations, as the most effective type of foundation on permafrost, require special attention from investigators and engineers—especially, because of the many unsolved and disputable problems in this field. The following are appropriate areas for discussion:

- (a) The most effective methods and areas of application of pile driving in permafrost soils under different soil conditions;
- (b) best types of piles;
- (c) methods for calculating bearing capacity of piles and allowing for temperature conditions of frozen soils;
- (d) values of design characteristics of soil resistance along the lateral surface of the pile and under its tip; and
- (e) experimental data on bearing capacity of the pile, relationship between the loads acting on the lateral surface of a pile, and its tip.

REFERENCES

- [1] K. Ye. Yegerev. *Elektrotenzometriya v issledovaniyakh vzaimodeystviya fundamentov s merzlymi gruntami*, Acad. Sci. USSR, 1961.
- [2] M. V. Kim, et al. *Vozvedeniye fundamentov v usloviyakh vechnomerzlykh gruntov*, State Publ. House, 1962.

[3] S. S. Vyalov. Reologicheskiye svoystva i nesushchaya sposobnost' merzlykh gruntov, Acad. Sci. USSR Publ. House, 1959, [Rheological properties and bearing capacity of frozen ground, USA CRREL Transl. No. 74, 1965].

[4] Tekhnicheskiye usloviya proyektirovaniya osnovaniy i fundamentov na vechnomerzlykh gruntakh, SN 91-60,

[Technical conditions for design of foundations on permafrost], State Publ. House, 1960, Tech. transl. 1033, Natl. Res. Coun., Canada, 1962.

[5] Stroitel'stvo v rayonakh Vostochnoy Sibiri i Kraynego Severa, Sb. 3, articles by M. V. Kim and O. V. Snezhko, M. V. Kim and G. F. Shishkanov; Krasnoyarsk, 1963.

MODERATORS' REPORT

NORMAN W. RADFORTH—Soils and Vegetation—Papers contributed for this session were valuable not only because of reasons inherent to the subject they exploited—but because they also afforded background for integrating understanding of our subject as a whole.

A survey of papers and discussions offered in Section 2a reveals little direct evidence for answering two major questions of interest to the conference as a whole, namely: Where precisely is the southern limit of permafrost? And how does one determine when to expect permafrost?

There was a single claim that on organic terrain the appearance of lichenaceous cover on south-to-north traverses coincides with incidence of permafrost. There were two other qualified claims for recognition of characteristic changes in vegetation experienced as one moved away from mineral or organic terrain underlain by permafrost, and in one case polyploidy is thought to occur with higher incidence where there is permafrost. It would seem that these observations signify working hypotheses worth emphasizing for future exploration.

To assist in evaluating the contributions, the papers were segregated and discussed for convenience under three headings: (a) Soils, in permafrost country; (b) vegetation in relation to soils, in permafrost country; and (c) vegetation in permafrost country.

Pedological processes and dynamics evidently hold promise for contributing a new basis of understanding in permafrost relations. The mechanics of surface-salt accumulation with upward movement of water and the association of this with other factors delineates evolution in soils and shows promise of application. The association of soil salinity relations with the active frost is suggested as a basis for useful field comparisons and determination of site history. At our present state of knowledge, soil genesis in permafrost country as related to peculiar geomorphic conditions offers a medium of understanding as attractive as that gained by correlating plant communities with soil types, and can even be used where no plants occur.

There are, on the other hand, more than mere suggestions of interrelationship between vegetation and permafrost soil. Occupancy of terrain by vegetation is significant in influencing the heat and water relations of the soil, and when soil temperatures are depressed as an annual mean to just below 0°C, vegetal cover is thought to exercise control on permafrost development and endurance. Also, sensing devices bring new promise of revealing differentials in soil-water regime once corrections are made for the effect of vegetal cover differences.

Where our contributions relate primarily to vegetation in permafrost country, frequently, occurrence of vegetal phenomena associates with patterned ground. The nonsorted nets of Washburn have been reidentified and evaluated on an ontogenetic basis. The vegetation which is associated with them, and particularly as a constituent of vegetation, willows, has been effectively used to arrange the geomorphic process of hummock formation on a measureable time axis.

Three authors recognize hummocks of two shapes; one type has nearly vertical sides, the other has sloping sides. The conference has afforded opportunity for these authors to review the geomorphic and vegetal features of the phenomena and to arrive at a joint understanding of probable origin and of nomenclature for these features.

In all cases the ontogeny of the configuration, biologically expressed, correlates with water relations in the landscape. In some instances the studies suggested presence of time attenuated and specialized, though universally applicable, erosional effects. In other instances the units arose amid

biological response to deposition of either mineral increment (loess) or organic matter contributed *in situ*. Catenaes may exist between them.

The segregation of plant life both from a species and growth form aspect is in accord with physiographic delineation, but despite this, most plant types in the high arctic show wide adaptability to site factors when geomorphic factors are not limiting.

Where shallow peat is forming, segregation is more marked, and the structure of the peaty deposition rarely shows change in the succession.

Microtopographic features of high-arctic young-organic terrain quickly develop and resemble those of older and deeper organic overburden characterizing the more southern expanses of permafrost country, a circumstance that is discernable even through aerial inspection by reference to patterns.

By reason of the several matters emphasized, and in some cases collated, progress is in evidence for our section and points to new principles and exciting new topics for permafrost research. Better understanding of the influence of vegetation in a permafrost environment on both mineral and organic terrain has brought gain, but it has also cautioned us on the dangers and intricacies involved in measurement of vegetal effects. We are now somewhat wiser on the subject of where, when, and how to measure for comparative studies on heat-water relations.

In light of anticipated resolutions of the conference as a whole, the section does not wish to sponsor proposals of its own save in one instance. We recommend that the next conference be held in permafrost country. There may be other matters which our participants will wish to submit to an ensuing conference committee if and when this is established.

APPENDIX

Soils

Tedrow was asked to initiate discussion of three papers concerned with soils (Tedrow, Ugolini, O'Sullivan). He did this first by raising the question of correlation of plant communities with soil types. This led him to the basic problem of soil genesis in the Arctic, as it is conditioned by geomorphic processes associated with the cold climate.

Cameron asked Tedrow to elaborate on the dating of the subsurface peat layer found in the Alaska soils. Tedrow said it was widespread in Arctic North America and also occurs in Northern Siberia. In Alaska it is found in the foothills of the north slope of the Brooks Range and also on the arctic coastal plain. He does not know its origin in detail. Pollen in it suggests a vegetation not much different from that of today. He thinks it indicates a former deeper thaw, and therefore a somewhat warmer climate. Carbon-14 gives dates of 8000 to 10,000 years.

Raup asked O'Sullivan whether the deep leaching of some deposits near the arctic shore that had been formerly impregnated with sea water could be dated. O'Sullivan was most hesitant to commit himself, but finally came up with a "maybe" date of 10,000 years.

Brown raised the question of "values" for vegetative cover, to be used in dealing with frost problems in the soil. Nothing seems to have come of this question.

Ugolini spoke of working in a region with essentially no vegetation. About the only organic accumulations are local ones of guano, the significance of which, for dating, he has not studied.

Assur said he doubted that Tedrow was right about the cli-

mate being different when the peat was accumulated. Tedrow said that there was evidence of frost action in the peat, and that the organic material was always covered by an overburden of some kind of inorganic material.

Hopkins mentioned good data he and others have from the Seward Peninsula showing that the period of deep thaw was between 10,000 and 7500 years ago.

Vegetation-Soil Reaction

Benninghoff talked on the influence of the forms of plants on the nature of the vegetation and in turn upon frost action and permafrost. He asked Brown to comment on his studies of the effects of differing forms.

Brown then commented briefly on relative reflectivity of lichens versus mosses versus herbaceous plants. He also noted the "spruce islands" in the Hudson Bay Lowlands, saying they are underlain by permafrost, as are also muskegs in the northern prairie provinces.

Radforth noted that ice was found in peat in central Ontario.

Beschel asked Benninghoff about methods of measuring heat transfer in vegetative cover, and said that he considered water content an all-important factor. Benninghoff outlined a possible system of instrumentation, or perhaps research for instrumentation.

Beschel said that he differed with Radforth in that he found no peat hummocks in Axel Heiberg (high arctic) and that he differed with Raup in finding no hummocks of the kind the latter described. Beschel and Raup went over their hummock data together. It is obvious, and agreed, that Beschel did not see Raup's "turf" hummocks in Axel Heiberg. Raup saw some of his kind at Mastersvig, but most of them he did not see. Beschel agrees that Raup's sequence is valid but thinks his time spans may be longer. Beschel's hummock interpretations at Axel Heiberg appear reasonable in Raup's view.

From a comparison of photographs, Radforth and Beschel later agreed that mound-shaped configurations of organic matter do occur on Ellsmere Island but the mound configurations of Beschel are not necessarily genetically the same as those of Radforth, especially in that those of Beschel may arise on steep slopes whereas those reported by Radforth do not.

Radforth is of the opinion that the mounding he has observed in very shallow organic terrain in the high arctic may be similarly constituted to that experienced by Raup since many contain willows, are in areas of changing water regime, and are of the appropriate shape and size. Raup concurs with some of the reasoning but has some reservations because his configurations may have mineral soil cores and eventually degenerate with time.

TROY L. PÉWÉ and FRITZ MÜLLER—Massive Ground Ice in Permafrost—Massive ground ice bodies not only constitute interesting phenomena in permafrost but have direct importance in engineering construction in the polar latitudes. These large ground ice masses, some extending as much as a kilometer, are of controversial origin and are responsible for some of the most striking micro- and meso-relief forms in the arctic terrain.

Slight changes in climatic conditions or interference by man in the thermal regime of the ground can cause extensive and spectacular deformation of engineering efforts. The interpretation of many surface forms in now temperate latitudes as glacial dead ice holes or as fossil ice-wedges, etc., will have to be reexamined in light of accomplished and proposed research on existing massive ground ice.

TERMINOLOGY AND CLASSIFICATION

Schumskiy and Vtyurin [1] present a classification based on genetic principles. Unfortunately the origins of many ground ice masses are not yet well enough known to place them in such a classification. There is an immediate need for more detailed knowledge of the physical properties and structural peculiarities of the various types of massive ground ice, as well as climatic conditions under which they grew. For the

time being (and as a step toward a final answer) a descriptive terminology and classification on the basis of physical and chemical properties is desirable.

At present two types of massive ground ice can be distinguished: (1) Pingo ice—characterized by translucent, large size, simple-shaped crystals and by the occasional scarcity or more often the complete absence of internal structures. (2) Ice-wedge ice—consisting of small-size crystals and showing distinct vertical to inclined foliation. A considerable amount of mineral and organic material is aligned with the foliation.

So far all other varieties of massive ground ice must be lumped together with only the certainty that there are more types to be distinguished when more complete descriptions and quantitative data are available. The possible Taber ice is in this group. The thick tabular sheets of ground ice characterized by horizontal layering with frequent dirty ice layers reported from the Mackenzie Delta, northeast Greenland, and various places in Siberia may be another distinct type.

Pingos

The intrapermafrost, ice-cored hills referred to as pingos [2] or bulgunniakhi, are distinctly different from seasonal frost mounds, mud volcanoes, peat hummocks, winter-ice blisters in the active layer or in the ice cover of rivers and lakes. So far two types of pingos have been distinguished: Closed system, Mackenzie type, and open system, East Greenland type [3]. Papers at this conference do not contribute new knowledge of the physical properties of pingo ice or the methods of its formation. They are, however, a valuable addition to information on the distribution of pingos in North America, and on their age.

Holmes, Hopkins, and Foster [1] have reported the discovery of hundreds of open-system pingos in the unglaciated interior of Alaska, in areas where permafrost is discontinuous. A few new findings of pingos in Canada, largely in the newly built land at the mouth of the Mackenzie River, have been described by Mackay [1]. These are of the closed-system type.

There is still a surprising scarcity of pingo records for the Canadian Shield and for most of the Canadian Archipelago. One open-system pingo was reported in the Thelon Valley by Craig [4] and one pingo of each type was found on Axel Heiberg Island (80°N, 90°W) by Müller [3].

The present distribution pattern suggests that open-system pingos occur predominantly in the mountainous or hilly areas of the discontinuous permafrost zone. Closed-system pingos are found almost exclusively in areas of continuous permafrost [5], generally in lowlands with thick alluvial deposits. So far no pingos have been reported for certain large areas where conditions would appear to be favorable for their development. More surveys of these areas may bring some to light.

Holmes, Hopkins, and Foster [1] have emphasized that the formation of existing pingos cannot be related to any single climatic period, but rather it seems that they have formed throughout postglacial times and, in unglaciated areas, even during Pleistocene time.

Ice-Wedges

The major discussion concerning ice-wedges during the past century has been on their origin. There is now almost universal agreement in support of the thermal-contraction crack theory in general, although differences of opinion still exist on several details. Taber's [6] hypothesis for the growth of ice-wedges is no longer tenable, and Schenk [1] in still supporting it has failed to take into consideration the more recent progress in this field.

Although the thermal-contraction crack theory of origin of ice-wedges is more than 60 years old, only recently has detailed consideration been given to the mechanics of cracking. Lachenbruch [1] of the United States, and Dostovalov [1] of the Soviet Union, both are active in this field but their approaches to the problem differ.

Both of their papers explain many characteristics of ice-

wedge polygons by mathematical analyses of the thermal contraction that causes them. Lachenbruch's paper shows that a nonlinear relationship between stress and strain is the more probable for frequency of cracking than the elastic relationship assumed by Dostovalov. Lachenbruch also shows that the orthogonality of the crack intersections can be produced by the unrelieved stress remaining after an initial crack is formed and does not require that the temperature field be distorted by convection within the initial crack as Dostovalov has proposed.

Investigations of the physical properties of ice-wedges have been initiated. Petrofabrics of ice-wedges have been made in Alaska, Greenland, and Russia, but most of the material is not yet published.

Geochemical analysis of ice-wedges and associated sediments appears to be one of the most fruitful lines of investigation in which only a beginning has been made. Brown's [1] recent work on the chemistry of ice-wedges and associated sediments demonstrates that the chemical regime of ice-wedges offers a potential tool for further study of the complex mechanism of wedge-ice growth.

The first report of this work shows that the ionic content of the ice and residue in the wedge is not closely related to that of the adjacent sediments. It is felt that sediment residue in the ice-wedges was in part incorporated through the sides of the wedges. O'Sullivan's [1] work in the geochemistry of soils near Point Barrow complements that of Brown [1].

Although the widespread distribution of ice-wedges in North America is known, no detailed or even reconnaissance distribution map is available. The first step toward this end has been made by Péwé [1] in grouping ice-wedges in Alaska into geographical areas according to their degree of activity—actively growing, dormant, or inactive.

Active ice-wedges appear to be almost entirely limited to the continuous permafrost area, and inactive wedges, to the discontinuous permafrost area. From the now known facts of distribution it is evident that some of the climatic parameters for ice-wedge growth can be deduced. In the area of active ice-wedges the mean annual air temperature ranges from about -6° to -8°C , at the southern limit to at least -12°C in northern Alaska. The minimum winter temperature at the top of the permafrost (top of the ice-wedge) for the same area is -15°C in the south and at least -30°C in the north. Inactive ice-wedges in central Alaska evidently originated during a colder period than the present one, possibly during the last ice age.

An interesting extension of this reasoning might suggest that the distribution of ice-wedges in Canada would be different from that in unglaciated Alaska since most of the permafrost areas of Canada were covered by glacial ice at the time when the climate was rigorous enough for ice-wedges to form.

Other Massive Ice Types

Large masses of ice occur in the permafrost, other than those in pingos, wedges, or buried ice, and are only now beginning to be investigated. Large horizontal masses of relatively clear ice up to 1 km long and 8 m in thickness are known from the Mackenzie Delta. However, their origin, age, and physical properties have not yet been determined. Cave and shaft fillings in permafrost are also known but have not yet been studied in detail.

Future Research on Massive Ground Ice

Size and shape—Although the dimensions and configurations of ice-wedges in central Alaska exposed during mining investigations are well-known, exact measurements of massive ice bodies elsewhere are little known as exposures are generally limited to sea and river banks. Close-net gravity and geodetic resistivity investigations together with short-distance seismic mapping and drilling should be undertaken on massive ground ice in the Arctic and Antarctic. Photogrammetric surveys are suggested where three-dimensional exposures are available.

Thermal, chemical, and physical properties—Perhaps the greatest present need in the study of massive ground ice is for quantitative information on the ice bodies and the ice itself.

Geochemical analyses of all types of massive ice are needed, not only of vertically selected samples but also of samples taken horizontally and in the third dimension. As suggested by Schenk, the wedge ice should be analyzed for radioactive elements released during the last 18 years. Radioactive tracers can be put into surface water and snow and later located in the new ice-wedge growth.

The composition and pressure of the gas in air bubbles in ground ice should be investigated as a possible means of shedding light on its origin and history. Information should also be collected on bubble size, shape, and distribution.

The study of the geophysical properties of massive ground ice may be significant in an evaluation of the ice. For example, resistivity seems to give information on the amount of metamorphism the ice has undergone, although such investigations are only in their beginning phases.

A further concentrated application of petrofabrics to all types of massive ground ice is needed. So far no detailed work has been done in thermal studies on massive ice.

These suggested studies should be undertaken with a specific objective in mind, as for example: (a) Comparison of properties between large and small pingos, (b) comparison of pingo ice from the different geographical areas in which it occurs, (c) comparison of ice from old and young and active and inactive massive ice bodies, and (d) comparison of massive ground ice from different climatic and ground environments.

An essential prerequisite for all such studies is distribution mapping of massive ground occurrences in all its forms.

In addition to laboratory experiments, it would be advisable to conduct field experiments. For example, it has been suggested that a pingo be grown under natural conditions by draining a lake and thus allowing the permafrost to invade.

An accurate and increasingly elaborate terminology and classification will progressively develop parallel with the above outlined research.

REFERENCES

- [1] Paper presented in Session 2b of this volume.
- [2] A. E. Porsild. "Earth Mounds in Unglaciated Arctic Northwestern America," *Geog. Rev.*, Vol. 28, 1938, pp. 46-58.
- [3] Fritz Müller. "Observations on Pingos," *Nat. Res. Coun. Canada, Tech. Trans.* 1073 (Ref: *Medd. om Grönland*, Vol. 153, No. 3, 1959) 1963.
- [4] B. G. Craig. "Pingo in the Thelon Valley, Northwest Territories," *Geol. Soc. Am. Bull.*, Vol. 70, 1959, pp. 509-510.
- [5] J. J. Burns. "Pingos in Yukon Kuskokwim Delta, Alaska," *Arctic*, Vol. 17, 1964, pp. 203-210.
- [6] Stephen Taber. "Perennially Frozen Ground in Alaska," *Geol. Soc. Am. Bull.*, Vol. 54, 1943, pp. 1433-1548.

D. M. HOPKINS and JOHN FYLES—Geomorphology I—Attention was directed to topics of permafrost distribution, permafrost age, and modification of landscapes by permafrost.

The distribution of permafrost was discussed mainly from the point of view of map representation. The Permafrost Map of Alaska, prepared by Oscar Ferrains of the United States Geological Survey, and on display at this conference, has abandoned the categories of sporadic, discontinuous, and continuous permafrost in favor of a more elaborate classification involving several categories of extent and thickness of permafrost and nature of frozen material in mountain, lowland, and hilly areas. This kind of map presentation was commended by several participants.

On the other hand, the continuing compilation of the permafrost map of Canada by R. J. E. Brown, National Research Council of Canada, employs the concepts of continuous and discontinuous permafrost zones as an effective representation of information at hand, particularly in the low-relief continental interior. Comments were made on the need for and the difficulties inherent in establishing a unified scheme for mapping permafrost and on the merits of complex, multipurpose permafrost maps. These are produced in the Soviet Union as a series of separate maps showing different

facets of the subject. Brown remarked that the southern fringe of permafrost, as shown on Canadian maps, persistently creeps southward as more and more information accumulates—demonstrating the presence of isolated bodies of frozen ground in many places in the prairie provinces and just north of the Laurentian scarp. (These unexpected southern lenses of permafrost also stimulated discussion in the panels concerned with engineering problems.) Successive Alaskan permafrost maps, as well as construction activities in southern Alaska, show that isolated bodies of permafrost are more widespread than had been supposed.

Baranov's theoretical paper on relationships between permafrost conditions and a complex set of climatic parameters emphasized the possible effects of cold-air drainage upon the local distribution of permafrost in protected valleys in areas of highly continental climate. However, Mel'nikov stated that permafrost in mountain ridges is commonly twice as thick as permafrost in valley bottoms as a result of good ground-water circulation in the valley bottoms. Both observations emphasize the largely unexplored complexities of permafrost distribution in regions having considerable relief.

Discussion of the age of permafrost centered around a paper by Nichols concerning the Recent age of permafrost based on occurrences in the Copper River Lowland of Alaska. Nichols deduces that pre-Recent permafrost could not have survived for an appreciable length of time beneath the deep glacier-dammed lake that formerly existed there nor beneath the adjoining areas covered by glacier ice. This inference is confirmed by the position of bodies of ground ice in a sequence of enclosing strata whose Recent age is established by radiocarbon dates.

Similar inferences concerning the age of permafrost can be drawn for the vast areas of Canada that were buried beneath the Laurentide ice and that are now underlain by thick, cold permafrost. Pre-Recent permafrost and ground ice is to be expected only in a few restricted areas, principally in Yukon Territory and in parts of the western Arctic Islands; throughout the rest of Canada, permafrost must have been initiated within postglacial time (12,000 to 7000 years ago, depending upon locality). Permafrost in Lapland also must be younger than the last glacial cycle, because it is developed, among other places, in late-glacial moraines and glacio-lacustrine deposits.

Williams stressed the value of knowing the actual age of bodies of permafrost and ground ice, but emphasized the desirability of basing conclusions concerning ages upon objective data such as stratigraphic relationships and radiocarbon dates rather than upon assumptions about former conditions.

The broad subject of landscape modification by permafrost was approached from several directions during the later part of the session.

Because permafrost is defined in terms of the freezing point of water, knowledge of the distribution, movement, and chemistry of liquid ground water in cold regions is essential to an understanding of permafrost itself. The paper of Williams and Waller on the occurrence of ground water in permafrost regions in Alaska provides an up-to-date summary presented mainly in terms of the geological framework. In contrast, the same subject is approached from the point of view of the ground-water flow system in L. V. Brandon's discussion (in this volume) of the Williams and Waller paper.

Brandon notes that permafrost creates impermeable boundaries within the ground-water flow network, restricting infiltration and discharge and modifying paths of flow. Increase in the viscosity of water with decrease in temperature further restricts flow in cold regions. Brandon demonstrates that in the Yukon Territory and Mackenzie Valley, where little direct information is available from wells or springs, evidence of ground-water discharge can be deduced from the base flow of rivers, from salinity studies of surface water, and from the distribution of saline plants. Brandon's conclusion that valleys in permafrost regions, as in temperate regions, are areas of effluent seepage carries the corollary that recharge must take place in higher parts of the landscape. Investigations of possible avenues of recharge in areas of near-contin-

uous permafrost would appear to be worthwhile. Possibly some ground-water recharge is obtained through the bottom melting of glaciers; late-lasting snow banks on south-facing slopes (common in the Arctic Islands and in parts of western Alaska) may also be underlain by thawed "holes" in frozen ground through which recharge is accomplished.

Mel'nikov emphasized the importance of *naley* (*aufeis*) in predicting areas of ground-water discharge; Holmes, Hopkins, and Foster, in a paper delivered to the ground-ice panel, have suggested that open-system pingos in central Alaska may provide valuable clues to areas of ground-water discharge.

The high incidence of saline waters in permafrost regions suggests that the explanation should be sought in terms of general permafrost-water interrelationships rather than in special local historical or geological conditions.

Bird's paper on limestone terrains in the Arctic provoked a lively discussion of the many peculiarities that result from the relatively high solubility and susceptibility to frost-shattering of many carbonate rocks. Conflicting opinions were expressed concerning the abundance and age of solution cavities in large bodies of carbonate rocks in permafrost regions. Several observations indicate that, contrary to Bird's opinion, large solution openings exist, transmit water, and are probably susceptible to continuing enlargement under present permafrost conditions. Some karst features in western Alaska can be shown to have originated during middle or late Pleistocene time, though perhaps during interglacial intervals when permafrost was less extensive than at present.

Rapid weathering of limestone fragments at and near the present surface was generally acknowledged, but the relative importance of frost-shattering and solution in this breakdown was debated. Obviously, both sorts of processes proceed rapidly in limestone terrain, and their effects are enhanced by frost-churning, which continually brings new particles to the surface.

Areas underlain by carbonate rocks in Alaska and in many other parts of the Arctic commonly stand well above adjoining areas underlain by other rock types and the carbonate rocks make solid outcrops much more common than do other rock types. Yet carbonate rocks are agreed to be exceptionally susceptible to rapid frost-shattering, and their disintegration products appear to be susceptible to especially rapid mass movements; the acknowledged rapid chemical solution of carbonate rocks at the surface in arctic regions heightens the paradox. Research could well be directed toward a resolution of these apparently conflicting observations. Perhaps the differential relief is inherited from older landscapes formed by different processes or in a different climate, or perhaps the apparent rapid denudation is spurious.

Walker and Armborg contributed a description of the peculiarities of river-bank erosion in perennially frozen unconsolidated materials, supplemented by an excellent film dramatizing the development of a deep thermoerosional niche undercut in the banks at water level during floods. Film and paper illustrated the later collapse of giant blocks of frozen ground bounded by ice-wedges, and the ensuing reduction of these blocks to subdued mounds of dirt. Some members of the panel had seen similar thermoerosional effects developed in frozen coastal bluffs during and after heavy storms. Walker and Armborg's report is one part of their extensive study of the dynamics of the Lower Colville River in arctic Alaska—the first study of its kind devoted to the special characteristics of arctic streams. We hope that their studies will stimulate future investigations of a similar type in other large and small streams in permafrost regions.

Popov, Katchurini, and Grave contributed a valuable synthesis of the distribution of various forms of microrelief in permafrost areas in the Soviet Union. Difficulty experienced by the North American panel members in relating features described by Popov and his associates to features with which they are familiar, points up the inadequacies of word descriptions, even in excellent translations; it emphasizes the serious need for illustrations in published reports and for joint Soviet-North American field correlation trips in arctic areas.

ALFRED JAHN—Geomorphology II—In the absence of the moderator, Lincoln Washburn, a short summary concerning papers and discussions about mass-wasting and patterned ground is presented. The investigation of both phenomena, which are related to seasonal or perennially-frozen ground, is entering a new phase. New methods of quantitative observations are being used—as indicated by some of the papers.

Data presented in the papers show that mass-wasting and patterned ground depend on climate and local factors. So far as the climate is concerned freeze-thaw cycles, both annual and short-term, are important, but opinion is divided as to their relative importance. Examples from the Canadian arctic and Spitsbergen indicate that it is necessary to take into account the climatic differences expressed by the number of freeze-thaw cycles. This problem requires further careful observations.

In the papers and discussions much attention was paid to sorting processes and to local factors and their significance in the development of patterned ground. The hydrological factors play a particularly important role. The general opinion was that these forms and structures developed rapidly in favorable environmental conditions, both in the Arctic and Antarctic.

For almost 100 years the problem of patterned ground or structural soil—as it was called earlier—has been the subject of continued interest but many problems are still unsolved. Recent progress in understanding the origin of patterned ground, however, has been possible with the application of modern quantitative methods of measuring dynamic features of these phenomena. These methods are effective, but we must continue to simplify equipment and techniques. Field experimentation demands patience and persistence because many years of observations are necessary.

Panel members suggest these lines for further investigation:

(a) Improved and simplified instrumentation for measuring the vertical velocity profile in mass-wasting.

(b) Investigations of the possible role of creep and deformation of perennially-frozen ground in mass-wasting. (It would be useful to make the results available to other engineering sciences.)

(c) Significance of short-term (as opposed to annual) freeze-thaw cycles in geomorphic processes, including weathering, mass-wasting, and processes involved in the origin of patterned ground.

(d) Origin of different forms of patterned ground, including string bogs. The interaction of patterned-ground processes and vegetation.

(e) Growth rate of different forms of patterned ground in different climatic environments.

(f) Influence of local as opposed to regional factors in the origin of various forms of patterned ground.

(g) Continuation of field and laboratory investigations of processes involved in the origin of patterned ground.

(h) Detailed quantitative observations of mass-wasting (including slope-wash) and of patterned ground, repeated at the same locations under various conditions and in different environments over a period of years.

G. A. LEONARDS—Phase Equilibria and Transitions—Lively discussion (on some issues two or even three points of view were stoutly defended) made it inevitable that the controversial issues commanded most attention. As a result, worthwhile contributions and provocative test results were largely ignored in the discussion. All papers submitted are commended for serious study.

The nature and properties of the unfrozen film of water that persists around mineral particles in frozen soils attracted considerable comment. The discussion did not delve into all of the uncertainties involved to the same extent, perhaps, as a result of the limited experimental data dealing directly with film water in the papers.

There was general agreement that the properties of the film may differ significantly from those of bulk water, but the crucial question remained unresolved: Can the film sustain a finite shear stress without yielding? The implications of this

question, such as the existence of a threshold or initial gradient—either hydraulic or thermal—are of far-reaching importance in many geotechnical problems both in frozen and unfrozen ground. Experiments to date have not been sufficiently conclusive to convince some skeptics, and further research on this question is welcomed. While careful attention to all pertinent experimental details is certainly in order, it may well be that a fresh approach is needed if conclusive results are to be obtained in the near future.

In a paper on the theory of frost-heaving it was contended that irreversible thermodynamics must be used to describe the frost-heaving process. The author's interpretation of such a formulation led to the conclusion that a temperature gradient in the direction of the mass flow of water is required to produce frost-heaving. This assertion was disputed in the panel discussion. While it was acknowledged that irreversible thermodynamics may be a more rigorous approach to the description of rate processes, opinion was divided regarding the advantages that might accrue from the use of this more sophisticated approach in lieu of conventional thermodynamics. Further studies on this question are clearly indicated.

Freezing point depressions in saturated and moist soils figured prominently in the discussions. When measured freezing point depressions are reported, the panel emphasized that the test conditions should be carefully specified to avoid ambiguous interpretations. In any case it was deemed desirable that the system be adjusted to minimize undercooling so that corrections for the amount of ice formed during nucleation are not excessively large. For calculation of freezing-point depression, the consensus was that where certain conditions were known to prevail, appropriate equations may be employed; but in other circumstances (particularly where ice, water, and air coexist in the soil pores) too little is known of the geometry of the system—especially the distribution of pressure in the several phases—to justify the use of these equations at this time.

Attention was given to the effect of soil-water interactions on the magnitude of heat of fusion of ice formed from soil water. These effects may have a bearing on the accuracy of calorimetric determinations of ice content in frozen soils or rocks and on the procedures for calculating the thermal regime resulting from changes in environmental conditions, especially at relatively low freezing temperatures (such as those that may arise from underground storage of liquid ammonia and the like).

It is regretted that implications of phase transitions in other related problems, such as refreezing of water and melting of ice during creep or the movement of mineral particles by the freezing process, were not considered. Unless the main physical processes involved are appropriately accounted for, it will never be possible to scale the results of laboratory experiments to prototype conditions.

Experience with related problems in unfrozen soils suggests strongly that mathematical approximations of these significant physical processes—however crude the initial approximations may be—are likely to lead to more fruitful results in the long run. A concerted research effort along these lines is recommended.

S. ORVIG—Thermal Aspects—Eight papers were divided into three groups for this discussion. Group I papers deal with temperature conditions above the ground and their relation to heat conduction in soils and presence of permafrost. Group II papers deal with calculations of and factors affecting depth of freeze and thaw in soils. Group III papers deal with the thermal regime in foundations and control of frost penetration.

DISCUSSION

Group I

Air temperature alone does not govern the distribution of permafrost; temperature can only be used as an indicator of the net heat balance at the surface due to processes which are insufficiently understood. The temperature studies tell little

about these processes, which are meteorological and geographical. Not enough meteorological material was submitted. The general conclusion was that since one cannot wait for basic studies, the information contained in temperature studies is better than nothing. However, more analysis of variables other than air temperature (e.g., percentage of possible sunshine or cloud cover, solar radiation) by meteorologists would greatly assist future studies.

Group II

Calculations of freeze and thaw depths are important if the method includes reasonable values for the meteorological variables. It is difficult to find these in meteorological literature, in a way useful to the soil scientists and engineers. The rather widely-spaced observing stations are sufficient to give regional values for such calculations; the problems of site characteristics are mainly those concerned with the actual surface at the location, such as albedo and vegetation cover. The methods described in these papers allow the study of changes brought about by varying the values of each of the meteorological elements, thus promising a better understanding of the processes.

Group III

These papers are concerned with reporting on temperature changes beneath structures built over permafrost and with determining the dimensions of the thawing basin with respect to time. The final papers, which discussed control of frost penetration rather than heat penetration, seemed to be of some interest to those in the audience who felt it might be tried in Alaska.

CONCLUSIONS

Some members felt that the topic of meteorological control of permafrost distribution should have had a more prominent place in the program. It is suggested that such discussion should have been the topic for the very first panel discussion in a conference such as this.

There was a minimum of discussion and controversy. Progress generally has been slow in this field, and few important papers have been published. Some of the current published material still reports principles, methods, and concepts that have been improved (or even discarded) during the past five to 10 years.

As this was the first conference of its kind, it was useful to have an opportunity of summarizing the status of the problems. If another such conference were to be held, the topic should be "current research." As there seems to be little such research in thermal aspects, another meeting including this particular branch of the field probably would not be very useful for some five years or more.

In research on heat fluxes in the ground and at the air-ground interface, it is necessary to have many more data than are now available. The meteorological information can be improved and there are promising signs that such improvement is under way. (The great interest of the Canadian Meteorological Service is one example.) Engineers, also, should publish data, or make known where data may be available. We can do with more measurements (drill holes and temperature measurements in soil near structures and in dams are useful). Cost analysis of particular engineering projects may show that crude data analysis is sufficient, because modern construction equipment permits the necessary over-design. It is more likely that construction of such things as earth-filled dams requires very careful thermal investigations. It is absolutely necessary to have careful analysis in order to improve our knowledge of the thermal processes. That careful data analysis can be of great value in a particular project was brought out by Skaven-Haug's paper in this volume.

A better understanding of the formation of permafrost, its distribution and its degradation requires more data, analyses and comparisons of the two, at the air-ground interface, and below the surface.

N. A. TSYTOVICH—Physicomechanical Properties of Frozen Ground—Seven reports were presented; two were on physical properties of frozen soils and five were on the mechanical properties of freezing, frozen, and thawing soils and the general regulation in the mechanics of frozen soils.

The latter reports can be classified as: (a) Investigation of the physicomechanical processes in freezing, frozen, and thawing soils (reports by M. S. Kersten and G. W. Aitken); (b) results of experimental studies of the mechanical properties of frozen soils and analysis of the causes of the change in these properties under the influence of external factors (reports by R. Yong, C. W. Kaplar, and N. A. Tsytoovich); and (c) investigations of plastic deformation and creep of frozen soils (reports by F. J. Sanger and C. W. Kaplar, and S. S. Vyalov).

The most important results of the investigations and the special problems suggested were debated. These discussions covered rheological processes in frozen soils and methods of determining physical and mechanical properties of frozen soils.

The reports represent a valuable contribution to our science, the mechanics of frozen soils, as they contain not only factual data that are the results of very complicated and prolonged experiments (sometimes covering many years), but they also provide generalizations that will permit a more extensive utilization of the data obtained in engineering practice.

In the future it is desirable to establish international cooperation in solving the following problems: (a) Prediction of primary and secondary consolidation of thawing and near-zero frozen bases, their creep and stress-rupture strength. (b) Generalization of experimental data on mechanical properties of frozen and thawing soils, and establishment of standard strength and strain characteristics.

JOHN A. PIHLAINEN—Exploration and Site Selection—The deliberations of Session 7 may be summarized in spirit if not in actual detail by noting first that exploration and site selection in the North are influenced by isolation, a short field season, and many difficulties of field movement. These limitations have led to an increased use of airphotos, for an airphoto provides a first look at the landscape without the many difficulties of field movement. A paper by Frost, McLerran, and Leighty described a workable analytical method for obtaining information from airphotos and stressed the ever important relation between photoanalysis and engineering criteria as related to exploration of northern lands. The application of this working tool to an engineering project in the Ungava Peninsula of northern Quebec was described by Mollard and Pihlainen. On this project, airphoto interpretation techniques were successfully used in the preliminary planning stages and they continued to supplement field observations during later design stages of the project.

The scope of engineering site investigation in permafrost areas is controlled by many factors. Generalization is difficult because every specific project in a specific northern locality has its own specific requirements. A paper by Johnston provided not only a useful summary of these variables but also recorded the rational step-by-step analysis of them in the order that they are usually encountered. Sebastian recorded an application of this approach with data collected from various sites in the Canadian North.

Methods of subsurface explorations range from the use of test pits to core drilling. All of the methods have commendable characteristics under certain circumstances but core drilling has been found to be the most efficient if attention is paid to the many implications imposed by frozen materials. The paper by Hvorslev and Goode recorded many of these details and experiences. More specific observations of the use of refrigerated fluids for drilling and coring in permafrost were reported by Lange. These observations and the quantitative approach to the design of such equipment are not only of immediate value for research in permafrost areas but are of practical value when frozen samples of bedrock or gravel must be obtained for engineering assessments.

Explorations in permafrost depend upon many factors; among them, the actual location and extent of permafrost is

of particular importance especially in areas of sporadic permafrost. Thus the number of subsurface explorations is inversely proportional to the areal extent of permafrost, i.e., the less permafrost in an area, the more "holes" are needed. Increased explorations in areas of sporadic permafrost (and the associated higher costs) will tend to discourage direct observations (such as drilling), but will stimulate the use of indirect methods. The paper by Barnes was a timely summary on the uses of geophysical methods for delineating permafrost and it also will serve as a useful basis on which to assess the utilization of these potential techniques on specific projects.

Although permafrost is defined on the basis of temperature, the many difficulties of measuring ground temperatures have hampered investigations of this property. At some stage of permafrost investigations or assessment, research and engineering must consider soil temperatures. The paper by Hansen was a most useful summary of the three most common methods of measuring ground temperatures and will be helpful to those engaged in observations of soil temperatures.

Site selection may be thought of as an integration of terrain, structure, and construction method requirements. Superimposed on these terms of reference are the actual exploration methods. The paper by Harwood recorded an account of a complex site exploration problem. One of the most interesting facets of this project was that prefield planning was so detailed that the problems associated with permafrost were minimized. In some cases potential permafrost problems were completely eliminated.

The contribution of our Soviet colleagues is as impressive as their record in the many other sessions. A paper by Bakakin and Zelenin on the mining of frozen ground described some excavation methods utilized in the USSR. This paper, although considered to be in the wrong session, attracted some detailed comments. A more pertinent paper on engineering geocryologic investigations by Ushkalov, Pchelintsev, Yefimov, and Dementyev recorded an approach that paralleled North American interests but was found to be more detailed than that usually employed in North America.

The constantly recurring suggestion of cooperation so that we might next meet in the field was stimulated largely by the Soviet contributions. At the risk of detracting from the many other needs of exploration and site selection, may I therefore end my comments on this hopeful note.

A. J. ALTER—Sanitary and Hydraulic Engineering—Panel discussions, general discussions, and the papers presented were in general agreement. The similarity of methods employed in providing successful sanitary and hydraulic engineering structures and services in the many geographic areas represented in the discussions was obvious throughout the session. Likewise, the problem areas were similar and the research needs were described as comparable.

Although there were 14 papers discussed, all topics were discussed in three major groups, followed by general summary-type discussions. The three major groups consisted of (a) hydrogeology and dams, (b) specific practices in Russia, Greenland, Antarctica, Alaska, and Canada, and (c) water and waste disposal systems design and construction principles applicable to such systems in permafrost areas.

Russian experiences in investigation of hydrogeology and dams have differed slightly from the experience in other countries.

HYDROGEOLOGY

The discussion brought out these points: (a) Hydrogeological investigations should be considered on the basis of area wide, regional, and local zones. (b) Underground water sources are fed from above and below the permafrost zone. (c) Chemical and physical characteristics and quantities of permafrost waters as well as pressure-head are determined by circulation of the waters above, through, and below the permafrost. (d) Russian experience includes studies of deep permafrost waters.

DAMS

Experience in design and construction of dams on permafrost was called inadequate. Certain basic principles to be considered in design and construction were pointed out as follows: (a) Prognosis of temperature conditions is of great importance. (b) Either "warm" or "cold" construction methods should be employed and not a combination of methods. (c) Frozen materials may be used for foundation, impervious core, or screen. (d) Ground and foundation conditions, logistics, runoff pattern, climatic conditions, and thermal features of the structure and site determine the type and design of a dam. (e) Little or no experience is available on large dams; in view of the large dams proposed for the future, much investigative work is necessary. The important Rampart Dam proposal was particularly emphasized.

SPECIFIC PRACTICES IN RUSSIA, GREENLAND, ANTARCTICA, U.S., AND CANADA

Water supply source development, distribution practice, treatment, problems, and miscellaneous water system features were discussed as well as sewers and sewage treatment. These design, construction, and operating features were included:

1. Recirculating mains and services, use of utilidors, insulation methods, wastage of water to prevent distribution system freezing, depth of bury for pipes, materials of construction, methods for heating pipes, methods for maintaining structural stability in pipes and facilities, installation and operation costs, and miscellaneous operating experiences. These items were found to be of common concern among representatives from all countries.
2. Sewage stabilization ponds were reported to function with some degree of adequacy in permafrost regions at relatively high latitudes.
3. Although specific costs were not available, considerable interest was expressed in finite costs and the relative costs of one type of facility in comparison with another.
4. Both Sweden and Soviet representatives reported successful performance of pipelines buried at relatively shallow depths where provision was made for recirculation and heating of water.
5. Providing water and sewage services in areas of permanently frozen ground is largely influenced by physical conditions prevalent in the area.
6. Much of the experience reported was based on observation of installed and functioning crash-built facilities rather than on full laboratory and field studies set up to precede ultimate design and construction.
7. Described practices were roughly categorized into encapsulated, insulated and heated facilities, and nonfrost-susceptible facilities, thus representing three basic design concepts in use.
8. The sparsity of specific data on the many facets of design and construction of water- and waste-disposal systems for use in permafrost areas was emphasized.
9. Simplicity in all systems for permafrost areas and use of proven mechanical items were stressed.
10. The importance of interdisciplinary viewpoints in planning sanitary works was emphasized. Although this is desirable anytime, its importance is amplified in permafrost areas. Logistics, efficiency, simplicity, planning, and thorough study are important.

DESIGN AND CONSTRUCTION OF WATER AND WASTE DISPOSAL SYSTEMS

Thermal considerations must be given to every facet of design construction and operation of sanitary and hydraulic works; a thorough thermal analysis should be as much a part of a project as structural analysis, economic analysis, or other bases for design. Locally available and low-cost materials as well as waste-energy sources should be considered. Wind energy was suggested as a usable source of waste-energy

under certain conditions. Design and construction should be governed by site conditions, climatic conditions, and local factors rather than upon mere modification of practice from another climatic area and should result in the selection of an ultimate "cold" or "warm" technique rather than a combination of active and passive methods. Community planning and utilities design should be correlated to the extent necessary to assure use of compatible utility system methods acceptable for use in permafrost areas.

Compressed-air evacuation of lines and insulation achieved from natural materials such as ice and snow are examples of different concepts for preventing utility freezing which should be considered wherever possible.

SPECIFIC RESEARCH NEEDS

Numerous gaps in necessary data and design parameters were pointed out in the discussions; the following items are examples of the type of studies that are needed:

1. Further determination of the comparability of hydrogeological studies conducted in different countries.
2. Further definition of hydrogeological zoning.
3. Better methods for exploration of underground hydrogeology in permafrost.
4. Further determination of permafrost characteristics as they relate to design and construction of sanitary and hydraulic structures.
5. Investigation of design concepts for dams in permafrost including methods for preventing filtration, methods for abutment design, methods for the design and construction of spillways, locks, head race, and tail race channels. Particular emphasis should be placed on studies to determine effects on the rock or earth dam creating an impounded body of water, and the effects on the reservoir site when water is stored in a reservoir continuously.
6. Every part of water and sewage works design needs further study to relate such design to the many characteristics of permafrost.
7. New concepts of water supply and waste disposal that are fully compatible with permafrost conditions must be studied and defined.
8. Community planning concepts more suited to the characteristics of the permafrost areas of the world are urgently needed and should be investigated and developed.

R. M. HARDY—Earthwork and Foundation Engineering—Foundation engineering problems in permafrost regions was one of the first areas that attracted international scientific attention. However, this dates back only some 20 years. The present conference is the first forum at which specialists, representing all countries in the Northern Hemisphere (with major interests in foundation problems in permafrost areas) have met together for a frank exchange of ideas and experience. It is therefore pertinent to examine the more important areas of agreement and disagreement on the problems discussed in this specific field.

The most complete exchange of ideas occurred in regard to the design and installation of piled foundations. The U. S. Army (CRREL) presented the results of some 15 years of research on design criteria and installation of piles and the results have been incorporated in a recently revised edition of the Building Foundation Chapter of the Engineering Manual for Military Construction of the U. S. Army. These, without question, will set the standard for design of foundations in permafrost areas on the North American continent for some years in the future. Senior representatives of the Frozen Ground Research Institute and of the Construction Institute in the USSR presented the current thinking in the design of and

construction practice for piles in permafrost in the USSR. Representatives of Dominion Government departments in Canada presented the current practice in Canada.

In the U. S. Army practice, the earlier exclusive use of steam- or water-thawed holes for emplacement of piles in permafrost has been substantially replaced by methods using modern drilling and driving equipment with holes either larger or smaller than the pile. No general preference is indicated for pile material. The practice in the USSR favors the use of reinforced concrete piles, and more recently, reinforced concrete H sections. Installation methods include preliminary steaming, placement in bored holes of a diameter in excess of the pile diameter (and with the annulus being primed with a soil slurry), and placement by driving directly into the frozen soil or into bored holes of diameter somewhat less than the pile diameter. The selection of method of installation is to a considerable extent governed by the temperature of the permafrost with "high temperature" frozen soil being considered as soil at a temperature not less than about -2°C . In Canada, the current practice largely uses timber piles set in steam-thawed holes.

These variations in installation practice and pile material, to a certain extent, reflect basic concepts concerning rate of refreezing of the soil around the pile and strength of adfreezing bond. However, to a greater extent they appear to reflect the general approach and economics of the particular national construction industry.

In the design field a considerable divergence of views on the basic action of piles in permafrost is evident between the practice in USSR and in U. S. A. Current thinking in the USSR postulates pile support derived from three sources: Adhesion between the surface of the pile and the frozen soil; end bearing of the pile on frozen soil, and under some circumstances, a friction component acting on the surface of the pile resulting from the normal stress component acting across the contact of the pile surface and the soil.

At CRREL in the U. S. A. the current thinking, based on recent research, considers that the supporting capacity of piles in permafrost is predominantly attained by the adfreeze bond between the soil and the pile surface. For practical dimensions of piles in permafrost only a very small percentage of the ultimate capacity is derived by end bearing. The test data indicate that the reason for this is that the ultimate strength in adfreezing bond is developed at much lower strains than are necessary to mobilize the end-bearing ultimate capacity.

Both schools of thought recognize that the adfreeze bond varies with soil type and condition, and, to a very marked degree, with temperature. However, design adfreeze values still appear to be selected on a substantially empirical basis. Here is probably an area to which research should be directed.

With one or two exceptions, there seemed to be no general appreciation, in the papers submitted or in the discussions, of the special foundation engineering problems that occur in areas of retrogressing permafrost. Developments in northwest Canada during the past five to six years have shown that sporadic and discontinuous permafrost exists over a much more extensive area, and extends much further south, than previously had been assumed. This fact emphasizes the importance of problems peculiar to the fringe areas surrounding the zones of continuous permafrost. Not only is there the problem of identifying areas of frozen or recently frozen ground, but there are questions such as rate of thawing of the permafrost, stability of slowly thawing permafrost, negative skin friction on piles in thawing permafrost and rate and amount of settlement of thawing ground. Solutions to these are still essentially empirical. Research directed to these problems is needed to permit more rational designs to be made.

APPENDIX

CONFERENCE COMMITTEE

Kenneth B. Woods
General Conference Chairman

PLANNING COMMITTEE

A. J. Alter
James A. Bender
Richard L. Cameron
Trevor A. Harwood
Arthur H. Lachenbruch
A. L. Washburn

Robert F. Legget
Kenneth A. Linell
Robert D. Miller
William J. Niemi
Troy L. Péwé

PUBLIC RELATIONS

Kenneth T. Simendinger, Chairman
Robert E. Fischer
Louise Levitas
Frederick S. Merritt

CONFERENCE PANELS

SOILS AND VEGETATION

Norman W. Radforth, Moderator
Hugh M. Raup, Assistant Moderator

William S. Benninghoff
Roger J. E. Brown

Richard L. Cameron
J. C. F. Tedrow

THERMAL ASPECTS

S. Orvig, Moderator
Ronald F. Scott, Assistant Moderator

R. C. Deen
G. V. Porkhayev
F. J. Sanger

MASSIVE GROUND ICE

Troy L. Péwé, Moderator
Jerry Brown, Assistant Moderator

J. Ross Mackay
Fritz Müller

PHYSICO-MECHANICAL PROPERTIES OF FROZEN GROUND

N. A. Tsytovich, Moderator
S. S. Vyalov, Assistant Moderator

O. B. Andersland
F. J. Sanger
Raymond Yong

GEOMORPHOLOGY

Davis M. Hopkins & A. L. Washburn, Moderators
John G. Fyles & Alfred Jahn, Assistant Moderators

Robert F. Black
Arturo E. Corté

P. I. Melnikov
Anders Rapp
Peter J. Williams

EXPLORATION AND SITE SELECTION

Kenneth B. Woods, Moderator
John A. Pihlainen, Assistant Moderator (Deceased)

Robert E. Frost
Trevor A. Harwood

G. R. Lange
Kenneth A. Linell
O. V. Snezhko

PHASE EQUILIBRIA AND TRANSITIONS

G. A. Leonards, Moderator
R. D. Miller, Assistant Moderator

Philip F. Low
N. A. Tsytovich

R. Torrence Martin

SANITARY AND HYDRAULIC ENGINEERING

A. J. Alter, Moderator
Warren George, Assistant Moderator

Donald G. Ball
Lars-Eric Janson
G. V. Porkhayev

EARTHWORK AND FOUNDATION ENGINEERING

R. M. Hardy, Moderator
Kenneth A. Linell, Assistant Moderator

G. H. Johnston
B. M. Monaghan
S. S. Vyalov

CONFERENCE REGISTRANTS

- AITKEN, George W.
Hanover, N.H.
- ALTER, Amos J.
Juneau, Alaska
- ALTSCHAEFFL, A. G.
West Lafayette, Ind.
- ANDERSLAND, O. B.
East Lansing, Mich.
- ANDERSON, Duwayne M.
Hanover, N.H.
- ANDREW, R. C.
West Lafayette, Ind.
- ANTES, Ronald
West Lafayette, Ind.
- ARNBORG, Lennart
Uppsala, Sweden
- ASSUR, Andrew
Hanover, N.H.
- AUGHENBAUGH, Nolan B.
West Lafayette, Ind.
- AUKLAND, Merrill F.
Alexandria, Va.
- AYLWARD, Thomas J.
West Lafayette, Ind.
- BAKER, Clyde N., Jr.
Northbrook, Ill.
- BALDIZZONE, Armando Garcia
West Lafayette, Ind.
- BALL, Donald G.
Boston, Mass.
- BAPTIST, O. C.
Laramie, Wyo.
- BARKSDALE, Richard D.
West Lafayette, Ind.
- BARNES, David F.
Menlo Park, Calif.
- BARON, William
West Lafayette, Ind.
- BARR, David
West Lafayette, Ind.
- BASCHIERE, Ronald
Niles, Ill.
- BECKER, Ronald E.
Dallas, Texas
- BEHLING, Robert E.
Oxford, Ohio
- BEISTLINE, Earl H.
College, Alaska
- BENDER, James
Hanover, N.H.
- BENEDICT, James B.
Nederland, Colo.
- BENNINGHOFF, William S.
Ann Arbor, Mich.
- BERG, Thomas E.
Madison, Wis.
- BESCHEL, Roland E.
Kingston, Ont., Canada
- BIENIADA, S. T.
Ottawa, Canada
- BIRD, J. Brian
Montreal, Canada
- BLACK, Robert F.
Madison, Wis.
- BOURNE, Harry K.
Washington, D.C.
- BOWERS, Maurice M.
Hancock, Mich.
- BRITTON, Max E.
Washington, D.C.
- BROWN, Jerry
Hanover, N.H.
- BROWN, Roger J. E.
Ottawa, Canada
- BROWN, Samuel N., Jr.
West Lafayette, Ind.
- BROWNING, James A.
Lebanon, N.H.
- BRUCE, William E.
Minneapolis, Minn.
- BUCK, Alan D.
West Lafayette, Ind.
- BUCKLEY, John W.
West Lafayette, Ind.
- BUGLIO, Antonia O.
West Lafayette, Ind.
- BUSSIERES, Paul
Quebec, Canada
- CAMERON, Richard L.
Columbus, Ohio
- CHATURVEDI, L. N.
West Lafayette, Ind.
- CHUNG, Hyung Sik
West Lafayette, Ind.
- COCHRANE, Thomas E.
Bloomington, Ind.
- COOK, E. F.
Washington, D.C.
- COOK, Francis A.
Ottawa, Canada
- COOK, Irvin Pat
Anchorage, Alaska
- COOLEY, John M.
Anchorage, Alaska
- CORTE, Arturo E.
Bahia, Blanca, Argentina
- CRORY, Frederick E.
Hanover, N.H.
- DASH, Umakant
West Lafayette, Ind.
- DAVIS, Robert M.
Hanover, N.H.
- DEEN, Robert C.
Lexington, Ky.
- DESAI, Sudhir
Oakebrook, Ill.
- DEVENNY, Dave
Ottawa, Canada
- DILLON, Howard B.
East Lansing, Mich.
- DILLON, Robert M.
Washington, D.C.
- DONELSON, Ralph W.
Anchorage, Alaska
- DOUGLASS, Paul L.
West Lafayette, Ind.
- DOUMANI, Geo. A.
Washington, D.C.
- DUDLEY, Robert A.
Albuquerque, N. Mex.
- DYE, E. Allen
Denver, Colo.
- EDWARDS, Larry J.
Lafayette, Ind.
- EGAN, Chris
East Lansing, Mich.
- ESTERHELD, John, Jr.
Oxford, Ohio
- EVERETT, K. R.
Columbus, Ohio
- FARRAR, Mr. and Mrs. Norman
Toronto, Canada
- FEATHERSTONE, William
Juneau, Alaska
- FERRIANS, Oscar J., Jr.
Washington, D.C.
- FLOYD, W. R.
Hanover, N.H.
- FLYNN, JACK M.
Tulsa, Okla.
- FOWLER, Geo. W.
Washington, D.C.
- FOX, Raymond R.
Washington, D.C.
- FRICKE, Orren W.
Denver, Colo.
- FROST, Robert E.
Hanover, N.H.
- FYLES, John G.
Ottawa, Canada
- GAARDER, Ole
West Lafayette, Ind.
- GAFFEY, John T., II
West Lafayette, Ind.
- GATES, George L.
San Francisco, Calif.
- GEORGE, Warren
Anchorage, Alaska
- GONZALEZ, Jorge W.
West Lafayette, Ind.
- GRAVES, James C.
Independence, Kan.
- GRIFFIN, William H.
West Lafayette, Ind.
- GRIMM, Clayford T.
Washington, D.C.

- GROTNEA, Leif
West Lafayette, Ind.
- GUSTAFSON, Adolph L.
Denver, Colo.
- HAAS, Wilbur M.
Houghton, Mich.
- HANNIGAN, Gene
West Lafayette, Ind.
- HANTO, Donald C.
West Lafayette, Ind.
- HARDESTY, Daniel M.
West Lafayette, Ind.
- HARDY, R. M.
Alberta, Canada
- HARRISON, William P.
Potsdam, N.Y.
- HARWOOD, T. A.
Ottawa, Canada
- HASTINGS, Andrew D.
Natick, Mass.
- HEAD, William J.
West Lafayette, Ind.
- HEINE, W. A.
West Lafayette, Ind.
- HENNION, Frank B.
Washington, D.C.
- HENRY, Elvin F.
Washington, D.C.
- HERRMANN, Melvin R.
Washington, D.C.
- HEUSTED, W. V.
Littleton, Colo.
- HICKEY, John L. S.
Anchorage, Alaska
- HISEROTE, Allan
Littleton, Colo.
- HOLMES, G. William
Beltsville, Md.
- HOOPER, James
West Lafayette, Ind.
- HOPKINS, David M.
Menlo Park, Calif.
- HOUDEBO, R. C.
Saskatchewan, Canada
- HUBBS, G. LaMar
Anchorage, Alaska
- HUGHES, Owen L.
Ottawa, Canada
- HUTCHISON, Lebrun
Littleton, Colo.
- JAHN, Alfred
Wroclaw, Poland
- JACKSON, Robert F.
Washington, D.C.
- JACOBSEN, George
Montreal Canada
- JANSON, Lars-Eric
Stockholm, Sweden
- JOHNSON, A. W.
Washington, D.C.
- JOHNSON, Albert W.
Los Angeles, Calif.
- JOHNSON, H. O., Jr.
Washington, D.C.
- JOHNSON, Richard L.
West Lafayette, Ind.
- JOHNSTON, G. H.
Ottawa, Canada
- KAISER, Richard
Washington, D.C.
- KAPLAR, Chester W.
Hanover, N.H.
- KARRIT, John B.
West Lafayette, Ind.
- KOOPMANS, Ruurd W. R.
Ithaca, N.Y.
- KOROPATNICK, A.
Hybord, Manitoba, Canada
- KOSIBA, Aleksander
Columbus, Ohio
- KREBS, Robert D.
Blacksburg, Va.
- LABERGE, Guy
West Lafayette, Ind.
- LAMBERSON, Eugene A.
Lafayette, Ind.
- LANCTOT, Jean-Paul
Montreal, Canada
- LANGE, C. Robert
Hanover, N.H.
- LAREW, H. G.
Charlottesville, Va.
- LASCA, Norman
Ann Arbor, Mich.
- LAUSTER, K. C.
Anchorage, Alaska
- LAWRENCE, N. A.
Edmonton, Alberta, Canada
- LEFEBVRE, Liguori M.
Lafayette, Ind.
- LEGGET, R. F.
Ottawa, Canada
- LEHLBACH, Arnold M.
Washington, D.C.
- LEIGHTY, Robert D.
Hanover, N.H.
- LEONARDS, G. A.
West Lafayette, Ind.
- LEWELLEN, Robert
Hanover, N.H.
- LEWIS, Karl H.
West Lafayette, Ind.
- LINELL, Kenneth A.
Hanover, N.H.
- LOBACZ, Edward F.
Hanover, N.H.
- LONG, Erwin L.
Anchorage, Alaska
- LOVELL, C. W.
West Lafayette, Ind.
- LUKAS, Robert G.
Northbrook, Ill.
- LUNDQVIST, Jan
Stockholm Sweden
- MABBITT, Harry F.
Washington, D.C.
- MACDONALD, D. H.
Niagara Falls, Ont., Canada
- MACKAY, J. Ross
Vancouver, B.C., Canada
- MACQUARRIE, L. G.
Ottawa, Canada
- McANERNEY, John M.
Hanover, N.H.
- McCULLOCH, David
Menlo Park, Calif.
- McGAW, Richard W.
Hanover, N.H.
- McKITTRICK, David P.
West Lafayette, Ind.
- McLERRAN, James H.
Hanover, N.H.
- MELNIKOV, Pavel Ivanovich
USSR
- MILES, Robert D.
Lafayette, Ind.
- MILHOUS, Robert T.
West Lafayette, Ind.
- MILLER, Lee D.
Ann Arbor, Mich.
- MILLER, Maynard M.
East Lansing, Mich.
- MILLER, Robert D.
Ithaca, N.Y.
- MILLS, R. E.
West Lafayette, Ind.
- MISHU, Louis
West Lafayette, Ind.
- MIZE, Ralph W.
Albuquerque, N. Mex.
- MOLLARD, J. D.
Saskatchewan, Canada
- MONAGHAN, B. M.
Sept Iles, Que., Canada
- MONTAGNE, John
Bozeman, Mont.
- MONTGOMERY, Robert D.
Monroeville, Penna.
- MÜLLER, Fritz
Montreal, Canada
- MULLER, Siemon William
Stanford, Calif.
- NAPADENSKY, Mrs. Hyla S.
Chicago, Ill.
- NEAL, James T.
Bedford, Mass.
- NELSON, Charles C.
West Lafayette, Ind.
- NELSON, James L.
West Lafayette, Ind.
- NELSON, Wilbur A.
Charlottesville, Va.
- NICHOLS, Donald R.
Washington, D.C.
- NOBLES, Laurence H.
Evanston, Ill.
- OOSTERBAAN, Marvin D.
Midland, Mich.
- ORDWAY, James F.
Lebanon, N.H.
- ORVIG, Svenn
Montreal, Canada
- OSBORNE, Alfred M.
West Lafayette, Ind.
- OSBURN, W. S.
Boulder, Colo.
- O'SULLIVAN, John B.
Milwaukee, Wis.
- PALMER, Jack M.
Chula Vista, Calif.
- PARKER, Claude B.
Centerline, Mich.
- PATTON, Franklin D.
Urbana, Ill.
- PEARSON, John E., Jr.
Lafayette, Ind.
- PENNER, E.
Ottawa, Canada
- PENZ, Michael C.
Bloomington, Ind.
- PETERSON, Lowell
Littleton, Colo.
- PEWÉ, Troy L.
College, Alaska
- PHILLEO, Edgar S.
Fairbanks, Alaska

- PIERCE, George N.
Juneau, Alaska
- PIHLAINEN, J. A.
Ottawa, Canada
- POCZATEK, Joseph J.
Niles, Ill.
- PORKHAYEV, G. V.
USSR
- PORSILD, A. E.
Ottawa, Canada
- PRINCE, Paul S.
Indiana, Penna.
- PRITCHARD, Gordon B.
Ottawa, Canada
- PRYER, Robert W. J.
Sept Iles, Que., Canada
- PULLEN, M. William
West Lafayette, Ind.
- QUINN, William F.
Hanover, N.H.
- RADFORTH, Norman W.
Hamilton, Canada
- RAPP, Anders
Uppsala, Sweden
- RAUP, Hugh M.
Petersham, Mass.
- REID, John R.
Grand Forks, N.D.
- ROBERTSON, Herbert C. Jr.
Garland, Texas
- ROSTOKER, David
Cambridge, Mass.
- RUTLEDGE, Philip C.
New York, N.Y.
- SAINES, Marvin
Oxford, Ohio
- SAMSON, Laval
Montreal, Canada
- SAMUDA, A. James
Washington, D.C.
- SANBORN, John L.
West Lafayette, Ind.
- SANBORN, Leonard F.
Boston, Mass.
- SANDERS, F. A.
Washington, D.C.
- SANGER, F. J.
Hanover, N.H.
- SARGENT, Charles
College, Alaska
- SASSANI, Michael J.
Washington, D.C.
- SAUER, Bert
Montreal, Canada
- SAYLES, Francis H.
Hanover, N.H.
- SCHEEL, Eugene
Littleton, Colo.
- SCHENK, Erwin K.
Giessen, West Germany
- SCHOLER, Charles F.
West Lafayette, Ind.
- SCHULTZ, Daryl D.
Kansas City, Mo.
- SCOTT, Ronald F.
Pasadena, Calif.
- SCOTT, W. A.
Toronto, Canada
- SCULLY, John
West Lafayette, Ind.
- SELLMANN, Paul
Hanover, N.H.
- SHERMAN, Richard G.
College, Alaska
- SIM, Victor W.
London, Canada
- SIMENDINGER, Kenneth T.
Washington, D.C.
- SIMONI, Olindo W.
Fairbanks, Alaska
- SLADEK, G. J.
Toronto, Canada
- SMITH, H. T. U.
Amherst, Mass.
- SMITH, P. C.
Washington, D.C.
- SMITH, Waldo E.
Washington, D.C.
- SNEZHKO, Oleg Vadimovich
USSR
- SOTIROPOULOS, Elias
West Lafayette, Ind.
- SPANGLER, Robert W.
Washington, D.C.
- STANLEY, D. R.
Edmonton, Canada
- STEWART, David P.
Oxford, Ohio
- STOLTING R.
Montreal, Canada
- SU, Hon-Hsieh
East Lansing, Mich.
- SULLIVAN, R. J.
Peoria, Ill.
- SWINZOW, George K.
Hanover, N.H.
- TAKAGI, Shunsuke
Hanover, N.H.
- TEDROW, J. C. F.
New Brunswick, N.J.
- THOMPSON, H. A.
Toronto, Canada
- THOMSON, S.
Edmonton, Canada
- TORDON, Frank
Montreal, Canada
- TOWNSEND, David
Kingston, Ont., Canada
- TSYTOVITCH, Mikolai
USSR
- UGOLINI, Florenzo
New Brunswick, N.J.
- VYALOV, S. S.
USSR
- WALCOTT, Lester J.
Houghton, Mich.
- WALDMAN, Michael A.
West Lafayette, Ind.
- WALKER, Harley, Jr.
Baton Rouge, La.
- WALKER, Richard D.
Blacksburg, Va.
- WALLER, Roger M.
Anchorage, Alaska
- WASHBURN, A. L.
New Haven, Conn.
- WATT, John S.
Ottawa, Canada
- WAYTOW, William R.
Spokane, Wash.
- WAYNE, William J.
Bloomington, Ind.
- WELLEMS, Thomas J.
Albuquerque, N. Mex.
- WEST, Terry R.
Lafayette, Ind.
- WHITE, Owen L.
Urbana, Ill.
- WHITE, Sidney E.
Columbus, Ohio
- WILLIAMS, John R.
Anchorage, Alaska
- WILLIAMS, Peter J.
Blindern, Oslo, Norway
- WOLFE, Louis
Ponca City, Okla.
- WOODS, K. B.
Lafayette, Ind.
- WORTH, E. G.
Lafayette, Ind.
- WRIGHT, Kenneth R.
Denver, Colo.
- WU, T. H.
East Lansing, Mich.
- YATES, A. B.
Ottawa, Canada
- YODER, Eldon J.
West Lafayette, Ind.
- YONG, Raymond N.
Montreal, Canada
- ZACKRISON, H. B., Sr.
Washington, D.C.
- ZEISLOFT, Jon
West Lafayette, Ind.
- ZENONE, Chester
Lafayette, Ind.
- ZONDORAK, John B.
New York, N.Y.

GB641.I6.1963.,c.1
 International Conference on
 Permafrost.
 Permafrost international
 conference.

GB641.I6.1963.,c.1
 International Conference on
 Permafrost.
 Permafrost international
 conference.

DATE DUE	BORROWER'S NAME	ROOM NUMBER
3/20/67	OCB - Bldg 507 pm 6-48	500
4/1/67	Attn: Miss Nolan 11-7539	707
1-3-71	Reed's Geog. Soc. 1601 M	
3-22-73	Miss Kinney 226 250 x 825	
	Dept Geographic Library	
	1100 Library	
	See 656-2209 - 406	