



**Vision Research: Flying and Space Travel;  
Proceedings of Spring Meeting, 1964. Edited by  
Milton a. Whitcomb and William Benson (1968)**

Pages  
209

Size  
5 x 9

ISBN  
0309299225

Milton A. Whitcomb and William Benson, Editors; Armed Forces - NRC Committee on Vision; National Research Council

 [Find Similar Titles](#)

 [More Information](#)

**Visit the National Academies Press online and register for...**

- ✓ Instant access to free PDF downloads of titles from the
  - NATIONAL ACADEMY OF SCIENCES
  - NATIONAL ACADEMY OF ENGINEERING
  - INSTITUTE OF MEDICINE
  - NATIONAL RESEARCH COUNCIL
- ✓ 10% off print titles
- ✓ Custom notification of new releases in your field of interest
- ✓ Special offers and discounts

Distribution, posting, or copying of this PDF is strictly prohibited without written permission of the National Academies Press. Unless otherwise indicated, all materials in this PDF are copyrighted by the National Academy of Sciences.

To request permission to reprint or otherwise distribute portions of this publication contact our Customer Service Department at 800-624-6242.

Copyright © National Academy of Sciences. All rights reserved.



c 2

**VISION**

**RESEARCH:**

**FLYING AND**

**SPACE TRAVEL**

Proceedings of Spring Meeting, 1964

Edited by MILTON A. WHITCOMB

and WILLIAM BENSON

ARMED FORCES — NRC COMMITTEE ON VISION

NAS-NAE

OCT 29 197

OCT 29 197

LIBRARY

LIBRARY

NATIONAL ACADEMY OF SCIENCES — NATIONAL RESEARCH COUNCIL  
Washington, D. C., 1968

**Reproduction is sponsored by contract NONR 2300(05)  
between Armed Forces-NRC Committee on Vision and ONR**

**Inquiries concerning this publication should be addressed to:  
Armed Forces-NRC Committee on Vision  
National Academy of Sciences—National Research Council  
2101 Constitution Avenue, N.W.  
Washington, D.C. 20418**

**Library of Congress Catalog Card Number 68-60078**

## **FOREWORD**

In the spring of 1964, a two-day meeting was held under the auspices of the Armed Forces-NRC Committee on Vision. The papers presented at this meeting concerned visual problems related to low altitude, high-speed flight, space travel, and incapacitating effects on pilots resulting from inadvertent viewing of a nuclear detonation. These papers were so greatly sought after that the Executive Council of the Committee on Vision decided to publish them as a collection representing the proceedings of the committee meeting.

## CONTENTS

### VISION IN SPACE TRAVEL

John H. Taylor, Chairman

Criteria for Laboratory Experiments Useful in Field Situations Wilson P. Tanner, Jr.	3
Visual Fitness for Space Travel Arthur Jampolsky, Ailene Morris, and Carter Collins	16
The Effect of Flash Distribution and Illuminance-Level upon the Detection of Low Intensity Light Stimuli Richard E. Wienke	19
Langley Research Center Simulators and Studies Related to Space Rendezvous and Docking Jack E. Pennington	31
Some Langley Research Center Plans in the Area of Visual Displays for Lunar Mission Simulation Donald R. Riley and Byron M. Jaquet	40
Visual Masking Using Different Test-Stimulus Patterns Robert C. Boyle	52
Sextant Sighting Performance in the Ames Midcourse Navigation and Guidance Simulator Robert J. Randle and Bedford A. Lampkin	62
Comments on Major Gordon Cooper's Observations from Orbit John H. Taylor	71
Gemini In-Flight Visual-Acuity Experiment S. Q. Duntley	80

**FLASH BLINDNESS**

John L. Brown, Chairman

**Operational Significance of the Flash Blindness Problem**

Walton L. Jones 85

**The Nature of Radiation from Nuclear Weapons in  
Relation to Flash Blindness**

J. H. Hill and Gloria T. Chisum 95

**Experimental Investigations of the Flash Blindness Problem**

John Lott Brown 104

**Methods of Preventing Flash Blindness**

Frederick E. Barstow 127

**Air Force Efforts in the Field of Flash Blindness**

James F. Culver 134

**A Flash Blindness Indoctrination and Training Device**

James F. Parker, Jr. 140

**VISION PROBLEMS IN LOW-ALTITUDE, HIGH-SPEED FLIGHT**

James W. Miller, Chairman

**Vision Problems in Low-Altitude, High-Speed Flight**

**Introductory Remarks by the Chairman**

James W. Miller 145

**Geographic Orientation during Low-Altitude Flight**

James J. McGrath 146

**Dynamic Visual Detection Recognition**

Charles P. Greening 164

**Operational Problems Associated with Low-Altitude Flight**

Robert W. Bailey 176

**Some Operational Aspects of Visual Problems in**

**Low-Flying, High-Speed Aircraft**

Robert L. Jones and James S. Joska 180

**VISION IN SPACE TRAVEL**

**John H. Taylor, Chairman**





## **CRITERIA FOR LABORATORY EXPERIMENTS USEFUL IN FIELD SITUATIONS<sup>1</sup>**

**Wilson P. Tanner, Jr.**  
**Sensory Intelligence Laboratory**  
**The University of Michigan**

It is of the utmost importance at the present time to design laboratory experiments useful in describing human behavior so that data relevant to the problems of U.S. space and military efforts may be obtained. If scientific laboratories are to continue to look to the government as a major source of financial support, the problem is critical to scientific progress. The solution of the problem does not exist in leaning more heavily toward field studies. Neither does it exist in increasing the rate of laboratory experiments as now conducted, for these tend to ignore many of the significant variables. The solution requires a more careful study of the problems, leading to a more nearly precise statement of the interacting variables which need careful examination. Laboratory experiments should, then, be designed to study these variables along with the interactions. The design of laboratory experiments to accomplish these desired objectives may require the development of new experimental techniques and new methods of analysis.

### **DESCRIPTION OF THE EXPERIMENTAL PROCESS**

One might begin by defining the purpose of an experiment as the reduction of uncertainty about a particular phenomenon or set of phenomena. The experiment itself is like an optical instrument designed to look at the phenomenon. The observations of the scientist using the instrument constitute the data. The scientist

1. This work was supported by the U.S. Air Force, Office of Scientific Research, Grant No. AF-AFOSR-367-63.

is the counterpart of an observer in a visual experiment, and his interpretation of the experimental results is the observer's responses. In other words, when one performs a visual experiment, he is studying processes very similar to those he is performing in conducting the experiment. The same theoretical framework can be applied to the task of evaluating the performance of experimenters as is applied to the evaluation of observers in psychophysical experiments.

Both problems can be illustrated by the same block diagram (Fig. 1). In the simple psychophysical experiment, the message

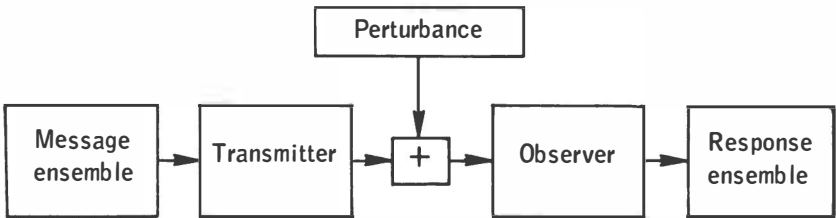

FIG. 1. Block diagram.

consists of a set of signals. In a vision experiment, one such set consists of two signals: a light flash with finite energy greater than zero, and a light flash of zero energy. Ideally, a random selection of the members of the set is made, and the selected signal is then transmitted through the channel. As the signal traverses the channel, it is perturbed. In the case of light signals, the energy spreads and random or irrelevant photons from the environment are added. The observer's input, then, is some combination of the transmitted signal and of the perturbances. It is the task of the observer in responding to indicate which of the signals of the ensemble was responsible for that particular input.

The data for such an experiment are summarized in terms of a measure indicative of the average reduction in uncertainty that can be attributed to the observer's responses. In other words, if the observer's response is known, can the selected signal be better stated than when such knowledge is not available? In information theoretic terms, the entropy of the source, minus the conditional entropy of the response, gives the desired information content for the experiment.

The analysis of an experimenter's behavior in terms of the same block diagram leads to surprisingly parallel statements. The message ensemble is a set of hypotheses, each with an

associated probability. The entropy of this set is the uncertainty of knowledge, prior to the experiment regarding which hypothesis is "true." One of the hypotheses in the set is presumed to be selected by nature for transmission. The transmitter and the channel constitute the experimental design and conduct. The data combine to constitute the input to the observer who, in this case, is the scientist. His response is a scientific publication which, hopefully, leads to a different set of probabilities associated with the hypotheses in the ensemble. The entropy of the latter set is the uncertainty associated with one's knowledge posterior to the experiment. The difference between the a priori entropy and the a posteriori entropy is the information content of the experiment. In other words, how much more is known about the "truth" of the hypotheses after the experiment than before?

Describing the experimental process in terms of the block diagram is essentially a statement of the problem of the design, the execution, and the interpretation of the experiments. The value of a problem statement is determined by its contribution to the solution: How does this statement lead toward a solution?

First of all, the experiment is defined as an instrument to convert probabilities associated with hypotheses from one value to another. The conversion indicates a Bayesian procedure. Letting  $X(E)$  be a function of the experiment, and  $P(H_1)$  be the a priori probability that  $H_1$  is the true hypothesis, Bayes' theorem states the a posteriori probability associated with  $H_1$  as

$$P_{X(E)}(H_1) = \frac{P(H_1) P_{H_1} [X(E)]}{P(H_1) P_{H_1} [X(E)] + P(\bar{H}_1) P_{\bar{H}_1} [X(E)]} \cdot \quad (1)$$

Examination of this equation leads to certain obvious statements.

1. Any hypothesis with an associated a priori probability equal to zero will have an a posteriori probability equal to zero.
2. Any hypothesis with an associated a priori probability equal to unity will have an associated a posteriori probability equal to unity.
3. The statement of associated a posteriori probabilities is a function of the statement of the associated a priori probabilities.

If the probabilities are interpreted as degrees of belief (a reasonable interpretation from the information theoretic point of view), examination of the above statements suggests ways in which a scientist introduces his biases into the design, the ex-

cution, and the interpretation of experiments. At the outset, the first statement indicates that complete disbelief in an hypothesis eliminates that hypothesis from consideration. For example, early experiments conducted within the framework of the theory of signal detectability were not considered by this author in terms of extrasensory perception, although they were by another scientist. Fortunately, he did not have complete belief in his hypothesis and a posteriori, as an explanation for the results, he associated a small probability ( $p < \epsilon$ ) to extrasensory perception.

Another example is that of the experimenter who determines a threshold by having an observer turn a knob until he sees or hears a signal. Built into his design is a credibility of unity associated with the threshold concept. His results are unlikely to question the validity of the concept.

The third statement illustrates the most serious controversy involving the use of Bayes' theorem. How can a set of hypotheses have associated probabilities in the face of a complete lack of knowledge? Perhaps the possible hypotheses cannot even be enumerated. The answer to this dilemma exists in a philosophy of science. As long as one is concerned with a finite set of data, there is an infinite set of possible hypotheses. The probability of identifying that which is true is zero. Thus, the scientist must be content with the knowledge that the probability of proposing an incorrect hypothesis or theory is unity.

Once this attitude is accepted, it is again possible to proceed. Watanabe (1960) has demonstrated that if the set of hypotheses has erroneous associated probabilities, repeated experiments with the application of Bayes' theorem will nevertheless lead to a convergence on the most likely hypothesis of the set. This theorem is a fortunate result, for without it experiments would be useless. If a correct statement were required a priori, this statement would have the same information content as that usually sought as the result of an experiment. If the result could be obtained a priori, there would be no need either for the experiment or for concern with Bayes' theorem.

Watanabe's theorem states that the convergence is to the most likely hypothesis of the set. The set may or may not contain the "true" hypothesis. What, then, is meant by the "most likely" hypothesis? It is that member of the set that is most likely to describe the data. From this point on, the task of an experimenter will be considered that of finding the most likely hypothesis of a set. He is not worried about truth since he knows that this is a fruitless attack. The usefulness of his work, either with

regard to scientific or practical application, depends on the choice of a useful set of hypotheses with which to work.

Further examination indicates the required content of the data. The term on the left of the equation is the a posteriori probability. Contained in the expression on the right are the a priori probabilities and some conditional probabilities. The theorem can be rewritten to express the additional terms as a single operator.

$$P_{X(E)}(H_1) = \frac{P(H_1) \{f_{H_1}[X(E)]/f_{H_1}[X(E)]\}}{P(H_1) \{f_{H_1}[X(E)]/f_{H_1}[X(E)]\} + P(H_1)},$$

where  $f(X)$  is a probability density, and the ratio is described as a likelihood ratio. Thus, the information content of an experimental result  $X(E)$  is contained in a set of numbers which are functions of the hypotheses being tested. If a particular result is equally probable under two hypotheses, it furnishes no information on which to base a choice between the hypotheses. Careful and precise statements of the hypotheses to be tested are essential to efficient experimental design and will point the way to experiments not likely to lead to results equally probable under the various hypotheses.

## THE SIZE OF THE EXPERIMENT

In an attempt to determine how incorporation of a priori knowledge influences the size of the experimental task, some calculations have been performed. The following assumptions are involved in the computations.

1. The hypotheses are each orthogonal to the others.
2. The hypotheses are a priori equally likely.
3. Each hypothesis, if true, leads to an observation containing equal energy.
4. One of the hypotheses is "true."

The amount of energy required to lead to a particular level of confidence was determined as a function of the number of alternatives in the set. For the two cases studied (confidence of 0.75 and 0.90), the energy was found to be linear with the logarithm of the number of alternatives. Since, under the assumptions, the total energy contained in an experimental result is the energy per observation times the number of observations, the size of the experiment required to lead to a particular level of confidence

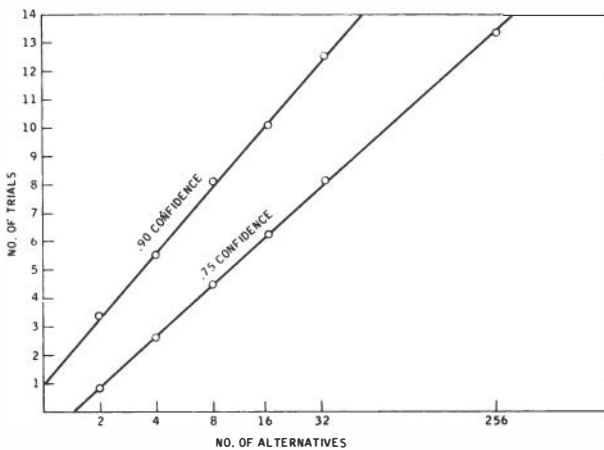

FIG. 2. Number of trials required to achieve a given level of confidence as a function of the number of alternatives.  $d' = 1$  is assumed.

is linear with the logarithm of the number of hypotheses to be tested (see Fig. 2).

The fact that the size of the experiment needed to develop a particular level of confidence is linear with the logarithm of the number of hypotheses to be tested leads to a consideration of the problem of the statement of the hypotheses to be included in the set. One can begin the process by describing as carefully as possible those hypotheses that appear a priori likely. Ideally, the next step is to define a mathematical space that includes each member of the set as well as all linear combinations of elements of the set. Given such a mathematical space, one should then attempt to describe a new set of basic hypotheses which span the space and are orthogonal to each other. The new set is the basis for the experimental design.

At this point, it should be observed that the problem is gradually being shifted. It is no longer that of choosing one of a finite set of hypotheses. It is rather that of searching for a set of coefficients applying to the orthogonal axes of the space. The coefficients are used to describe a point in a continuous space, this point representing the "most likely" hypotheses of an infinite set.

The coefficients are similar to the factor loadings of factor analysis. The dimensionality of the space, however, is determined a priori rather than a posteriori. The coefficients thus are more like those of the Fourier analysis of electrical waveforms.

Consider the possibility of computing the number of observations necessary to reduce the entropy of a parameter coefficient from one value to another. The terms are defined as follows:

$$\sigma_{\text{I}}^2 = \text{initial variance,}$$

$$\sigma_{\text{O}}^2 = \text{variance associated with an observation,}$$

$$\sigma_{\text{P}}^2 = \text{variance of estimate following the experiment.}$$

Now, treating these variances as representing Gaussian noise and letting  $N_{\text{O}}$  equal the number of observations in the experiment, the entropy can be written as

$$H(\text{I}) = \log \pi e \sigma_{\text{I}}^2 = \text{initial entropy,}$$

$$H(\text{E}) = \log \pi e (\sigma_{\text{O}}^2 / N_{\text{O}}) = \text{entropy of observation,}$$

$$H(\text{P}) = \log \pi e \sigma_{\text{P}}^2 = \text{posterior entropy.}$$

Then the reduction of entropy as a result of the experiment is

$$R(\text{E}) = H(\text{I}) - H(\text{P}).$$

By writing  $\sigma_{\text{I}}^2 = \sigma_{\text{I}}^2 / N_{\text{I}}$  as the initial variance representing a number of previous observations, and by writing  $\sigma_{\text{P}}^2 = \sigma_{\text{O}}^2 / (N_{\text{I}} + N_{\text{O}})$  as the a posteriori variance in terms of a variance dependent on both the observations prior to and during the experiment, then

$$\begin{aligned} R(\text{E}) &= \log \pi e (\sigma_{\text{O}}^2 / N_{\text{I}}) - \log \pi e [\sigma_{\text{O}}^2 / (N_{\text{I}} + N_{\text{O}})] \\ &= \log [(N_{\text{I}} + N_{\text{O}}) / N_{\text{I}}] \\ &= \log \{ 1 + [N_{\text{O}} (\sigma_{\text{I}}^2 / \sigma_{\text{O}}^2)] \}. \end{aligned}$$

Solving for  $N_{\text{O}}$

$$\begin{aligned} N_{\text{O}} &= \sigma_{\text{O}}^2 [(\sigma_{\text{I}}^2 - \sigma_{\text{P}}^2) / \sigma_{\text{I}}^2 \sigma_{\text{P}}^2] \\ &= \sigma_{\text{O}}^2 [(1 / \sigma_{\text{P}}^2) - (1 / \sigma_{\text{I}}^2)]. \end{aligned}$$

The last equation indicates clearly that the number of observations required of an experiment, if the a posteriori result is intended to be within a previously specified level of confidence, depends on the incorporation of prior knowledge. The greater the prior knowledge, the smaller the experiment required.

The discussion of size of experiment to this point has been entirely in terms of estimating a single coefficient. If one tries to extend this to a set of  $W$  orthogonal coefficients, then a bandwidth term is introduced, and each of the entropy terms must then be multiplied by  $W$ , as must the size of the experiment.

## ILLUSTRATIVE EXPERIMENTS

### The Imperfect Memory Problem

An example of an experiment in which the suggested technique was used is one performed by the author (Tanner, 1961). In attempting to explain the shape of the psychometric function for the detection of acoustic sinusoid segments in noise, the human observer was conceived as having an imperfect memory. The problem thus became one of establishing an hypothetical space for describing imperfect memories.

The first step was an examination of the knowledge necessary to a perfect memory. This led to the identification of a set of parameters that would describe a segment of sinusoid in its entirety: amplitude, starting time, duration, frequency, and phase. If the memory is not perfect, it seems reasonable to assume that the imperfection will lead to an error in the recorded values for these five parameters. The error has the same effect on performance as an uncertainty in the specification of the signal. For example, if there is no phase memory, but all other memories are perfect, then the performance is expected to be that of an ideal receiver detecting a signal specified except for phase.

An imperfect memory has the same effect on performance as a signal with uncertain specification. Thus, the measure of an imperfect memory is the degree of uncertainty necessary to account for an observed level of performance.

In the experiments, frequency and phase were grouped as a single parameter, starting time and duration as a second parameter, amplitude as a third, and internal noise as a fourth parameter. These four dimensions were assumed to be independent and to be spanning the space in which the likely hypothesis can be described. Experiments were then performed in order to estimate numbers describing an uncertainty introduced by memory imperfection for each of these parameters.

There was actually a sequence of experiments involved in estimating the parameters. The first of these, being a study of amplitude memory as a function of time, provided both an estimate of



the internal noise and uncertainty in amplitude memory. The memory requirements for frequency, phase, starting time, and duration were removed by superimposing the signal to be detected on a pedestal—a segment of sinusoid of the same frequency, phase, starting time, and duration as the signal. This pedestal occurred in each of two intervals in time, with the signal imposed on the pedestal in one of the two intervals. It was the observer's task to state whether the signal was superimposed on the first or second pedestal.

In the experiment described in the preceding paragraph, the variable was the time between the ending times of the two pedestals. It was assumed that the amplitude of the first pulse was measured and then stored until the second pulse for comparison with the measure of that pulse. With the assumption that the pedestals provided the observer with the frequency, phase, starting time, and duration knowledge, then the only uncertainty in this experiment consisted of that introduced by the internal noise to the measures of the amplitude, and a variance added to the first measure as it was stored in the memory. After the data were analyzed for an increase in variance, as the time between the intervals was increased, the curve was extrapolated to zero delay to estimate the internal noise.

A second experiment was then performed in which the knowledge of starting time and duration was removed, although that of frequency and of phase was still provided. The signal to be detected was superimposed on a steady sine wave component added to the noise. The component was of the same frequency and phase as the signal. In order to estimate the uncertainty introduced by the inability to store starting time and duration, it was assumed that the values of the parameters for amplitude and internal noise from the first experiment for each observer still applied.

In a third experiment, the continuous wave was removed from the noise, and a requirement for memory of frequency and phase was introduced. Thus, all of the memory requirements are now demanded of the observer. A parameter estimating frequency and phase uncertainty was determined from this experiment, again on the assumption that the parameters estimated from the previous experiments still applied.

The uncertainties estimated were these: the internal noise reduced efficiency by about 0.3; the variance enlarged by the amplitude memory added one unit of noise every 400 msec; the 50-msec signal appeared to be fixed within a 75-msec interval:

and the frequency could be described as being defined within an interval of 80 to 100 cycles (Tanner, 1961).

### The Problem of Vigilance Behavior

Another example of the proposed design criteria may be found in an analysis of the subject of vigilance behavior. Briefly, the vigilance situation involves tasks in which small, infrequent signals occur at random intervals over long periods of time. There have been a number of experimental studies dealing with varied situations of this general type; several writers have also advanced theoretical formulations with the hope of describing vigilance behavior within a general framework. The kind of effect traditionally observed was that a rapid deterioration in correct signal detections appeared to occur during the task period. An early experimental observation was that these detection rates increased as a function of the input signal rate and decreased with the variability of the intersignal interval. Indeed, the addition of "artificial" signals mixed in with the actual ones appeared to be helpful. The following hypotheses have been suggested in explaining these effects:

1. lowered arousal or alertness level due to task monotony,
2. fatigue or accumulation of inhibition over time,
3. low expectancy, and
4. distraction or attention shifts away from the task.

Two recent theoretical approaches are those of Broadbent (1964), and Jerison and Pickett (1963). Broadbent argues from the point of view of signal detectability theory that perhaps many of the observed vigilance effects are due to criterial shifts over time rather than sensitivity shifts. He noted recently, however, that the data bearing on this question are ambiguous. Jerison and Pickett introduced the concept of "value of observing" in the vigilance experiment. Their construct controls the probability of observing. They suggest that detection failures are attributable to the fact that the observer was not observing at the time the signal occurred. It seems evident from the data presented that these writers are not theorizing about the same phenomena. The difference in explanations suggests that the experiments involved hypotheses existing in different spaces. The practical problem is that it is highly desirable to describe behavior which might exist in certain field situations. Laboratory experiments designed to meet this goal should, then, fall in the same descriptive space as the practical situations. For example, an explanation requiring the concept of "value of observing" is clearly not in the same

space as some tasks of practical interest where the cost of not observing is prohibitively expensive. Indeed, if it were not, there would be no interest in describing behavior in such situations. Thus, defining characteristics of vigilance tasks are the occurrence of signals, the worthiness of observing these signals, and the uncertainty of the arrival time of the signals. In some of the recent studies investigating the decision theory type of explanations of vigilance decrements, such characteristics of the tasks were absent. Other constraints may be crucial for several reasons. First, the signals, when they occur, must not be completely discernible to the observer. Second, the nature of the decision rule employed by the observer may be an important function of the expected time distribution of the signals. An important experimental parameter of what should be considered "vigilance" situations is the degree of uncertainty of the observer concerning the starting time and duration of the possible signals. Realizing that though the early studies by Mackworth (1950) on vigilance did employ clear signals, i.e., clock-pointer double jumps, it seems obvious that again the interest is not in the analogous field situation. It seems evident that such tasks could be easily automated; hence, one could safely avoid the possibly hypnotic effects of clock-pointer watching.

The general problem of memory in such tasks may be an extremely important one and may serve as a possible descriptive dimension. For example, having available noiseless stored reference parameters of the expected signals conceivably can improve detection performance and, indeed, may serve as a partial explanation of the facilitative effect of artificial signal insertion. The decay of such a memory may explain performance decrements over time. An example of an hypothetical vigilance situation, as defined here, illustrates the advantages of the criteria proposed. Consider a detection experiment in which an observer must participate for some period of time. The input is noisy, and occasionally, although infrequently, a signal will be in the noise. The observer is allowed only a fixed number of detection responses; his task is to remain solvent until the task time period is over. He may lose his solvency either by spending all of his detection responses before the time period is over, or by failing to detect and thereby turning off an incoming signal within some short time interval after its arrival. A considerable monetary reward is the payoff for remaining solvent throughout the task time period. Admittedly, such a situation has some difficulties in theoretical analysis. Certain bounds on efficient per-

formance can be established, however, and suitable performance measures conceivably may be developed for describing behavior in such a task. It is clear, for example, that when the a priori probability of a signal at any point in time during the observation period is low, one should adopt a variable false alarm rate such that, on the average, the allowable responses will be exactly used up at the end of the experimental period.

In laboratory experiments, it is probably true, as Jerison and Pickett (1963) suggest, that the observer is guilty of failure to observe, and that this failure may increase as the experiment progresses. The occurrence of this phenomenon may be due to the trivial nature of the experiments, particularly from the point of view of the observer; watching a clock face for a deflection of a needle which may be a low probability event is a task which is unlikely to keep most observers interested. Their thoughts will obviously stray to other things, and even though they may be cooperative observers, they may still fail to respond from time to time. Rather than try to recover data from these trivial experiments, it seems more profitable to look in the direction of an improved experimental design yielding data which can be utilized in terms of some a priori satisfying theory, rather than one which merely attempts to describe the data after it has been collected. The importance of the problem of vigilance is attested by the investment of large sums of money in methods of improving performance in vigilance tasks. In any laboratory experiment in which failure to observe because of the worthlessness of the task is reported, the wrong problem has been studied. The vigilance problem that concerns a worthwhile task is the type to be used as the basis of a laboratory experiment.

## SUMMARY

An explanation of the establishment of criteria for the design of laboratory experiments useful to field situations has been presented. The first step, that of describing the current state of knowledge, is accomplished by stating a set of possible hypotheses to which an associated probability or degree of belief is assigned. The space in which these hypotheses exist is then described in terms of a set of orthogonal dimensions spanning the spaces. The size of the experiment necessary to assign coefficients to the orthogonal dimensions within a predetermined level of confidence is then determined. The procedure was

illustrated by an experiment on memory in psychophysical tasks, and the problem of the interpretation of data obtained from experiments on vigilance was discussed. In conclusion, it is again emphasized that the most important factor is a precise statement of the problem to be studied.

## REFERENCES

- Broadbent, D. C. Vigilance. Brit. med. Bull., 1964, 17-20.
- Jerison, H. J., & Pickett, R. M., Vigilance: a review and re-evaluation Hum. Factors, 1963, 5, 211-238.
- Mackworth, N. H., Researches on the measurement on human performance. Med. Res. Council Spec. Rep. Series, H. M. Stationery Office (London), 1950, No. 268.
- Tanner, W. P., Jr., Physiological implications of psychophysical data. Ann. N.Y. Acad. Sci., 1961, 89, 752-765.
- Watanabe, S., Information—theoretical aspects of inductive and deductive inference. IBM J. Res. Develop., 1960 (April), 4, 2, 208-231.

## VISUAL FITNESS FOR SPACE TRAVEL

Arthur Jampolsky, Ailene Morris, and Carter Collins  
Eye Research Institute  
Presbyterian Medical Center

Determination of visual fitness for an unknown environment is the challenge currently presented. What visual capabilities are required for space travel? How does one provide for unpredictable stresses on an already overloaded man confronted with a mortal dilemma? How can one evaluate and select the man who can meet novel and unknown crises which may involve critical visual performance? To answer these questions new tests adapted to dynamic stressful situations must be developed. What should be done rather than what can be done is the measure to be considered.

Although evaluation and selection on the basis of static tests have been satisfactory for simple tasks, clearly they have not been suitable for complex ones. Static visual tests do not adequately reflect operational needs. Visual parameters presently tested do not necessarily have a bearing on the visual functions required and, indeed, the visual parameters may change during the dynamic or stressful performance situation. For example, in the area of auto driving static visual tests fail completely in adequately selecting night vision capability. An older person with decreased dark adaptability, a slight myopia which will increase at night, a senile pigmentary degeneration or an intraocular scattering of light due to a partial cataract may well pass all of the static daylight tests and yet be a distinct hazard on the road at night. Indeed, he has an almost specific disability for night driving.

The few existing dynamic tests have been more successful for the selection of candidates able to meet complex operational situations; for example, driving qualification tests now include

measurement of glare recovery, dynamic visual acuity, etc. More sophisticated qualification tests involve measurement of visual performance while the subject is made to endure disturbing stresses. Visual fitness can be established best during a totally simulated situation. However, in the interest of economy, critical components of the whole task can be simulated to provide suitable qualification tests.

Physicians have long used the technique of measuring an organ or system before and during known stresses, or under increased performance demands. Stress upon the heart is induced by the subject exercising, and upon the kidney by increasing demands to excrete physiological products or certain drugs. Similarly, the visual system might be evaluated under stresses such as anoxia, vibration, or acceleration. How does one evaluate the effects of psychological factors such as fear, anxiety, and so forth on visual performance?

Many stresses may occur in high-altitude, suborbital, and orbital environments. The critical factor is tolerance to stress rather than possession of basic visual perfection. A person with a "perfect" visual apparatus may fall easy prey to a complete upset of particular visual parameters which will virtually render him visually incapacitated. On the other hand, certain anomalies currently considered disqualifying may actually enhance visual performance under stress. For example, anoxia or alcohol produces an esophoric shift which may result in diplopia if the pre-existing status was normal; and especially so if somewhat esophoric. A person with exophoria actually possesses more latitude for resisting such stress than a "visually perfect" individual. Further, a person with a well-adapted strabismus, such as equal vision alternating exotropia, will not suffer diplopia due to stress of the muscle imbalance; indeed, his distance judgment is good if he is allowed to use his eyes in his own alternate monocular way. He may see in two directions at almost the same time or with rapid alternation because his eyes are already well adjusted to dissociation. Also, one eye may be dark-adapted for cockpit visual tasks while the other eye could be light-adapted for visual search of the sky.

The authors are not so naive as to believe that this notion will be accepted as practical, but it does serve to emphasize the principle that perfection in the different visual parameters, as measured under static conditions, is not to be equated to visual unstressability nor to visual fitness. Relatively unstressable visual apparatus or comfortable visual efficiency may be preferred

to stressable visual perfection. Tests of tolerance to visual stress should be further developed. One must test what one should rather than what one can.

One of the more obvious results of the stress of space travel might be "blackout." The "threshold" tolerance to blackout is a variable thing. A present bias exists that there is a firm basis for it being primarily, if not solely, retinal in origin. This concept is based, among other things, on the fact that the retinal arterioles are seen to collapse at the time of the visual blackout. If one could but see the cerebral vessels one wonders whether these would not similarly collapse. In fact, there are parallels between the watershed of vascular supply to the visual cortex and to the peripheral retina that make one feel that the origin of blackout is perhaps not so firmly understood as may have been supposed.

It should be pointed out that the dynamic tests of performance under stress will necessarily involve reliable means of objectively recording and evaluating visual efficiency. Psychophysical measurements depending on subjective report from a man under stress may be contaminated by the stress, or may be impossible to achieve. Sophisticated electrophysiological techniques involving cross-correlation of stimulus and evoked retinal and cortical potentials may be the means of achieving the above requirements. Further, these objective measurements might be employed without interfering with the primary simulated or actual operational task.

It is hoped that those responsible for visual fitness criteria and selection standards will recognize the lessons from the past: static tests are insufficient to evaluate the dynamic stressful performance situation. Finally, the importance of measuring what one should rather than what one can is again emphasized.



## THE EFFECT OF FLASH DISTRIBUTION AND ILLUMINANCE LEVEL UPON THE DETECTION OF LOW INTENSITY LIGHT STIMULI

Richard E. Wienke<sup>1</sup>

Lockheed Missiles and Space Company

Research in the area of flashing lights as navigational signals has had a primary emphasis on the value of the conspicuity, or brightness equivalence, of a flashing light to a steady-state light. The classical work in the field was done by Blondel and Ray (1912). It has been confirmed and extended by the studies of Toulmin-Smith and Green (1933) and Schuil (1940). Schuil was interested in and determined conspicuity as a function of flash rate.

Those studies have established the functional relationship of intensity in flashing and steady-state lights. However, they do not provide any information about the probability of detection of either light flashes or steady-state lights by subjects who must search a large solid angle. Toulmin-Smith and Green found that a flashing light in the order of 0.149 kmc (0.425 mile-candles) is adequate for visibility against a dark surround. Langmuir and Westendorp (1931) recommended, on the basis of experimental work, that a flashing light should have 10 times the illuminance of a threshold flashing light to ensure detection by the second or third flash. If the nominal of 0.0083 kmc is taken as the threshold of vision, then Langmuir and Westendorp are recommending an illuminance of about 0.083 kmc for signal lights. This is somewhat lower than the 0.149 kmc recommended by Toulmin-Smith and Green, but it is still in fair agreement. Both illuminance values are centered about the 0.13-kmc value produced by a third-magnitude star.

1. Now at the 6570th Aerospace Medical Research Laboratories, Wright-Patterson Air Force Base, Ohio.

Since search has not been a variable in the majority of the reported work, little is known about search and detection of flashing lights. This study was undertaken to determine the capability of naive subjects to detect flashing lights in a large visual field and visually to track dynamic flashing stimuli.

## APPARATUS

The stellar surround was provided by a planetarium in the Morrison Planetarium, San Francisco, California. The projector is similar in design to the Zeiss instrument.

The light flashes were produced by a telescopic projection system that rotated about its axis at the rate of  $1^\circ$  of arc/sec. The light flash was produced by a cam-actuated switch which pulsed a tungsten source. The light pulse had a width of 180 msec when measured one-third peak to one-third peak.

The intensity of the projected area may be determined by the equation:

$$I = BA/144, \quad (1)$$

where  $I$  = the candle power,

$B$  = the luminance of the projected patch,

$A$  = the area of the patch in inches and

144 = the constant to convert from square feet to square inch.

The projector produces a collimated beam, and, within the limitations of the projection distance used, its illuminance is independent of distance. Calibration of the beam yielded a value of 0.70 ft-c. The relationship between illuminance and luminance is:

$$B = ER, \quad (2)$$

where  $B$  = luminance,

$E$  = illuminance in foot-candles, and

$R$  = the reflectance of the surface.

Since  $R = 0.68$ , the luminance was equal to 0.48 ft-c. Substituting this value in Equation (1) gives one known. Therefore, it was necessary to measure the cross section of the light beam. This was 0.192 in.<sup>2</sup> This was also placed in Equation (1). The intensity of the projected spot was  $2.02 \cdot 10^{-4}$  candles.

However, the effective intensity when the lamp is pulsed is known to decrease. This was corrected by the Blondel-Ray equation:

$$I = I_0 (T + 0.21) / T, \quad (3)$$

where  $I$  = the intensity of the flashing source,  
 $I_0$  = the intensity of the steady-state source,  
 $T$  = the flash duration in seconds, and  
0.21 = an empirically derived constant.

The light source therefore had an apparent intensity of  $9.35 \times 10^{-5}$  candles. Since the target was matte and the light patch subtended a visual angle of between 2- and 3- of arc, the inverse square law of illumination is applicable and is accurate to about 2 per cent.

$$E = I/D^2, \quad (4)$$

where  $E$  = the illuminance,  
 $I$  = the intensity of the source, and  
 $D$  = the distance.

The distance between the observer's eye and the patch was, on the average, 10 m and atmospheric attenuation was negligible. Consequently, the illuminance at the observer's eye was equivalent to 0.935 kmc of steady-state light.

Similar calculations indicated that a steady-state illuminance of 0.29 kmc would be required to produce a flash with a conspicuity of 0.13 kmc. This illuminance is that of a third-magnitude star. Equation (1) was solved for  $A$  to produce the required illuminance and the area was found to be 0.45 in.<sup>2</sup> The alteration of area is permissible under Ricco's law which states:

$$AI = C, \quad (5)$$

where  $A$  = the area, providing it is a spot whose diameter is not more than 10-m of arc,  
 $I$  = the intensity, and  
 $C$  = a constant.

Therefore, either area or intensity can be altered to produce the desired change in illuminance.

When the projected patch was compared with the third-magnitude stars in the surround, it was found that the surround stars were too bright. This was corrected by reducing the voltage on the planetarium projector until several of the simulated stars which should have an illuminance of 0.30 kmc appeared to have the same brightness as the steady-state 0.29-kmc calibrated source. This equality was obtained by the method of limits.

Three trained observers were used. The data were recorded on a 20-channel event recorder. One channel was used to record the occurrence of the stimulus; the remaining 19 were activated by the subjects. The subject was instructed to activate the switch when he saw a light flash.

## EXPERIMENTAL CONDITIONS

A total of 130 experimentally naive subjects were utilized. Normally, the subjects were run in subgroups of 19, which were serially labeled 1 through 7. In general, each subject was run only once so that the results would not be confounded by practice effects. However, an exception was made to this rule in subgroups 1, 4, and 7. In the case of these three subgroups, the order of presentation of the conditions was alternated, and a total of four data runs was made.

The temporal and spatial characteristics of the stimulus were produced by the flash generator. The track of the flash was identical in all conditions, but since the stimulus did not pass through zenith, and since the timing was generated at the projector, the number of degrees in the specification of the conditions was less than  $180^\circ$ .

In the first or massed condition, 0.13 kmc flashes were presented in two groups of six flashes each.<sup>2</sup> The first and last flashes were, respectively, about  $30^\circ$  of arc above the southern and northern horizon. Each flash was separated from the next by 1 sec of time and about  $1^\circ$  of arc. The total of 57 subjects was run under this condition.

The second or distributed condition consisted of 12 flashes with a conspicuity of 0.13 kmc. These flashes were presented at the rate of 1 flash each 10 sec, and each was separated by about  $10^\circ$  of arc. A total of 54 subjects was run under this condition. However, the fourth subgroup was inadvertently given an auditory cue in the form of a switch activation about 5 sec before the first flash. The presence of this inadvertent cue made the data of this subgroup suspect; therefore, they were subjected to additional analysis.

The third condition is distributed as was the second. In this case, the illuminance was increased to 0.935 kmc with a sample of 19 subjects.

2. Only 11 flashes were presented to one subgroup of 19 subjects because of equipment failure.

The subjects were given instructions that stated that the first flash would occur in the south and the path of the flashes would be in a northerly direction. They were instructed to search the south constantly, but occasionally to search off toward the north since they might possibly miss the first flash.

Immediately after the instructions were given, the planetarium lights were dimmed and the flash projector was started. Since the flash projector was stopped immediately after it delivered the last flash, there was a period of approximately 4 min before the first flash in the new sequence was presented. Therefore, there were about 4 min of dark adaptation for all subjects in the initial condition. There was a 4 min interval between trials for the three subgroups that were presented multiple trials.

## RESULTS

Table 1 summarizes the number of subjects reporting flashes and the number of flashes reported. It was anticipated that subgroup 4, which had been presented the auditory cue, would be superior to the other subgroups in that condition. Examination of the data in Table 1 tends to sustain that opinion. Therefore, two hypotheses were advanced: first, that the null hypothesis would be sustained between this subgroup and the other subgroups in condition II; and, second, that the null hypothesis would be sustained between this subgroup in condition II and the subgroup run in condition III. They were tested by means of continuity corrected  $\chi^2$  for proportions, and the results are given in Table 2. The first hypothesis advanced was rejected, and the second was sustained. Since this group was atypical it was removed from the remainder of the analysis.

The hypothesis was then advanced that the same proportion of subjects in the three experimental conditions made detections. This was tested by means of standard large sample tests of proportions. The results are given in Table 3. The null hypothesis was sustained between conditions I and II, but rejected between conditions I and III, and between conditions II and III.

It was hypothesized that there was no difference between the proportion of flashes seen under the three experimental conditions. The large-sample proportion statistic was again used and the results are given in Table 4. The null hypothesis was rejected between conditions I and II, conditions I and III, and conditions II and III.

TABLE 1. Effect of Method of Stimulus Presentation and Stimulus Illuminance on Responses to Flashing Lights

Method of stimulus presentation	Stimulus illuminance in kmc	Subject subgroup	Number of subjects	Number of reportable flashes	Number of subject flashes	Number of flashes detected	Proportion of subject detecting flashes	Proportion of flashes detected
I. Massed	0.130	1	19	209 <sup>a</sup>	4	6		
		2	19	228	1	1		
		3	19	228	7	23		
		Total		57	665	12	30	0.21
II. Distributed with auditory cue <sup>b</sup> without auditory cue	0.130	4	19	228	15	91	0.79	0.40
		5	19	228	5	43		
		6	16	192	4	24		
	Total		35	420	9	67	0.26	0.16
	0.935	7	19	228	12	109	0.63	0.49

<sup>a</sup>See footnote 2.

<sup>b</sup>Not included with totals for subgroups 5 and 6.

**TABLE 2. Comparison of Detection of Flashes with and without an Auditory Cue**

Without auditory cue		With auditory cue $\chi^2$
Experimental condition	Iluminance of flash	
Massed	0.130 kmc	24.47*
Distributed	0.130 kmc	12.06*
Distributed	0.935 kmc	0.51

\*Probability less than 0.01.

**TABLE 3. Significance of Difference of Number of Subjects Reporting Flashes**

	0.13-kmc distributed flashes	0.935-kmc flashes
0.13 kmc massed	-0.593	-3.40**
0.13 kmc distributed		-2.62*

\*Probability less than 0.005.

\*\*Probability less than 0.00034.

**TABLE 4. Test of Significance of Differences of Number of Flashes Reported**

	0.13-kmc distributed flashes	0.935-kmc distributed flashes
0.13-Magnitude massed flashes	-20.3*	-12.1*
0.13-Magnitude distributed flashes		-8.7*

\*Probability less than 0.00003.

The effect of practice is shown in Table 5, where the number of subjects that detected flashes is given. The significance of difference was tested by means of correlated  $\chi^2$  that was corrected for continuity. The null hypothesis was sustained between trials 1 and 2 and between trials 2 and 4, but it was rejected for trials 1 and 3, and trials 1 and 4.

The effect of practice on the number of flashes detected is shown in Table 6. It was hypothesized that practice had no effect

TABLE 5. Summary and Analysis of Number of Subjects Detecting Flashes for the First Four Trials

		Number of Subjects Detecting Flashes	
		0.13 kmc	0.935 kmc
Trial 1	Massed 1		Distributed <sub>1</sub>
	Reported	4	12
	Not reported	15	7
	Total	19	19
Trial 2	Distributed 1		Massed <sub>2</sub>
	Reported	7	15
	Not reported	12	4
	Total	19	19
Trial 3	Massed 1		Distributed <sub>2</sub>
	Reported	11	18
	Not reported	8	1
	Total	19	19
Trial 4	Distributed 2		Massed <sub>2</sub>
	Reported	11	17
	Not reported	8	2
	Total	19	19

Statistical Comparison of Trial 1  
 with Trials 2, 3, and 4  
 and Trial 2 with Trial 4

		0.130 kmc	
	Trial 1		Trial 4
Trial 2	2.00		3.12
Trial 3	7.11*		
Trial 4	7.11*		
		0.935 kmc	
	Trial 1		Trial 4
Trial 2	3.12		2.25
Trial 3	9.14*		
Trial 4	6.12*		

\*Significant at the 0.01 level of confidence.



**TABLE 6. Summary and Analysis of Number of Flashes Reported for the First Four Trials**

	Number of Flashes Reported	
	0.13 kmc	0.935 kmc
<b>Trial 1</b>		
Reported	6 Massed	109 Distributed
Not reported	203	119
Total	209	228
<b>Trial 2</b>		
Reported	43 Distributed	94 Massed
Not reported	185	115
Total	228	209
<b>Trial 3</b>		
Reported	36 Massed	162 Distributed
Not reported	173	66
Total	209	228
<b>Trial 4</b>		
Reported	80 Distributed	141 Massed
Not reported	148	68
Total	228	209

**Statistical Comparison of Trial 1  
 with Trials 2, 3, and 4  
 and Trial 2 with Trial 4**

	0.130 kmc	
	Trial 1	Trial 4
Trial 2	-5.28*	-4.00*
Trial 3	-4.40*	
Trial 4	-8.48*	
	0.935 kmc	
	Trial 1	Trial 4
Trial 2	0.501	-3.72*
Trial 3	-5.15**	
Trial 4	-4.24**	

\*Null hypothesis rejected at 0.0001 level of confidence.

\*\*Null hypothesis rejected at 0.00003 level of confidence.

on the number of flashes reported, and this hypothesis was tested by means of a statistic for the testing of proportions obtained from large populations of subjects. It may be seen, for the 0.13-kmc flash, that the null hypothesis was rejected in the case of trials 1 and 2, trials 1 and 3, trials 1 and 4, and trials 2 and 4. It was sustained, for the 0.935-kmc flash, for trials 1 and 2, but rejected for trials 1 and 3, trials 1 and 4, and trials 2 and 4.

Figure 1 shows the cumulative percentage of first detections as a function of serial position. It was found that 67 per cent of the massed 0.13-kmc subjects, 88 per cent of the distributed 0.13-kmc subjects, and 74.9 per cent of the 0.935-kmc subjects made first detections on or before the fourth flash.

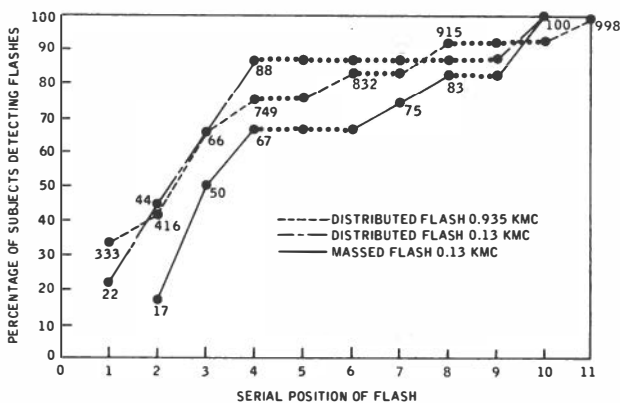

FIG. 1.

## DISCUSSION

The data indicate that the same proportion of subjects made detections when illuminance level was held constant, irrespective of flash configuration. However, a larger proportion of flashes was seen under the distributed condition than under the massed condition. It is hypothesized that this resulted because it was necessary to detect two bursts under the massed condition, whereas tracking of the patch was relatively simple once the initial detection had been made in the distributed condition.

These conclusions would have to have been altered if the fourth subgroup had been included in the analysis. The inclusion of an auditory cue in the experimental condition made the data from this subgroup suspect. Analysis indicated that the subjects in this subgroup made significantly more detections than any

other subgroup which was presented stimuli of the same intensity. It was also indicated that the null hypothesis was sustained between the fourth subgroup and the subgroup which was presented stimuli with an illuminance of 0.935 kmc. It was concluded that inclusion of those data into the general analysis was unwarranted. The error suggests that proper use of auditory cues should be investigated for use in energy-restricted systems.

The analysis suggests that learning is fairly rapid. However, since the design was both incomplete and counterbalanced, all conclusions are tentative. In general, it appears that 50 per cent of the subjects in the 0.13-kmc illuminance condition can make detections after a small amount of training. The subjects given 0.935-kmc stimuli were superior in ability to detect; however, even in their case no single run was made in which all subjects made detections. The ability to learn to detect flashes deserves more study.

Examination of the number of flashes reported again shows the superiority of the distributed over the massed condition. In addition, it is shown that the number of flashes detected generally is a function of the number of trials presented. The evidence is suggestive rather than definitive.

The present study indicates that only one-half to two-thirds of the subjects made their first detection by the third flash. This is inferior to the performance predicted by Langmuir and Westendorp when they stated that one could assure detection by the second or third flash, particularly, when it is considered that between 40 and 80 per cent of the subjects were incapable of making a detection.

There are many obvious differences between the Langmuir and Westendorp study and this study. First, Langmuir and Westendorp used highly trained subjects. They stated that they had corrected for training, but gave no explanation as to the basis of that correction. Second, they searched a relatively small, well-defined solid angle of space. The smaller and better defined the solid angle, the greater the probability of detection becomes. Third, the flash was always static in space. Detection is probably easier when the stimulus does not move.

The 0.13-kmc illuminance used in this study is very near the lower limit of illuminance allowable if detection of the stimulus is critical. This was implicitly recognized by Toulmin-Smith and Green who specified their value of 0.149 kmc for visibility and not for detection. The value of 0.935 kmc should be used for semitrained subjects who have large and ill-defined solid angles

to search. Consequently, present data suggest that the range of illuminance required for successful search and detection of flashing point source stimuli lies between 0.13 kmc and 0.935 kmc.

## SUMMARY

The proportion of light flashes detected by naive subjects was determined as a function of two flash groupings and two levels of flash intensity. One flash grouping, the "massed" condition, consisted of two groups of six flashes. The flashes were presented at the rate of 1 flash/sec with about  $1^\circ$  of arc separations. The groups were separated by approximately 90 sec of time and  $90^\circ$  of arc. The second, or "distributed" condition, consisted of 12 flashes presented at the rate of 1 flash/each  $10^\circ$  of arc and 10 sec of time. The illuminance-level of these two conditions was equivalent to 0.13/kmc. One group of subjects was run under the distributed condition when the illuminance was increased to 0.935 kmc. There was no significant difference in the proportion of subjects detecting flashes where flash distribution was the independent variable. A greater proportion of flashes was seen under the distributed condition than under the massed condition. More subjects made detections when the stimulus was 0.935 kmc than when it was 0.13 kmc.

## REFERENCES

- Blondel, A., & Ray, J. The perception of lights of short duration at their range limits. Trans. Illum. Engrg. Soc. (Amer.), 1912, 7, 625-658.
- Langmuir, I., & Westendorp, W. F. A study of light signals in aviation and navigation. Physics, 1931, 1, 273-317.
- Schuil, A. E. The effect of flash frequency on the apparent intensity of flashing lights having constant flash duration. Trans. Illum. Engrg. Soc. (London), 1940, 5, 117-121.
- Toulmin-Smith, A. K., & Green, H. N. The fixed light equivalent of flashing lights. Illum. Engrg., 1933, 26, 304-306.

## **LANGLEY RESEARCH CENTER SIMULATORS AND STUDIES RELATED TO SPACE RENDEZVOUS AND DOCKING**

**Jack E. Pennington**  
**NASA Langley Research Center**

The best way of investigating many piloting tasks is through the use of simulators that duplicate the mission as closely as possible. National Aeronautics and Space Administration (NASA) Research Centers use such simulators extensively because: (a) all flight parameters can be continuously recorded, (b) parameters can be varied from flight to flight, and (c) simulated flights can be repeated as many times as desired. Much of the simulation work done at the NASA Langley Research Center is devoted to investigating techniques that make maximum use of man's capabilities, thereby tending to minimize system requirements and to increase the probability of mission success.

This paper summarizes the simulation work at Langley Research Center which relates to the rendezvous and docking of two vehicles in space. Current simulators, studies conducted, and visual problems encountered are discussed.

Rendezvous can generally be defined as bringing two vehicles together in space. The visual rendezvous technique, illustrated in Fig. 1, and described in Lineberry, Brissenden, and Kurbjun (1961), utilizes the pilot's capabilities not only to control the vehicle, but also to sense and to process the required information. In the visual rendezvous, the pilot must first visually acquire (or detect) the target. A study of these visual aspects is described in Brissenden (1962), and in Pennington and Brissenden (1963).

Directly after acquisition, an interception course is attained by arresting the angular motion of the line of sight seen as the motion of the target against the star background, which is as an inertial reference. Once the intercept course has been estab-

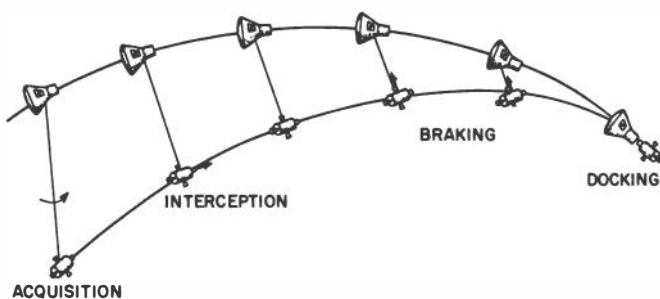

FIG. 1. Phases of visual rendezvous.

lished, the braking operation is begun and continues until the range is a few hundred feet, or less, the point where the docking operation begins.

The acquisition phase of the rendezvous has come to mean detecting a flashing light mounted on the target, at night. Two high-intensity flashing lights mounted on the Agena will enable it to be detected by the Gemini pilots at ranges up to 20 miles. However, such a flashing light can be used only at night, and the power requirements are relatively high. Another technique, currently being studied at Langley, uses optical filtering for detection of a sunlit target. By successively viewing the search area first through a filter that transmits both the background and target, and then through a complementary color filter that transmits the background but reflects the target luminance, the target appears to blink against a steady background, which greatly enhances the target.

Experimental results showed that subjects could detect the target when it was as bright as a fourth- to a fifth-magnitude star. This means that the filtering technique does not change the threshold of detection, but with the use of solar illumination the target could be detected at considerably greater ranges than would be possible with the use of artificial lighting. Research is under way to find suitable coatings and filter combinations which could be used on a manned space vehicle.

Coplanar rendezvous closure control was investigated as early as 1960 (Brissenden, Burton, Foudriat, & Whitten, 1961), assuming a generalized spacecraft configuration and a simple visual display. Non-coplanar simulations of visual and instrumented displays are described in Lineberry, et al. (1961), and Wolowicz, Drake, and Videan (1960), respectively. The results of this

simulation work were important in defining man's part in the Gemini rendezvous, and also strongly influenced the adoption of the Lunar Orbit Rendezvous technique for the Apollo mission. Studies of rendezvous with low thrust levels, such as reported in Beasley (1963), as well as effects of display resolution (Pennington, 1963), also provided design information important to Gemini.

A new simulation using Gemini control parameters is currently under way. The simulator is located inside an inflatable radome which has a diameter of 53 feet (ft)(Fig. 2), and which serves as a planetarium. A star background, target reference, and earth horizon are projected on the walls of the radome.

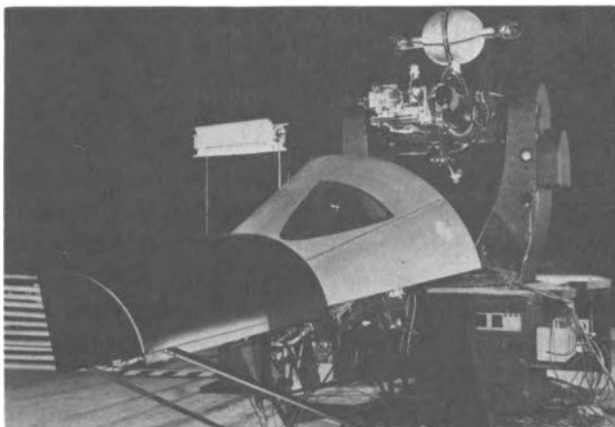

FIG. 2. Gemini simulation equipment.

The simulator (Fig. 2) consists of a static cockpit linked through an analog computer to a modified Nike antenna drive unit, which contains star background, target, and horizon projectors driven dynamically to produce the Gemini's visual environment. The simulator drives the star background in response to a Gemini rotation, superimposes the target against the star background, and drives the target against the background with proper line-of-sight rate. The pilot's ability to detect the target's motion against the star background, which is very small in the Gemini program, is an important factor in completing a successful visual rendezvous.

One problem was encountered in this simulation. When the bright target spot moved near a dim star the star sometimes

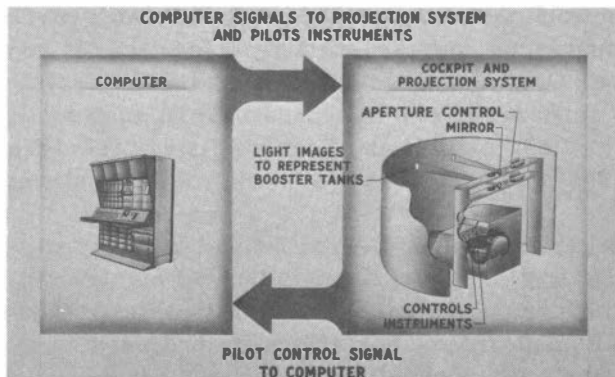

FIG. 3. Visual simulator for remote docking.

disappeared. The pilot would then lose his reference for determining line-of-sight rate. This effect is currently being investigated further.

The docking phase of the mission takes place from a few hundred feet in to zero range. One of the first simulators to study general pilot docking (Fig. 3) utilized two circular light spots projected on a cylindrical screen to simulate remote assembly of two objects, such as fuel tanks, controlled from a spacecraft a short distance away. Riley and Suit (1964) describe this study. An analog computer commanded the images to grow in size or to move relative to each other in response to the pilot's control inputs. This simulation showed that pilots could accurately control the docking or latching using only visual information, and with a wide range of control levels.

Because this early work showed that the pilot could serve as a sensor with sufficient accuracy for visual docking control, two more elaborate simulators have been constructed at Langley to simulate the Gemini-Agena docking with high fidelity.

The first simulator, shown in Fig. 4, is called the Visual Docking Simulator (VDS). It can simulate the docking from ranges up to 300 ft. A closed-circuit television (TV) system and an analog computer are employed. In this system a small-scale model of the target vehicle having three degrees of freedom is mounted in front of a TV camera. The model translates along the camera axis and rotates in response to the pilot's control inputs and the analog computer. The image of the target is transmitted by the TV system to a 2-axis mirror above the Gemini pilot's head and is projected on the inside surface of a 20-ft-diameter spherical screen. Through the added action of this mirror system, all six



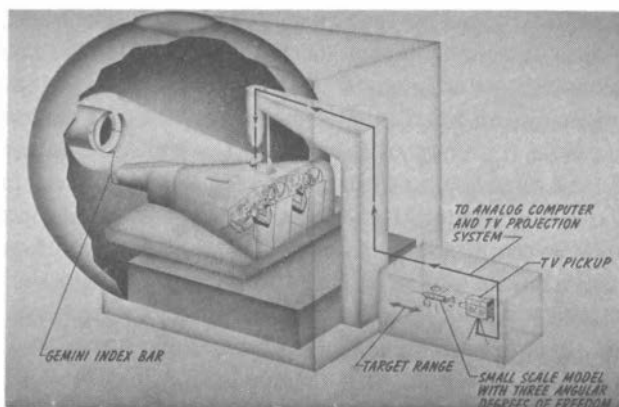

FIG. 4. Visual docking simulator.

degrees of freedom are simulated. The pilot and crewman are seated in a full-scale wooden mock-up of the Gemini vehicle. A moving star field responsive to the Gemini vehicle's angular rates gives an impression of angular motion.

Two of the studies made using the VDS are now discussed. The first investigated the effects of control modes (direct command and rate command) on the pilot's control of docking. The second was a series of flights made under daytime and nighttime lighting conditions to determine any docking problems arising from the target lighting.

The results of the first study showed that it was easier to control the docking in the rate command mode than in the direct mode. This was expected because, in the rate command mode when the controller is returned to zero, unwanted angular rates are automatically damped out, while in the direct command mode the pilot must provide his own damping by applying a manual control input to bring the attitude rates to zero. Somewhat surprisingly, the study showed that the reason the direct mode was more difficult to control was not because the pilot could not make precise corrections, but rather because the pilot could not distinguish between the attitude rates and the translational rates.

The pilot determined the capsule's attitude in the VDS by looking at the nose position relative to the target. Translation cues were obtained from the aspect of the target. The second study, which compared the docking under daytime and nighttime lighting conditions, showed that it was difficult to determine precisely the Gemini's attitude and translation errors during the day, but it was considerably more difficult at night for two reasons. First,

only the cone was illuminated, rather than the entire body of the target. Second, the nose of the Gemini was not lit, so the pilot saw the indexing bar only when it was silhouetted against the illuminated target cone. Thus, the pilot had to use the cone itself, rather than the body of the target for the orientation cues, and the lack of aspect made the problem, in effect, one of docking with a two-dimensional rather than three-dimensional target. Since the pilots could not determine the vehicle alignment, they then concentrated on just flying the indexing bar into the docking slot. As a result, the pilots positioned the indexing bars slightly (about an inch) more accurately at night, but only with a sacrifice in vehicle alignment.

The next logical step was to look for a visual-aid technique that could be added to the Gemini-Agena without a major modification, and that could reduce the inaccuracies and increase the pilot's confidence, particularly in the darkside (night) docking. Several visual aids were tested, using both the VDS and the Rendezvous Docking Simulator (RDS).

The RDS (Fig. 5) involves a full-size model of the cabin and nose sections of the Gemini spacecraft, associated drive systems, a general-purpose analog computer, and a full-size lightweight model of the Agena target. The Gemini capsule is mounted in a hydraulically driven gimbal system which provides three degrees attitude freedom. The entire capsule and gimbal system is, in turn, mounted on a horseshoe-shaped box frame, which is suspended by eight cables from an overhead bridge-crane system.

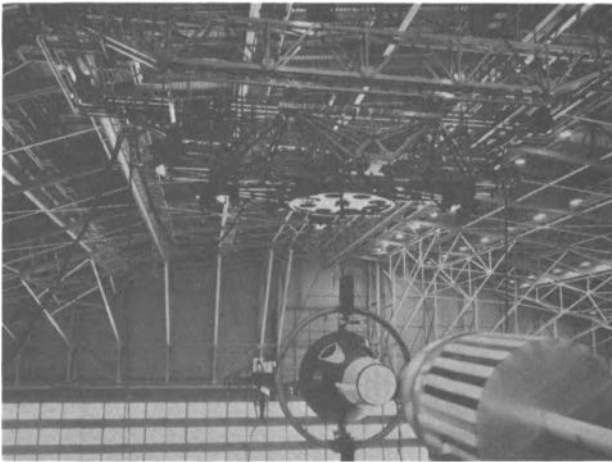

FIG. 5. Full-scale rendezvous docking simulator.

The electrically driven bridge crane provides three degrees of translational freedom. The analog computer commands the drive systems to move the capsule in response to the pilot's control inputs, just as though the capsule were the Gemini vehicle in space. The RDS can simulate the docking from ranges up to 150 ft and permits studies using the actual Gemini and Agena hardware.

Two of the studies made using the RDS are now discussed. The first was an evaluation of the suitability of the Agena Target Docking Adapter, (TDA). The second was an investigation of the effect of thruster failure on the pilot's control of docking.

For the first study, McDonnell Aircraft Company supplied the hardware mock-up of the Agena TDA for use in an investigation of possible problems in docking, using the TDA and an optimization of the Agena's visual aids.

The TDA is shown in Fig. 6. In addition to the docking cone and latching mechanism, it contains two high-intensity flashing lights mounted at about 11 o'clock and 5 o'clock on the Adapter. These lights enable the astronauts to detect the Agena at ranges up to 20 miles. The lights are turned off at 500 ft in order not to distract or blind the pilot. Pilots made part of the simulated flights with these lights on to determine to what extent the docking would be degraded if the lights did not turn off. Pilots agreed that the lights were distracting and reduced the pilot's confidence, but they felt that they could dock successfully, particularly if the lights could be repositioned on the target. If the lights

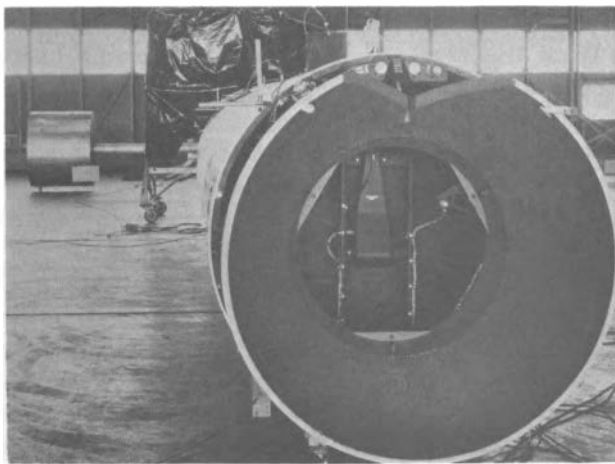

FIG. 6. Production target docking adaptor (TDA).

were placed at 9 o'clock and 3 o'clock they would not be seen by either astronaut when docked.

As mentioned earlier, the night flights had shown a need for a visual-aid technique that could increase the docking accuracy. Two types of aids were indicated. The first aid would be a light to illuminate the nose of the Gemini so the pilot could determine the vehicle's attitude. A floodlight mounted on the capsule to illuminate the nose was tried and found to be satisfactory. The second aid was to be mounted on the target to provide a reference for aligning the axes of the capsule and target. Three aids were tested on the TDS. The first was a probe projecting out of the TDA along the pilot's line of sight. The second aid was a 30-inch square with lights at three corners, mounted near the rear of the target. A light near the front of the target completed the square when the vehicles were aligned. The third aid tested consisted of illuminated vertical and horizontal bars mounted front and back of the target. All the pilots who flew the simulator, including four astronauts, agreed that the bar aids were better.

Another study using the RDS investigated the effects of jet failure on the pilot's ability to complete the docking. The case in which a control jet failed to fire was simulated. If a jet were to fail open (not turn off), the astronaut could cut off the fuel to that particular jet. The situation would then be the same as that simulated. Vertical and lateral jet failures were the most difficult to control because these jets fire singly. All other jets fire in pairs, so if, for example, a braking jet failed to fire it would cut only the control power in half. If a vertical jet failed to fire, however, the capsule just could not move unless the pilot either rolled and fired a lateral jet, or pitched and fired a longitudinal jet. Only these most critical malfunctions were studied, and techniques were developed for overcoming them successfully.

An example of some of the simulation work at Langley related to rendezvous and docking has been presented. Other studies made with the simulators include: (a) technique for manually determining range and range rate during rendezvous, (b) evaluation of the Gemini cockpit instruments and controllers, (c) techniques for reducing control cross-coupling by canting the translation jets, and (d) remote-controlled docking using closed-circuit television.

The VDS and the RDS are excellent examples of closed-circuit TV and dynamic simulators. Each has inherent advantages and disadvantages. Closed-circuit TV permits simulating relatively high velocities and longer ranges, and it is relatively easy to

vary the lighting conditions, but the picture loses fidelity at close ranges, and the minimum range is determined by the distance from the observer to the projection screen. The dynamic simulator gives the pilot the same view he would have from the spacecraft including target aspect, and permits closure to vehicle contact, but it is difficult to eliminate visual cues. Flat black curtains to keep ambient light out of the darkened hangar are used with filters over the capsule windows. Thus, it is necessary to consider not only the pilot's visual capabilities, but also the simulator's visual characteristics.

All of the simulators that have been discussed are used for research rather than for training, so they are designed to be versatile. This permits investigating many problems with one piece of equipment. For instance, the rendezvous simulator will also be used to study the lunar take-off phase of the Apollo mission, the VDS will be used to study space station docking, and the RDS will be used for lunar landing studies.

## REFERENCES

- Beasley, G. P. Pilot-controlled simulation of rendezvous between a spacecraft and a commanded module having low thrust. Langley Field (Hampton, Va.): NASA tech. Note, 1963, No. D-1613.
- Brissenden, R. F. A study of human pilot's ability to detect angular motion with application to control of space rendezvous. Langley Field (Hampton, Va.): NASA tech. Note, 1962, No. D-1498.
- Brissenden, R. F., Burton, B. G., Foudriat, E. C., & Whitten, J. B. Analog simulation of a pilot-controlled rendezvous. Langley Field (Hampton, Va.): NASA tech. Note, 1961, No. D-747.
- Lineberry, E. C., Brissenden, R. F., & Kurbjun, M. C. Analytical and preliminary simulation study of a pilot's ability to control the terminal phase of rendezvous with simple optical devices and a timer. Langley Field, (Hampton, Va.): NASA tech. Note, 1961, No. D-965.
- Pennington, J. E. Effects of display noise on pilot control of the terminal phase of space rendezvous. Langley Field (Hampton, Va.): NASA tech Note, 1963, No. 1619.
- Pennington, J. E. & Brissenden, R. F. Visual capability of pilots as applied to rendezvous operations. Amer. Inst. Aeronautics & Astronautics (Meeting, Jan. 21-23, 1963) 1963, No. 63-15.
- Riley, D. R., & Suit, W. T. A fixed-base visual simulator study of pilot control of orbital docking of attitude-stabilized vehicles. Langley Field (Hampton, Va.): NASA tech. Note, 1964, No. D-2036.
- Wolowicz, C. H., Drake, H. M., & Videan, E. N. Simulator investigation of controls and display required for terminal phase of coplanar orbital rendezvous. Langley Field (Hampton, Va.): NASA tech. Note, 1960, No. D-511.

## **SOME LANGLEY RESEARCH CENTER PLANS IN THE AREA OF VISUAL DISPLAYS FOR LUNAR MISSION SIMULATION**

**Donald R. Riley and Byron M. Jaquet  
NASA Langley Research Center**

As presently planned, Project Apollo will have automatic capability for most phases of the lunar mission. The design over-all probability of success of the Apollo mission is currently specified as 0.90.

In order to meet this criterion, the various subsystems must have very high reliability figures and to improve this number would presumably require some form of man-machine integration. Consequently, the National Aeronautics and Space Administration (NASA) has considerable interest in the utilization of the astronaut to increase systems reliability.

The ability of the astronauts to perform many tasks was demonstrated in planned maneuvers in Project Mercury and, probably more important, was clearly demonstrated in the case of failures of automatic systems. That experience and a wealth of previous experience with man-machine combinations has shown that the reliability of systems can be increased through the proper integration of man and machine. A basic requirement in such a combination is that procedures be available for the man to follow. Preferably, guidance for the application of these procedures should be independent of complex automatic equipment. Many task areas of Project Apollo exist for which simple manual procedures have not been developed, for example, midcourse navigation, orbit establishment, lunar landing, etc. In such situations the first step is to develop piloting procedures for the various tasks, and the next step is to demonstrate the pilot's proficiency in performing the tasks.

Inherent in the development of piloting procedures is the use of man's visual sense. At present, not much visual experience

exists in the space environment. In addition, it is not easy to acquire. At the present stage of development several years of preparation are invested in each manned space program. Each mission is planned in detail and practiced in order to acquire proficiency and to assure success. This procedure dictates the use of simulators and inherently specifies that sophistication will be required if realism is to be obtained.

The present paper reviews the work at the Langley Research Center in this area, stressing simple piloting procedures which are based on visual cues, and describes in some detail the use of visual cues and how these cues will be generated in the simulators.

## DEVELOPMENT OF PROCEDURE

The areas being examined at the Research Center are listed on Fig. 1. They include earth entry, rendezvous, docking, midcourse navigation, orbit ephemeris determination, lunar orbit establishment, powered lunar descent, hover and translation, and lunar launch. A first step is the development of a simple piloting procedure. Consider, for example, a powered mission phase; in this situation the primary task of an automatic or manual guidance system is simply to point the thrust vector in the proper direction. Therefore, in looking for a simple manual guidance technique visible references are sought which an astronaut can use for orienting the thrust vector. Solutions to this problem take the steps shown in Fig. 2. First, compute a fuel-optimum maneuver for the task. Then, examine the results to see how the thrust vector orientation changes relative to references external to the spacecraft. In most cases, some reference exists so that the angle between the thrust vector and the line of sight to that reference remains about constant during the maneuver. The

- | EARTH ENTRY
- | RENDEZVOUS
- | DOCKING
  
- | MIDCOURSE NAVIGATION
- | ORBIT EPHEMERIS DETERMINATION
  
- | LUNAR ORBIT ESTABLISHMENT
- | POWERED LUNAR DESCENT
- | HOVER AND TRANSLATION
- | LUNAR LAUNCH

FIG. 1. Task areas under study.

1. COMPUTE OPTIMUM MANEUVER
2. EXAMINE THRUST VECTOR ORIENTATION
3. RECOMPUTE MANEUVER USING VISUAL REFERENCE
4. ERROR ANALYSIS OF TECHNIQUE
5. MAKE SIMULATOR STUDY USING TECHNIQUE

FIG. 2. Procedure for selection of simplified piloting technique.

next step is to compute the maneuver based on use of the reference and to compare the results with the optimum maneuver. If the maneuver looks reasonable, an error analysis is made to determine the sensitivity of the procedure to reasonable operational errors. The most promising techniques at this stage are tried on a simulator.

### LUNAR DESCENT

As an example of the technique, consider Fig. 3, which is concerned with lunar landing. It was assumed that after applying thrust, a lunar excursion module separated from a spacecraft which was in an 80-nautical-mile-altitude orbit around the moon. The module descended on a Hohmann transfer ellipse to a pericynthion altitude of 50,000 (ft). It then made a gravity-turn powered descent toward the lunar surface. On examining the orientation of the thrust vector relative to various references, it was

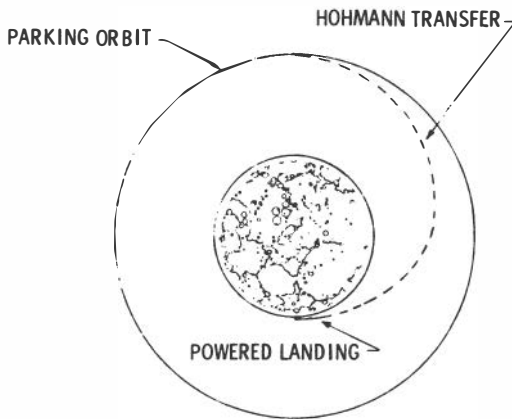

FIG. 3. Lunar descent.



noted that the angle between the excursion-module thrust vector and the line of sight to the orbiting spacecraft remained very nearly constant during the powered descent phase (see Fig. 4.). Subsequent error analyses indicated that the orbiting spacecraft would be a suitable reference for manual control during the descent (Barker & Queijo, in press; Barker, in press). Some enhancement of the orbiting spacecraft, possibly by the use of a high-intensity flashing beacon or a filtering technique (Pennington, 1964) would be required to assure visual acquisition for the range of the maneuver. It is worth noting that the large variation in the angle  $K$  shown at the lower end of the altitude scale would, of course, require the astronaut to obtain some other visual reference. At this point, it so happens that the excursion module is now operating within the altitude-speed range of many high-performance airplanes, and previous airplane experience would indicate that an out-of-the-window view of the surface would suffice from this point to touchdown.

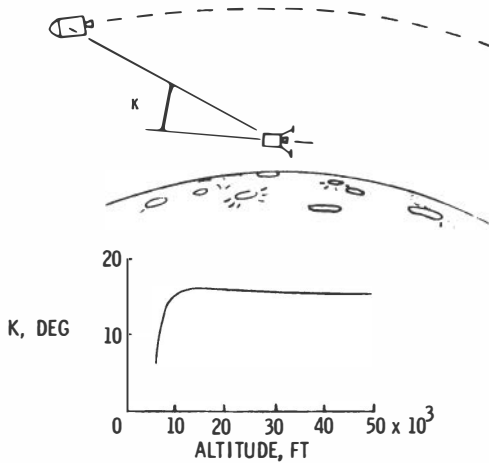

FIG. 4. Lunar landing.

Studies along these lines have been made and others are in progress for many tasks associated with lunar landing missions. Manual procedures utilizing visual references for guidance are being developed for most of these tasks. Some of these procedures already have been tried on available simulators, and some must await the activation of more sophisticated simulation devices.

## ORBIT ESTABLISHMENT

Some additional lunar mission tasks, the procedures developed for each task, the visual cues required, and the generation of the cues in simulation devices are now reviewed. Consider the task of establishing an orbit around the moon. The problem is illustrated in Fig. 5. The vehicle approaches the moon on a hyperbolic trajectory. The task is to establish an 80-nautical-mile-altitude circular orbit, which means reducing the vehicle radial and tangential velocity components and altitude to the desired orbital values.

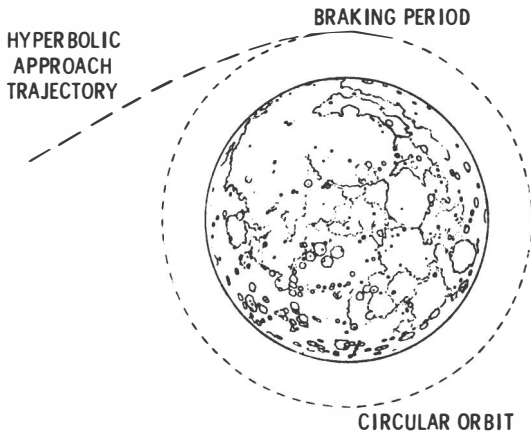

FIG. 5. Orbit establishment.

An analytical study showed that the lunar horizon would be a convenient reference for thrust-vector orientation in the pitch plane, and that stars would, of course, be good yaw or azimuth references. In fact, Mercury experience indicated that the astronaut could align the capsule in yaw within a couple of degrees just by observing the convergence of the surface features through the window. In other words, it appears that the astronaut could navigate by aiming his vehicle, using a scribed windshield or some other simple sighting device, possibly as shown in Fig. 6. Here the lunar surface and several stars are shown. Elevation or pitch angles could be set using the lunar horizon. Convergence of the landscape on the grid could be used for azimuth alignment, while the stars and the grid could be used to obtain a desired angular displacement. In order to provide these cues

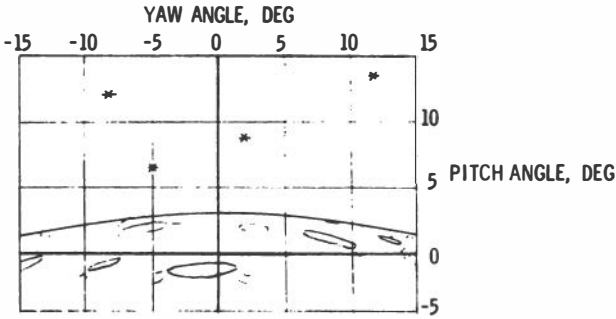

FIG. 6. Window for vehicle alignment.

in a simulator, it is necessary to show the horizon, surface features, and stars with proper relative motion to correspond to spacecraft movement. At present, there is no device for projecting or displaying properly all of this information, so it has been necessary to revert to the use of a cathode-ray tube (CRT) to generate representative stars and a horizon. The scribed lines on the CRT correspond to the spacecraft window lines. This simulator will be used for a preliminary evaluation of the procedures for establishing orbits. By the summer of 1965, the Lunar Orbit and Landing Approach (LOLA) simulator should be operational, and there will be a good means of generating the horizons and surface features. At that time, star projectors will be used for star displays. The LOLA simulator is described in detail subsequently in this paper.

### ORBIT EPHEMERIS DETERMINATION

The next task to be examined is that of orbit ephemeris determination. The problem is simply that of finding the characteristics of an orbit as determined from on-board sightings. Two basic procedures for doing this have been proposed as shown in Fig. 7. One depends on the use of lunar landmarks and measure-



FIG. 7. Orbit ephemeris determination.

ments of such parameters as rotation of a line-of-sight, altitude, altitude rate, etc. The other depends on taking sightings on orbiting spacecraft and determining range and range rate. Thus, there are two different techniques to evaluate, and the visual cues to be generated are completely different. The one requiring lunar surface features will be evaluated on LOLA. The other requires the generation of a spacecraft image. In this case, the spacecraft will probably be represented by a light spot.

## LUNAR LANDING

The most critical phase of the lunar mission will be the final part of the powered descent and touchdown. Experience with airplanes and helicopters has demonstrated that man can perform landings much better and more reliably than any automatic system. The lunar landing, therefore, is one task area which will be investigated with as much realism as practical. Here, of course, the visual cues required are the lunar surface features, and since appreciable accelerations are involved motion cues become important. The final portion of the lunar landing will be studied on the Lunar Landing Research Facility, which is described subsequently.

## LUNAR ORBIT AND LANDING APPROACH SIMULATOR

Currently under construction at the Langley Research Center are two rather sophisticated simulators. One of these is the LOLA simulator, which is illustrated in Fig. 8. This simulator consists of four models of the lunar surface, viewing systems to transmit views of the models to the display area, and a four-porthole display system. The four models were selected on the basis of a desired simulated altitude range of about 200 miles to 200 ft for a wide range of trajectories. Design considerations included a minimum distance from viewing optics to the models of  $3/4$  in., and a practical size for construction and housing in an existing structure. The region around Crater Alphonsus was selected as the landing site for simulation studies because of scientific interest and because regions of the most rugged mountains on the moon lie on the approach. Therefore, it presents the pilot with an exacting navigational task. Orbital inclinations up to  $15^\circ$  can be simulated with the spherical model. The surface of the spherical model will be smooth with the lunarscape painted on plastic gores which are then mounted on the surface. All other models

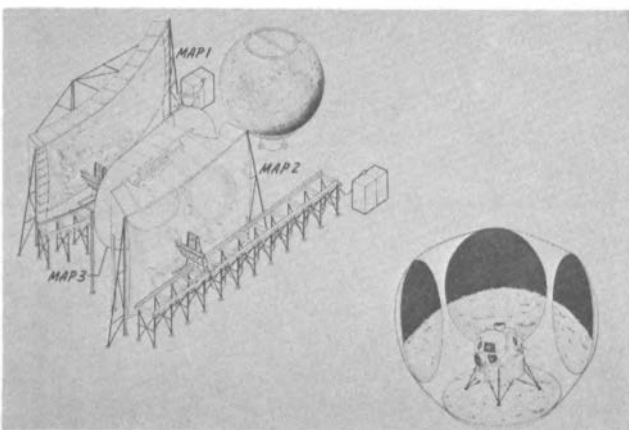

FIG. 8. Lunar Let-Down Simulator.

are in relief with painted shadow patterns to give the proper appearance. All models are internally or back-lighted. Direct solar illumination was chosen as the lighting condition so that the lunar surface features would appear under low contrast. This should reduce the facility to see the features and provide an adverse viewing condition, as compared with other lighting conditions in which shadows are more prominent.

The models are viewed by clusters of television cameras mounted on transport mechanisms. The transport mechanisms have three translational degrees of freedom. In addition, the camera clusters are gimballed to provide three angular degrees of freedom so that motion with a full six-degrees-of-freedom can be simulated. One group of four TV cameras furnishes the display information to the pilot at any given instant. A simulated vehicle will have four portholes, a TV camera providing each with a  $65^\circ$  simulated field of view. The display will present the pilot with realistic terrain features, such as the irregular lunar horizon and close-up features when in the final landing approach.

Pilot control signals are transmitted to the computer which, in turn, drives the transport and gimbal mechanisms so that the pilot, in effect, flies the cameras over the lunar surface. During a descent, the system viewing the spherical model of the moon will furnish display information to the pilot until the lower limit of travel is reached. Before this lower limit is reached, the second camera cluster is automatically switched on for Map 1. Similar switching will be made through the remainder of the descent.

The size, scale factors, and altitude range of each model are shown in Table 1.

TABLE 1.

Model	Size	Altitude Range	Model scale
Sphere	20-ft D	200 mi. to 7 mi.	1 in. = 9 mi.
1	15 ft x 40 ft	7 mi. to 1.5 mi.	1 in. = 2 mi.
2	35 ft x 25 ft	1.5 mi. to 3/8 mi.	1 in. = 1/2 mi.
Ellipse	34.9-ft major axis 22-ft minor axis	3/8 mi. to 200 ft.	1 in. = 200 ft.

In order to use the sphere and Map 1 before the TV system is operational, a 180° motion-picture camera-projector has been developed. Preprogrammed trajectories will be filmed. The motion pictures will then be projected within the sphere giving a 180° field of view. The pilot will be an observer and will not have control over the display. This presentation will be used to test man's ability to perform observational tasks which would precede any control action and to determine his orbital ephemeris.

LOLA should help define those control tasks best performed by man or machine, and thus will determine an effective man-machine integration for the lunar mission. Studies with the preprogrammed trajectories should begin in the latter part of 1964, and the complete system should be in operation about a year later.

## LUNAR LANDING RESEARCH FACILITY

Because gravity on the moon is one-sixth that of the earth, thrust levels for lunar operations are very low compared with those required for vertical taken off or landing (VTOL) flight on earth. To produce reasonable horizontal accelerations for braking and maneuvering during lunar landing, large attitude angles, up to 30° or more, will be required. A facility designed to study the piloting problems close to the lunar surface is presently under construction at Langley. This simulator with its associated equipment is known as the Lunar Landing Research Facility. Simulation with this facility begins at about the altitude where LOLA stops.

An over-all layout of the facility is shown in Fig. 9. The gantry supports a traveling crane from which the vehicle is suspended. The crane system supports five-sixths of the weight

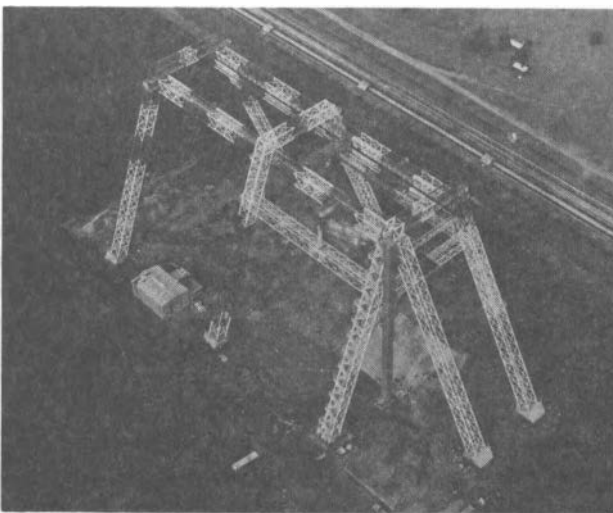

FIG. 9. Lunar Landing Research Facility.

of the vehicle through serv-controlled vertical cables, while the remaining one-sixth of the weight pulls downward and simulates the lunar gravitational force. The overhead crane is slaved to move with the vehicle linear motions to keep the cables vertical. A gimbal system on the vehicle permits angular freedom in pitch, roll, and yaw.

Vehicles weighing up to 20,000 (lbs), and as large as the full-scale lunar excursion module used in the Apollo Project, can be tested on this facility. The pilot can maneuver in complete  $6^\circ$  of freedom in a volume 400 ft long, 165 ft high, and 50 ft wide. Through the use of a catapult, initial velocities up to 50 feet per second (fps) horizontally and 40 fps vertically can be provided.

A photograph of the general research test vehicle is shown in Fig. 10. The vehicle gross weight is 10,000 lbs including a two-man crew and 3,300 lbs of fuel. Fuel is 90 per cent hydrogen peroxide. The main motors provide 6,600 lbs of thrust with a ten-to-one throttling range. Attitude motor thrust is ground-adjustable to produce angular accelerations from 0.1 to 0.5 radians per second per second ( $\text{rad}/\text{sec}^2$ ) about all axes. The fuel load will permit about 3 minutes of operation.

The pilot's bubble can be masked to determine the effect of the viewing area on his ability to land safely. It is anticipated that requirements for instrument displays will be developed as the simulation program proceeds. The establishment of requirements for performing a lunar landing will be accomplished by

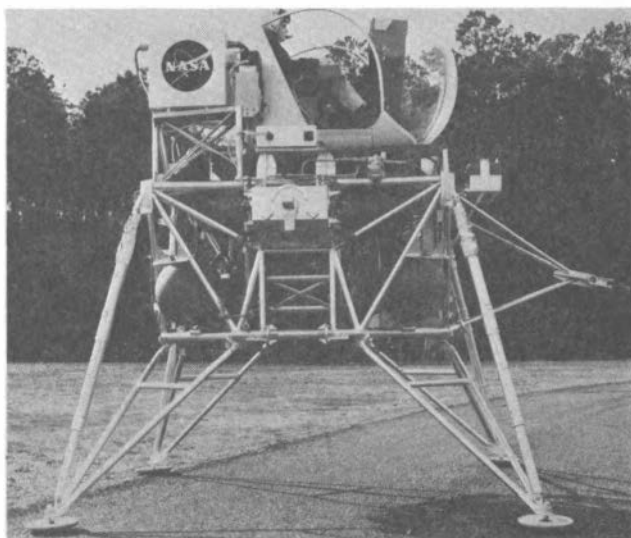

**FIG. 10.** General research vehicle for Landing Research Facility.

measuring pilot performance. Piloting techniques, visibility, and abort modes will be major items of study using this simulator. Construction of this facility was started in September 1962. Research studies were started in 1964.

#### **CONCLUDING REMARKS**

In conclusion, the Langley Research Center has been examining, through analytical and simulation studies, simple guidance techniques for pilot control of various tasks associated with the lunar mission. These simplified techniques and pilot utilization should increase the reliability of Project Apollo and other manned space missions. Results of simulator studies conducted thus far have shown that, given proper information, pilots can perform rendezvous and docking, although these missions have not actually been performed in space. The usefulness of simulator devices, however, has been demonstrated in Project Mercury. Simulation devices such as LOLA and the Lunar Landing Research Facility will provide information necessary for the lunar and other space programs.



## REFERENCES

- Barker, L. K. A technique for thrust-vector orientation during manual control of lunar landings from a hohmann transfer. Washington, D.C.: NASA tech. Note, in press.
- Barker, L. K., & Queijo, M. J. A technique for thrust-vector orientation during manual control of lunar landings from a synchronous orbit. Washington, D.C.: NASA tech. Note. in press.
- Pennington, J. E. Langley research center simulators and studies related to space rendezvous and docking. Paper presented at meeting of Armed Forces-NRC Committee on Vision, (April 23-24) 1964, Washington, D.C. (Included elsewhere in these Proceedings)

## VISUAL MASKING USING DIFFERENT TEST STIMULUS PATTERNS

Robert C. Boyle<sup>1</sup>  
NASA Ames Research Center  
Moffett Field

Temporal delay in human visual processes assumes a greater importance as the velocities of travel increase. In fact, at very high velocities an observed event can occur and be past before the observer is even aware that he saw the event. This visual latency increases under conditions of low illumination. The data from this present study give some idea of how visual latency increases as object luminance decreases.

One approach to the study of visual perceptual latencies is by means of a visual phenomenon called visual masking, which has been studied under various other names. It was called masking by Piéron (1925), rapid light adaptation by Boynton and Kandel (1957), perceptual blanking by Lindsley (1961), and perceptual interference by Kietzman (1962), and Boyle (1963). In this study the term visual masking refers to the gradual reduction of correct responses as to the orientation of a patterned test stimulus as the temporal interval between the test stimulus and a succeeding brighter masking stimulus is decreased. A latency model of visual masking was used to explain the obtained results. It has been stated by Cheatham (1952) and Keitzman (1962) that a latency model of visual masking cannot explain the divergent results that are obtained when using different test-stimulus patterns under otherwise similar conditions. It is the thesis of this experiment that even though the constants of an equation based on a latency model of visual masking may vary some with different test-stimulus patterns, the variation, despite its significance, will be relatively minor and the equation will retain its general latency form.

1. Resident Research Associate, National Academy of Sciences.

## METHOD

Figure 1 shows a block diagram of the experimental system. Fourteen numbered program steps and the four test slide positions are prepunched on paper tape and operate through the relay logic block to present the various conditions. The neutral-density filter selector servo-system is controlled by external panel controls. The test-stimulus positioning servo-system is directly

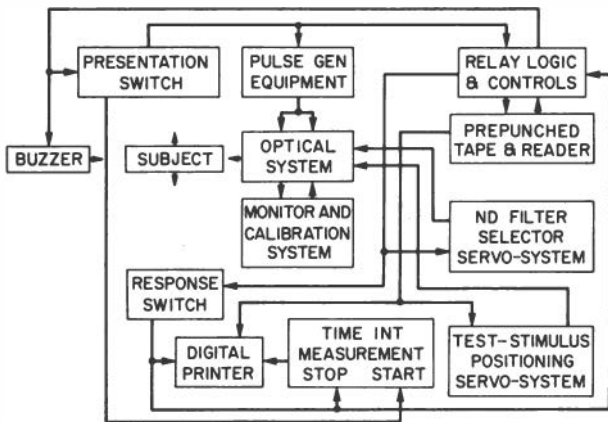

FIG. 1. Block diagram of experimental system.

controlled by the prepunched paper tape. Activation of the presentation switch by the subject starts a timing counter, begins the pulse generator, and prepares the tape reader to advance the paper tape to the next position. To indicate the test-stimulus direction, the subject activates a four-position response switch which stops the timing counter and initiates test-stimulus repositioning. The preselected stimulus position, the subject's selection of the stimulus position, and his response latency (mainly to insure that the subject is not drowsy) are printed out on the digital printer. The buzzer informs the subject when the presentation switch is rearmed. The optical and monitor system is shown in Fig. 2. The optical system consists mainly of a monocular Maxwellian-view optical system, with Sylvania R1131C glow modulators as light sources, and a red fixation-light source. The pulse generator initiates the pulses which "fire" the glow modulators,  $GM_{TF}$  and  $GM_{BF}$ . These in turn are activated by an ultraviolet source (UV) to eliminate erratic operation of the glow modulators in the dark. The filters  $F_1$  and  $F_2$  eliminate visible light from the ultraviolet light source.

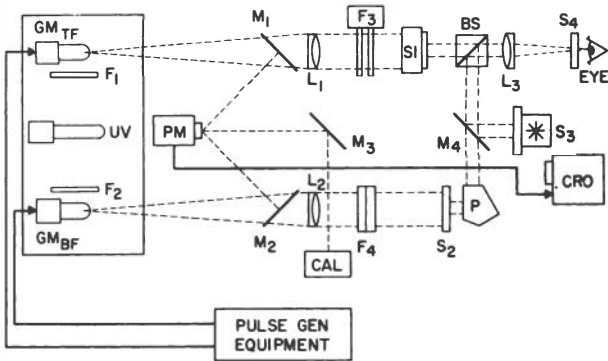
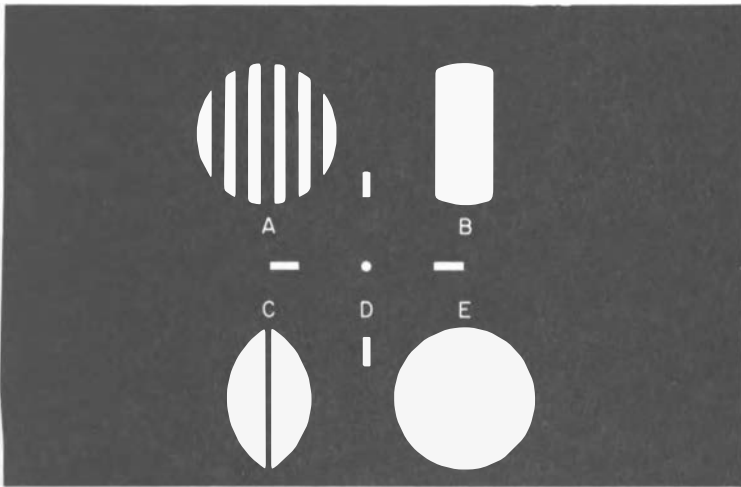

FIG. 2. Schematic diagram of optical system.

Glass slides  $M_1$  and  $M_2$  reflect a portion of each light beam to a photomultiplier (PM) which permits equating the luminances of the two light sources by means of an oscilloscope (CRO). Beyond  $M_1$  and  $M_2$  the light beams are collimated by lenses  $L_1$  and  $L_2$  (508-millimeter (mm) focal lengths).  $F_4$  is a filter holder for neutral density filters, and  $F_3$  represents a pair of servo-controlled filter wheels in the light path of the test flash. Similarly,  $S_2$  is the fixed reticle holder for the blanking stimulus, and  $S_1$  is the servo-controlled reticle holder for the test stimulus. The blanking-flash beam is reflected at  $90^\circ$  of arc from itself by means of a pentaprism (P), combined with the red fixation pattern ( $S_3$ ) at glass slide  $M_4$ , and is superimposed upon the test-flash beam at a beam splitter (BS). This combined beam is then focused upon the cornea of the subject's eye by lens  $L_3$  (508-mm focal length) through a 3.65-mm artificial pupil ( $S_4$ ).

To insure that the illumination is always set at the same level, a calibration circuit (CAL) is incorporated in the system. A beam of light is passed through a chopper and is reflected from mirror  $M_3$  onto the photomultiplier (PM). Mounted on  $M_3$  is a cadmium sulfide photocell that is one leg of a bridge circuit. The light source is varied until a zero reading is obtained from a meter in the bridge circuit. Then the amplitude of the calibration light source can be determined from the oscilloscope, and the test and blanking-flash amplitudes are set at this same level.

Figure 3 shows the various reticles used in the experiment. A, B, and C were the three equal-area test stimuli used, E the blanking-flash stimulus, and D the fixation pattern. Each test slide has four positions: up (|), down (-), left (\), and right (/). As seen by the subject, the blanking flash was superimposed upon the test flash in the open central area of the fixation pattern.



**FIG. 3.** Reticle patterns used in experiment. A, B, and C are equal area test flash patterns, D is fixation pattern, and E is blanking flash pattern. White areas represent lighted portion of pattern as seen by subject.

The visual angle subtended by the test and blanking flashes was  $1^{\circ}42'$ . Both stimuli were effectively square waves of 10 milliseconds (ms) in duration with luminances of 4358 millilamberts (ml) for the blanking flash and 2566 ml for the test flash (no filters) as measured at the plane of the subject's eye by means of a Pritchard Photometer. The red fixation pattern was easily visible and was present continuously throughout the session.

## SUBJECTS

The three subjects studied were Moffett Field Naval personnel. They were all trained on all three test stimuli over a 2-week period. All three had emmetropic vision with 20/20 visual acuity or better for the right eye as measured by a Bausch and Lomb Ortho-Rater. Throughout the experiment each subject used only his right eye.

## PROCEDURE

Given subject aligned himself in the apparatus and dark-adapted for 10 minutes. At the end of this time, a ready signal was given and, when he was prepared, the subject could initiate the signal presentation by pressing a hand-held switch. The subject's task

was to identify the position (up, down, left, or right) of the test stimulus. He had to indicate his response each time by means of the four-position response switch or the programmed tape would not advance to the next step. Two conditions were run. Generally, the conditions were randomized except that one test-stimulus pattern was completed before a new test-stimulus pattern was begun. Each condition consisted of a preliminary warm-up run of 12 presentations, followed by 6 more runs of 23 presentations each with a minimum of 7-1/2 seconds between presentations. The first three presentations of each run were eliminated from the data as they were for light-adaptation purposes only.

The dependent variable was the percentage of correct responses (0 to 100 per cent) corrected for a 25 per cent chance level. The independent variables were test-flash luminance (1.61 to 5.61 log microlamberts ( $\mu l$ ) in six 0.1-log neutral-density filter steps for each condition), test-stimuli forms (three), and the interval between test- and blanking-flash onsets (10, 13.5, 18, 26, 39, and 70 ms). The blanking-flash luminance was 6.64 log  $\mu l$ . Each condition was repeated three times, and then averaged to obtain a better estimate.

## RESULTS

Preliminary data are shown in Figs. 4, 5, and 6. From Fig. 4, it can be seen that visual masking decreases as test-flash luminance is increased or as the interval between the test flashes and blank-

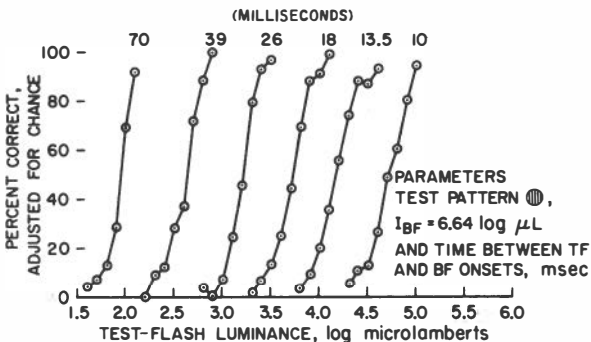

FIG. 4. Percentage correct (adjusted for 25 per cent chance level) as function of test-flash luminance and interval between test- and blanking-stimulus onsets for coarse-grating stimulus. Each curve represents average of three repetitions of each condition for all three subjects.

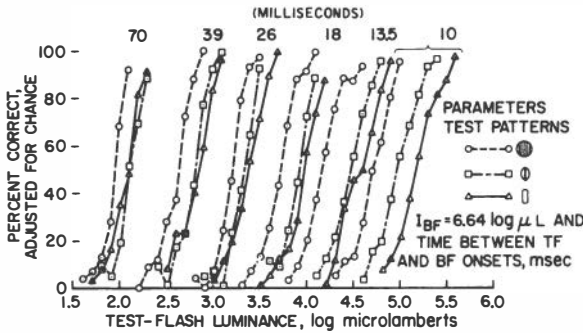

FIG. 5. Percentage correct (adjusted for 25 per cent chance level) as function of test-flash luminance, interval between test- and blanking-stimulus onsets, and test-stimulus patterns. Each curve represents average of three repetitions of each condition for all three subjects.

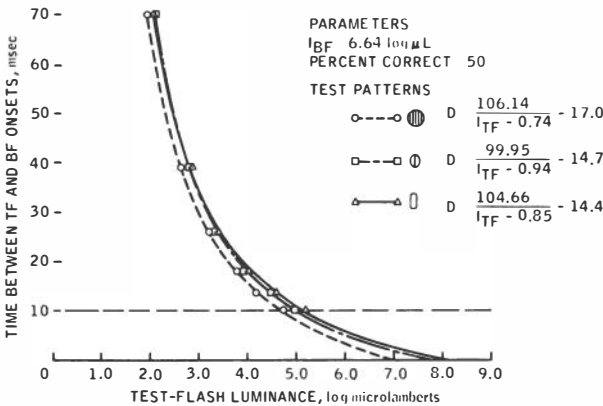

FIG. 6. Time between test- and blanking-flash onsets as function of test-flash luminance and test-stimulus patterns at constant 50 per cent correct level. Plotted points obtained from curves of Fig. 4, and smooth curves calculated from indicated equations. Break from calculated curve (for which data were not obtained in this experiment), occurs beyond 10 ms as indicated by dashed line at that interval.

ing flashes is increased. Figure 5 gives the same data as Fig. 4, but for all three test stimuli. It can be seen that the coarse grating is more easily seen while the rectangular form is generally the hardest to see.

Test-flash luminance values were taken from all of the curves

of Fig. 5 at the 50 per cent correct level. These are the points plotted in Fig. 6. A preliminary equation was fitted to each set of these data. They are included in Fig. 6. The smooth curves were plotted from values calculated from the equations. When the data were plotted in the form of Fig. 6, it could easily be seen that, as the test-flash luminance was increased, the interval between stimulus onsets had to be decreased in order to operate at the same level of performance (50 per cent correct). It should also be noticed that all three curves are quite similar to each other.

### DISCUSSION

The equations derived from the data were based on a latency model. In other words, it was hypothesized that the time interval between stimulus onsets could be determined from the difference between some inverse function of the test-flash luminance and the blanking-flash luminance, as shown in Equation (2). A schematic of this model is shown in Fig. 7. If one imagines an electrode implanted in the brain to measure evoked potential latencies at the point where visual masking occurs, TF refers to the time the test flash was initiated, and  $T_{TF}$  to the latent period after which an evoked potential ( $TF_e$ ) to the test flash appeared. D refers to the time after the test flash (TF) was initiated that the blanking flash (BF) was initiated, and  $T_{BF}$  is the latent period after which an evoked potential ( $BF_e$ ) to the blanking flash

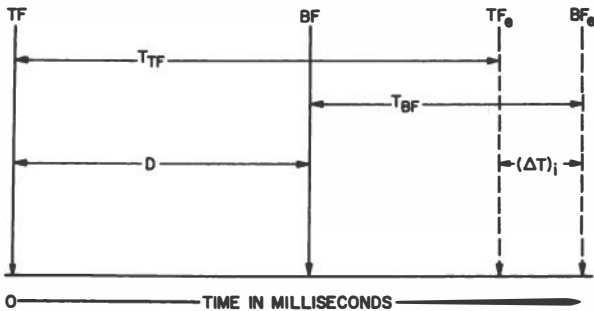

FIG. 7. Hypothesized relationship between test-flash evoked potential latency ( $T_{TF}$ ), blanking-flash evoked potential latency ( $T_{BF}$ ), interval between test-flash and blanking-flash onsets (D), and the difference in latency  $[(\Delta T)_i]$  between  $T_{TF}$  and  $T_{BF}$  under visual masking conditions. TF and BF refer to physical light stimuli, while  $TF_e$  and  $BF_e$  refer to physiological potentials evoked by TF and BF stimuli.



appeared.  $(\Delta T)_i$  refers to the time differential between test-flash and blanking-flash evoked potentials under visual masking conditions.  $(\Delta T)_i$  is assumed to vary directly with the percentage of correct responses. The entire relation can easily be stated in mathematical form.

$$D = T_{TF} - T_{BF} + (\Delta T)_i \quad (1)$$

$$= f\left(\frac{1}{I_{TF}}\right) - f\left(\frac{1}{I_{BF}}\right) + f(Z). \quad (2)$$

$D$  is the interval between test- and blanking-flash onsets,  $I_{TF}$  is the test-flash luminance,  $I_{BF}$  is the blanking-flash luminance, and  $Z$  is percentage correct (corrected for chance) converted to standard score form. The equations shown in Fig. 6 follow the latency form of Equation (2). The constant on the right would be some inverse function of blanking-flash luminance (Boyle, 1963) if that parameter had been varied.

In Fig. 6 there is probably a significant difference between the coarse-grating curve and the other two curves. This would indicate that the neural interaction between test- and blanking-flash evoked potentials is dependent on the form of the test stimulus. This could be expected because slightly different retinal elements are activated by the different test patterns, even though the over-all test pattern areas are equated. Nevertheless, as hypothesized, it should be noticed that all three curves are very similar to each other. This is also verified by the equations in Fig. 6, in which the differences between the various constants of the equations are relatively minor, and all of the equations have the same general form.

Another point of interest is that when the data are plotted in the form of Fig. 6, an approximate idea can be obtained as to how long it takes the human eye to perceive a given object over a wide range of object luminances. Transposing the term of Equation (1) to obtain

$$T_{TF} = D + T_{BF} - (\Delta T)_i, \quad (3)$$

and assuming some low value of percentage correct, one or below,  $(\Delta T)_i$  can be assumed to be zero or close to zero. Therefore, if a value is known for the evoked potential latency of the blanking flash ( $T_{BF}$ ), then the evoked potential latency of the test flash ( $T_{TF}$ ) could, in effect, be determined.

From work with humans, Cigánek (1961) has determined that

a value of 28.6 ms would be the minimum latency of a visual evoked potential for a very bright stimulus which filled the entire eye. For the small foveal blanking flash used in this experiment, although very bright, this is too small a figure and, therefore, quite conservative. Accordingly, it would take longer to perceive a visual stimulus than the figures would indicate. There is also an unproved assumption about the relationship between evoked potentials and the phenomenon of visual masking when any recorded value of evoked potential latency is used. Referring to the 2 per cent correct level in Fig. 4, and keeping the above limitations in mind, adding 28.6 to 70 would give 98.6 ms as the time required to see a foveal stimulus just 1 per cent of the time, very near to the absolute threshold of the test stimulus. Even with the same test stimulus 2.6 log units above this threshold, it would still take 38.6 ms to perceive the stimulus. These latencies could have important ramifications for the operation of very high velocity spacecraft. As an example, at a velocity of 30 ft per 1 ms, which is in the order of the velocity required to escape the earth's gravitational field, a dim object which would require 98.6 ms to be perceived would appear to be 3,000 ft away when, in actuality, it would be in the same position as the observer. Even with the much brighter object which would require 38.6 ms in order to be perceived, the object would appear to be 1,200 ft away. Such visual latencies suggest that, in cases of the extreme velocities associated with space flight, the traditional concepts of pilot observation of the external environment will have to be modified.

## REFERENCES

- Boyle, R. C. An investigation of the latency hypothesis of perceptual interference resulting from successive visual presentations. Unpublished doctoral dissertation, Univer. of Calif., Los Angeles, 1963.
- Boynton, R. M., & Kandel, G. On responses in the human visual system as a function of adaptation level. *J. opt. Sec. Amer.*, 1957, 47, 275-286.
- Cheatham, P. G. Visual perceptual latency as a function of stimulus brightness and contour shape. *J. exp. Psychol.*, 1952, 43, 369-380.
- Cigánek, L. Die elektroencephalographische lichtreizantwort der menschlichen hirnrinde. Bratislava: Verlag der Slowakischen Akad. der Wissenschaften, 1961.
- Kietzman, M. L. The perceptual interference of successively presented visual stimuli. Unpublished doctoral dissertation, Univer. of Calif., Los Angeles, 1962.

Lindsley, D. B. Electrophysiology of the visual system and its relation to perceptual phenomena. In M. A. B. Bazier (Ed.), Brain and behavior, Vol. 1, Washington, D.C.: Amer. Inst. biol. Sci., 1961, pp. 359-392.

Piéron, H. Recherches expérimentales sur la marge de variation du temps de latence de la sensation lumineuse (par une méthode de masquage). Année psychol., 1925, 32, 5-24.

## SEXTANT SIGHTING PERFORMANCE IN THE AMES MIDCOURSE NAVIGATION AND GUIDANCE SIMULATOR

Robert J. Randle and Bedford A. Lampkin  
NASA Ames Research Center  
Moffett Field

The Ames Research Center is studying the role of the crew in the navigation, guidance, and control for the midcourse phase of manned space missions. In pursuit of these investigations, a lunar midcourse navigation and guidance simulator has been constructed at Ames. This device presents, for one thing, a controlled visual task to the human operator in a relatively realistic manner. So that the reader may form some idea of its capabilities as a research device for visual problems, the major features of the simulator and the conduct of an exploratory study of sextant-sighting performance in the simulated task environment are discussed.

The visual scene is a  $25^\circ$  portion of the sky, including a simulated moon which is translatable in accordance with long-period vehicle-moon relative motions for a typical trajectory.

Fig. 1 shows the moving cab mounted on an air bearing. The cab is driven by an on-board cold gas system. The air-bearing support is a portion of a 105-inch sphere that allows rotational motion up to  $\pm 10^\circ$  of arc in pitch and roll, and  $\pm 90^\circ$  of arc in yaw. The on-board cold gas control system has been successfully used to stabilize the cab both manually and automatically during optical sighting tasks. It has also provided limit-cycle operation.

Fig. 2 depicts the celestial visual scene that has been stimulated in the midcourse simulator. The direct optical planetarium approach to visual-scene generation has been utilized. The visual scene, located about 40 ft from the viewing point, is composed of 64 stars that are contained in the  $25^\circ$  segment of the sky surrounding the moon. This segment results from the choice of a specific

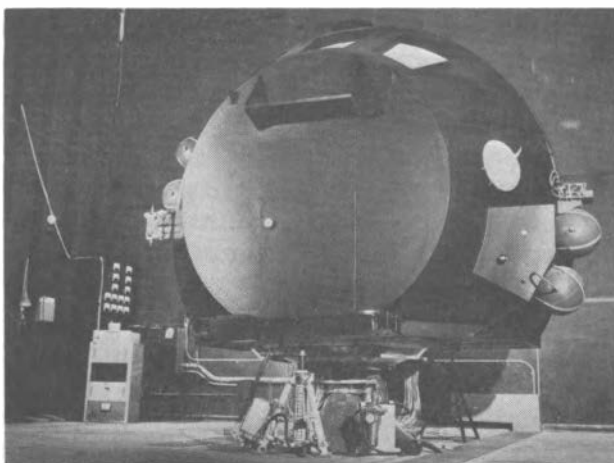

FIG. 1. Moving cab on air bearing.

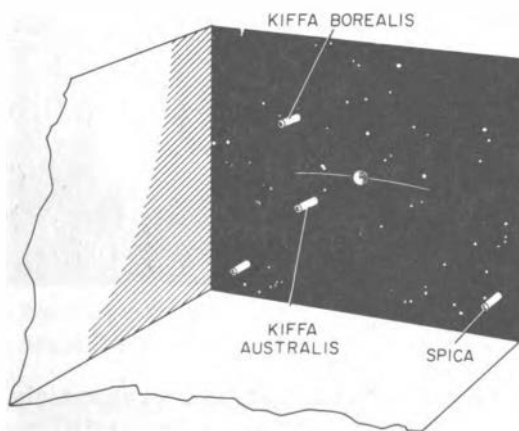

FIG. 2. Simulated celestial scene.

trajectory which is taken as being typical of several possible lunar trajectories.

The simulated stars are simply 0.005-in. diameter holes in the end of a tube lighted by a grain-of-wheat lamp. They have a subtended angle of about 2 arc (sec) and maintain their relative positions within  $\pm 5$  sec of arc for as long as 8 (hr). Unfortunately, the direct optical planetarium is subject to optical parallax due to the finite distance between the light source and the viewer. To minimize the errors in angular measurements due to parallax, four of the star images were collimated by means of 6-in.

parabolic mirrors with small light sources at the focus to represent the stars.

Fig. 3 is a picture of the collimating device. The images produced in the parabolic mirrors, when viewed from the simulator cab, appear to be at infinity and have the same direction when viewed anywhere within the viewing limits of the parabolic mirrors. To extend the viewing area these collimated stars are being fitted with 12-inch parabolic mirrors. Use of the larger mirror will of course extend the magnitude of rotational oscillations which may be employed in research on the effects of motion on sighting accuracy. (This very brief description of the simulation facility is taken from an unpublished paper by Donald Smith of Ames Research Center.)

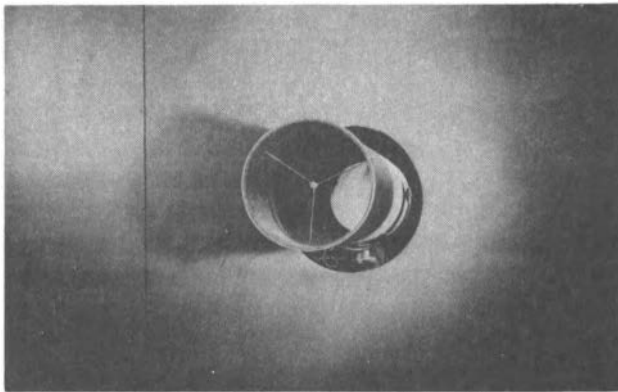

FIG. 3. Collimating device.

The research using this facility concerns mainly the identification and verification of performance capabilities of the human operator as an active participant in the positive fixing and guidance of the vehicle during translunar or midcourse flight. This use of the simulator rests upon the conviction that man can be a useful adjunct to, or replacement for, fully automatic primary systems. Thus, his capabilities in this task environment must be fully explored and delineated (Christensen, 1963). One of the important tasks that will concern the astronaut is that of obtaining navigational information. For the moment manual sextant sighting performance is being investigated as a possible minimum manual system for gathering navigational data. Later, this task will be integrated with the larger task of inputting the data to the on-board computer and, ultimately, with the broader task

context of vehicle alignment, sighting, computation, and velocity correction. The immediate larger goal is to simulate up to an 8 hr segment of the midcourse phase of the translunar trajectory.

Sextant sighting, which has been the initial concern, is now discussed briefly as the first task element. Many manual navigational schemes have been proposed in the literature for finding one's way about in the solar system (Haviland & House, 1963; Havill, 1963; Lillestrand & Carroll, 1963; Moskowitz & Weinschel, 1963; U.S. Navy Department, 1962; White & Wingrove, 1962). These are generally of two kinds: (a) extensions of conventional celestial navigation techniques for the explicit, point-by-point determination of present and future position; and (b) implicit guidance through the determination of the elements of the orbit and their departure from or agreement with a reference orbit which has been predetermined to intersect the coordinates of the desired target point in space.

Both of these methods involve considerable mathematical computation, but each, in most cases, depends first on the seemingly simple task of measuring an angle with an optical sighting device. In marine and air navigation, the accuracy of the celestial fix depends largely on the measurement of angular altitude of the body of interest above the natural sea horizon or the bubble horizon. In navigation in space, several kinds of angles may be of interest:

1. the angle between the line of sight of a lunar, terrestrial, or planetary landmark and a star;
2. the angular extension of any of the planets, moon, or sun;
3. the angle between a star and the limb of a planet, moon or sun; and,
4. the angle between the earth or moon and the vehicle-centered horizon.

Since the marine sextant may be rotated through any angle to measure the angle between any two points of interest, it is the instrument that has been used. The bubble sextant is disqualified, of course, because of its dependence on a gravitational field.

Specifically, the Navy Mark II Mod 0 hand-held sextant has been used, mainly because of its availability. It has a three-power scope and a  $10^\circ$  of arc field of view. A modern sextant with interchangeable telescopes will be used in future studies.

It probably appears an audacious bit of romance to bring forward this time-honored device for evaluation against the precision requirements of space navigation. However, as an entrance point to the study of the fundamental sighting task its employment

is inescapable and appears thus far to be quite fruitful. This is particularly true where it is desired to estimate relative accuracies under various sighting conditions. The inherent sextant errors bias only the determination of the true angle. The variance of the operator's sighted angles about their mean is the criterion measure for a given sighting session, and the change in this score with the conditions of the study is the experimental variable of interest.

Fig. 4 is a photograph of the marine sextant now being used. Its design, as for all sextants, is based on the optical principle that the angle between the first and last directions of a ray of light that has undergone two reflections in the same plane is twice the angle that the two reflecting surfaces make with each other. Since the index arm is mechanically linked to the index mirror, the position of the arm on the limb indicates the angle between the two mirrors. The limb thus must be calibrated so that  $0.5^\circ$  of arc reads  $1^\circ$  of arc. Originally, the limb was a sixth of a circle, hence the name sextant; however, on modern sextants it is usually more than a sixth. There are several sources of error associated with this sextant. Some are due to mirror and telescope misalignment, others are due to eccentricity in the index arm, errors of graduation, and lack of parallelism between the mirror and shade glasses (Hill, Utegaard, & Riordan, 1961).

Obviously, these are not highly accurate instruments in terms of error tolerances for space navigation. Position fixing on the open sea does not have stringent accuracy requirements nor does

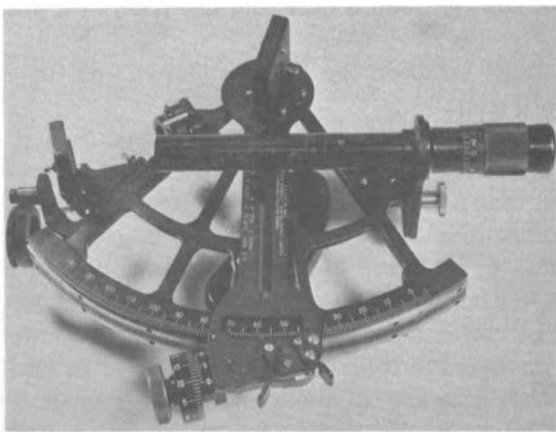

FIG. 4. Marine sextant.



air navigation necessarily, where critical corridors and terminal points are approached using other, more precise techniques. In fact, the German Hydrographic Office considers any sextant used for marine navigation purposes to be "free from errors for all practical use if the error goes up to twenty seconds" of arc. However, the theoreticians in space navigation and guidance employ an accuracy model of, at most, 10 sec of arc in sighting performance in their analyses of navigation requirements (McLean, Schmidt, & McGee, 1962; Smith, 1964; Smith & Harper, 1964).

The literature is not at all replete with controlled studies of sextant sighting accuracy. One study, in which a modified modern sextant was used, measured performance in sighting on actual celestial objects in the night sky (Yachter & Goetz, 1962). Two stars, a star and a planet, and a star and a moon crater were the targets. The sextant was fitted with a 6 x 30 telescope and mounted on a modified telescope mount. The micrometer vernier permitted angular interpolation to 3 sec of arc.

For the measurements of angle between two stars, and a planet and a star, the standard deviation was of the order of 10 sec of arc, and for the star-crater pair it was of the order of 26 sec of arc.

The Ames project used a hand-held sextant and a sextant gimbal mounted to the cab. The three-power telescope had a 10° field of view. The vernier was readable to 6 sec of arc with a dubious interpolation to 3 sec of arc. The interest was not, however, in the ascertainment of absolute sighting performance; but rather the determination of whether there was a difference in performance between the hand-held and the gimballed sextant, and also whether oscillatory motion affected performance to any great extent.

Accordingly, an arbitrary limit-cycle function was programmed on an analog computer to drive the cab using the cold gas jet system. The limit cycle was restricted to the yaw axis, spurious motions in the other axes being damped to relatively small amplitudes. Three levels of rate were used: 1/2° of arc/sec, 1° of arc/sec, and 1-1/2° of arc/sec. A static condition was also included. The oscillations were contained within a ±2° band about the line bisecting the stars of interest. Two of the collimated stars, oriented in a near vertical position, were used as targets. The task was to measure the angle between these stars by superpositioning one star over the other in the sextant field of view.

The subjects were three Air Force navigator instructors at nearby Mather Air Force Base, an advanced Air Force navigation

school. Also included were four professionals engaged in related studies at Ames Research Center.

Since these investigations are still in process, it would be premature to present data at this time; however, some informal statements regarding apparent trends are in order.

Training is an important variable, at least for the task environment being provided. It was found that, using two sighting sessions per day, a week or more was necessary to bring the subjects down to asymptote. Twenty-four sightings were taken in each session. This was true for the navigators as well as for the professionals. For the navigators, transfer of training cannot be evaluated because of their lack of recent intensive use of their bubble sextants and the fundamental differences between previous tasks and the present one. One of the major differences is due to the use with modern bubble sextants of manual or automatic integrating devices that allow for the averaging of a continuous sighting over a minute or two of time. The marine sextant is a single-shot device and is so used in sea navigation. It was noticeable that the subjects regressed considerably in their learning after the intervention of a weekend. However, the losses were quickly recovered after some additional sessions. It is mandatory that the extent of retraining required after varying periods of nonpractice be determined, if a strictly manual sighting scheme is to be seriously considered as an alternate mode for space navigation.

The cab motion does not appear to have a systematic effect on performance at the relatively large rates used. However, the effects of less discernible rates in both the limit cycle and the long-period relative motions of the vehicle and bodies in the solar system have yet to be estimated.

Indications are that the gimbaled sextant has a slight edge, in terms of accuracy, over the hand-held. The subjects preferred the gimbaled sextant, particularly after having had some experience with both types. However, this is not sufficient to qualify the gimbaled sextant and disqualify the hand-held sextant, the difference amounting to some 3 sec of arc in standard deviation. This is not very much when it is known that the standard deviations for all subjects ranged from 5 sec of arc to 46 sec of arc with a mean of 22 sec of arc.

The three-power telescope may not be the best for most accurate performance. The modern sextant with a 6 x 30 telescope has been tried, and, although there was considerable random motion in the two star targets due to hand tremor, performance

was better. Since this determination was based on only a few subjects, the contribution to performance of various telescope magnifications using the newer sextant will be further investigated using a larger number of subjects.

In the process of defining the details of the task, it becomes apparent that the visual processes involved require separate treatment for their investigation. Accordingly, plans are being made to assess matters such as the relation of visual acuity to performance; the effects of fatigue; the effects of reticle geometry such as cross hairs versus concentric circles versus gun-sight type displays; the variance of performance with varying geometries of celestial targets; the effects of varying contrasts in the field of view; and the effects of training, lack of practice, and retraining on all of these. These are general statements because they result from an initial judgment of what is important in sighting performance as identified in the simulated task environment. The opportunity to make these judgments is provided by the midcourse navigation and guidance simulator.

## REFERENCES

- Christensen, J. M. Psychological aspects of extended manned space flight. Wright-Patterson AFB: Behavioral Sci. Lab., tech. doc. Rep., 1963, No. AMRL-TDR 63-81.
- Haviland, R. P., & Hause, C. M. Celestial navigation in space, advances in the astronomical sciences. Amer. Astronautical Soc. Proc. of 9th Ann. Mtg. (Los Angeles), 1963, Vol. 13.
- Havill, D. C. An emergency midcourse navigation procedure for a space vehicle returning from the moon. Moffett Field: NASA tech. Note, 1963, No. D-1765.
- Hill, J. C., Utegaard, T. F., & Riordan, G. Duttons navigation and piloting. (4th Prtng). Annapolis: US Naval Inst., 1961.
- Lillestrand, R. L., & Carroll, J. E. Horizon based satellite navigation systems. In IEEE transactions on aerospace and navigational electronics, Vol. ANE-10, No. 3, New York, 1963.
- McLean, J. D., Schmidt, S. F., & McGee, L. A. Optimal filtering and linear prediction applied to a midcourse navigation system for the circumlunar mission. Moffett Field: NASA tech. Note, 1962, No. D-1208.
- Moskowitz, S., & Weinschel, P. Instrumentation for space navigation. In IEEE transactions on aerospace and navigational electronics, Vol. ANE-10, No. 3, New York, 1963.
- Smith, G. L. Secondary errors and off-design conditions in optimal estimation of space vehicle trajectories. Moffett Field: NASA tech. Note, 1964, No. D-2129.

- Smith, G. L., & Harper, E. V. Midcourse guidance using radar tracking and on-board observation data. Moffett Field: NASA tech. Note, 1964, No. D-2238.
- United States Navy Department, Space navigation handbook. Washington, D.C.: U.S. Government Printing Office, 1962, Navpers No. 92988.
- White, J. S., & Wingrove, R. A survey of guidance and navigation problems for the manned lunar mission. J. Inst. Navigation, 1962, 9,2.
- Yachter, M., & Goetz, R. A. Astronomical angular measurements via an astro sextant. Amer. Bosch Arma Corp.: Arma Div. Rep., 1962, No. DR-62-E652-8.

## COMMENTS ON MAJOR GORDON COOPER'S OBSERVATIONS FROM ORBIT

John H. Taylor  
Scripps Institution of Oceanography  
University of California

The Mercury series of manned earth-orbital space flights ended with the mission referred to as MA-9, piloted by Major L. Gordon Cooper. During certain of the 22 orbits, Major Cooper reported having seen objects on the surface of the earth that must necessarily have subtended very small visual angles from the capsule altitude. There was an immediate and vociferous reaction on the part of the scientific and lay communities, and during the months following MA-9 there was a considerable bulk of commentary published in the press, notably in Aviation Week. Opinions ran the gamut from flat denial of the possibility of Major Cooper's sightings being genuine to acceptance of his reports based upon one or another "explanatory" principle. These included such things as hallucination, the magnification due to the atmosphere, and a postulated improvement in visual acuity due to weightlessness. Most of these hypothetical effects can be dismissed or shown to be insignificant, e.g., the magnification due to the whole atmosphere would have the effect of raising the object about 8 feet—not much help in 100 miles.

In September of 1963, the Visibility Laboratory was asked by Dr. Robert B. Voas, then of the Manned Spaceflight Center at Houston, to investigate the situation in terms of visual and atmospheric optical considerations in the hope of settling the controversy. Analysis by the Laboratory of Major Cooper's reports was contained in a letter from Dr. S. Q. Duntley to Dr. Voas, and eventually formed the basis for a National Aeronautics and Space Administration press release. Further, it led to plans for a controlled experiment which will assess the ability of the Gemini astronauts to discriminate ground features.

This ex post facto visibility problem was approached in much the same manner that one usually goes about making visibility calculations. Ideally, the needed inputs regarding the characteristics of the target and its illumination, the transmission properties of the path of sight, and the visual performance capabilities of the observer should be quantitatively known. In the present case, however, it was necessary to reconstruct the situation on the basis of partial information gathered after the event and upon some assumptions which are thought to be reasonable.

The first step was to get as much information as possible about the objects which Major Cooper reported, the manner in which they were illuminated, and the backgrounds against which they were seen. For this purpose, Mrs. Jacqueline I. Gordon and the writer made a trip to Houston where transcripts of the taped in-flight verbal reports and the detailed orbital information regarding the areas of the sightings were secured. The post-flight Pilot's Report was read, and Major Cooper was questioned at some length about his experiences. It should be emphasized at the outset that Major Cooper is a remarkably careful observer; he is meticulous in differentiating fact from inference. Not only does he have excellent visual acuity, as measured clinically, but he has had a tremendous amount of experience in the reconnaissance of angularly small, distant objects. From his Wisconsin boyhood hunting days through his Air Force test pilot work in high-altitude jet aircraft, he emerges as a genuine specialist in the types of observations that he later reported from orbit. To give a single example, Major Cooper asserted that he often observed, while flying over the Salton Sea in clear weather at 40,000 ft, the wakes of motorboats, the boats themselves, occasionally a smaller wake near the boat, presumably caused by a water skier, and, once in a while, a small light dot at the front of the wake which could have been the skier and his lifejacket. It is entirely possible to detect a target this small (about 10 sec of arc) given sufficient contrast and good visual acuity, of course, and herein lies, in the opinion of the author, the crux of the matter. Before, however, one can evaluate Major Cooper's orbital sightings, it is necessary to arrive at reasonable estimates of the apparent size and contrast of the reported objects, and to relate these to existing visual-performance data. The appropriate data for use in this case are those reported for the visibility of fine lines, e.g., Hecht and Mintz, angularly small targets, e.g., Blackwell, and vernier acuity, e.g., Berry. It is clearly inappropriate

to appeal to ordinary clinical wall-chart acuity, with its traditional 20/20 rubric, as it has become entrenched in the popular mind.

Since the exact optical properties of the atmosphere during the observations cannot be known, it was decided to use data from the Visibility Laboratory's instrumented aircraft obtained under the clearest weather conditions. It was assumed that the atmospheric clarity at the time of Major Cooper's sightings was as good as or better than that measured during the instrumented-aircraft flights. This is believed to be a reasonable assumption for both the areas of interest. The first area near El Centro, California, is characterized by extremely clear dry air much of the time, and information secured from the local weather station confirmed that this condition obtained during the period of interest. The second area, the high Tibetan plateau, is probably overlaid by a very clear air mass, owing largely to the fact that its elevation is about 13,000 to 16,000 ft. Photographs taken from the capsule tend to corroborate this, although data from ground weather stations there were unavailable.

Four specific reported sightings were examined. They combined measured atmospheric transmission data, known visual-performance capabilities, and both measured and assumed properties of the objects purportedly seen. The estimated inherent characteristics of the reported objects were arrived at by some rather interesting sleuthing. For each of the four cases investigated, pertinent excerpts are given from Major Cooper's statements (derived from the on-board tapes, the Pilot's report, and the interview, followed by a brief description of the findings and the conclusions to which they lead.

#### Case I

Between El Centro and El Paso Major Cooper could "easily see lots of roads, both paved and unpaved." He saw two unpaved roads running east-west, one on either side of the U.S.-Mexican border. On the northern road he observed a cloud of light dust, "lighter than the terrain" under conditions of "no wind" so that the dust cloud hung over the road. He stated that the cloud seemed to be caused "by a vehicle traveling from west to east," and that he could discern "a lighter dot" at the eastern end of the dust cloud.

The U.S. Border Patrol confirmed the presence of the roads paralleling the border. The Patrol uses a specially designed vehicle called the International Scout, somewhat similar to the Jeep,

but covered by a flat white top to reflect the desert sun. Dimensions of this vehicle, which were furnished by the Patrol, have been used in the calculations. The terrain background reflectance, from information supplied by the San Diego Museum of Natural History, was estimated to be similar to that measured in other desert locations during field expeditions where the soil and vegetation closely resembled those in the border area. Assumed values of reflectance of terrain, road, vehicle, and dust cloud, together with physical dimensions of the vehicle and an 8 ft wide road, have been combined with an assumed contrast transmittance of the path of sight of 0.77 in order to derive the probabilities of seeing, as shown in the last column of Table 1. Parenthetically, it might be noted that, had the vehicle been stationary, it would very likely not have been seen; the dust cloud at the time of observation not only added to the positive signal contrast but may have obscured the vehicle's shadow which, without dust, would have tended partially to cancel out the lighter vehicle at the angular size noted. One may conclude that this sighting was entirely credible.

### Case II

During a pass over the high Tibetan plateau (ground elevation 16,000 ft) Major Cooper reported seeing, on an east-west road, a dust cloud blown by a "wind out of the south" which he inferred to be a "stiff breeze" from the angle it appeared to assume relative to the ground. At the confluence of the dust cloud and the road, he reported seeing "a light spot" which he interpreted to be a vehicle.

An attempt was made to discover the most likely characteristics of both the road and the terrain; and what is believed to be reasonable data from the Laboratory files was taken for use in the calculations. The probability of seeing the road, as indicated in Table 1, is in excess of 0.99. If one guesses that the vehicle might have been a 2.5-ton truck with a light top, the probability of its detection is 0.50.

### Case III

Near some of the Tibetan roads, Major Cooper reported seeing small villages and, occasionally, "squarish houses." "I noted... the wind direction on the ground due to smoke coming out of smokestacks and out of the fireplaces (sic) of houses."

Tibetan dwellings in the area of interest are found (in National Geographic Magazine photographs) often to be rather large,



TABLE 1

Case	Location	Ground elevation (ft)	Altitude NM	Ground object	Assumed effective object size (ft)		Assumed object	Reflectance background	Estimates of contrast transmittance	Probability of seeing
					Width	Length				
I	El Centro	0	86	Dirt road vehicle	8	$\infty$	0.23	0.18	0.77	0.84
					5.7	12.9	0.92	0.18	0.77	<0.01
								0.18	0.77	>0.84
II	Tibet	16,000	86	Dirt road 2.5-ton truck	8	$\infty$	0.18	0.07	0.66	0.99
					8.2	21.5	0.60	0.07	0.66	0.50
III	Tibet	16,000	86	Side of house	Equivalent of projected area 138 sq ft		0.80	0.07	0.66	0.50
				Smoke	2	$\infty$	0.125	0.07	0.66	0.50
IV	Probably China	Uncertain; (0-16,000)	86	Train track	8	$\infty$	0.06	0.09	0.70	0.90
				Smoke or steam	2	$\infty$	0.33	0.09	0.70	>0.99

75

multifamily houses with white (whitewashed?) sides and dark roofs. The lighting which prevailed at the time of the sightings should have caused the sides of these dwellings to be brightly lit, and to form, in consequence, a high positive contrast with the terrain background. Using terrain reflectance values which seem reasonable for the region, it is calculated that a brightly-lit building side having a projected area of 138 sq ft in the direction of Major Cooper's line of regard would be seen with a probability of 0.50. This probability increased markedly with size, so that, for example, a vertical wall having twice the area, i.e., 276 sq ft, would generate an optical signal of detection probability greater than 0.90. Some detective work led to the discovery that the smoke issuing from these structures may have produced a positive contrast sufficient to be seen with a probability of 0.50, for the usual local fuel in these timberless regions is yak dung, which yields a dense, light smoke. (It has been suggested that this fact may have led to the traditional expression used by Tibetan housewives: "Oh my baking yak!") In any case, it is believed the sightings are reasonable.

#### Case IV

In what is believed to be part of western China, Major Cooper reported seeing a railroad track running in a northeast-southwest direction. The track was seen as darker than the terrain, and at one point on it he reported "an extended target, lighter than the track" with a plume of white (smoke or steam) at its northeastern end. This he interpreted to be a train proceeding in a northeasterly direction. He stated that he believed the wind direction to have been southerly, owing to the angle formed between the white plume and the track.

Under the assumed conditions it is believed that the roadbed should have been visible with a probability of 0.90. The white plume of steam or smoke under the same conditions would almost certainly have been detected (probability greater than 0.99).

There were other fascinating sightings reported by Major Cooper, such as a boat and its wake on a river in Tibet, nightside observations of cities and villages, lightning, and his remarks concerning the apparent color of terrestrial features from orbital altitude. Only in the few cases outlined above, however, did making the assumptions required for visibility calculations seem at all justified.

At this point, a few comments can be ventured which may help in understanding why many people greeted Major Cooper's reported

sightings with skepticism, or felt obliged to ascribe his observations to one or another extrinsic causes. The term "visual acuity" refers to a variety of discriminations of which an observer is capable. In all cases, it relates to the detection of a spatial difference or discontinuity, and the subject is tested to find the smallest such difference he can detect. This value, generally expressed in terms of the subtended angle of the spatial element or its reciprocal, is taken as a measure of the visual acuity. A wide variety of test objects has been used in the investigation of this function, and the numerical results are widely disparate and depend on the nature of the visual task involved. Simplest of such tests, which are referred to as tests of the "minimum visible," involve the detection of presence of an object, such as a point or a line. Somewhat more complicated are those tests in which the objects contain some spatial discontinuity within themselves, such as a pair of small targets or a broken ring, in which the "twoness" of the points or the location of the gap must be discriminated. These tests are referred to as measures of the "minimum separable." Still other tests involve higher-order discriminations, such as form recognition, of which the ordinary clinical wall chart of Snellen requiring the recognition of letters, is typical. They are called measures of the "minimum cognizable."

It is evident that the last-named measures of acuity are most often used in medical practice, and that the numerical values resulting from such tests are most familiar to the majority of the population. Since the Snellen charts are based upon the notion that 1 min of arc is required for the perception of form (based upon a statement of Hook, quoted by Robert Smith in 1738), it is firmly implanted in the popular mind that 1 min of arc angle represents the value of best acuity. After all, is it not often said that 20/20 scored on the Snellen test (from the line on which the letter stroke width subtends 1 min of arc) means perfect vision"? Major Cooper's Snellen acuity happens to be 20/12, or 0.60 min of arc, although, as is indicated below, this value is merely suggestive of his superior vision and does not represent a limiting value of visual resolution.

Measures of acuity other than the conventional clinical wall charts yield quite different values, and, generally speaking, the simpler the test the more "acute" vision becomes. Only two studies are cited, although there are dozens in the experimental literature. These two have been chosen because the test objects are more closely analogous to the real objects sighted during the MA-9 flight.

The first step is to summarize the data of Hecht and Mintz, who determined the minimum angular diameter required for a long wire to be seen against a uniformly luminous background. The subtended angle of the wire, which was seen as a dark silhouette (contrast  $\cong -1.0$ ), was found to decrease with increasing field luminance, reaching its limiting asymptote at 0.007 arc min. These data were taken from a single observer (Hecht), aged 45 years, and it is probable that Major Cooper, similarly tested, would better this result by a palpable factor. While the terrain backgrounds against which roads, rivers, and railroad tracks were seen were probably not as uniformly bright as those used in the experiments, still these data are most closely applicable to the visibility of such earth features.

One variety of visual acuity comes from tests in which the observer is required to detect the presence of a discontinuity in an extended line. This measure, called "vernier acuity" from its resemblance to the visual task required in the reading of vernier instrument scales, is analogous to the situation in which an extended line is suddenly displaced by some small angular amount. An hypothetical example might be the case where a truck and its shadow combine to produce a pair of such apparent displacements. Experiments have shown vernier acuity values in the range of 1 sec of arc, or about 0.017 arc min.

Both of the studies referred to concerned targets of essentially -1.0 contrast, the lower limit for targets darker than their backgrounds. Targets which are darker than their terrain backgrounds may approach this value, but, owing to contrast losses suffered because of the presence of the atmosphere, will always be of lesser contrast and concomitantly reduced discriminability. The quantitative features of this situation may be calculated in order to arrive at visibility estimates. When targets are brighter than their effective backgrounds, however, no upper limit on contrast is imposed, and it is common to see angularly tiny objects (such as stars, distant lights, sun glints, and the like) provided only that sufficient light from these objects reaches the eye. The light-colored vehicles reported by Major Cooper may be a case in point.

A final point should be made in regard to the use of laboratory data in predicting the performance of an observer in a real-life situation. By and large, the numerical results of these experiments are estimates based upon large numbers of observations, and almost always refer to that value of angle that is necessary for discrimination to be successful one-half of the time. There

are statistical considerations that make this a desired value which need not be gone into here. It must be emphasized, however, that the numbers so derived represent only a single point on a continuum—that there are larger visual angles which will result in greater certainty of seeing, and smaller ones which yield lower probabilities of seeing. That is to say, smaller targets than those indicated will occasionally be seen, albeit less frequently. This fact, together with the likelihood that Major Cooper is a superior observer, and with the unquestionable fact that he is highly experienced in high-altitude observation, make it very probable that estimates based upon laboratory data may be conservative, indeed.

In sum, it is concluded that the terrestrial objects reported by Major Cooper from the Faith 7 capsule could, in fact, have been seen under the conditions that have been assumed to have prevailed during the MA-9 mission. It is not necessary to invoke any exotic environmental or psychological factors in order to account for these sightings. Finally, reconstructing the event merely indicates the possibility of the sightings, and in no wise proves them to have been made. An opportunity to perform controlled experiments during future space flights is, therefore, anticipated with great enthusiasm. The first of these is described by Dr. Duntley elsewhere in these Proceedings.

## GEMINI IN-FLIGHT VISUAL-ACUITY EXPERIMENT

S. Q. Duntley  
Scripps Institute of Oceanography  
University of California

As a result of astronaut Gordon Cooper's reports of sighting small objects on the ground from Mercury Flight MA-9, there is considerable operational and scientific interest in an experiment which will test the existing methods of predicting the visual capabilities of observers in space. It is hoped to determine under carefully documented conditions the effects of prolonged weightlessness, 5 PSI oxygen breathing, and other environmental conditions peculiar to space flight on the astronaut's visual-performance capabilities as a function of time.

It is intended to obtain information by measurements prior to flight on the visual capabilities of the astronauts who will be involved in the seven-day or longer missions. Also, they will be trained in the tasks which they will have to perform in flight. The astronauts' performance in two visual tasks in flight will then be measured in flight as the mission progresses.

The astronauts involved in missions GT-5 and GT-6, and/or GT-7 will be required to measure their own visual acuity during the mission with the aid of an in-flight vision tester, which will be provided by the Visibility Laboratory of the University of California, San Diego. This task will involve the use of the tester by each man once a day throughout the flight. He will report the result of his test to the ground each day. In addition, during orbits which pass within range of a prepared ground target area, the astronaut in the right-hand seat will be ask to determine the orientation of each of (approximately) 12 rectangular targets which will be arranged in a line from west to east approximately 10 nautical miles long. The astronaut in the left-hand seat will orient the spacecraft so that the right-hand astronaut will have the optimum view of the target area. The astronauts will be

familiar with the location of the target site and its general configuration, and a suitable method will be provided for locating the target area. All targets will be above detection threshold but will bracket the astronauts' ability to determine their orientation. The observing astronaut will call out the orientation of the targets, and his answers will be conveyed to the ground by radio. Depending on the results of the experiment, the size of the ground targets may be changed between days of the mission to insure that the proper range of target size and contrast is presented.

The optical condition of the window being used by the observer will be monitored continuously throughout the observing period (approximately 2 minutes) to determine the amount of earthlight being scattered by the window. This is necessary in order to obtain quantitative information on the astronauts' performance, as the apparent contrast of targets will depend on the manner in which the contrast is degraded by passage through the window. The necessary information will be obtained by an in-flight photometer which will be mounted on the 16-mm camera bracket in the right-hand corner of the right-hand window. This photometer will be aligned with a small, circular light trap which will be mounted outside the window on the hatch immediately in front of the photometer, about 9 inches in front of the window. The output from this photometer will be telemetered through the high-level dumped telemetry system. In order to determine if the scattering from the window is uniform and, if not, what the degree of nonuniformity is, the spacecraft will be rolled over so that the right-hand observer is looking into black sky but sunlight is obliquely illuminating the window. The astronaut will then remove the photometer from the 16-mm camera bracket and scan the window manually, using the black sky as his light trap. The output from the telephotometer will again be telemetered during this operation, and the telemetered information will be time-correlated with the voice record which he makes during this task. A meter on the rear of the telephotometer will permit the astronaut to make his own determinations of the scattering from the window, or measure the luminance of any other target of opportunity that may interest him.

The experiment will be performed only on a seven-day or longer mission as the purpose of the experiment is to determine the "longitudinal" effects of spacecraft environment. It will be necessary as a very minimum to perform the ground observation portion of the experiment near the start of the mission and near the end. It is expected that this observation will actually be made on each pass within range of the target area. A Visibility

Laboratory instrumented trailer-van will be at the target site during the mission to document the light and atmospheric conditions at the targets. An Air Force C130, instrumented by the Visibility Laboratory, will fly over the target area at the time of the orbits used for sighting to document the pertinent optical properties of the atmosphere as a function of altitude. All of this information will be used to determine the nature of the optical signal available to the astronaut, and the Laboratory will then correlate this with his visual performance.

A National Aeronautics and Space Administration van will be outfitted by the Visibility Laboratory and set up in Houston to measure the visual capabilities of the astronauts and to train them in the use of the in-flight vision tester. This will require 8 to 12 two-hour sessions for each of the astronauts who may be assigned to the mission. As this training may occur six months prior to flight, a brief refresher training will be given to the astronauts within two to four weeks prior to flight. In addition to the training at Houston, the astronauts will be flown in a C130 over the target area to familiarize them with its appearance and with the location of permanent landmarks. A scale model of the target will be laid out in this area and will be viewed by the astronauts through open hatches or ports from an altitude of 20,000 feet or less.

The in-flight vision tester will be completely self-contained and require no interfaces with the spacecraft other than stowage. It will be used by both astronauts once each day. The astronaut in the right seat will use it on the orbit prior to his first orbit over the target for that day and report his results to the ground on passage over a suitable communication site in the United States. The device will be binocular, with an adjustable interpupillary distance which will be pre-determined for the astronaut and will be held by means of a biteboard inserted in the astronaut's mouth. Each astronaut will have a biteboard prepared for him, which will then properly position the vision tester. The astronaut will rotate a knob on the tester to a series of detented stops which will align targets in the field of view of the instrument. The astronaut will make a binary-type decision, i.e., yes-no, vertical-horizontal, or a-b, and will note his answer on a small card by punching the knob used to rotate the drum, thereby causing a pin to puncture a card if he determines "a." If he determines "b," he will not puncture the card but rotate the drum to the next position. The card, which is removable, will contain the results of the vision test, these results to be read by the astronaut either into his tape recorder or directly by radio link to the ground.



**FLASH BLINDNESS**  
**John L. Brown, Chairman**



## OPERATIONAL SIGNIFICANCE OF THE FLASH BLINDNESS PROBLEM

Walton L. Jones  
Bureau of Medicine and Surgery  
Bureau of Naval Weapons

A pilot who has dropped 17 atomic weapons during various tests describes his experiences in this manner: "At the moment of burst I typically am headed directly away from the burst point. When the burst occurs, the horizon disappears and everything seems to be covered by an overwhelming glow. I can distinguish no colors nor can I see any terrain features. It is as if I am experiencing the white-out suffered by aviators flying in Arctic zones."

That pilot flies at altitude in a large stable aircraft which can be controlled by autopilot as required. His temporary loss of vision is not as serious as if these events were to occur while he was weaving his way around hilltops and through valleys, at as low an altitude as possible, while trying to maintain an accurate navigation course to a target he had never seen before. Inasmuch as many Navy missions are flown under just such circumstances, the problem of flash blindness has come to be regarded as quite a serious one.

This paper discusses in some detail the operational significance of the flash blindness problem, and then describes the major areas of effort being undertaken in attempting both to understand this phenomenon and to provide means for minimizing its hazard. The specific devices which have been developed and which are being evaluated at this time, are discussed elsewhere in this Report.

In considering the effects on vision of the light from a nuclear burst, there are, in fact, two major areas of concern: one deals with the permanent damage, or retinal burns, and the other with temporary impairment, or flash blindness. Fig. 1 presents formal

## EFFECTS OF VISIBLE AND THERMAL RADIATION FROM NUCLEAR BURSTS ON VISION

### PERMANENT RETINAL BURNS

IRREVERSIBLE TISSUE DAMAGE IS CAUSED BY THE ABSORPTION  
OF EXCESSIVE THERMAL ENERGY IN THE RETINA AND UNDERLYING  
LAYERS, PRINCIPALLY THE CHOROID.

### FLASH BLINDNESS

A TEMPORARY LOSS OF VISION PRODUCED BY OVERSTIMULATION  
WITH VISIBLE ENERGY. THE PERIOD OF FLASH BLINDNESS IS THAT  
PERIOD DURING WHICH THE INDIVIDUAL CANNOT PERFORM HIS  
DUTIES BECAUSE OF LOSS OF VISION

FIG. 1.

definitions of these problem areas. Obviously, each area is of deep concern to the Navy. Since careful study of these areas has proved that any protection provided against flash blindness will also protect against retinal burns, attention has been focused on the flash blindness problem. Flash blindness is defined as that period during which the individual cannot perform his duties because of loss of vision. From an operational point of view, the concern is actually with loss of performance capability rather than with loss of vision. Thus, if any features within the cockpit can be arranged to provide benefit, such as an automatic increase in cockpit lighting following exposure, the period of flash blindness can be decreased, even though the overstimulation of retinal chemicals has in no way been changed. Such a concept is important since it allows one to consider means of reducing flash blindness above and beyond the obvious one of providing direct protection for the eye.

As the problem of flash blindness is placed into operational perspective, one can see that in certain respects it poses a more difficult problem than those produced by the blast, shock, and thermal radiations from the weapon. Fig. 2 shows the area within which flash blindness might occur as related to the thermal envelope of the weapon. Note that when the burst point is in the central field of vision flash blindness may occur at a distance as far as several hundred miles from the point of detonation. If the burst occurs behind the pilot, however, relatively little flash blindness should occur unless there are clouds or other highly reflective surfaces within his direct field of view. The important point to note in this figure is that it is necessary to protect

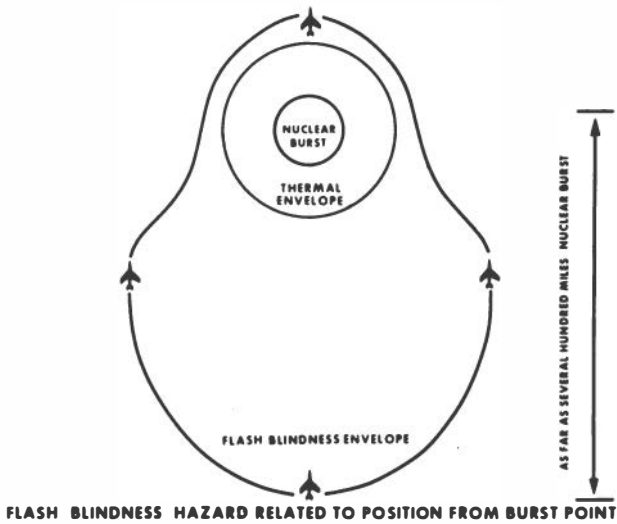

FIG. 2.

a pilot from flash blindness at much greater distances from the burst than is required for protection from thermal radiation effects on his skin.

To achieve a genuine understanding of the operational importance of flash blindness it is necessary to review certain performances which are required of Navy aviation personnel. Fig. 3 lists a few of these activities for which the maintenance of effective vision is critical. The first of these, low-level daylight attack, provides an excellent example. Here the pilot is trying to fly the aircraft, maintain an absolutely minimum altitude, search for navigation checkpoints, and occasionally to monitor certain of his panel instruments. The demands placed on his vision are imposing. Research conducted by the Navy indicates that with present equipment for contour flying a pilot looks outside approximately 90 per cent of the time in order to maintain geographic orientation. It is no wonder that pilots flying these missions estimate that if their vision were lost for as brief a period as 5 to 10 sec they would in all likelihood either crash or become hopelessly disoriented.

Another item in the list of activities in this figure relates to night formation flights. There are certain Navy missions in which one aircraft, which has extensive navigation equipment, will lead other aircraft to target areas. Under these circumstances, it is absolutely essential that the pilot of the aircraft

## **PILOTS**

### **DAY OR NIGHT OPERATIONS**

- **LOW LEVEL ATTACK**
  - **TERRAIN CLEARANCE**
  - **NAVIGATION CHECKS**
- **INFLIGHT REFUELING**
- **FORMATION FLIGHT**
- **DECK OPERATIONS**
  - **TAXI**
  - **LAUNCH**
  - **LAND**

## **CARRIER PERSONNEL**

- **NIGHT DECK OPERATIONS**

### **NAVAL AVIATION ACTIVITIES REQUIRING FULL USE OF VISION**

FIG. 3.

being led fly a tight wing position on the lead aircraft. To do this he must be able to perceive the outline of the lead aircraft as well as its running lights. To try to follow by reference to the lights alone leads to autokinesis and subsequent severe seizures of vertigo. Thus, the pilot is in a situation in which he must not only be able to see outside the cockpit at all times, he must also maintain a high level of dark adaptation throughout the flight. Obviously, in this situation a period of flash blindness of even a few seconds would have devastating consequences.

As a final item from Fig. 3, consider the night deck operations performed on a carrier. During night launch operations, for example, flight-deck personnel must maneuver jet starting equipment around the deck, guide aircraft to the launch position, and aid in preparing the aircraft for launching. While doing these tasks, they must avoid spinning props, jet intakes and exhausts, and moving tractors. The noise level is such that warning shouts are almost useless. And all this takes place on a deck that, on a moonless night, is illuminated only by red flood lights located seven stories up on the island of the carrier. Here, again, any light which produces flash blindness or even destroys dark adaptation could be quite serious.

Many persons have proclaimed that with airborne radar and

radar-controlled intercept missions there is no need for concern with night vision. It is true that a pilot no longer tries to locate enemy fighters at night by purely visual means. But, as one can see from Fig. 3, there are many activities performed by Navy personnel, both at night and during the day, for which the maintenance of effective vision is of the utmost importance.

Realizing the importance of maintaining the visual capability of Navy personnel under combat conditions, the Navy has had, for several years, an active program to investigate flash blindness and to develop protective devices and procedures. Fig. 4 shows the major areas of effort within this program. In an attempt to make the program as comprehensive as possible, efforts have ranged all the way from laboratory investigations of flash blindness, using high-intensity light sources, to the preparation of training and indoctrination materials for pilots.

**NAVY PROGRAM CONCERNING FLASH BLINDNESS PROTECTION**  
**AREAS OF EFFORT**

1. LABORATORY INVESTIGATIONS OF VISUAL IMPAIRMENT FROM EXPOSURE TO HIGH INTENSITY LIGHT SOURCES
2. COLLECTION OF DATA FOR MODEL ALLOWING PREDICTION OF FLASH BLINDNESS HAZARD IN OPERATIONAL ENVIRONMENTS.
3. DEVELOPMENT AND EVALUATION OF FLASH BLINDNESS PROTECTION DEVICES.
4. PREPARATION OF TRAINING AND INDOCTRINATION MATERIALS FOR PILOTS.

FIG. 4.

Early efforts were aimed primarily at providing protection from the thermal effects of the weapon rather than at protecting against flash blindness. At least in part, some protection from flash blindness has been provided by these efforts. For example, Fig. 5 shows a cockpit enclosure designed to be closed by the pilot, thereby protecting him from thermal effects. In later aircraft, this protective hood will close automatically when energy from the burst is detected. Thus, some measure of protection from flash blindness will be afforded, particularly from those weapons which produce extended fireballs.

A number of studies have shown that the recovery of vision after exposure to a high-intensity flash is much more rapid if the visual task is brightly illuminated. It has been found, for

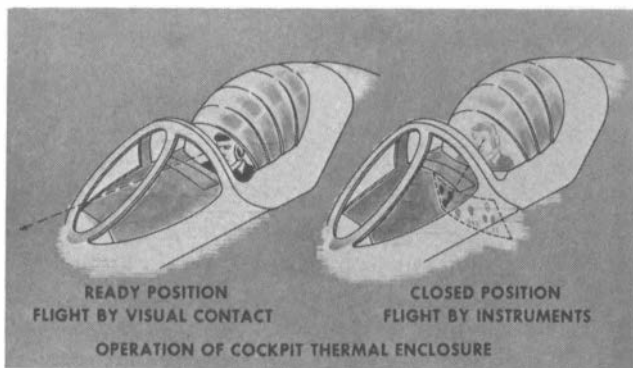

FIG. 5.

example, that a period of flash blindness that would last from 20 to 30 sec under normal lighting can be reduced to approximately 2 sec simply by floodlighting the visual task with 50 foot-candles. Thus, an obvious means of reducing the period of flash blindness suffered by a pilot is to provide for an automatic increase in the intensity of cockpit lighting immediately following exposure to a burst. A system for automatically increasing the intensity has been developed.

While thermal shields and automatic high-intensity cockpit lighting systems do offer some protection against the effects of flash blindness, the most obvious means of providing this protection lies with the development of devices designed to limit the visible energy which reaches the eye. Fig. 6 lists areas which offer protection possibilities. As can be seen, these areas range from the use of a simple monocular eye patch to the highly sophisticated television devices indicated under indirect vision techniques.

### AREAS OFFERING PROTECTION POSSIBILITIES AGAINST FLASH BLINDNESS

1. MONOCULAR EYE PATCH
2. PARTIALLY-OCCLUDING (FIXED FILTER) GOGGLES
3. FULLY-OCCLUDING (ACTIVE) GOGGLES
4. PHOTOTROPIC GOGGLES
5. PHOTOTROPIC CANOPY
6. INDIRECT VISION TECHNIQUES

FIG. 6.



As a means of providing a measure of protection while more efficient devices are developed, the Navy has considered the use of monocular eye patches. Figure 7 shows a pilot wearing an eye patch during a recent evaluation at the Navy Aviation Medical Acceleration Laboratory to determine the extent of visual impairment caused by light leaks around the patch. For a time there was concern that the afterimage produced in the exposed eye would cause a cortical blurring of the image received from the protected eye after the patch was removed. Recent limited testing, however, indicates that this blurring is not sufficient to cause alarm. Useful vision is regained in the protected eye almost immediately following the flash, while vision through the exposed eye may remain impaired for many seconds. The major problem with this protective device, however, is that since vision is so critical to most missions the maintenance of vision in one eye is generally regarded as only a poor interim solution to the protection problem. Such patches, however, can be carried by pilots as a means of achieving some measure of protection during emergency conditions.

For several years, the Navy has been investigating the protection potential of fixed-density goggles. In 1958, general purpose light-restrictive filter goggles, known as LRFG-58, were issued. Fig. 8 shows these goggles being worn with the aviator's helmet and oxygen mask. Photometric transmission of these goggles was 1 per cent. It was hoped that they would allow a



FIG. 7.



FIG. 8.

pilot to see well enough to fly during daylight by visual contact, and at night by instruments when the instruments were flood-lighted.

In spite of the obvious protective benefit of 1 per cent transmission goggles, they are not being used by the Navy at this time. Primary reasons are excessive visual fatigue, limited peripheral vision, and an apparent insufficient transmission of light. Recently, however, the Navy and the Air Force have tested gold-covered visors with no peripheral vision limitations for use during daylight missions. The gold-covered visors also have a photometric transmission of 1 per cent. The improved field of vision and the apparent increased brightness in the yellow band seem to reduce problems of visual fatigue.

Pilots who examined these materials initially indicated a 1 per cent coating was too dark to visualize other aircraft making the device unacceptable for daylight use. Accordingly, the Navy has changed to a 3 per cent coating which has met with much greater pilot acceptance and seems to involve only a nominal loss of protection.

While fixed-filter goggles might provide adequate protection against retinal burns and flash blindness, they do impose a penalty of loss of vision because of the low transmittance of the filter. At dusk or at night this is unacceptable. Considerable effort has, therefore, gone into the development of "active" devices which are transparent normally, but which "close" when exposed to

intense light. Another paper in this Report will be devoted specifically to the characteristics of these active devices.

As has been indicated, there are a number of avenues being pursued in the quest for effective protective devices. It is quite possible that more than one will be accepted as satisfactory for service use. Should this be the case, a specific protective device could be selected to match the particular hazards of a given mission. However, such use of these protective devices cannot become a reality until more is known about the nature of the hazard. Thus, the Navy is developing a comprehensive model within which it should be possible to specify a typical or anticipated nuclear environment, and then to evaluate the extent of the flash blindness hazard for aviators flying missions within such an environment. Figure 9 shows the classes of variables which will be used in the development of the model, and, to some extent, the specific variables falling within each class. One advantage underlying the development of the model is that missing parametric terms in the model can be identified which will thus tend to structure research efforts toward a meaningful goal.

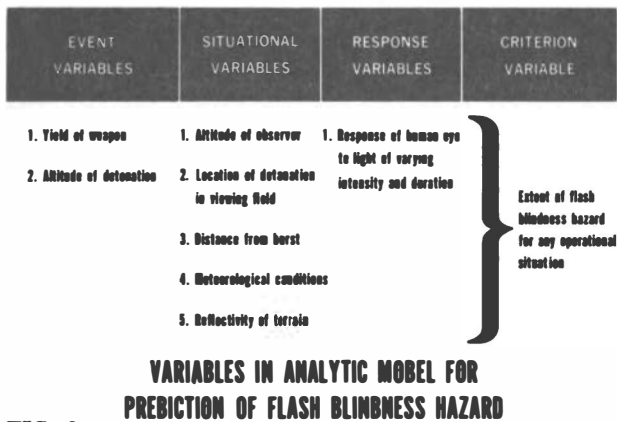

FIG. 9.

One final developmental effort being undertaken by the Navy should be noted. Flash blindness protective devices, as they are delivered into the fleet, represent a class of equipment entirely new to pilots. These devices attempt to meet a requirement for which no previous equipment has been provided. Since they are so new and since many of them operate in a strange manner, their introduction into the fleet must be accompanied by a training program designed to illustrate their method of operation and proper use. In addition, the flash blindness phenomenon itself

should be so interpreted both psychologically and physiologically in a manner so that pilots understand and appreciate the inherent hazards. Considerable effort is being devoted at this time to the development of a comprehensive training program. Much of this program involves, as might be expected, training manuals and training films. However, at the heart of this program is what is termed a "flash blindness indoctrination and training device." It consists of a high-intensity flash source which simulates the light that would be encountered by a pilot should he be flying within haze conditions or over reflective terrain at the time of the flash. With this source it is possible to produce all of the features of flash blindness; that is, startle, intense afterimages, and visual incapacitation, without the risk of permanent damage to the visual system. By actually experiencing flash blindness, a pilot will better appreciate the need for protective devices and should be more highly motivated to use them correctly.

Some of the reasons have been presented here as to why the Navy considers the problem of flash blindness to be quite serious from an operational point of view, and the extent of the programs being pursued to combat this hazard. In spite of the automatic characteristics of the modern weapon systems, the human eye continues to play a dominant role in many if not all military activities. With effective vision of such importance, it must be protected.

## THE NATURE OF RADIATION FROM NUCLEAR WEAPONS IN RELATION TO FLASH BLINDNESS<sup>1</sup>

J. H. Hill and Gloria T. Chisum  
Aviation Medical Acceleration Laboratory, USN  
Air Development Center

The fireball of a nuclear weapon detonated in the atmosphere appears to radiate as a black body. The visible portion of the spectrum of this radiation produces a high-intensity flash that can cause flash blindness—the temporary reduction in visual sensitivity following exposure to a high-intensity flash. Although such a weapon flash can also cause retinal burns, this paper is limited to the nature of the radiation in relation to flash blindness.

The minimum information about a light source necessary to determine whether or not it will produce flash blindness, and, if so, to design adequate flash blindness protective devices consists of the luminance, duration, and visual angle subtended by the source. Estimations of these dimensions of a light flash with a nuclear weapon fireball as a source can be deduced from information given in Glasstone, 1962. Although the weapon flash parameters thus determined from scaling laws are, at best, estimates, it is hoped that the data presented will provide some guidelines for others interested in the problems of flash blindness research and development as they have for the scientists at Vision Research, Aviation Medical Acceleration Laboratory (AMAL).

The thermal radiation from a nuclear weapon detonated at low altitude amounts to about 35 per cent of the yield of the weapon. The other 65 per cent is in nuclear radiation and mechanical energy as shown in Fig. 1. The ranges within which the latter

1. Opinions and conclusions in this report are those of the authors and do not necessarily reflect the views or the endorsement of the Department of the Navy.

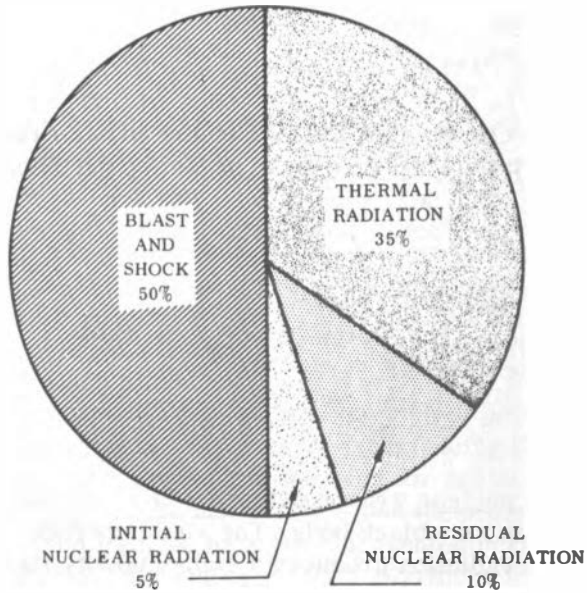

FIG. 1. Distribution of energy in a typical air burst of a fission weapon in air at an altitude below 100,000 ft. (Glasstone, 1962)

two forms of energy are dissipated to safe levels are much shorter than that for the thermal energy. The variation of the ranges with weapon size is shown in Fig. 2.

It can be assumed for purposes of this paper that, except for their eyes, personnel can be adequately protected up to the point at which they would receive second-degree burns. On this basis, one can make use of the concept of equal effects of nuclear weap-

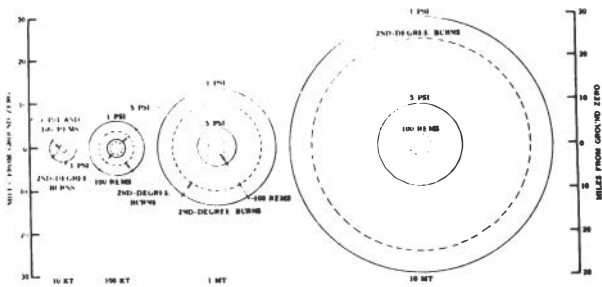

FIG. 2. Idealized ranges for effects of air burst with the heights of burst optimized to give the maximum range for each individual effect. (Glasstone, 1962)

ons regardless of weapon size. This concept is illustrated in Fig. 3. At 0.1 mile from a 1-kiloton (KT) weapon, or 10 miles from a 1-megaton (MT) weapon, or anywhere to the left of the second-degree burn line, the thermal and mechanical damage may well be so excessive that flash blindness is not a problem. The point at which flash blindness can become a problem is to the right of the second-degree burn line. The second-degree burn distance has been arbitrarily defined as the minimum "safe" distance.

Figure 4 shows the thermal history of a nuclear detonation at low altitude. The form of this curve—a very rapidly rising and falling pulse followed by a second, longer, slower rising and falling pulse—is the same for all weapons regardless of weapon size. The time at which the minimum occurs varies with the weapon yield according to the scaling law,  $t_{(min)} = 0.0025 W^{1/2}$ , where

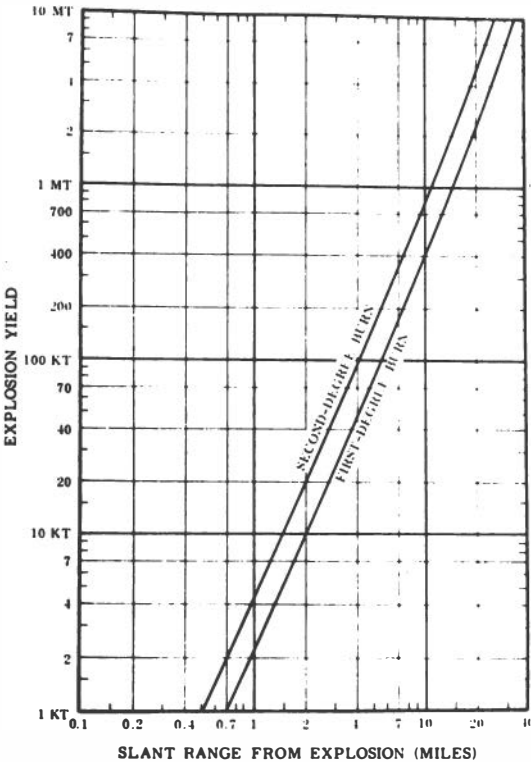

FIG. 3. Ranges for first- and second-degree burns as a function of the total energy yield. (Glasstone, 1962)

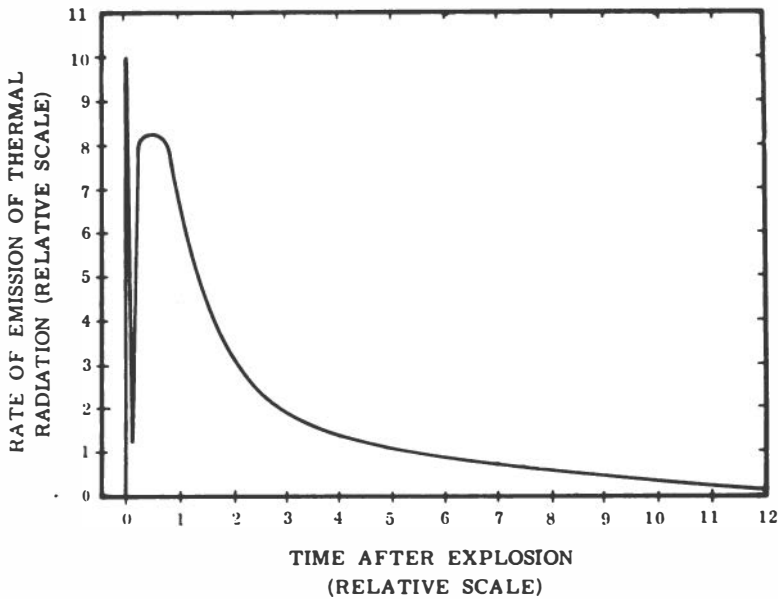

FIG. 4. Emission of thermal radiation in two pulses in an air burst. (Glasstone, 1962)

$W$  is the yield of the weapon in kilotons. The rate of emission, on the other hand, is a function of fireball temperature, which is independent of weapon size.

Fireball temperature as a function of time is shown in Fig. 5. Because the emission of the fireball approximates that of a full radiator, the luminance of the fireball can be determined from its effective temperature. With the aid of black-body luminance tables (Pivovonsky & Nagel, 1961), the fireball temperature curve was converted to a luminance curve. The effects of weapon yield and viewing distance were taken into account by translating the curve the appropriate distances along the axes. The minimum safe distance for each weapon and an atmospheric transmission of 80 per cent were used in these calculations. These curves are shown in Fig. 6. The luminances of the smaller weapons viewed at the minimum safe distances exceed the luminance of the sun. The significance of these luminances for visual effects is more readily apparent from the integrated curves shown in Fig. 7. The integrated luminances which would be received by the eyes, protected only by the blink reflex, and by some of the protection devices under development, are indicated along the abscissa. The integrated luminance received with only the blink



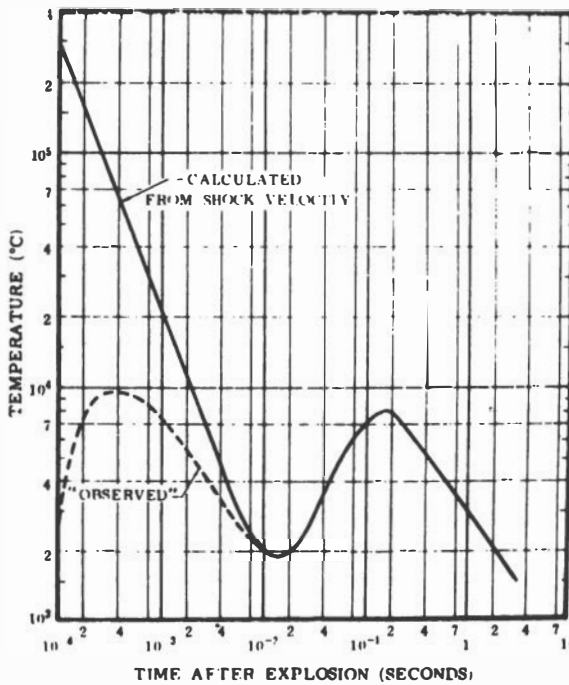

FIG. 5. Variation of apparent fireball surface temperature with time in a 20-kiloton explosion. (Glasstone, 1962)

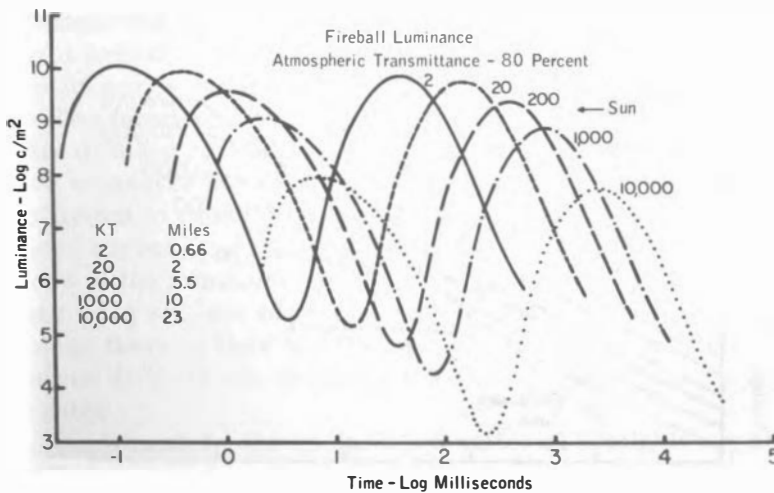

FIG. 6. Fireball luminance for five weapon yields at minimum safe distance with 80 per cent atmospheric transmittance.

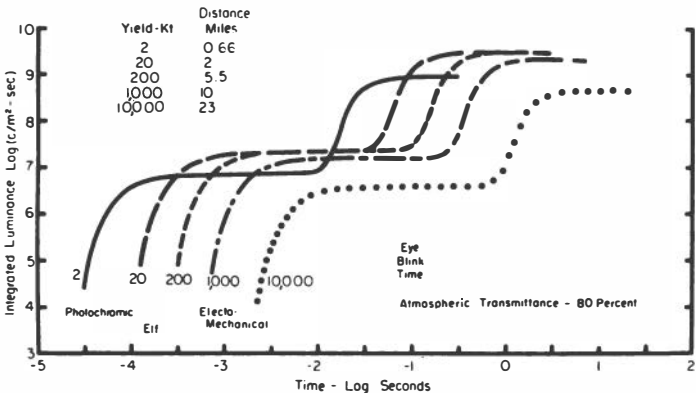

FIG. 7. Integrated fireball luminances for five weapon yields at minimum safe distances with 80 per cent atmospheric transmission.

reflex as protection would be about equal to looking at the sun for one full second.

The extent of the retina covered by the image of a fireball will depend on the viewing distance as well as the fireball diameter, which is a function of yield and time. The relation of fireball diameter to yield and time is shown in Fig. 8. The fireball diameter at any specific time after detonation varies directly with weapon size. The visual angle subtended by a fireball when viewed at the minimum safe distance varies inversely with weapon size as shown in Fig. 9. As the fireball diameter increases the retinal image size increases. This increase in image size stimulates

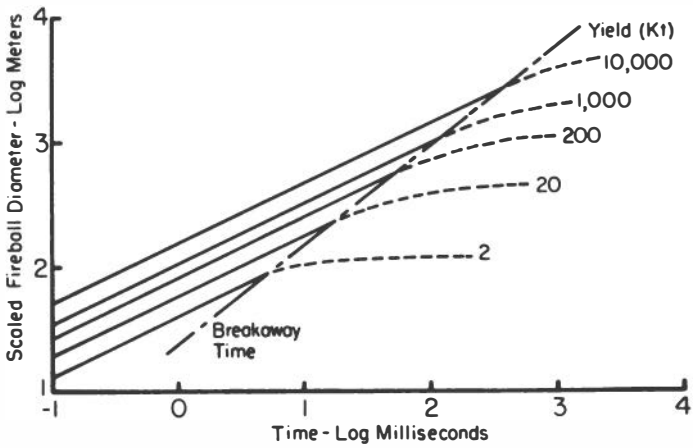

FIG. 8. Fireball diameters for five weapon yields.

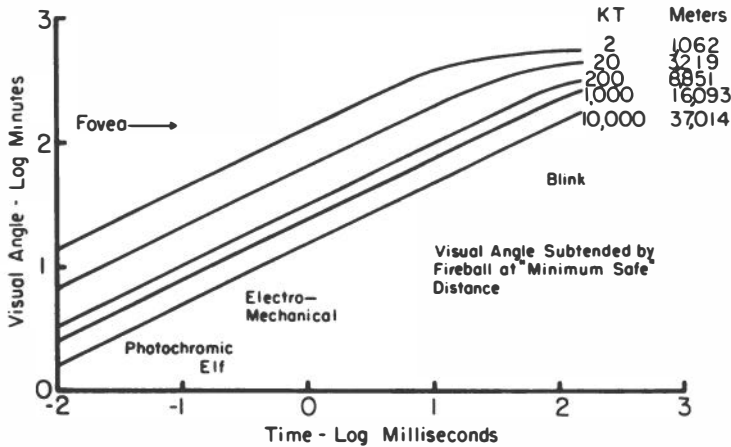

FIG. 9. Visual angles subtended by fireball of five weapon yields at minimum safe distances.

new areas of the retina. Only the retina at the center of the image receives the full extent of the fireball luminance.

In the event that the fireball itself is not imaged in the retina, other surfaces within the visual field will be illuminated by the fireball. For this reason it is important to know how much illumination a fireball can produce. The illumination received at the minimum safe distance can be determined from the fireball luminance and diameter, viewing distance, and atmospheric transmission. This relation is shown in Fig. 10. The luminance of a surface with a diffuse reflectance of 10 per cent is shown on the right ordinate scale. Integration of the illumination and resulting luminance is shown in Fig. 11.

The integrated luminance received from a surface with 10 per cent diffused reflectance can be over 5 log mL-sec if no protective measures but the blink reflex are used. This luminance is sufficient to cause flash blindness hazardous to a pilot. From these curves it is readily apparent that for low-altitude detonations at the minimum safe distances, the eyes can receive more than 5 log mL-sec of visible energy from a 10 per cent reflector before there is time to blink, and the luminance of a fireball viewed directly can be as much as four orders of magnitude greater.

Unfortunately, the unclassified material available for high-altitude detonations is severely limited. The dangers of eye damage from high-altitude detonations can be surmised, however, from the qualitative comparison of the rates of emission for high-

ILLUMINANCE FROM FIREBALL ATMOSPHERIC TRANSMITTANCE - 80 PER CENT

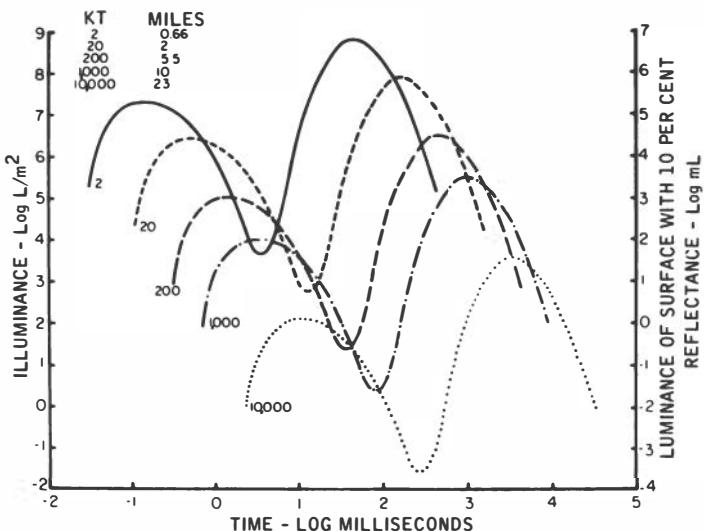

FIG. 10. Fireball illuminances for five weapon yields at minimum safe distance and luminances of 10 per cent reflecting surface at 80 per cent atmospheric transmission.

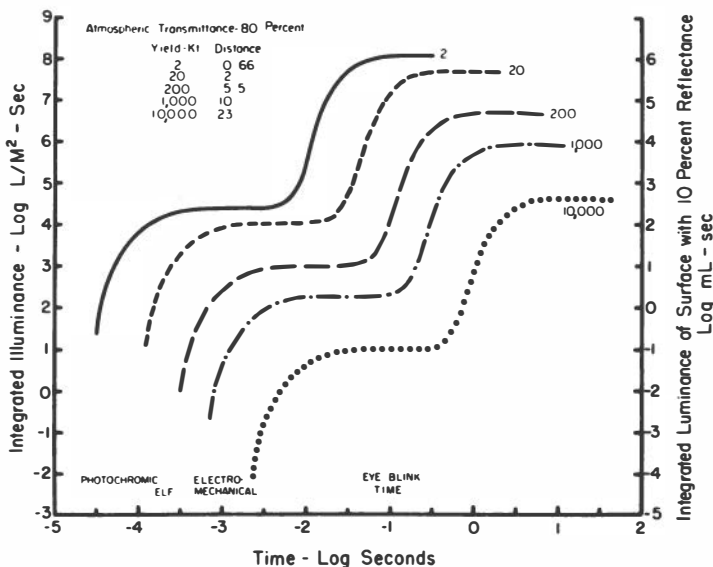

FIG. 11. Integrated fireball illuminance for five weapon yields at minimum safe distances and integrated luminance of 10 per cent reflecting surface at 80 per cent atmospheric transmission.

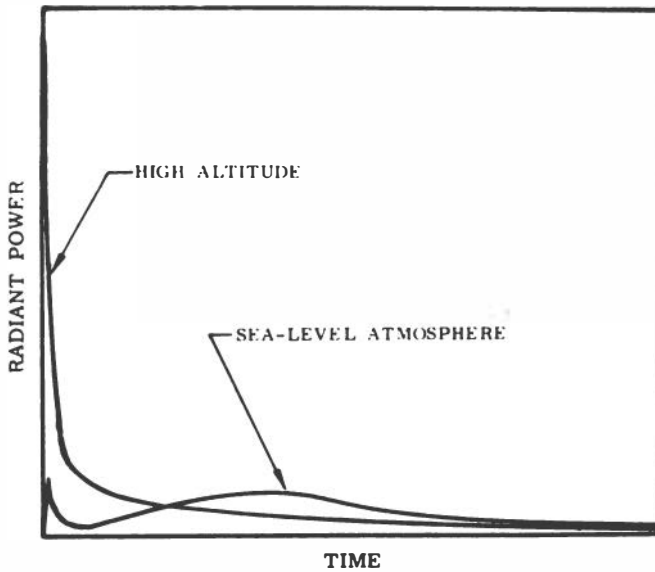

FIG. 12. Qualitative comparison of rates of arrival of thermal radiation at a given distance from high-altitude and sea-level bursts. (Glasstone, 1962)

altitude and low-altitude bursts shown in Fig. 12. The total thermal energy for high-altitude bursts is 50 per cent of the weapon size as compared to 35 per cent for low-altitude bursts, and the rate of emission is also many times greater.

The predictions of luminances made in this paper should be considered merely as guidelines. Other factors not considered, such as altitude of detonation, terrain, atmospheric and meteorological conditions, are required for prediction of flash luminances in operational situations. With reasonable knowledge of the luminance that personnel may be expected to encounter in operational situations, adequate flash blindness protection will be devised, and the minimum safe distance for personnel will not have to be extended.

## REFERENCES

- Glasstone, S. (Ed.) *The effects of nuclear weapons*. Washington: U.S. Atomic Energy Comm., 1962, Dept. Army Pamphlet No. 39-3.
- Pivovonsky, M., & Nagel, M. R., Tables of blackbody radiation functions. New York: Macmillan Co., 1961.

## EXPERIMENTAL INVESTIGATIONS OF THE FLASH BLINDNESS PROBLEM

John Lott Brown  
The School of Medicine  
University of Pennsylvania

It has been made clear that military aviators must depend on vision, in many cases unaided vision outside of their aircraft, for satisfactory performance in a variety of situations. High energy flashes from atomic weapons can seriously impair visual function at ranges beyond those at which damage to an aircraft or injury to the pilot may occur. The design of the eye for light detection renders it uniquely susceptible to excesses of light at ranges well beyond those where light energy may affect any other part of the body. There is, thus, an operational requirement for providing protection against visual incapacity in ranges from those within which damage to the aircraft or injury other than to the eyes of the pilot will jeopardize a mission out to a range of complete safety.

The first step in the development of appropriate protection is the specification of the physical conditions against which protection must be afforded. The previous paper provides information concerning the temporal and spectral variations in energy from atomic weapons of a number of different yields. The relation of effect to range is also discussed. A second step in the development of effective protection is the determination of how vision is impaired by exposure to unusually high energy levels in spectral and temporal patterns that are representative of those to be encountered from atomic weapons. One approach to the problem is to attempt field tests of visual function and visual impairment in conjunction with atomic weapon tests. Field tests may provide valuable information relative to the effectiveness of protective devices and general reactions to weapon detonation, but they can

hardly be expected to provide much information relative to the retinal processes involved. Such tests are always on a noninterference basis, i.e., secondary to engineering questions and considerations. Field test attempts that have been made indicate that the requisite attitude of scientific deliberateness is difficult for either experimenters or subjects to achieve in the awesome proximity of an atomic blast. In one such attempt, no evidence of any flash blindness effect was found. It was later ascertained that all subjects, including the project director, had their eyes tightly closed prior to and during the blast. The count-down was audible to all, and the final syllable produced an involuntary lid closure in all concerned.

There are two additional factors which tend to limit the value of attempts to study basic visual processes in conjunction with atomic weapon tests. In the first place, it is never possible to specify beforehand what the precise physical characteristics of a detonation will be, and, in the second place, there is almost no chance of replicating a given set of conditions. These considerations all argue for the study of basic visual functions which relate to flash blindness in the laboratory. Field tests, if they are ever again permitted, will afford a knowledge of the physical conditions to be encountered and will permit evaluation of protective devices and techniques, but information on the responses of the eye, from which necessary characteristics for protective devices can be specified, is best obtained in laboratory experiments.

It is the purpose of this report to consider flash blindness in relation to laboratory studies of the important parameters of the problem. The effects of these parameters are discussed in the succeeding sections of this paper. Flash blindness in the sense in which it is used in this report is a reversible reduction in visual capability which may incapacitate someone for the performance of visual tasks. A case of paramount importance is that of the pilot of a high-performance aircraft. Flash blindness may be defined quantitatively in terms of the duration of incapacity, or time for recovery from the effects of a blinding flash. Incapacity and recovery must, of course, be measured in terms of some specific visual task, and will vary in duration with the nature of the task. Such visual-task parameters as luminance and visual-acuity requirements are considered specifically in this report.

## PARAMETERS

### Energy of the Flash

It is useful to consider the way in which flash blindness, expressed in terms of recovery time, may be expected to vary with the energy of the blinding (adapting) flash. Flash duration is an important variable and a subsequent section is devoted to it, but in this section, flash duration is considered a constant. A hypothetical relation between the energy of an adapting flash and recovery time for a specific visual task is illustrated in Fig. 1. Recovery time is on the ordinate; adapting-flash energy is represented on the abscissa (for constant flash duration and constant spectral distribution, adapting-flash energy is proportional to radiant or luminous flux). For very low adapting-flash energies, there will be no effect on visual capability, and recovery time will be minimal. As energy is increased, there will be an increase in recovery time at an increasing rate. The form of this function will depend on the nature of the visual task. As the energy of the adapting flash reaches a level that corresponds to maximum possible bleaching of photosensitive substances of the retina, the rate of increase of recovery time may be expected to reduce. Recovery

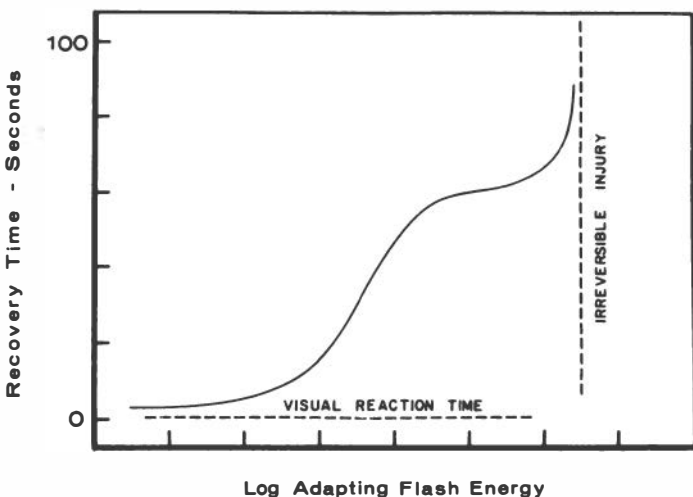

FIG. 1. Hypothetical curve illustrating relation between energy of blinding flash and time required for detection of information in a visual display. Minimum detection time at low flash energy corresponds to visual reaction time. Detection time approaches infinity as flash energy approaches value which will cause irreversible injury.



time may actually assume a constant value over some range of adapting-flash energy beyond that at which maximum retinal bleaching has occurred.

As energy is further increased into the range where injury may occur, it is to be expected that recovery time will again increase. The mechanism of recovery in this range will no longer be the same as that of normal adaptation, and as the extent of the injury increases, recovery time will increase at an increasing rate, reaching an infinite value when the injury becomes irreversible.

Several experiments have been performed which illustrate various parts of the function presented in Fig. 1. Metcalf and Horn (1958) employed a 0.1-second (sec) adapting flash with a diameter of approximately  $4^\circ$  of visual angle at luminances from 46,000 foot-Lamberts (ft-L) to over 9,000,000 ft-L. The natural pupil was dilated and an artificial pupil was employed. Results were expressed as the time required for two successive detections of a 17-min circular test patch at a luminance of 0.07 ft-L, which flashed on and off at 1-sec intervals. Results for each of four subjects are illustrated in Fig. 2. The independent variable, adapting illumination, is presented as a function of the dependent variable, recovery time. This changes the appearance of the functions somewhat by indicating variability in adapting luminance with increasing recovery time rather than the actual relation. This relation is a somewhat variable one, but can be approximated by a straight line. Thus, for the range of adapting-flash luminances represented, recovery time increases from a few seconds to over 2 min in direct proportion to the logarithm of the adapting-flash energy. Recently, Miller (1964) has obtained similar data for adapting energies of from 5.94 to 7.93 log troland-seconds with flash durations of from 42 microseconds ( $\mu\text{sec}$ ) to 1.4 milliseconds (msec). Time required after exposure to an adapting flash before a subject could correctly identify a test letter illuminated at 0.066 millilamberts (mL) provided a measure of the duration of flash blindness. Miller presented her data in the form of recovery time versus log adapting-flash energy in troland-seconds. She transformed the data of Metcalf and Horn (Fig. 2) to troland-seconds for comparison, and found the two sets of results to be almost superimposed. Such a comparison is difficult to evaluate, however. Miller employed an artificial pupil of  $4 \text{ mm}^2$  while Metcalf and Horn employed a 6-mm diameter pupil. Under these circumstances for equal troland-seconds, the adapting flash presented by Miller should have been the more

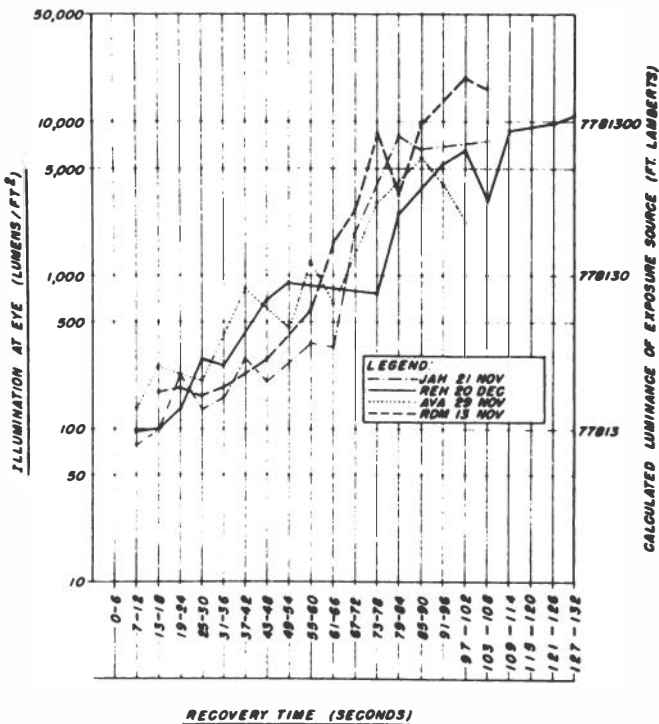

FIG. 2. Time required for detection of 17-min circular test patch at luminance of 0.07 ft-L as function of luminance of adapting flash. Mean values for each of four observers (Metcalf and Horn, 1958).

detrimental, since it was presumably confined to the central region of the pupil and not diminished by the Stiles-Crawford effect. However, Miller employed a recognition criterion, and Metcalf and Horn employed a detection criterion. Under these circumstances, equal detection times would indicate that the conditions of adaptation employed by Miller were less detrimental.

The relation between adapting luminance and recovery time has also been discussed by Whiteside (1960). He has presented data from several experiments (Fig. 3), which, when replotted in terms of recovery time versus log adapting-flash energy, show an approximately straight-line relation between these variables over a wide range. The data from one experiment (Whiteside & Bazarnik, 1952) which extend up to a higher level of adapting-flash energy (greater than  $3 \times 10^7$  mL-sec) show a sharp increase in recovery time at this level. Whiteside has suggested that this may reflect the beginning of retinal damage.

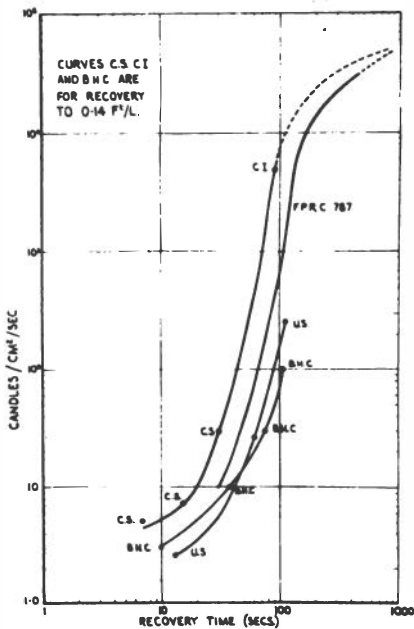

FIG. 3. Recovery times for detection of criterion targets after exposure to adapting flash as measured by several investigators. BHC curve obtained by Crawford with 0.14 ft-L target. US curve represents data of Metcalf and Horn. Other data obtained by Whiteside (Whiteside, 1960).

Some of the results of a flash blindness experiment performed by Hill and Chisum (1962) are presented in Fig. 4. Recovery was measured in terms of the time required for detection of the orientation of a grating pattern. This pattern consisted of parallel lines and spaces 3 min of arc in width, and hence required the function of cones for its resolution (Brown, 1954). Data were obtained for three grating-pattern luminances and for each of two adapting-flash durations. It is clear that each of these parameters has an important influence on recovery time, and they will be considered in detail in subsequent sections. Of interest here is the fact that for very low adapting-flash energies recovery time is short, and as adapting-flash energy increases, recovery time increases at an increasing rate. There is some indication that recovery time may approach a plateau for adapting-flash energy of greater than 4.5 log mL-sec (data for the longer flash duration).

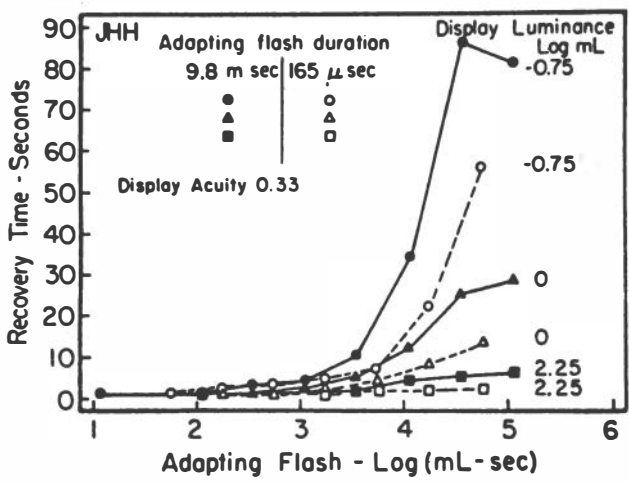

FIG. 4. Time required to perceive acuity target as function of energy of adapting flash (log millilambert-seconds). Individual curves represent each of two adapting-flash durations for three acuity target illuminations (Hill & Chisum, 1962).

In summary, several experiments have been performed that provide a relation between recovery time and the energy of an adapting flash. No single experiment has covered a sufficiently wide range of adapting luminances to illustrate both extremes of the relation presented in Fig. 1. When considered together, the experiments of Hill and Chisum (1962), and Whiteside and Bazarnik (1952) do support the kind of relation proposed in Fig. 1, however. It is obviously impossible to investigate the upper range of this relation extensively with human observers.

#### Flash Blindness Criteria

Comparison of experimental studies of flash blindness is rendered difficult by the various criteria of flash blindness which have been employed by different investigators. It is, therefore, of considerable importance to consider further the effects of changing various parameters of the visual task which serves as a criterion of flash blindness.

Luminance. Data are presented in Fig. 4 for each of three display luminances: -0.75, 0, and 2.25 log mL. It is clear that an increase in display luminance has a highly significant effect on recovery time, particularly at the high adapting-flash energies where flash blindness may be a problem. The hypothetical relation in Fig. 1 may be illustrated in a more general way by taking

the effect of display luminance into account. This is illustrated in Fig. 5. The uppermost curve represents a relatively low display luminance. Increasing display luminances are represented by successively lower curves in the figure. The minimum recovery time at low adapting-flash energy for the individual curves is shown to decrease with increase in display luminance. This relation is slightly exaggerated, but visual reaction time will decrease to a minimum value with increase in the luminance of a visual display (Teichner, 1954). All of the curves show the final increase in recovery time toward an infinite value at the same adapting-flash energy. This characteristic of the curves is attributed to retinal injury which will be dependent solely on the characteristics of the adapting flash. It is possible, of course, that the effect of injury on recovery time will vary with the criterion task, but for a given task with changes only in display luminance, the relations presented in Fig. 5 would seem to be the most probable.

The nature of the relation between recovery time and display luminance can be inferred from Fig. 5. In Fig. 5, each of the vertical dashed lines which cut through the family of curves for

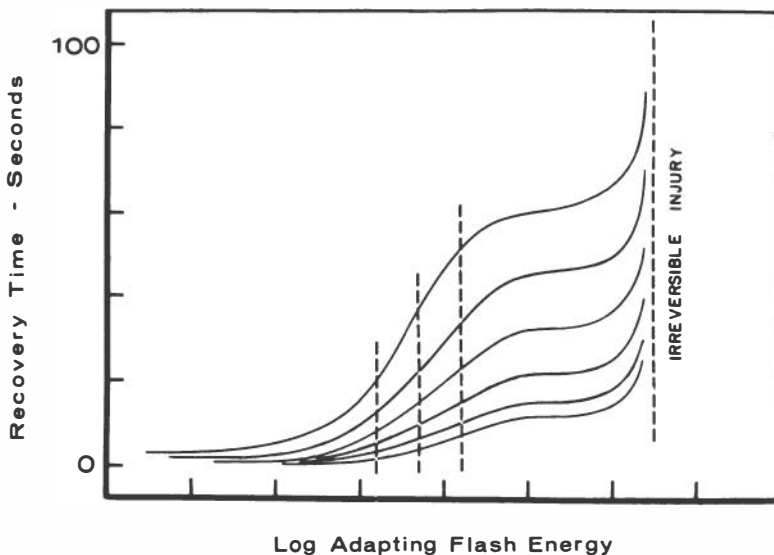

FIG. 5. Hypothetical functions like that in Fig. 1 for various luminances of display. (Display luminance assumed to increase in equal logarithmic steps from low value for top curve to high value for bottom curve.) Vertical dashed lines are construction lines for derivation of functions of kind illustrated in Fig. 6.

different display luminances represents a specific adapting-flash energy. It is evident that as display luminance is increased there will be a decrease in recovery time at a decreasing rate down to a minimum value. This relation will be steeper and have a higher final minimum value of recovery time, the higher the adapting-flash energy.

Both Metcalf and Horn (1958) and Whiteside (1960) recognized the possible importance of the luminance of the criterion task on flash blindness, but they obtained very little data relevant to this point. In order to clarify this aspect of the problem, experiments were performed in which display luminance was a primary independent variable (Brown, 1959; 1964). Recovery time was measured as a function of display luminance for each of several adapting-flash energies. Adapting-flash duration was held constant at 0.9 sec. The display consisted of a grating pattern, and observers were required to identify its orientation. A timer was started and the grating was illuminated with presentation of the adapting flash. As soon as grating orientation was detected the observer depressed a switch that turned off the timer and the display. Detection times were recorded only for correct identification of grating orientation. The relation of detection time to display luminance is illustrated in Fig. 6 for each of two observers and for each of two grating sizes. The families of curves in the upper part of the figure represent results with a grating, the individual lines of which subtended a visual angle of 3.8 min of arc. Detection of the orientation of such a grating will depend on cone vision (Brown, 1954). The lower curves were obtained for a grating which represented a visual angle of 12.5 min of arc. Rods may serve in detection of the orientation of the coarser grating (Brown & Woodward, 1957). All of the data in Fig. 6 have been fitted with curves based on a single equation. The fit is good for data of this kind. (cf. Severin, Newton, & Culver, 1962; Severin, Alder, Newton, & Culver, 1962). Data for the two observers are quite similar. As display luminance is reduced, detection time increases at an increasing rate down to a display luminance which represents the absolute threshold for the discrimination of the display pattern. At high display luminances, there is little difference in recovery time for different adapting luminances, although recovery time is slightly longer for the two highest adapting luminances. It is clear that display luminance is an extremely important variable, and that flash blindness effects can be significantly reduced by raising display luminance.

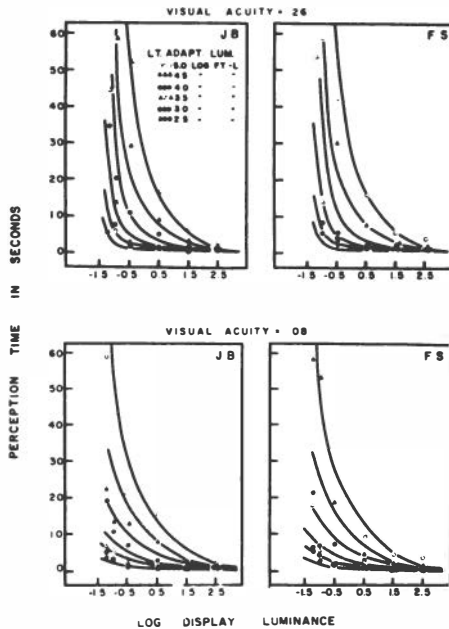

FIG. 6. Relations of perception time to log display luminance (foot-lamberts) for each of six adapting-flash luminances. Upper graphs represent grating display that required visual acuity of 0.26; lower graphs represent visual acuity of 0.08. Subjects JB and FS (Brown, 1964).

The criterion task. It is clear that a change in the visual acuity required for the visual task may alter the form of functions such as those presented in Fig. 6. Specification of the visual task in terms of acuity requirements is not sufficient to define the function, however, as visual acuity is an arbitrary and incomplete description of any visual display (Brown, Phares, & Fletcher, 1960). The nature of the function relating luminance and visual acuity varies significantly with changes in the kind of test pattern employed (Shlaer, 1937). Nevertheless, it can be concluded that differences in the course of recovery from flash blindness for different criterion visual tasks will be smaller for higher illumination of the tasks and for lower adapting-flash energies. Differences will be most prominent when the illumination provided is near threshold for one of the tasks.

### Duration of the Adapting Flash

The way in which the energy of an adapting flash is distributed in time may be expected to influence its effect. For the extreme case of retinal injury, it has been found that the threshold for a retinal burn is approximately 0.5 to 1.5 calories/centimeter<sup>2</sup> (cal/cm<sup>2</sup>). This energy must be delivered at a rate of at least 0.7 cal/cm<sup>2</sup>-sec, however, or the rate of heat dissipation in the tissue will be sufficient to prevent elevation of the temperature to a degree where a burn will result (DeMott & Davis, 1959).

The distribution of adapting-flash energy in time may also influence its effect on visual threshold. From studies of dark adaptation, there is evidence that for higher adapting luminances of shorter duration the early thresholds during dark adaptation are higher than those found after light adaptation of the same total energy with exposure of a lower luminance for a longer duration (Johannsen, 1934; Wald & Clark, 1937; Winsor & Clark, 1936; Mote & Riopelle, 1953). These experiments have not included the systematic investigation of very short duration, i.e., less than a second, however. Fry and Alpern (1951) measured changes in extrafoveal visual acuity for a line target illuminated at 0.01 ft-L during dark adaptation. Light-adapting luminances from 0.0137 to 13,660 ft-L for durations of from 0.003 to 3.0 sec were used. The earliest measurements of acuity were made 10 or 15 sec after the termination of light adaptation and showed considerable variability. The form of the function showing recovery of visual acuity with time in darkness was not affected by duration of light adaptation, but appeared to be determined by the product of the luminance and duration of the light-adapting flash, i.e., the total luminous energy. In the experiment by Miller (1964), the effect of exposure to an adapting flash on time required for recognition of dimly illuminated letters was also found to depend on total luminous energy, independent of flash duration. This was true for durations from 42  $\mu$ sec to 1.4 ms. Miller concluded that a reciprocal relation between luminance and duration of the adapting flash probably holds up to a duration of 100 ms on the basis of a comparison between her data and those of Metcalf and Horn. Differences in experimental procedures referred to above may render this comparison unjustified, however.

With respect to the purely photochemical aspects of light adaptation, the reciprocity relation between luminance and duration for bleaching of rhodopsin has been demonstrated by direct



measurement in recent years. Campbell and Rushton (1955) measured rhodopsin density in the living human eye and found reciprocity to hold for exposure durations of up to 48 sec. For equivalent total amounts of bleaching energy, equal amounts of rhodopsin were bleached during exposures up to this duration. The minimum time investigated was 300 ms.

Some evidence obtained with this technique has been presented that would lead to the conclusion that the effects of adapting flashes of very short duration might not be as severe as the effects of longer flashes of the same total energy. Hagins (1956) found it impossible to bleach more than 50 per cent of the rhodopsin of the rabbit retina with flashes of less than 1 ms duration no matter how high the luminance. If the same amount of energy was distributed between two flashes separated by 1 or 2 sec, it was possible to bleach up to 75 per cent of the rhodopsin. Dowling and Hubbard (1963) have explained this result in terms of underlying photochemical processes. A portion of certain unstable intermediate products of bleaching are isomerized back into photosensitive forms by light itself. With prolonged exposure, these are again bleached, a lesser portion returns to a photosensitive form and so on, until bleaching has reached the maximum possible for the luminance used. Thus, complete bleaching requires both light energy and time. When an adapting flash is of the order of 1 ms duration or less, bleaching cannot be as great as that which will occur for the same or even lesser amounts of light energy spread out more in time. Early thresholds measured after a short adapting flash will, therefore, not be elevated as much as those after a longer duration. Dark adaptation following a short flash is not equivalent to dark adaptation following longer exposure to a low luminance which results in the same amount of bleaching, however. A part of the dark-adaptation process, hydrolysis of all-trans bleaching products, can occur during exposure to light. Hence, when a longer duration adapting light is extinguished the process of recovery is at a more advanced stage than is the case after exposure to a short flash, even though photosensitive pigment concentrations and initial thresholds are the same. Complete recovery will take longer after the short flash.

Brindley (1959) has made some observations of afterimages that probably depend on these photochemical effects. Afterimages induced by flash luminances in excess of  $3 \times 10^6$  meter-candles were of the same appearance for all luminances as long as the total flash energy was presented in a short interval. The after-

image following a single flash was comparable to the afterimage of two successive flashes of the same luminance if the two were separated by only 250  $\mu$ sec. If the two flashes were separated by 4 ms or more, however, there was a clear difference in the afterimages. Thus, the additional energy of the second flash apparently had no effect unless it irradiated the retina at an interval of several milliseconds after the first flash.

The findings of Hill and Chisum (1962) presented in Fig. 4 may also be an illustration of these effects. The curves of recovery time versus adapting-flash energy all indicate a more rapid recovery from a short adapting flash (165  $\mu$ sec at one-third amplitude) than from a long adapting flash (9.8 ms at one-third amplitude) of the same total energy. When the energy is distributed over a longer time period, it is apparently more effective in the production of flash blindness. The experiment of Hill and Chisum is the only experiment in which extensive data on flash blindness has been obtained for flash durations both below and above a duration of from 1 to 4 ms. This is the range of durations below which Hagins and Brindley found a reduction in the effectiveness of a given amount of stimulus energy for the bleaching of rhodopsin and for the production of an afterimage.

The flashes employed by Hill and Chisum were produced by gas discharge tubes. Luminance rose sharply to a maximum, and then decayed exponentially. The spectral compositions of the long and short flashes were not identical, and the spectral composition of each may have varied with time during a single flash. In order to avoid difficulties associated with physical measurements, luminance of these flashes was measured in relation to threshold for resolution of a grating pattern with 3-min bars and spaces. Resolution of a grating of this size will depend on cone function (Brown, 1954). Threshold luminance was first measured with 8-ms flashes controlled by a mechanical shutter, and illumination from a uniform source of known luminance attenuated with neutral filters. Luminous energy at threshold was calculated by integrating threshold luminance over flash time. Thresholds were then remeasured with the gas-discharge tubes as sources of illumination, again attenuating luminance with neutral filters. It was assumed that at threshold the luminous energy was a constant, independent of changes in its temporal distribution (Brindley, 1952). Thus, the conclusion that the adapting effect of light flashes of a given energy is not constant when flash duration is reduced depends on the validity of the assumption that threshold energy is constant for similar changes in

flash duration. Verification and extension of the results of Hill and Chisum with a technique such as that employed by Miller (single source of known luminance; mechanical control of flash duration) will have important implications for the theory of visual function.

### Spectral Characteristics of Flash and Task Illumination

Some studies of flash blindness with various wavelength distributions of the adapting flash have been made, but they have been limited to low-flash energy levels by the use of selectively absorbing color filters for control of spectral distribution. The primary purpose of these studies has been to examine the possibility of protecting the eyes from flash blindness with color filters in the form of goggles, or in the form of a tinted aircraft canopy. In the first case, both the flash and the visual task would be viewed through the color filter, and the spectral distribution of both flash and task illumination would be modified accordingly. In the second case, the flash would be viewed through the color filter, but any task related to the instrument panel would be seen with its normal illumination unaltered.

Some data which illustrate the first case (Brown, 1959) are presented in Fig. 7. Each of five color filters was used with neutral filters such that the combination transmitted approximately 1 per cent of the visual task illumination (based on the photopic luminosity function). When the visual acuity requirement is 0.33, there is a regular increase in detection time at low illumination as the wavelength of maximum transmission of the color filter is decreased. No such regular increase is evident in the results for the 0.13 visual-acuity requirement. The explanation of these results probably lies in the fact that the luminance of the flash as seen through the blue filter was somewhat higher than the flash luminance seen through the red filter. This follows from the fact that the spectral distribution of energy in the flash was concentrated at shorter wavelengths than the energy of the task illumination, and the matching of photopic transmission of the various color filters was based on the task illumination. At low task luminances, the available illumination was not far above threshold for the finer grating, and its identification was, therefore, quite sensitive to changes in adapting-flash luminance. For the coarser grating pattern (visual acuity equals 0.13), there was no regular increase in detection time with change in the color of filters from red to blue. Detection of the coarser grating depended to some extent on scotopic

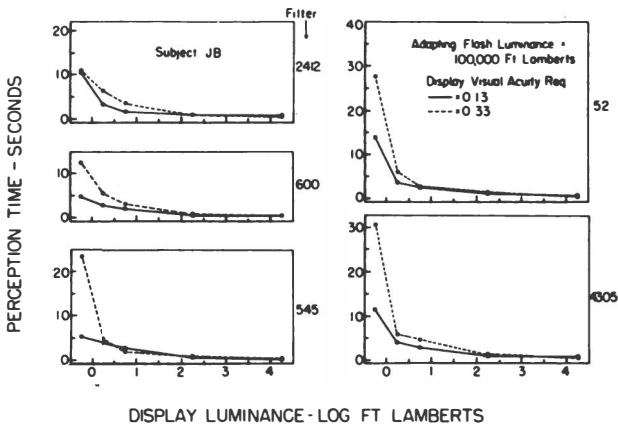

FIG. 7. Time required for perception of orientation of grating displays following exposure to 0.9-sec adapting flash of 100,000 ft-L. Color filters in front of eyes, both during exposure to flash and during viewing of grating. Filters are Corning 2412-red, Bausch & Lomb 600-red interference, Bausch & Lomb 545-green interference, Kodak 52-green, and Corning 4305-blue. Neutral filters added to each of color filters to reduce total photometric transmittance to 1 per cent (Brown, 1959).

vision. The desensitizing effect of the higher luminance of the blue flash was partially offset by the higher effectiveness of the task illumination as perceived through a blue filter for stimulation of the rods.

If colored protective goggles are to be worn continuously, and all visual tasks must be performed with goggles on, an interesting problem arises as to the optimum density of the goggles. Clearly, the greater the density the greater the protection afforded, but if the density is high and the light available for vision is relatively low, very dense goggles may seriously interfere with visual performance. It has been shown that for illumination of an 8-min grating pattern below 1 ft-L, recovery from the effects of a 100,000 ft-L flash will be faster for goggles with 10 per cent transmittance than for goggles with 1 per cent transmittance, even though the denser goggles permit only one-tenth as much of the adapting energy to enter the eye (Brown, 1959).

If the protective filter attenuates only the adapting flash and not the illumination of the visual task, shorter wavelength transmittance is bound to be accompanied by an increase in detection time for a coarse grating at low levels of illumination of the

visual task. This may be attributed to the increased desensitizing effects of the shorter wavelength adapting flash on the rods, which, in this case, is not compensated by a more effective spectral distribution of illumination of the visual task.

It is difficult to predict the result of investigations in which spectral variations are included. These results depend on the population of receptors required for the visual task, the threshold luminance for performance of the task, the spectral character and the energy of the adapting flash, as well as the spectral character and the luminance of the visual task illumination, and the spectral transmission characteristics of any filters employed. All of these factors must be taken into account.

### OTHER CONSIDERATIONS

There are a variety of additional variables that are of importance. Several of them should be mentioned here. Severin et al. (1963) have demonstrated that pupil size is a relevant variable in determining the amount of the flash blindness effect upon exposure to a given adapting-flash condition. The larger the diameter of the pupil and, hence, the larger the retinal illumination, the greater will be the duration of flash blindness. The effect is approximately proportional to pupil area.

Miller (1964) has shown that the area of the adapting-flash image on the retina has little effect as long as the entire fovea is illuminated. The criterion task in this investigation was recognition of a 20.3 min of arc test letter illuminated at 0.066 mL.

A characteristic of flash blindness experiments is the relatively high variability of results from one subject to another (Severin, et al., 1962; 1963). When very short adapting flashes are used, a slight deviation of gaze or blinking during presentation of the flash can appreciably reduce the flash blindness effect. There is some evidence that with an increase in subject experience, the results of different subjects become more nearly similar, and, at the same time, the flash blindness effect is somewhat greater than that found with inexperienced observers (Brown, 1964).

A number of investigators have discussed the problem of flash blindness in relation to the masking effects of the afterimage of the adapting flash. Actually, an afterimage disappears and reappears, and its moment-to-moment appearance bears little correspondence to the moment-to-moment changes in light-detection threshold during dark adaptation (Aulhorn, 1958). Barlow and Sparrock (1964) have attributed this to the fact that afterimages

are stabilized on the retina, and, therefore, must be compared with a physically stabilized retinal image if one wishes to evaluate their masking effect in relation to a physical stimulus. The work of Barlow suggests that changes in threshold during dark adaptation may be closely linked to the masking effect of the afterimage of the light-adapting stimulus.

### THE QUANTITATIVE FORMULATION OF FLASH BLINDNESS EFFECTS

From the practical standpoint, it would be useful to be able to express flash blindness effects in the form of an equation. Such an equation would permit the calculation of perception time for any combination of adapting-flash energy and display luminance over a wide range. A more useful application might be the calculation of required display luminance for the achievement of a perception time within some maximum acceptable time following exposure to a given adapting-flash energy.

Several approaches to the development of an appropriate descriptive equation have been investigated. The first of these was a consideration of an equation of the same form as one with which Rushton (1961) has been able to fit data of dark adaptation. Although techniques of making measurements in flash blindness experiments differ from those which are usually employed in studies of dark adaptation, flash blindness experiments are essentially studies of the early dark-adaptation process following exposure to short adapting flashes. Rushton has found that the logarithm of threshold luminance during dark adaptation is an exponential function of elapsed time from the termination of light adaptation. The equation provides a reasonable fit of rod dark adaptation, provided 25 per cent or more of the available rhodopsin has been bleached. Such an equation did not provide an adequate fit of the data of a representative flash blindness experiment (Brown, 1964). Its failure to do so may be attributed to the fact that perception times probably depend on cones rather than rods in most instances in the study of flash blindness, while Rushton's formulation was developed to represent recovery of the rods. It is also possible that the perception of targets within seconds after exposure to an adapting flash may be limited to a greater extent by neural events than by photochemical events. Once the parameters of the experimental procedure have been determined, the time course of dark adaptation in Rushton's formulation is entirely dependent on photochemical events.

The second equation considered was one proposed some years ago by Schouten and Ornstein (1939) to relate threshold luminance for the detection of a light to the time interval following exposure to an adapting flash. An equation of this form failed to provide an adequate fit of the data of a flash blindness experiment (Brown, 1964) when the values of various fixed parameters of the experiment were substituted appropriately in the equation.

Finally, several simple relations similar in form to the curves presented in Fig. 6 were investigated. These included reciprocal and exponential relations between log display luminance and time. In each case a minimum display luminance and minimum perception time were introduced. Minimum display luminance was based on the known minimum threshold luminance in the dark-adapted eye for the gratings employed. Minimum perception time was either a single value based on minimum visual reaction time (0.20 sec), or minimum perception time was permitted to vary with the luminance of the adapting flash. In the latter case, an attempt was made to estimate the minimum perception time by averaging minimum values for all observers for each adapting-flash luminance.

Experimental data were transformed to correspond to a straight-line transformation of each of the equations under investigation and replotted. An attempt was then made to fit straight lines to these distributions of transformed data. On the basis of visual inspection, one equation appeared to afford the best fit for all observers. This was an equation of the following form.

$$t - t_0 = a + [b/(\log L - \log L_0)], \quad (1)$$

where:

- t = perception time in seconds,
- $t_0$  = 0.20 sec for all conditions of adaptation,
- L = display luminance in foot-lamberts, and
- $L_0$  = minimum luminance at which the display can be perceived under optimum conditions.  
(-1.4 log ft-L for visual acuity of 0.26; -2.3 log ft-L for visual acuity of 0.08.)

Perception time t must approach a minimum  $t_0$  as display luminance L is increased, and it may safely be assumed that a value L will be reached beyond which there will be no further

reduction of  $t$ . If this is the case, then the constant,  $a$ , must be of the following form:

$$a = -[b/(\log L_{\max} - \log L_0)], \quad (2)$$

where  $L_{\max}$  is the luminance at which  $t_0$  is reached.

When perception time was plotted as a function of  $1/\log L - \log L_0$ , the lines of best fit for the various adapting-flash luminances tended to converge in the region of  $t = 0.2$  sec. For data representing a visual acuity of 0.26, the corresponding value of  $1/(\log L - \log L_0)$  was approximately 0.25. For the data representing a visual acuity of 0.08, the corresponding value was approximately 0.20. Values of  $\log L_{\max}$  can be calculated from these values, since they correspond with the minimum perception time,  $t_0 = 0.2$  sec. Values of  $\log L_{\max}$  calculated in this way were 2.6 for the higher acuity, and 2.7 for the lower acuity. These values may be considered equivalent in view of the approximate nature of the entire fitting procedure. Assuming a value of 2.7 for  $\log L_{\max}$ , Equations (1) and (2) can be combined and rewritten as follows:

$$t = 0.2 + b[(2.7 - \log L)/\log(L/L_0)(2.7 - \log L_0)]. \quad (3)$$

The smooth curves drawn through the data of observers FS and JB in Fig. 6 represent this equation. Values of  $b$  were obtained graphically from the straight-line transformations of each observer's data. The equation obviously does not afford a perfect fit of the experimental results, but in most cases it provides a reasonable approximation.

The value of  $b$  is the slope constant of the straight lines of best fit. It varies both with the luminance of the adapting flash and with the visual acuity required by the display. Relations between average values of  $b$  determined graphically for JB and FS and the energy,  $A$ , of the adapting flash were investigated for each acuity. It was found that the logarithm of  $b$  was proportional to the logarithm of  $A$  for the data representing both of the two acuity levels. A simple power function, therefore, serves to relate  $b$  to  $A$ :

$$b_{0.08} = 0.108A^{0.58} \quad (4a)$$

$$b_{0.26} = 0.022A^{0.68} \quad (4b)$$



where A represents adapting flash energy in foot-lambert-seconds.

Either of these values of b may be substituted in Equation (3) along with the appropriate value of  $\log L_0$  for the calculation of perception time. Equation (3) thus affords a basis for approximating perception time for conditions of adaptation and display luminances over the ranges employed in the experiment. It must be emphasized that this is an approximate, empirical relation. Nonetheless, it represents an objective basis for estimating over a fairly wide range of conditions the blinding effects of short adapting flashes in terms of the extension of perception time that may be expected to result.

There are some conditions for which these equations do not hold, however. With high target or display illumination, the minimum time required for the detection of a given display appears to be somewhat longer when the adapting-flash energy is higher. This is illustrated in Fig. 5. When adapting-flash energy reaches a value somewhat below that which corresponds to the plateau preceding the final increase in detection time in Fig. 1 and Fig. 5, Equation (4) will no longer hold.

The results of Hill and Chisum presented in Fig. 4 illustrate the significance of flash duration. Curves for both flash durations were cut by vertical lines at adapting-flash energies of 3.9, 4.2, and 4.6 log mL-sec. The intersections of these vertical lines with the functions for each of the three grating display luminances provided coordinates in display luminance and recovery time with which to check the adequacy of Equation (3) for describing the results of Hill and Chisum. The logarithm of the minimum luminance ( $L_0$ ) for resolution of a 3-min grating (visual acuity equals 0.33) is approximately -1.2 (Brown, Graham, Leibowitz, & Ranken, 1953). In Fig. 8, recovery time is plotted as a function of the reciprocal of  $\log L/L_0$  for each of the three selected values of adapting-flash energy and for each of the two flash durations. The data can be fitted quite well with straight lines. It is clear, however, that the lines for different flash durations do not all converge at a single point. The values of b for the longer flash duration data are found to fit the equation:

$$b_{0.33} = 0.01 A^{0.8}. \quad (4c)$$

The constants in this equation appear reasonable in relation to those in Equation (4b) for a slightly lower visual acuity requirement.

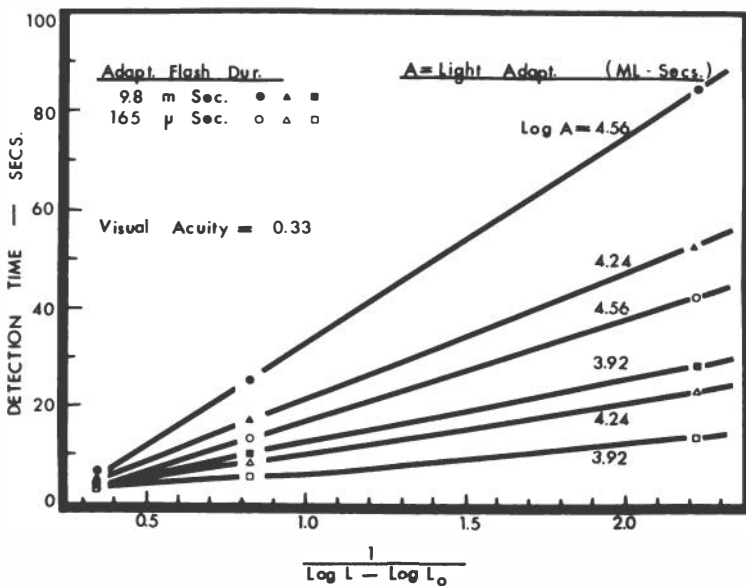

FIG. 8. Time required for detection of a 0.33 acuity grating as function of  $1/(\log L - \log L_0)$ , where  $L$  is grating luminance and  $L_0$  is minimum (threshold) grating luminance. Functions represent two adapting-flash durations and three adapting-flash energies. Functions derived from data presented in Fig. 4.

It is clear that values of  $b$  for the shorter flash duration cannot be calculated from Equation (4c). This equation can be used to calculate values of adapting-flash energy at the longer flash duration, which would be equivalent to the shorter duration adapting-flash energy in their effects on recovery time, however. This has been done for each of the three short flash-duration curves in Fig. 8. In each case, the shorter flash duration corresponds to a reduction in adapting-flash energy at the longer duration by a factor of 2.5. This corresponds to a shift of the short duration curve in Fig. 4 along the abscissa, a distance of 0.4 log unit from the corresponding curves for a longer flash duration. In other words, light-adapting flashes of less than 1-3 ms duration may be only 40 per cent as effective in reducing cone sensitivity as flashes of greater than 3-ms duration.

It is evident that recovery from flash blindness is not a simple mechanism. It may involve mechanisms of dark adaptation as this is measured conventionally, it may reflect neurophysiological effects, the influence of which is not usually seen in studies of dark adaptation, and it may reflect recovery from retinal

injury following exposure to very high adapting-flash energies. For a wide range of conditions it can be represented by a fairly simple empirical equation, however.

## REFERENCES

- Aulhorn, E. Das Verhalten der Netzhautempfindlichkeit im Nachbildbereich. XVIII Councilium Ophthalmol. (Belgium) 1958. 1605-1609.
- Barlow, H. B. & Sparrock, J. M. B. The role of afterimages in dark adaptation. Science, 1964, 144, 1309-1314.
- Brindley, G. S. The Bunsen-Roscoe law for the human eye at very short durations. J. Physiol., 1952, 118, 135-139.
- Brindley, G. S. The discrimination of afterimages. J. Physiol., 1959, 147, 194-203.
- Brown, J. L. The effect of different preadapting luminances on the resolution of visual detail during dark adaptation. J. opt. Soc. Amer., 1954, 44, 48-55.
- Brown, J. L. The use of the colored filter goggles for protection against flash blindness. USN Air Develpm. Cntr. Rep., 1959, No. MA 5917.
- Brown, J. L. Time required for detection of acuity targets following exposure to short adapting flashes. J. engrng Psych. in press.
- Brown, J. L., Graham, C. H., Leibowitz, H. W., & Ranken, H. B. Luminance thresholds for the resolution of visual detail during dark adaptation. J. opt. Soc. Amer., 1953, 43, 197-202.
- Brown, J. L., Phares, L., & Fletcher, D. E. Spectral energy thresholds for the resolution of acuity targets. J. opt. Soc. Amer., 1960, 50, 950-960.
- Brown, J. L., & Woodward, L. K. Rod-cone interaction in the dark adapted eye. Optica Acta, 1957, 4, 108-114.
- Campbell, F. W., & Rushton, W. A. H. Measurement of the scotopic pigment in the living human eye. J. Physiol., 1955, 130, 131-147.
- DeMott, D. W., & Davis, T. P. Irradiance thresholds for chorioretinal lesions. AMA Arch. Ophthalmol., 1959, 62, 653-656.
- Dowling, J. E., & Hubbard, R. Effects of brilliant flashes on light and dark adaptation. Nature, 1963, 199, 972-975.
- Fry, G. A., & Alpern, M. Effect of flashes of light on night visual acuity. Wright-Patterson AFB: WADC tech. Rep., November, 1951, No. 52-10. Part I.
- Hagins, W. A. Flash photolysis of rhodopsin in the retina. Nature, 1956, 177, 989-990.
- Hill, J. H., & Chisum, G. T. Flash blindness protection. Aerospace Med., 1962, 33, 958-964.
- Johannsen, D. E. The duration and intensity of the exposure light as factors in determining the course of subsequent dark adaptation. J. gen. Psychol., 1934, 10, 4-41.
- Metcalf, R. D., & Horn, R. E. Visual recovery time from high intensity flashes of light. Wright-Patterson AFB: WADC tech. Rep., 1958, No. 58-232.

- Miller, N. Visual recovery from brief exposures to very high luminance levels. Paper presented at Meeting, Opt. Soc. Amer., spring 1964.
- Mote, F. A., & Riopelle, A. J. The effect of varying the intensity and the duration of preexposure upon subsequent dark adaptation in the human eye. J. comp. & Physiol. Psychol., 1953, 45, 49-55.
- Rushton, W. A. H. Dark adaptation and the regeneration of rhodopsin. J. Physiol., 1961, 156, 166-178.
- Schouten, J. F., & Ornstein, L. S. Measurements on direct and indirect adaptation by means of binocular method. J. opt. Soc. Amer., 1939, 29, 168-182.
- Severin, S. L., Newton, N. L., & Culver, J. F. A new approach to the study of flash blindness. Arch. Ophthalmol., 1962, 67, 578-582.
- Severin, S. L., Alder, A. V., Newton, N. L., & Culver, J. F. Photostress and flash blindness in aerospace operations. Brooks AFB: USAF Sch. aerospace Med. tech. doc. Rep. 1963, No. SAM-TDR-63-67.
- Shlaer, S. The relation between visual acuity and illumination. J. gen. Physiol., 1937, 21, 165-188.
- Teichner, W. H. Recent studies of simple reaction time. Psychol. Bull., 1954, 51, 128.
- Wald, G., & Clark, A. B. Sensory adaptation and chemistry of the rods. J. gen. Physiol., 1937, 21, 93-105.
- Whiteside, T. C. D. The observation and luminance of a nuclear explosion. Air Ministry Flying Personnel Res. Comm. Rep. 1960, No. 1075.1.
- Whiteside, T. C. D., & Bazarnik, K. The dazzle effect of an atomic explosion at night. Air Ministry Flying Personnel Res. Comm. Rep., 1952, No. 787.
- Winsor, C. P., & Clark, A. B. Dark adaptation after varying degrees of light adaptation. Proc. nat. Acad. Sci., 1936, 22, 400-404.

## METHODS OF PREVENTING FLASH BLINDNESS

Frederick E. Barstow  
Edgerton, Germeshausen & Grier, Inc.  
Bedford, Massachusetts

Other papers presented in this Section of the Report have covered the historical and operational aspects of flash blindness, something of the nature of the atomic radiation which causes it, and some of the current laboratory studies on flash blindness. This paper is concerned with methods of eye protection. The first part considers the requirements which must be met by any protective device and some of the many methods that have been investigated. The remainder of the paper deals with a specific method—namely, the Photochromic Protective System.<sup>1</sup>

The specifications shown in Table 1 are nominal for the average eye protective device and represent a compromise between the requirements for various applications rather than an exact specification for any particular device. Some applications consider open transmission of major importance and demand a

TABLE 1. Nominal Specifications—Flash Blindness Protective Devices

Transmission	50%
Density (activated)	3.0
Closure time	less than 100 $\mu$ sec
Reopening time	2-10 sec
Recycle rate	2-10 sec
Life cycles	100
Optical quality	Excellent

1. Edgerton, Germeshausen & Grier, Inc. (EG&G) has developed the goggles and periscope shutters described under various government contracts.

value higher than 50 per cent. In others, density is considered of greater significance and open transmission can be compromised. A density of 3.0 will probably provide burn protection under all conditions, but it is not clear yet whether this density is always adequate to prevent flash blindness. The specified closure time of 100  $\mu$ sec shown in Table 1 is generally accepted as the desired maximum value, although there are many cases where this is not required. Reopening time depends on the application, but in the case of a pilot of a modern aircraft the device must clear in a few seconds. The recycle rate is even more arbitrary, but the range of 2 to 10 sec certainly covers most applications. The number of life cycles has been set at 100 since this number of operations would be more than adequate to cover any single mission. Finally, a high optical quality is essential if the user's vision is not to be impaired.

The search for effective protection methods has been very extensive. Table 2 is only a partial listing of the broad range of protection schemes. With the exception of only one or two, all these have been subjects of government-sponsored research.

Perhaps the blink response should not be considered as a passive method, but it is listed under that heading because no auxiliary equipment is required. The use of an eye patch over one eye needs no explanation. It should be noted that a fixed filter having a density of 2.0 gives only marginal protection; in addition, it is of little value at night. Pure mechanical systems are apt to be slow, while those depending on polarization are limited to transmissions of 15 to 30 per cent in the open state. On the other hand, chemical-molecular systems are likely to be fast-closing.

TABLE 2. Flash Blindness Protection Methods

Passive methods	Active methods (directly and indirectly actuated)		
	<u>Mechanical</u>	<u>Polarization</u>	<u>Chemical-molecular</u>
Blink response	ELF (explosive)	Stressed plate	Photochromic or
Eye patch	Electromechani-	Kerr Cell	phototropic
Fixed Filter	cal goggles	Pockle Cell	chemicals
	Curtain		Photochromic glass
	Destruction		Triple-State enzymes
	of mirror		F-centers
	surfaces		Fast plating
	Exploding wire		Vado materials

A brief explanation of some of the methods may be of help. In the ELF device, an explosive charge drives a carbon-black mixture between two optically transparent plates. Although very high densities are reached in 100 to 200  $\mu\text{sec}$ , the lens element must be replaced after each activation.

In the electromechanical goggle, a set of opaque lines or bands on one transparent plate is placed directly behind a similar set of bands on a second transparent plate. A small explosive charge then moves one plate so that the opaque lines on it cover up the spaces between bands on the other plate. The device develops a high density but is limited to less than 50 per cent open transmission. Activation time is several hundred microseconds at best.

Curtain systems have been investigated as a possibility for goggles and as a method of protecting the entire cockpit. Closing a curtain over the entire canopy is slow, but this method may be used in conjunction with a more rapidly activated goggle device. Methods of destroying mirror surfaces have also been developed, but an exploding wire goggle has never been developed, even though such a device has been used effectively as a camera capping shutter.

In the experimental stressed-plate shutter, a thick glass plate placed between two polarizing sheets is momentarily stressed or stretched by means of a stack of piezoelectric crystals so that the system temporarily becomes opaque. Open transmission and closed density depend on the choice of polarizers.

The Kerr Cell is more familiar. It is a cell in which nitrobenzene is placed between metal plates and the combination placed between light polarizers. When a high voltage (generally in the range of kilovolts) is impressed across the plates, the birefringence of the nitrobenzene in conjunction with the polarizers causes a drastic change in transmission. Though limited to a maximum open transmission of about 30 per cent, closure time can be less than 1  $\mu\text{sec}$ . The Pockle Cell is approximately the solid-state equivalent of the Kerr Cell.

The photochromic system is now described in more detail. First, it should be noted that it is an "indirectly actuated" system, requiring ultraviolet energy from flash-tubes. This is in contrast to a "directly actuated" system which would use energy from the nuclear explosion to actuate it. The active element in the photochromic system is an organic chemical, normally transparent in thin sections, but which becomes colored when exposed to ultraviolet light. The behavior of a typical dye is shown in Fig. 1. The straight line at 90 per cent to 95 per cent shows the

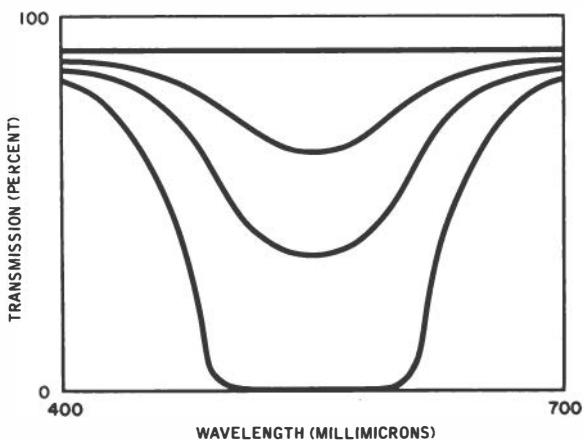

FIG. 1. Behavior of a typical photochromic dye.

transmission of the unactivated material. When exposed to increasing amounts of ultraviolet energy, an ever deepening absorption band develops in the visible spectrum. Although high densities are possible in this band, light leaks through at the blue and red ends. Consequently, fixed sideband filters are required to block out each end of the spectrum. In this way, high visual or luminous density can be obtained.

Fig. 2 is a schematic diagram which shows how the goggle works. The photochromic solution is confined in a layer only 0.010-in. thick between two optically ground and polished quartz wedges. Xenon flash-tubes positioned above and below the quartz wedge system provide the ultraviolet activating energy. Special

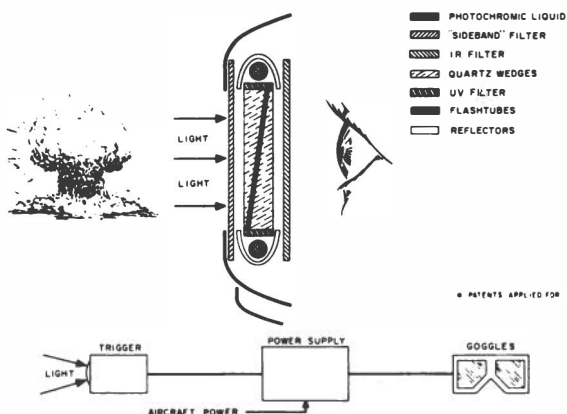

FIG. 2. Schematic diagram, photochromic goggle system.



filters protect the eye from visible light emitted by the flash-tubes but still transmit the ultraviolet energy to the photochromic material. The wedges distribute the ultraviolet light to the photochromic solution in a uniform manner so that the entire goggle area is colored to the same density.

Energy for the xenon flash-tubes is furnished by a high-efficiency power supply which is triggered by a light-sensitive detector circuit, which, in turn, reacts to the very earliest nuclear light. The size of the power supply is a function of the sensitivity of the photochromic material, the goggle area, and the closed density.

Fig. 3 shows a photograph of the most recent photochromic protective goggle system, including the power supply and detector-trigger elements. A relatively wide angle of view, good open transmission, fast closure, high closed density, and automatic clearing are achieved in this device.

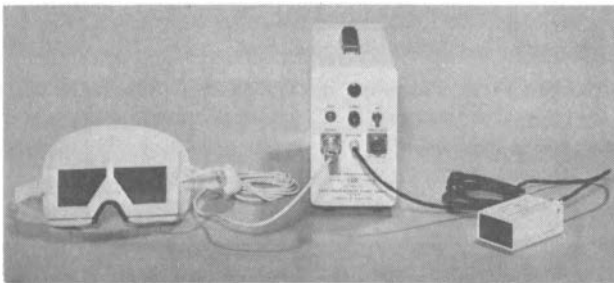

FIG. 3. EG&G photochromic goggle system.

Fig. 4 shows the first photochromic shutter designed for a periscope. The two circular apertures provide protection for both optical paths in the binocular instrument. In this case, the portable power supply is battery-operated.

Table 3 shows how the goggle and periscope (Fig. 3 & 4) compare with the nominal specifications listed earlier. The values for the goggle differ from those for the periscope since the requirements and limitations imposed on each are different. For example, a wide angle of view is imperative for the goggle, while the same is not required for the periscope shutter.

The present goggle with 35 per cent open transmission falls short of the specified 50 per cent but continued research is expected to yield the specified value. On the other hand, the periscope device already exceeds 50 per cent, and a new shutter is expected to reach nearly 70 per cent. The closed-density speci-

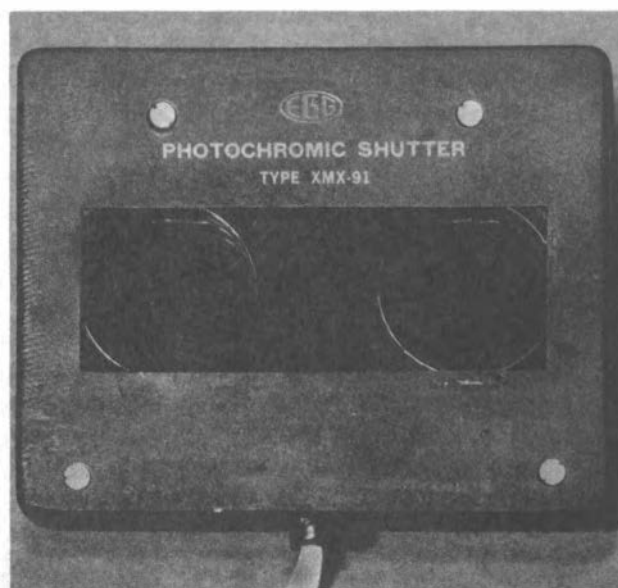

FIG. 4. First photochromic shutter designed for a periscope.

TABLE 3. EG&G Photochromic Devices (1964)

	Specifications	Goggle	Periscope
Open transmission	50%	35%	55%
Closed density	3.0	3.5	3.0
Closure time ( $\mu$ sec)	100	75	50
Reopening rate (sec)	2-10	2	5-10
Recycle rate (sec)	2-10	2	10
Life cycles	100	30-60	30-60
Optical quality		All excellent	

fication is equalled by the periscope device and exceeded by the goggles, while the closure time exceeds the specification in both cases. Reopening and recycling rates fall within the specified range; some adjustment is also possible through choice of photochromic chemicals and through power-supply design. The number of life cycles, however, or the number of times the device can be closed before resulting in some small degrading of the other characteristics, is less than desired. Although optical quality is relative, the system permits any degree of optical perfection

desired. Thus, it can be seen that the photochromic devices already meet most of the specified characteristics.

It is interesting to examine the actual closure of the photochromic shutter. The oscillographic traces in Fig. 5 were generated by passing the light from an electronic flash-tube through the periscope shutter onto a photocell. The top trace shows the flash-tube light falling on the photocell when the shutter was not activated. The lower trace is for the same identical conditions except that the very early light from the flash-tube was picked up by the detector, which, in turn, triggered the periscope shutter. Note that for the first 8 or 10  $\mu\text{sec}$  the traces are nearly the same, but by 20  $\mu\text{sec}$  the activated shutter blocks out more than 90 per cent of the light, and at 30 to 40  $\mu\text{sec}$  essentially all of the light is blocked out. The stated closure of 50  $\mu\text{sec}$  is, therefore, conservative.

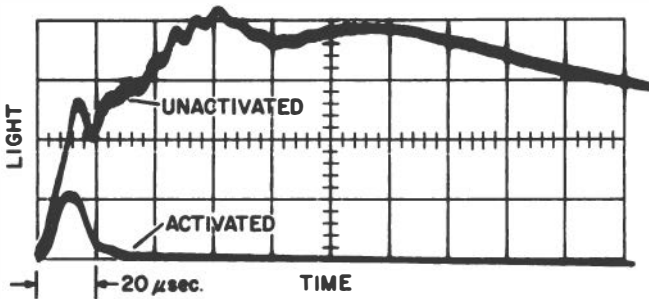

FLASHTUBE VIEWED THROUGH PERISCOPE SHUTTER

FIG. 5. Oscillographic traces: flash-tube viewed through periscope shutter.

At this point, it is interesting to give an example relating to closure time. Assume that a pilot flying at sonic velocity is wearing a pair of photochromic goggles and encounters an atomic detonation. His goggles would then close in less time than it would take his aircraft to move 1 inch.

This paper has stressed the positive aspects of the photochromic system. There are, however, still some problems to be solved. As is shown in Table 3, open transmission and life are less than desired. In addition, the photochromic materials are temperature sensitive in that the clearing or reopening time varies with temperature. Another problem is weight, particularly that of the energy storage power supply. However, continued research will undoubtedly lead to improvements in these and other areas.

## **AIR FORCE EFFORTS IN THE FIELD OF FLASH BLINDNESS**

**James F. Culver  
Ophthalmology Department  
USAF School of Aerospace Medicine, Brooks Air Force Base**

It is apparent that interruption of a pilot's vision at a critical time could prove disastrous. The problem, therefore, consists of repeatedly providing adequate vision for aircrew members up to the time of a nuclear flash, shielding their eyes from the flash, and then again providing adequate vision almost immediately. This is not a simple undertaking. The severity of the problem varies considerably, depending on the ambient illumination, i.e., during daylight the problem is minimal unless the observer happens to be looking directly at the detonation; however, night-time operation can offer an extreme hazard during certain flight operations. Flight testing has shown that pilots would prefer to have the protective device placed on the windshield or canopy rather than on the person to obviate interruption of instrument visibility during the closed state. The concept of a goggle-type protective device should not be completely discounted since there will be other operations associated with flying in which they could be most valuable.

The problem of flash blindness and that of chorioretinal burns cannot be entirely divorced. Both can occur from a thermonuclear detonation. One happens to be of a temporary nature and the other is permanent. It is felt that a short summary and reference list of Air Force activities in these areas would be of interest to the members of the Armed Forces-NRC Committee on Vision.

Ocular hazards were recognized from the beginning of the nuclear era, and protective goggles were provided for observers at the first nuclear device detonation at White Sands, New Mexico. Empirical data from subsequent weapons tests later indicated the extent of the problem of flash blindness and chorioretinal burns

(Byrnes, 1953). Researchers at the U.S. Air Force (USAF) School of Aerospace Medicine continued to pursue field investigations of the ocular effects of nuclear flashes until the moratorium on testing was declared in 1958. The occurrence of chorioretinal burns in rabbits was demonstrated at distances of over 300 nautical miles from a thermonuclear detonation (Glasstone, 1962). During this period, prototype protective devices were also tested by the USAF Aerospace Medical Research Laboratory (Gulley, Metcalf, Wilson & Hirsch, 1960).

During the more recent 1962 series of weapons tests, personnel from the USAF School of Aerospace Medicine tested retinal-burn prediction models. This was the most comprehensive experiment of its type to date, and provided extensive, well-documented quantitative data which will also be of great value in flash blindness research.

Parallel to the experiments carried out in the field of weapons tests, a laboratory program to establish the chorioretinal-burn threshold was continuing. Early projects were sponsored by the United States Air Force at the Medical College of Virginia and continued by the Defense Atomic Support Agency. The excellent work performed by Dr. Ham, Dr. Geeraets, and their group at the Medical College of Virginia is well known. Their early studies indicate that the macroscopic-burn threshold varied from 1 to 13 calories per square centimeter ( $\text{cal/cm}^2$ ), depending on the retinal image size, utilizing a constant input rate (Ham, Wiesinger, Schmidt, Williams, Ruffin, Shaffer, & Guerry, 1958). Subsequent work by this group indicated this threshold could be less than  $1 \text{ cal/cm}^2$  when the energy is delivered at a very high rate.

Research on the effect of high-intensity flashes on the eye at the New York Eye and Ear Infirmary has also been supported by the United States Air Force. Their findings confirmed those of the investigators at the Medical College of Virginia in the areas where the two studies overlapped (Jacobsen, Cooper, & Najac, 1962; Jacobsen, Najac, & Cooper, 1963). Studies were also conducted at The Ohio State University where an attempt was made to determine the effectiveness of various spectral bands in the production of chorioretinal burns (Bredemeyer, Wiegmann, Bredemeyer, & Blackwell, 1963).

It is apparent that there has been much effort expended in the past on the problem of chorioretinal burns; however, data obtained in these field tests and laboratory studies are of definite importance in establishing eye-protection criteria. Recently, the em-

phasis has again shifted primarily to the problem of flash blindness. Early field studies conducted in 1952 that were devoted to flash blindness have been supplemented by the initial experiments on the operational aspects of flash blindness conducted by the Air Force Aerospace Medical Research Laboratory (Metcalf & Ham, 1958). Personnel at the USAF School of Aerospace Medicine are presently conducting an in-house flash blindness program to define the operational aspects of this problem and outline a training program. Currently, a research project directed toward a better understanding of the basic mechanism of flash blindness is being sponsored at The Ohio State University (Miller & Fry, 1963).

Air Force efforts to provide urgently needed protection are outlined below.

In 1955, the Air Force Systems Command initiated a project to conduct the development of eye protection from nuclear flashes. As a first step, feasibility studies of the electro-optical shutter (Kerr Cell) and the electromechanical goggle (Burger & Filer, 1964; Wayne-George Corp., 1959) were conducted. The Kerr Cell approach was found not be feasible for Air Force needs, and development of the electromechanical goggle was pursued. During this same period, investigation of phototropic, or self-attenuating, filters was also being made. These were parallel developments at the USAF School of Aerospace Medicine and the Aerospace Medical Research Laboratory. The phototropic approach has resulted in at least three eye-protection systems, including the indirectly activated phototropic goggles (Barstow & Lilliott, 1961), the one-way directly activated phototropic goggle (Krekeler, 1963), and the Dynacell directly activated device (Harries, 1963). Only the one-way directly activated goggle has been field tested and deemed to be unacceptable (Parkhurst, 1963). Recent studies have proved the electromechanical goggle to be unacceptable for pilot use. A further study of an electrochemical-type shutter found it also not feasible. This was an investigation of the electroplating principle in a shutter system (Aitken, 1962).

During this same period, the development of a fixed-filter eye-protection system has been under way. This has taken the form of protective visors and goggles. Studies indicate that a 1 per cent transmittance filter (gold-plated goggle) can provide adequate vision for flying during daylight.

To coordinate research better and to prevent duplication of effort in this field, the Oculo-Thermal Section was established within the Ophthalmology Department at the USAF School of

Aerospace Medicine in 1963. It is presently engaged in developing design criteria for eye protection from nuclear flashes, and prototype eye-protective devices.

As previously stated, the nuclear-flash eye hazard represents a continuum ranging from temporary flash blindness to permanent retinal-burn effects. Flash blindness is receiving the primary effort. In the study of chorioretinal burns, two criteria for damage have been used. One of these is a visually detectable threshold burn. This macroscopic lesion, although a gross approach to the problem, may very likely represent minimal significant retinal damage. More recently, with the development of a mathematical model for retinal burns, temperature rise in the retina has been utilized as the criterion of retinal damage. Some definitive work has been done by Ham, at the Medical College of Virginia, and by Jacobson *et al.* at the New York Eye and Ear Infirmary, on the temperature rise in the retina. However, this factor remains for the most part rather elusive and in need of considerable investigation. At the present time, an attempt is being made to define the critical temperature rise by comparing laboratory burns with burns received at nuclear weapons tests. It is hoped that this approach will throw some light on the nature of the critical temperature rise. The problem, insofar as the retinal-burn hazard is concerned, consists of developing reliable indicators for threshold retinal burns, then relating this significant lesion to nuclear weapon output for the various situations.

In order to assess properly the flash blindness hazard, it is necessary to define the stimulus. As a result, an in-house project has been established to develop luminance values of the various detonation conditions. Weapons effects data from actual weapon tests are being utilized for this effort. A contract is presently being negotiated to develop a mathematical expression for flash blindness. This model will make use of the best available data on recovery times and weapon illuminances, and if successful, will permit computer programming for development of flash blindness safe separation distance charts. Concurrent with the development of flash blindness separation distance charts will be the development of design criteria for eye-protective devices.

In order to fulfill the second requirement of the section's mission, a number of nuclear flash eye-protective devices are being developed. Even though design criteria for eye-protective devices offering a high degree of confidence are not available, estimates can be made of the required protection. This is especially true

in the case of retinal burns. An improved filter visor transmitting 2 per cent in the range between 200 and 2,000 millimicrons has been developed. This visor should provide adequate retinal-burn and flash blindness protection during daylight hours. The 2 per cent transmittance allows normal visual response inside and outside the cockpit in daylight. This item is to be brought into the inventory in early 1965.

Other items under continuing development are:

1. Phototropic, or so-called self-attenuating, filters which darken on exposure to ultraviolet and shortwave-length visible radiation;
2. indirectly activated phototropic filters activated by flash-tubes;
3. dynacell phototropic filters which consist of highly sensitive phototropic fluids flowing through filter cells; and
4. electronic triggering systems for the indirectly activated filters.

It is hoped that this short summary and reference list will be of value. Unfortunately, due to regulations, classified reports cannot be referenced; however, they are available to eligible investigators.

## REFERENCES

- Aitken, J. F. Electrochemical light modulator. Wright-Patterson AFB: MRL tech. doc. Rep., 1962, No. 62-29. (Final Report, Philco Research Corp. Contract AF 33(616)-7828).
- Barstow, F. E., & Lilliott, C. Development of flash blindness protective goggles. Bedford Mass.: EG&G Inc. Rep. 1961, No. B-2288.
- Bredemeyer, H. G., Wiegmann, O. A., Bredemeyer, A., Blackwell, H. R. Radiation thresholds for chorioretinal burns. Wright-Patterson AFB: AMRL tech. doc. Rep., 1963, No. 63-71. (DDC AD 416652).
- Burger, W. R., & Filer, H. C. Electromechanical goggle. Wright-Patterson AFB: ASD tech. Rep. 1963, No. 63-451. (Final Report, The National Cash Register Co. Contract AF 33(600)-43570).
- Byrnes, V. A. Flash blindness. Report of Project 4.5, Operation SNAPPER. Brooks AFB (Tex.): Weapons Test Rep., 1953, No. WT-530.
- Glasstone, S. (Ed.). The effects of nuclear weapons. (Rev. ed.). Washington: US Atomic Energy Comm., 1962.
- Gulley, W. E., Metcalf, R. D., Wilson, M. R., & Hirsch, J. A. Evaluation of eye protection afforded by electromechanical shutter. Brooks AFB: Weapons Test Rep., 1960, No. WT-1429. (Report of Project 4.2., Operation PLUMBOB).
- Ham, W. T., Jr., Wiesinger, H., Schmidt, F. H., William, R. C., Ruffin, R. S., Shaffer, M. C., & Guerry, D., III. Flash burns in the rabbit retina. Amer. J. Ophthalm., 1958, 46, 700-723.



- Harries, R. W. The dynacell and focal plane concepts of phototropic ophthalmic nuclear flash protective device. Wright-Patterson AFB: ASD tech. Rep. 1963, No. 63-658. (DDC AD 424140L).
- Jacobson, J. H., Cooper, Blossom, & Najac, H. W. Effects of thermal energy on retinal function, Part I. Wright-Patterson AFB: AMRL tech. doc. Rep., 1962, No. 62-96. (DDC AD 290808).
- Jacobson, J. H., Najac, H. W., & Cooper, Blossom. Effects of thermal energy on retinal function, Part II. Wright-Patterson AFB: Final Rep., 1963. (Contract AF 33(616)-7685)(DDC-AD 434726).
- Krekeler, J. H. Development of an irreversible photo-thermosensitive ophthalmic nuclear flash protective device. Wright-Patterson AFB: ASD tech. Rep., 1963, No. 63-658. (DDC AD 424140L).
- Metcalf, R. D., & Horn, R. E. Visual recovery times from high intensity flashes of light. Wright-Patterson AFB: WADC tech. Rep., 1958, No. 58-232. (DDC-AD 205543).
- Miller, N. D., & Fry, G. A. Visual recovery from brief exposure to very high luminance levels. Ohio State University: Interim Report, 1963. (Contract AF 33(657)-9229), (DDC-AD 434729).
- Parkhurst, D. J. Operational test and evaluation of phototropic goggles. ENTAFB (Col.): ADC Rep., 1963, ADC/73AD/63-26, (DDC AD 428073).
- Wayne-George Corp. High-speed electromechanical goggle. Wright-Patterson AFB: WADC tech. Rep., 1959, No. 59-114. (DDC-AD-215828).

## **A FLASH BLINDNESS INDOCTRINATION AND TRAINING DEVICE**

**James F. Parker, Jr.**  
**BioTechnology, Inc.**

Relative to the flash blindness problem area, a flash blindness indoctrination and training device has been developed for the Office of Naval Research and the Bureau of Naval Weapons by BioTechnology, Inc. The purpose of this device is to demonstrate to pilots who might operate in nuclear combat zones what would happen to their vision, and consequently, to their mission capability if they unexpectedly encounter the light from a nuclear burst. It is anticipated that this device will serve two training functions.

1. **Indoctrination training.** The device can be used to demonstrate dramatically the effect of "startle" and temporary loss of vision on the performance of typical flight activities.

2. **Proficiency training.** The device can be used to demonstrate the protection afforded by various protective systems and procedures, and will allow practice in the use of these systems and procedures.

The basic elements of the flash blindness device are:

1. **Flasher unit.** The light source is a xenon gas discharge electronic flash-tube of the quartz helix type. This unit delivers approximately 400,000 lumen-seconds (sec) of visible energy in 2 milliseconds, which simulates the initial pulse of the weapon. Simultaneously with the initial flash, three 300-watt bulbs are illuminated and gradually extinguished over a 4-sec period. This simulates the dying out of the weapon fireball.

2. **Focusing hemisphere.** Light from the flash source is bounced off a silvered hemisphere of 4-ft radius and is directed toward the position of the pilot, who is seated at the front of the device.

3. Diffuser screen. The screen diffuses the light with approximately a 30 per cent loss in intensity so that it is more representative of that which might be experienced in a nuclear environment. This screen allows also for the projection of a color film which presents a view of typical terrain as seen by a pilot flying a low level, high speed mission.

4. Pilot's instrument panel. This panel provides tasks for the pilot which are representative of those performed by aviators. It can be used to demonstrate the performance decrement which occurs following exposure.

5. Operator's panel. The instructor uses this panel in controlling the over-all operation of the device and in monitoring pilot performance.

Fig. 1 shows the major components of the device, the photograph being taken at the moment of flash. The operator control panel, pilot's panel, and diffuser screen are shown in this figure.

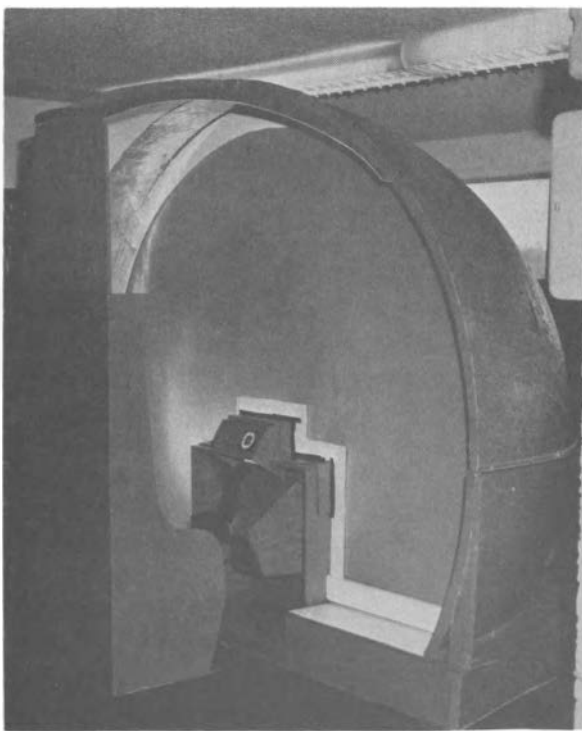

FIG. 1. Major components of flash-blindness device.

**Fig. 2** shows the reaction of a subject as he receives the initial pulse of light.

One of the most important uses of this device is to illustrate the dramatic decrease in visual recovery time which occurs when the illumination of the visual task is increased. A number of subjects have been tested in this device, under somewhat uncontrolled conditions, and their recovery times noted. Table 1 presents the range of recovery times for the two conditions of illumination of the visual task. The visual task in this instance consisted simply of reading three digits, which were white against a black background, as soon as possible following the flash.



**FIG. 2.** Subject photographed at moment of flash.

**TABLE 1.** Range of Visual Recovery Times for Two Conditions of Illumination of the Visual Task

	<u>Illumination</u>	
	0.5 foot-candles	30 foot-candles
Range of recovery times	20-90 sec	4-7 sec

**VISION PROBLEMS IN LOW-ALTITUDE,  
HIGH-SPEED FLIGHT**

**James W. Miller, Chairman**



## **VISION PROBLEMS IN LOW-ALTITUDE, HIGH-SPEED FLIGHT**

### **Introductory Remarks by the Chairman**

**James W. Miller**  
**Engineering Psychology Branch**  
**Office of Naval Research**

The papers presented in this Section describe current work related to the visual aspects of low-level, high-speed flight, and include such topics as geographic orientation, visual acquisition and tracking, tactical strike missions, and low-level problems associated with helicopters. The concept of flying at extremely low altitudes in order to penetrate enemy territory is by no means a new one. However, recent advances in radar defense systems and the accuracy of guided-missile systems have made it imperative that attacking aircraft avoid early detection, if at all possible, in order to insure survival. There are several types of missions which require flying at these extremely low altitudes. Such missions are usually concerned with visual reconnaissance, ground support, special-weapons delivery, or fire control.

The Low-Altitude High-Speed (LAHS) mission requires precise location and identification of ground points with precise heading, air-speed, and altitude. Such navigation is a combination of dead reckoning, and visual and radar navigation using ground features as an aid in the identification of targets and checkpoints. Terrain-avoidance radar and other airborne display systems are being developed in order to aid the pilot in such missions. Recent evidence indicates, however, that, in large numbers of flights, the pilot becomes so geographically disoriented that the goal is not achieved at all and the entire mission must be aborted.

It is hoped that these papers will clarify those problems which currently face pilots flying such missions.

## GEOGRAPHIC ORIENTATION DURING LOW-ALTITUDE FLIGHT<sup>1</sup>

James J. McGrath  
Human Factors Research, Incorporated  
Los Angeles, California

In low-altitude flight, the pilot is burdened with a large number of information and performance requirements. One of these requirements, that he maintain an awareness of his navigational position, has become known as "geographic orientation." (Geographic orientation should not be confused with the more familiar spatial orientation, which generally refers to the pilot's awareness of the attitude of his aircraft.)

Before undertaking any extensive research on geographic orientation, it was first necessary to determine the need for research in this area and the directions it should take. Therefore, in June, 1963, a "Phase 1" effort began. It was essentially a problem analysis effort, rather than a problem solving effort. The purposes of the research were: first, to determine whether pilots under operational conditions become lost frequently enough to constitute a significant cause of mission failure; secondly, to determine the role for research and to establish the priority of research problems within this area; and, finally, to evaluate possible experimental techniques to be used in solving the research problems. The inquiry was limited during this phase to those missions in which the pilot must fly at low altitudes under visual flight rules.

1. This research is being supported under Contract Nonr 4218(00) by the Joint Army-Navy Aircraft Instrument Research project, a cooperative effort of the Office of Naval Research, The Bureau of Naval Weapons, and the U.S. Army Material Command.



## THE OPERATIONAL PROBLEM

The first task of the project was to determine the magnitude of the problem of geographic disorientation in present-day aviation operations. The guiding principles in carrying out this task were: (a) the magnitude of the problem of geographic disorientation should be documented by objective data, rather than by personal opinion; (b) the data should come from several different sources, rather than from a single source; and (c) the data should be current to reflect conditions found in present-day aviation.

### Aircraft Accidents

An obvious indication of the magnitude of the problem would be the number of aircraft accidents attributable to geographic disorientation. Therefore, aircraft accident records were obtained from the Air Force, Navy, Army, and Civil Aeronautics Board and were examined to determine the role of geographic disorientation in aviation safety.

Fig. 1 shows the number of aircraft completely destroyed and the number of lives lost in major aircraft accidents attributable to geographic disorientation in military aviation during the years 1958 to 1962. The tabulation does not include accidents in which the aircraft sustained reparable damage, nor those in which the crew were only injured. Accidents in which geographic disorientation played only a minor or inconsequential role were also excluded.

In civilian aviation during the three-year period 1959-1961, a total of 243 accidents resulted from the pilot becoming lost under Visual Flying Rules (VFR) conditions. In these accidents 41 per-

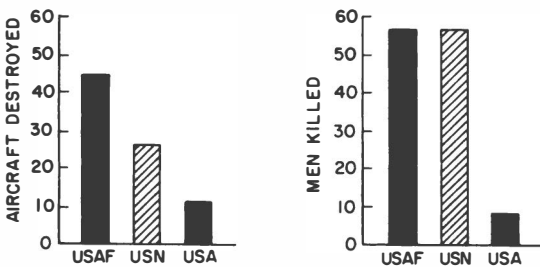

FIG. 1. Number of aircraft destroyed and men fatally injured in aircraft accidents attributable to geographic disorientation in military aviation, 1958-1962.

sons were killed. Many pilots became lost because they continued VFR into Instrument Flying Rules (IFR) weather conditions. During the same three-year period, 613 accidents resulted from this type of geographic disorientation, and 365 of these involved fatalities. Geographic disorientation was a contributing cause of 6.7 per cent of all general aviation accidents during the period studied.

Although aircraft accidents resulting from geographic disorientation have taken a heavy toll of aircraft and human lives, such aviation safety data do not accurately reflect the frequency with which pilots have become lost. The vast majority of pilots who become lost survive the experience, and accident statistics describe only a minor aspect of the problem.

### Personal Experiences of Military Aviators

Another source of data was the pilot himself. A total of 72 Navy, Marine Corps, and Army pilots was asked to describe their most serious personal experiences with geographic disorientation. All but four pilots described at least one instance of becoming lost in flight; the majority said they had had many such experiences. Forty-five of these descriptions of critical incidents were recorded in detail. One of the items of information recorded was the date on which the incident occurred.

Fig. 2 shows the distribution of critical incidents by calendar year, and Fig. 3 shows the distribution by month within the year 1963. Note that the most frequent category was 1963; and within that year, most of the incidents occurred during July—the month

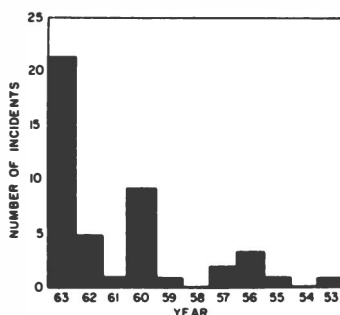

FIG. 2. Forty-five critical incidents of geographic disorientation reported by military aviators. distributed by calendar year.

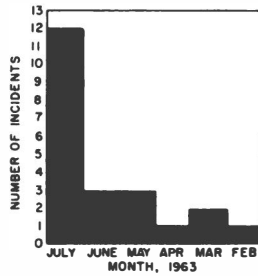

FIG. 3. Twenty-two critical incidents of geographic disorientation reported by military aviators, distributed by calendar month during 1963.

during which the interviews were conducted. One may draw either of two conclusions from the data: that an epidemic of geographic disorientation occurred in July, 1963, or that geographic disorientation is a relatively common occurrence among military aviators. When asked to relate his most serious personal experience of being lost, the pilot simply relates his most recent one—usually an experience which has occurred within the past few months.

#### Flight Assists to Lost Civilian Aviators

The large number of civilian aviators who become lost is indicated by the Flight Assist Reports issued by the Federal Aviation Agency (FAA). In 1962, a total of 1,492 assists was given by ground control operators to pilots flying the federal airways system. Of this number, 1,270 assists were given because the pilots were lost. In other words, of all the pilots who required assistance for all reasons, 88 per cent required assistance because they were geographically disoriented. This is a conservative number, according to FAA officials. They believe that assisting lost pilots to reorient themselves is such a commonplace event in air traffic control that a great many such incidents go unreported.

#### Geographic Disorientation on Low-Altitude Missions

To get closer to the heart of the military problem, attention was turned to the low-altitude attack training missions which are now being flown over the Sandblower courses. (Sandblower courses are those routes designated for low-level training and extend from the Northwest to the deserts.) These missions are assumed to be representative of operational combat missions flown by light attack aircraft. Mission critiques of almost one thousand Sand-

blower flights were analyzed. Based on the statements of the chase pilots, who evaluated the missions, Fig. 4 shows the incidence of geographic disorientation on these flights. Ten per cent of the missions failed completely because the pilot became lost. In another 17 per cent of the missions the pilot became lost, but eventually reoriented himself and found the target area. In these cases the mission was compromised in many ways, and under combat conditions might have failed. The remaining 73 per cent of the missions were categorized as "O.K." Many of these missions failed too, but not because of geographic disorientation.

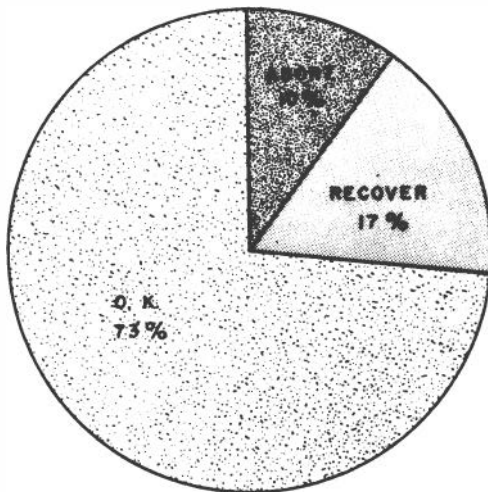

FIG. 4. Summary of data obtained from 959 flight critiques of low-level navigation training missions.

It is important to point out that the "abort" and "recover" percentages are minimum figures, in that many cases of disorientation went unreported, and any case that was doubtful, or that had insufficient information, was thrown into the "O.K." category.

#### Records of Individual Pilots

To clarify the data obtained from the flight critiques, a study of individual differences in low-altitude navigational performance was made. A "probability of disorientation" was computed for each pilot, based on the proportion of his flights on which he became geographically disoriented. The frequency distribution shown in Fig. 5 was plotted from the resulting data. The distribution includes 126 pilots, each of whom flew between six and

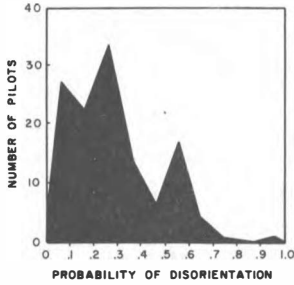

FIG. 5. Frequency distribution of disorientation incidents showing individual differences in geographic orientation performance.

eleven low-altitude navigational missions. Individual differences ranged from becoming lost on no mission to becoming lost on every mission. For the reasons mentioned earlier, these data are conservative estimates of the frequency of geographic disorientation on these missions.

The data can be interpreted more meaningfully in the form shown in Fig. 6, which is a cumulative distribution of the data shown in Fig. 5. The abscissa represents probability of disorientation based on the percentage of missions on which the pilot became lost. The ordinate represents the percentage of pilots who exceeded that probability. By drawing a line horizontally from the 50 per cent point on the ordinate to the cumulative distribution function, and, thence, vertically to the abscissa, for example, it can be seen that one-half of the pilots became geographically disoriented on at least 23 per cent of their missions. By intersecting the function at another point, as another example, it can be seen that 15 per cent of the pilots became disoriented on about one-half of their missions.

When individual differences in performance are of the magni-

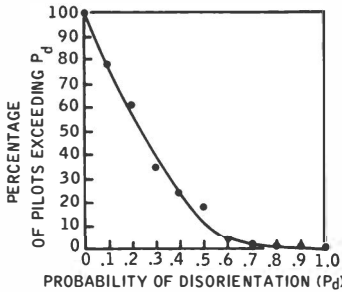

FIG. 6. Percentage of pilots exceeding a given probability of geographic disorientation ( $N = 126$ )

tude shown here, it is always valuable to know the reliability of such differences. To estimate the reliability of individual differences in geographic orientation performance the correlation was computed between the instances of disorientation that occurred on each pilot's even-numbered flights with those which occurred on his odd-numbered flights. The correlation coefficient was 0.56. This is a remarkably high reliability coefficient in view of the nature of the data from which it was derived.

### Conclusions

The results of the initial investigation showed that aircraft accidents caused by geographic disorientation take a significant toll of aircraft and human lives. But the reports of critical incidents by military pilots and the large number of flight assists to lost civilian pilots indicate that geographic disorientation is far more prevalent than indicated by accident data. If the training operations that are conducted on the Sandblower courses by light attack aircraft are at all representative of low-altitude combat missions, it can be expected that a substantial number of such missions will fail, or will be seriously compromised by geographic disorientation. Further, the problem is not confined to a small number of disorientation-prone pilots, but appears to be a general problem encountered by the majority of pilots. One is compelled to conclude that the answer to the original question was "yes": geographic disorientation does occur frequently enough in present-day aviation operations to affect significantly the success of those operations.

### THE ROLE FOR RESEARCH

It does not suffice to point out the existence of a problem and to suggest vaguely that something be done about it; therefore, the next task of the project was to delineate the role for human performance research in the study of geographic orientation.

#### Statistical Description of the Problem Situation

The first step was an attempt to provide a statistical description of actual incidents of geographic disorientation. The data were derived from accounts of critical incidents of geographic disorientation as related by 72 military pilots. Fig. 7 shows some of the functions that were obtained. Fig. 7(A) shows the frequency of disorientation as a function of the number of miles from the point of the take-off to the point at which the pilot realized he was

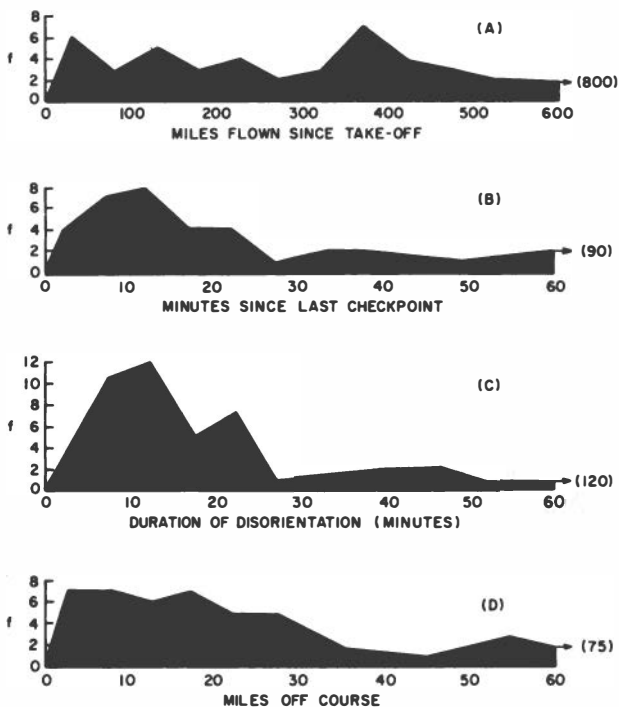

FIG. 7. Frequency (f) of geographic disorientation incidents as function of (A) miles flown since take-off; (B) minutes since last identified checkpoint; (C) duration of disorientation episode; and (D) miles off course during disorientation episode.

lost. Disorientation incidents occurred about equally often at all distances from less than 50 miles to more than six hundred miles from the point of origin. In other words, the occurrence of geographic disorientation was not systematically related to distance flown, and it appears that geographic disorientation can overtake the pilot at almost any stage of a flight.

Fig. 7(B) shows the frequency of disorientation as a function of the amount of time that had elapsed since the last identified checkpoint. Again, the range was very large. It is particularly interesting to note that a number of pilots became disoriented only a few minutes after they had fixed their positions with an identified checkpoint.

Fig. 7(C) shows that the durations of the disorientation experiences ranged from about 4 minutes (min) to more than an hour. The median duration was 12 min which, in an aircraft, is a dangerously long period of confusion.

Fig. 7(D) shows that during these episodes of geographic disorientation the pilots were anywhere from 4 or 5 miles to 75 miles from their intended track. The median distance the pilot got off course during these incidents was 20 miles, which is quite a large enough error to compromise most aircraft missions, although at least one incident is known in which the pilot was seven hundred miles off course.

The study also disclosed that in one-third of these cases the pilot experienced marked disbelief of some informational source during the disoriented state. That is, he became incredulous of his chart, his instruments, or his preflight planning. Most of the pilots experienced great difficulty in recognizing the fact of disorientation, and, having recognized it, experienced marked emotional stress.

It was also noted that the pilots used different methods of reorienting themselves. Of the pilots studied, 27 per cent first searched the chart for possible checkpoints and then attempted to locate these points in the visible field; another 43 per cent first selected terrain features that they could see and then attempted to locate these on the chart, while others (30 per cent) used a combination of these methods. In all cases the pilot attempted to relate some feature or combination of features in the visible terrain to features portrayed on his chart. The point of interest here is that the operational procedure recommended by Naval training doctrine is the chart-to-terrain method, the method used by the minority of pilots.

A statistical analysis was also made of the aircraft accident data. Although the circumstances surrounding the accidents were diverse, the accidents themselves were easily classified by type. Fig. 8 shows the different types of aircraft accidents that resulted from geographic disorientation in military aviation. More than half of these accidents occurred when the pilot believed himself to be in one position when, in fact, he was many miles away from that position. Unaware of this disorientation, the pilot subsequently collided with an elevated portion of the terrain. In the remainder of the cases, the pilot was well aware of the fact that he was lost, but was unable to reorient himself before fuel starvation occurred. Depending on the circumstances, he either abandoned the aircraft or attempted an emergency landing. In addition to the predominant behavior pattern of failing to recognize the fact of disorientation, there was another frequently observed pattern. In these cases, the pilots recognized they were lost, but were reluctant to admit this to anyone, and exhausted



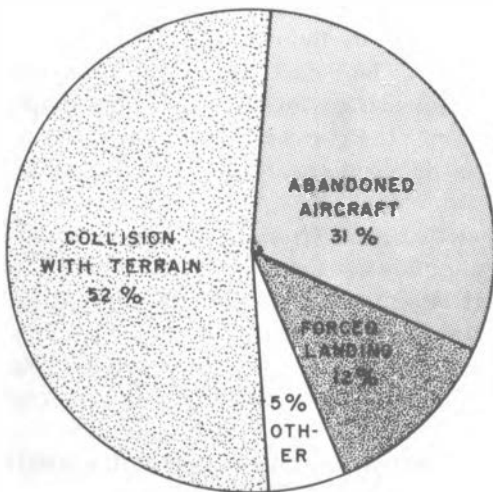

FIG. 8.

their fuel in an attempt to get out of what they considered to be an embarrassing situation.

In civilian aviation these patterns of pilot behavior also occur. But, by far the dominant pattern in civilian accidents caused by geographic disorientation is the inadequacy or complete lack of preflight planning.

#### The General Problem Areas

These statistical analyses provided useful background information on the problem of geographic disorientation, but the identification of research problems came from an exhaustive study of all available informational sources. Some of the sources have already been described: aircraft accident reports, critical incident reports, flight assist reports, and the critiques of low-altitude missions on the Sandblower courses. Those four sources of information provided data on actual cases of geographic disorientation. Two other sources of information were consulted, both dealing with pilot opinion. The two additional studies involved personal interviews conducted with 109 pilots who are presently flying low-altitude missions, and a questionnaire survey of 305 U.S. Army aviators. The large number of specific research requirements that were identified from the analysis of all available data has been reported in detail in a technical report (McGrath and Borden, 1963).

The following six general problem areas were identified in

the analysis, and their relative contributions to geographic disorientation are indicated by the different sources of information.

1. Visual reference: Included problems dealing with the selection, detection, and identification of visual checkpoints.

2. Dead-reckoning (D.R.) procedures: Included problems related to the control of the aircraft and the execution of a flight plan.

3. Charts: Included problems concerned with the selection and encoding of information in aeronautical charts, problems of interpreting chart information, and problems of displaying and handling the charts.

4. Weather conditions: Included problems dealing with the influence of visibility and wind conditions on geographic disorientation.

5. Preflight procedures: Included problems involved in pre-flight planning.

6. Instruments (Inst.): Included problems concerned with the display and interpretation of those flight instruments which the pilot uses in navigation.

### The Problem Hierarchy

To determine the problem hierarchy, and thus to establish the research priorities of the different problem areas, three independent studies were made of the relative contribution of the six factors to geographic disorientation.

In 135 cases of disorientation on the Sandblower missions, the chase pilot clearly stated what he considered to be the cause of disorientation. These cases were tabulated by problem area as shown in Fig. 9. The results suggested a hierarchical order of problem areas with visual reference problems being dominant.

The hierarchy of problem areas was verified in the second study, which was based on 108 reports of critical incidents of geographic disorientation as personally experienced by military pilots of fixed-wing and rotary-wing aircraft. None of the pilots in the second study was from the group represented by the Sandblower mission critiques, making this an independent sample. Further, these missions covered a wide range of circumstances as opposed to the relatively standardized missions of the Sandblower series. The causes of disorientation in 108 incidents were categorized in the same manner as the mission critiques. The results (Fig. 10) show a close agreement between the problem hierarchy as shown by critiques of standardized missions, and as shown by the personal experiences of pilots on a wide variety

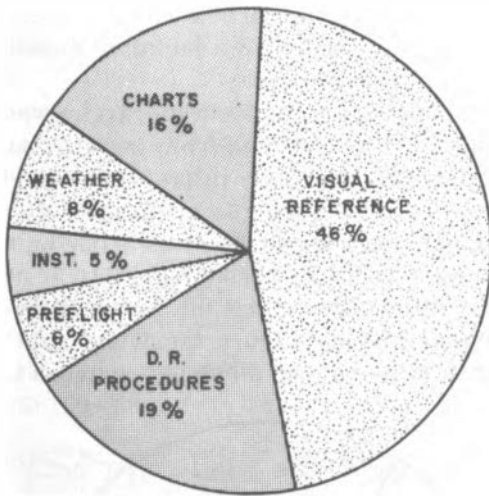

FIG. 9. Causes of 135 cases of geographic disorientation on Sandblower routes, classified by problem area.

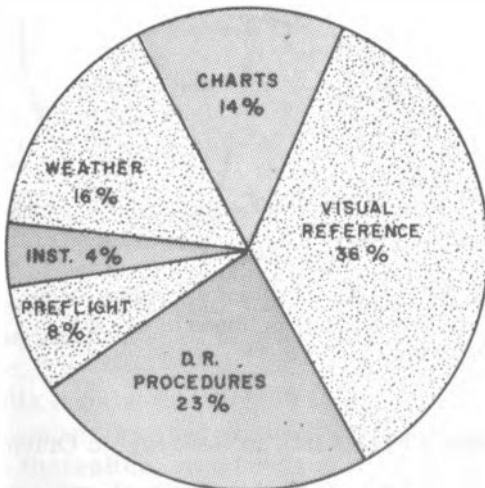

FIG. 10. Causes of 108 critical incidents of geographical disorientation in personal experiences of military pilots, classified by problem area.

of missions. About the only important difference is the greater incidence of weather conditions as a factor in disorientation as shown by the critical incident data.

A third assessment of the problem hierarchy was made possible by the response data obtained from the questionnaire survey. In one question the 305 Army pilots were asked to give their opinion of the factors contributing to geographic disorientation. The results (Fig. 11) show a problem hierarchy highly similar to that indicated by mission critiques and critical incident reports. The major difference is that the Army pilots regarded preflight planning as playing a more important role in geographic disorientation than either of the other two sources would indicate.

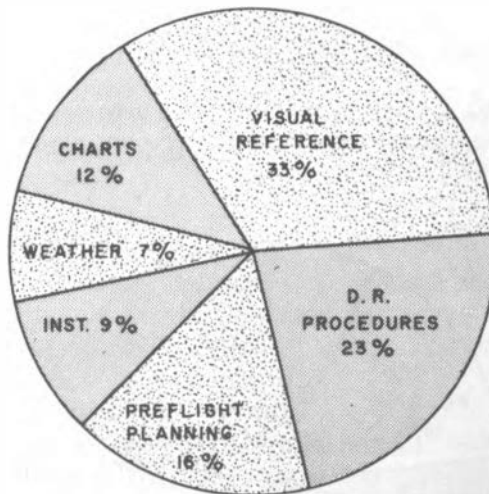
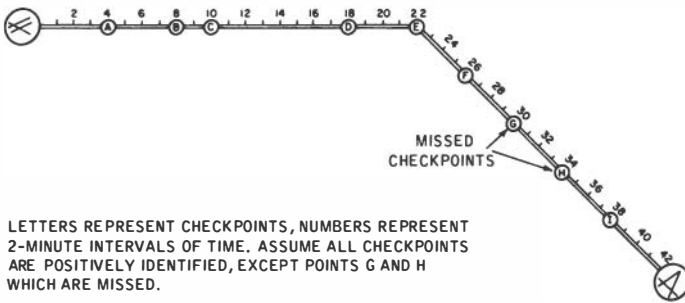

FIG. 11. Causes of geographic disorientation as indicated by opinions of 305 U.S. Army pilots.

### The Role of Visual Checkpoints in Geographic Orientation

Since all three sources indicated that visual-reference problems played a key role in geographic orientation, a study designed to clarify this role was conducted. Seventy-five pilots were shown a plan view of a hypothetical low-level VFR flight (Fig. 12). Letters indicated checkpoints, and numbers indicated time-ticks set at 2-min intervals. Checkpoint E was a turning point. The pilots were asked to assume that they had positively identified all checkpoints with the exception of G and H, which they had



LETTERS REPRESENT CHECKPOINTS, NUMBERS REPRESENT 2-MINUTE INTERVALS OF TIME. ASSUME ALL CHECKPOINTS ARE POSITIVELY IDENTIFIED, EXCEPT POINTS G AND H WHICH ARE MISSED.

FIG. 12.

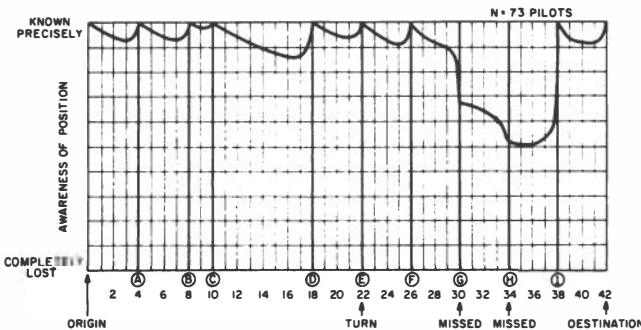

FIG. 13.

missed. Using a rating scale, the pilots then indicated for each time-tick what their level of awareness of position would be on such a hypothetical flight (Fig. 13). The scale referred not to the pilot's ability to calculate his position, if he had to; but, rather, to his awareness of his navigational position at each point in time.

The results showed that the pilots felt they would be precisely oriented only when they had positively identified a checkpoint. Immediately thereafter, awareness of navigational position would deteriorate until the pilot recovered his orientation by identifying the next checkpoint. As would be expected, when a checkpoint is missed, instead of recovering, there would be a sharp drop in position awareness, which would recover upon eventually identifying a checkpoint. It should be noted that the pilot does not consider himself to be lost between checkpoints, but rather his apprehension of his precise position becomes less and less certain.

The pilots were also asked to shade in those portions of the

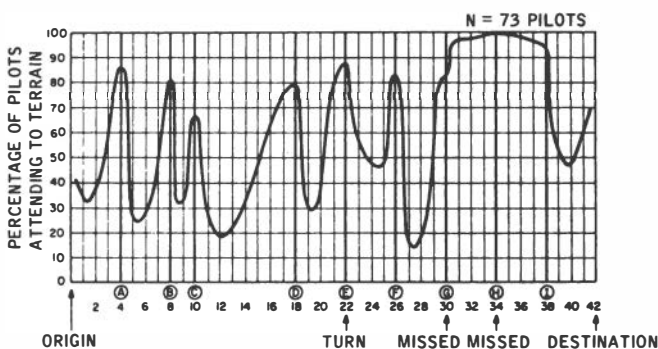

FIG. 14.

flight during which they would be most attentive to the external terrain. The results indicate that the pilot is most attentive to terrain features when a checkpoint is imminent (Fig. 14). If he successfully identifies the checkpoint, he immediately turns his attention to other matters. If he misses the checkpoint, he becomes very much occupied with searching the visual terrain until he does identify a checkpoint.

Taken as a whole, the results of the study support the earlier findings that checkpoint detection and identification play a key role in geographic orientation, and an understanding of geographic orientation could be advanced most rapidly by the study of conditions affecting the pilot's visual-reference behavior.

## THE RESEARCH PROGRAM

Thus far in the study, the magnitude of the problem of geographic disorientation in contemporary aviation had been established and the important problem areas identified. The next step was to evaluate experimental techniques which could be adapted to the study of these problems, and to formulate a systematic research plan.

As shown in the outline in Fig. 15, the program of research began with survey studies designed to structure the research task. These are, in fact, the studies reported herein. The next step is to conduct laboratory studies to test the hypotheses developed in the first phase. In evaluating various experimental techniques, it was found that there are two requirements of primary importance. One is the need for fidelity of visual cues—that is, the method should provide visual stimuli which are comparable to the visual conditions in the real-world situation. Secondly,

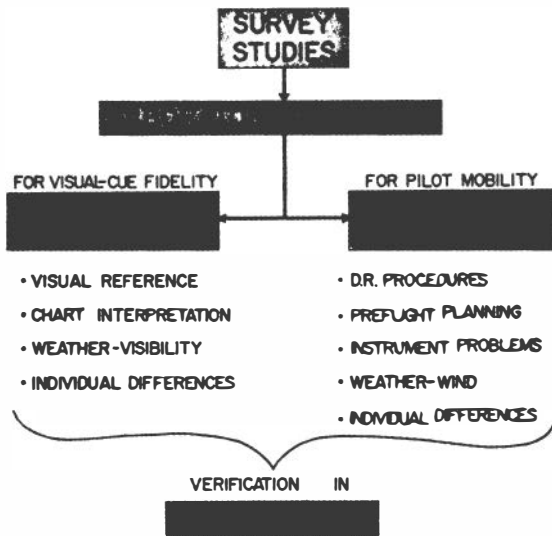

FIG. 15. Outline of research program.

the method should allow the pilot some form of mobility—that is, the pilot should be allowed to make navigational decisions and act on those decisions. No feasible simulation technique was found which will adequately satisfy both requirements. It is possible, however, to satisfy the requirements by using complementary methodologies.

For those research problems which demand fidelity of visual cues, a variety of motion-picture techniques can be used. In the technique now being implemented, wide-angle, color motion pictures are taken from a low-flying aircraft and back-projected onto a screen surrounding a simulated aircraft cockpit. Using a special Kinoptik lens, undistorted, high-resolution motion pictures can be taken of visual field  $85^{\circ}$  by  $67^{\circ}$ . It is also possible to obtain a  $256^{\circ}$  visual field by the use of three cameras (Figs. 16 and 17).

The main limitation in the motion-picture methods is that the pilot is a passive observer in the simulated aircraft. It is possible to give him various control tasks to perform, but these will not influence the visual field, although it is possible to provide some visual compatibility with pitch, yaw, and speed control. However, the technique has the advantage of being relatively inexpensive, and is well adapted to the study of visual-reference problems (variables affecting the detection and identification of checkpoints. Chart-interpretation problems are almost insepa-

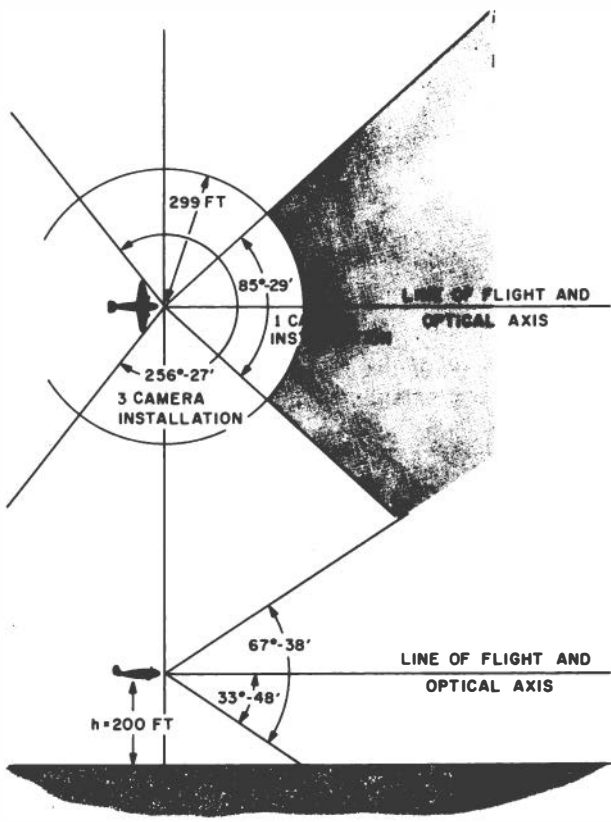

FIG. 16.

rably linked to the visual-reference problems and can be studied with this approach. Those weather conditions affecting visibility can be studied by this method, as well as the investigation of individual differences.

For those problems in which visual-cue fidelity is not absolutely essential, but where it is mandatory that the pilot be allowed command of the movement of the aircraft, terrain-model methods can be applied. There presently exist various facilities that can be adapted to research on geographic orientation. One of these is located at North American Aviation's flight simulation laboratory in Columbus, Ohio. The facility consists of a terrain model over which a television camera moves. The camera is servoed into the controls of a simulated cockpit, and the output of the camera is projected on a screen on front of the cockpit. This device allows pilot mobility, but the visual cues are too



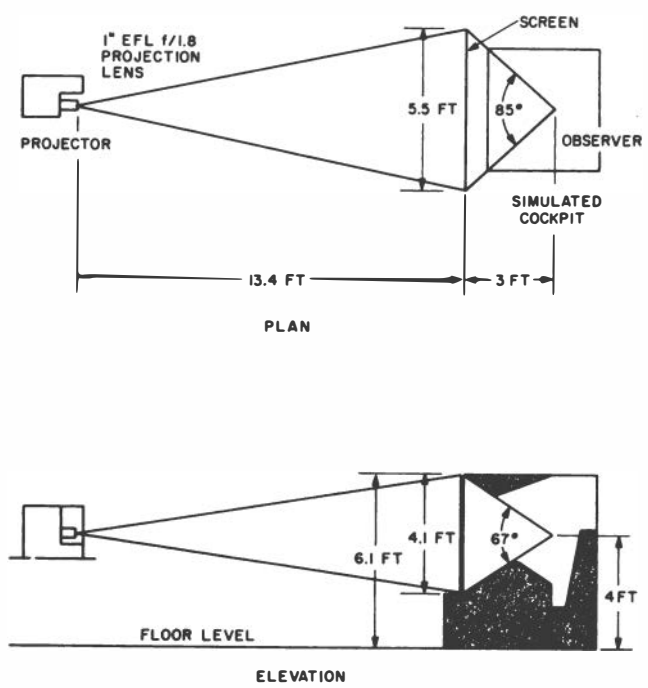

FIG. 17.

degraded for use on problems requiring visual-cue fidelity. However, many of the research problems in the area of dead-reckoning procedures, preflight planning, instrument error, and wind conditions could be studied using such devices.

The final step in the program must be the verification of the findings of laboratory studies through field studies. These studies would involve the use of real aircraft in the real world.

The program is now in its second phase, in which the motion-picture technique is being used. The effort involves four tasks: the production of the motion-picture materials, the instrumentation of the visual-flight simulator, the execution of a series of methodological studies designed to identify the most reliable performance measures and experimental procedures, and the execution of the first series of experimental studies of the visual aspect of low-level navigation.

### REFERENCE

McGrath, J. J. & Borden, G. J. Geographic orientation in aircraft pilots: a problem analysis. Los Angeles Human Factors Research, Inc. tech. Rep., 1963, No. 751-1.

## **DYNAMIC VISUAL DETECTION RECOGNITION**

**Charles P. Greening**  
Autonetics, North American Aviation, Inc.

### **IMPORTANCE OF VISION FROM LOW-ALTITUDE AIRCRAFT**

In spite of the development of new sensor devices and the improvement of old ones, the unaided eye remains an important source of outside-world information in aircraft systems. Its small size, light weight, low power requirements, high reliability, and convenient packaging are well known. Unfortunately, not as much is known as should be about its performance characteristics.

#### **Impact of New Requirements**

The defensive environment has forced aircraft to operate in the basically hostile regime of very low altitudes, and to do so in poor weather and/or at night, if possible. Flight operations at very low altitudes—200 (ft) and below—have increased the demands on the visual system by changing what used to be a quasi-static visual problem to one with complex dynamic properties.

The subsequent sections of this paper describe: (a) a schema for relating those dynamic properties to other aspects of visual research, (b) some of the dynamic properties of low-altitude vision, and (c) some of Autonetics' data on dynamic target detection and recognition performance.

### **RELATION BETWEEN STATIC AND DYNAMIC PROPERTIES OF VISION**

The problem of developing good experimental data incorporating dynamic and static variables typical of the real visual world can

perhaps best be looked at with the aid of a qualitative three-dimensional diagram (Fig. 1). The three axes represent visual complexity, dynamic complexity, and degree of experimental control. It is necessary, somehow, to approach the rear upper right corner of the diagram.

Number 1 on the diagram represents observations reported by airborne observers. The visual and dynamic properties of the real world are fully represented by definition. The introduction of experimental control into these observations, however, presents stubborn problems. Among them are: (a) the difficulty of flying an aircraft repeatedly over precisely the same path, (b) the seasonal and diurnal changes in character of the foliage and other features of the world, (c) rapid changes in illumination and in atmospheric transmission, and (d) the difficulty of introducing systematic changes in size, color, location, or orientation with such targets as factories and highway bridges. In spite of these difficulties, partially controlled flight test programs are going forward at Autonetics and elsewhere.

Some of the control problems described above can be eased by going to a high-fidelity terrain simulator. This simulation approach is represented by number 2 on the diagram. The visual character of the real world is almost entirely duplicated, if the job is carefully done. The dynamic properties of the real world can be correctly represented. Control of certain variables, such as illumination, vehicle position, and seasonal changes, can be achieved more readily than in flight testing. The systematic control of target and background properties such as masking, texture, and clutter, is still difficult, since there are no really appropriate descriptive metrics for them. Even very good simu-

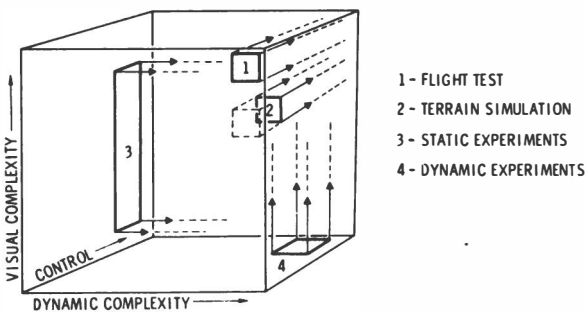

FIG. 1. Schema for dynamic low-altitude vision research.

lator data may differ from airborne data, e.g., recognition ranges, by a factor of two (Blackwell, Ohmart, & Harcum, 1959).

Number 3 on the diagram represents the careful, static experiment typical of much good vision research. Control is maximized, while visual complexity may vary over a wide range in these experiments from Landolt rings on a white background to highly textured representations of the real world. A few people have introduced some dynamic elements into this kind of work (Miller, 1958; Lippert, 1962; & Erickson, 1963), usually with relatively simple visual materials.

Number 4 represents an attempt, just getting under way in Autonetic's laboratory, to start with visually simple, controlled, dynamic material, and gradually to increase the visual complexity. There are no data to report from this work yet. The laboratory is designed to preserve all the dynamic properties of low-altitude flight, as is a high-fidelity terrain simulator. It is anticipated that the controlled addition of visual complexity will permit separation of the effects of parameters which, in nature or terrain simulation, are usually confounded.

## DYNAMIC PROPERTIES OF THE LOW-ALTITUDE VISUAL FIELD

### Single-Point Geometry

Unaccelerated flight past a point on the ground produces changes in the line-of-sight to that point, as shown in Fig. 2. The apparent angular position of a point on the ground changes relatively slowly when the range is large compared to the altitude. As the aircraft approaches the object, its apparent angular motion increases rapidly until it reaches the position of nearest approach and then it recedes in symmetrical fashion. Fig. 3 (Greening & Sweeney, 1962) shows curves of angular rate versus time.

### Extended-Object Geometry

When a collection of points comes under observation, the geometry becomes more complex. All the characteristics of the static search, detection, and recognition problem exist at any one instant, but the quality of the picture also changes significantly with time. Some of the changes are described below.

1. Angular subtense. The angular subtense of any extended target normal to the line-of-sight is  $a/R$ , where "a" is a linear dimension of the target, and "R" the range to the target. For a

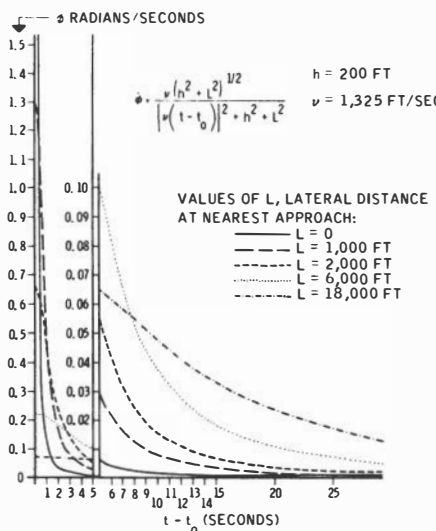

FIG. 2. Apparent angular motion of ground objects.

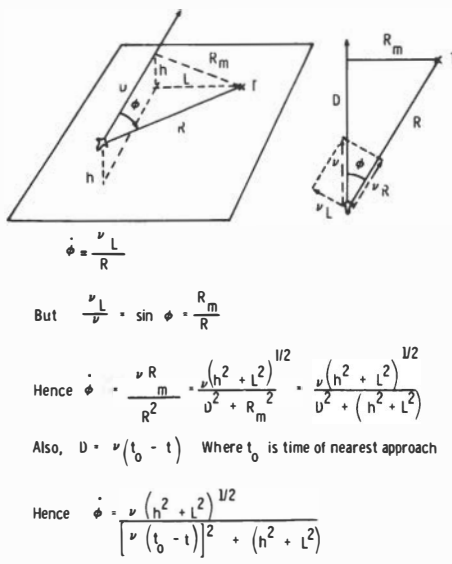

FIG. 3. Angular rate as function of time.

rectangular element with dimensions  $a \times b$ , the apparent area will be  $ab/R^2$  (Fig. 4). Thus, as the object is approached, its apparent linear dimensions increase as  $1/R$ , while its apparent area increases as  $1/R^2$ .

For a small horizontal surface, the lateral subtense is again approximated by  $a/R$ . But, the vertical subtense can be seen to involve the altitude,  $H$ . For small angles, the vertical subtense will be  $x/R = (H/R) = (b/R) = Hb/R^2$ . Thus, a linear feature along the flight path will lengthen apparently as  $1/R^2$ , while lateral linear features are growing as  $1/R$ . The apparent proportions of horizontal (or inclined) surfaces will thus be changing with time.

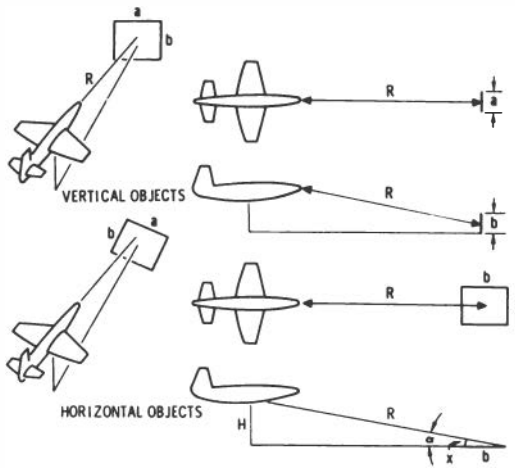

FIG. 4. Subtense of distant objects.

Following the same reasoning, the apparent solid angle subtended by a small horizontal surface will be approximated by  $(a/R) \times (Hb/R^2) = AH/R^3$ , where  $A = a \times b$ , the area of the horizontal surface.

In a target complex made up of a horizontal area with projections on it, e.g., buildings on flat ground, the total apparent angular subtense of the horizontal elements will be increasing faster,  $1/R^3$ , with decreasing range than the vertical elements,  $1/R^2$  (Fig. 5). Thus, at a distance, a village appears to be almost all buildings, fences, etc., while from close range (more oblique aspect) it seems to be mostly ground, roads, etc.

This relationship holds also for objects too small to be resolved individually, such as grass, pebbles, etc. The result is

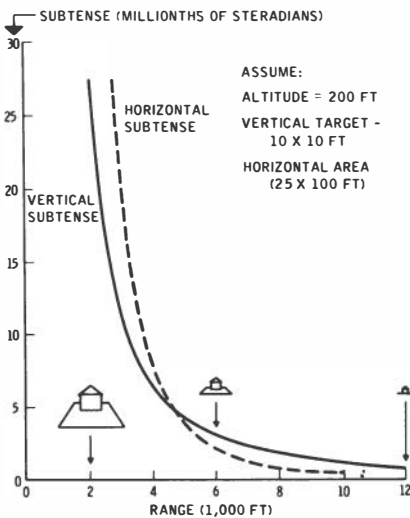

FIG. 5. Apparent size of horizontal and vertical surfaces.

an inevitable change in visual texture and, usually, in apparent brightness and color as well, independent of atmospheric effects or visible details.

2. Apparent relative position. The apparent relationships among separated points in the visual field also undergo continuous significant changes when viewed from a low-altitude vehicle. For objects viewed as a pattern, this means that the aspect of the pattern varies with time.

For more widely separated objects, some or all of which have significant vertical extent, observer motion at low altitude produces the effect of intermittent, partial, or total eclipsing of one object by another. Such masking effects seem certain to have an important effect on airborne recognition performance, but data and descriptive metrics are lacking.

All the geometric effects described above act in addition to, and probably interact with, the static visual variables such as contrast (brightness and color), shape, atmospheric attenuation, clutter in the visual field, etc. One brief analytical attempt has been made to combine these variables in a form usable for quasi-dynamic prediction. Using static data presented by Middleton (1952), Boynton (Boynton & Bush, 1958a; Boynton, Ellsworth, & Palmer, 1958b), the apparent contrast has been plotted as a function of range, meteorological conditions, and target size (Fig. 6).

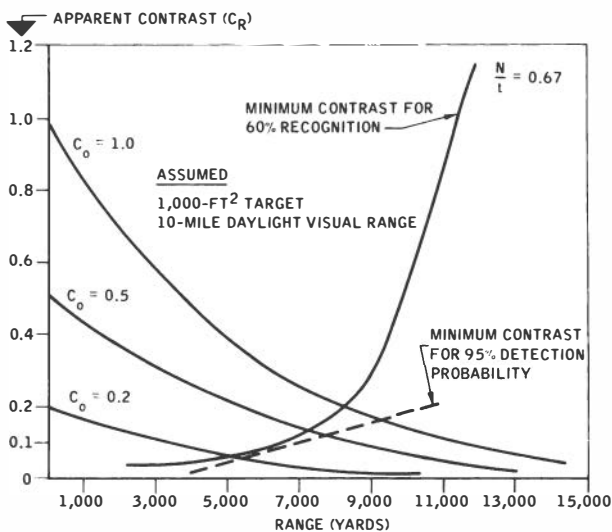

FIG. 6. Recognition range and apparent contrast.

If one now assumes a target of 1,000 ft<sup>2</sup>, with a contrast ( $C_o$ ) of 0.5, one can visualize riding the 0.5 curve in toward the left as a function of one's motion toward it. When this curve crosses the 60 per cent recognition curve, it ought to be recognized.

A family of these curves could be computed for different meteorological range, target size, and so on. But, it is probably not worth doing because the data would be obtained under conditions so different from low-altitude flight. Some of the airborne data has been checked against these curves without noticeable agreement. These data are presented after the flight test programs have been described.

## EXPERIMENTAL RESULTS

### Simulation

After an early analytical look at the low-altitude vision problem, one attempt at a motion-picture simulation was made, an outdoor parking area, natural lighting, and simple geometric objects (Snyder & Greening, 1963). In the experiment, target size and proportions, lateral offset at nearest approach, vegetative masking, and ground speed were systematically varied. In the three-dimensional diagram presented earlier, this study corresponds to full dynamic properties, relatively simple visual properties, and modest control of variables.



The recognition-range results are shown in Fig. 7. Assuming a scale of 1 to 100, the results indicate a range of approximately one mile for an object the size of a large truck. This experiment left a good deal to be desired in terms of experiment control. The difficulty of controlling conditions led directly to the design of the Dynamic Vision Laboratory, recently activated at Autonetics.

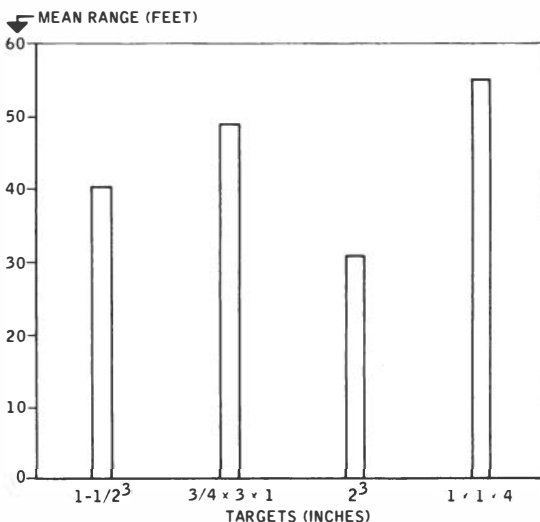

FIG. 7. Mean range of correct recognition (simulated).

### Flight Tests

The initial flight test of low-altitude visual performance was an attempt to introduce as much experimental control as possible into a real-world study. Four tactical targets using three different configurations were deployed on a specified target area 5.2 miles in length. The target area terrain was relatively flat Southern California desert, spottily covered with joshua trees, brush, and some grass. The target positions were all natural clearings in the target area.

The targets were a yellow jeep, a yellow truck, a two-man tent, and a simulated two-man gun position. They were chosen so that they could be readily moved between aircraft passes, and yet had some tactical significance.

A Beechcraft aircraft was equipped with a forward-looking 16-mm movie camera, a forward-looking television (TV) camera and monitor, and a 16-mm camera recording the TV. A total of

24 passes was made over the target area to permit counterbalancing target arrangements, direction of flight, location of ground track, and altitude. During each flight, an airborne visual observer and a TV observer searched for the four targets. Each was instructed to press a switch as soon as he recognized each target. In addition, the motion-picture films of the direct and televised forward view were used in the laboratory for additional data, with larger subject populations.

Major results of the study are shown in Fig. 8 and Fig. 9, and described more fully in Snyder, Greening, and Calhoun (1964).

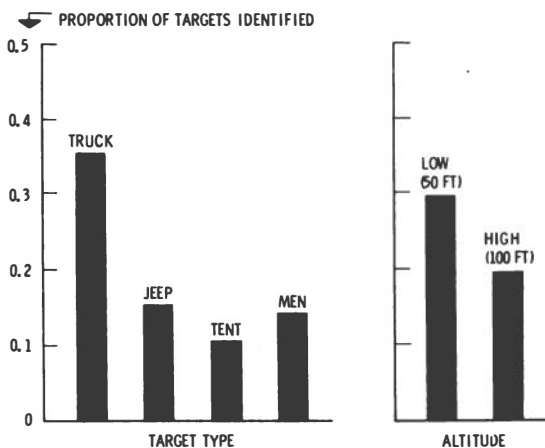

FIG. 8. Proportion of correct recognition, by altitude and by target.

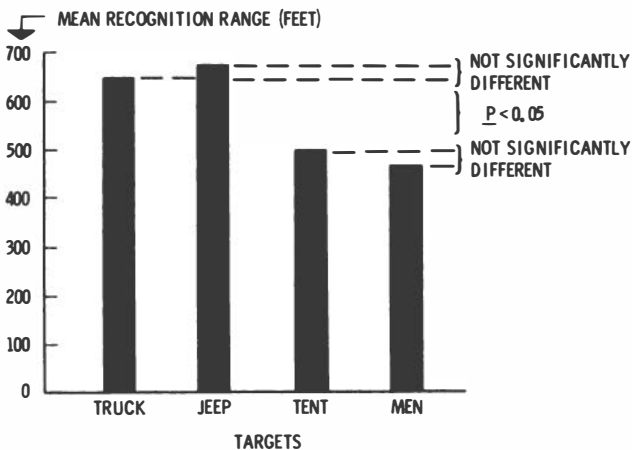

FIG. 9. Mean recognition range, by target.

In general, the results support other studies (Moler, 1962, Blackwell et al., 1959; Thomas & Caro, 1962) which have shown that the probability of correctly recognizing small tactical targets from low-altitude aircraft is undesirably low. Typically, these probabilities range from 35 per cent for tank-size targets to 5 per cent for small, troop-size targets. Furthermore, the median range at which such targets are correctly recognized in these and other studies is typically on the order of 2,000 ft.

The range data in the Autonetics study were all obtained from the film experiment. Problems in airborne data collection prevented comparison of these with direct visual recognition ranges.

A second, more elaborate flight test program is now in progress. This program is being conducted primarily as a multiple-sensor (visual, TV, radar, and infrared) comparison study. Only the visual data have been partly reduced, however, and they are the data of most interest to the reader.

The targets were 29 cultural objects ranging in size from a highway cloverleaf to the Santa Monica pier. Obviously, the control of target location was a luxury not possible in this series. Data were obtained, however, at three altitudes for all targets. Subjects were trained aerial observers, who were provided with briefing photos and map locations of each target. Because of the high cost of flight testing, the number of observations of each target under any condition is small. However, collapsed data provide meaningful results when recognition range is plotted against altitude (Fig. 10), or is computed for representative targets

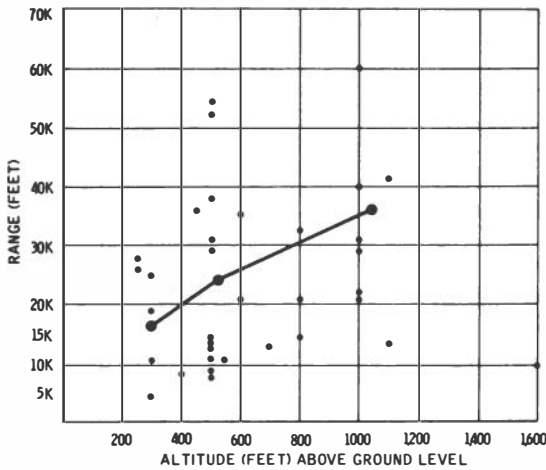

FIG. 10. Data points and mean recognition ranges.

TABLE 1. Mean Recognition Ranges for Selected Targets

Target	Range (ft)
Suspended pipeline	16,100
Highway cloverleaf	17,800
Freeway intersection (harbor and San Diego)	21,400
Oil tank farm (Long Beach)	27,600
Santa Monica Pier	36,600
Power station	42,800

(Table 1). Probabilities of target recognition were high under most conditions in this study. No target was more than a few hundred feet off the flight path, however.

The most effective way to get an idea of the visual world from this altitude regime is to view a section of the forward-looking film. The changing geometry can be clearly seen, and the targets should be readily detectable.

### CONCLUSION

This paper has described some of the struggles at Autonetics to answer the simple question "What can a man see out of a low-flying aircraft?" One potential danger in this field would seem to be sheer exhaustion from attempting to explore all main effects and significant interactions among the numerous visual and dynamic variables. Consequently, an attempt has been made, probably prematurely, to link the flight data just obtained with

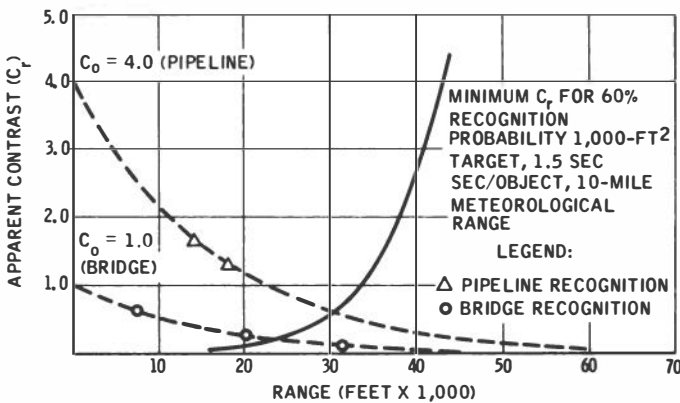

FIG 11. Selected flight test data points compared with static prediction.

previous static laboratory data. Selected experimental points have been plotted on the static curves described earlier (Fig. 11). The wide scattering of data points would seem to indicate that the researchers in Autonetics laboratory are still a considerable way from predicting dynamic visual performance with a simple model based on static data. It is hoped that pushing for better control in the flight work and for better dynamics in the laboratory, will bring the far corner of the cube closer in the future.

## REFERENCES

- Blackwell, H. R., Ohmart, J. G., & Harcum, E. R. Field and simulator studies of air-to-ground visibility distances. In Ailene Morris & E. P. Howe (Eds.), Visual search techniques. Pub. No. 712. Washington: Nat. Acad. Sci., 1960.
- Boynton, R. M., & Bush, W. R. Laboratory studies pertaining to visual reconnaissance. Wright-Patterson AFB: WADC tech. Rep. D1958, No. 55-304, (Part II). (a)
- Boynton, R. M., Elworth, C., & Palmer, R. M. Laboratory studies pertaining to visual reconnaissance. Wright-Patterson AFB: WADC tech. Rep., 1958, No. 55-304 (Part III). (b)
- Erickson, R. A. Visual search performance in a moving structured field. USN Ord. Test Station, 1963, No. IDP-1745.
- Greening, C. P., & Sweeney, J. S. Vision from low-flying aircraft. Autonetics Lab. Rep., 1962, No. EM 1162-103.
- Lippert, S. Dynamic vision—the legibility of equally spaced alphanumeric symbols. Douglas Aircraft Corp. Engng. Paper, 1962, No. 1481.
- Middleton, W. E. K. Vision through the atmosphere. Toronto: Univer. of Toronto Press, 1952.
- Miller, J. W. Study of visual acuity during the ocular pursuit of moving test objects: II. effects of direction of movement, relative movement, and illumination. J. opt. Soc. Amer., 1958, 48, 803-808.
- Moler, C. G. Helicopter armament program: air-to-ground detection and identification. USA Ordn. Tech. Memo., 1962, No. 1-62.
- Snyder, H. L. & Greening, C. P. Visual performance in simulated low-altitude flight. Autonetics Lab. Rep., 1963, No. EM 1163-123.
- Snyder, H. L., Greening, C. P., & Calhoun, R. L. An experimental comparison of TV and direct vision for low altitude target recognition. Lab. Rep., 1964, No. T-46/3111-4.
- Thomas, F. H., & Caro, P. W., Jr. Training research on low-altitude visual aerial observation: a description of five field experiments. Washington: HumRRO Res. Memo., 1962. unnumbered.

## OPERATIONAL PROBLEMS ASSOCIATED WITH LOW-ALTITUDE FLIGHT

Robert W. Bailey  
U.S. Army Aeromedical Research Unit  
Fort Rucker

In order to make any comments about the operational problems associated with low-altitude flight in Army aviation more meaningful it should first be explained what "nap-of-the-earth" can mean in terms of flight profile (Bell Helicopter Corp., n. d.). It should be remembered too, that in most cases Army aviators pilot, navigate, observe, and fire at targets with the aircraft armament, or direct the fire of supporting artillery. Such an operation is classified as a "complex-task."

Nap-of-the-earth, however, does not always mean this type of profile. Army tactical doctrine defines nap-of-the-earth flying as follows: "Nap-of-the-earth flying is employed as a protection against enemy observation and weapons. It is a flight conducted in close proximity to the earth; normally below the height of surrounding trees, in stream beds, valleys, or any fold of the earth that affords protection from enemy observation and fire." In fairly even terrain this doctrine usually requires flying along stream beds in low, close proximity to the earth profile. In more hilly and mountainous terrain, however, flying behind a hill mask at an altitude of 1,000 feet (ft) could still be considered nap-of-the-earth, as it is defined. The altitude that will provide the required protection from enemy observation and weapons is selected.

The problems involved have been identified by very little research and a great deal of subjective evaluation by aviators and those nonaviators who get a fearful amount of input as passengers.

In 1957, at the Armed Forces-NRC Vision Committee meeting at Tufts University (Wulfeck & Taylor, 1957) the U.S. Air Force representative presented the problem of navigation at low altitude

as one of their most serious problems. Low altitude was then considered 200 ft, now that altitude is considered rather high in other than hilly or mountainous terrain. Even at a 200-ft altitude, visual navigation requires an accuracy of a fractional part of a mile. This is severely limited by two factors—apparent speed, and effective line-of-sight distance. If one considers that the apparent speed of an aircraft is inversely proportional to its height above the surface of the earth, then 100 knots<sup>1</sup> at 20 ft is equivalent to 500 knots at 100 ft, and 2,500 knots at 500 ft. At these low altitudes it becomes apparent that the helicopter must be regarded as an extremely high-speed aircraft. The second factor is that of the effective line-of-sight distance and the effective surface area within this line-of-sight distance. Extrapolation of the reasonably effective visual range at this altitude was made from some data included in a Marine Corps study (Marine Corps School, 1961) which worked out to be about 0.188 nautical miles, or 1,142 ft. Any distant point that is fixated can, therefore, be expected to pass beneath the aircraft in about 7 sec after it enters the effective visual range.

This is the pilots view of the problem of navigation. Consider in addition to this that the aircraft instrumentation is not especially designed nor human-engineered to aid the pilot in flying this type of profile (Wright & Pauley, 1964). One striking example of this problem is the sexagesimal clock in Army aircraft. This is the aviators' speedometer and odometer, but it requires mental calculation to convert elapsed time in minutes and seconds to miles or kilometers per hour. If you have just flown 1.7 km in 42 sec, how long is it going to take to complete the leg of 8.3 km? What is your present ground speed? On a new helicopter this clock is on the floor console. For the readers particularly interested in these factors as they influence low-altitude navigation the following report is recommended: "Task Lowentry Survey Reports" by R. H. Wright and W. P. Pauley, U.S. Army Aviation Human Research Unit, Fort Rucker, Alabama.

The assumption that navigation is a real operational problem has been sustained by Dr. McGrath's paper presented in these Proceedings (McGrath, 1963). His data revealed that aviators who became geographically lost will eventually fly into the ground, or abandon their aircraft unless they are able to re-establish their geographical position. This disorientation is not systematically related to distance, however, so that the shorter radius

1. Knot = nautical mile (6,076. 1033 ft)/hr.

of operation in Army aviation (1-100 miles) is just as sensitive to this problem as are the longer missions of other services.

There are other problems associated with flying nap-of-the-earth.

1. There is a definite decrease in security and a resultant increase in stress on the pilot due to his relative air-ground position. In the fixed-wing aviator this may start to occur at altitudes as low as 300 ft and at air speed of only 70-80 knots. However, this altitude and air speed is comfortable to the rotary-wing aviator.

2. The complex task of flying low profiles is not the same for helicopters as it is for fixed-wing pilots. This is due to the lag between control input and response in the helicopter, which is considerably longer than in fixed-wing aircraft. Also, the helicopter is an inherently unstable platform that requires constant active control employing both hands and both feet.

3. At very low altitudes, e.g., 30 ft, on flat terrain the visual streaming effects have been reported to produce nausea in pilots flying at 250 knots.<sup>2</sup> The Army surveillance aircraft, OV-1, is capable of flying at this speed, and new experimental helicopters are rapidly approaching the 200-knot/hr capability.

There are two studies that have been done by the Defense Research Medical Laboratories of Canada (Lewis, 1961-1962), during extended low-altitude flight, which are pertinent to the human engineering deficit and the problem of navigation. In these studies, Canadian Army pilots were required to navigate accurately over unfamiliar terrain during flights flown nap-of-the-earth and lasting approximately two hours. Data were obtained about navigation capability, "head-down" time in the cockpit, number of times the pilots flew into wires or cables, and pilot errors such as forgetting to switch fuel tanks because they were so engrossed with the overloaded situation of navigation combined with low-altitude flying. In low-altitude flight such an error could be a fatal omission, but was avoided in these cases only because the experimenter was a passenger and either turned the switch for the pilots, or reminded them at the last possible moment. The same delayed interference was employed to prevent the pilots from flying into wires.

Mr. Lewis, author of these studies, has made available a documentary film taken during one of these experiments in an

2. R. Wright, USA Aviation Hum. Res. Unit, Ft. Rucker. Personal communication, October, 1963.



L-19 fixed-wing aircraft, a standard light observation aircraft used by both Canada and the United States. The film shows that a "jury-rigged" map roller was required to overcome the human engineering lack in this aircraft. To the stress of low-altitude flight was added the burden of navigation. Fixation times on the roller map had a mode of 1.5 sec or less. Aircraft altitude was below 75 ft 90 per cent of the time. The turbulence often present on summer days at low levels can be noted. Observers or passengers seldom endure more than 20 minutes of such turbulence without nausea.

The major sensory input for such a complex task of flying is certainly vision. It is hoped that this brief and far from complete presentation about some of the operational problems in low-altitude flight has served to stimulate interest and provide insight into the problem.

## REFERENCES

- Bell Helicopter Corp. The Army and the H-13 Sioux on the warpath.  
(Film) Author, w.d.
- Lewis, R. E. F. Pilot performance during low speed, low level navigation. Toronto: Defense Res. Bd of Canada DRML Rep., 1961, No. 248-1.
- Lewis, R. E. F. Pilot performance during low speed, low level navigation. Toronto: Defense Res. Bd of Canada DRML Rep., 1962, No. 248-2.
- McGrath, J. J. A study of geographic orientation in aircraft pilots. Los Angeles: Hum. Factors Res. Inc. tech. Rep., 1963, No. 751-1.
- Marine Corps School. Marine Corps landing force development activities. Quantico: Develpm. Bull., 1961, No. 2-61.
- Wright, R. H., & Pauley, W. P. Lowentry 1 Survey Report. Fort Rucker: U.S.A. Aviation Hum. Res. Unit, 1964 unnumbered.
- Wulfeck, J. W., & Taylor, J. H. (Eds.) Form discrimination as related to military problems. Washington: Nat. Acad. Sci., 1957, Pub. No. 561.

## **SOME OPERATIONAL ASPECTS OF VISUAL PROBLEMS IN LOW-FLYING, HIGH-SPEED AIRCRAFT<sup>1</sup>**

**Robert L. Jones<sup>2</sup> and James S. Joska**  
**Air Proving Ground Center**  
**Eglin Air Force Base**

Penetration of enemy defenses and capability of survival in the face of current sophisticated defense systems have generated a need for low-altitude flight. Missions into enemy territory vary, however, and to understand the various aspects of visual problems associated with low-altitude flight, it is necessary to delineate the types of missions involved in order to present specific problems. Low-altitude profiles for nuclear and non-nuclear warfare vary as do the low-altitude profiles for close-support and interdiction missions. Each has its own peculiar set of problems. This paper considers the inherent problems contained in the close-support and interdiction type missions, noting that other areas remain, including those of air superiority, armed reconnaissance, and, of course, nuclear deliveries.

Low-altitude flight is generally considered to involve flight

1. This paper is based on Projects 9069Z, 5967Z2, and 0501T1 conducted at the Air Proving Ground Center, Air Force Systems Command. The results of the first of these projects were documented in PGN Document 64-1, "Human Factors Aspects of Low-Altitude Flight: A Sample of Fighter Pilot Attitudes and Altitude Estimates," dated February 1964, prepared by Robert L. Jones of the Deputy for Effectiveness Test in collaboration with Jefferson F. Lindsey of the former Deputy for Bioastronautics, APGC. The findings of the second project were reported in PGT Document 63-1, "Effect of Aircraft Speed on Low-Altitude Acquisition of Ground Targets," dated December 1963, prepared by Major James S. Joska of the Deputy for Effectiveness Test, APGC. The results of the last project, which was a follow-on of Project 5967Z2, will be published by APGC in May 1964.

2. Now with Crew Systems Division, Manned Spacecraft Center, NASA, Houston, Texas.

at an altitude of 500 ft or less. High-speed flight at these altitudes produces numerous problems. The pilot is confronted with the increased probability of disorientation, difficulty in recognition of significant checkpoints on a critical flight path, and, of course, the constant avoidance of collision with the terrain. It can be seen, then, that flying at low altitudes involves more than just navigation.

The Deputy for Effectiveness Test, Air Proving Ground Center (Air Force Systems Command), in conjunction with the Tactical Air Warfare Center (Tactical Air Command), both located at Eglin Air Force Base, is currently focusing attention on problems encountered in close-support and interdiction missions. Each of these missions, as they are considered here, involves problems in low-altitude flight, namely, navigation to the target area, search for the target, target acquisition,<sup>3</sup> target recognition, tactical maneuvering, weapons delivery, and escape (see Fig. 1).

The distances at which acquisition and recognition occur must be considered for herein lies the limitation for employment of

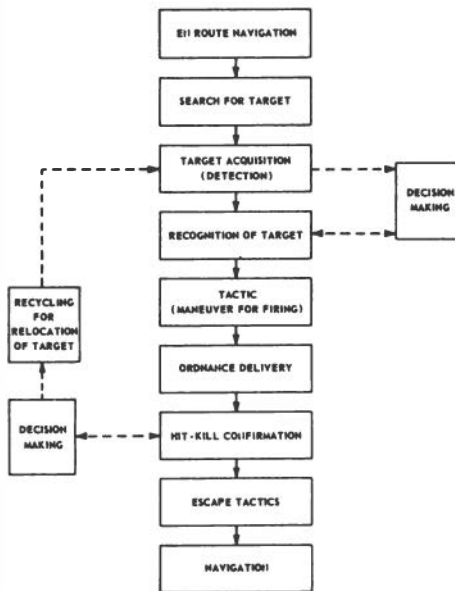

FIG. 1. Phases of target acquisition, recognition, and destruction.

3. In this paper, target acquisition is considered as that point at which detection of the target occurs.

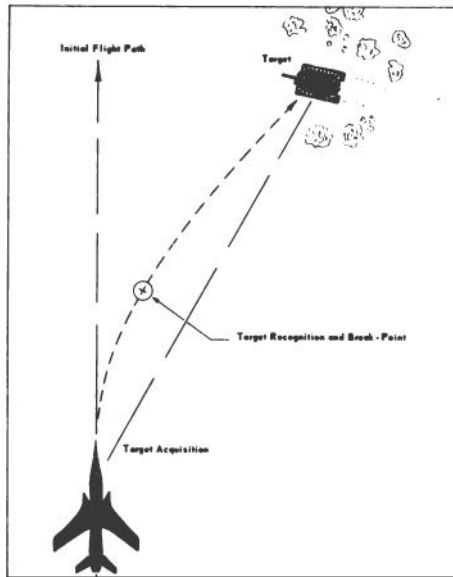

FIG. 2. Critical target acquisition and recognition distances and critical angle-off for executing tactical maneuver for ordnance delivery.

available weapons through tactical maneuvering (Fig. 2). For example, rocketry and strafing are severely limited from a high-performance aircraft flying at extremely low altitudes. Other types of munitions must be employed, dependent, obviously, on the type of target under attack. If, in approaching the target location, the pilot is several degrees to one side of his target he must maneuver his aircraft, in accordance with an accepted tactic, to line up on the target in order to deliver his weapon. Such a maneuver is time-consuming and can involved severe physical stresses on both the pilot and the aircraft during flight. Also, psychological stress for the pilot might very well be increased as a function of prolonged exposure to enemy defensive ground fire during this maneuver.

In a situation emphasizing the use of a high-performance aircraft in the missions under consideration where ground-to-air defensive weapon systems make the capacity to survive a critical factor, there arises a problem of a compromise of survival in order to achieve effectiveness. The Deputy for Effectiveness Test has begun an investigation of factors involved in achieving a "first-pass acquisition, recognition, and fire" situation, where

the pilot might acquire, recognize, and destroy a target on a single pass. Information was needed to determine the probability of achieving this event, for attaining such proficiency appears to be significant, especially in light of the sophisticated defense systems anticipated. Recently, interviews with 15 Tactical Air Command (TAC) fighter pilots completing live-fire training passes on targets which were well hidden among trees revealed that first-pass acquisition, recognition, and fire was reported as occurring only approximately one-third of the time. Further, the flight leaders reported achieving this event significantly more often than the Number 2, 3, or 4 pilots in the flight. Perhaps this was due to the superior skill and more extensive experience of the flight leaders. There is also the factor that the flight leader can devote his full attention to the acquisition-recognition-firing task, while the remaining men in the flight have to be concerned with flight integrity, i.e., position, spacing, etc. The first-pass acquisition, recognition, and fire capability seems to be desirable, but elusive.

Data on low-altitude flight directly pertinent to tactical operations gathered from field tests in which high-performance aircraft and qualified line fighter pilots were utilized are extremely rare. Regulations of the Federal Aviation Agency (FAA) severely restrict flying at an altitude of 500 ft or lower, except for certain approved routes laid out for special training missions. Since pilots are unable to acquire extensive high-speed, low-altitude flight experience, and will certainly not admit to "buzzing" episodes, data are unavailable.

Considerable differences of opinion concerning pilot capability to perform low-altitude flight are seen to exist, further complicating the lack of objective data in the area. To obtain some insight into "how low is low," and how low pilots feel they can fly, a sample of 58 highly qualified U.S. Air Force TAC fighter pilots were asked to estimate the lowest altitude they felt they could comfortably maintain for certain specified conditions. The relationships among speed, flight duration, flight conditions (favorable versus unfavorable), and altitude estimates, as well as interactions among these factors, were investigated.

In preparing the altitude estimate data for analysis, two separate classes of data were established: (a) data on estimates made for reciprocating-engine aircraft, and (b) data on estimates made for jet aircraft. These were then broken down further into data based on time, which made possible an analysis of variance for estimates pertaining to flight duration—10 min, 1 hr, and 1 to 2

hr. To evaluate the human-factors aspects of the estimates, the pilots were grouped according to anxiety level, total flying hours, and total jet time. Anxiety levels, using scores based on the Institute for Personality Testing (IPAT) Anxiety scale were: Low, 5-14; Medium, 18-23; High, 23-37. Total flying hours were: Group 1, 0-999 hr; Group 2, 1,000-1,999 hr; Group 3, 2,000-2,999 hr; and Group 4, 3,000 hr or more. Total jet time was: Group 1, 0-1,000 hr; Group 2, 1,001-2,000 hr; and Group 3, 2,000 hr or

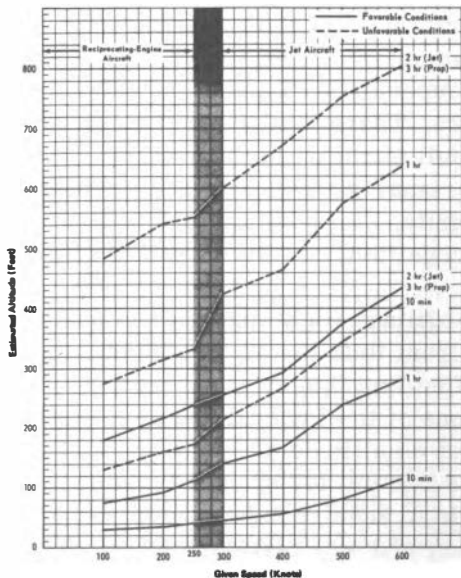

FIG. 3. Means for altitude estimates for reciprocating-engine and jet aircraft: total pilot group (N = 58).

more. The means for the altitude estimates for both reciprocating-engine and jet aircraft for the total subject group are shown in Fig. 3. The means for the estimates made by the pilots in each of the human-factors groupings for each type aircraft and for the three flight duration periods are shown in Fig. 4 through Fig. 12.

The relationships between anxiety level and the estimates made by the pilots are extremely interesting, since subjects of high anxiety made significantly higher altitude estimates, with unfavorable conditions and longer flight durations interacting with anxiety level. Since pilots reported that low-altitude flight tends to be stressful (Jones & Lindsey, 1964), and since stress

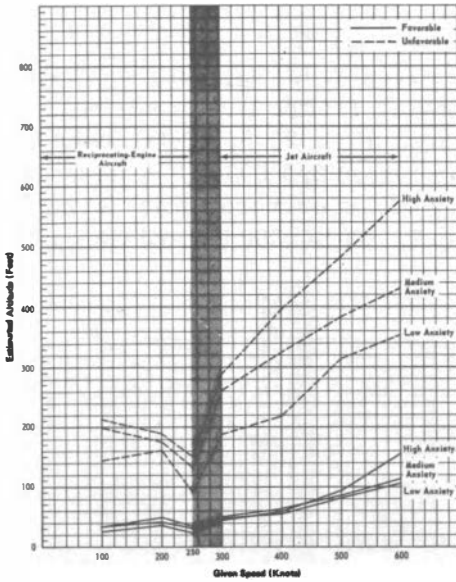

FIG. 4. Means for altitude estimates for reciprocating-engine and jet aircraft: 10-min flight duration period—anxiety grouping.

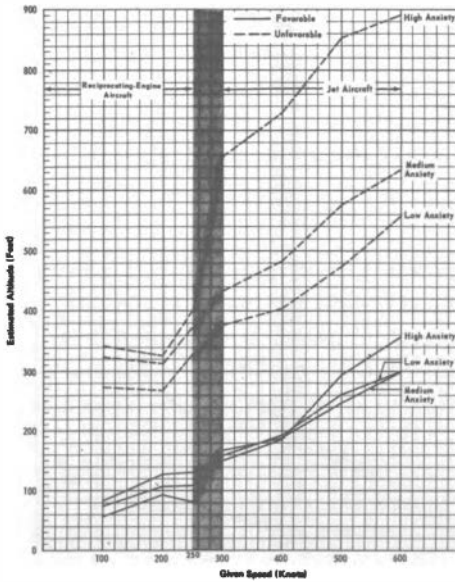

FIG. 5. Means for altitude estimates for reciprocating-engine and jet aircraft: 1-hr flight duration period—anxiety grouping.

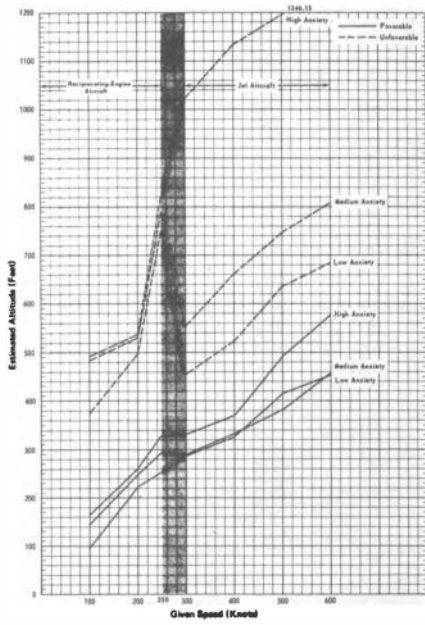

FIG. 6. Means for altitude estimates for reciprocating-engine and jet aircraft: 2- to 3-hr flight duration period-anxiety grouping.

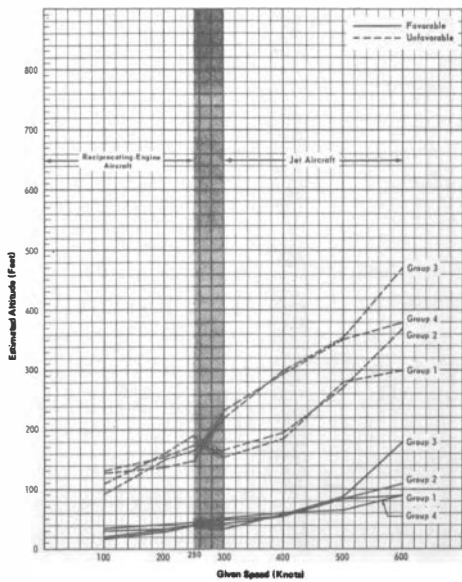

FIG. 7. Means for altitude estimates for reciprocating-engine and jet aircraft: 10-min flight duration period-total flying hours grouping.



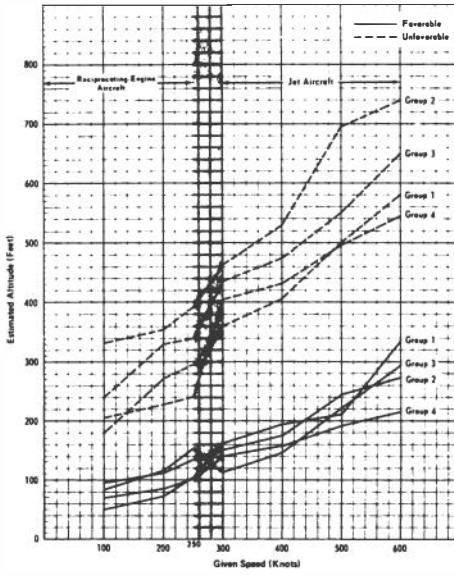

FIG. 8. Means for altitude estimates for reciprocating-engine and jet aircraft: 1-hr flight duration period—total flying hours grouping.

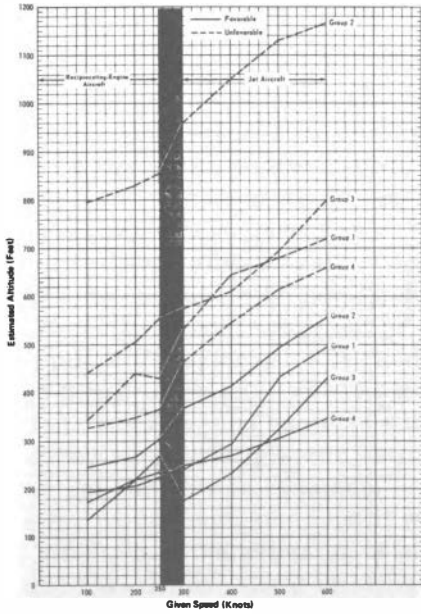

FIG. 9. Means for altitude estimates for reciprocating-engine and jet aircraft: 2- to 3-hr flight duration period—total flying hours grouping.

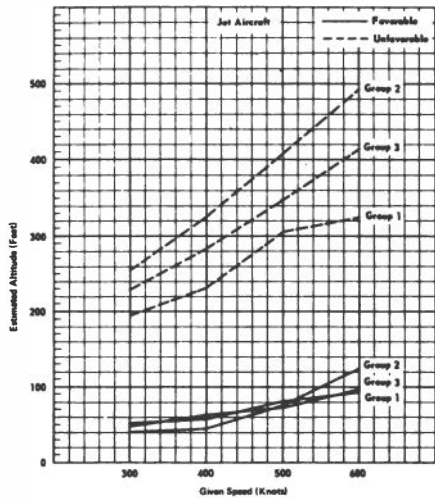

FIG. 10. Mean for altitude estimates for jet aircraft: 10-min flight duration period—total jet time grouping.

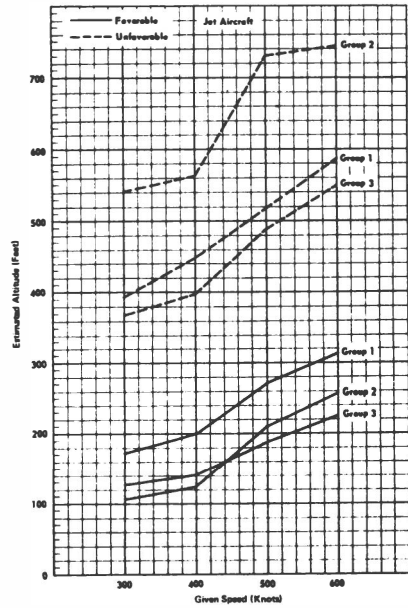

FIG. 11. Mean for altitude estimates for jet aircraft: 1-hr flight duration period—total jet time grouping.

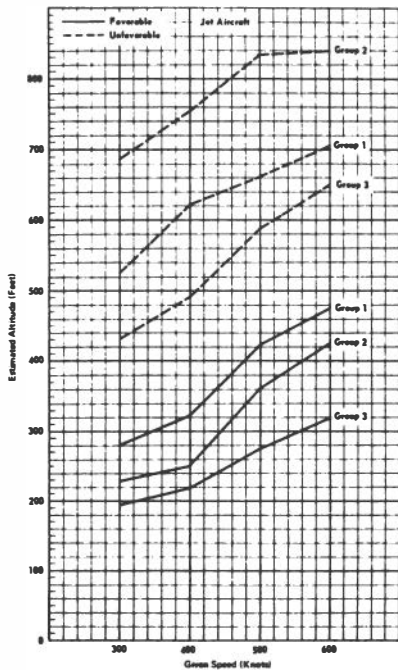

FIG. 12. Mean for altitude estimates for jet aircraft: 2-hr flight duration period—total jet time grouping.

tends to increase variance in performance, these findings are quite significant, for it might be expected that pilots of high anxiety would encounter greater probability of pilot error. The results certainly seem to warrant further investigation.

In the total flying hour groupings, consistent trends demonstrating that pilots of greater experience (as evidenced by higher total flying hours) give lower altitude estimates were not present, and differences were not consistently significant. Therefore, it would appear that total flying hours may not be a significant criterion in selecting pilots to perform low-altitude flight.

However, in two of the three total jet time groupings, results were in the expected direction, and subjects with the greatest total jet time produced significantly lower estimates. Perhaps, then, it is an important variable to consider.

These data are far from conclusive, and it would certainly appear that close attention to the selection of pilots for the performance of critical low-altitude flight missions is warranted. Further research in this area is necessary if adequate understanding of the problem is to be gained.

While these subjective data have much to offer in an approach to understanding and evaluating operational aspects of visual problems in low-altitude flight, field test data are absolutely necessary to improve simulation techniques, to evolve tactical concepts and doctrines involving low-altitude flight, and to improve weapon systems design.

As stated earlier in this paper, data relating to the distance at which typical ground targets might be acquired and recognized during high-speed, low-altitude flight are not adequate. In fact, very little data obtained from physical testing are available. In order to approach this significant gap, a test was conducted at Eglin Air Force Base to determine the effect of aircraft speed on low-altitude acquisition of ground targets (Joska, 1963). Eleven pilots flew 44 acquisition passes against a typical ground target which was placed in a realistic setting. The F-100 aircraft was used with 500 ft as the test altitude, and acquisition distances were obtained for speeds of 250, 350, 450, and 550 knots. The data obtained are shown in Fig. 13.

Since the sample was too small to establish stable means, a statistical test was performed to determine differences among target acquisition distances for the four speeds used during physical testing. A non-parametric test, known as the rank-sum test, was employed. Significant differences between the 250-550, and the 350-550 knot speeds were found to exist (see Table 1). To evaluate further the acquisition phenomena, a chi-square ( $\chi^2$ ) test was performed to determine the probability of target acquisition for each of the four speeds. Significant differences were again found, demonstrating less probability of target acquisition at the 550-knot speed (see Table 2).

This test effort was considered to be a preliminary effort, or pilot study, and another test was performed under a separate project (APGC Project 0501T1) using the F-105 aircraft flying at speeds of 350, 550, and 700 knots, again at an altitude of 500 ft. Targets consisted of three military-type vehicles, placed in line, perpendicular to the flight path. A total of 27 missions was flown, including single passes at each of three target groups per mission, or a total of 81 target passes.

The results of this test were concerned with the relationship between airspeed and target acquisition distance and, as will be covered later, run number and target acquisition distance. Secondary radar data plots were used as a source of data for the test, with target acquisition distances derived therefrom accurate to within  $\pm 200$  ft. The data were plotted in a chart for each

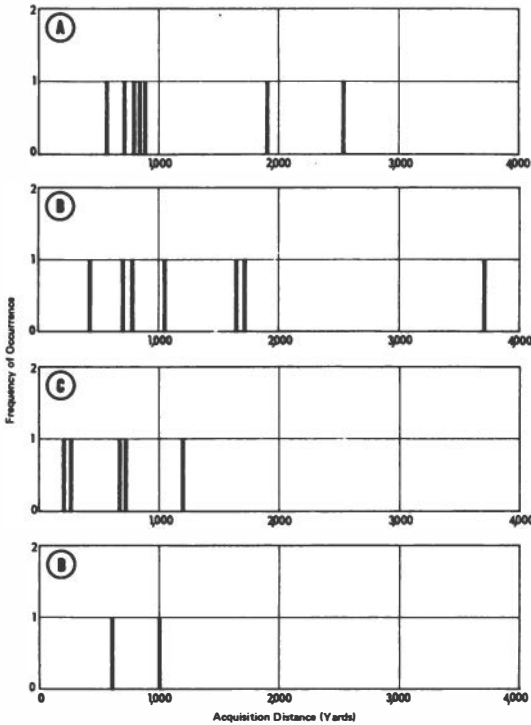

FIG. 13. Line graphs showing distribution of acquisition distances for each of the briefed speeds: (A) 250 KTAS, (B) 350 KTAS, (C) 450 KTAS, (D) 550 KTAS.

of the three speeds with each acquisition occurrence being plotted to the nearest 1,000 ft. These data are included in Fig. 14. The over-all appearance of the data display did not lead to any strong feeling as to the nature of the underlying frequency distributions. Therefore, means and standard deviations were calculated for each speed and the usual  $\chi^2$  "goodness of fit" test was used to test for normality. The  $\chi^2$  test indicated no reason for rejection of the hypothesis that the acquisition distances were normally distributed. Additionally, the medians of the distance distributions for each speed were determined, together with the grand median distance for all target passes.

An analysis of variance was accomplished as if the test were a one-third replicate of a  $9 \times 3 \times 3 \times 3$ , four-factor experiment. Because of military necessity, one pilot was unable to complete the three missions required and, hence, the number of levels of the

**TABLE 1. Summary of Rank-Sum Test Results. Speed Versus Target Acquisition Distance.<sup>a</sup>**

Test No.	Speeds Compared	Sample Sizes	Results
1	250/350 KTAS <sup>b</sup>	7 10	Accept—no difference due to speed
2	350/450 KTAS	9 7	Reject—a difference due to speed
3	450/550 KTAS	6 5	Accept—no difference due to speed
4	250/450 KTAS	5 6	Accept—no difference due to speed
5	250/550 KTAS	7 7	Reject—a difference due to speed
6	350/550 KTAS	9 6	Reject—a difference due to speed

5% level of significance.

<sup>a</sup>Probability less than 5%

<sup>b</sup>Knots true air speed

**TABLE 2. Summary of Chi-Square Tests. Speed Versus Target Acquisition Probability.\***

Test No.	Speeds compared	Chi-Square		Results
		Calculated	From table**	
1	All	9.755	7.810	Reject hypothesis—probabilities differ between speeds
2	250/350 KTAS	0.414	3.841	Accept—no difference
3	350/450 KTAS	0.023	3.841	Accept—no difference
4	450/550 KTAS	1.467	3.841	Accept—no difference
5	250/550 KTAS	6.828	3.841	Reject—probabilities differ between speeds
6	250/450 KTAS	0.053	3.841	Accept—no difference
7	350/550 KTAS	5.166	3.841	Reject—probabilities differ between speeds

\*5% level of significance.

\*\*Necessary for significance at or beyond the 0.05 level.

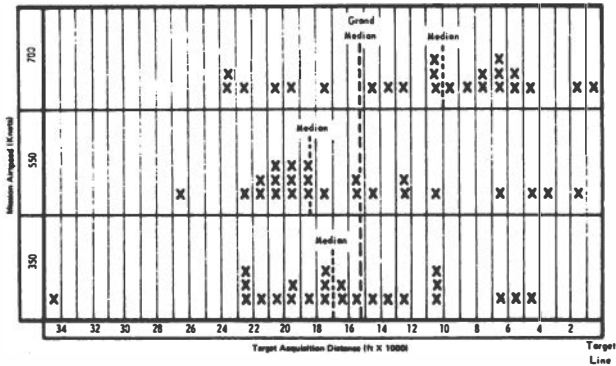

FIG 14. Frequency of occurrence of acquisition distances for each of test speeds.

first factor was reduced to eight. Additionally, this caused a certain degradation of results by an upset in the balance in blocks. Following necessary adjustments, it was determined that the only second-order interactions which were significant were the pilots with targets and pilots with trials. Finally, the analysis of variance in Table 3 shows that speed was a significant factor in target acquisition distance, and also that the number of trials by a particular pilot produced a significant difference in acquisition distances.

The usual "studentized" range technique was used to determine possible groupings with mean acquisition distances calculated versus airspeed only. It was found that the mean acquisition distances on the supersonic (700 knots) runs were significantly lower than the means for the subsonic runs, and that no significant difference existed between the mean acquisition distances for the subsonic runs. Due to the small sample size obtained in this test and the magnitude of the standard deviations in the previous parametric analysis, it was felt that a non-parametric analysis might produce a contradiction to the findings. Therefore, two non-parametric analyses were made which strongly supported the previous findings, thus giving additional assurance to the results.

Fig. 15 illustrates the frequency of target acquisition distance occurrences for each run. This display alone leads one to believe that there is a significant learning factor involved between the first and second runs. The usual  $\chi^2$  "goodness of fit" test was used to test for the normality of the distributions. The results obtained show that the frequencies were not significantly different. The data sample was too small to allow an extrapolation within any reasonable degree of accuracy to compensate for the

TABLE 3. Analysis of Variance.

Source	Sum of Squares	Degrees of Freedom	Mean Squares	F-ratio		Significance*
				Calculated	Critical	
Pilots	337,794,729	7	48,256,390	2.61	3.30	No
Targets	6,157,396	2	3,078,698	0.17	5.39	No
Speeds	339,936,228	2	169,968,114	9.20	5.39	Yes
Runs	948,360,806	2	474,180,403	25.66	5.39	Yes
Pilots x targets	505,702,009	14	36,121,572	1.95	2.75	No
Pilots x runs	854,930,576	14	61,066,470	3.31	2.75	Yes
Error (residual)	554,304,833	30	18,476,827	-	-	-
Totals	3,547,186,577	71	-	-	-	-

\*1% level of significance.



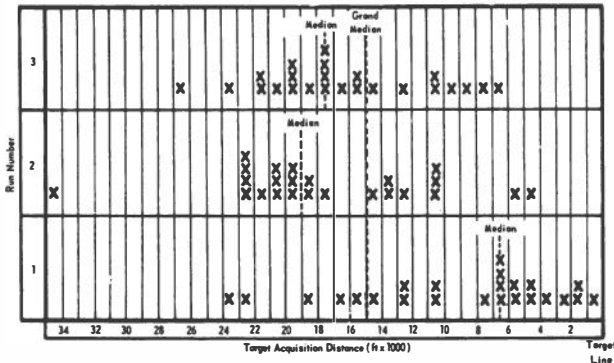

FIG. 15. Frequency of occurrence of acquisition distances for each run.

apparent learning. Although it was known that the variance due to run number could affect the rest of the data, it would have been unreasonable to have attempted to make any compensations in the analysis before further test results were obtained. The fact in question is not so much that there was learning, but rather the degree of learning and the point at which the learning stabilizes. It is felt that after the second set of target passes by a particular pilot, his learning reaches a plateau. After additional testing has been accomplished, an attempt will be made to substantiate this theory.

Although the results of this test were obtained from a small sample size, there was strong support for the fact that target acquisition was affected significantly by the speed of the aircraft. In fact, the distance from the aircraft to the target at acquisition was decidedly less for air speeds in the supersonic region. It is felt that this distance was less to the extent that it put the pilot beyond the critical point in reaction time at which he could make the required tactical corrections for delivery of ordnance on the target.

In light of these factors, another test is presently being conducted at the Air Proving Ground Center to evaluate training techniques designed to improve the perceptual efficiency of pilots and thus improve their capability for target acquisition and recognition.

These techniques involve use of linearly programmed photographs (ranging from low stimulus ambiguity to high stimulus ambiguity) of typical tactical targets which will be presented on a tachistoscopic teaching machine, allowing stimulus presentation speeds of 1 sec, 1/2 sec, 1/10 sec, and 1/20 sec. The target

series consists of 18 targets, such as tanks, missiles, and anti-aircraft guns. Two film sequences comprise the total film package, with the first film serving as the learning film. In the learning film, 14 views of each target, ranging from high-contrast photographs to low-contrast photographs, are presented in both slow and rapid order. The second film consists of an "eyeball training phase" in which 324 photographs of the 18 targets are presented to the subjects in random order in the high-speed mode only. Two groups of TAC line fighter pilots make up the sample. There are 20 pilots in each group, with one group receiving conventional recognition training, as currently used in the field, and the second group receiving the special training outlined above. After completion of the training phase, both groups will be tested on 1-sec presentations of 72 views of the 18 targets. Following this, the pilots in each group will make target acquisition-recognition passes on four single targets placed on the range, perpendicular to the flight path. These passes will be flown at an airspeed of 550 knots at a 500-ft altitude. The two groups will be compared in regard to accurate target identification, distance at target acquisition, distance at target recognition, time lag between target acquisition and recognition, and recall of details of the mission at time of debriefing.

Such a technique appears to have a great deal to offer, not only in basic and specific programs of target recognition training, but also in presenting to pilots, in a highly effective manner, other types of information such as foreign technical material, technical order data, low-level navigational routes with photographs of checkpoints, and new reconnaissance data. All these data could be made available to the combat pilot and presented on a teaching machine for maximum effectiveness. Further, teaching machines are small and reliable, possessing great versatility, and film strips can be made up in a matter of days, hence, giving a reasonable reaction time for both large- and small-scale missions.

## SUMMATION

The effort of the Deputy for Effectiveness Test in the area of low-altitude flight testing has been, to date, one of investigating various aspects of target acquisition and recognition, including evaluation of the techniques designed to improve the perceptual efficiency of pilots, and thus improve their capability for target

acquisition and recognition. Further tests are being established to evaluate target acquisition and recognition at various altitudes and speeds using fixed and mobile targets of varying contrasts. Future test efforts will involve search, acquisition, and recognition of targets with live ordnance delivered against them. It is expected that these tests will be accomplished in 1964.

While it is obvious that this total effort encompasses but a few aspects of the over-all low-altitude, high-speed flight problem, the basic groundwork for solution of the problem is being carried out. It must be remembered that this effort was born of an operational need by a using command. This need must be satisfied in order to provide the necessary assistance to commanders in the field, who are faced with the complex decisions of warfare, and who must have facts at their disposal to make their day-to-day "trade-off" between survival and effectiveness.

## REFERENCES

- Jones, R. L., & Lindsey, J. F. Human factors aspects of low-altitude flight: a sample of fighter pilot attitudes and altitude estimates. Eglin AFB: Air Prov. Ground Centr Doc., 1964, No. PGN 64-1 (APGC Proj. 9069Z).
- Joska, J. S. The effect of aircraft speed on low-altitude acquisition of ground targets. Eglin AFB: Air Prov. Ground Centr Doc., 1963, No. PGT 63-1. (APGC Proj. 5967Z2)







