



Materials Properties Data Management: Approaches to a Critical National Need (1983)

Pages
119

Size
8.5 x 10

ISBN
0309326141

National Materials Advisory Board; Commission on
Engineering and Technical Systems; National Research
Council

 [Find Similar Titles](#)

 [More Information](#)

Visit the National Academies Press online and register for...

- ✓ Instant access to free PDF downloads of titles from the
 - NATIONAL ACADEMY OF SCIENCES
 - NATIONAL ACADEMY OF ENGINEERING
 - INSTITUTE OF MEDICINE
 - NATIONAL RESEARCH COUNCIL
- ✓ 10% off print titles
- ✓ Custom notification of new releases in your field of interest
- ✓ Special offers and discounts

Distribution, posting, or copying of this PDF is strictly prohibited without written permission of the National Academies Press. Unless otherwise indicated, all materials in this PDF are copyrighted by the National Academy of Sciences.

To request permission to reprint or otherwise distribute portions of this publication contact our Customer Service Department at 800-624-6242.

Copyright © National Academy of Sciences. All rights reserved.



NATIONAL RESEARCH COUNCIL
COMMISSION ON ENGINEERING AND TECHNICAL SYSTEMS

NATIONAL MATERIALS ADVISORY BOARD

The purpose of the National Materials Advisory Board is the advancement of materials science and engineering in the national interest.

CHAIRMAN

Dr. Donald J. McPherson (Retired)
Kaiser Aluminum & Chemical Corporation
1180 Monticello Road
Lafayette, CA 94549

PAST CHAIRMAN

Mr. William D. Manly
Senior Vice President
Cabot Corporation
125 High Street
Boston, MA 02110

Members

Dr. Arden L. Bement, Jr.
Vice President, Technology Resources
Science and Technical Department
TRW, Inc.
23555 Euclid Ave.
Cleveland, OH 44117

Dr. William J. Burlant
Director, Lexington Laboratory
The Kendall Co.
Lexington, MA 02173

Dr. James C. Burrows
Vice President
Charles River Associates
200 Clarendon Street
John Hancock Tower, 43rd Floor
Boston, MA 02116

Dr. Raymond F. Decker
Vice President, Research
Michigan Technological University
Houghton, MI 49931

Mr. Edward J. Dulis
President
Crucible Research Center
Colt Industries
P.O. Box 88
Pittsburgh, PA 15230

Dr. Brian R. T. Frost
Division Director, Materials Science
Argonne National Laboratory
9700 South Cass Avenue
Argonne, IL 60439

Dr. Serge Gratch
Director of Chemistry Science Lab
Engineering & Research Staff
Ford Motor Co.
P.O. Box 2053
Dearborn, MI 48121

Dr. Nick Holonyak, Jr.
Professor Electronic Engineering
University of Illinois-Urbana
Dept. of Electrical Engineering
Urbana, IL 61801

Dr. Paul J. Jorgensen
Vice President, SRI International
333 Ravenswood Avenue
Menlo Park, CA 94025

Dr. Alan Lawley
Professor Metallurgical Engineering
Drexel University
Department of Materials Engineering
Philadelphia, PA 19104

Dr. Raymond F. Mikesell
W. E. Miner Professor of Economics
University of Oregon
Department of Economics
Eugene, OR 97403

Dr. David L. Morrison
President
IIT Research Institute
10 West 35th Street
Chicago, IL 60616

Dr. David Okrent
Professor of Engineering & Applied Science
University of California, Los Angeles
5532 Boelter Hill
Los Angeles, CA 90024

Dr. R. Byron Pipes
Director, Center for
Composite Materials
Department of Mechanical &
Aerospace Engineering
University of Delaware
Newark, DE 19711

Professor James R. Rice
Gordon McKay Professor of
Engineering Sciences and Geophysics
Division of Applied Sciences
Harvard University
Peirce Hall
Cambridge, MA 02138

Dr. Brian M. Rushton
Vice President, Research & Development
Air Products & Chemicals, Inc.
P.O. Box 538
Allentown, PA 18105

Dr. William P. Slichter
Executive Director, Research
Materials Science and Engineering Division
Bell Laboratories
600 Mountain Avenue
Murray Hill, NJ 07974

Dr. William A. Vogely
Professor and Head
Department of Mineral Economics
Pennsylvania State University
University Park, PA 16802

Dr. Robert P. Wei
Department of Mechanical Engineering
and Mechanics
Lehigh University
Bethlehem, PA 18015

Dr. Albert R.C. Westwood
Director, Martin Marietta Labs
Martin Marietta Corporation
1450 South Rolling Road
Baltimore, MD 21227

NMAB STAFF

K.M. Zwilsky, Executive Director

UNCLASSIFIED

SECURITY CLASSIFICATION OF THIS PAGE (When Data Entered)

REPORT DOCUMENTATION PAGE		READ INSTRUCTIONS BEFORE COMPLETING FORM
1. REPORT NUMBER NMAB-405	2. GOVT ACCESSION NO.	3. RECIPIENT'S CATALOG NUMBER
4. TITLE (and Subtitle) Materials Properties Data Management-- Approaches to a Critical National Need		5. TYPE OF REPORT & PERIOD COVERED Final Report
7. AUTHOR(s) Committee on Materials Information Used in Computerized Design and Manufacturing Processes		6. PERFORMING ORG. REPORT NUMBER NMAB 405
9. PERFORMING ORGANIZATION NAME AND ADDRESS National Materials Advisory Board National Academy of Sciences 2101 Constitution Avenue, N.W. Washington, D.C. 20418		8. CONTRACT OR GRANT NUMBER(s) MDA 903-82-C-0434
11. CONTROLLING OFFICE NAME AND ADDRESS		10. PROGRAM ELEMENT, PROJECT, TASK AREA & WORK UNIT NUMBERS
		12. REPORT DATE September 1983
		13. NUMBER OF PAGES 112
14. MONITORING AGENCY NAME & ADDRESS (if different from Controlling Office) Defense Advanced Research Projects Agency Department of Defense/National Aeronautics and Space Administration Washington, D.C.		15. SECURITY CLASS. (of this report) Unclassified
16. DISTRIBUTION STATEMENT (of this Report) This report is for sale by the Defense Technical Information Center, Cameron Station, Alexandria, Virginia 22312.		15a. DECLASSIFICATION/DOWNGRADING SCHEDULE
17. DISTRIBUTION STATEMENT (of the abstract entered in Block 20, if different from Report)		
18. SUPPLEMENTARY NOTES		
19. KEY WORDS (Continue on reverse side if necessary and identify by block number)		
CAD/CAM	Handbooks	
Computer networks	Hardware	
Data	Materials data	
Data Storage	Materials properties	
Design	Software	
20. ABSTRACT (Continue on reverse side if necessary and identify by block number)		
<p>The United States has taken a leading role in the application of modern computer technology to design and manufacturing processes through the development of computerized design and manufacturing systems (CAD/CAM systems), which are now in place in some of our large industries. However, a corresponding use of computer technology in the storage, dissemination, and analysis of materials properties data vital to the design process has been only weakly developed. Unfortunately, the United States, which</p>		

UNCLASSIFIED

SECURITY CLASSIFICATION OF THIS PAGE(When Data Entered)

generates the major portion of the free world's materials properties data, has no national policy directed toward efficient management of these data. As a result, valuable information is often lost or very difficult to locate. The efficiency of data management could be greatly enhanced by the use of computerized data bases linked through a national network. No technical barriers stand in the way of developing such a system and such developments have already started in Japan and in the European community with strong support from their central governments.

This report outlines some of the problems associated with the development of materials properties data bases and describes the essential features and advantages of a National Computerized Materials Properties Data Bank Network cooperatively established by our federal government and the private sector. Such a system would be a positive factor in increasing product reliability and improving the competitive position of the United States in a world market environment where maximum use of advanced technology is decisive for success.

Unclassified

**MATERIALS PROPERTIES DATA MANAGEMENT--
APPROACHES TO A CRITICAL NATIONAL NEED**

**Report of the
Committee on Materials Information Used in Computerized
Design and Manufacturing Processes**

**NATIONAL MATERIALS ADVISORY BOARD
Commission on Engineering and Technical Systems
National Research Council**

**NMAB-405
National Academy Press
Washington, D.C.
1983**

**NAS-NAE
OCT 7 1983
LIBRARY**

NOTICE: The project that is the subject of this report was approved by the Governing Board of the National Research Council, whose members are drawn from the Councils of the National Academy of Sciences, the National Academy of Engineering, and the Institute of Medicine. The members of the panel responsible for the report were chosen for their special competences and with regard for appropriate balance.

The report has been reviewed by a group other than the authors according to procedures approved by a Report Review Committee consisting of members of the National Academy of Sciences, the National Academy of Engineering, and the Institute of Medicine.

The National Research Council was established by the National Academy of Sciences in 1916 to associate the broad community of science and technology with the Academy's purposes of furthering knowledge and of advising the federal government. The Council operates in accordance with general policies determined by the Academy under the authority of its congressional charter of 1863, which established the Academy as a private, nonprofit, self-governing membership corporation. The Council has become the principal operating agency of both the National Academy of Sciences and the National Academy of Engineering in the conduct of their services to the government, the public, and the scientific and engineering communities. It is administered jointly by both Academies and the Institute of Medicine. The National Academy of Engineering and the Institute of Medicine were established in 1964 and 1970, respectively, under the charter of the National Academy of Sciences.

This study by the National Materials Advisory Board was conducted under Contract No. MDA 903-82-C-0434 with the Department of Defense and the National Aeronautics and Space Administration.

This report is for sale by the Defense Technical Information Center, Cameron Station, Alexandria, Virginia 22314.

Printed in the United States of America.

ABSTRACT

The United States has taken a leading role in the application of modern computer technology to design and manufacturing processes through the development of computerized design and manufacturing systems (CAD/CAM systems), which are now in place in some of our large industries. However, a corresponding use of computer technology in the storage, dissemination, and analysis of materials properties data vital to the design process has been only weakly developed. Unfortunately, the United States, which generates the major portion of the free world's materials properties data, has no national policy directed toward efficient management of these data. As a result, valuable information is often lost or very difficult to locate. The efficiency of data management could be greatly enhanced by the use of computerized data bases linked through a national network. No technical barriers stand in the way of developing such a system and such developments have already started in Japan and in the European community with strong support from their central governments.

It is obvious that the CAD/CAM system could be improved by rapid access to appropriate computerized data bases containing properly evaluated materials properties data. Of equal importance is the provision of such information to our many relatively small industries, which may not have a staff of materials specialists and, therefore, find themselves in an unfavorable position with respect to foreign competitors in those countries where technology receives strong federal support.

One might look to the Department of Defense Information Analysis Centers (IACs) to take the lead in providing the needed data bases and networking arrangements because the DOD generates a large portion of our materials properties data through their research and technology programs and through their hardware programs. However, the funding history of the IACs reflects a continuous weakening over the last 12 years, and the only center concerned with development of a computerized mechanical properties data base for metals was abolished in 1982.

In the absence of a rational materials data management policy, the United States is allowing the hemorrhaging of a vital national resource. The consequences of this neglect are serious:

1. Data loss has a negative impact on the evolution of new engineering concepts through depletion of the information base necessary for their development.

2. The record shows millions of dollars of losses associated with structural failures caused by the lack of appropriate materials properties data. As structural complexity increases in the transportation and power generating fields, component reliability will deteriorate in the absence of a comprehensive materials properties data base.
3. Neither the DOD nor NASA have an effective means for retrieval and dissemination of materials properties data derived from their hardware programs. Thus, information generated through the expenditure of public funds is unavailable to those in the private sector who helped pay for it and who could effectively use it.
4. As the amount and complexity of materials properties data continue to expand, the commonly used data bases in the form of handbooks will become increasingly out of date due to inefficiencies in their production.
5. The United States is rapidly approaching a position where, in some cases, due to schedule constraints, it is more efficient to regenerate the needed data than to search for it.
6. A continuation of the passive attitude of our federal government concerning the materials properties data management will ultimately result in further erosion of our competitive position in the world's industrial markets.

This report outlines some of the problems associated with the development of materials properties data bases and describes the essential features and advantages of a National Computerized Materials Properties Data Bank Network cooperatively established by our federal government and the private sector. Such a system would be a positive factor in increasing product reliability and improving the competitive position of the United States in a world market environment where maximum use of advanced technology is decisive for success.

ACKNOWLEDGMENT

Appendixes A through G were prepared by members of the committee. Mr. Harold Mindlin of Battelle-Columbus Laboratories provided helpful comments during their preparation. We are grateful to Professor Volker Weiss of Syracuse University, who contributed Appendix H in its entirety and to Dr. Jack H. Westbrook of the General Electric Company, who contributed Appendix I.

NATIONAL MATERIALS ADVISORY BOARD

Committee on Materials Information Used in Computerized
Structural Design and Manufacturing

Chairman

WILLIAM F. BROWN, JR., Consultant, National Aeronautics and Space
Administration, Lewis Research Center, Cleveland, Ohio

Members

WILLIAM D. BEEBY, William Beeby Associates, Renton, Washington (formerly
Boeing Commercial Airplane Company)

JAMES A. GRAHAM, Manager, Materials Technology, Deere and Company Technical
Center, Moline, Illinois

LEONARD BEITCH, Manager, Engineering Mechanics and Life Management,
General Electric Aircraft Engine Group, Cincinnati, Ohio

DALE C. LITTLE, Manager, Materials Technology, General Dynamics, Fort Worth,
Texas

THOMAS P. RICH, Professor, Department of Mechanical Engineering, Bucknell
University, Lewisburg, Pennsylvania

EDWARD J. RIPLING, President and Director of Research, Materials Research
Laboratory, Glenwood, Illinois

EDWARD T. WESSEL, Retired, Murrysville, Pennsylvania (formerly Senior
Consultant, Materials Science Division, Westinghouse Research and
Development Center, Pittsburgh, Pennsylvania)

Liaison Representatives

A. ANDERJASKA, Airframe Branch, Office of Airworthiness, Federal Aviation
Administration, Department of Transportation, Washington, D.C.

CYNTHIA CARTER, Executive Secretary, Numerical Data Advisory Board, National
Academy of Sciences, Washington, D.C.

ROBERT E. FULTON, National Aeronautics and Space Administration, Langley
Research Center, Hampton, Virginia

CLAYTON HARMSWORTH, Materials Integrity Branch, Air Force Wright
Aeronautical Laboratory, Wright-Patterson Air Force Base, Ohio

Liaison Representatives (cont.)

THOMAS F. KEARNS, Institute for Defense Analysis, Alexandria, Virginia

RALPH PAPIRNO, Army Materials and Mechanics Research Center, Watertown,
Massachusetts

JEROME PERSH, Staff Specialist for Materials and Structures (Engineering
Technology), Office of Deputy Under Secretary of Defense for Research
and Engineering, Department of Defense, Washington, D.C.

JOHN RUMBLE, Program Manager, Materials Durability and Resource Recovery,
National Bureau of Standards, Washington, D.C.

RICHARD SCHMIDT, Naval Air Systems Command, Department of the Navy,
Washington, D.C.

CECIL WALLACE, Structural Concepts Branch, Air Force Wright Aeronautical
Laboratory, Wright-Patterson Air Force Base, Ohio

NMAB Staff

Joseph R. Lane, Staff Metallurgist

CONTENTS

	<u>Page</u>
1 INTRODUCTION	1
2 CONCLUSIONS AND RECOMMENDATIONS	5
Conclusions	5
Recommendations	7
3 CLASSES OF INFORMATION AND USE OF THE MATERIALS PROPERTIES DATA BASE	9
Classes	9
Use in Design	9
4 SOURCES OF MATERIAL PROPERTY DATA USEFUL TO THE STRUCTURAL DESIGNER	13
Numeric Data Bases for Materials Properties	13
DOD Information Analysis Centers	14
5 PROBLEMS ASSOCIATED WITH ESTABLISHING A MATERIALS PROPERTIES DATA BASE	17
Common Problems	17
Problems Associated With Machine Readable Data Bases	23
6 PRODUCTION AND USE OF A MATERIALS PROPERTIES DATA BASE	25
Data Base in Handbook Form	25
Computerized Data Bases	27
7 A NATIONAL MATERIALS PROPERTIES DATA NETWORK	33
REFERENCES	37
APPENDIXES	
A. EXAMPLES OF THE COSTS OF HARDWARE FAILURE AND OF SAVING MATERIALS PROPERTIES DATA	39
B. SITUATION WITHIN THE DOD CONCERNING THE ACCUMULATION AND STORAGE OF MATERIALS PROPERTIES DATA ORIGINATING FROM SYSTEMS PROGRAMS	43
C. SITUATION WITHIN NASA CONCERNING THE ACCUMULATION AND STORAGE OF MATERIALS PROPERTIES DATA ORIGINATING FROM SYSTEMS PROGRAMS	51
D. APPLICATIONS OF COMPUTER-AIDED DESIGN OF THE 767	53
E. EXAMPLE OF AN ON-LINE COMPUTERIZED MATERIALS PROPERTIES DATA BASE DEVELOPED FROM AN EXISTING HANDBOOK DATA BASE	61

INTRODUCTION

The National Materials Advisory Board's Committee on Materials Information Used in Computerized Design and Manufacturing Processes was charged with the task of arranging a dialogue between the design community and the materials community in order to define the needs of designers with respect to materials properties data for use in computer-aided design (CAD) and computer-aided manufacturing (CAM). As the committee looked into the task it became apparent that the larger problem of how to efficiently retain and access property data had to be solved first.

Materials properties combined with structural analysis form the basis of modern industrial design. International competitive pressures are driving virtually all structural design in the direction of greater complexity and increased economies of production and operation. If the U.S. industrial design process is to remain competitive in this environment, engineers must have rapid access to a well organized materials properties data base. Experience both within the Department of Defense (DOD) and the National Aeronautics and Space Administration (NASA) has shown that extremely expensive failures can result from the use of designs that are not supported by adequate materials properties data.

The efficiency of any structural design process will be improved by access to an on-line computerized data base containing critically evaluated information. The need for data bases and the corresponding need for adequate data evaluation have been emphasized for several years. In 1978 the Numerical Data Advisory Board (NDAB) of the National Academy of Sciences reviewed the activities of U.S. data analysis centers and pointed out that the cost of operating a data center is far less than the cost of generating the data. To this may be added the observation that one failure resulting from inadequate information at the design stage can result in costs far exceeding those associated with several years of operating a pertinent data base (see Appendix A). The NDAB (1980) also reviewed the status of data reporting, evaluation, and dissemination for the mechanical properties of

metals and alloys. It emphasized the deficiencies in this area both on a national and on an international level. Although not specifically pointed out by the NDAB, it is worth noting that the DOD has no identifiable system for gathering, storing, and retrieving materials properties data originating from their contracting or in-house activities (see Appendix B). NASA is in no better shape in this respect (see Appendix C). More recent reviews of the need for adequately maintained data bases and the advantage of modern computer technology in the storage and dissemination of information have been performed by Lide (1981) and Hampel (1981).

During the past decade there has been rapid development and implementation of the use of computers in the aerospace industry and elsewhere. Interactive graphics permit the definition of detail parts and assemblies in such a way that alternative configurations are easily displayed by varying certain input parameters. In addition, computer applications have included kinematics, clearance studies, and mock-up layouts. Information developed in this way is readily stored and retrievable for use in automating the manufacturing processes. An example of the use of advanced CAD and CAM methodologies in airframe design is described in Appendix D, which illustrates the large savings in start-up time, reduction in manufacturing changes, and increased part standardizations that can be achieved using modern computer technology.

Although the CAD and CAM methods employed in the above example are indeed at a high level of sophistication, they do not directly incorporate computerized materials properties information that the designer needs to select materials and to size components for a given service application or to decide on the most appropriate fabrication processes. It seems obvious that the design process, with or without CAD and CAM methods, could be enhanced by conjugate use of on-line materials properties data bases having the capability of responding to a range of user inquiries and of operating in a friendly mode. Particularly interesting in this respect is the development of logic programming that permits the computer to perform operations requiring deductive reasoning and thus exhibit "artificial intelligence." This is a new and rapidly expanding field in which commercial markets have only started to develop (Verity 1982).

It is worth noting that the Japanese have undertaken a national effort to produce by 1990 a family of super computers whose operation will be based on logic programming with communication between the user and the machine in spoken language. The Japanese government is providing 100 percent of the funding for the basic research with approximately \$41 million being approved through 1984. As the program moves forward, it is expected that government funding will drop to about 50 percent, which in the development stage will represent a government contribution of from \$100 to \$170 million. A recent survey of advanced Japanese developments in the field of super computers is given by Buzbee and co-workers (1982). After reviewing the Japanese plans the British Department of Industry has proposed a "catch-up" program to be funded at \$600 million over a period of 5 years, with 100 percent government funding for research and training and 90 percent government funding for operation where the information is to receive wide dissemination (Alvey Committee 1982).

The study of materials properties and the factors influencing them constitute the largest branch of the physical sciences and the data derived from these studies are scattered through many sources. Although these sources can be identified through the recently developed machine-readable bibliographic services, the citations for a given material are frequently so numerous as to render compilation and evaluation for relevancy a very time consuming and expensive task. Further, the interpretation of relevant data often is complicated by the lack of a standard format for presentation and by the absence of sufficient information to properly characterize the material.

The situation in the United States regarding materials properties data management can be characterized by the ad hoc development of data bases and a steady decay of the DOD Information Analysis Centers that once had a lead role in this field. This passive attitude of the federal government stands in contrast to the well established plans in the European community and in Japan to accelerate the development of computerized processing of information through programs well funded by their national governments.

Evidence for an increasing awareness of the need for systematic management of materials properties data in the United States is provided by the discussions that took place during a workshop held in November of 1982 and organized by the National Bureau of Standards, CODATA, Fachinformation-zentrum (West Germany), and Oak Ridge National Laboratory. The executive summary of the proceedings of this workshop are given in Appendix I. This summary emphasizes that computer access to materials property data is needed badly and would substantially improve the efficiency and reliability of structural design. However, such access does not exist in any comprehensive form, even though no technical barriers to its development can be identified. The workshop defined the major problem as selection of the proper group to lead the development of a national computerized materials properties data network to raise the required funds and to coordinate the necessary technical expertise. It was recommended by this workshop that the NAE take an active role in the formation of such a system and, if necessary, to establish a committee that would define the specific tasks and identify the permanent leadership to manage and operate the system.

Major U.S. technical societies (American Society for Mechanical Engineers, American Society for Metals, American Society for Testing and Materials, and the American Welding Society) and the Engineering Foundation have evidenced a strong interest in computerized materials properties data bases and have funded a study through the Metal Properties Council (MPC) to explore the feasibility of establishing a nationally based computerized materials properties data network. This study also revealed that the major obstacles facing such a development are not technical but center on funding. In connection with the MPC study, a survey made by Westbrook (1982a and 1982b) shows that the European nations and Japan have several well developed machine readable data bases for materials properties. For example, the Technical Institute of Kawasaki Heavy Industries in Japan maintains a large file of mechanical properties (including fatigue, crack propagation, fracture toughness, and creep) for a wide variety of alloys used in heavy industry. The University of Tokyo also maintains machine-readable files of mechanical properties. The Betriebsforschungs-institut in West Germany maintains a data base on the physical and

mechanical properties of 300 grades of steel with approximately 2000 data points per grade. The Commission of the European Communities, through action of the Joint Research Center Petten Establishment in the Netherlands, has established a pilot program for an on-line data base for one alloy (INCO 800) that is used widely in the power generating and chemical industries (Commission of the European Communities 1981). The data are available on-line to the six European nations supporting the program. All of these programs are supported either entirely or primarily by the nations themselves. The content of these data files, in many cases, is largely derived from data generated in the United States. Westbrook's survey (Westbrook 1982b) also shows that the development of machine-readable materials properties bases is not confined to the free world. For example, the Czechoslovak Institute of Standards and Quality maintains a file on steels and plastics totaling about one-half million data points.

The situation in the United States appears to be quite different, as pointed out by Representative George E. Brown, Jr., formerly Chairman of the Subcommittee on Science, Research, and Technology of the House Committee on Science and Technology. Brown (1981) characterizes the federal government's approach to the management of scientific and technical information as "ad hoc and piecemeal" and urges that new initiatives be developed to address the storage, access, packaging, and dissemination of such information, which is purchased by the taxpayer through federally funded research.

Remedial action is urgently needed for the chaotic state of materials properties data management in the United States. The purpose of this report is to suggest means for improving the situation. Specifically, the objectives of the report are as follows: (1) to define the use of a materials properties data base in the structural design process, (2) to identify sources of materials properties data with emphasis on machine-readable files, (3) to outline the problems associated with the development of a materials properties data base with emphasis on the role of specialists and data base management systems, (4) to give examples of the production and use of a design-oriented materials properties data base, (5) to outline the essential features of a National Materials Properties Data Network, and (6) to recommend those actions that will be necessary to bring such a network into existence.

CONCLUSIONS AND RECOMMENDATIONS

CONCLUSIONS

On the basis of the evidence available, the committee has drawn the following conclusions:

1. There is no national policy in the United States directed toward a rational system of materials properties data management and the situation in this area is best described as chaotic. As a result, valuable information is sometimes lost or otherwise unavailable to the designer because of inefficiencies in the present primitive systems of data storage and dissemination.
2. U.S. technology cannot remain progressive and competitive if engineers do not have timely access to the growing stock of materials properties data. To be most effective, these data must be equally available to engineers in all industries, whether large or small.
3. Neither the DOD nor NASA appear to be making an effort to organize and save the materials properties data resulting from their hardware programs. Essentially many of these data are lost and may be generated again in subsequent hardware programs.
4. The absence of appropriate materials properties data or the lack of knowledge of their existence has resulted in enormously expensive failures (in the range of several hundred millions of dollars) for both NASA and the DOD. However, it is not possible to use this information directly in estimating future cost savings associated with the development of properly managed data bases.
5. The United States led the world in materials data management when the DOD Information Analysis Centers were established. Although these centers still perform valuable services with respect to the production of handbooks and, in a few cases, the maintenance of machine-readable

data bases, they have been progressively weakened by the lack of adequate funding, and the only center concerned with development of a computerized mechanical properties data base for alloys has been abolished.

6. References to sources of materials properties data are easily obtained from machine-readable on-line bibliographic services maintained by the U.S. federal government and several private organizations; however, it often is difficult to determine whether the data are relevant without reading the references.
7. Handbooks now constitute the most comprehensive materials properties data bases, but they are a primitive form of numeric data base and are inefficient to use in the design process. In some cases the materials characterizations provided in handbooks are poor, and it is difficult to make rapid comparisons of materials properties and to abstract graphical information for computerized structural analysis. These limitations will increase as the complexity of materials properties data increases.
8. The United States has been a leader in the development of the computer-aided design and manufacturing techniques that greatly reduce routine engineering time and manufacturing costs in high technology industries, but the use of computers in materials data management has been only weakly developed.
9. Efficient access to and manipulation of materials properties data in the design process requires the development of machine-readable data bases coupled with data base management systems that can respond to a variety of user needs.
10. While certain problems can be identified as associated with machine-readable data bases, none of these constitute a barrier to their development. A number of machine-readable data bases and data base management systems exist in the United States, but all have been developed independently for special purposes and there are no plans to interconnect them.
11. Data base management systems that permit the computer to answer unanticipated questions and to handle queries requiring deductive reasoning are now in the experimental stage, and it is obvious that they have enormous potential for increasing the efficiency of the design process.
12. The federal government and the private sector should work cooperatively to establish a national computerized materials properties data bank network that would efficiently provide carefully evaluated information to our industrial designers. Active participation of the federal government is initially required because start-up costs cannot be rapidly recovered and because the whole nation will benefit from the existence of such a network.

RECOMMENDATIONS

Based on the conclusions of this study and on those of complimentary studies, the committee makes the following recommendations:

1. The federal government should assume a strong supportive role in establishing a National Materials Properties Data Network and work cooperatively towards this goal with those organizations, such as the Metal Properties Council that have taken the first steps in defining the funding problems facing such a development.
2. In concert with the recommendations of the Computerized Materials Data Workshop (Appendix I), the committee recommends that the NAS/NAE take an active role in the development of a National Materials Properties Data Network. A Network Systems Definition Committee should be formed with the cooperation of the Numerical Data Advisory Board and the National Materials Advisory Board. These boards are appropriate to deal with the technical questions and, because of their impartial nature, with proprietary concerns. It is anticipated that the Network Systems Definition Committee would consist of a relative few (perhaps five to seven) persons representing the following fields: compilation of materials properties data and their analysis, materials application, structural analysis and design using computers, data base management theory and application, and economic analysis. This group would receive input and advice from the MPC and appropriate federal agencies. It is anticipated that upon completion of the committee's studies and plans, another group would assume a monitoring function.

It is suggested that the Network Systems Definition Committee undertake the following tasks:

- a. Prepare a justification for the National Materials Properties Data Network in terms of national needs and estimate the economic benefits that would accrue from its operation.
- b. Identify specific users and their technical requirements.
- c. Define the characteristics of the National Materials Properties Data Network in terms of both technical and administrative functions, namely: hardware, software, and communications between data bases; means for ensuring validity of the data; structure of the technical and administrative staff; and suggested location.
- d. Identify legal problems and the means for securing and handling classified and proprietary data.
- e. Define development tasks and schedules and suggest task assignments so that a statement of work can be prepared by an appropriate federal agency.
- f. Provide an estimate of start-up costs and the respective role of the federal government and industry in providing the required funds.

- g. Plan a demonstration program using existing facilities to the extent possible and provide a cost estimate for this plan.
- h. Determine to what extent the National Data Base should engage in international cooperation.

The committee believes that the development of a demonstration program is one of the most important tasks for the Network Systems Definition Committee because without it there is nothing tangible to sell to those persons who have the funds but probably do not have direct experience with materials properties data bases or their potential uses.

CLASSES OF INFORMATION AND USE OF A MATERIALS PROPERTIES DATA BASE

CLASSES

The information in a materials properties data base falls into three classes:

1. Test data that are derived from presumably repeatable measurements on a material body or physical system. These data can be expressed in numerical form and ideally are invariant for the test conditions applied. Included here would be the mechanical properties of materials such as tensile strength, crack propagation resistance, and corrosion rates as well as physical properties such as the thermal and electrical characteristics.
2. Data that cannot be reduced to numerical form such as the conclusions derived from laboratory tests and performance feedback regarding precautions to be taken in the production, fabrication, or application of a given material (e.g., a certain heat-treated condition of a steel should be avoided if the application involves high stresses and corrosive atmospheres). Although numerical data may be the basis for such statements, it often is not possible to express the precautionary statement in quantitative terms because of the complexity of the material response.
3. Data relating to specification requirements, material costs, fabrication costs, maintenance procedures, etc. These data may be expressed in numerical form but they are not invariant and frequently must be up-dated as economic conditions, available materials, production processes, etc., change.

USE IN DESIGN

A well developed materials properties data base in combination with modern methods of fatigue and fracture analysis permit the designer to simulate

component performance more accurately than was possible a decade ago. With this information it is possible to achieve an optimum balance of structural performance and minimum cost.

Measures of structural performance will vary with the end use of the product. In the aerospace industry, for example, damage tolerance and minimum weight will be major factors, whereas in the power-generating industry, very long life combined with low maintenance costs are prime measures of structural performance. An approach commonly used by the aerospace industry (Figure 1) involves the creation of detail component groups that have similar form and requirements. The next step is to identify candidate materials and manufacturing processes for each group giving consideration to all available options. Preliminary structural analysis including fatigue and fracture mechanics considerations coupled with various cost and schedule factors then narrows the list of candidates. Finally, cost and weight trade-off studies are made to arrive at the final materials selection. Although the high technology aerospace industry has led the way in the use of advanced design concepts and well developed materials properties data bases, the ground transportation industry now is employing similar procedures to reduce costs and increase product reliability. Examples of the use of materials properties data bases in conjunction with modern design methods are provided by Galliard and co-workers (1979) for off-the-road machinery and by Appo (1981) for automotive manufacturing.

The materials properties data needed for the selection process varies according to the component and its environment. A very large amount of information on mechanical and physical properties is needed when a damage tolerance approach to design is used or when the material property is time-dependent as in the design of the hot section of jet aircraft engines or steam turbines. Also encompassed in the materials properties data base are the applicable specifications for each material and these often include both company specifications and those of federal agencies. The total data base generally resides in a set of printed documents, as described in Appendix E. In a large industrial concern this library may consist of as many as 14 thick books and total several thousand pages. In such a large organization, the designer generally is not concerned with the creation of this data base; rather he is provided with information on physical and mechanical properties and other material characteristics by appropriate specialists. For example, the materials specialists will use valid data in combination with his own experience of material behavior to provide a curve of tensile strength versus temperature for the designer. This curve may be the result of a statistical analysis and represent a 95 percent confidence that 99 percent of future strength values will exceed the curve. The "A" and "B" values in Military Handbook-5 are examples of such design data. In addition to the documented data base, the designer may require special test data specific to his particular application. An example is the life of a material under certain spectrum loading and environment conditions. Such information may be so specialized that it cannot be applied to other designs.

Even with the help of a well documented data base prepared by various specialists, the designer, in a high technology industry, is faced with a time consuming and sometimes tedious job in making his material selections. The situation is particularly complex when many material candidates must be examined. For example, the design of the B-1 bomber involved a detailed

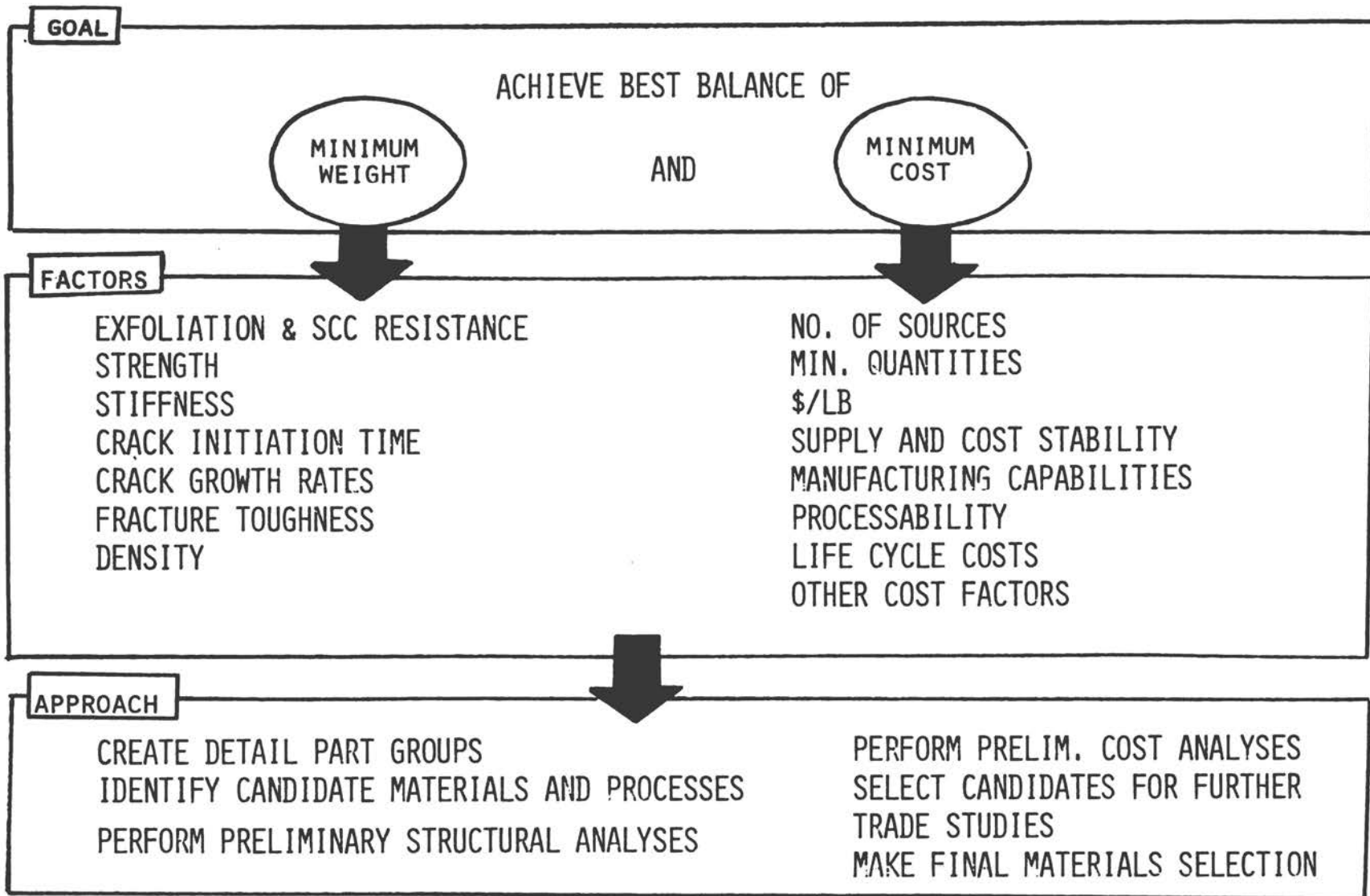

FIGURE 1 The generalized procedure as used in the aerospace industry for material and for process selection.

assessment of the fracture characteristics of 15 alloys (Ferguson and Berryman 1976). The designer not in a high technology industry generally is not faced with as many material selection decisions, but he also does not have the cadre of materials specialists to help him arrive at valid design properties. Therefore, he must depend on widely scattered technical literature for information and on the relatively few published handbooks. Many of his sources will not contain critically evaluated data and, as a result, unwise design decisions may be made.

At present, the use of materials properties data stands aside from direct involvement in CAD and CAM systems. If these systems are limited to interactive graphic displays of structures, pattern development and the production of engineering drawings, a materials properties data base has no direct role; however, there is no apparent reason why the CAD process cannot be expanded to include various structural analysis methods, including finite elements. With this expanded capability, a materials properties data base can be used to determine the load carrying capacity of a given component or to make detailed stress analyses of the critical areas of a component. With this flexibility, engineers interacting with computers could fully evaluate a new product or design modification from the standpoints of structural integrity, manufacturing costs, and scheduling. The efficiency of this expanded form of CAD and CAM would be enhanced by the use of software permitting the computer to perform automatic deductive reasoning. The application of such "artificial intelligence" will be discussed later.

When considering the integration of a materials properties data base into CAD and CAM, it should be recognized that the large savings in production costs resulting from the use of CAD and CAM in the aircraft industry primarily reflect the elimination of engineering drawing time and increased efficiency in fabrication. The introduction of an on-line materials data base would not further increase these savings but would act to stimulate conceptual design and increase product reliability, both of which are essential for technological leadership in any industrial organization.

SOURCES OF MATERIALS PROPERTIES DATA USEFUL TO THE STRUCTURAL DESIGNER

With the exception of data relating to specification requirements, materials costs, etc., the information necessary for a materials properties data base is seldom generated primarily by the organization using the data base. Exceptions are encountered in advanced technology industries in which large amounts of proprietary data are generated in the course of the development of new products.

Westbrook and Desai (1978) have reviewed data sources for materials scientists and engineers and have developed a matrix that permits rapid identification of a pertinent data source as a function of the property or information type of interest. Of the information sources studied, 45 were identified as centers or projects in which the output in the form of handbooks, reports, or data files is the responsibility of specialists in the specific field covered by the center. However, only a few of these were identified as being concerned with physical or mechanical properties data useful to the designer. Westbrook and Desai (1978) also listed 16 guides to materials information that are essentially sources having detailed information. Twelve of these guides are concerned with structural materials and none attempt to critically evaluate a data source. As pointed out by Westbrook and Desai, the listing of critically evaluated sources is not comprehensive but selective of those sources containing a combination of the most and best evaluated data. What follows here is an attempt to provide information that will up-date Westbrook and Desai's 1978 review with emphasis on mechanical properties useful to the structural designer.

NUMERIC DATA BASES FOR MATERIALS PROPERTIES

The NDAB (1980) have surveyed the status of the reporting, collection, appraisal, and dissemination of mechanical properties data for metals and alloys. It lists 15 numerical data compilation programs exclusive of those maintained by private industry for in-house use. A more recent survey by Westbrook (1982a) lists 58 machine-readable files of engineering data on

materials located in this country and abroad. Of these, 35 are identified as containing mechanical properties with the majority (28) concentrating on metals and alloys. The remaining 7 contain data on polymers and composites. Other machine-readable files contain information on corrosion, explosives, electrical properties, machinability, forming, and casting. In many cases Westbrook provides valuable information on the specific goals and favorable and unfavorable features of these data bases. Although the listing may not be complete, it does reveal that there is considerable interest in establishing machine-readable data bases within the U.S. industrial community. Thus, of the 35 files identified by Westbrook (1982a) as being concerned with mechanical properties, 24 are located in the United States but only 7 are directly supported by the federal agencies. Unfortunately, few of the organizations listed are capable of providing critically evaluated data, and there is little evidence of cooperation or interconnection between the various data bases. Presumably these machine-readable data bases could be placed on-line; however, very few have that as a goal. The fact that the majority of the machine-readable files containing mechanical properties are located within the United States should not be taken to mean that the nation is leading in this technology. In fact, on-line operation is a better distinguished goal in Europe and Japan than in the United States, and, as pointed out previously, the commitment to move toward integrated on-line systems with government support is far better established outside the United States than within.

Appendix F summarizes a survey made by the committee devoted to data bases in the United States that specialize in physical and mechanical properties useful to the designer. Also identified are certain comprehensive bibliographic data bases that have proven useful to both the materials engineer and the designer. Of the 9 data bases concerned with mechanical properties of constructional materials, only the Carbon-Carbon Composite Data Bank located at Battelle-Columbus Laboratories and the Plastics Technical Evaluation Center (PLASTEC) located at the U.S. Army Armament Research and Development Command provide on-line service to the user. The Mechanical Properties Data Center located at Battelle-Columbus Laboratories was in the process of reorganization prior to going on-line when it was terminated in 1982 by its sponsor, the Defense Logistics Agency.

DOD INFORMATION ANALYSIS CENTERS

It is important to briefly examine the role and the history of the DOD Information Analysis Centers (IACs). The original mission of these centers was to gather, analyze, and disseminate technical information originating from federal activities and from other sources, with the thought that benefits would accrue to both the government and the private sector. Of the DOD-sponsored IACs (Defense Logistic Agency 1981) seven can be identified as providing information useful to the structural designer. Of these seven, five are listed as concerned with physical and mechanical properties. Two of these--the MCIC Carbon-Carbon Composite Data Bank and PLASTEC--provide on-line access. A salient feature of these IACs is their charter to provide critically evaluated data. Unfortunately, they have suffered from continuously increasing neglect. In fact, the Mechanical Properties Data Center at Battelle-Columbus Laboratories was eliminated this year, and this

was the only IAC specifically concerned with maintaining a computerized data base for metallic alloys. As initially operated, the DOD IACs distributed their products without charge or for only a nominal charge to organizations involved in maintaining an adequate national defense. More recently, the IACs have been required to achieve a substantial measure of self-support through sales of their products. This has been increasingly difficult in times of economic distress. The effectiveness of the IACs has been further decreased over the past few years by the effects of inflation and reduced budgets. An example is shown in Figure 2 (private communication, W. F. Brown, Jr., NASA-Lewis Research Center and H. Mindlin, Battelle-Columbus Laboratories, 1983), which illustrates the funding level of the Metals and Ceramics Center in the period from 1975 to 1982 based on 1972 dollars. The plight of the DOD IACs is not due to arguments made against the wisdom of saving and analyzing information but likely stems from the difficulty of selling a product to the DOD which is not clearly targeted to a particular hardware defense program.

Although the DOD IACs are still able to provide useful services to the structural designer, the continuous eroding of their resources has made them less timely and less efficient than would be desirable. Without restoration of an appropriate level of federal support it would be very difficult for them to develop a sufficient market to expand computer-based operations.

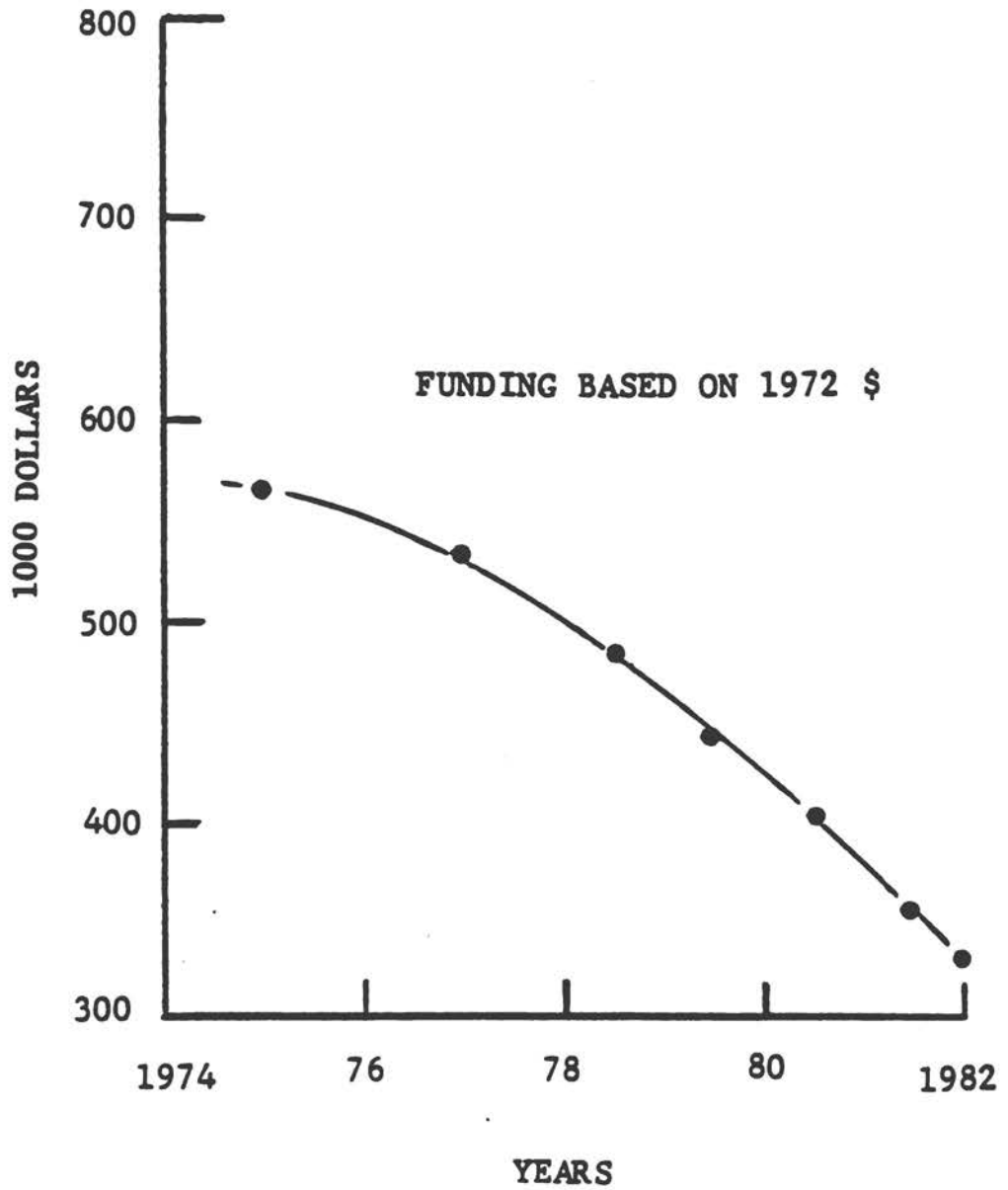

FIGURE 2 Metals and Ceramics Information Center funding history.

PROBLEMS ASSOCIATED WITH ESTABLISHING A MATERIALS PROPERTIES DATA BASE

There are certain readily identified, common problems associated with establishing a materials properties data base whether it be in the form of a handbook or of a machine-readable file. Computerized data bases have special problems primarily associated with the development of the software. What follows is a brief summary of the common problems and these special problems.

COMMON PROBLEMS

1. Size of the Data Base

A data base for the physical and mechanical properties of metals alone which includes both minimum and typical properties will be very large and subject to rapid expansion. Some idea of the size and character of such a data base can be obtained from examination of the information on metallic alloys contained in the Society of Automotive Engineers-Aeronautical Materials Specifications (SAE-AMS), Military Handbook-5, and the Aerospace Structural Metals Handbook (Metals and Ceramics Information Center 1982a), which are all devoted primarily to the needs of the aerospace industry. Reference to the Aerospace Structural Metals Handbook shows that about 30 physical and mechanical properties are used by the designer at one time or another. These, in turn, are often a function of temperature, strain rate, melting practice, fabrication history, heat treatment, and chemical environment. The Aerospace Structural Metals Handbook contains chapters on over 200 alloys, 5000 graphical displays, and 3000 tables. MIL-Hdbk-5 emphasizes statistically treated data and contains information on 113 alloys. There are over 2000 SAE-AMS specifications covering several hundred alloys used in the aerospace industry. All three of these sources contain a large amount of data that cannot be reduced to numerical form (see chapter 3) as an aid to the designer and metallurgist in materials selection.

2. Lack of Physical Laws.

Unfortunately, most of the mechanical properties of materials cannot be connected by general laws of behavior such as those which describe the reaction rates of chemical substances. Thus, there is no mechanical equation of state relating the stress required for plastic flow to temperature, strain, and strain rate. There are, however, useful empirical

relationships that have been developed to correlate certain mechanical properties under complex loading conditions and to account for the effects of time and temperature on material strength. Examples include the relationships between plastic strain and cycle life in fatigue, crack growth rate as a function of applied stress intensity and time-temperature parameters for extrapolation and interpolation of creep and creep rupture data. These empirical laws must be used with caution and their evolution is highly dependent on a comprehensive data base.

3. Format for Data Presentation.

The format used controls the amount of information that will be used to characterize the material and test conditions of a particular data set. Problems arise here from the very large amount of information that is necessary to characterize the state of the material which is determined by many factors in its past history, and in some cases by the lack of a standard test procedure that defines the measured quantity. An example of such a format is shown in Figure 3 for fatigue data. This particular format was taken from a report by the Numerical Data Advisory Board (1980) and represents one used for computer input. Not all attributes would be necessary for each data set. Figure 4 shows one format used in a handbook to present the information necessary to characterize crack growth rate tests on an aluminum alloy. Ideally the information given should be sufficient to permit another investigator to repeat the experiments. Fortunately, the knowledge base in the form of test standards (such as those developed by the American Society for Testing and Materials) and long experience with handbook data presentation will permit a satisfactory solution to format development for computerized data bases.

4. Validation of the Data.

Data validation is perhaps the most formidable problem in data base development. By validation is meant the result of some judgmental process that establishes that a data set is suitable for its intended purpose. This judgment may or may not require a statistical analysis of the data set. The problems mentioned above directly impinge on this problem. Validation can be satisfactorily performed only by specialists who are familiar with both the basic character of the material and the methods used to obtain the data. For example, Figure 5 shows the fracture toughness of beryllium obtained by various investigators using different methods. Unless the examiner was familiar with the fact that the test methods themselves contributed to the scatter and that none of them were standardized, he would have no choice but to put all the data into the file. Another example where the knowledge of the specialist is needed concerns the use of inexpensive tests to derive the results of more elaborate and expensive tests through empirical correlation of their results. The need for such correlations has been described in a report of the National Materials Advisory Board (1976). As pointed out in this report, such correlations are useful but should be applied only when their limitations are understood. For example, the nominal strength of small bend specimens has been used to estimate the plane strain fracture toughness K_{IC} of high strength alloys which is determined by a much more complex procedure and requires larger specimens. As shown by Succop and Brown (1977), correlations of this type (e.g., Figure 6) have

MECHANICAL PROPERTIES DATA STORAGE FORM

RECORD NUMBER	<	>	FATIGUE		TEST TYPE	<TY>	PLAT I GLU E
TEST NUMBER	<TND>	[]	SPECIMEN NUMBER	<ND>	SERIES LABEL	<ID>	[]
SOURCE FIELD	<IP>	[]	[]	[]	[]	[]	[]
TEMPERATURE	<TE>	[]	(C°)	IRRADIATION DATA:			
ENVIRONMENT	<EN>	[]	EXPERIMENT NUMBER		<ED>	[]	[]
MATERIAL	<MA>	[]	REACTOR AND POSITION		<RP>	[]	[]
HEAT NUMBER	<HN>	[]	IRRADIATION TEMPERATURE		<IT>	[]	(C°)
ALLOY BASE	<AB>	[]	FLUENCE		<FL>	[]	(N/M ²)
PRODUCT FORM	<PF>	[]					
SPECIMEN DESC.	<SD>	[]					
HEAT TREATMENT	<HT>	[]					
COMMENTS	<CD>	[]					
ORIENTATION	<OR>	[]	STRESS CONCENTRATION		<KT>	[]	[]
MODE OF CONTROL	<MC>	[]	MAXIMUM TENSILE STRESS AT N _f /2		<TS>	[]	(MPA)
STRAIN RANGE	<ET>	[]	(%)	MAXIMUM COMPRESSIVE STRESS		<CS>	[] (MPA)
MEAN STRAIN		[]	(%)	ELASTIC STRAIN RANGE		<EL>	[] (%)
WAVE FORM	<WF>	[]	PLASTIC STRAIN RANGE		<EP>	[]	(%)
HOLD MODE	<HM>	[]	CYCLES TO 1ST DECREASE IN STRESS RANGE		<ND>	[]	[]
HOLD TIME	<TI>	[]	(HR)	CYCLES TO 5% RED. IN STRESS RANGE		<NS>	[]
RAMP STRAIN RATE	<SR>	[]	(%/S)	CYCLES TO FAILURE		<NF>	[]
FREQUENCY	<FO>	[]	(HZ)	CYCLES DISCONTINUED		<TD>	[]
POISSON'S RATIO	<PR>	[]	MAXIMUM STRESS RANGE		<SMO>	[]	(MPA)
			CYCLES TO MAXIMUM STRESS RANGE		<NMO>	[]	[]
			SATURATION STRESS RANGE		<ST>	[]	(MPA)
			CYCLES AT SATURATION STRESS RANGE		<NS>	[]	[]
			SATURATION STRESS AMP AT 0.1 HOLD TIME		<SH>	[]	(MPA)
			SATURATION MINIMUM STRESS AMPLITUDE		<RS>	[]	(MPA)
			TIME TO FAILURE		<RT>	[]	(HR)

FIGURE 3 An example of a format that might be used for computer storage of fatigue data (Numerical Data Advisory Board 1980).

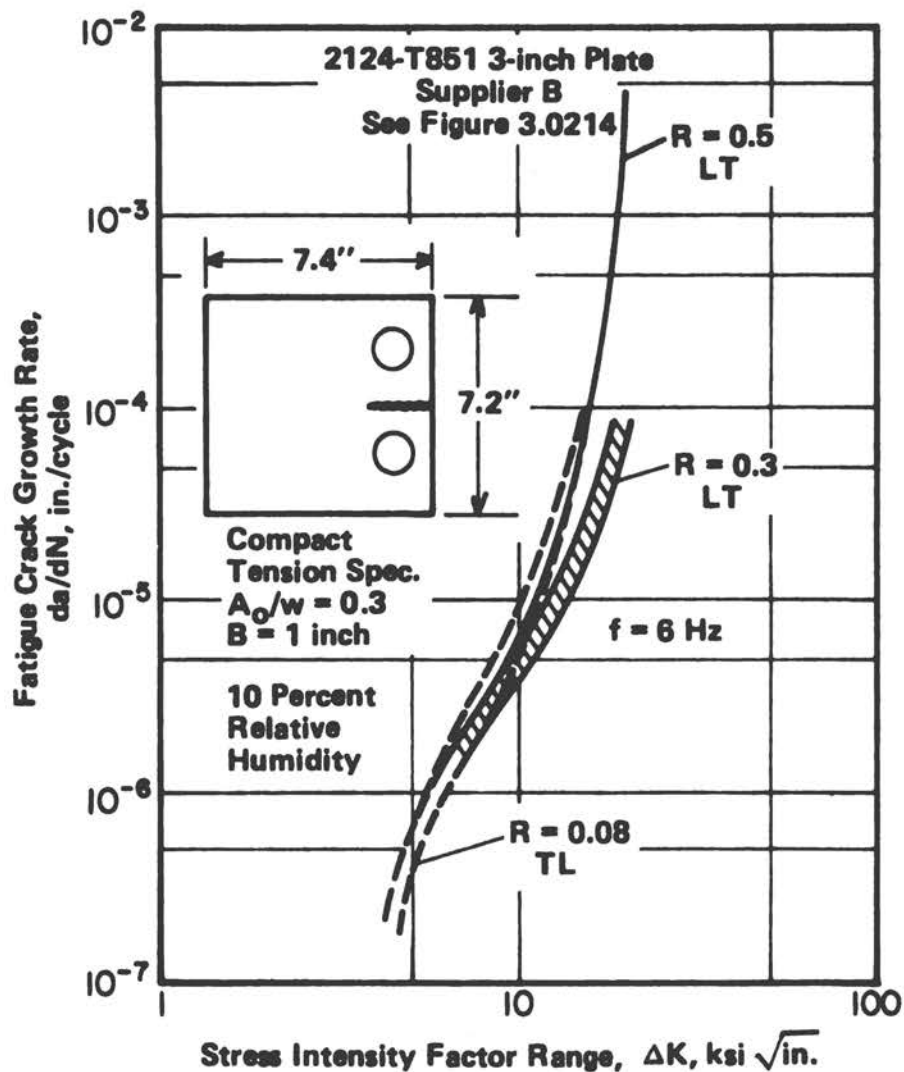
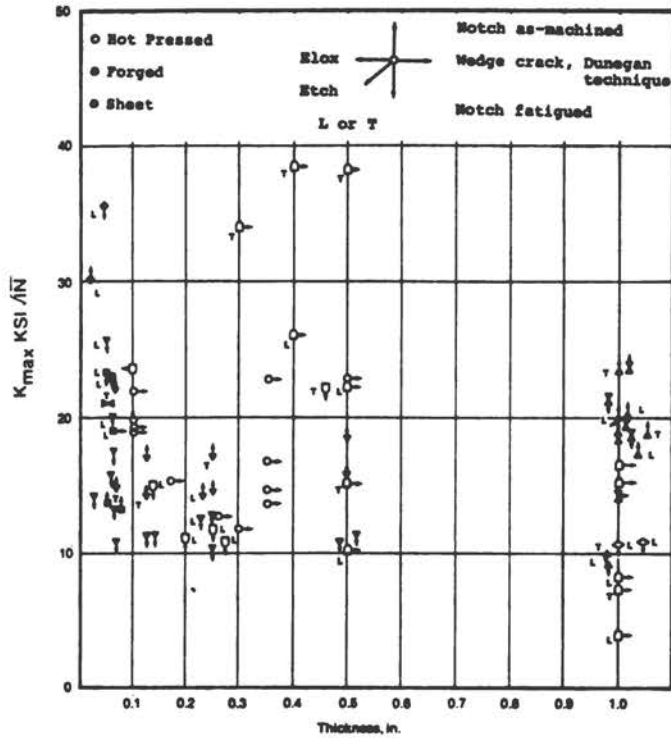

FIGURE 4 An example of the type and amount of information necessary to characterize the fatigue crack growth rates for an aluminum alloy (Metals and Ceramics Information Center 1982b).



- | | | |
|---|---------------------------|----------------------------------|
| □ | Brush Wellman Inc. [1, 5] | SEN-tension or bend test |
| | NASA-Lewis | max load data |
| ○ | Albertin [8] | SEN, CENTER NOTCH, or SURFACE |
| | (Boeing) | FLAW max load data |
| ◇ | Finn et al [9] | CENTER-NOTCH tension test |
| | (McDonnell) | max load data |
| ⊗ | Boeing-Battelle [4] | SEN-3 point bend, max load data |
| ○ | Harris and Dunegan [6] | SEN tension test |
| | (UCRL) | max load data |
| ○ | Ledman [7] | SEN-3 point bend |
| | (Sandia) | intercept data only |
| △ | Harrod et al [9] | WOL-tension test |
| | (Westinghouse) | max load data |
| ⊗ | Greene [10] | WOL-tension test |
| | (Lockheed) | max load data |
| ◇ | Kesterson [11] | WOL-COMPACT TENSION |
| | (Westinghouse) | max load data |
| ▽ | NASA-Lewis [18] | SEN-3 point bend, max load data |
| | | SEN-single edge notched specimen |
| | | WOL-wedge opening loading |

FIGURE 5 Fracture toughness of beryllium determined by various investigators methods and product forms, showing the large scatter that results (Conrad et al. 1973).

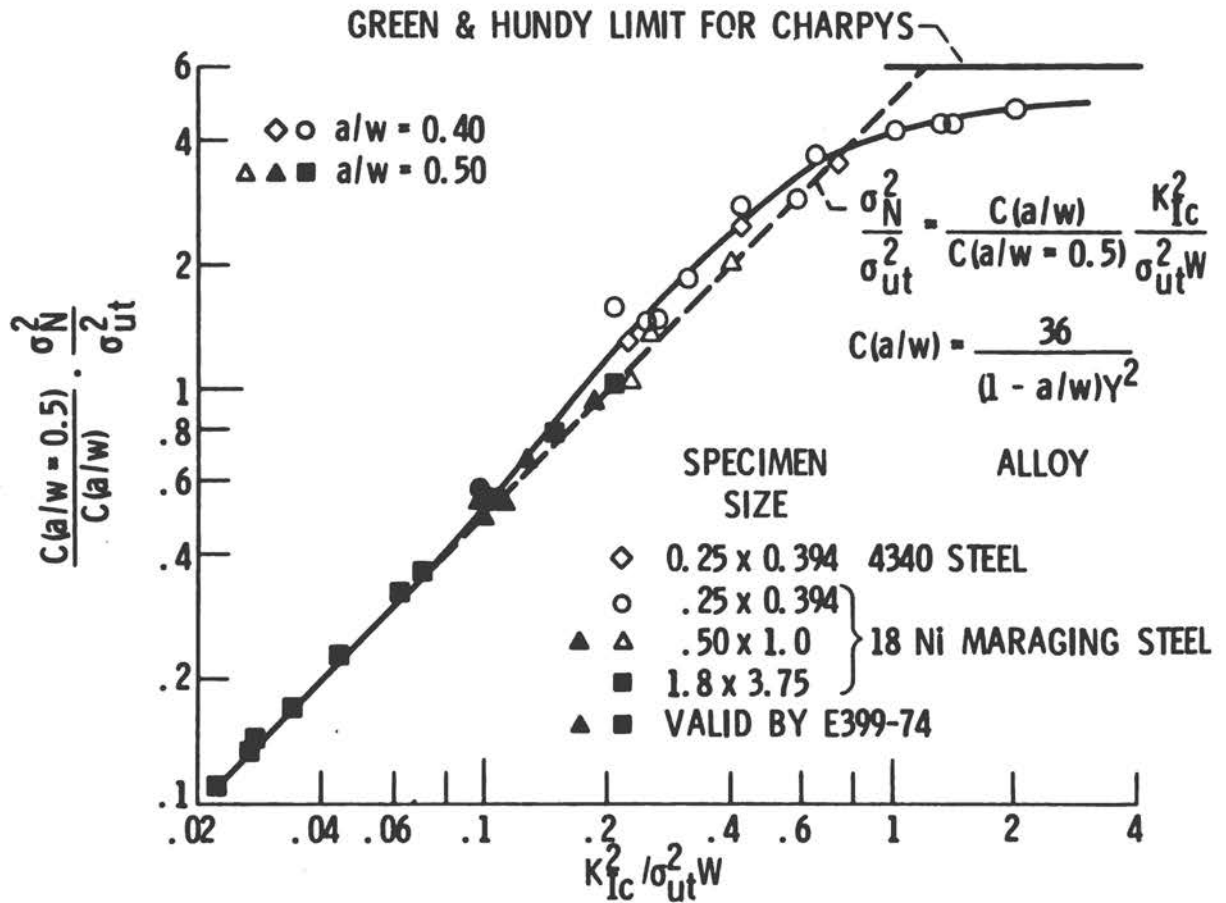

Figure 6 Examples of the limitations of using the nominal strength of small precracked bend specimens as an index of plane strain fracture toughness, K_{Ic} . The flattening of the curve at high values of bend strength (left ordinate) makes prediction of toughness unreliable (Socop and Brown 1977).

definite limitations as the toughness of the material increases. Thus, the bend strength loses sensitivity to changes in K_{IC} at high toughness levels. This is explained by the fact that the maximum load of the small specimens is determined by plastic instability rather than by cracking at sufficiently high toughness levels. Similar problems often are encountered when there is an attempt to substitute a simpler test for a more complex one.

Another problem associated with data validation is the inadvertent inclusion of duplicate data. Frequently data published initially by one investigator may be repeated in papers by other investigators and often in a somewhat modified form (e.g., by changing the units or forming ratios of the variables). In some cases the avoidance of duplication is one of the most difficult tasks faced by the materials specialist and may require his or her reading the entire document as well as examining some of its references.

PROBLEMS ASSOCIATED WITH MACHINE-READABLE DATA BASES

Problems primarily associated with machine-readable data bases focus on data base management systems (DBMSs) which consist of the software that permits the user to implement the physical data base in terms of his needs and with the computer system itself. These problems are discussed briefly here and in more fundamental terms in Appendix G.

Standardization of Language

The languages used to design DBMSs and the commands used to obtain information from existing systems are not standardized. As will be discussed later (Appendix G), this complicates the development of a decentralized computer system.

Selection of Data Models

Present DBMSs generally are based on the hierarchical data model* because it is efficiently implemented on large files with variable length records. However, a relational model* in combination with very high level languages (see Appendix H) would permit better implementation of the data base in solving engineering design problems by provision for unanticipated queries and automatic deductive reasoning. Such advanced DBMSs are as yet still under development.

Integrity of the Data Base

Special provision must be made to minimize the possibility of contaminating the data base with errors of entry (e.g., obviously wrong values, transposition of numbers). These errors are distinct from the introduction of invalid data, the prevention of which is the responsibility of the materials specialists. Errors of entry are more often encountered in the production of a computerized data base than in preparation of a handbook.

*For further information on data model terminology the reader is referred to C. J. Date, An Introduction to Database Systems, 2nd Ed., Addison Wesley, 1979.

Generally those persons entering data into the computer will not be familiar with expected trends in materials properties data or with the expected values. Furthermore, they will be working from tabular results that are relatively difficult to interpret in terms of expected trends. In contrast, handbook representations of data are frequently produced directly by the specialist in graphical form in which errors of entry are often readily seen.

The systems can be designed to help minimize errors of entry but will not completely eliminate them. For example, property values outside certain known limits could be flagged and files could be checked for duplication of data through source tracing. However, these safety features will complicate the design of the DBMS.

Timeliness of Data

Not all materials remain the same in terms of their properties even though their names may not change. For example, Ti-6Al-4V has the same basic composition that it had 15 years ago but improvements in melting and processing have resulted in beneficial changes in its mechanical properties. Thus, 15-year-old data on this alloy would not represent present production and should be excluded from the data base by a periodic purging procedure that would be the responsibility of the materials specialists. This provision for timeliness requires that data sets be identified as to source and date. This is not now normally done in computerized files. On the other hand, handbook data generally are referenced so that the user can make a judgement as to their timeliness.

Security of the Data Base

It is often important to restrict access to a portion or to all of the data base. Restricted access may refer to extracting of information or to modifying files. Methods that should provide adequate protection to materials properties data bases except in extreme cases are already developed (Ullman 1980). These methods depend on codes for user identification and on special query languages to define users' rights. It should be no more difficult to achieve the same level of security in a computerized data base system that is in general use than it is in a handbook containing the same information.

Protection Against Loss of Data

A variety of things can go wrong and cause a computer to "crash." Of particular concern are the physical or electrical events that cause loss of data. The only protection against such events is ensure that copies of the physical data base are stored in a safe place. As files are modified, a record of the modifications should be kept so that a crash will not result in loss of information necessary for operations subsequent to the crash.

PRODUCTION AND USE OF A MATERIALS PROPERTIES DATA BASE

A materials properties data base may exist in the form of hard copy (handbook), a machine-readable file, or a combination of both forms. What follows is a description of the steps necessary to produce a materials properties data base with emphasis on the role of the specialist and the services provided to the user. Traditionally, handbooks were the repository of a mechanical properties data base and most comprehensive data bases of this type still exist in handbook form. Because the steps in production of a handbook are well established and encompass those in the development of a computerized data base, the production of a handbook data base and its use will be considered first.

DATA BASE IN HANDBOOK FORM

The Aerospace Structural Metals Handbook is a fairly comprehensive data base of high-strength alloys, and it contains critically evaluated data and special precautions to be observed in the fabrication and application of a given alloy. The steps in its production are as follows:

1. Definition of need. A decision must be made as to whether a particular alloy should be added or whether an existing chapter needs up-dating. This decision requires a survey of the suppliers and the users of the alloy in question. This survey considers a number of factors including the criticality of the alloy application, the amount of material produced during the past several years, present production, recent changes in processing that might influence properties, and the budget for chapter production.
2. Definition of data sources. This is the only step in which modern computer technology is used, and the many on-line bibliographical retrieval services are invaluable in this respect. These services include the Metals and Ceramics Information Center (MCIC), the National

Technical Information Service (NTIS), and METADEX. For a widely used alloy these services may produce several hundred citations covering a five-year period. Unfortunately, no one service is comprehensive and duplicate references are unavoidable.

3. Data source selection. From the citations it is necessary to select the most appropriate sources. In some cases this selection process is aided by brief abstracts accompanying the citations. However, in most cases the chapter author is still left with about 80 to 90 percent of the citations which must be located and examined as potential references.
4. Source location. Location of the cited documents requires access to a good technical library and often the services of a reference librarian. Data appearing in the technical journals usually are not difficult to locate. Reports issued by the federal agencies, however, are frequently difficult to obtain in their original printed form either from the sponsoring agency or from its contractors. In most cases, copies can be obtained from Defense Technical Information Center (DTIC) but these copies may not always be legible in part or in whole. Because technical journals often are bulky and cannot be removed from the library, it is necessary to copy articles of potential interest.
5. Definition of References. It is not unusual to accumulate 75 to 100 documents on a metallic alloy that appear, on brief examination, to be potential reference sources. Some of these contain data on several alloys and each must be examined in detail to assess their value as reference sources for the handbook. At this point a problem frequently arises--namely, that insufficient information is given to properly identify the condition of the material. This is most often encountered in articles appearing in technical journals. For example, the author may state that tests were made on sheet of alloy X obtained from supplier Y. For the purposes of his investigation this may be an adequate description but it is of little help to one who is assembling data to be used by a designer. The only way to solve this problem is to contact the author and sometimes also the supplier. These contacts often are extremely time consuming.
6. Data Presentation and Analysis. Following the identification of reference documents, it is necessary to abstract the data for presentation in graphical or tabular form and to perform the analyses needed to identify special considerations of interest to the designer. These analyses may involve curve-fitting, cross-plotting, or statistical treatment of the data. These tasks often are complicated by the lack of tabular data. This deficiency is most often found in journal articles that use graphical displays, sometimes so small that enlargement is necessary in order to abstract the data.
7. Production of the Handbook. The publisher receives hand-drawn graphs and a hand-written or rough-typed version of text and tables. This manuscript copy then is used to produce ink tracings and typed versions of the tables and text. From these final copies a mock-up is made for the printer.

Of all the steps listed above, only steps 2, 4, and 7 can be assigned to a nonspecialist. Therefore, the specialist must spend a great deal of time on tasks that are tedious but necessary to the primary job of proper data validation, presentation, and analysis. Generally, well over 50 percent of the specialist's time will be spent on these peripheral tasks. Essentially the handbook is a data base that is produced in much the same way as a technical book or paper.

The user of a typical handbook data base can be faced with a time consuming and tedious task if his need is for comparisons of several properties of different alloys. This is especially true if different ranking schemes are used. Cross-plotting and replotting of the data often are necessary, and this is complicated by the fact that not all plots of the same properties are prepared using the same scale. Statistical analysis or curve-fitting requires that the data be abstracted from graphs or tables and entered into appropriate computer programs, and there is no way that data treated in this manner can be easily entered into the handbook for future use. Thus, the user, in effect, must provide his own data management system, and peripheral documents tend to develop from the handbook data base that contains specially treated information.

There are, however, certain advantages to handbook data bases. Communication with the data base is most friendly and initial user investment and maintenance costs are low. Reference sources can be identified easily and quickly and serve to establish the age of the data. An advantage to the author is that he does not have to anticipate the users' questions. Data relating to such things as heat treatment and special application precautions are easily located and referenced.

COMPUTERIZED DATA BASES

Generally, a computerized materials properties data base will be developed from a hierarchal data model, in which the numeric data file may be in the same form as a handbook arranged according to alloy, with the attributes of form, property, etc., being stored in random access memory. If the physical data file is dependent on conventional sources of information, the computer can have a direct role in production of the data base output only in step 6 above, which is concerned with the analysis and production of data displays. The need for the materials specialist is not reduced in any of the production steps although his work efficiency may be substantially increased by the use of peripheral equipment and programs that permit manipulation of the data sets and storage of these products in the computer. On the other hand, if the user can take a major role in establishing the data files, the task of the specialist is greatly reduced. Essentially he would be left with ensuring the timeliness of the information and with those tasks concerned with data analysis.

Once a central file has been established, a suitable data base management system must be developed. This is a critical step insofar as the user is concerned. Conceivably, the DBMS could be so arranged that its output would be a handbook, an on-line information source supplemented by a

handbook containing data that cannot be reduced to numerical form, or an on-line system containing all the information needed by a designer. Obviously, the user would benefit most from the latter two types.

An important key to user satisfaction is flexibility and friendly communication with the data base. If user needs are relatively constant in content and can be anticipated, menus can be created that permit the user to efficiently and easily retrieve required information (see Appendix E). An example of such a menu, which can be called up to provide statistically treated data, specifications, comparison plots for various alloys as a function of some variable, and cost information, is shown in Figure 7. One large aircraft engine manufacturer is in the process of transferring information from 14 handbooks to a computer data base that can be queried by such menus (see Appendix E).

A more flexible but less efficient DBMS is similar to that used for searching bibliographic data bases. Here the user obtains information by a process of elimination of data attributes. The output of such a system as to a query regarding tension data for a bar material with less than 20 percent chromium for test temperatures between 60 and 80°F is shown in Figure 8. The result for one material (item) of the 20 saved is shown in Figure 9. If it appeared from the result in Figure 9 that a material with 20 percent chromium would not be satisfactory, the data base could be searched again for alloy with other chromium content limits. These searches then could be continued until enough information had been obtained to permit a decision. This mode of data base operation generally provides the user with more information than he needs. With either of the above DBMSs the designer would be providing the deductive reasoning and generally would be using a separate computer for the design calculations. Neither of the above systems will permit efficient combination of different search strategies or will enter directly into the design process. However, a data base management system should be sufficiently flexible to accomplish both these tasks.

To be of maximum use in CAD and CAM, the data base should be capable of deductive reasoning. The computer should be able to treat its own programs and rules as data objects. In this respect, the data base is able to provide an "artificial intelligence." Rapid progress is being made in the development of programming languages that will greatly extend the power and efficiency of the DBMS. These languages will permit data files and rules to automatically answer unanticipated questions and to directly produce design decisions (see Appendix G). For example, an inquiry might be in this form: "Provide the minimum wall thickness, weight, and diameter for a spherical pressure vessel operating at 1000 psi, containing liquid hydrogen, and subjected to 100 zero-to-maximum pressures cycles with a frequency of one cycle per day. Specify alloy, welding procedures, cost per vessel, and expected safety margin based on a four life time requirement." Development of such a DBMS obviously will require close cooperation between computer specialists and those in the materials and design engineering fields. Although the use of computers in this mode is, at present, largely experimental, there are strong economic driving forces that will produce commercial applications within the next few years (Verity 1982). Obviously, this mode of computer operation will require an exceptionally well-established materials data base.

```
*****  
*  
* 1. PLOT AVG & 95/99 CURVES FOR ONE CURVE # *  
* 2. TABLE OF DATA POINTS *  
* 3. READ CURVES -- POINT PAIRS *  
* 4. MATERIAL COST PER POUND *  
* 5. COMPLETE MATERIAL SPECIFICATION *  
* 6. SUMMARY OF MATERIAL SPECIFICATION *  
* 7. OVERLAY PLOTS *  
* 8. PLOT OFFICAL REDBOOK PAGE *  
* 9. CHANGE CURRENT KEYSTRING (CURVE NUMBER) *  
* 10. PRINT ALL KEYSTRINGS (CURVE NOS.) DEFINED *  
* 11. TERMINATE REDBOOK DATA FUNCTION *  
*  
*****  
=
```

FIGURE 7 Example of a menu that can be called up from a computerized file to provide statistically treated data and other information useful to the designer of aircraft turbine engines (see Appendix E also).

SEARCH EXAMPLE-1

ENTER YOUR REQUEST

1/TT: TENSION
200 ITEMS SAVED AS SET 1

2/FM: BAR
150 ITEMS SAVED AS SET 2

3/CR 0.0/20.0
75 ITEMS SAVED AS SET 3

4/(1 AND 2 AND 3)
50 ITEMS SAVED AS SET 2

5/TMP 60/80
40 ITEMS SAVED AS SET 5

6/(4 AND 5)
20 ITEMS SAVED AS SET 6

FIGURE 8 Examples of output from a DBMS that produces information by the elimination of data attributes. The query in this case is to retrieve tension data for a bar material with less than 20 percent chromium for test temperatures between 60 and 80°F (Mindlin 1981).

MPDC DOCUMENT NO.: 241499

NAME: 6419 FORM: BAR-ROUND, 1.875 IN
DIAMETER

DOCUMENT: 1635

ELEMENT WEIGHT %: NI: ;CR:18.0 ;CO:14.8 ;TI:4.88 ;MO:3.1 ;AL:2.5 ;
W:1.47 ;FE:0.14 ;MN:0.1 ;C:0.07 ;SI:0.10 ;B:-.018 ;
ZR:0.04 ;S:-.003 ;

PROCESSING INFORMATION

PRIMARY OPERATION: WROUGHT, FORGED
THICKNESS: DENSITY: 0.292

SPECIMEN DATA

NOTCH CONFIGURATION: STRESS CONC FACTOR: 1.0
SPECIMEN CONFIGURATION: ROUND SPEC, LG OF RED. SECT 2.500 IN.

HEAT TREATMENT

TYPE	TEMP, HOURS, MEDIUM, REMARKS
MULTIPLE AGE	2150 , 4.0 ,,AIR COOLED TO ROOM TEMPERATURE
	1975 , 4.0 ,,AIR COLLED TO ROOM TEMPERATURE
	1550 , 24.0 ,,AIR COOLED TO ROOM TEMPERATURE
	1400 , 16.0 ,,AIR COOLED TO ROOM TEMPERATURE

NOTES: PRE-HEAT - SOLUTION TREATMENT - COOL OR QUENCH TO
ROOM TEMP

TEST DATA

TEST TYPE: TENSION TEMP: 79.9 - DEG. F THICKNESS: 0.500
GAGE: 2 TEST RATE: 0.005 INCH/INCH/MIN. IN THE ELASTIC
REGION. AFTER YIELD THE HEAD SPEED WAS
INCREASED TO 0.1 INCH/MIN. FAILURE.ORIENTATION: LONGITUDINAL ENVIRONMENT:
FAILURE DESCRIPTION:

UTS	YS	ME(*)	EL	RA	PR	HRD(**)
177.000	138.000 - 0.2%	30.900	7.20	7.00		
178.000	139.000 - 0.2%	27.900	7.70	9.60		
178.000	137.000 - 0.2%	28.900	6.70	9.50		

ENTER REPORT DIRECTIVE

FIGURE 9 Complete computer output for one alloy resulting from the query
illustrated in Figure 8 (Mindlin 1981).

A NATIONAL MATERIALS PROPERTIES DATA NETWORK

As indicated earlier, the committee believes that both federal agencies and private industry would benefit from access to a computerized materials data base that contained valid materials properties data including test data derived from presumably repeatable measurements on a material body or physical system and data that cannot be reduced to numerical form. These benefits would include stimulation of innovative design, decreased design costs, and increased component reliability, and, as a result, the U.S. position in the international markets would improve.

The sponsors of this study are not the only groups to recognize this situation. In November 1982, an "On-line Materials Data Workshop" was held in Crossville, Tennessee. Its sponsors were the National Bureau of Standards, the Numerical Data Advisory Board, CODATA, the Federal Republic of Germany, Oak Ridge National Laboratory, and John Wiley and Sons, Inc. The report on this workshop has not yet been issued, but the general consensus can be summarized as follows:

1. Computer access to engineering properties of materials does not now exist in any comprehensive way, and it is badly needed.
2. There is no significant technical barrier to establishing the needed system. What is most needed is funding and an organizational structure that can integrate the disparate needs of the purveyors and users of information. Of lesser concern are problems that will need immediate and continuing attention, including data validation, format, interfacing data with the computer system, and training of operators.

The workshop participants endorsed existing cooperative work now under way by the Metal Properties Council and CODATA. In addition, they suggested that the National Academy of Engineering should examine the findings of the workshop and possibly establish an "interim council" to: (1) define the tasks necessary to set up a comprehensive computerized material property information system, (2) identify the permanent leadership body or new

institution to manage and operate the recommended system, (3) seek the cooperation and participation of all "stakeholder" groups, and (4) involve international groups to the extent feasible and appropriate.

What follows is a brief review of the decisions that must be made when one considers the organization and workings of a national materials data base network. Further details are given in Appendix G.

The data model used with the data base management system may take one of three different forms: hierarchical, network, or relational. For very large files, the most efficient system would probably correspond to a hierarchical organization. However, once information was abstracted from a central file it might be stored in the user's computer in whatever mode would best suit his needs. Ideally, the central file would contain valid raw data for all material property attributes. Thus, stress-strain data would be retrievable in a form that would permit the construction of tangent modulus curves at the user's station. The computer system itself might be: (1) centralized, with all processing and data storage taking place in one location and the system depending primarily on a single brand of equipment; (2) distributed, which involves a collection of geographically dispersed computers that would communicate data and use common software; and (3) decentralized, which involves a collection of geographically dispersed independent and different computer systems that do not communicate. The advantages and disadvantages of each of these arrangements is described in Appendix G. The decentralized system has one very important advantage in that it makes use of computer systems already in place at the site of the users and circumvents the problems associated with incompatibility of hardware and software. However, such a system leads to problems associated with data storage on some transportable medium such as disk or tape. These problems appear to be of a lesser magnitude than those associated with the other two systems.

It would be advantageous, as discussed previously, if the users could contribute information to the central file. The possibility for success in doing this will be increased by the development of a standard materials data format, the use of the SAE-ASTM unified numbering system for metals and alloys (Society of Automotive Engineers 1977) and the acceptance of only data that has been obtained using ASTM standard test methods or other widely recognized test standards. The language used in the data base management system will depend on the complexity of the users' inquiries. FORTRAN is a commonly used language in data base systems and probably would be sufficient for most purposes, but the users' systems may not operate with FORTRAN and this could present a problem in communication. It appears, however, that such problems could be solved. Ultimately, the language should be sufficiently rich and friendly that it would permit the use of the data base in a deductive reasoning mode (see Appendix H).

The basic requirements of a decentralized national materials data bank network may be summarized as follows:

1. The system should be accessible by any of the major computer hardware devices manufactured in the United States.

2. The system should make maximum use of the computer storage and computational power now existing in the users' organizations as well as those in the DOD Information Analysis Centers and other material data bases.
3. The configuration of the system should encourage participation by American industry, both as users and as contributors of data, while maintaining a built-in security system that would protect information of a proprietary nature.
4. A data base management system should be established that would permit the answering of unanticipated questions.

A possible configuration of such a national computerized materials data base network is shown in Figure 10. It involves the interconnection of existing computer systems located in industrial, university, and governmental establishments. The nerve center of the network includes a mainframe computer system; data and analysis peripherals; and a staff of computer technicians, materials specialists, and data analysts. Although the facility housing the nerve center would formally be identified as the National Data Base, it primarily would be the monitor of the data base that would be housed mainly in the participants' computers. Thus, the role of the nerve center and its staff would be to provide the following essential functions:

1. Maintain a directory of materials and their properties that would be available throughout the network.
2. Establish guidelines and procedures for the exchange of materials properties between participants. This function would include standards for validation of data.
3. Procure and/or develop the computer hardware and software required to permit communications between the nerve center and all major computer systems tying into the data base system. This would include the capabilities of numerical and graphics communications.
4. Maintain a staff of materials specialists and data analysts to develop data analysis software and display programs. They would provide a data analysis service to participants requesting it. Raw data in a standardized format would be transferred to participants who wished to do their own analysis.

A National Materials Properties Data Network such as that described above will provide the following valuable services to those who are concerned with materials selection, structural design, and materials research:

1. A source of carefully evaluated data on a wide variety of materials used in industry, which would increase design efficiency and product reliability.
2. A means for rapid transfer of new data to potential users and a method for efficiently up-dating materials properties files.

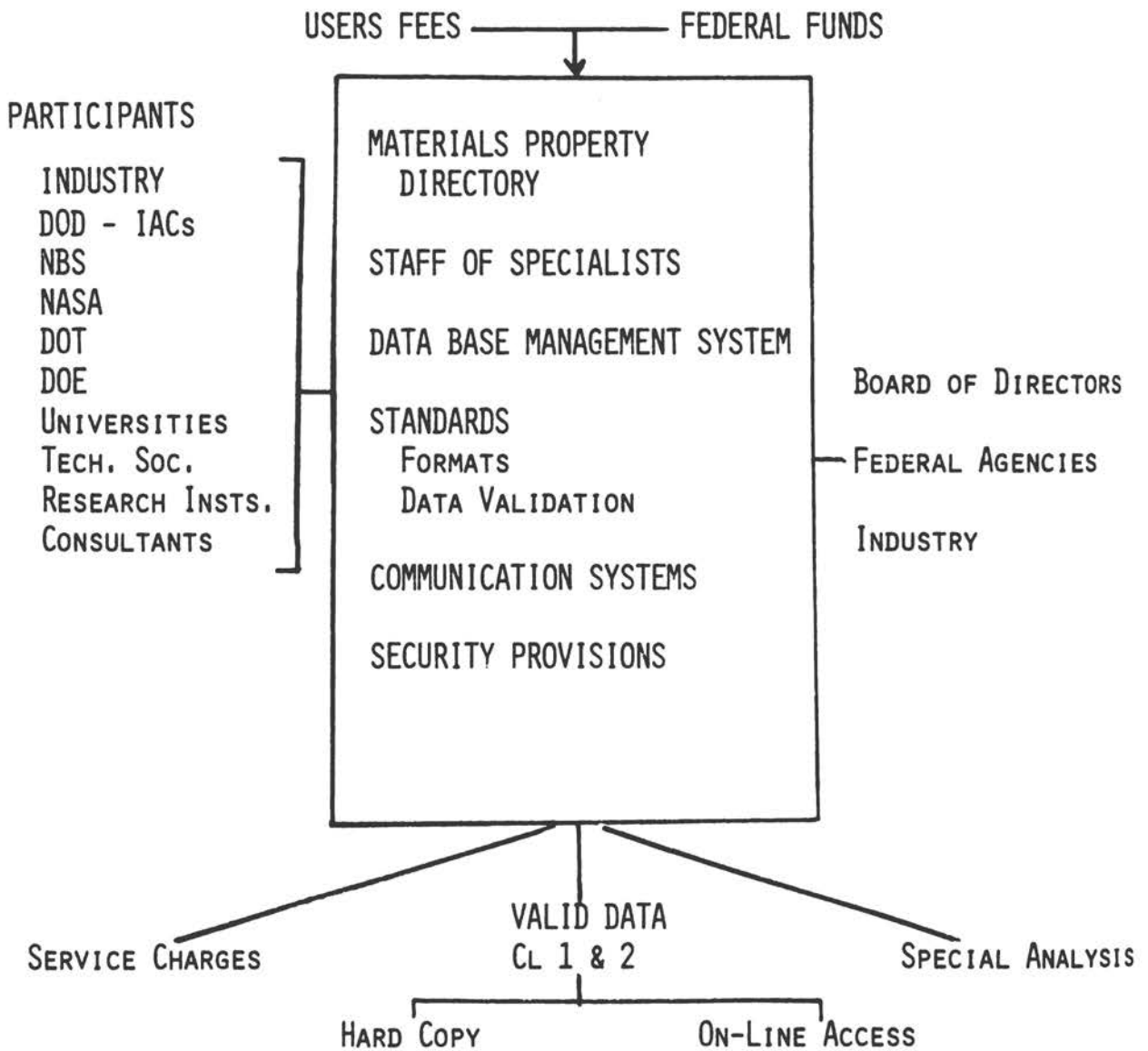

FIGURE 10 Example of a decentralized national materials properties data base network.

3. Ready access to design data and materials specifications, which would reduce duplication of data generation.
4. Access for smaller industries to a large data source that would not otherwise be available to them.
5. A focus for international cooperation in sharing of the materials properties data resource.

REFERENCES

- Alvey Committee. 1982. A Program for Advanced Information Technology: The Report of the Alvey Committee, HMSO. United Kingdom: Department of Industry.
- Appoo, P. M. 1981. A computerized data materials data base for an automotive manufacturer. In Data for Science and Technology, pp. 231-249, edited by P. S. Glazer. New York, New York: Pergamon Press.
- Brown, G. E., Jr. 1981. Information Issues Confronting the Congress, p. 31-5. ASIS Bulletin. Washington, D.C.: American Society for Information Sciences.
- Buzbee, B. L., R. H. Ewald, and W. J. Worlton. 1982. Japanese supercomputer technology. Science 218:1189.
- Commission of the European Communities. 1981. Annual Report of the Joint Research Centre Petten Establishment, pp. 36-8. The Netherlands: Petten Establishment.
- Conrad, H., J. Hurd, and D. Woodward. 1973. Fracture toughness of beryllium. Journal of Testing and Evaluation 17:1189.
- Defense Logistics Agency. 1981. Information Analysis Centers Profiles for Specialized Technical Information. Alexandria, Virginia: Defense Technical Information Center.
- Ferguson, R. R. and R. C. Berryman. 1976. Fracture Mechanics Evaluation of B-1 Materials, Report AFML-TR-76-137, Vol. 1 and 2. Wright-Patterson Air Force Base, Ohio: Air Force Wright Aeronautical Laboratory.
- Galliart, D. R., S. D. Downing, and H. D. Berns. 1979. Computer based material properties - an effective link to reliable products. Closed Loop. Minneapolis, Minnesota: MTS Systems Corporation.
- Hampel, V. E. 1981. Fact Retrieval for the 1980s, Report UCRL-85749. Livermore, California: Lawrence Livermore Laboratory.
- Hampel, V. E., J. B. Cain, R. A. Kawin, G. Pavel, N. A. Lann, G. T. Richards, and W. S. Scott. 1982. TIS - A Focal Point for Technology Transfer, Report UCRL-53342. Livermore, California: Lawrence Livermore Laboratory.
- Harrison, I., Jr., V. E. Hampel, and R. A. Kawin. 1982. Downloading and Post Processing of Bibliographic Information with the TIS Intelligent Gateway Computer, Report UCRL-88119. Livermore, California: Lawrence Livermore Laboratory.
- Lide, D. R., Jr. 1981. Critical data for critical needs. Science 212:1343-49.
- Metals and Ceramics Information Center. 1982a. Aerospace Structural Metals Handbook, Alloy Code 1216. Columbus, Ohio: Battelle-Columbus Laboratories.

- Metals and Ceramics Information Center. 1982b. Aerospace Structural Metals Hand Book, Alloy Code 3221. Columbus, Ohio: Battelle-Columbus Laboratories.
- Mindlin, H. 1981. Information Analysis Centers and Substitution Technology. Paper presented at the Workshop on Conservation and Substitution Technology for Critical Materials, Vanderbilt University, Nashville, Tennessee, June 15-17, 1981.
- National Materials Advisory Board. 1976. Rapid Inexpensive Tests for Determining Fracture Toughness. Washington, D.C.: National Academy Press.
- Numerical Data Advisory Board. 1978. National Needs for Critically Evaluated Physical and Chemical Data. Washington, D.C.: National Academy Press.
- Numerical Data Advisory Board. 1980. Mechanical Properties Data for Metals and Alloys: Status of Data Reporting, Collecting, Appraising, and Disseminating. Washington, D.C.: National Academy Press.
- Society of Automotive Engineers. 1977. Unified Numbering System for Metals and Alloys, SAE HS1086A and ASTM DS-56A. Warrendale, Pennsylvania: Society of Automotive Engineers.
- Succop, G. and W. F. Brown, Jr. 1977. Estimation of K_{IC} from slow bend precracked charpy specimen strength ratios. ASTM STP 632. W. F. Brown, Jr. and J. G. Kaufman, eds. Philadelphia, Pennsylvania: American Society for Testing and Materials.
- Ullman, J. D. 1980. Principles of Data Base Systems. Rockville, Maryland: Computer Science Press.
- Verity, J. W. 1982. Learning to LISP. Datamation November:70-4.
- Westbrook, J. H. 1982a. Feasibility Study of an Intersociety Computer Based Materials Properties Data System. Six Month Progress Report. New York, New York: Metal Properties Council.
- Westbrook, J. H. 1982b. Machine Readable Files of Engineering Data on Materials. Paper presented at the Materials Data Workshop, Fairfield Glade, Tennessee, November 7-11, 1982.
- Westbrook, J. H. and J. D. Desai. 1978. Data sources for materials scientists and engineers. Annual Review of Materials Sciences 8:359-422.

Appendix A

EXAMPLES OF THE COSTS OF HARDWARE FAILURE AND OF SAVING MATERIALS PROPERTIES DATA

This appendix will present some examples of the enormous costs of hardware failures that occur either because the required materials properties data were not available or because the data were not readily accessible to the designer. It also will be shown that the cost of saving materials properties data is far less than the cost of data generation. The following information on failure costs is taken from an October 1971 NASA report entitled "NASA Research and Technology Advisory Committee on Materials and Structures--Ad Hoc Panel on Fracture Control." The five examples presented below add up to at least \$1.8 billion. Such a list cannot be considered complete because failure costs often are treated as sensitive information or are not well documented due to the press of schedules.

1. F-111. The use of high-strength, relatively low-toughness, flaw-sensitive steel for the monolithic carrythrough structure in this Air Force fighter plane resulted in failures that led to additional program delays and costs of \$150 to \$195 million.
2. NASA 260 Inch Motor. The use of improper welding processes and inadequate nondestructive test methods resulted in a hydrotest failure of this solid propellant motor case with a loss of \$17 million.
3. NASA SPS Tank. The presence of machine tool marks combined with an unexpectedly aggressive influence of methanol on 6Al-4V-Ti resulted in the catastrophic failure of the Apollo Service Propulsion Module No. 17 and a loss of \$10 million.
4. NASA LM Tanks. Undetected, subsurface metallurgical defects in titanium lunar module propulsion system tanks, stress corrosion in the aluminum tank covers, combined with inadequate welding techniques and inspection methods resulted in failures that cost \$4.7 million.
5. Military Aircraft. A comprehensive study of various military aircraft reveals that between 1962-1970, 1 percent of all noncombat fighter losses were caused by the unexpected failure of a primary structure. Considering both bombers and tankers, during this period, there were 42

wing failures and 16 fuselage/tail failures, some of which resulted in the loss of the entire aircraft. Another view of the problem is reflected by the fact that the USAF has had 16 major structural crises on 15 aircraft types in recent years with catastrophic failures occurring in 10 of the aircraft. Twelve of these crises occurred in the past five years. The cost of these failures, plus the required correction, is beyond accurate estimating abilities but cannot be below \$1 billion.

It is interesting to note that the NASA 260-inch diameter motor case was fabricated from 250 grade maraging steel, which was a relatively new material, but a data base was available in the Aerospace Structural Metals Handbook for that steel. The failure resulted from improper welding procedures that were identified as unsuitable in the handbook. The total cost of placing the information on 250 grade maraging steel in the handbook was \$3,000 in 1964 or about 0.2 percent of the loss.

Under the heading of "Collection and Dissemination of Data," the previously referenced NASA report concludes:

Failure experience within the aerospace industry has shown that the technology necessary to prevent many of the failures during the last decade was available but had not been incorporated into adequate failure prevention efforts. Collection and dissemination techniques on fracture information and data are lacking in that pertinent information is not reaching the aerospace structures contractors. Currently, there are general data dissemination activities (government agencies' technical reports, technical society reports and publications, and DOD material data information centers) which include fracture information along with other data, but these agencies have proven to be inadequate to disseminate the information on a timely basis to the ultimate user, the contracted structural designer. Lack of communication within and between government agencies and industrial contractors has prevented the development of unified fracture control practices; the sharing of timely, costly materials data; and often has resulted in duplication of effort. Future demands for improved fracture control coupled with higher performance vehicles make rapid dissemination of information even more critical.

Recommendations under this heading are as follows:

1. As part of its overall fracture control program, NASA should establish a fracture control information center which will emphasize the aspects of fracture control information and data which are not emphasized by existing government and society functions. Specifically, this information center would:

- a. Collect all reports and documents related to fracture control including crack propagation data, fracture toughness data, methods for testing, flaw tolerance analysis, nondestructive test methods, and structural failures.
- b. Publish a periodical acquisition list containing appropriate title and author information and a verbatim abstract extracted from the document.
- c. Provide a suitable computerized materials fracture data retrieval system, coded to allow data searches to be made from a broad family of key indicators such as alloy identity, crack propagation, K_{IC} , analysis methods, NDT, and etc.
- d. Provide the facilities for the reproduction and distribution of full copies of original documents to all government agencies and their contractors upon request.

It is recommended that this program be coordinated with all DOD agencies to ensure that data generated in contracted design programs are made available rapidly.

2. Through its role in the fracture information data function, NASA should encourage the free flow of fracture information on failure prevention procedures and materials data. This could be accomplished by freely disseminating reports and conducting periodic technology symposiums held at the NASA Fracture Information Data Center.

These recommendations were not implemented by either NASA or the DOD.

It is seldom possible to compare the cost of generating materials properties data with the cost of placing the data in a handbook or computer file because data sources for a single engineering material are so varied and often no attempt is made to separate the cost of data generation from the overall cost of a hardware program. However, one clear example does exist: the development of the steel alloy AF 1410 which was funded by the Air Force as a possible substitute for titanium. The program included four organizations with a total cost to the Air Force of about \$2 million. It was quite a successful development involving the establishment of proper melting practices, forging techniques, and welding procedures. During the program, a large amount of well characterized mechanical and physical properties data was generated. These data, as well as general information on melting practices and joining procedures, were gathered, analyzed, and published in a chapter of the Aerospace Structural Metals Handbook for a total cost of about \$10,000 or about 0.5 percent of the contract cost.

Appendix B

SITUATION WITHIN THE DOD CONCERNING THE ACCUMULATION AND STORAGE OF MATERIALS PROPERTIES DATA ORIGINATING FROM SYSTEMS PROGRAMS

Data requirements for major contracts are controlled by MIL-D-8706 (Attachment 1). Structural design, test data, and analysis are in accordance with MIL-D-8868 (Attachment 2) and MIL-D-8870. The Navy basically follows MIL-D-8706 as written and requires the contractor to submit a report describing the materials research plan (not data). The Air Force usually expands the MIL-D-8868 requirements in the specific system contract document and requires a report containing actual test data.

Attachment 3 is a copy of such an Air Force data requirement from the F-15 contract. Distribution of the required reports is very limited, and only three copies were required in this case. In addition, these reports often are restricted to government use only. Even when the report is printed and released, it may not always be generally available. Only two cases where a wide distribution was or will be made are known to the committee. In the case of the B-1, the Materials Laboratory funded an effort to publish and distribute the B-1 report, (Attachment 4 - abstract) primarily because it was the first large development of fracture mechanics data (1764 tests). The test data used to develop allowables for 7175-T73 large extrusions from the C-5 modification program are being distributed through MIL-HDBK-5.

In summary, there is not only no requirement to put weapons system development data in the DOD data centers, but also there is no specific requirement for a data-containing report. This is left to the judgment of the contracting office. There is a DOD requirement for a documented test plan. Concerns expressed to our AF liaison representative by several contracting offices contacted involving the release of such data included its proprietary nature, the export control act, the cost of preparing appropriate reports (even if limited to data centers only), and the added work for the same contractor personnel who are directly involved in the weapon system contract itself.

ATTACHMENT 1

MIL-D-8706B(AS)

3.5.25 MATERIALS AND PROCESSES DEVELOPMENT AND EVALUATION REPORT. - The contractor shall submit a summary technical report describing materials and processes research, development and evaluation work which has been conducted or is planned under the contract, or alternatively, shall submit a statement that no work of this type has been conducted or is contemplated.

(1) RADIO ACTIVE MATERIALS. - If a component containing a radioactive element requiring AEC licensing is used in the aircraft, ASO shall be notified of the need for a license. Notification shall be made as soon as the design has been sufficiently defined to permit licensing.

3.5.26 PHOTOGRAPHS. - Photographs shall be 8" by 10" and shall be furnished as follows: The complete aircraft showing the maximum amount of detail in not less than six positions as follows: forward, rear, port, starboard, three-quarter front, and three-quarter rear with wheel type and/or float-type alighting gears.

3.5.27 ENGINEERING DRAWINGS

3.5.27.1 PREPARATION OF ENGINEERING DRAWINGS. - Engineering drawings and documents referenced on them shall be prepared, completely describing the equipment articles to be delivered under the contract, excepting Government-furnished components. The term "equipment articles" includes all contractor-furnished design-engineered material articles; the contract end-articles, contractor-furnished components and parts, contractor-furnished support equipment, and spares and repair parts. Drawings and associated data shall be prepared in accordance with Spec MIL-D-1000/1 and shall contain information sufficient for the intended use categories specified in addenda to this specification. Applicable drawings previously prepared for other applications but meeting the above requirements shall not be redrawn for this application. Drawings shall be prepared and/or revised to reflect Class I design changes (as defined in ANA Bulletin 445 or superceding document), and CAO-designated Class II design changes, in sufficient time to permit delivery of microfilm copies at least 30 days prior to delivery of the first equipment article affected by the change. They shall be revised to reflect all other Class II changes (a) when a maximum of five such changes per drawing is reached, or (b) within 30 days following delivery of the last article in the production block to which the drawings apply, whichever occurs first.

3.5.27.2 REPRODUCIBLE COPIES OF ENGINEERING DRAWINGS. - One microfilm copy, accompanied by tabulating cards, of each of the above engineering drawings and of non-Government documents referenced on them shall be furnished. It shall be camera-negative roll microfilm, accompanied by Frame Deck and Data Deck tabulating cards, all conforming to Spec MIL-M-38761/1. If the contractor prefers, microfilm

mounted in aperture cards may be furnished in lieu of roll film and Frame Deck cards provided this is done at no more cost to the government than roll film and Frame Deck cards. Specifics shall be arranged with the Naval Air Technical Services Facility (NAVAIRTECHSERVFAC) (Code ED).

ATTACHMENT 2

MIL-A-8868A

- (i) A plan of inspection and repair maintenance.
- (j) A description of unusual sonic fatigue failures that may be of significance to the structural integrity of the aircraft.
- (k) A description of the anticipated service life of the aircraft on the basis of work performed in the prototype proof test, accounting for the scatter that is a characteristic of sonic fatigue tests.

3.10.5

Material substantiating data and analyses report -

This report shall include data and analyses to substantiate the use of material property values from sources other than MIL-HDBK-5 and MIL-HDBK-23, as specified in MIL-A-8860, and to substantiate compliance with applicable design requirements. The data shall be presented in a manner similar to the presentation in MIL-HDBK-5.

3.10.5.1

Fibrous composites -

- (a) Mechanical properties - Minimum mechanical properties for use as structural design allowables shall be furnished for fibrous composites. Such properties shall be for room temperature conditions, and for all combinations of fiber and stress directions determined as critical for the intended operating environment. As a minimum the following mechanical properties shall be included:
 - (1) Tensile ultimate strength-longitudinal (0°) and transverse (90°) including attendant elongation.
 - (2) Tensile yield strength-longitudinal and transverse.
 - (3) Compressive ultimate strength-longitudinal and transverse including attendant deformation.
 - (4) Compressive yield strength-longitudinal and transverse.
 - (5) Shear ultimate strength-membrane and interlaminar.
 - (6) Core shear strength.

CONTRACT DATA REQUIREMENTS LIST									
ATCH NR _____ TO EXHIBIT <u>A</u>			CATEGORY <u>S/SYS. ANAL.</u>				SYSTEM/ITEM <u>1</u>		
TO CONTRACT/PR <u>F33657-70-C-0300</u>							CONTRACTOR <u>MCAIR</u>		
1. SEQUENCE NUMBER	2. TITLE OR DESCRIPTION OF DATA	3. SUBTITLE	4. TECHNICAL OFFICE			10. FREQUENCY	12. DATE OF 1ST SUBMISSION	14. DISTRIBUTION AND ADDRESSEES (Addresses - Regular Copies/Repro Copies)	
5. AUTHORITY (Data Item Number)	3. CONTRACT REFERENCE		7. DD200 REQ	8. (A)	9. (R)	11. AS OF DATE	13. DATE OF SUBSEQUENT SUBM/EVENT ID		
A161AA	Structural Materials Utilization Document		YFEFF			ONE/R	See 16	YFEFF	1/0
S-J.25/M	SEMP. App. C		LT	N		NA	See 16	ATTN/LAA	1/0
16. REMARKS									
Initial submission shall be 90 days prior to first flight with content and format consistent with attachment. A revised document shall be submitted 60 days prior to first production delivery. See Attachment #1.0A to DD 1423 for preparation instructions.									
Not applicable to FY 75									
Contract Copy Baseline: 2/0									
PREPARED BY			DATE			APPROVED BY			DATE
									MAY 21 1975
								15. TOTAL 3/0	

ATTACHMENT 3

47

ATTACHMENT 3 (cont.)

Attachment #40A to DD 1423 (S-125/M)
Structural Materials Utilization Document

1. The contractor shall prepare a detail list covering the application of materials in the primary structure of the airframe including landing gear. This list shall include as a minimum the following:
 - a. Material form and condition
 - b. Description of part or part function
 - c. Part or drawing number
 - d. Part location in air vehicle

2. The materials list shall be supplemented by the following information:
 - a. Materials characteristics and background information supporting the selection of the materials.

 - b. Special precautions or processes required for insuring satisfactory performance of any parts fabricated out of magnesium or beryllium or any parts of high criticality.

3. The resulting document(s) shall be prepared in a format consistent with MIL-STD-847 except that the title page, bibliography and alphabetical index shall be deleted. The document(s) shall be sectionized into the following material categories:
 - a. Aluminum
 - b. Beryllium
 - c. Magnesium
 - d. Titanium
 - e. High Strength Steels (180 ksi or greater)
 - f. Heat Resistant (Super) Alloys
 - g. Advanced Composites
 - h. Glass Reinforced Plastics

ATTACHMENT 4 (cont.)

UNCLASSIFIEDSECURITY CLASSIFICATION OF THIS PAGE(When Data Entered)

of welds in Ti-6Al-4V, PH13-8Mo and 9-4-.20 alloys and of diffusion bonds in Ti-6Al-4V were determined. Testing variables were temperature, specimen thickness, environment, cyclic frequency and R factor for the da/dN tests; temperature and specimen thickness for the K_C tests; temperature for the K_{Ic} tests; and environment for the K_{Isc} tests.

The results of the tests are presented in tables and graphs in detailed and summarized forms. The effects of the various material and testing variables on fracture behavior are discussed.

UNCLASSIFIEDSECURITY CLASSIFICATION OF THIS PAGE(When Data Entered)

Appendix C

SITUATION WITHIN NASA CONCERNING THE ACCUMULATION AND STORAGE OF MATERIALS PROPERTIES DATA ORIGINATING FROM SYSTEMS PROGRAMS

NASA does not maintain machine-readable files containing materials properties data derived from its own programs or other sources. However, certain special files that relate to material performance are maintained. NASA Johnson contracts with Rockwell to maintain a file called MATCO (Material Control) specifically for the Orbiter. Essentially, what MATCO does is to provide the designer and fabricator with information relating to the conditions under which a particular material may be used. NASA specifications for the Orbiter require the use of "approved materials" and a NASA contractor will use MATCO to determine whether or not his choice of material is approved for the stress and environmental conditions that characterize the application. For example, he may find that he can use a particular alloy in contact with a certain propellant providing the stresses are below the corrosion threshold. Some materials are forbidden for use in any Orbiter application. This file is up-dated continuously but is not on-line. However, a printout can be obtained upon request to the appropriate NASA Orbiter Program Office. NASA Johnson also maintains a handbook on flammability of nonmetallic materials. A specification (MSFC-522A) entitled "Design Criteria for Controlling Stress Corrosion Cracking" that relates primarily to marine environments and classifies materials into high, intermediate and low susceptibility to stress corrosion cracking is published by NASA Marshall. This document, however, does not provide numerical data relating to stress corrosion performance.

NASA does maintain an on-line bibliographical reference file through the operation of the NASA Scientific and Technical Information Facility (STIF). This contract operation is located in Baltimore, Maryland, and is charged with the responsibility of maintaining a bibliographic file that includes technical information of interest to NASA's program offices and centers. Any organization receiving a contract or grant from NASA has the responsibility of furnishing copies of their interim and final reports to STIF. Copies of NASA's in-house reports are also sent to STIF. Certain DOE

contractors have a similar requirement. In addition, STIF receives twice monthly, magnetic tapes from Defense Technical Information Center's Technical Abstracts Bulletin (TAB) and, when appropriate, microfiche of reports listed in TAB.

All of this information is subject to an evaluation that includes cataloging by key-words, indexing, and abstracting. Titles and abstracts are published bimonthly in a NASA document called STAR. All this information also is maintained on-line in a file known as RECON. Terminals for communication with RECON are located in all NASA libraries. RECON can be very useful in locating titles and abstracts when searching by alloy type and strength-limiting factors (e.g., hydrogen embrittlement, stress corrosion). Descriptors may be combined as desired in the search.

Hard copy of microfiche of documents in the RECON file presumably can be obtained from STIF but it is quicker to obtain such materials from the author.

Appendix D

APPLICATIONS OF COMPUTER AIDED DESIGN ON THE 767

William D. Beeby
Boeing Commercial Airplane Company
Seattle, Washington

Abstract

Requirements for technological advances and more efficient airplanes prompted the Boeing Company to develop a new generation of airplanes. The complexity of these products and the growing need for increased productivity resulted in greater use of computers in the design and manufacture of these new aircraft. The 767 program is proving the effectiveness of using computers.

Computers have been used in Boeing for many years, and have evolved to a sophisticated system of Computer Aided Design (CAD) and Computer Aided Manufacture (CAM). CAD tools and capabilities have proven effective for the design and drafting process. The CAD/CAM Integrated Information Network (CIIN) allows communication between various computer systems, making data available to design and manufacturing at all Boeing locations.

1. INTRODUCTION

In 1916, William Boeing and Conrad Westervelt collaborated in the design and manufacture of a new airplane. Named the B&W, it was a twin-float seaplane built of spruce, steel wire, and linen (Figure 1). It was a simple design by today's standards and was developed using traditional tools of design and manufacture.

Over a half century later, Boeing is still creating airplanes. In response to advance of technology and need for greater effi-



Figure 1.—Boeing's first airplane, the B&W, was simple by today's standards.

ciency, Boeing is developing a new generation of aircraft consisting of the 757 and 767.

Although the designer's imagination is still the key to designing Boeing aircraft, the complexity of these programs and the growing need for increased productivity have resulted in the update of tools used to design and manufacture airplanes. This update includes the use of computers, which are rapidly taking the place of drafting boards and slide rules.

2. HISTORY OF COMPUTING AT BOEING

CAD efforts at Boeing started in the late 1950's, when Numerically Controlled (NC) machines were used to produce tooled parts. Using APT, a programming language, punched tapes were created to control the motions of NC machines. This computerized process revolutionized both the production and design of parts when engineering began using APT technology to create programs by which machines could produce drawings. When used by engineering, APT was used to describe geometry using the mathematical definition of the airplane surface as a basis.

The YC-14 program was the first production synthesis of CAD. A batch procedure, APT programming was combined with computerized design analysis aids for wing and body rib design. The YC-14 applications included surface configuration, kinematics of variable flap mechanisms, and plotting of body stress node points.

In 1974 computer graphics were installed which allowed interactive manipulation of part geometry. These systems were helpful because for the first time the user was able to interact

with the system and data in real time to reduce turn-around time and speed up the design process.

Since introduction of Interactive Computer Graphics (ICG) into the Boeing process, several special application programs have been added, and use of Batch CAD or parametric design and ICG have been combined through the use of networking, taking advantage of the best of each method.

3. CAD AND THE 767: THE COMPUTING TOOLS

Engineering uses a combination of computers and computing systems to generate, store, and communicate airplane design data. These systems are product definition systems, parametric part design (or Batch CAD), Interactive Computer Graphics, and design aids.

Product definition systems generate mathematically controlled surface definitions which describes the product surfaces in two planes and allows visualization of surfaces. This data is used by Batch CAD programs.

Batch CAD is a Boeing-developed technique that uses the inherent logic of the APT programming language to define detail parts and surface geometry for automated drafting and manufacturing of parts and assemblies. Batch CAD programs allow designers to define detail parts and assemblies, and define design alternatives by varying input parameters.

This method is successful when designing a "family" of look-alike parts such as airplane wing ribs (Figure 2). Prior to using Batch CAD or APT, drafters would draw each part separately, resulting in as many differences in the parts as there were designers. APT allows a program to be written for one part and modified slightly to produce the remaining parts of the "family."

Because of the continued development in computing capability ICG is fast becoming a viable tool for many applications.

ICG plays a prominent role in the drafting and release of engineering drawings and related datasets and is used for two-dimensional conceptualization, layout of geometric features, dimensioning, and annotation. Other typical applications include

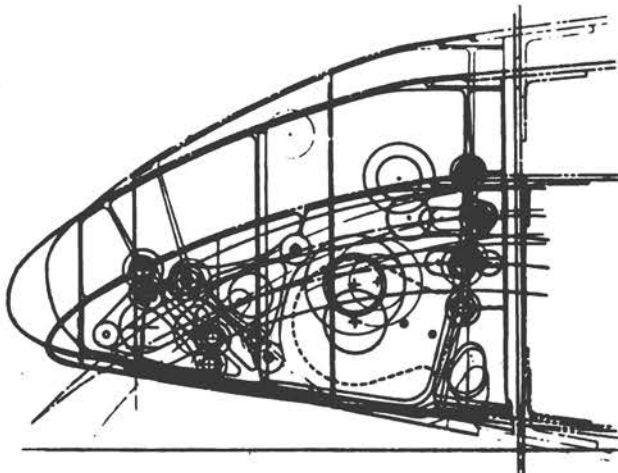

Figure 2.—Batch CAD is used to design "families" of look-alike parts.

3-D modeling, kinematics, clearance studies, illustration, and mock-up layouts.

ICG standard part libraries, or special collections of ready-made symbols and figures, provide a great deal of part interchangeability and common design concepts. Symbols, figures, tooling components, and other commonly used items are categorized and stored, to be recalled and used without having to be recreated each time (Figure 3).

Design aid systems are used for kinematic analysis, mathematical analysis, and computerized assembly.

Based on initial information, engineers enter preliminary design information such as wing plan form, thickness, and engine type to define initial airplane configuration geometry. The computer performs size matching calculations, kinematics of trailing edge flaps, testing of noise levels, simulations, and temperature variation calculations.

Use of CAD on the 767 program allows engineering information to be available to Technology Staff analysts much earlier than on previous programs. The importance of early weight information is shown by Figure 4, which shows the 767, 727, 737 weight history comparison. When early visibility is available, changes to the airplane can quickly be analyzed and weight growth trends monitored, minimizing the need for costly weight reduction programs to meet performance requirements.

Use of CAD kinematics modeling allows early detection of design errors. Complex surface clearances, which were difficult to detect with manual methods, are detected early with CAD.

Boeing combines these systems to make up a unique series of systems for various applications. The combination of systems are tied together by a network which allows data to be transferred between systems, and to be stored and retrieved from a common Geometric Data Base (GDB).

4. APPLICATIONS OF CAD TO THE 767

The newest addition to the Boeing airplane family, the all-new 767 wide body airplane has advanced technology wings and improved engines for quieter and improved fuel efficient operation. It will carry 208 passengers in comfort and has a wing span of 155 feet and body length of 159 feet (Figure 5).

Increasing volumes and complexity of work prompted Boeing to use computers in all phases in the design and manufacture of the 767. The 767 was the first large scale use of computing, partially because of the ease in applying this technology to a new program rather than trying to convert data from previous programs into computer form.

One major problem of past airplane programs had been the number of drawing changes made late in the design phase, usually at 90% release and certification or first airplane flight. Early in the 767 program, a study revealed that of the major changes, 24% were caused by basic engineering error, 18% because of necessary weight changes, and 12% because of Technology Staff changes.

It was estimated at that time that use of CAD could reduce these changes 15% by reducing the number of engineering

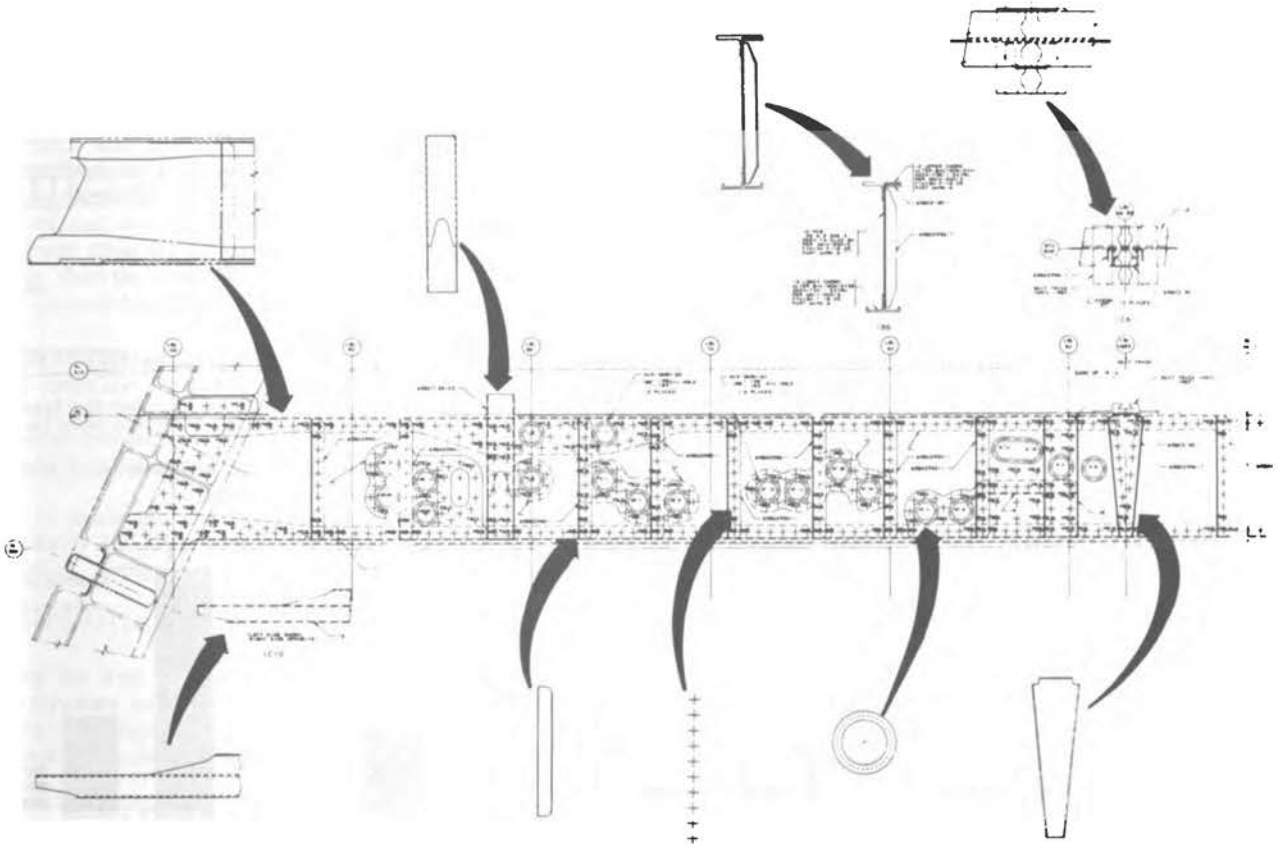

Figure 3.—Commonly used items are stored and recalled for later use in designing such items as floor beams.

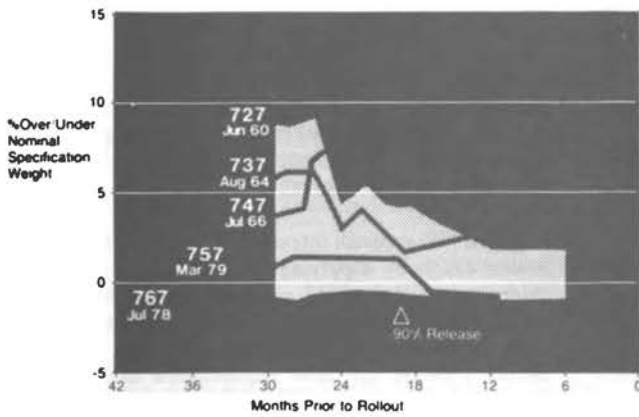

Figure 4.—Early weight information on the 767 allowed performance requirements to be met earlier than on previous programs.



Figure 5.—The 767 is Boeing's first large-scale use of Computer Aided Design.

errors. The engineering error reduction would be realized through more accurate design, not immediate manhour savings.

It was also estimated that of the 18,000 drawing sheets needed for the 767, 5,000 could safely be committed to CAD methods. Total planned penetration of CAD methods was 18% and as the program progressed the actual percentages exceeded those estimations.

4.1 STRUCTURES APPLICATIONS

A special parametric part design program has been used to design the 767 leading edge ribs. The variables for each rib are described in such a way that one rib after another can be drawn from the same APT program.

This powerful design approach guarantees that all designs in the family of parts are kept consistent with one another. The computer gives a cut of the loft of the leading edge for the stabilizer, or produces a layout wherever there is to be a rib. The rest of the ribs, though of different sizes, can be drawn by the computer with slight modification of the program. Once this information is transferred to the graphics systems, it is used to develop detail designs from the installation drawings.

Because all ribs come from the same program, each rib is the same, in contrast to other methods which produced as many variations in ribs as there were designers on the project. When passed to manufacturing, each rib is essentially the same part, not different ones.

A second structures program, called the wing box program, is considered the most powerful and cost effective program on the 767.

Aerodynamic shapes, structural arrangement, the centerline diagram structural thickness, shapes, and concepts are input to the program resulting in complete layouts of skin assembly with stringers and inspar rib cross sections of the spar (Figure 6). These layouts have allowed layout of wing panels with all the dimensions. Due to this, complete mock-up drawings have been produced months sooner than on other programs with problems discovered and corrected early in the 767 program.

The speed of this program also allows that all leading edge ribs can be respaced, the spar on the stabilizer changed, and drawings released within a week. Overnight turnaround on the rib and spar layouts to reflect skin panel changes contributes to higher quality engineering and fewer changes late in the program (Figure 7).

These quick changes are accomplished because each module shares common input. If changes are made to the thickness of a spar chord, for example, all ribs, clips, and items related to it are changed without requiring a designer to spend valuable time investigating affected parts.

4.2 SYSTEMS APPLICATIONS

Batch CAD and ICG are used for drawing and layout preparation and to verify mechanism clearances. General applications include flight control systems, hydraulics, and tubing layouts.

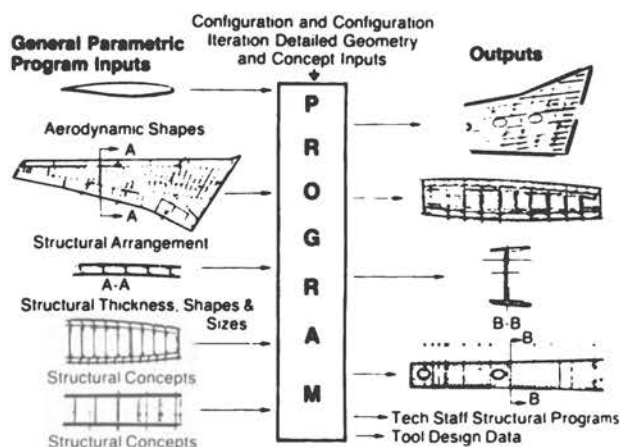

Figure 6.—General Batch CAD programs result in dimensioned layouts of wing panels.

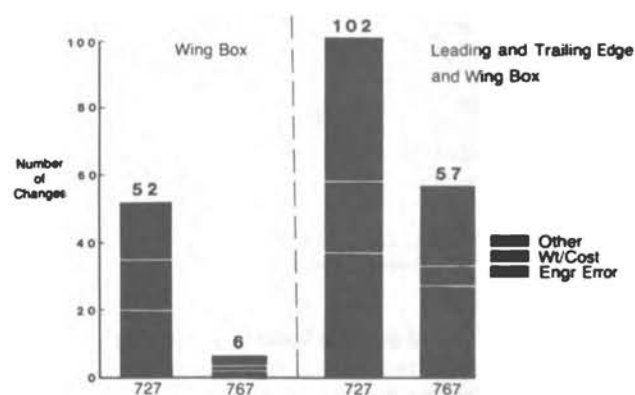

Figure 7.—Higher quality engineering and fewer changes late in the 767 program are attributed to CAD.

Hydraulic and electrical systems are routed using the 3-D capabilities of ICG. The computerized 3-D model provides a spatially correct model that allows the designer to route wires and tubes more accurately than manual methods before a mock-up is built.

A special ICG program integrates the entire process of hydraulic system design by supplying data for design judgment and decisions, supporting rapid layout and analysis iterations. Through use of several specialized programs, the system is used to determine the smallest, lightest tubing capable of maintaining satisfactory pressure and flow requirements of equipment under flight conditions. Other programs determine high and low operating temperature ranges and heating effects, define design parameters such as tube length, branch, and/or sub-system in relation to operating conditions, and stress analysis accounting for tube tolerance, deflection, and vibration for fatigue evaluation.

Although a new system, and still in the test phase, it should reduce many problems with overstressed tubes and remake of tubes in the airplane. In the past tube design was completed and controlled by master tubes which are subject to deviation. As a result at least 60% were changed when installed in the airplane. Now, because engineering releases datasets as well as

an actual drawing to the automatic tube bending machines, more accurate hydraulic tubes are available.

Batch CAD and ICG are combined as an integral part of the 767 flight control design process (Figure 8).

Moving surfaces and mechanisms are modeled as an aid to geometry generation and analysis. A flight control parametric design program includes a computer module for each type of motion transfer including control cable systems, linkage, gears, cams, actuators, and flat/slot tracks. General programs for each of these modules allow those features to be placed anywhere in the airplane. Once the layouts have been completed, engineering can optimize each feature.

Computers are also used as design tools to verify surface motion versus input command, identify and correct errors before release, determine the effect of friction on system performance during the design process, and maximum load analysis on each component and the total system, plus total power requirements.

In addition to hydraulics and flight controls, computerized systems, (primarily ICG), are used to design and release electrical schematics, wiring diagrams, and printed wire boards.

4.3 PAYLOADS APPLICATIONS

By combining the large amount of structural data from the Batch CAD programs and the speed and ease of ICG, cargo compartments, passenger accommodations, and the cargo handling system can be designed using computers.

It is technically feasible to input customer specifications such as type of galley, seats, lavatory, pitch, waterline, locations, and so on, and from this data generate assembly and installation drawings, and produce computerized assembly data.

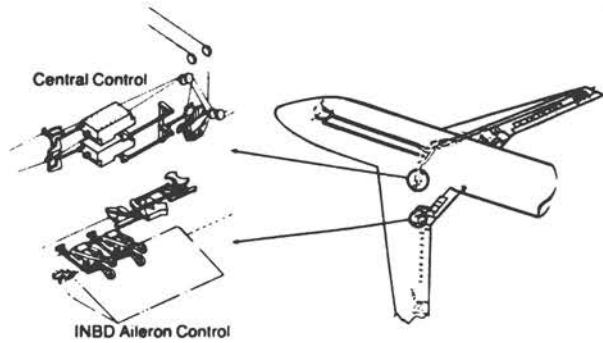

Figure 8.—Flight Control moving surfaces and mechanisms are modeled using ICG capabilities.

Furthermore, since these areas are customer-variable many different design specifications and changes are required and ICG assists with rapid changes to the basic design.

Interior arrangements are created by retrieving patterns stored in the computerized library and duplicating them in the layout desired by the customer. These items are matched by using a full size presentation of the airplane in the computer (Figure 9).

4.4 MANUFACTURING USE OF CAD

Boeing's Manufacturing Division uses computer generated engineering data and separate manufacturing systems for detail part fabrication, tooling design, and assembly processes.

Detail part fabrication using NC systems constitutes a major CAM application. APT systems, special programs and ICG systems are used by Numerical Control programming. A special

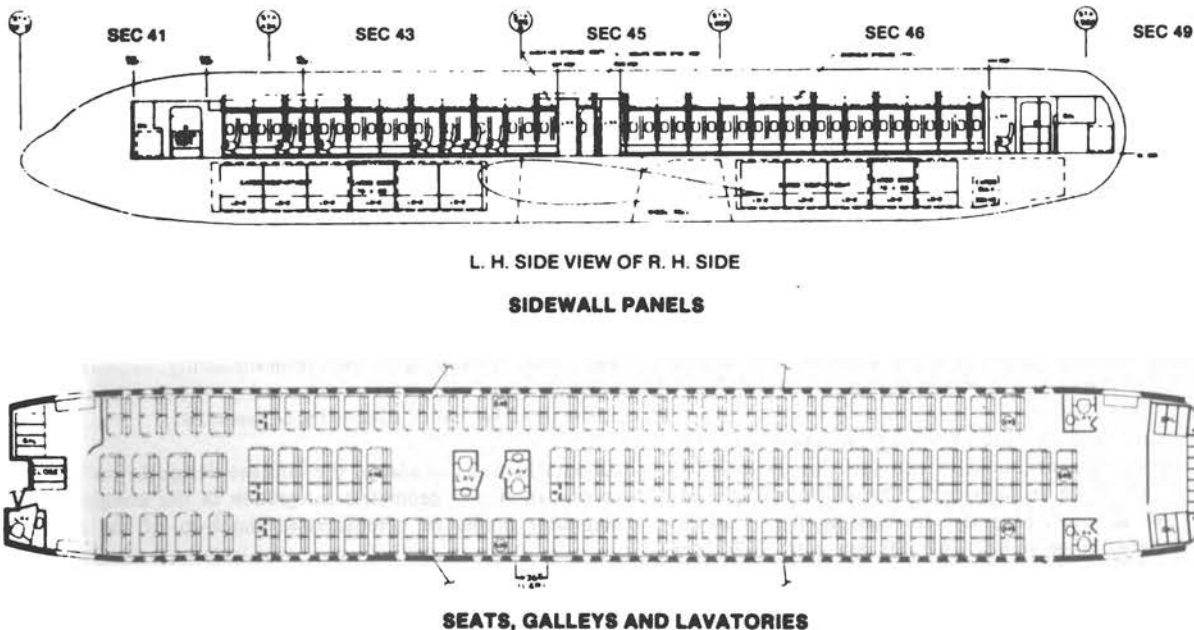

Figure 9.—ICG is used to design airplane interiors and provide computerized assembly.

system enables NC part programmers to interactively prepare NC part programs. Part geometry and cutter path data is entered into the system from which tape tryout machine media is produced. ICG is used to provide better visibility of the relationship between part geometry and cutter tool paths.

Manufacturing is also able to distribute NC cutter path data directly from the data center to a machine tool, using a special minicomputer based distribution system. When CAD datasets are used, the time normally spent for NC programming is greatly reduced.

ICG systems are also used by Tool Design to design jigs, fixtures, and scaffolding.

A major tooling application of ICG on the 767 is shown by the design of the scaffolding built to provide access to all areas of the airplane in assembly. On previous airplane programs, each part of the scaffolding was custom built, resulting in unique, one-of-a-kind parts. Interactive computer graphics allowed modular design of the decks, posts, guard rails, and stairs. This standardized design in turn permitted mass production of parts and procurement from local commercial sources.

ICG pattern libraries consisting of 622 patterns, 44 forms, and 221 drafting symbols assisted in the creation of the scaffolding, resulting in 27.5% savings in hours over conventional design. The scaffolding was not only better, requiring less maintenance, but will be reuseable on follow-on programs.

Boeing developed a family of microprocessor driven drilling and riveting tools using NC programs which are generated from CAD/CAM datasets with little or no NC programmer intervention.

A self-propelled drilling unit with independently controlled drill spindles which travels on tracks in the airplane is used to drill the seat track holes. Holes can be drilled at an average of 30 holes per minute, and on the 767 there are over 8,000 holes which were drilled with no errors.

A computer aided tool also locates, drills, and fastens wing spar components. Use of this tool eliminates drill plate tooling and maintenance costs and provides for one-step joining of sealed surfaces. The spar assembly process allows drilling of the fastening holes by a computer controlled system which drills each hole, clamps, and rivets the spar automatically.

In addition, manufacturing uses robots for sanding and painting tasks, and interactive computer graphics systems for electrical and electronic assembly, including wire bundle processes and printed circuit board fabrication. The Numerically Controlled tube bending digitizers automatically measure and record hydraulic tube shapes and completes multiple tube bends.

Improved design, tooling, manufacturing processes, and engineering (CAD) have contributed to less part mis-match and a reduction in 767 shim requirements. This difference is clear, when the 747 and 767 programs are contrasted as follows: Section -46 cargo floor shims: 747-130 per unit; 767-3 per unit, for a 98% reduction. Sections 42/43 cargo floor shims: 747-160 per unit; 767-zero, for 100% reduction.

Although this is a brief overview of the CAD and CAM systems used by Boeing on the 767 program, it is apparent that there are many systems and many tasks. One of the requirements is taking the efficiency of Batch CAD and combining it with the flexibility of ICG.

5. CIIN

When Boeing introduced ICG systems, batch programs were already in existence so a method of having different computers communicate with each other was required. The CAD/CAM Integrated Information Network (CIIN) was established, and in July, 1976 the first APT data was passed via the CIIN system directly to the Everett CAD interactive system. This first attempt at networking unlike computing systems was unique to Boeing, and perhaps the industry.

A main requirement for the network is to pass data to the manufacturing division as input for APT/NC programs. Without the network, engineers produce drawings manually, by Batch CAD, and by ICG systems. In order for manufacturing to build the part, a program based on the drawing must be written and a second program written by Quality Control for inspection. In the middle is a two dimensional piece of paper that acts as the communication device. The reliability and accuracy of the part thus depends on the interpretation of the person using the drawing, which leaves a great deal of room for mistakes.

It is necessary for unlike computers to communicate between each other because Boeing's variety of computers include large host IBM, Cyber systems, varying types of stand-alone mini-computers, and interactive computer graphics. This communication is also necessary because Boeing has diverse locations ranging from the Puget Sound area to Wichita, Kansas.

CIIN provides for storage, retrieval, and transmission of product descriptions between the geometry producing systems. It consists of the GDB and network interfaces. The GDB contains a community data base for work in progress, a preliminary data base for establishing configuration control prior to release, and a release data base containing only released part data.

Data is stored in a standard format and network interfaces convert geometry and associated data from the format of one system to the format of another.

In addition to linking the different geometry systems, plotting systems have been installed which produce electrostatic prints for mark-up and flatbed plotters to produce high quality plots for released drawings.

This integrated approach, aside from enhancing communications between engineering and manufacturing, is important because of the development of computerized assembly.

As data becomes available, the airplane design is available for coordination and geometric integration in the computer as a computer model or computerized mock-up of the airplane.

Because this data is accessible and shared between the designers of the different disciplines such as Structures or Systems, all designers can communicate quickly and easily use data from the

other disciplines. Examples might be coordination of mechanical systems with hydraulics, or Payloads with Structures information.

6. CONCLUSION

The integrated approach and coordination allows early cooperation between the disciplines, facilitating the detection and solving of problems in the computer before actual production begins.

The 767 airplane program is Boeing's first large scale use of computers and CAD/CAM to date, and has exceeded the original expectations of how successful the applications of the system would be and the penetration, as shown by the following chart.

	1978 Goal	1979 Revised	Estimated Completion
Structures	25%	35%	
Payloads	19%	50%	
Systems	5%	18%	
Propulsion	5%	3%	
TOTAL	18%	31%	35-40%

The success of CAD/CAM on this program has depended upon the integration of Batch CAD and ICG methods.

Batch CAD contributed to engineering efficiency by providing early layout visibility, early mock-up, and an early design freeze. The early layout of wing ribs and struts, for example, was accomplished approximately seven months earlier than conventional methods would have allowed (Figure 10).

These early layouts in turn, have supported the entire process of design and manufacturing. Because detailed and accurate layout drawings were available early in the program, the airplane mock-up was improved, allowing for the engineering mock-up to be converted with only slight modification to the production mock-up.

This much earlier design freeze imposed because of accuracy allows more time in the later phases of design, leading to a reduction in error and more precise fit during assembly.

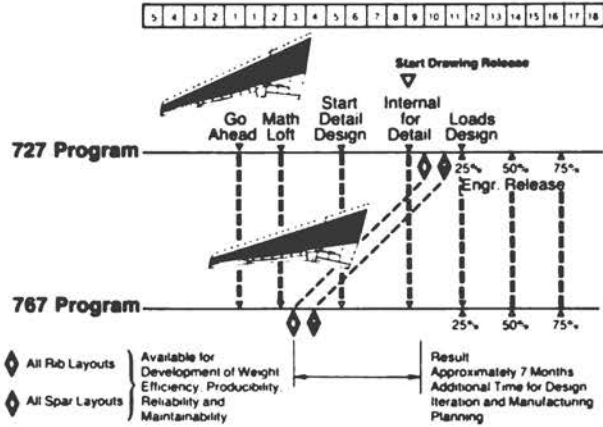

Figure 10.—Batch CAD contributes to engineering efficiency by providing early rib and spar layouts.

The accuracy, dependability, and reduction in error are all benefits of CAD/CAM which have led to a more efficient production schedule and higher quality product, assuring Boeing's superiority in the commercial airplane field into the next century.

7. BIOGRAPHY

Mr. William D. Beeby is the Director of Engineering Computing Systems for the Boeing Commercial Airplane Company, with responsibility for the administration and direction of computer activities within the Engineering Division.

Following graduation from Kansas State University with a BSME, Mr. Beeby has been employed by the Boeing Company in a variety of positions. His assignments have included Chief Liaison Engineer on the B-47 program, Assistant Chief Project Engineer on the 737 program, and Manager of Production Engineering for the Boeing Fabrication Division.

Mr. Beeby is currently the National President of the Computer and Automated Systems Association (CASA), and a member of the Board of Directors of the National Computer Graphics Association. He is also a member of the Engineering Advisory Board for both Seattle University and Washington State University.



Appendix E

EXAMPLE OF AN ON-LINE COMPUTERIZED MATERIALS PROPERTIES DATA BASE DEVELOPED FROM AN EXISTING HANDBOOK DATA BASE

INTRODUCTION

The properties of materials and their supporting specifications utilized for the design, analysis and manufacturing of jet engine parts are documented in the 14 volumes shown in Figure E-1. They contain 2300 curves and 900 specifications. This appendix is a status report on a project that will incorporate computer-aided engineering into the latest revision of the materials properties and specifications release.

OBJECTIVE AND STRATEGY

The overall objective of the project is to improve the way material properties are presented and to make full use of the engineering data base for the storage, retrieval, and historical preservation of the data. The basic plan of attack consists of the following steps:

1. Establish a scientific data base,
2. Enter the curves and specifications into the data base, and
3. Develop user-oriented application programs.

The integrated data base was chosen as the data base for the project. This system has been developed primarily for the engineering community. Its main attributes are that it is engineering oriented, growth-oriented, and flexible; it provides the user with rapid access to the data; and it is user friendly.

Before being entered in the data base, the material property curves are being restructured to the new statistical format of 95 percent confidence of 99 percent exceedence. This was accomplished by digitizing the existing



FIGURE E-1 An AEBG materials properties data base computerization.

curves and applying algorithms to create the new curves via the Computervision Interactive Graphics hardware. Similarly, the specifications are documented using word processors and then are transferred to the engineering data base when completed. Discussions were held with the user community to define present and future uses of the materials properties.

BENEFITS

This system will allow the same data to be utilized throughout the engineering and manufacturing community. This will include the major aircraft engine business group sites at Lynn, Massachusetts, and Evendale, Ohio, plus the various satellite plants and repair shops. The data can be accessed by CRT terminals or remote printers. The result will be a paperless system with computer-developed reports as a by-product. The major computer programs on stress, vibration, and heat transfer analysis will interface directly to the data base to permit the user to obtain the material properties. Major productivity improvements and cost reductions are anticipated from both the user's standpoint and that of the organization responsible for analyzing the materials data, generating the curves, and publishing the results.

USER INPUT/OUTPUT

The software is structured to make user inquiries very friendly, and two modes of entry are provided. If the user knows his material property curve number, he can have direct access to the vital information. If the curve number is not known, a tutorial mode of entry allows users to work their way sequentially through the table of contents to the curve number. The table of contents includes alloy, material form, specification, material property, and curve number. Users repeat the process until the curve numbers they want to investigate, up to a maximum of 10, are established. Since the system functions in a time sharing mode, access to the data is quick and cost-effective.

The output selection menu (Figure E-2) appears on a Tektronix 4014 upon command. The users then can request the information they are interested in obtaining. Figures E-3 through E-11 (taken directly from the Tektronix 4014 hard copy unit) document the output sequentially.

Figure E-3 displays the average and 95/99 curves for a material property. It is a reproduction of the curve as it appears in today's hard copy manuscripts. Figure E-4 is a table of the average and 95/99 data points that make up the curve in Figure E-3. The average points are the digitized values and the 95/99 points result from the algorithm processed against the average points.

Figure E-5 displays the average and 95/99 curves with the raw data points superimposed on the average curve. The raw data points are a result of the materials testing process. Figure E-6 is a table of the average, 95/99, and raw data points that make up the curve in Figure E-5.

Figure E-7 is the material cost per pound. The purchasing data bases are accessed regularly and the resulting cost stored in this system.

```
*****  
* 1. PLOT AVG & 95/99 CURVES FOR ONE CURVE # *  
* 2. TABLE OF DATA POINTS *  
* 3. READ CURVES -- POINT PAIRS *  
* 4. MATERIAL COST PER POUND *  
* 5. COMPLETE MATERIAL SPECIFICATION *  
* 6. SUMMARY OF MATERIAL SPECIFICATION *  
* 7. OVERLAY PLOTS *  
* 8. PLOT OFFICAL REDBOOK PAGE *  
* 9. CHANGE CURRENT KEYSTRING (CURVE NUMBER) *  
* 10. PRINT ALL KEYSTRINGS (CURVE NOS.) DEFINED *  
* 11. TERMINATE REDBOOK DATA FUNCTION *  
*  
*****  
#
```

FIGURE E-2 Output selection menu.

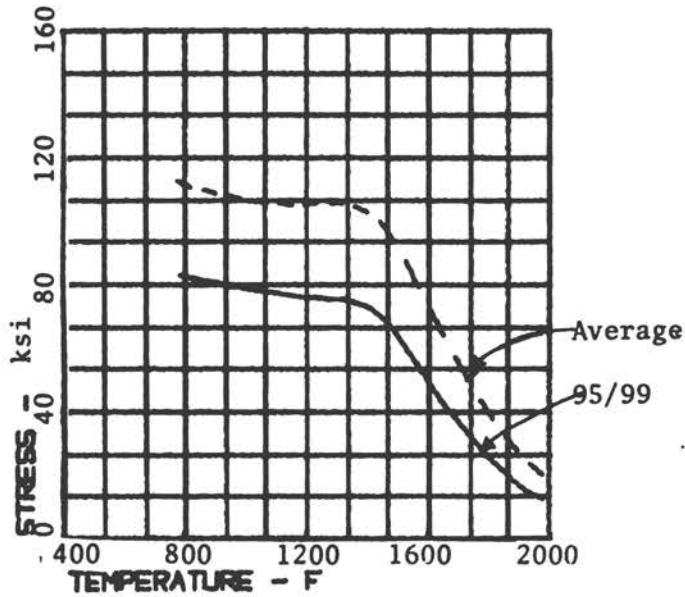

FIGURE E-3 Average and 95/99 0.2 percent tensile yield strength curve for a nickel-base alloy.

NICKEL BASE ALLOY
CURVE # 2281

AVERAGE		95-99	
X	Y	X	Y
779.39	112.08	779.39	83.54
912.45	108.55	912.45	80.17
1045.50	106.31	1045.50	77.69
1178.56	105.41	1178.56	76.15
1311.61	105.67	1311.61	75.03
1444.67	99.23	1444.67	69.85
1577.72	77.02	1577.72	51.92
1710.78	52.93	1710.78	34.79
1843.83	33.72	1843.83	21.14
1976.89	19.79	1976.89	12.36

HIT C/R WHEN READY TO CONTINUE

FIGURE E-4 Example of tabular output (based on Figure E-3).

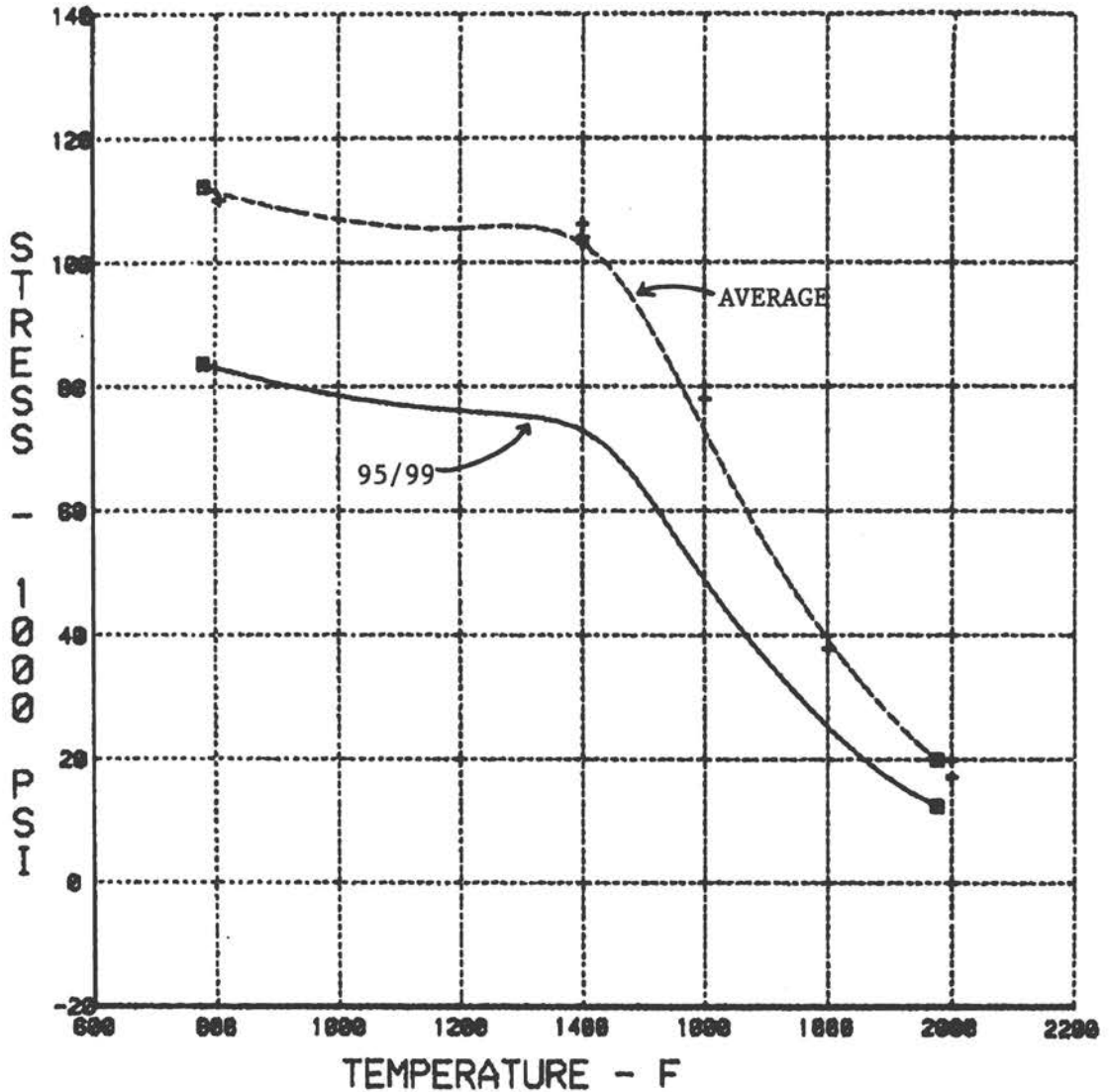

FIGURE E-5 Average 95/99 0.2 percent tensile yield strength curve for nickel-base alloy showing raw data points.

NI BASE CAST
CURVE # 2281

AVERAGE		95-99		RAW DATA	
X	Y	X	Y	X	Y
779.39	112.08	779.39	83.54	75.00	123.00
912.45	108.55	912.45	80.17	75.00	122.00
1045.50	106.31	1045.50	77.69	806.00	110.00
1178.56	105.41	1178.56	76.15	1400.00	106.00
1311.61	105.67	1311.61	75.03	1400.00	103.00
1444.67	99.23	1444.67	69.85	1400.00	104.00
1577.72	77.02	1577.72	51.92	1600.00	78.00
1710.78	52.93	1710.78	34.79	1800.00	38.00
1843.83	33.72	1843.83	21.14	2000.00	20.00
1976.89	19.79	1976.89	12.36	2000.00	17.00

WHEN READY TO CONTINUE, HIT C/R

FIGURE E-6 Example of tabular output (based on Figure E-5).

```

*****
*
* 1. PLOT AVG & 95/99 CURVES FOR ONE CURVE #
* 2. TABLE OF DATA POINTS
* 3. READ CURVES -- POINT PAIRS
* 4. MATERIAL COST PER POUND
* 5. COMPLETE MATERIAL SPECIFICATION
* 6. SUMMARY OF MATERIAL SPECIFICATION
* 7. OVERLAY PLOTS
* 8. PLOT OFFICAL REDBOOK PAGE
* 9. CHANGE CURRENT KEYSTRING (CURVE NUMBER)
* 10. PRINT ALL KEYSTRINGS (CURVE NOS.) DEFINED
* 11. TERMINATE REDBOOK DATA FUNCTION
*
*****
=4

```

NI BASE CAST COST PER POUND IS \$ 10.62

HIT C/R WHEN READY TO CONTINUE

FIGURE E-7 Material cost per pound.

The specifications that support the individual materials are stored in the data base system in their entirety. For the individual user interested only in specific subsets of the specification, a summary sheet has been developed and is stored on the data base. These features are shown in Figures E-8 and E-9.

One of the main features of the system is the user's ability to make comparisons between multiple curves in a rapid manner. Figure E-10 displays two sets of average and 95/99 curves; up to 10 can be handled by the software.

For making comparisons, an automatic curve-reading feature has been incorporated into the software. This is illustrated in Figure E-11. Referring to Figure E-10, for a temperature of 1000°F, the software picks out the appropriate stress levels for the four curves and documents the results.

Information searches presently are being developed as a user-controlled option. For example, the user could query the system: "What materials have a 0.2 percent tensile stress of greater than XXXXX psi at a temperature of XXXX°F?"

1 C50TF28-S10 DATE MAR. 2, 1978
2 Ni BASE INVESTMENT VACUUM CAST TURBINE BLADES AND VANES
3
4 1. SCOPE
5
6 1.1 SCOPE. THIS SPECIFICATION PRESENTS REQUIREMENTS FOR PRECISION
7 INVESTMENT VACUUM CAST Ni BASE TURBINE BLADES AND VANES. DETAILS
8 OF OPERATIONS INVOLVING MECHANICAL DEFORMATION, BRAZING, OR
9 COATINGS, ARE BEYOND THE SCOPE OF THIS SPECIFICATION.
10
11 1.1.1 THIS SPECIFICATION CONTAINS THE FOLLOWING CLASSES
12
13 CLASS A FULLY HEAT TREATED 2200F (1204C) + 2000F (1093C) +
14 1925F (1052C) + 1550F (843C)]
15 CLASS B SOLUTION TREATED AND PRIMARY AGED 2200F (1204C) +
16 2000F (1093C)]
17 CLASS C AS CAST
18 CLASS D SOLUTION TREATED 2200F (1204C]

DO YOU WISH TO REVIEW ANY LINES OF THE SPECIFICATION?

=

FIGURE E-8 Material specifications (small sample of complete specification).

COMMERCIAL DESIGNATION:

Investment Cast Turbine Blades and Vanes.

1	Chemical Composition %	Element		C	Si	Mn	P	S	Cr	Mo
		min.		0.15	---	---	---	---	13.70	3.70
		max.		0.19	0.10	0.10	0.015	0.0075	14.30	
		Element		W	W+Mo	Ti	Bo	Al	Co	Zi
		min.		3.70	7.70	4.80	0.01	2.80	9.00	0.02
		max.		4.30	---	5.20	0.02	3.20	10.00	0.10
		Element	Co	Fa	Va	Cu	Ha	Mg	Ni	Nv3
		min.		---	---	---	---	---	---	---
max.		0.10	0.10	0.10	0.10	0.10	0.1	Remainder	2.32	
2	CLASS(FS)			A		B		C	D	
3	Method of Melting			Vacuum Cast						
4	Form Method of production Limit dimensions			Precision investment cast						
5	Acceptance Standards									
6	Condition and Heat Treatment Supply			Fully Heat Treated (See Spec)		Solution Heat Treated and Primary		As Cast Solution Treated		
7	Condition and Heat Treatment Use					Aged (See Spec)		(See Spec)		
8	Test Piece Heat Treatment Sampling			N/R						
9	Dimensions Concerned		mm	N/A						
10	Thickness of cladding on each face		%	N/A						
11	Direction of Sample			Cast as machined						
12	Hardness			N/R						
13	Shear Strength		R _c psi (MPa)	N/R						
14	Bending (r=k x a)		k	N/R						
15	Impact			J N/R						

FIGURE E-9 Material specifications summary.

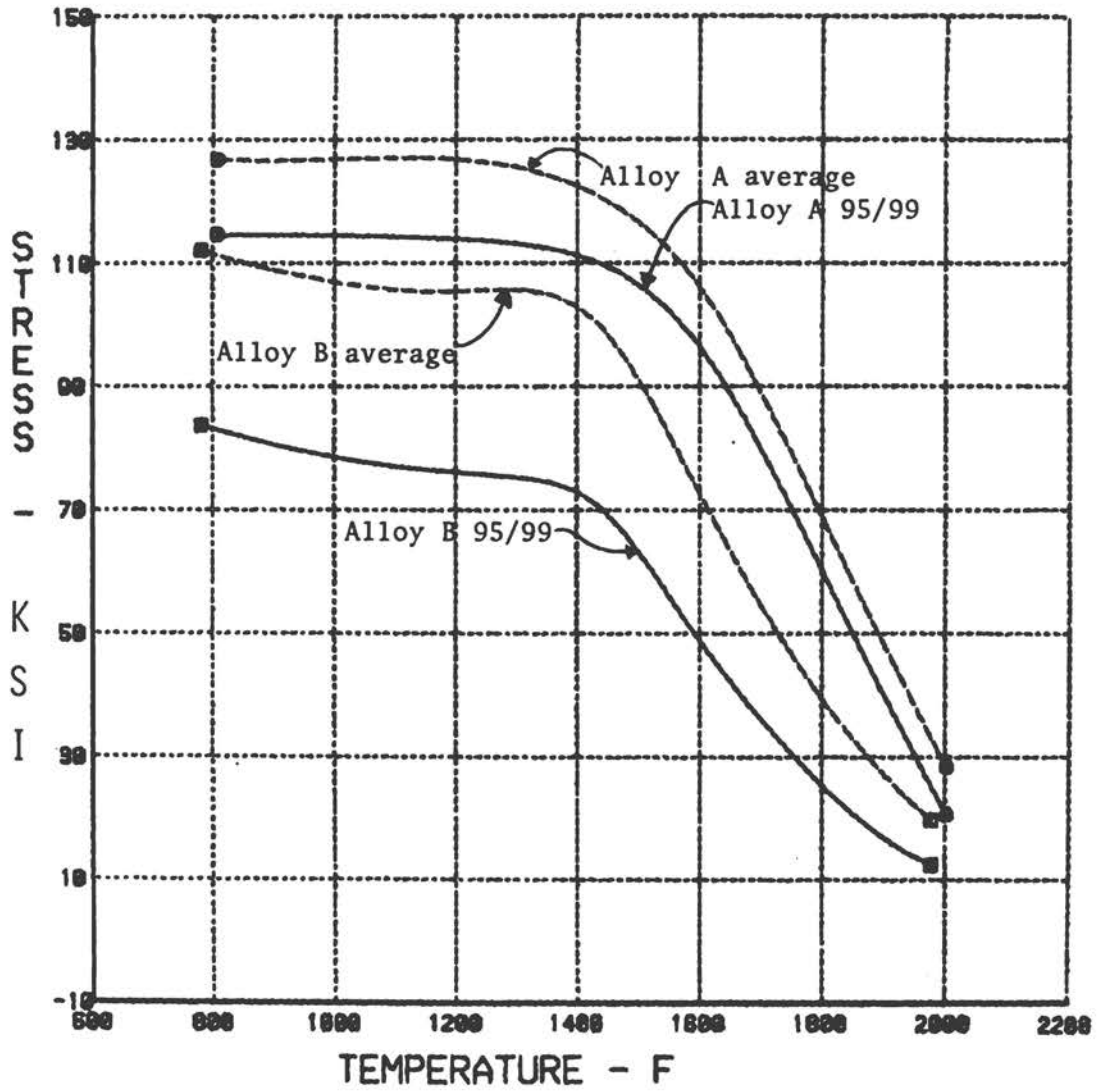

FIGURE E-10 Comparison of average and 95/99 0.2 percent tensile yield strength curves for two alloys.

INPUT AXIS CODE('X' OR 'Y'),VALUE
=X,1000

CURVE NO. 2281

MAT'L FORM Ni BASE CAST
MAT'L SPEC .2% TENSILE
MAT'L PROP *C50TF28 CL-C

AVERAGE X = TEMPERATURE - F
1000.00

Y = STRESS - 1000 PSI
107.

95/99 X = TEMPERATURE - F
1000.00

Y = STRESS - 1000 PSI
79.

CURVE NO. 5258

MAT'L FORM Ni BASE CAST
MAT'L SPEC C50TF60C*
MAT'L PROP .2% TENSILE

AVERAGE X = TEMPERATURE - F
1000.00

Y = STRESS - 1000 PSI
127.

95/99 X = TEMPERATURE - F
1000.00

Y = STRESS - 1000 PSI
115.

DO YOU WISH TO CONTINUE READING CURVES?
=

FIGURE E-11 Automatic curve reading.

SUMMARY

Computer-aided engineering technology has been applied to a manual, labor-intensive system to create an on-line, real-time engineering data base that offers cost-effective storage, presentation, and analysis of the materials properties and their associated specifications.

Appendix F

SURVEY OF U.S. DATA BASES THAT SPECIALIZE IN PHYSICAL AND MECHANICAL PROPERTIES OF USE TO DESIGNERS

In order to ascertain what might be done to develop a data analysis center that would assist in the development of the CAD and CAM industry, the activities of currently operating data centers in this country were reviewed. The operation of each of these data centers consists of three functions: data acquisition, quality control of data, and dissemination of data. These are discussed separately below.

Currently operating data centers are concerned with a variety of topics, and, in general, the phases of each center's operations that are most advanced are those that are most important to its topic, and, of course, possible with the present level of technology. Data accumulation is relatively straightforward for all centers; technical publications, government reports, company reports, and data generated by the center are the most common sources of data.

Quality control of the data is far more difficult, and, again, the level of quality control depends upon the data topic. For example, one of the well established data centers in this country is the Center for Information and Numerical Data Analysis and Synthesis (CINDAS) at Purdue University. The center is staffed mainly by scientists whose field of expertise is in property measurement and theory associated with the type of data they collect. Hence, they are able to judge the quality of data by reviewing experimental techniques. This competence is maintained by having staff members make many of the measurements at the facility. This experimental task is supported by grants from the National Science Foundation (NSF) and the DOD. In one area of its activities, the collection of thermophysical and electronic properties data, CINDAS has an opportunity for more rigorous control of data quality than may be possible in other disciplines. Properties such as enthalpy, heat capacity, and equilibrium constants are connected through well established laws of thermodynamics. By systematically collecting all the reported data for a given class of

compounds, the laws of thermodynamics can be applied to arrive at a preferred set of properties. Unfortunately, the kind of property data needed for CAD and CAM generally cannot be related with any presently available theories.

One major problem of quality control is being sure the material being studied is adequately characterized. In evaluating the electrical conductivity of copper, CINDAS evaluated 200 measurements made as a function of temperature and at low temperature found a variation of more than three orders in conductivity. Much of this scatter was found to result from differences in the purity of the copper. One example is the influence of copper on irradiation embrittlement of A533 steel used in nuclear reactor vessels. The importance of copper was not even known when the earlier reactors were built. Similar problems are expected in characterizing the properties of concern in CAD and CAM. What is important in characterizing materials, particularly for manufacturing? What influences formability, machinability, or weldability? Can the quality of mechanical properties data be controlled by making correlations with chemical composition and microstructure?

In addition to data accumulation and data quality control, an important mission of data analysis centers is data dissemination, and the most advanced and useful means for doing this is by on-line information retrieval. One on-line data service that is well established is the Chemical Information System (CIS). It was initiated by the National Institute of Health and the Environmental Protection Agency, and now has over 500 subscribers and makes a total of about 2500 researches per month. One of its components is concerned with hazardous materials so that it is important for its on-line retrieval to be able to answer inquiries as quickly as possible. Not all of this information can be presented as numerical data so that some of it must be presented in a descriptive or narrative manner. One phase of its operation--the chemical identification portion (MSSS) of the Structure and Nomenclature Search System (SANSS)--does allow for complete numerical or graphic responses. To identify a compound, the user inserts each peak in the mass spectrum of the unknown material. After insertion of the second peak, the molecular formula, proper name, and common names of the compound are given and, with a further command, the complete mass spectrum is given. This requires about 2 minutes and costs about \$1.50.

Much of what is learned from presently operating data analysis centers can be applied to centers associated with the CAD and CAM industry. One serious problem anticipated in establishing a CAD and CAM center or centers is cooperation with presently operated private centers. There is a large number of privately maintained structural material data bases in this country already, and, although the expense of developing similar data at a number of centers is obviously wasteful, these bases have a great proprietary value to their owners and it may be unreasonable to expect them to discard them in favor of a central nonproprietary base. In the same vein, one must consider whether engineers in one company will accept mechanical properties or formability data whose quality is judged by an outside agency.

Following is a list of mechanical properties data bases:

1. **Materials Deterioration Data Program**
 - a. Owner--U.S. Army.
 - b. Maintainer of Data Base---Plastics Technical Evaluation Center (PLASTEC), Dover, New Jersey.
 - c. Materials Included-- Plastics, metals, inorganics, elastomers.
 - d. Data Included--Atmospheric deterioration, chemical resistance.
 - e. Sources of Data--Technical reports, texts, failure analyses.
 - f. Analyses Performed--Reviewed for technical suitability prior to data capture by materials engineers.
 - g. Methods of Dissemination--Disseminated by remote terminal access; hard copy and computer.
 - h. Users of Data--Accessed currently by the government and its contractors.
 - i. Price Schedule--Fixed fee and time share.

2. **The Center for Information and Numerical Data Analysis and Synthesis (CINDAS)**
 - a. Owner--Purdue University. It is classified as the DOD Information Analysis Center. In addition to the DOD funding, it also receives specific contracts from other government agencies including the National Bureau of Standards and the Department of Energy and from private industry.
 - b. Maintainer of Data Base--CINDAS, Purdue University, West Lafayette, Indiana 47906, (800) 428-7675
 - c. Materials Included--More than 56,000 materials plus 9,000 synonyms and trade names are identified in materials directories. This coverage includes the elements, organic and inorganic compounds, alloys, intermetallics glasses, ceramics, cermets, coatings, polymers, systems, composites, foods, biological materials, and many other groups.
 - d. Properties--A total of 14 thermophysical properties and 22 electronic, electrical, magnetic, and optical properties are included. These properties and other search parameters are used for data retrieval.
 - e. Sources of Data--Scientific and technical articles, government reports, doctoral and master theses; more than 230,000 bibliographic citations are included and 10,000 new citations are being added annually.
 - f. Analyses Performed--Reference data are generated through critical evaluation, correlation, analysis, and synthesis of the available experimental data compiled from all sources. The procedure involves critical evaluation of the validity of the available data and related information, judgment on the reliability and accuracy of the data, resolution and reconciliation of disagreements in conflicting data, correlation of data in terms of various controlling parameters (sometimes in reduced forms using the principle of corresponding states), curve-fitting with theoretical and empirical equations, comparison of results with theoretical predictions or with results

derived from theoretical relationships or from generalized empirical correlations, etc.

Besides critical evaluation and analysis of existing data, theoretical methods and semi-empirical techniques are employed to fill data gaps and to synthesize fragmentary data so that the resulting recommended values are internally consistent and cover as wide a range of each of the controlling parameters as possible. As a result, CINDAS can provide to its users not only the available data and information, but also the evaluated correct data and information. In many cases, CINDAS also can provide predicted data and information to the users through the powerful tool of data analysis and synthesis, even when the needed data and information are completely lacking.

- g. Dissemination--The information that CINDAS accumulated is made available in a multitude of publications. A list of these publications can be obtained by writing to Wade H. Shafer, CINDAS, Purdue University, 2595 Yager Rd., West Lafayette, Indiana 47906, or by calling (800) 428-7675. The thermophysical and electronic properties bibliography data base are available for respective searches and current updates. The total bibliographic data base is contained in segments and specialized fields may be obtained on magnetic tapes on a lease or licensed arrangement. CINDAS is working on an interactive on-line service for direct access to the evaluated numerical data. Inquiries concerning this service are invited.
- h. Users of Data--Anyone can use the information available through CINDAS, either through purchasing its publications, obtaining the magnetic tapes, or using the on-line service when it becomes available. Special requests are handled at CINDAS. These may be data evaluation, data generation, or advisory and consulting services. CINDAS is in a position to handle many requests in an expeditious manner.
- i. Price Schedule--CINDAS charges \$40 per man-hour for technical assistance work. Other charges are based on the publication cost and the amount of manipulation of the data required.

3. Aluminum Fracture Toughness Data Bank

- a. Owner--Aluminum Association and the Metal Properties Council.
- b. Sources of Funds--Aluminum Association.
- c. Maintainer of Data Base--Alcoa Laboratories, Alcoa Technical Center, Alcoa Center, Pennsylvania 15069.
- d. Materials Included--Aluminum Alloys, 2124-T851 and 7475-T7351 plate.
- e. Properties--Yield strength, notch strength, and the fracture toughness of K_{IC} values.
- f. Sources of Data--Test results submitted by the member companies of the Aluminum Association.
- g. Analyses Performed--Various statistical analyses are performed as appropriate for this type of data. They arrive at various levels for the K_{IC} values: Value A, 95 percent confidence that 99 percent of the population will equal or exceed this value; Value B,

95 percent confidence that 90 percent of the population will equal or exceed this value; Value C, 75 percent confidence that 99 percent of the population will equal or exceed this value; and Value D, 75 percent confidence that 90 percent of the population will equal or exceed this value.

- h. Methods of Dissemination--Currently the information is disseminated only in hard copy form to members of the Aluminum Association. The users of the data are the members of the Aluminum Association and committees of the Metal Properties Council and ASTM studying the fracture properties of aluminum alloys.
- i. Price Schedule--There are no charges for the information to members of the Aluminum Association and members of the technical committees participating in the analysis of the data.

4. Fatigue of Aluminum Welds

- a. Owner--Welding Research Council with the primary source of funds from the Aluminum Association.
- b. Maintainer of Data Base--Civil Engineering Department, Iowa State University, Ames, Iowa 50011. The individual to contact is W. W. Sanders, Jr., Assistant Director, Engineering Research Institute, College of Engineering, 104 Martson Hall, Ames, Iowa 50011, (515) 294-2336.
- c. Materials Included--All types of aluminum welded joints and the fastening of aluminum to other materials. Extension plans include bolted joints and adhesive bonded joints of aluminum alloys.
- d. Properties--Raw test data are included for the S-N curves of welded joints and the data bank includes the base material tensile properties and joining procedures. Crack propagation data is being considered for the future input.
- e. Sources of Data--Worldwide published information and unpublished reports from several companies as well as data from projects sponsored by the Welding Research Council.
- f. Analyses Performed--Numerous statistical analyses in curve plotting are performed on the data. Various methods of presenting fatigue life data also are being evaluated.
- g. Methods of Dissemination--The data is disseminated by the Civil Engineering Department of Iowa State University on a request basis. There is no direct computer access to this data base.
- h. Users of Data--Anyone needing the data may obtain it from Iowa State University.
- i. Price Schedule--Individual charges are made for the information supplied.

5. Carbon-Carbon Composite Data Bank

- a. Owner--U.S. Air Force and U.S. Navy.
- b. Maintainer of Data Base--Battelle-Columbus Laboratories, Columbus, Ohio 43201. Contact is Harold Mindlin at (614) 424-4425.
- c. Materials Included--Carbon-carbon composites.

- d. Properties--All properties from initial layup to final use are included. Numerical data, giving the raw test values, are in the data bank.
 - e. Sources of Data--Government reports.
 - f. Analyses Performed--The data center does not perform any analysis but post-processing programs are available so users can analyze the data themselves.
 - g. Methods of Dissemination--There is on-line access to the numeric data base and reference to hard copies of the carbon awareness bulletin, cutting plans, data sheets, and test method sheets.
 - h. Users of Data--Users are limited to those approved by the Air Force.
 - i. Price Schedule--There are charges for hard copy material.
6. Metals and Ceramics Information Center
- a. Owner--Department of Defense.
 - b. Maintainer of the Data Base--Battelle-Columbus Laboratories, Columbus, Ohio 43201. Contact Harold Mindlin at (614) 424-4425.
 - c. Materials Included--Wide range of metallic alloys and selected ceramics with emphasis on materials used in aerospace applications, military ground equipment, and various weapons systems.
 - d. Properties--Physical and mechanical properties used in structural design. Physical properties include thermal, electrical, and magnetic. Mechanical properties include tensile, fracture, impact, shear, bearing, fatigue, creep as well as the influence of fabrication history and service environments on these properties.
 - e. Sources of Data--Government reports, open literature, and private communication.
 - f. Analyses Performed--Data is carefully characterized and sources are given. Both tabular and graphical presentations are used, supplemented by statistical analyses where appropriate. Special attention is given to deriving information from the data which will help the designer avoid problems in application of specific materials.
 - g. Methods of Dissemination--The center issues a monthly Current Awareness Bulletin that gives an overview of new developments in the fields of metallic alloys and ceramics and includes a detailed reference listing. In addition, the center publishes the Aerospace Structural Metals Handbook, a five volume compilation of physical and mechanical properties of steels, light metals, superalloys, and refractory metals, which is updated on a quarterly basis. Other special compilations of materials properties data are published from time to time.
 - h. Users of Data--Anyone needing information can have access to it.
 - i. Price Schedule--The Current Awareness Bulletin is available without charge to all qualified users in the United States. In general, these users would include the federal agencies and their contractors. The Aerospace Structural Metals Handbook and other data compilations are available on a price schedule.

7. Military Handbook 5 Data Base

- a. Owner and Sources of Funds--U.S. Air Force, U.S. Army, and Federal Aviation Administration.
- b. Maintainer of Data Base--Battelle-Columbus Laboratories, Columbus, Ohio 43201. Contact Harold Mindlin at (614) 424-4425.
- c. Materials Included--Aerospace materials.
- d. Properties--Raw test data are contained on cards. These include the tensile yield elongation, bearing compressive shear, temperature effects, creep, stress, rupture, fatigue, fracture, fatigue crack propagation, and the strength of joints, both mechanical and welded.
- e. Sources of Data--Government reports and contractor reports.
- f. Analyses Performed--Statistical analyses are performed on the data and the 90 and 95 percent values at 95 percent confidence are shown for the recommended design allowables. Regression analyses are performed to identify factors that influence properties, curve-fitting, both linear and nonlinear, plotting of the data and ratioing is performed for properties at elevated temperatures compared to the properties at room temperatures.
- g. Methods of Dissemination--Data are disseminated through Military Handbook 5 which is available upon request.
- h. Users of Data--Anyone can have access to this information by phoning the Naval Publications Office in Philadelphia.
- i. Price Schedule--There is no charge for the handbook.

8. Fossil Energy Material Properties

- a. Owner--Department of Energy.
- b. Maintainer of Data Base--National Bureau of Standards, Center for Materials Science, Washington, D.C.
- c. Materials Included--Alloys and refractories that have been considered for coal conversion plants.
- d. Properties--Creep at elevated temperature, corrosion, tensile, and stress-strain.
- e. Sources of Data--Material contractors reports to the Department of Energy.
- f. Analyses Performed--Most of the test results are single values. When multiple values exist, statistical analysis will be performed.
- g. Methods of Dissemination--A data book containing this information is being published.
- h. Users of Data--DOE contractors and anyone requesting the information.
- i. Price Schedule--There will be a charge for the published book.

9. Materials and Components Plant Performance Data Base

- a. Owner--The Department of Energy.
- b. Maintainer of Data Base--National Bureau of Standards, Center for Materials Science, Washington, D.C.
- c. Materials Included--Alloys and refractories actually in use in coal conversion plants.

- d. Properties--Failures actually occurring in operating conditions. Given are the time and the operating conditions, the failure analysis made on the materials, and any recommendations to eliminate them in the future.
 - e. Sources of Data--This information was supplied through voluntary information exchange program by the Department of Energy.
 - f. Analyses Performed--There will be various types of analysis performed on the data to show the type of failure modes occurring on the different components and the components that have like types of failures and other analyses as needed to enable coal conversion plant designers to better utilize materials.
 - g. Methods of Dissemination--Information is disseminated by answering directly any phone or written request. In the future this information will be made available through direct access by computer on a national network.
 - h. Users of Data--Anyone who requests the information.
 - i. Price Schedule--There are no charges for the information.
10. Mechanical Property Data Analysis Center
- a. Owner--Department of Energy.
 - b. Maintainer of Data Base--Oak Ridge National Laboratory, Oak Ridge, Tennessee.
 - c. Materials Included--304 and 316 stainless, 2-1/4 chrome-one moly, 9 chrome-one moly, 1718 alloy, 800, and 800H.
 - d. Properties--Mechanical properties include tensile, creep, and fatigue at room temperature and elevated temperature. Raw test data are included.
 - e. Sources of Data--The data in this bank were obtained primarily from the Department of Energy laboratories and contractors. Some data were obtained from the literature.
 - f. Analyses Performed--Mathematical modeling is used to show the behavior of the material useful for design purposes. This includes average trend lines of the properties as a function of temperature and the variability of these properties from lot to lot.
 - g. Methods of Dissemination--The analyzed data are distributed in hard copy form by specific request and in the Nuclear Systems Materials Handbook.
 - h. Users of Data--Department of Energy, Breeder Reactor Program Contractors.
 - i. Price Schedule--There are no charges made to the above contractors.
11. Copper Development Association Bibliography
- a. Owner--Copper Development Association.
 - b. Maintainer of Data Base--Battelle-Columbus Laboratories, Columbus, Ohio 43201.
 - c. Materials Included--Copper and copper alloys.

- d. Properties--Bibliographic information. References are included for copper and copper alloys from mining through production and to the end use of copper and copper alloys.
- e. Sources of Data--Open literature, government reports, patents, and industry reports.
- f. Analyses Performed--Since this is bibliographic, no analysis can be performed.
- g. Methods of Dissemination--The bibliographic references are on-line to all the members of the Copper Development Association (CDA). From the bibliographic references, users identify extracts of primary data that has been published in volumes called the CDA extracts. Searching the on-line system, users identify reference numbers of the extracts that contain specific data needed. If the extracts do not contain a sufficient amount of information, complete copies of the report can be obtained from Battelle.
- h. Users of Data--Members of the Copper Development Association.
- i. Price Schedule--The service is included in the price of membership to the CDA.

12. World Aluminum Abstracts

Published by Metals Information (U.S. office) for the Aluminum Association (New York) European Primary Aluminum Association and Aluminum Development Association (Australia).

- a. Frequency--Monthly with annual cumulations.
- b. Coverage--The world's technical literature on aluminum, including government reports and world patents, taken from more than 1600 publications.
- c. Subject Scope--Aluminum industry; ores, alumina production, extraction; melting, casting, foundry; metalworking, fabrication, finishing; physical and mechanical metallurgy; engineering properties and tests; quality control and testing; and end uses.
- d. On-Line Availability--The complete data base, representing over 75,000 references entered since 1968, also is available on magnetic tapes, both for lease and for on-line computer searching through ASM, DIALOG Information Services, Inc., QL Systems (Canada), and ESA Information Retrieval Service (Italy). For details on magnetic tapes contact Metals Information (U.S. office).
- e. Prices--General, \$90; Public, universities, and libraries, \$60. Also published by Metals Information and available from the Aluminum Association in The Thesaurus of Aluminum Technology (Third Edition 1980) at a cost of \$25 (order from The Aluminum Association, 818 Connecticut Avenue, N.W., Washington, D.C. 20006).

13. METADEX Data Base

METADEX is metals abstracts, metals abstracts indices, and alloys indices issued on magnetic tape for computer searching. It offers comprehensive access to the world's published metals literature from January 1966 to the present and contains some 450,000 records.

- a. Frequency--A monthly tape is issued.
- b. Coverage--Each year more than 33,000 scientific and technical papers enter the METADEX data base; over 450,000 are now computer-searchable, covering over 1200 journals, the international conference and technical book literature, and patents and dissertations.
- c. Subject Scope--All aspects of the science and technology of metals are covered: constitution (11), crystal properties (12), lattice defects (13), structural hardening (14), physics of metals (15), irradiation effects (16), metallography (21), testing control (22), analysis (23), mechanical properties (31), physical properties (32), electrical and magnetic phenomena (33), Chemical and electrochemical properties (34), corrosion (35), ores and raw materials (41), extraction and smelting (42), refining and purification (43), physical chemistry of extraction and refining (44), ferrous alloy production (45), nonferrous alloy production (46), foundry (51), working (52), machining (53), powder technology (54), joining (55), thermal treatment (56), finishing (57), metallic coating (58), engineering components and structures (61), composites (62), electronic devices (63), general and nonclassified (71), special publications (72).
- d. Format--From 1966 the data base contains full bibliographic citations together with indices identifying authors, materials, properties, processes, products, and applications. From 1974 there are additional indices that locate specific alloys, intermetallic compounds, and metallurgical systems. From 1979 the full text of the abstract has been included with each citation.
- e. Tape Lease--METADEX is available for lease to organizations with their own computer facilities. Tapes are IBM computer-generated and supplied in 800 or 1600 bpi, 9 track format. The file is updated monthly.
- f. On-Line Availability--METADEX also is available on-line from ESA/IRS (Rome), QL Systems (Canada), DIALOG Information Services, Inc. (USA), and FiZ4 (Germany). This permits direct access to the METADEX data base and its interrogative searching from remote locations through computer terminals that are connected to the host computers by telephone lines. There are many thousands of such terminals giving worldwide access to METADEX via on-line systems. For information about on-line access to METADEX, or the availability of training courses on the use of METADEX on-line, please contact Metals Information.

Appendix G

THE ROLE OF CURRENT COMPUTER TECHNOLOGY IN ESTABLISHING A NATIONAL MATERIALS PROPERTIES DATA BASE

INTRODUCTION

The United States now is at the junction of two technical high-speed throughways. The first is the continuing explosion of new materials being developed and subsequently being subjected to a wide range of testing to determine properties characteristics. The second is the rapid evolution of computers and the ability to store and retrieve specific information from large masses of data. An opportunity now exists to merge these two technologies and produce an automated computer base of materials properties data that could facilitate computer-aided and conventional design of American hardware products and result in increased productivity. The purpose of this appendix is to identify computer-related options now available for implementing such a data base and the areas requiring technical planning and decisions before such a data base can become a reality.

DATA BASE SYSTEMS

Before considering the specific types of materials data that could possibly comprise a data base, it is useful to review, from a more generic perspective, the components of any data base system. Figure G-1 presents Ullman's (1980) general representation of a data base system.

Level I is the physical data base and represents the storage of the actual experimental data--in this case, the materials properties. Level II is the conceptual data base and represents the philosophy of how the physical data are organized and categorized. There currently are reported to be three principal philosophies of data base organization as presented by Ullman and others (Gardenas 1979, Booth 1981, Champine 1980): hierarchical,

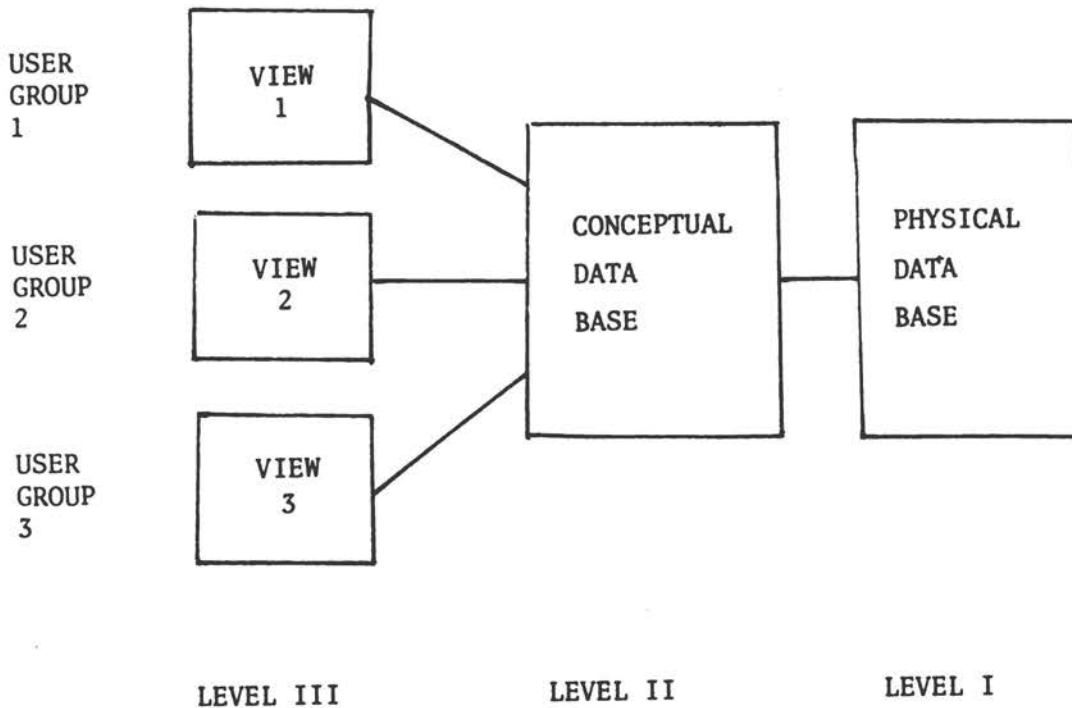

FIGURE G-1 Levels of data base abstraction (Ullman 1980).

network, and relational. A detailed description of these philosophies will not be given here, but it is important to note that each format for the conceptual data base carries with it advantages and disadvantages with respect to accessing and efficiently searching the physical data base. Finally, Level III represents specific viewpoints to be constructed for the potential use of the data base. These viewpoints depend on the specific needs of each potential user group that may wish to access the data base.

By exploring each level of a general data base, the specific problems and areas for technical decisions can be identified as they relate to the particular case of a materials data base. In addition, other problem areas can be identified when the three level system as a whole is considered. It is also useful to categorize the problem areas into those related to the hardware or actual computer equipment and those related to the software or the computer programs that manipulate the data. The remainder of this report will consider each of these areas; first the overall system will be examined and then each level in turn.

AN OVERALL LOOK

The first major decision to be made in planning the overall system for a data base involves choosing the type of computer system that will best suit

the situation. Three broad types of systems can be identified: centralized, decentralized, and distributed.

In a centralized system, all processing and storage of data takes place at one geographic location. This would probably mean the use of one primary brand of computer equipment and system software. Remote terminals could tie into the centralized computer, but they would do no processing but only serve for data input and output. The centralized approach has a number of advantages (Gardenas 1979) in addition to being supported by the manufacturer's software. These include a unified administration of the data base, complete compatibility of hardware and software, and sufficient resources in storage and computing power to handle large computing jobs. The centralized system would perhaps seem the most efficient way to standardize a data base system; however, the reality of the situation is that many potential users of a materials data base already have a considerable investment in their own, computer systems that, taken altogether, comprise a collection of hardware and software from a myriad of manufacturers. In addition, the costs of communication between a centralized processor and remote terminals across the country is not now insignificant and, in fact, is rising while the cost of much equipment used in a decentralized or distributed system is falling.

A decentralized system, is made up of a collection of independent computer systems, which do not communicate, in different geographic locations. The advantage of this type of system design for a data base is that it makes use of existing on-site computing facilities at the locations of potential users. It circumvents the problems of hardware and software incompatibility between computer equipment made by different manufacturers associated with direct communications. However, the mere fact that the computers do not communicate leads to the associated problems of data transfer to and from a common data base. It also leads to problems concerning the format for data storage on some transportable medium (e.g., disks, tapes, or cards) that would make up the data base and be easily useable by all potential computer systems.

A distributed computer system is also a collection of various computer systems in different geographic locations. However, unlike the decentralized system, the computers in the distributed system communicate data and process application software cooperatively. The advantages of this type of system include a potential for rapid communication of data and software between existing machines around the country. In addition, a distributed system can take full advantage of the rapidly developing lines of smaller, less expensive, computing systems and peripheral devices (e.g., plotters and cathode graphics screens). The disadvantages include the possible problems associated with direct communications between the wide range of computing equipment now available. The full magnitude of hardware and software incompatibilities between equipment from different manufacturers must be demonstrated. A survey of current publications (McGraw-Hill 1981a and 1981b) indicates that there are more than 50 manufacturers of microcomputers (e.g., Apple and Radio Shack), some of whom have more than one model. In addition, many establishments possess minicomputers (e.g., DEC or PRIME) along with large main frame computers

(e.g., IBM, CDC, UNIVAC, and Honeywell). A materials data base that would be truly accessible to any potential user on a distributed system would need communications capability with all of these computers in addition to specialty devices such as printers, plotters, and cathode graphics tubes.

Thus, three possibilities exist for the overall configuration of a computer system to support a data base of materials properties. Advantages and disadvantages are associated with each. A thorough study of these options should be made before a commitment is made to any one philosophy of computer processing.

LEVEL I--PHYSICAL DATA BASE

Along with the problems associated with the overall system, each level or subsystem of the data base poses problems for a materials data base. The physical data base contains the storage of the raw data; therefore, a decision must be made regarding which data are to be saved. In the case of a materials data base, the data can be grouped into two types. The first is the actual data as taken from a specific test. For example, a materials data base could include actual stress and strain values from each tensile test that is accepted into the system. Such a mode of data storage would require the physical data base to have the capability of possessing variable-length records. The second type of raw data would be the specific properties to be saved from such an array of physical test results. In the case of tensile data, these values would be quantities such as Young's Modulus, Poisson's ratio, 0.2 percent yield strength, ultimate tensile strength, reduction in area, and percent elongation. In the case of the second data type, a fixed record length could be established for whatever engineering properties are included. Once the specific data to be stored in the data base are determined, there appears to be no major problem in formatting the data in the computer system. A problem does arise, however, with respect to identifying the device for storing the physical data base. For the centralized or distributed systems, the data base most likely would reside on disk and/or magnetic tape. For the decentralized system, the physical data base would be placed on a transportable medium such as tapes or cards.

A problem that could arise with the physical data base is one of size. An estimation should be made of how many raw pieces of data eventually would be saved within such a system and of the storage capacity that would be required.

LEVEL II - CONCEPTUAL DATA BASE

The conceptual data base represents the philosophy adopted regarding the organization of the data in the physical data base. It is not as simple as just saying that the values of the yield strength, ultimate tensile strength, etc., will be stored and located with the corresponding materials (e.g., 7075-T6). The philosophy of the data base will be governed in part by the types of searches that would be anticipated by designers of the base. For example, a user might ask: "What is the stress strain curve for 7075-76

at room temperature and at a given strain rate?" Alternately, another user might ask: "What materials in the data base possess a yield strength of 50 ksi \pm 5 percent at room temperature?" A third might ask: "What material has the best ratio of ultimate tensile strength to weight density?"

Each question would require a different searching philosophy and different post-search calculations. The three principal philosophies of data base organization mentioned above have structures that facilitate various types of searches. A conceptual data base for a materials data base would require that a decision be made regarding which philosophy would best accommodate the types of searches anticipated. Thus, a good deal of thought must be put into defining the possible uses to which the materials data base will be put. This overlaps into the Level III area of user viewpoints.

The identifiers to be used for each data entry also must be determined. For example, each data point would be associated with a specific material, but it must be decided how the material would be identified. Would a steel be identified by an AISI number or an SAE number? The computer files could be established easily with an internal, unique, numerical identification. However, its relationship to various society or association identifications could pose a problem.

With the adoption of a philosophy for the conceptual data base, a programming data base language to manipulate the data stored in the physical data base and to interact with the user must be evolved. This language is required to enable the user to obtain the information that he wants while keeping the terms needed to communicate with the data base system as close to standard English terminology as possible. In other words, when an engineer or scientist seeks some data from a handbook, he has no problem with the language (English) or the conventional organization procedures employed in most books. It is important that the data base language be easy to use and not require the user to learn a significantly new language.

The programming data base language can be written in available system languages such as FORTRAN. However, it must be possible for the data base language to transmit the actual data and to be communicated through the system software of the wide variety of computer hardware now available. It appears from the literature (Lide 1981, Williams 1980, Gubiotti et al. 1981) that such problems, while not insurmountable, have not yet been completely solved.

LEVEL III - USER VIEWPOINTS

As mentioned above, the potential users of the data base and the possible information they will require must be determined carefully because of their great influence on the conceptual data base philosophy. It also is necessary to review the possible formats for user interaction with the data base. Information can be added by users of the system through various possible means. These include transportable media such as data sheets, punched cards, and formatted magnetic tapes. In the case of terminal interaction, data can be added directly through a keyboard to a prescribed

menu or even from real-time monitoring of a particular test specimen. Each method must be evaluated with respect to the possible system options identified earlier.

The manner in which a user obtains the information from the data base also must be evaluated before a data base can be established. For example, a user could obtain the entire data base in a prescribed format on a magnetic tape for use on his own computer system in a decentralized mode. He then could analyze the data on his own system with his own analysis software and display programs. Alternately, specific information could be provided to a user in tabulated print-out form or graphical plotter/cathode tube display from a host computer in either the centralized or distributed computing modes. Thus, it must be determined whether all raw data should be made available to the user or whether averaged and/or limiting values should be given. For example, if there were 100 stress-strain curves in the data base for 7075-T6, the user could be given a curve representing the average value curve for, say, room temperature and a given strain rate with perhaps some scatter band or the entire 100 plots.

The final point to be raised is the need to specifically determine the anticipated clientele of the data base and their hardware requirements. Given that potential participants include government agencies, large companies, and technical societies (most of which already have established data bases on large computers for specific materials) as well as smaller companies and divisions and with individual engineers and scientists who are obtaining microcomputer systems, the influence of the anticipated clientele on the data base structure is obvious.

CONCLUSIONS

Whether at the level of considering a materials data base as a complete system or when looking at the individual levels of the data base subsystems, the technical means to achieve a computerized data base appear to exist. At each level, however, various alternatives exist that affect the structure, equipment, searching strategies, efficiency, ease of implementation, and cost of establishing such a data base. When coupled with the social, commercial, and technical requirements placed on a data base, the feasibility and proper course needed to bring it to reality must result from considerable thorough planning, evaluation, and optimization.

REFERENCES

- Booth, G. M. 1981. The Distributed System Environment. New York, New York: McGraw-Hill Book Co.
- Champine, G. A. 1980. Distributed Computer Systems. New York, New York: North-Holland Publishing Co.
- Gardenas, A. F. 1979. Data Base Management Systems. Boston, Massachusetts: Allyn and Bacon, Inc.
- Gubiotti, R., H. Mindlin, and G. Kovacs. 1981. Experiences in creating an on-line numeric data base system - mechanical properties data center. Paper submitted at the National Online Information Meeting, New York, New York, March 1981.

- Lide, D. R., Jr. 1981. Critical data for critical needs. *Science* 212(4501):1343-49.
- McGraw-Hill. 1981a. *The Small Systems Journal* (October). New York, New York: McGraw-Hill Publication.
- McGraw-Hill. 1981b. *Popular Computing* (November). New York, New York: McGraw-Hill Publication.
- Ullman, J. D. 1980. *Principles of Data Base Systems*. Potomac, Maryland: Computer Science Press, Inc.
- Williams, M. E. 1980. Elements of a distributed transparent information retrieval system. *Communicating Information, proceedings of the 43rd ASIS Meeting, Vol. 17*. Washington, D.C.: American Society for Information Scientists.

Appendix H

DEMONSTRATION OF AN EXPERIMENTAL MATERIALS KNOWLEDGE BASE USING LOGIC PROGRAMMING

Volker Weiss
Syracuse University
Syracuse, New York

The use of logic programming (LOGLISP) in connection with the materials properties knowledge base recently has been demonstrated by V. Weiss at Syracuse University. The knowledge base uses the LOGLISP system that was developed by Professors J. A. Robinson and E. E. Sibert, also of Syracuse University (Robinson and Sibert 1981).

LOGLISP, a novel programming language, combines a very successful old language (LISP) based on "traditional" programming ideas with a new one (LOGIC) based on the idea of logic programming. The resulting hybrid is a higher-level language than LISP and a richer, more convenient language for logic programming than PROLOG, the only other available logic programming system. Languages like LOGLISP and PROLOG are attracting attention at the moment because of a massive 10-year national project, called the Fifth Generation Computer System Project, being undertaken by the Japanese Ministry of International Trade and Industry. The Japanese project calls for the creation, by 1990, of a family of super computers whose design is based on the logic programming paradigm. One aim is that the communication between user and machine (in both directions) will be in spoken natural language. The machine will be capable of a wide range of intelligent behavior including much of today's routine professional expertise in medicine, engineering, education, and management.

In the United States and in Europe, logic programming systems such as LOGLISP are under development with much the same sort of aim as that of the Japanese project. Something of a revolution in many application areas, in particular in the field of data base management, is foreseen. Logic programming allows the creation of "intelligent" on-line deductive data

bases that can be queried in unanticipated ways (ad hoc querying) and that can respond rapidly by means of purposeful, efficient, and fully automatic deductive reasoning.

LISP is a flexible, sophisticated programming language. It can treat its own programs and control mechanisms as data objects. LISP's simple recursive data structures are enormously powerful and versatile. It has become the programming language of choice for the artificial intelligence research community and has a 20-year track record of complex experimental software applications.

Logic programming is a method of programming by making assertions rather than by issuing commands. The assertions, in no particular order, form the "logic program." Running a logic program consists of deducing logical consequences from it. The deduction is entirely automatic. Logic programming was invented in 1972 by Alain Colmerauer (Colmerauer et al. 1973) in France and Robert Kowalski (1974) in Great Britain. It is an ingenious application of the general system of machine-oriented logic called "resolution," which was discovered by John A. Robinson in 1963 (Robinson 1965). Resolution is based on a fundamental process of symbolic computation called "unification"--which turns out now to be the main driving force of the "inference engines" used to process logic programming.

Logic programming has many advantages over traditional programming:

1. It makes programming more "natural" (i.e., much simpler, much clearer, and considerably more intelligent).
2. Logic programs are highly modular (i.e., each asserted sentence is actually an independent module) and structured (i.e., one can group sentences into subprograms dealing with one idea).
3. Logic computing is similar to purposive thinking; therefore, logic programming is more like explaining something to somebody. Computations are perceived as attempts to solve problems or to answer questions. The outcome of these attempts depends naturally and directly on "what is known" (i.e., what sentences are in the logic program).
4. The programmer need not worry about controlling the flow of events inside the machine about explicitly constructing or decomposing data objects.

Combining logic with LISP has produced, in LOGLISP, a much higher level language than LISP is without logic.

The experimental knowledge base "materials" developed at Syracuse, contains assertions that consist of data and rules. The data have the forms:

```
(|- (Is ST4340 400. TS 272.0))
(|- (Is ST4340 800. KIC 65.0))
```

The first of these states that the tensile strength of steel 4340 in condition 400, which refers here to the tempering temperature, is 272 ksi. The second line states that the fracture toughness of steel 4340 in condition 800 (i.e. tempered at 800 °F) is 65 kis- $\sqrt{\text{in}}$.

Rules have the forms:

```
(i- (Is ST4340 cond DEN 0.28000000))
(i- (CL mat1 cond (% (SQR (% k/y)) 3.1415925))
    <- (Is mat1 cond KIC k)
    & (Is mat1 cond YS y))
```

The first rule states that the density of 4340 steels in any condition is 0.28 pounds per cubic inch and the second uses the well known formula for calculating the critical crack length (i.e., $Cc1 = (k/y)^2/\pi$ as it is expressed in LISP).

At present, the knowledge base contains about 300 assertions representing data on some 43 materials. The properties that are listed are tensile strength (TS), yield strength (YS), compression strength (CS), shear strength (SS), tensile strength transverse (TST), compressive strength transverse (CST), fracture toughness (KIC), density (DEN), price (PR), elastic modulus (EMOD), elastic modulus in the transverse direction (EMODT), shear modulus (SMOD), elastic modulus in compression (EMODC), Poisson's ratio (POIR). For most materials, only a few of these properties are entered in the present experimental data base. For example, for ST4340 at 800 °F, the knowledge base contains the tensile strength, the yield strength, the Rockwell-C hardness, the fracture toughness, the elastic modulus, and the price whereas for sintered bronze powder, the knowledge base contains only the tensile strength, the yield strength, the fracture toughness, the density, and the price. It is easy to query the knowledge base for this type of information, as shown below:

```
*(THE x (Is ST4340 800 KIC x))
65.0

*(THE (t p) (Is PMBRONZE SIN TS t) (Is PMBRONZE SIN PR p))
(18.0 1.75)
```

It also is quite easy to get a tabulated listing of all materials in the data base, whether the properties are known or not, as illustrated in Table H-1, which is the response to the query given here. In this case, LISP is used to store the question and for a heading for the table as values of the (LISP) variables QMATLS and HEADER.

```
*(SPRINT QMATLS)
(QUICKSORT (ALL (mat cond
                ts
                ys
                kic
                (FLT-STR-SG den 3.)
                (FLT-STR-FX pri 3. 2.))
            (Is mat cond TS ts)
            (Is? mat cond YS ys)
            (Is? mat cond KIC kic)
            (Is? mat cond DEN den)
            (Is? mat cond PR pri)
            (DECREASING)
            3.)
```

Table H-1 The Materials and Their Principal Properties in Order of Decreasing Tensile Strength

Mat	Cond	Tens	Yield	K _{IC}	Den	Price
ST4340	400.	272.0	243.0	40.0	0.280	0.75
CSIC-AL	VF50	262.0	-	-	0.950E-1	-
ST4340	600.	250.0	230.0	55.0	0.280	0.75
ST4130	400.	236.0	212.0	35.0	0.280	0.65
CSGLA-EPO	VF60	230.0	-	-	0.730E-1	-
ST4130	600.	217.0	200.0	40.0	0.280	0.65
ST4340	800.	213.0	198.0	65.0	0.280	0.75
ST4130	800.	186.0	173.0	45.0	0.280	0.65
CKEV-EPO	VF60	180.0	-	-	0.500E-1	-
CBOR-EPO	VF60	180.0	-	-	0.730E-1	-
CGRA-EPO	VF60HS	180.0	-	-	0.570E-1	-
ST4340	1000.	170.0	156.0	75.0	0.280	0.75
ST1060	400.	160.0	113.0	75.0	-	0.50
ST1060	600.	160.0	113.0	80.0	-	0.50
ST4130	1000.	150.0	132.0	55.0	0.280	0.65
CEGLA-EPO	VF60	150.0	-	-	0.750E-1	-
ST4340	1200.	140.0	124.0	95.0	0.280	0.75
ST1060	1000.	140.0	97.0	110.0	-	0.50
TI6AL4V	ANN	130.0	120.0	80.0	0.160	7.50
CGRA-AL	VF40-1100	128.0	-	-	-	-
TI811	ANN	125.0	115.0	60.0	0.156	6.50
ST4130	1200.	118.0	102.0	60.0	0.280	0.65
SS301	ANN	110.0	40.0	140.0	0.280	0.95
SS440C	cond	110.0	65.0	-	0.290	2.35
CGRA-EPO	VF60HM	110.0	-	-	0.590E-1	-
CGRA-AL	VF32-201	100.0	-	-	0.910E-1	150.00
ST1060	ANN	90.75	54.0	100.0	-	0.50
CGRA-EPO	VF60UHM	90.0	-	-	0.610E-1	-
SS316	ANN	82.0	35.0	145.0	0.280	1.05
AL7075	T76	76.0	65.0	25.0	0.101	2.50
ST1030	cond	75.5	50.0	120.0	0.280	0.40
ST960X	AR	75.0	60.0	130.0	0.280	0.45
SS410	cond	72.0	42.0	60.0	0.290	2.25
PMCUST	SIN	66.0	-	25.0	0.200	1.15
ST1015	HR	61.0	45.5	130.0	0.280	0.40
TI00	cond	60.0	45.0	70.0	0.163	5.00
AL6061	T6	45.0	40.0	40.0	0.101	1.50
PMFE	SIN	40.0	26.0	30.0	0.240	0.85
AL5052	H32	35.0	20.0	35.0	0.970E-1	1.25
PMAL601	HT	34.5	33.5	10.0	0.900E-1	3.45
AL2219	T351	25.0	11.0	50.0	0.101	0.50
AL1100	00	24.0	13.0	120.0	0.101	3.50
PMBRONZE	SIN	18.0	17.5	15.0	0.240	1.75

***HEADER**

(MAT COND TENS YIELD KIC DEN PRICE)

***(DISPLAY (EVAL QMATLS) HEADER)**

[See Table H-1 for output]

The table is arranged in order of decreasing tensile strength. Whenever a value for a property called for is not available, the system prints a "-", as for the yield strength, the fracture toughness, and the price of the composite silicon carbide aluminum (CGRA-A1) with volume fraction 50 percent. DISPLAY is a rather simple, easy-to-use program that produces fairly neat output at the terminal, and we have also specified numeric formatting for the density and price. Of course, one would do more elaborate formatting for tables intended for formal publication. Alphabetic sorting by material also is quite easily accomplished as indicated in Table H-2.

A typical example of an ad hoc question would be a listing of those materials that have a critical crack length larger than that of ST1060 tempered at 400 and to list the name of the material, the condition, the yield strength, the density ratio, and the critical crack length. The question as well as the response are shown in Table H-3.

Another example of an ad hoc question would be to determine which materials, for which the transverse tensile strength and the ratio of tensile strength to density are known (Table H-4), have a tensile strength larger than 130 ksi. The question is:

```
*(SPRINT QTST)
(ALL (mat cond ts tst tdr)
  (Is mat cond TS ts)
  (> ts 130.0)
  (Is mat cond TST tst)
  (RXDEN mat cond ts tdr))
```

The relation RXDEN is used here to obtain the ratio of tensile strength to density. It is defined by the rule:

```
(!- (RXDEN mat cond x (% x den))
  < - (Is mat cond DEN den))
```

LISP also asked to time the processing of the question, in which 61 deduction steps were required. Most of the time was spent typing the answer on the terminal. The result is as follows:

```
825. msec CPU, 14350. msec clock, 2182. conses
61. resolvents generated
```

The system may be queried as to how any of the conclusions were reached in any of the previous examples.

Graphic representation of data or sets of data also is possible. The quality of the presentation depends on the display system available. For this demonstration, a small program that permits plotting on an ordinary

Table H-2 Tensile Strengths and Yield Strengths Alphabetically
by Material

Mat	Cond	TS	YS
AL7075	T76	76.0	65.0
SS440C	cond	110.0	65.0
ST1060	400.	160.0	113.0
ST1060	600.	160.0	113.0
ST1060	ANN	90.75	54.0
ST1060	1000.	140.0	97.0
ST4130	1200.	118.0	102.0
ST4130	600.	217.0	200.0
ST4130	1000.	150.0	132.0
ST4130	800.	186.0	173.0
ST4130	400.	236.0	212.0
ST4340	800.	213.0	198.0
ST4340	400.	272.0	243.0
ST4340	1000.	170.0	156.0
ST4340	600.	250.0	230.0
ST4340	1200.	140.0	124.0
ST960X	AR	75.0	60.0
TI6AL4V	ANN	130.0	120.0
TI811	ANN	125.0	115.0

```

*(SPRINT QA)
  (QUICKSORT (ALL (mat cond ts ys)
                (Is? mat cond TS ts)
                (Is mat cond YS ys)
                (>ys 50.0))
             (ALPHABETICALLY)
             1.)

```

```

*(DISPLAY (EVAL QA) '(Mat Cond ts ys))

```

Table H-3 Materials Having a Critical Crack Length Larger Than
ST 1060 Tempered at 400

Mat	Cond	YS/Den	YS	Cc1
TI6AL4V	ANN	750.0	120.0	0.141
AL2219	T351	108.91089	11.0	6.577
SS410	cond	144.82758	42.0	0.650
ST4340	1200.	442.85713	124.0	0.187
SS316	ANN	124.99999	35.0	5.463
TI00	cond	276.07361	45.0	0.770
ST960X	AR	214.28571	60.0	1.494
ST1015	HR	162.5	45.5	2.598
ST1030	cond	178.57142	50.0	1.833
SS301	ANN	142.85714	40.0	3.899
AL6061	T6	396.03960	40.0	0.318

*(SPRINT Q6)

(ALL (mat1 cond rys-den ys (FLT-STR-FX c1 3. 3.))
(CL ST1060 400. c11)
(CL mat1 cond c1)
(> c1 c11)
(Is mat1 cond YS ys)
(RYS-DEN mat1 cond rys-den))

*(DISPLAY (EVAL Q6) '(Mat Cond ys//Den ys Cc1))

Table H-4 Materials Having Tensile Strength Greater Than 130 KSI for
Known Transverse Tensile Strength and Ratio of Tensile Strength to Density

Mat	Cond	TS	TST	TS/DEN
CBOR-EPO	VF60	180.0	10.0	2465.7534
CGRA-EPO	VF60HS	180.0	6.0	3157.8947
CKEV-EPO	VF60	180.0	4.3000000	3600.0
CGLA-EPO	VF60	230.0	7.0	3150.6849
CEGLA-EPO	VF60	150.0	7.0	2000.0
CSIC-AL	VF50	262.0	13.299998	2757.8946

*(LTIMER (DISPLAY (EVAL QTST) '(Mat Cond ts tst ts//Den)))

terminal with no special graphics features was written. An example of a plot of yield strength versus tensile strength of all data is given in Figure H-1.

A program for selection of materials for a given design application can be readily formulated. The example presented below describes such a program for the design of a simple tensile member. The program is arranged in a conversational mode and requests as input the load in KIPS, the safety factor (sf), the maximum diameter (dia) permissible in inches, and the maximum weight per unit length in pounds per inch. The following input values will be used for the example: load = 200 KIPS, sf = 1.75, maximum permissible diameter = 1.5 in., and maximum weight per unit length = 1 lb/in. From the limited materials properties data base, Table H-1, the program produces the information in Table H-5, which lists materials meeting the input requirements in order of decreasing yield strength.

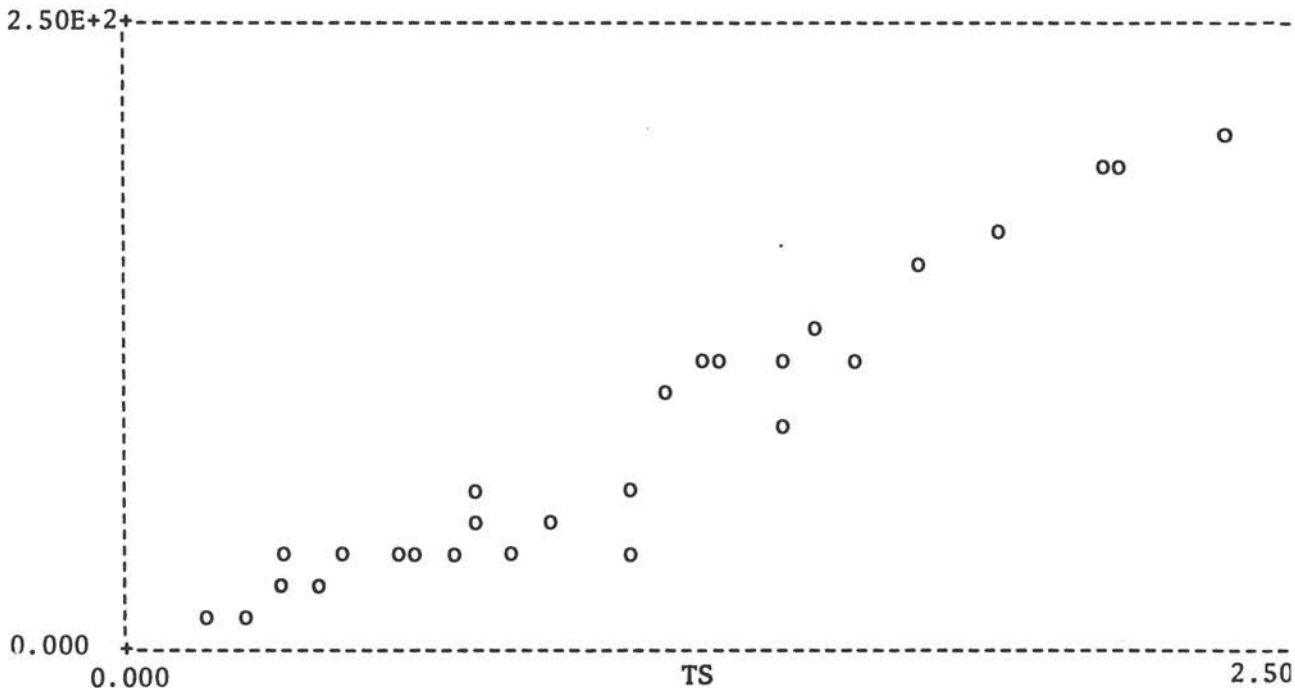

```
*TSYS
(ALL (x y) (Is mat cond TS x) (Is mat cond YS y))
*(PLOT (EVAL TSYS) '(0 250) '(0 250) '(Ys t s))
```

FIGURE H-1 Yield strength versus tensile strength (all materials).

Table H-5 Results for the Example Program for Design of a Simple Tensile Member

Mat	Cond	YS	Dia
ST4340	400.	243.0	0.88653878
ST4340	600.	230.0	0.91124878
ST4130	400.	212.0	0.94914583
ST4130	600.	200.0	0.97720544
ST4340	800.	198.0	0.98212842
ST4130	800.	173.0	1.0506978
ST4340	1000.	156.0	1.1064672
ST4130	1000.	132.0	1.2028567
ST4340	1200.	124.0	1.2410521
TI6AL4V	ANN	120.0	1.2615668
TI811	ANN	115.0	1.2887003
ST4130	1200.	102.0	1.3683613
PMST	HSIN	91.0	1.4487057

(EVAL QTEN)

For this program, the rules are as follows: Tensile-memb which in itself calls on three rules--WUL, AR, and dia. AR is the ratio of the load times safety factor divided by the yield strength. WUL is the weight per unit length equal to the product of density and area. Dia. is calculated from the area (ar). The query and the program rules are shown in LOGLISP form below:

```
*(SPRINT QTEN)
(DISPLAY (QUICKSORT (ALL (mat cond ys dia)
  (Tensile-memb mat cond 100. 1.5 ys ar wul)
  (= dia (*2. (SQRT (% ar (PI))))))
  (<= dia 1.5)
  (<= wul 5.))
  (DECREASING)
  3.)
'(Mat Cond Ys Dia))
```

NIL

```
*( P Tensile-memb)
```

```
(PROCEDURE Tensile-memb)
```

```
(|- (Tensile-memb mat cond p sf ys ar wul)
  < - (Is mat cond YS ys)
  & (WUL mat cond (* p sf) ar wul))
(PP WUL)
```

```
(|- (WUL mat cond p ar (* ar den))
  < - (Is mat cond DEN den)
  & (AR mat cond p ar))
```

*(PP AR)

(PROCEDURE AR)

(!- (AR mat1 cond p (% p ys)) <- (Is mat1 cond YS ys))

*

The system easily can accommodate textual statements as well as more than one value per property for a given material and condition. LISP functions can be developed to operate on the knowledge base such that, for instance, typical properties or average properties are reported or that lower or upper bound properties are reported or that properties having a certain confidence limit are reported. The flexibility of the system and the ease with which queries can be constructed by noncomputer specialists should make it particularly attractive to data base management not only for material selection and design but for general applications in knowledge base management where there is a premium on ad hoc querying. Eventually it is hoped that logic programming systems such as LOGLISP, perhaps coupled with finite element programs, would lead to a system that will enable the design of critical components to certain specifications.

REFERENCES

- Colmerauer, A., H. Kanoui, R. Pasero, and P. Roussel. 1973. Un Système de Communication Homme-machine en Français. Rapport, Groupe Intelligence Artificielle. Luminy, France: Université d'Aix-Marseille.
- Kowalski, R. A. 1974. Predicate Logic as Programming Language. Proceedings IFIP Congress, 1974. Geneva, Switzerland: International Federation for Information Processing.
- Robinson, J. A., and E. E. Sibert. 1981. The LOGLISP User's Manual. Syracuse, New York: School of Computer and Information Science, Syracuse University.
- Robinson, J. A. 1965. A machine-oriented logic based on the resolution principle. Journal of the Association for Computing Machinery 12:23-41.

Appendix I

COMPUTERIZED MATERIALS DATA SYSTEMS - THE PROCEEDINGS OF A WORKSHOP DEVOTED TO DISCUSSION OF PROBLEMS CONFRONTING THEIR DEVELOPMENT Fairfield Glade, Tennessee, November 7-11, 1982

J. H. Westbrook and J. R. Rumble, Jr., Editors

(Copyright 1983 by the Steering Committee of the Computerized
Materials Data Workshop. All Rights Reserved)

EXECUTIVE SUMMARY

Materials form the tangible basis of our society and a major component of our economic activity. Materials businesses in the U.S. alone annually contribute over \$200 billion to the gross national product, and manufacturing businesses critically dependent on materials account for several \$100 billion more. Users and producers need reliable materials information for design and selection decisions and computers now make it possible to deliver better information faster and more completely. Such accessibility can have a major impact not only on costs but also on product safety and reliability, the environment, technology, and innovation.

Materials data experts met together with representatives of the materials producer and user communities in November 1982 to discuss computerized data systems for engineering properties of materials. The issues concentrated upon were the feasibility, timeliness, and best mode of development of such a system. The conclusions are summarized below.

GENERAL OBSERVATIONS

- o Computer access to engineering properties of materials is badly needed but does not now exist in any comprehensive way.

- o Direct materials information needs and computerized engineering and manufacturing systems are driving this development.
- o The desired system will not arise spontaneously, and a cooperative effort is required.
- o The participants should include professional societies, trade associations, universities, research institutes, users and generators of materials data, technical publishers, and the government. They should be international in scope.
- o No significant computer barriers exist.
- o A time window now exists for developing this system. Without prompt, cooperative action, either a large unsatisfactory system or uncoordinated independent databases will evolve.

PROBLEMS

- o The major problem is identifying the best group to lead development, raise financial resources, and coordinate technical expertise.
- o The following additional items require attention:
 - Data validation and indication of data quality
 - User-friendly interfaces with the computer
 - Improved economic studies of the value of technical information
 - On-line referral to data collections not yet incorporated in the system
 - Training of users and marketing of computerized systems
 - Standardization and cross-referencing to materials, properties, and test methods

RECOMMENDED CONCEPT

- o The recommended system is a coordinated, distributed system of independent databases, each of limited scope, connected by a common gateway computer in such a manner that the user gains access to all databases with a single phone call.
- o The gateway will provide other features such as standard support programs, on-line directories to data sources, and built-in tutorials.
- o Individual databases will be developed and managed by expert groups.
- o A minimum size is necessary, probably encompassing a few thousand materials and 50 to 100 different properties.
- o Initial emphasis should focus on mechanical and thermal properties of metals which represent the largest amount of available data and greatest demand.

- o A few industrial application areas should be chosen for a pilot system to secure acceptance and allow for orderly growth.
- o The need for materials selection should be served first. Component design and process automation will be covered in the future.

EXPECTED BENEFITS

- o A computerized system of materials data, rather than a multiplicity of handbooks, card files, data centers, etc., provides the user a single source for most information.
- o Other benefits include functions that printed sources perform poorly or not at all:
 - Graphics
 - File inversion or profile matching
 - Unit conversion
 - Integration with design algorithms and CAD/CAM programs
 - Ascertaining equivalency of different materials
- o The following are other positive impacts:
 - Improvements in data standards and data quality
 - Increased awareness of gaps and inconsistencies in the data
 - Attraction of new data into the system from journals, poorly articulated publications, and government reports
- o The proposed integrated system of distributed semiautonomous databases offers many advantages, including the following:
 - Focused expertise in building and maintaining individual databases
 - Easier access and application by users
 - Easier homogenization of database structures
 - Facile expansion
 - Ready tailoring to serve different user markets
 - Easy exploitation of existing database construction
 - Lower total cost
 - Decreased redundancy of effort

Action Plans. The Workshop participants recommend the following specific actions to the Steering Committee and to other leaders in this field:

- o Publish and widely distribute a Workshop report.
- o Endorse and coordinate existing initiatives toward cooperative work in this field, e.g., the Metal Properties Council and CODATA.
- o Request the National Academy of Engineering to review the Workshop report and, if necessary, establish with other groups an Interim Council to undertake the following:

- Define the specific tasks necessary to set up a comprehensive computerized materials property information system
- Identify the permanent leadership to manage and operate the recommended system
- Seek the cooperation and participation of all stakeholder groups
- Involve international groups to the extent feasible and appropriate

CURRICULA VITAE OF COMMITTEE MEMBERS

WILLIAM F. BROWN holds Master of Science and Metallurgical Engineering degrees from Case Institute of Technology. Since 1948 he has been active in the area of fracture and nondestructive testing at NASA-Lewis Research Center where he published 90 technical papers and 3 books on the subject. He presently is a consultant to NASA and is active in a number of professional societies as well as serving in an editorial capacity to several scientific journals on fracture.

WILLIAM D. BEEBY's Bachelor of Science is from Kansas State University. At Boeing Commercial Airplane Company, where he was Director of Engineering Computing Systems until his retirement, he held positions of chief liaison and project engineer for the B47 and 737, respectively, and Manager of Production Engineering Fabrication Division. Mr. Beeby was instrumental in Boeing Company's efforts in applying computers to the design and manufacture of airplanes and has also taken a lead role in establishing computer designs for engineering students at various universities. He now heads his own consulting firm, William Beeby Associates.

LEONARD BEITCH holds a Ph.D. in Aerospace Engineering from the University of Cincinnati. His experience in stress analysis was obtained at McDonnell Aircraft and General Electric, where his various positions involved stress and vibration analysis and early use of computers in design. He is currently Manager of Engineering Mechanics and Life Management with a staff of about 150 engineers and computer programmers.

JOHN A. GRAHAM received his Master of Science degree from Purdue University. He presently holds the position of Manager, Materials Technology, Deere and Company Technical Center. He is active in a number of professional societies and is Editor of SAE Fatigue Design Handbook. He is chairman of the Panel on Mechanical Properties Data for Metals and Alloys of the National Research Council's Numerical Data Advisory Board and Chairman of the Task Group on Intersociety Materials Data of the Metal Properties Council.

C. DALE LITTLE earned his Master of Science degree from Southern Methodist University. Since 1977 he has held the position of Manager, Materials Technology, Structures and Design Department, General Dynamics Corporation, Fort Worth Division. He is actively involved in a number of professional societies, specifically on committees or panels studying materials technology and fracture of materials. He holds patents on methods for testing of composite sandwich structures and high strength fracture resistant weldable steels.

THOMAS A. RICH holds a Ph.D. in mechanical engineering from Lehigh University and a B.S. from Carnegie Mellon University. He was Research Mechanical Engineer at AMMRC, Department of Army, during which time he spent a year as a visiting professor, Mechanical Engineering Department, University of Southampton, England. After teaching at Texas A&M University, he joined Bucknell University, where he is a professor in the Department of Mechanical Engineering. He is active in a number of professional societies and a technical reviewer for several scientific journals.

EDWARD J. RIPLING attended Pennsylvania State University and Case Institute of Technology; he received his Ph.D. in Metallurgical Engineering from Case. He has held positions with Westinghouse Electric Company, Copperweld Steel Company, Continental Can Company, and Assistant Professor and Research Project Director at Case Institute of Technology. He is currently President and Director of Research at the Materials Research Laboratory specializing in fracture and failure analysis and is actively involved in a number of professional societies.

EDWARD T. WESSEL's Master of Science degree in metallurgical engineering is from Carnegie Institute of Technology. He has 30 years of experience in the area of structural behavior of materials with emphasis on the development and application of fracture mechanics technology for the electric power generation industry. He is a member of a number of professional societies and the author of 60 or more technical productions. He has retired from the position of Manager, Structural Behavior of Materials Department at Westinghouse Electric Corporation.