



Magnetic Materials (1985)

Pages
101

Size
8.5 x 10

ISBN
0309322693

Committee on Magnetic Materials; National Materials Advisory Board; Commission on Engineering and Technical Systems; National Research Council

 [Find Similar Titles](#)

 [More Information](#)

Visit the National Academies Press online and register for...

- ✓ Instant access to free PDF downloads of titles from the
 - NATIONAL ACADEMY OF SCIENCES
 - NATIONAL ACADEMY OF ENGINEERING
 - INSTITUTE OF MEDICINE
 - NATIONAL RESEARCH COUNCIL
- ✓ 10% off print titles
- ✓ Custom notification of new releases in your field of interest
- ✓ Special offers and discounts

Distribution, posting, or copying of this PDF is strictly prohibited without written permission of the National Academies Press. Unless otherwise indicated, all materials in this PDF are copyrighted by the National Academy of Sciences.

To request permission to reprint or otherwise distribute portions of this publication contact our Customer Service Department at 800-624-6242.

Copyright © National Academy of Sciences. All rights reserved.

NATIONAL RESEARCH COUNCIL
COMMISSION ON ENGINEERING AND TECHNICAL SYSTEMS

NATIONAL MATERIALS ADVISORY BOARD

The purpose of the National Materials Advisory Board
is the advancement of materials science and engineering in the national interest.

CHAIRMAN

Dr. Arden L. Bement, Jr.
Vice President, Technical
Resources
Science and Technology Department
TRW, Inc.
23555 Euclid Ave.
Cleveland, OH 44117

PAST CHAIRMAN

Dr. Donald J. McPherson
(Retired)
Kaiser Aluminum & Chemical
Corporation
1180 Monticello Road
Lafayette, CA 94549

MEMBERS

Dr. Raymond F. Decker
Vice President, Research
Michigan Technological University
Houghton, MI 49931

Mr. Edward J. Dulis
President
Crucible Research Center
Colt Industries Inc.
P.O. Box 88
Pittsburgh, PA 15230

Dr. James Economy
Manager, Organic Polymer Research
IBM Corporation
K42-282 Monterey & Cottle Road
San Jose, CA 95114

Dr. Merton C. Flemings
Professor and Chairman
Department of Materials Science
and Engineering
Massachusetts Institute of
Technology
Cambridge, MA 02139

Dr. Brian R.T. Frost
Senior Metallurgist, Materials
Science and Technology Division
Argonne National Laboratory
9700 South Cass Avenue
Argonne, IL 60439

Dr. Bernard H. Kear
Senior Consultant Scientist
Exxon Research & Engineering Co.
Clinton Township
Route 22E
Annandale, NJ 08801

Dr. Alan Lawley
Professor Metallurgical
Engineering
Drexel University
Department of Materials Engineering
Philadelphia, PA 19104

Dr. David L. Morrison
President
IIT Research Institute
10 W. 35th St.
Chicago, IL 60616

Dr. R. Byron Pipes
Director, Center for Composite
Materials
Department of Mechanical and
Aerospace Engineering
University of Delaware
Newark, DE 19711

Dr. Dennis W. Readey
Professor and Chairman, Department of
Ceramic Engineering
Ohio State University
2041 College Road
Columbus, OH 43210

Dr. James R. Rice
Gordon McKay Professor of
Engineering Sciences and Geophysics
Harvard University
Pierce Hall
Cambridge, MA 02138

Dr. William P. Slichter
Executive Director, Research
Materials Science and
Engineering Division
AT&T Bell Laboratories
600 Mountain Avenue
Murray Hill, NJ 07974

Dr. William A. Vogely
Professor and Head
Department of Mineral
Economics
Pennsylvania State University
University Park, PA 16802

Dr. Albert R.C. Westwood
Corporate Director
Martin Marietta Labs
Martin Marietta Corporation
1450 South Rolling Road
Baltimore, MD 21227

NMAB STAFF

K.M. Zwilsky, Executive Director
S.M. Barkin, Associate Executive
Director

REPORT DOCUMENTATION PAGE

1a. REPORT SECURITY CLASSIFICATION Unclassified			1b. RESTRICTIVE MARKINGS			
2a. SECURITY CLASSIFICATION AUTHORITY			3. DISTRIBUTION / AVAILABILITY OF REPORT Public Release Distribution - Unlimited			
2b. DECLASSIFICATION / DOWNGRADING SCHEDULE						
4. PERFORMING ORGANIZATION REPORT NUMBER(S) NMAB - 426			5. MONITORING ORGANIZATION REPORT NUMBER(S)			
6a. NAME OF PERFORMING ORGANIZATION Nat'l Materials Advisory Bd. National Research Council		6b. OFFICE SYMBOL (If applicable) NMAB		7a. NAME OF MONITORING ORGANIZATION Department of Defense Nat'l Aeronautics and Space Administration		
6c. ADDRESS (City, State, and ZIP Code) 2101 Constitution Avenue, N.W. Washington, D.C. 20418			7b. ADDRESS (City, State, and ZIP Code) Washington, D.C. 20301			
8a. NAME OF FUNDING / SPONSORING ORGANIZATION Dept. of Defense, Nat'l Aeronautics & Space Adm		8b. OFFICE SYMBOL (If applicable) DOD/NASA		9. PROCUREMENT INSTRUMENT IDENTIFICATION NUMBER MDA-903-82-C-0434		
8c. ADDRESS (City, State, and ZIP Code) Washington, D.C. 20301			10. SOURCE OF FUNDING NUMBERS			
			PROGRAM ELEMENT NO.	PROJECT NO.	TASK NO.	WORK UNIT ACCESSION NO.
11. TITLE (Include Security Classification) Magnetic Materials						
12. PERSONAL AUTHOR(S) Committee on Magnetic Materials						
13a. TYPE OF REPORT Final		13b. TIME COVERED FROM 3/15/84 TO 3/29/85		14. DATE OF REPORT (Year, Month, Day) March 1985		15. PAGE COUNT 96
16. SUPPLEMENTARY NOTATION						
17. COSATI CODES			18. SUBJECT TERMS (Continue on reverse if necessary and identify by block number)			
FIELD	GROUP	SUB-GROUP	See reverse side			
19. ABSTRACT (Continue on reverse if necessary and identify by block number) The report describes the fundamental role that magnetic materials play in many of the electrical and electronic systems used by modern society. It reviews the status of magnetic materials in their current engineering applications and identifies technical issues whose resolution would lead to improved performance in such applications as well as for new applications of these materials. The report recommends more research in the areas of rare-earth permanent magnets, amorphous magnetic materials and recording media and lists a number of scientific challenges.						
20. DISTRIBUTION / AVAILABILITY OF ABSTRACT <input type="checkbox"/> UNCLASSIFIED/UNLIMITED <input checked="" type="checkbox"/> SAME AS RPT. <input type="checkbox"/> DTIC USERS				21. ABSTRACT SECURITY CLASSIFICATION Unclassified		
22a. NAME OF RESPONSIBLE INDIVIDUAL Jerome Persh			22b. TELEPHONE (Include Area Code) (202) 695-0005		22c. OFFICE SYMBOL DOD	

Subject Terms

Permanent magnets
Amorphous magnetic materials
Semi hard magnets
Soft magnetic materials
Storage media
Magnetic bubbles
Transducers (magnetostriction and magnetoresistance)
Electrophotography
Ferrofluids
Magneto-optic materials

MAGNETIC MATERIALS

**REPORT OF THE
COMMITTEE ON
MAGNETIC MATERIALS**

**National Materials Advisory Board
Commission on Engineering and Technical Systems
National Research Council**

**Publication NMAB-426
National Academy Press
Washington, D. C.
1985**

**NAS-NAE
APR 5 1985
LIBRARY**

85-0029
2.1

NOTICE: The project that is the subject of this report was approved by the Governing Board of the National Research Council, whose members are drawn from the councils of the National Academy of Sciences, the National Academy of Engineering, and the Institute of Medicine. The members of the committee responsible for the report were chosen for their special competences and with regard for appropriate balance.

The report has been reviewed by a group other than the authors according to procedures approved by a Report Review Committee consisting of members of the National Academy of Sciences, the National Academy of Engineering, and the Institute of Medicine.

The National Research Council was established by the National Academy of Sciences in 1916 to associate the broad community of science and technology with the Academy's purpose of furthering knowledge and of advising the federal government. The Council operates in accordance with general policies determined by the Academy under the authority of its congressional charter of 1863, which established the Academy as a private, nonprofit, self-governing membership corporation. The Council has become the principal operating agency of both the National Academy of Sciences and the National Academy of Engineering in the conduct of their services to the government, the public, and the scientific and engineering communities. It is administered jointly by both Academies and the Institute of Medicine. The National Academy of Engineering and the Institute of Medicine were established in 1964 and 1970, respectively, under the charter of the National Academy of Sciences.

- - - - -

This study by the National Materials Advisory Board was conducted under Contract No. MDA 903-82-C-0434 with the Department of Defense and the National Aeronautics and Space Administration.

This report is for sale by the Defense Technical Information Center, Cameron Station, Alexandria, Virginia 22314.
Printed in the United States of America.

COMMITTEE ON MAGNETIC MATERIALS

Chairman

ROBERT M. WHITE, Principal Scientist, Xerox Corporation, Palo Alto
Research Center, Palo Alto, California

Members

GEOFFREY BATE, Senior Vice President, Verbatim Corporation, Sunnyvale,
California

GILBERT Y. CHIN, Director, Materials Research Laboratory, AT&T Bell
Laboratories, Murray Hill, New Jersey

T. H. GEBALLE, Professor, Applied Physics, Stanford University,
Stanford, California

C. D. GRAHAM, Professor, Metallurgy and Materials Science, University of
Pennsylvania, Philadelphia, Pennsylvania

FRED E. LUBORSKY, Physical Chemist, Research and Development Center,
General Electric Company, Schenectady, New York

KARL STRNAT, F. M. Tait Professor of Electrical Engineering, University of
Dayton, Dayton, Ohio

RUSSELL G. WEST, Vice President, Trans-Tech, Inc., Adamstown, Maryland

Liaison Representatives

JOHN C. HURT, U.S. Army Research Office, Department of the Army, Research
Triangle Park, North Carolina

DONALD E. POLK, Office of Naval Research, Arlington, Virginia

JEROME PERSH, Department of Defense, The Pentagon, Washington, D.C.

NMAB Staff

DONALD G. GROVES, Staff Scientist

PREFACE AND ACKNOWLEDGMENTS

In response to a request from the Department of Defense, the National Materials Advisory Board of the National Research Council established a Committee on Magnetic Materials in January 1984. The committee's charge was (1) to assess current progress in research and development of magnetic materials in the United States; (2) to identify key problems and factors (e.g., economic and technological) that may limit the use of needed future magnetic materials; and (3) to recommend research and development areas, including those in manufacturing technology, that appear most likely to return the highest scientific and technological dividends within the next decade.

The reasons for initiating this study may be summarized as follows:

- There is an increasing reliance on external sources of magnetic materials and on devices employing such materials.
- There is a declining interest on the part of U.S. educational institutions to provide training in the underlying principles and applications of magnetic materials.
- Japan appears to be taking a commanding lead in new technological developments.
- The U.S. Department of Defense and various other U.S. government agencies as well as segments of U.S. industry are concerned that the United States may be losing its dominance in a technology that plays a crucial role in the economy as well as the possibility that new applications of magnetic materials may provide a military advantage to the discoverer.

This report of the committee attempts to describe the state of science and technology in magnetic materials from the perspective of workers in the field. It is hoped that it will help to illustrate the importance of magnetic materials to science and engineering. The committee has identified areas where appropriate research and development could have a significant impact in restoring the United States to a prominent position in the field.

Many people, in addition to the committee members and liaison representatives, have contributed to this report, and we are most appreciative of that assistance. Special thanks are due the following individuals, who gave presentations at the committee's meetings or

provided material for the report: Rollin Parker, Hitachi; Fred Pinkerton, General Motors; Sung Ho Jin, AT&T Bell Labs; G. Rodrigue, Georgia Tech; J. Houze, Allegheny-Ludlum; R. Sundahl, AT&T Bell Labs; R. O'Handley, MIT; Fred Jeffers, Kodak; James Lemke, Kodak; Neal Heiman, LANX Corp.; Mark Kryder, Carnegie-Mellon University; Ami Berkowitz, General Electric; A. Clark, Naval Surface Weapons Center; H. Savage, Naval Surface Weapons Center; I. Jacobs, General Electric; J. Rowell, Bell Communications Research; I. Sander, Verbatim; D. Thompson, IBM.

The chairman is particularly grateful to Fumiko Mannes and Frances Renteria Soto for their help in assembling this report.

Robert M. White
Chairman

ABSTRACT

Magnetic materials play a fundamental role in many of the electrical and electronic systems that characterize modern society. This report reviews the status of magnetic materials with respect to current applications and identifies technical issues whose resolution would lead to improved performance or new applications. It recommends more research in the areas of rare-earth permanent magnets, amorphous magnetic materials, and recording media, and it lists a number of specific scientific challenges.

Chapter 1

SUMMARY OF CONCLUSIONS AND RECOMMENDATIONS

INTRODUCTION

Magnetic materials are an integral part of modern industrial society. They play a key role in power distribution, they make possible the conversion between electrical and mechanical energy, they underlie microwave communication, and they provide both the transducers and the active storage material for data storage in information systems. The properties of magnetic materials are continuously being improved, and many new applications are possible. In fact, magnetic materials seem to offer an infinite variety of applications; when one application is displaced, another arises. For example, the first generation of computers used magnetic drums for memory. These devices were displaced by matrices of ferrite cores. As these cores were displaced by semiconductor technology, magnetic materials appeared in magnetic bubble devices and in disk storage media and drives.

In spite of such practical uses of these materials, and the fact that they have also served as ideal systems for exploring basic concepts in solid-state physics, the evolution of magnetic materials technology in the United States is now seriously threatened. The reasons for such a situation are given in the following conclusions of this report, and recommendations are put forth in the interests of correcting the problem and promoting progress in the field.

CONCLUSION 1

Despite the critical importance of magnetic materials, the United States is rapidly losing its competitive position in this technology. This is primarily due to three current situations:

- The growing tendency on the part of American industry that manufactures systems employing magnetic devices to rely on external sources for these devices.

- Those American companies producing magnetic materials are finding it increasingly more difficult to economically justify significant expenditures on new technology.
- Foreign nations, notably Japan, have invested in the research and development to further improve the performance of their materials.

Hence, U.S. industries, in the absence of domestic suppliers, buy magnetic components from foreign sources. Although this may optimize individual corporate profits, it may not be in the nation's best long-term interest because it can lead to an unstable situation. A corporation that does not manufacture magnetic components is not going to support research in this area. The absence of industrial research will discourage university research, and eventually the national effort becomes subcritical. At this point the U.S. system manufacturers become vulnerable to imports of systems produced by the foreign component suppliers, which have become vertically integrated. The potential harmful effects attendant to the United States loss of control over a technology that plays a crucial role in the economy, as well as the possible threat that new applications of magnetic materials present serious problems to our national security.

Our analysis convinces us that all the major magnetic technologies in the United States are approaching this undesirable condition. Accordingly, we recommend the following:

Research should be increased in support of those technologies with strong growth potential or having strategic value.

By creating a supportive environment for these new developments we may regenerate internal sources of magnetic components. An increased research effort will also reestablish a base of knowledgeable scientists and engineers who can exploit these new materials in novel ways. We have identified three growth areas:

- Permanent magnets are one of the oldest and largest applications of magnetic materials. The "strength" of a permanent magnet is measured by its energy-product. This figure-of-merit has increased more rapidly over the past decade than at any time in history through the introduction of rare-earth cobalt (RE-Co) compounds. However, the precarious supply situation for cobalt also makes such permanent magnets expensive and their users vulnerable to recurring problems with imports. Recently it has been discovered, in Japan and independently by General Motors in the United States, that boron helps form ternary compounds with iron and the light rare earths, such as neodymium, which have magnetic properties superior even to those of RE-Co. This discovery was accidental--boron was being introduced as a glass-former in a rapid-quench process. The research issue is, therefore, what is the origin of the good magnetic properties of this compound and how can it be further improved? A great deal

of optimization has already been achieved simply by substitutional methods. The energy product is so large that it will revolutionize the design of motors. This provides an economic impetus for establishing a better understanding that will enable improved processing, less temperature sensitivity, better chemical stability, etc., to be achieved.

- Soft magnetic materials are another class of materials that support large markets, typified by transformers at low frequencies and recording heads at high frequencies, and they offer enormous opportunity for improvements, particularly through the introduction of amorphous materials. These materials, currently in the form of ribbons, offer higher permeabilities at higher frequencies and lower losses. They might also, for example, replace the materials of present magnetic recording heads, whose relatively low saturation magnetizations prevent the use of higher coercivity media, which in turn limit the recording density. However, many questions, such as stability and controllability of domains, remain to be evaluated. We believe the potential of these materials warrants more research.
- Magnetic recording almost suffers from an overabundance of storage materials--particles and films with in-plane or perpendicular configurations--and all offer promise of providing much higher recording densities. Again, the committee sees dramatic growth here and an enormous opportunity for innovative research. Increased storage densities are absolutely necessary if we are to benefit from efforts to increase the number of transistors on a chip. An improved understanding of the magnetic as well as the nonmagnetic properties of particulate and thin-film media will allow tapes and disks to be designed rather than developed empirically, as is done today.
- In addition to these three promising areas, there are classes of materials having strategic military value but less economic potential at present where modest research support would be appropriate. Two decades ago the Department of Defense supported the development of microwave ferrites, and today 85 percent of that market is still military. Magnetostrictive sensors for sonar devices are a more recent example. Certain rare-earth elements and alloys have extraordinary large values of magnetostriction. If the resistivity of these materials could be increased significantly without affecting the magnetostriction, the frequency range of such materials could be greatly extended by suppressing eddy currents. Magnetic bubbles are another example. Although they have not been able to compete economically with semiconductor RAMs in most applications, their combination of nonvolatility and ruggedness makes them attractive for military applications. Bubble devices have the added feature that they contain the potential for much

higher storage densities based on internal domain wall structures as opposed to the present scheme based simply on domains.

This report also contains sections on semihard magnetic materials, microwave materials, and magnetic particles for marking. In all cases the markets are small and, except for microwave materials, where larger $4\pi M_s$ and improved microstructure would be desirable, existing materials appear to be adequate.

CONCLUSION 2

History shows that a large base of fundamental, exploratory research regularly produces unexpected but often useful results. One example of this process is the development of the magnetic bubble technology. This grew out of the fundamental studies of domain behavior, magnetic single crystals, and optical properties and is described in a 1972 report of the National Academy of Sciences (the Bromley Report). Another example is the discovery of amorphous magnets. This resulted from fundamental studies of crystalline solid solutions by Duwez and his colleagues at Cal Tech.

In the past, fundamental research in magnetism has been largely carried out in university environments. In order to keep up with and couple into such university activities, industry has supported in-house fundamental research in a few corporate R&D centers. Over the past decade, however, the academic base of fundamental research in magnetism and magnetic materials has eroded severely, and there has been a corresponding decrease of industrial research. The opposite is true in semiconductor research. There, a large part of the science is actually done in industrial laboratories, and there is excellent communication among scientists in industry, universities, and national laboratories engaged in this technology. The poor present situation in magnetism impacts our ability to implement the first recommendation above. We therefore recommend that:

An effort be made to regenerate a strong university-based research program in magnetism and magnetic materials.

Research opportunities in condensed matter physics involving magnetic phenomena are discussed in the recent National Survey of Physics (Brinkman Report). Examples include:

- Transition metal magnetism.
- F-electron magnetic phenomena.
- Disordered magnetic systems.

Further, better mechanisms for coupling the science of magnetism with technology should be established. While some steps have been taken recently to stimulate work in support of specific magnetic technologies by establishing university centers, such as those at the University of California at San Diego and Carnegie-Mellon University, effective ways for integrating the more fundamental and applied research being done in other laboratories, and coupling it to industrial development, must yet be devised. The Annual Conference on Magnetism and Magnetic Materials, now 30 years old, is perhaps the major opportunity for practitioners of magnetic science and technology to interact, but this is quite insufficient. We therefore further recommend that:

The advisory bodies that the National Science Foundation (NSF) and other government agencies normally employ for program evaluations have some representation from the more applied centers mentioned above.

CONCLUSION 3

The present separation in much of the magnetics community between fundamental and applied activities is detrimental to the development of new materials and applications. The fundamental scientists are generally physicists, whereas the applied scientists generally come from engineering and materials science backgrounds. This split manifests itself in departmental boundaries within universities as well as in professional conferences. Magnetic technology has now reached a level of sophistication where this gap must be closed. The interdisciplinary aspect of this subject should be recognized and dealt with. A reservoir of understanding already exists in solid-state physics that, if applied to magnetic problems, would have an enormous impact. The solid-state sciences have also developed experimental techniques, such as epitaxial growth (MBE) and structural determination by X-ray absorption (EXAFS), that could be applied to magnetic problems with important results. In turn, there are application problems and material requirements which the fundamental scientists could help solve if made aware of them by more frequent contact with technologists. We therefore recommend the following:

The relationships between scientific research in magnetism and the magnetics technology be strengthened.

Some examples of fundamental problems whose solutions would advance magnetic technologies are:

- Surfaces: What is the mechanism whereby a surfactant increases the coercivity of a magnetic particle? Why are the magnetic properties of amorphous films more surface-sensitive than their crystalline counterparts?

- Fundamental limits: What would one have to do to increase magneto-optic or magnetoresistive coefficients by, say, an order of magnitude? Could one design a useful ferromagnetic insulator in which the sublattices were all ferromagnetically coupled?
- Statistical physics: What governs the spread in the nucleation fields for an ensemble of magnetic particles?
- Amorphous materials: What governs the formation of amorphous materials? What is the origin of their anisotropy and magnetostriction?
- Micromagnetics: Much remains to be learned about the dynamics of magnetic domain wall singularities such as Bloch lines. We believe the United States has overreacted to its disenchantment with magnetic bubbles by abandoning all fundamental research in this area.

We urge government funding agencies, advisory bodies of university research organizations, and organizing committees of conferences to take steps to bring these two cultures together. Funding agencies might look more favorably on proposals involving physicists, engineers, and materials scientists; they might also directly support through travel grants and tutorial sessions at national conferences, emphasizing the interaction between fundamental and applied topics. Universities might also offer interdepartmental courses.

CONCLUSION 4

Since the subject of magnetic materials is so broad, information appears in a variety of places, not all of which are readily identifiable. For example, much work on magnetic oxides is being done by geophysicists who publish in their own journals. Manufacturers of magnetic materials also publish promotional literature that offers data not found in the traditional publications. We therefore recommend the following:

A national resource center for the assimilation of information on magnetic materials should be formed.

As a corollary to this we should note that, as Japan becomes more dominant in this area, more information will appear first in Japanese literature. For example, the Japanese Society of Applied Physics, the Japanese equivalent of IEEE, and the Society of Applied Magnetism hold regular meetings and publish extended abstracts in Japanese. Oyobutsuri is a journal that contains many articles on magnetic materials. We endorse the recent decision of the Magnetics Society of the IEEE to publish translations from Japanese journals and urge more effort in this direction.

Chapter 2

INTRODUCTION

All materials are magnetic in the sense that they respond to an applied magnetic field. In most cases this response is linear and small. If this response is negative, we speak of diamagnetism; if it is positive, the material is paramagnetic. Except for superconductors, which exhibit perfect diamagnetism, these materials are not employed for their magnetic properties. For the purposes of this study we shall focus on materials that exhibit ferromagnetism or ferrimagnetism, i.e., those that have undergone a phase transition into a macroscopically ordered state that breaks time reversal invariance. Fortunately, the temperature at which this transition occurs (the Curie temperature) lies above room temperature for many materials. These materials have either a large response, i.e., a large permeability, or a nonlinear response resulting in a large remanence, i.e., a magnetization that remains when the applied field is reduced to zero. This remanence endows "magnetic" materials with properties that cannot be duplicated by any other materials. For example, the remanence acts as the source for magnetic fields. These fields may interact with other fields or with currents to produce forces. Conversely, the motion of the remanent field relative to a conductor will generate an electromotive force. Remanent magnetization is a vector quantity, and this makes it ideally suited for storing binary information. Furthermore, because both magnetization and magnetic field are vectors, the response is a tensor. The "off-diagonal" response leads to the Hall effect and a variety of magneto-optical phenomena.

Although this study is focused on "technical" magnetic materials, i.e., those with practical applications, magnetic materials have also served as ideal systems for exploring basic concepts in solid-state physics. Historically, they have been the system for studying the critical behavior accompanying second-order phase transitions. Magnetic materials are particularly useful in this context because there exist crystal structures that produce magnetic systems with 1- and 2-dimensional characteristics. One can also find systems where the spin is confined to point parallel or antiparallel to a specific direction (Ising-like), or alternatively to lie in a plane (XY-like). Spin glasses and, more recently, random magnets have challenged and clarified theoretical understanding of disordered and nonequilibrium statistical

mechanics. Magnetic materials also exhibit chaotic and soliton phenomena associated with nonlinear systems. In this role, magnetic materials are a convenient means to an end.

Interestingly enough, of the 90-some elements occurring in nature, it is mainly those that undergo a magnetic phase transition in their elemental form that combine with others to produce magnetically ordered materials. These consist of the familiar transition metal elements, chromium, manganese, iron, cobalt, and nickel, as well as the rare-earth elements. There are a few exceptions, such as Au_4V , $ZrZn_2$, and some copper salts.

The first modern application of magnetic materials was in the general area of power generation and distribution, namely, motors and transformers, beginning in the mid-nineteenth century. Since then, magnetic materials have continued to play a major role in virtually all industrial advances. They permeate communications through telephone, radio, and television. And recently they are making possible spectacular improvements in information storage.

This evolution of magnetic technology now appears to be threatened, at least in the United States. This threat comes from two sources. The first is the perception on the part of American industry employing magnetic devices that the internal development of magnetic technology does not offer significant economic opportunities. Magnetic materials are almost regarded as "low-performance" materials. A larger percentage of the devices that use these materials are coming from foreign sources.

- It is difficult to estimate the importation of permanent magnets since many of them enter the United States as part of larger systems; nevertheless it is the consensus of the industry that Japan's market share is increasing dramatically.
- In soft magnetic materials, no grain-oriented Fe-Si was imported 10 years ago; now 15 percent comes from Japan, and the amount is growing.
- Bubble memory technology was invented at AT&T Bell Laboratories, and a large number of U.S. firms invested heavily in it. However, today in the United States only Intel and Motorola are in commercial production. On the other hand, although they started somewhat later, Japanese industrial firms were the first to market bubble devices and are now clearly the world's leaders in volume of production.

These trends will accelerate, because the Japanese have invested in the research and development to further improve the performance of their materials. They have pioneered the use of laser scribing in electrical steels for reducing loss and the use of cobalt in recording particles for increasing coercivity.

The United States has shown some signs of responding to this situation. There are now two university centers where magnetic technologies are being addressed. The program at Carnegie-Mellon University (CMU) began with a strong magnetic bubble activity but has now broadened considerably. Its support comes equally from industry and government sources. A magnetic recording center has been established at the University of California at San Diego (UCSD). Although most of the \$12 million raised to start this center came from industry, the only materials work currently under way is associated with individual faculty grants from government agencies. Estimates of the 1984 expenditures in magnetic materials at these two institutions are indicated in Table 1. In both cases some of the dollars should more appropriately be classified as "basic" research, without a particular applied association. As a reference, it is worth noting that the University of Dayton, which focuses specifically on permanent magnets, has a \$280,000 research program. There are, of course, other programs scattered across the nation. And there are various government agencies that have in-house research programs on magnetic materials as well as contract research. The Army Research Office (ARO), for example, supports approximately \$500,000 of in-house research and \$1 million in contracts. The Office of Naval Research (ONR), on the other hand, runs about \$1.5 million in-house, at the Naval Research Laboratory (NRL) and the Naval Surface Weapons Center (NSWC), while contracting out \$500,000. But the point remains that if the United States is to regain a leadership position in magnetic materials a much larger investment is necessary, something in the order of additional tens of millions of dollars. This may take the form of specific industrial collaborative efforts analogous to the UCSD recording program. However, the interdisciplinary nature of the materials problems will call for a broad coordinated effort.

TABLE 1 Level of Magnetic Research Expenditures (1983/1984)

	<u>CMU</u>	<u>UCSD</u>
Hard Magnetic Materials	\$163,000	\$188,000
Soft Magnetic Materials	163,000	--
Recording Materials	1,300,000	180,000

The second component of this threat to the U.S. magnetic industry is the lack of an active scientific base. In the late 1950s and early 1960s many distinguished American scientists, such as Van Vleck, Kittel, and Anderson, were working on magnetism. Today, all the "action" is in semiconductors. Although exciton droplets and the quantized Hall effect are not likely to lead to new devices, the existence of a large exploratory science base certainly increases the chances of new discoveries that will affect device development. This lack of enthusiasm

for magnetic phenomena may have even deeper consequences. The magnetic properties of solids are an integral part of their description, and abdication of research on magnetic phenomena weakens overall understanding of condensed matter.

The NSF and DOE also support facilities that serve the basic magnetism community. The National Magnet Laboratory of MIT provides high magnetic field capabilities. The emphasis, however, has largely been on semiconducting and superconducting materials. The lab has not focused on magnetism and magnetic materials to the extent that the high field laboratories in Japan or Europe have.

There also exists half-a-dozen major neutron-scattering facilities in the United States. This is perhaps the most important "tool" for the study of magnetism. Yet according to a recent NRC Panel on Neutron Scattering, the United States has fallen behind Western Europe in the use of cold neutron beams and high-resolution spectroscopy.

This committee cannot reverse the attitude of American industry or the American scientific community toward magnetics. But what we can do is identify what we feel are areas where more research could have an impact. We can also identify fundamental questions with rich scientific content. We hope these suggestions will stimulate or redirect research along a path that will bring the United States back to a prominent position in this field.

Since the range of magnetic materials is extremely broad, we have chosen to break down our analysis along the lines of the conventionally accepted definitions of technical magnetic materials. Chapter 3 is devoted to a discussion of hard magnetic materials--i.e., those having a large coercivity that can therefore support a large remanence and are useful, for example, as permanent magnets. Chapter 4 addresses the soft magnetic materials, or those having low coercivities that enable their magnetization to be switched easily, as in transformers and magnetic recording heads. Magnetic recording media have coercivities that are intermediate between hard and soft, and therefore might be categorized as semihard. However, their large-area, thin-film application requires considerations that place them in a category of their own, and they are discussed in Chapter 5. The magnetic state of a material can also influence other physical properties, such as optical properties, resistivity, and strain. These couplings become the basis for the use of magnetic materials as transducers, which are covered in Chapter 6. Finally, in Chapter 7, applications are discussed in which the motion of magnetic particles under the influence of an applied field is exploited.

Chapter 3

HARD MAGNETIC MATERIALS

PERMANENT MAGNETS

A permanent magnet is used to create a steady magnetic field in some region of space. It produces the same effect as an electromagnet but requires no external source of power after its initial magnetization. The field of the permanent magnet may be used to exert a force on a current-carrying conductor, as in a motor or loudspeaker; to deflect a moving charged particle, as in a CRT or synchrotron; to induce an electromotive force in a moving conductor, as in a generator; or to exert a force on a magnetized or magnetizable body, as in a scrap metal separator or refrigerator door seal.

The usual measure of quality for permanent magnets is the maximum energy product, $(BH)_{\max}$, defined as the largest inscribed rectangle in the second quadrant of the hysteresis loop plotted as B vs. H (Figure 1). The maximum energy product (often called simply the energy product) is inversely proportional to the volume of permanent magnet (PM) material needed to produce a flux density of magnitude B_{opt} in a given volume of space. The usual units (cgs) for $(BH)_{\max}$ are megagauss-oersteds (MGOe); the SI units are kilojoules per square meter (kJ/m^2). Other important parameters, shown in Figure 1, are the remanent induction B_r and the coercive field or coercive force H_c . Note that two materials can have the same energy product but quite different values of B_r and H_c ; in general, we can have high B_r and low H_c or vice versa.

An ideal permanent magnet has a constant magnetization equal to the saturation magnetization M_s in any practical applied field. Since $B = H + 4\pi M$, if $M = M_s = \text{constant}$, then a plot of B vs. H is a straight line intersecting the B axis at $B_r = 4\pi M_s$ and the H axis at $H_c = -B_r = -4\pi M_s$. The maximum possible energy product is then $(4\pi M_s)^2/4$. Pure iron, with $4\pi M_s = 20,700$ G, would have an energy product of 107 MGOe if it could be made into an ideal permanent magnet of 100 percent density.

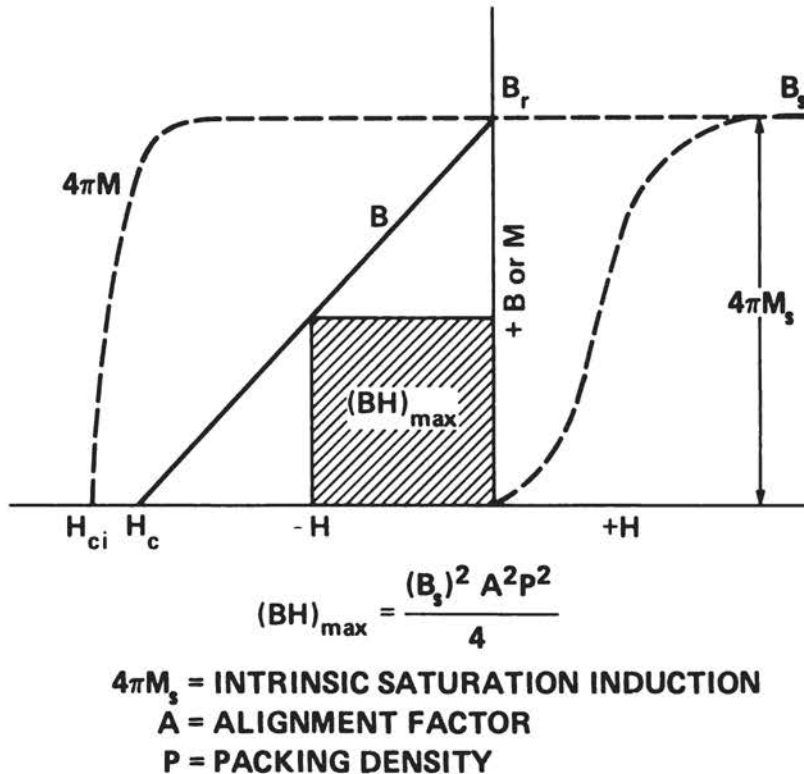

Figure 1 Hysteresis loop associated with a permanent magnet.

The first permanent magnets were natural oxide magnets or lodestones. The first artificial permanent magnets were steels, hardened by quenching. The fact that soft iron was easily magnetized and demagnetized, whereas hardened steel acted as a permanent magnet, led to the terminology of hard and soft magnetic materials that we use today. The PM properties of steels were improved in the early 1900s by the addition of various alloying elements, notably tungsten, but the energy product of steel does not exceed 1 MGOe. In the 1930s good PM properties were discovered by Japanese workers in certain Fe-Ni-Al alloys; these were developed into a family of alloys containing also cobalt and known collectively as Alnico, with energy products up to 6 MGOe or more, produced by conventional casting technology. Alnico led to major design changes in PM devices and to much wider use of permanent magnets.

Magnet steels and Alnico were developed essentially by trial and error. The major conceptual advance occurred in the 1940s, when Neel, Kittel, and others introduced the idea of the single-domain particle, a single crystal so small that it is energetically unfavorable for it to contain a domain wall. In the simplest model, such a particle can reverse its magnetization only by a uniform or coherent rotation. The field required for this rotation is directly proportional to the effective anisotropy of the material. In a justly famous paper Stoner and Wohlfarth worked out in considerable detail the expected magnetic

behavior of arrays of single-domain particles of various shapes and alignments. This model has dominated subsequent development work in PM materials.

In the 1950s PM ferrites were produced at Philips in the Netherlands. These are compounds of iron oxides and barium or strontium oxides, which have hexagonal crystal structure and strong uniaxial magnetic anisotropy. Small single-crystal particles in the form of a loose powder are aligned by a magnetic field so that their magnetic axes are parallel, mechanically compacted, and bonded together by a high-temperature solid-state diffusion process called sintering. Ferrite magnets, with energy products similar to Alnico, have relatively low magnetization but high coercive fields. They are well suited for uses where the demagnetizing fields are high, such as motors. They use inexpensive raw materials, are cheap to produce, and have many and growing industrial uses.

Also in the 1950s a successful attempt was made to produce a physical embodiment of a Stoner-Wohlfarth magnet based on shape anisotropy. A research group at General Electric set out to make elongated single-domain particles, which came to be known as ESD magnets. The process used electrolytic deposition of iron into a mercury cathode, followed by a low-temperature heat treatment. The resulting magnets, known by the trade name Lodex, are still in production. However, the coercive field of Lodex is substantially lower than the Stoner-Wohlfarth model predicts. This discrepancy led to a number of notable theoretical papers describing new models for the magnetization reversal in single-domain particles.

By the late 1950s it was generally understood in the PM research community that to make a superior magnet one needed to find or make a material with high magnetization and strong uniaxial anisotropy and make it into single-domain particles. Strnat et al. (1967) showed that a series of rare earth-cobalt compounds met the conditions. (The rare-earth metals had become available through research undertaken for the Manhattan Project in World War II.) By about 1970 the first of the rare-earth permanent magnets (REPMs) became commercially available. This was SmCo_5 ; it is made from aligned single-crystal powders, using the same basic procedure used for hard ferrites. Two phases are present in the finished magnets. These materials have energy products of about 20 MGOe, a factor of 4 better than Alnico or hard ferrite. Although both cobalt and samarium are expensive and the production process is difficult because of the strong tendency of rare-earth metals to oxidize, SmCo_5 production was increasing rapidly until the cobalt crisis of 1977 dramatically increased its price and raised fears about the long-term stability of its supply. These events impeded growth in the REPM industry for several years.

There is conclusive evidence that SmCo_5 magnets do not contain single-domain particles. The particles reverse their magnetization by domain wall motion, and the reversal field is determined by domain wall pinning or nucleation. The exact mechanism is still under debate, and in some models the distinction between pinning and nucleation disappears.

This is a case where a theoretical model clearly guided the development of a new material, although the model turned out not to be applicable to the final product.

A second generation of REPMs based on the compound $\text{Sm}_2\text{Co}_{17}$ has become available within the last 5 years from Japanese manufacturers. The advantage of these materials is increased B_r . Energy products above 25 MGOe have been achieved. These magnets are considerably off the stoichiometric 2 - 17 composition and contain substantial amounts of iron and copper plus small but essential additions of zirconium, hafnium, or tantalum. A complex heat treatment is required, and the finished magnets have a very fine-scale microstructure with probably three distinct phases.

The latest addition to the REPM catalog is the $\text{Fe}_{14}\text{Nd}_2\text{B}$ composition announced by Sumitomo Metals and General Motors in 1983. The base compound is tetragonal rather than hexagonal. Energy products are 30 to 45 MGOe, and the raw materials are relatively cheap. The major drawback is a low Curie temperature (300°C), which causes magnetic properties to be strongly temperature-dependent. The Curie temperature can be raised by replacing iron with cobalt. The Sumitomo magnets are made by a process very similar to that used for SmCo_5 , so no major investment in new production facilities is required. General Motors makes a similar composition starting from a rapidly solidified ribbon sample.

There is a substantial number of other compositions that have been and continue to be used as permanent magnets. The most widely used are those that combine reasonably good PM properties with mechanical ductility; their most important use is in telephone receivers. The REPMs, Alnicos, and hard ferrites are all brittle and must be shaped by grinding.

All the standard PM materials can be ground into coarse particles and embedded in rubber or polymer materials. These "bonded" magnets have magnetic properties inferior to the parent materials but are easy to cut or form to exact shapes and can be mechanically flexible. They have many engineering uses.

Figure 2 shows the improvements in PM materials that have occurred over the last eighty years, and Table 2 lists the major classes of PM materials in commercial use.

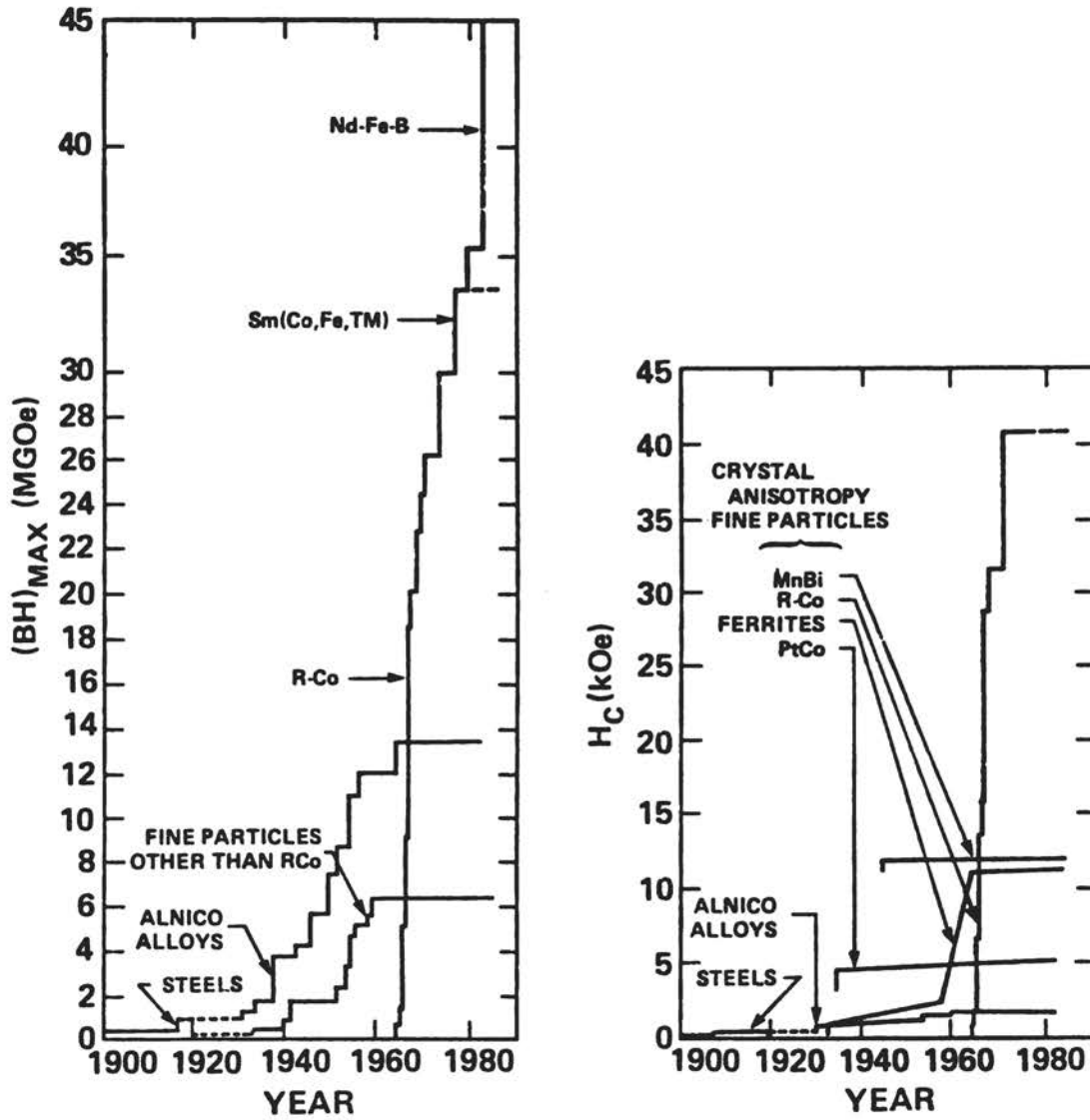

Figure 2 Energy product and coercivity of permanent magnets.

TABLE 2 Permanent Magnet Materials in Use

<u>Types</u>	<u>Introduced</u>	<u>Use</u>	<u>Use Trend</u>
Martensitic steels	1820 - 1930	Small	Declining
Alnico alloys	1930s	Large	Declining
Remalloy (Fe-Co-Mo)	1930s	Very small	Replaced by Fe-Cr-Co
PtCo	1930s	Very small	Fast declining
Cunife, Cunico	1930s	Small	Declining
Vicalloy	1940s	Very small	Steady
ESD Fe-Co	1950s	Small	Steady
Ferrites (oxides)	1950s	Large	Fast growing
*RE-Co alloys	1970s	Small	Fast growing
Fe-Cr-Co alloys	1979	Medium, replacing Alnico 5, Cunife	Modest growth
Mn-Al-C alloy	1979	Small, replacing some Alnicos	Steady?
*Fe-Nd-B	1983	Very small	Rapid growth expected

*Together called REPM (rare-earth permanent magnets) in this report.

Source: K. Strnat, 1983.

Applications and Market

Permanent magnets have device applications in many unrelated fields of technology. We discuss here four categories of PM devices based on the function the magnet serves in them, together with representative examples.

Electromechanical Devices

- Electric motors--rotary or linear, dc or synchronous--for watches and clocks, servos, computer peripherals, automobile accessories, etc.
- Electric generators--for tachometers, car alternators, exciters for large turbo-generators, aircraft main power, jet engine ignition, etc.
- Electromechanical actuators--linear or rotary--for computer printers, recording head positioners, industrial robots, etc.
- Electroacoustic applications such as loudspeakers, microphones, earphones, and phonograph pickups.
- Measuring instruments such as galvanometers and balances.

Electomechanical devices now are the largest market for permanent magnetism (85 percent of sales) and growing rapidly. Large motors use mostly ferrites; some, for military and space applications, use Sm-Co. Computer peripherals represent the application with the fastest growth (20 percent per year). Most disk drives, head positioners, and line and dot-matrix printers now use REPMs. Millions of small dc motors and loudspeakers are used each year in the automobile industry, consuming large quantities of ferrites (and soon probably iron based REPMs as well). Millions of telephone receivers contain ferrite, Alnico, or Fe-Cr-Co magnets. Modern magnets, combined with high-power semiconductors and microprocessors, are revolutionizing drive systems. A new "universal" PM-dc motor type is evolving that should in time replace most electrically excited machines. Permanent magnetic motors promise to become competitive even with induction motors in appliance applications, a huge potential market for ferrites. New uses and designs of miniature motors and/or actuators for computerized business machines are mushrooming; actuators using REPMs are replacing hydraulics in airplanes and manufacturing robots; and lightweight, high-speed rotating magnet machines (several hundred kilowatts) are also becoming economically attractive.

Mechanical Force and Torque Devices

- Torque and linear motion couplers, eddy current brakes, rotary-to-linear motion converters.
- Magnetic bearings and suspensions in vehicle levitation, watt-hour meters, ultracentrifuges, etc.

- Holding and lifting devices for door latches, seals, etc.
- Material separators for ore processing, scrap metal recovery, water cleaning, etc.

Magnetic bearing systems are developing slowly. Old uses in meters and new ones for isotope separation centrifuges, turbo-molecular pumps, space gyros, and antennas still use only small quantities, predominantly rare-earth cobalt. A German magnetic train levitation and propulsion system now in the field-test stage, if implemented on a commercial scale, would require several tens of tons per year of REPM material.

Electron and Ion Beam Control

- Microwave and millimeter-wave tubes such as klystrons and magnetrons.
- Focusing lenses and beam-bending magnets in particle accelerators.
- Wigglers and undulators in synchrotron radiation sources.
- Deflection magnets in mass spectrometers.

Microwave devices, gyros, and accelerometers are a high-technology speciality market for REPMs. Only small quantities are used, but special compositions and processing are required for internal temperature compensation and high-temperature, long-term stability. The same is true for particle accelerators and synchrotron sources. However, if predicted applications in chemical industry and defense should develop, requirements for several times the present REPM production capacity would arise.

Medical Applications

- Force devices such as catheters.
- Field sources for nuclear magnetic resonance (NMR) tomography.

Medical uses will consume very little magnet material, usually REPMs. An exception could be NMR scanners: if new PM systems are successful, significant quantities of ferrite or Nd-Fe-B might be required.

Some of the electromechanical uses require a large supply of inexpensive magnets, often with only modest properties. In contrast, developments in the communications and energy-beam fields demand the best possible PM properties, while the quantities consumed are small to moderate and materials cost is secondary. Such devices encompass millimeter-wave and microwave tubes and filters, multipole structures for particle accelerators, and the new synchrotron light sources, all areas of fairly rapid growth.

In some long-established uses, older types of permanent magnets are being replaced by digital semiconductor circuitry and piezoelectric devices, for example, in galvanometers, telephone relays, and mouthpieces. Semiconductors are also making some inroads in microwave technology. But these are all low-current devices. Magnetic technology is firmly entrenched in the power device field. Where PM designs compete with electromagnetic ones, the permanent magnets are increasingly winning because of the new magnet materials.

Attempts to associate a dollar market value with devices using permanent magnets are difficult. Magnets are essential (though often hidden) components of many expensive products and thus have high leverage in technological markets.

Table 3 shows quantities produced and the sales value of finished magnets (not the devices containing them) for 1982 in four major materials categories. These numbers include the "captive" production by automobile manufacturers such as General Motors and Chrysler. Data on the regional distribution of noncommunist world production show that Japan produces 40 percent, the United States 32 percent, Europe 20 percent, and others 8 percent. Japanese manufacturers now supply 20 to 25 percent of the U.S. market for permanent magnets. Proprietary considerations and the international nature of the business make the figures uncertain. The overall market size at present is about \$1 billion, of which 30 percent is U.S. production. In the past 10 years, the U.S. industry has lost its lead in production technology and its dominance of the PM world market. This attrition process continues.

TABLE 3 1982 Production Estimates and U.S. Market Figures

Type of Product	Noncommunist World Production		Avg. PM Price, Dollars per Pound	Market Distribution: Percent of U.S. Sales in Dollars	
	Millions of Pounds	Millions of Dollars		1972	1982
Alnico	20	250	12.20	40	35
Ferrites	300	350	1.70	50	46
REPM	1	80	80	0.5	11
Other	10	120	12	9.5	8
Totals	331	800	--	100	100

SOURCE: R. Parker, private communication, 1984.

The total magnet industry output (pounds) grew fairly steadily from 1960 to 1982 at an average annual rate of 8 percent. Present growth (1983-1984) is estimated at 20 percent. This recent acceleration is mostly in ferrites. REPMs are also growing very fast but from a small total volume. Alnico production is severely down since the cobalt (in constant dollars) are expected to at least triple in 10 years because of the growth of PM-dc motor applications.

The number of U.S. magnet-producing companies is about 15 (9 major ones); in the world, about 100. The traditional affiliation with steel manufacturing has largely ceased. Some large consumers (particularly automotive) now produce much of their own magnet needs.

Technical Issues

Although the present surge in magnet applications was driven by the availability of new PM materials, use trends now place various, sometimes conflicting, demands on future magnet development. The motor mass market requires a plentiful materials supply and low magnet cost. This calls for automated mass-production methods for ferrites and, perhaps, Nd-Fe-based REPMs. But for specialty motors and generators and aerospace and robotics applications, the premium is on performance, so magnets with still higher energy and coercivity are desired.

Objective for Mass-Consumption Magnets

- Reduced use of expensive, limited supply, or strategic elements (Sm, Co).
- Cheaper manufacturing processes, easier magnetizing methods.
- Lower magnet cost per unit of energy.
- Reduced temperature-dependence of magnetic properties, especially for ferrites, Nd-Fe-B, and Mn-Al-C.
- Improved mechanical properties, reduced brittleness.
- Improved property consistency and production yields.

Objectives for High-Performance Magnets

- Higher remanence and energy product, coercivity of 15 to 20 kOe, and good loop squareness.
- Intrinsic temperature compensation over different use ranges.
- Improved long-term stability at elevated temperatures.
- Methods for making very large as well as small, thin, and/or intricate shapes.
- Improved property uniformity in ring magnets and large pieces.

Current Research and Development

The promise of RE-Co, Fe compounds, and later the cobalt supply crisis, caused intense global R&D activity in the last 18 years that led to new PM materials and to better understanding. The fundamental work leading to the REPMs was done largely in the United States and sintered SmCo was developed into a product here, with heavy Air Force and Defense Advanced Research Projects Agency investment. But after government support ceased, materials R&D in the U.S. magnet industry deteriorated. Practically all recent PM materials have been developed to commercial maturity in Japan ("2-17" RE-Co magnets, epoxy-matrix REPM, Mn-Al-C, and Nd-Fe-B). Several traditional centers of PM research in the United States--at Indiana General, Bell Labs, and GE--dispersed their magnetics teams; so did the contract laboratories, Franklin Institute, Stanford Research Institute, and Battelle. Only Colt Industries and General Motors have maintained a good level of research activity.

Magnet application development did proceed in U.S. industry, largely for defense and computer uses, and with support from DOD agencies or NASA. But the growing requirements for high-performance magnets, efficiently mass produced--for motors, computer printers, microwave tubes, ion-beam devices, etc.--are increasingly filled by imports, mostly from Japan, where the magnet industry has aggressively expanded, modernized, and continued materials development.

At U.S. universities, PM materials research was never strong; however, at least the Universities of Dayton and Pittsburgh maintained groups working on REPM development in the last decade, with a few isolated individuals working at other institutions. All depended entirely on government and industry support, so they had lean years. One disastrous consequence of insufficient academic effort is a severe lack of young engineers and materials scientists having systematic knowledge and research experience in this difficult field. This occurs at a time when a generation of magneticians will retire soon from the producing industry and when many magnet user companies wish to hire engineers for their expanding device development and production efforts. Since permanent magnets are crucial components for such a wide range of machines and electronic and mechanical devices, the present neglect of education and research in this field will have serious adverse consequences for the industries that utilize magnets.

Federal agency interest in PM materials research was recently rekindled by ARO and NRL. Government support for research by magnet producers would accelerate application of basic findings generated worldwide and would increase the number of trained people in this field. The U.S. magnet-producing industry and most of its constituent companies are too small to afford a great amount of new product and plant development, much less conduct long-range research and effectively support needed education efforts.

Opportunities

In this section we indicate some areas in which work is urgently needed or where important future progress seems possible.

Manufacturing

- Nd-Fe-B and derivatives: Develop efficient alloy and magnet production methods. Make alloy modifications to improve elevated temperature properties. Characterize magnetic and physical design properties. Study and improve chemical and magnetic stability.
- REPM matrix magnets: Develop efficient production methods for arcs, rings, and large-size magnets of good uniformity and thermal stability. Evolve specialized property systems by powder blending, different binders. Perfect injection molding and extrusion techniques.
- Mn-Al-C: Develop cheaper alternatives to extrusion for forming and orienting.

Materials

- REPM: Improve elevated-temperature properties of Nd-Fe-B. Develop intermediates between present RE-Co and RE-Fe-B magnet alloys, precipitation-hardened versions, direct reduction method for alloy powder. Change RE-Co-transition metal compositions to maximize remanence and energy, minimize cost. Develop easy-to-magnetize high-coercivity 2-17. Improve corrosion resistance, stability of REPM powders.
- Ferrites/oxide magnets: Try increasing saturation while maintaining other properties. Search for ferrite systems with higher Curie point. Improve low-temperature coercivity.
- Rapid quenching technique (now used with Nd-Fe-B): Apply to other powder metal alloys (such as Alnicos) to increase coercivity by creating metastable phases and ultrafine microstructures. Develop anisotropy in melt-spun alloys. Explore economics of melt-spinning method.

Scientific

- Develop better understanding of the factors controlling anisotropy of alloys and compounds, their Curie temperature, and the magnetization reversal mechanisms in magnets, particularly REPM.
- Understand the role of metallurgical microstructure in domain-wall pinning, ways of controlling it, and the relationship between coercivity and microstructure of rapidly solidified alloys.

- Study unidirectional solidification of REPM alloys for magnets with perfect crystal orientation.
- Search for new ternary and quaternary intermetallics that combine high saturation, Curie point, and anisotropy, qualifying new PM materials.
- Study properties of permanent magnets at cryogenic temperatures for future cold environment devices.

SEMIHARD MATERIALS

Semihard magnet materials generally exhibit coercivities in the range of 10 to 100 Oe. These materials belong to the low-coercivity end of PM materials. During device operation they provide biasing fields on a soft magnet material that can be conveniently reversed by an external field, or their own magnetization is reversed by the external field. There are several commercially available semihard magnet alloys such as magnet steels, Remendur, and Vicalloy. Their properties are listed in Table 4.

TABLE 4 Some Semihard Magnet Alloy

Magnet Material	Chemical Composition	Br, kG	Hc, Oe	(BH) _m , MGOe
3.5% Cr steel	3.5Cr, 1C, balFe	10.3	60	0.30
3% Co steel	3.25Co, 4Cr, 2C, balFe	9.7	70	0.35
17% Co steel	18.5Co, 3.75Cr, 5W, 0.75C, balFe	10.7	150	0.70
36% Co steel	38Co, 3.8Cr, 5W, 0.75C, balFe	10.4	220	0.90
Vicalloy I	10V, 52, Co, balFe	7.5	240	0.75
Remendur	2V, 49Co, balFe	18.0	30	-
Nibcolloy	3Nb, 85Co, balFe	15.0	20	-
Vacozet 655	Co-Fe-Ni-Al-Ti	14.0	40	-
Experimental*	8Mo-1Ni-balFe	18.0	30	-
Experimental*	15Cr-5Mo-balFe	15.0	30	-

*Experimental alloys developed by S. Jin, AT&T Bell Laboratories.

In the United States, although there are a number of manufactures in magnet steels, only Cartech makes Remendur and Vicalloy; Arnold Engineering makes Vicalloy.

Applications and Market

Semihard magnet alloys are used in three major application areas: hysteresis devices, telecommunications, and security and antitheft.

Hysteresis Devices

Hysteresis devices are based on the principle that the magnet hysteresis energy can be used to provide a mechanical torque. The torque can then be used to drive a rotating shaft as in a hysteresis motor or to provide a braking or clutch action as in a tensioning device.

Hysteresis motors are used in clocks and timers, turntables, valves for zone heating and cooling, and flue dampers where smooth and quiet operations are desired. Magnet steels are used, generally in ring form attached to the rotor. The U.S. production is estimated to be about 100,000 kg per year or \$2 million of magnetic alloys going into 10 to 20 million motors at a price range of \$5 to \$80 per motor (Jin, private communication, 1984). In the future the use of hysteresis motors in clocks and timers will decrease as clocks increasingly become digital or quartz and as timers in appliances utilize microprocessors. For other applications, a modest growth in use is expected.

Hysteresis clutches and brakes are used in tensioning devices for the textile and paper industries and in computer disk drives. Vicalloy in the form of a cup is generally used, with production about 7,000 kg per year, or \$40,000. The trend in disk drives is toward friction brakes and brushless dc motors, while use in tensioners is expected to remain steady.

Telecommunications

In the telecommunications area, the major use of semihard magnets is in self-latching remanent-reed electrical contacts for telephone switching systems. These consist of a pair of paddles sealed in glass, the contact between them controlled by a current passing through an external coil. The reed material is fabricated by drawing the alloy to a wire of about 0.5 mm diameter followed by flattening to 0.2 mm thick in the paddle section. Magnetic requirements call for a high remanent induction and controlled coercivity of 20 to 100 Oe. Currently the alloy of choice is Remendur in the United States (about 20,000 kg per year, or \$1.5 to 2 million), Nibcolloy in Japan, and Vacozet in Europe. In the future the market for remanent-reed contacts is expected to decline as they are gradually replaced by high-voltage silicon devices such as gated cross-point diodes.

Security and Antitheft

Antitheft devices consist of tags attached to articles such as library books, clothing, or grocery goods. When passed through a suitable detection gate, the tag will send off a signal unless it is properly desensitized or removed. Currently, there are three competing technologies: microwave, RF, and magnetic. The magnetic detection scheme consists of a composite thin strip of a soft magnetic alloy such

as Permalloy and a semihard alloy such as Vicalloy. The magnetic response of the Permalloy to an externally applied field is then dependent on whether or not the Vicalloy has been magnetized.

Current production of Vicalloy strips (50 μm thick) is of the order of 5,000 to 10,000 kg per year for the magnetic antitheft devices. These are primarily used in library systems. The main advantages of the magnetic device is the low cost per tag (5 to 10 cents). However, the coverage area is small (about 1 m^2) and the detection system bulky. Consequently, in the retail area more use is made of the microwave and RF technologies. The microwave detection system is compact and operates on a large sensing distance (3 to 5 m) while the RF system operates at an intermediate sensing distance (1 to 3 m). Both systems, however, have the disadvantages of high cost per tag (about \$1.00) and ease of shielding against the detection system.

The trend is for modest growth in library systems and high rate of growth in the retail area. Whether magnetic systems can successfully penetrate the latter market is uncertain at this time.

For security in building access, semihard magnets in the form of Vicalloy wire segments embedded as an array in a plastic card are used for identification. These Wiegand-effect wires are specially processed by a complex sequence of wire drawing, twisting, and heat treating operations to produce a magnetically soft core of low coercivity surrounded by a hard shell of higher coercivity. As a result, the magnetization reversal becomes abrupt, giving rise to an induced EMF in a pickup coil. The advantage of this system as compared with conventional ferrite particle media is that the signals from the physical array of specially treated wires cannot be easily duplicated. In addition to this use, Wiegand-effect wires have also been explored as position sensors and voltage pulse generators.

Technical Issues

For hysteresis device applications, the current commercially available materials have adequate magnetic properties. Likewise, in the telecommunications field, no major technical issues remain. Furthermore, in the past several years, new improved alloys such as Fe-8Mo-1Ni and Fe-12Cr-5Mo have been developed in the laboratory with properties comparable to Nibcolloy and Remendur, respectively (see Table 4). The new alloys are cobalt-free and exhibit improved ductility. For the security and antitheft area, there is a need for materials with a wider range of coercivities (switching fields) to permit a greater flexibility of design. Materials that are simpler to process but otherwise perform the same functions as the Wiegand-effect wires would also be desirable.

Current Research and Development

Current R&D efforts on semihard magnet materials are limited because of the small size of the market, availability of alloys with adequate properties, and limited growth potential. However, the security and antitheft area is expected to show the highest growth potential. There

is current activity in developing materials with a wide range of coercivities as well as simpler processing compared with that for the Wiegand-effect wires. This activity requires an intimate collaboration among electrical design engineers and materials specialists, since an optimum low-cost design involves tailoring the magnetic flux output to the electronic instrumentation.

Opportunities

The work on security and antitheft devices typifies the magnetic sensor area which could have potentially wide-ranging applications such as low-cost magnetic tags, motion sensors in robotics, and remote magnetic activation of implanted biomedical devices to control body functions. As stated previously, this type of activity requires an interdisciplinary approach if it is to be successful. At the same time, one must recognize that magnetic sensor technology is but one of a wide variety of sensor technologies based on various physical, chemical, and mechanical properties.

REFERENCES

Strnat, K. 1983. Study and Review of Permanent Magnets for Electric Vehicle Propulsion Motors. NASA CR-168178.

Strnat, K., G. Hoffer, J. Olson, W. Ostertag, and J. J. Becker. 1967. J. Appl. Phys. 38:1001.

Chapter 4

SOFT MAGNETIC MATERIALS

LOW FREQUENCIES

Soft magnetic materials are used principally in motors, generators, transformers, and related equipment. The function of the magnetic material is to produce a high magnetic flux density in some region of space. This flux density must change with time in magnitude or direction or both. The two principal materials requirements are a high working flux density and a low energy loss when the magnetic flux is changed.

The highest flux density is available in iron-cobalt alloys. The cost of the material in a device using a soft magnetic alloy is usually the major portion of the cost of the final device, and this effectively rules out the use of the much higher cost cobalt alloys except for special applications. This is in contrast to PM devices, where the cost of the permanent magnet is a small fraction of the total cost of the device. On the other hand, the relatively low electrical resistivity of iron leads to large eddy-current losses with changing flux. This problem has been dealt with in two ways: first, by electrically subdividing the iron into thin sheets or laminations and, second, by adding alloy elements to increase the intrinsic resistivity. Energy losses can also be lowered by removing sources of domain wall pinning, primarily second-phase particles and regions of elastic or plastic deformation.

A high working flux density is attained by increasing the permeability--that is, by approaching the saturation flux density at relatively small fields. In most materials the approach to saturation is limited by the field needed to rotate the local magnetization against crystal anisotropy forces. Improved performance can be achieved by using a single crystal or a textured polycrystal with the working flux direction parallel to an easy direction of magnetization or by choosing a composition or structure for which the anisotropy is small. The sensitivity to stress can be minimized by choosing a composition with zero magnetostriction.

These general principles have led to the general use of three major categories of metallic materials. In order of increasing price and quality, these are nonoriented electrical steels, grain-oriented electrical steels, and nickel-iron alloys. A relatively new class of materials, amorphous alloys, may compete successfully against the latter two.

Nonoriented electrical steels are basically low-carbon steel sheets made by the same rolling and annealing process used for automobile body sheet. For magnetic use they are made with carbon content as low as is practical and normally have some crystallographic texture of the (001)[100] type. Silicon up to about 3 percent may be added to raise resistivity, but silicon above 3 percent makes the steel too brittle to process by normal methods. Thicknesses are usually in the range of 0.35 to 0.5 mm. This material is made worldwide by most sheet steel producers and is used for motors and generators and for transformers where low cost is more important than low loss. Losses as measured in stacked sheets are in the range of 2 to 4 W/kg at 60 Hz and 1.5 T maximum flux density, depending on composition and sheet thickness.

Grain-oriented electrical steels contain about 3-1/4 percent silicon. This eliminates the phase change from bcc to fcc that occurs in iron at 910°C and makes possible a sequence of rolling and high-temperature annealing steps that produce a very strong (110)[001] texture. The process was developed about 1939, and commercial production began in the late 1940s. This material is normally made in thicknesses of 0.23 to 0.35 mm, with losses of 1.3 W/kg at 1.7 T. It is used in power transformers of all sizes where low loss is of primary importance and in some large rotating machines. There are now just two U.S. producers, Armco and Allegheny-Ludlum. Grain-oriented steel is made also in Japan (Kawasaki and Nippon), the United Kingdom (British Steel), West Germany (Thyssen), France (Creusot-Loire), Italy (Terni), Korea (Posco), and recently in Brazil and India, as well as in eastern Europe.

Within the past 10 years, improved grades of grain-oriented silicon steel have been introduced by various steelmakers, starting in Japan. These are often referred to by the trade name HiB steel; they have better texture, larger grain size, and lower losses at high working flux densities than conventional oriented steel. An important feature of these steels is the use of a stress-coating. This is a thin layer of a glassy material that places the sheet under a small elastic stress because of differential thermal contraction between the steel and the coating. Since the elastic modulus of the textured steel sheet is anisotropic, this gives a preferential strain in the rolling direction and improves the magnetic properties in that direction by interaction with the magnetostriction.

Another recent technique to reduce losses is the deliberate introduction of nucleation sites for additional domains, now accomplished by scribing very narrow lines on the sheet surface with a focused laser beam (laser scribing).

Nickel-iron alloys are made in two principal compositions: near 80 percent Ni, 20 percent Fe, often with about 4 percent Mo; and 50 percent Ni, 50 percent Fe. The 80-20 composition has low crystal anisotropy and low magnetostriction and when properly heat treated has very high permeability and low losses; the saturation flux density is about 1.0 T, about half that of iron. The 50-50 alloy has a higher saturation flux density of about 1.5 T. It can be made with a strong (100)[001] texture. These materials were developed mainly by the Bell Telephone Labs in the 1930s and have the generic trade name Permalloy. They cost 5 to 10 times more than electrical steels and are used in small devices--transformers, inductors, recording heads, shielding--where very high permeability and/or very low losses are required. Thickness varies according to use; some very thin gauge material is made around 0.03 mm. There are two U.S. producers (Cartech and Allegheny-Ludlum) plus at least one company producing for internal use (Magnetics Inc.). Nickel-iron alloys are also produced in toroidal form for inductors (loading coils) for telephone use by powder metallurgy techniques. Powder metallurgy is also used to make iron, iron-silicon, and iron-phosphorus alloys where complex shapes are required. The combination of alloying elements plus porosity resulting from the manufacturing process gives the material relatively high apparent resistivity, so the parts are useful in ac or pulsed-field applications such as dot-matrix printers.

Ferromagnetic amorphous alloys are made by very rapidly freezing liquid alloys on a metal surface. The method was devised by Duwez in 1958 and first developed as a manufacturing technique by Allied Corporation, which has provided material for sale since 1974. The manufacturing process produces thin ribbon, with a maximum thickness of about 0.035 mm, and only certain compositions can be made amorphous by this process. The usual magnetic alloys are FeBSi, FeNiBSi, and CoFeNiBSi, with B + Si = 15 to 25 atomic percent. The high-cobalt alloy has near-zero magnetostriction. The absence of microstructure, small macroscopic anisotropy, high electrical resistivity ($\sim 150 \mu\Omega/\text{cm}$), thin gauge, and high elastic limit make amorphous alloys excellent soft magnetic materials. Properly annealed, they have high permeability, low losses, and saturation flux densities up to 1.6 T or above. Since thin sheet is made from the melt in one high-speed operation, and high levels of purity are generally not required, production costs can be low.

Amorphous alloys will be used where their unique combination of properties makes them competitive with nickel-iron alloys, grain-oriented electrical steels, or ferrites. They are superior to nickel-irons in having higher resistivity, high mechanical hardness, lower losses, and lower costs; they are superior to oriented steels in having high resistivity, thinner gauge, and much lower losses at potentially similar cost; and they are superior to ferrites in having much higher flux density and permeability and sometimes lower cost.

Amorphous alloys are produced for sale in the United States only by Allied Corporation; in Japan by Namco (an Allied affiliate) and by other companies (Sony, TDK, Matsushita) for internal use; and in Germany by Vacuumschmelze. The patent and licensing situation is complex and in litigation; this is hindering commercial applications.

Applications and Market

Nonoriented steels are used in motors, some generators, and lower quality transformers such as for lamp ballasts. Oriented steels are used in high-quality power and distribution transformers and in some generators. The nickel-iron alloys are used where the very high permeability or low losses are necessary and where the cost of the materials is not the major consideration--for example, in signal transformers and in tape heads. In addition to traditional applications of nickel-iron using their high permeability, the hysteresis loop can be conveniently altered to exhibit either a square or skewed shape for special applications. For recording heads, alloying additions have been made to confer wear resistance via precipitation hardening. In newer applications, the nickel-iron alloys are increasingly used in thin-film form--defining bubble movement patterns in bubble memories, as magnetoresistance sensors, and in thin-film recording heads. Here the technical issues revolve around the relationship between processing, structure, and properties of these films. The amorphous alloys are just beginning to be used in commercial products, principally in various types of tape heads, where the combination of high hardness and high permeability is essential, and in small transformers, for example, for switched mode power supplies.

Table 5 gives some data on the production levels and growth trends of these materials. Note that U.S. production of electrical steels dropped sharply from 1972 to 1983. This is a result of the drop in growth of demand for electricity caused by the jump in oil prices in 1973, the general recession in the U.S. economy, and (recently) the increase in imports of steel to the United States. Only modest growth is foreseen for electrical steels in the near future.

TABLE 5 U.S. Production of Soft Magnetic Materials

Material	1973	1983		Annual Growth Rate to 1990 (kg), percent
	Millions of kg	Millions of kg	Millions of dollars	
Grain-oriented electrical steel	668*	204	340	2.5 to 3
Nonoriented electrical steel, >0.6 percent Si		500	500	4**
Nonoriented electrical steel, <0.6 percent Si	114	43	28	
Nickel-iron alloys	--	3.5	50	-4 to +8
Amorphous alloys	--	<0.06	<0.7	0 to 10 ³

SOURCE: G. L. Houze, private communication, 1984.

*Represents total kg of both grain-oriented and nonoriented electrical steel.

**Represents total percent of both nonoriented electrical steel.

Demand for nickel-iron alloys is uncertain; the telephone industry has been a large consumer, but the adoption of digital transmission technology will sharply curtail this market. Future sales of amorphous alloys are uncertain but could be large.

Technical Issues

The technical issues involved in controlling the properties of soft magnetic alloys are somewhat different for the various alloys.

In the case of nonoriented steels, where minimum cost for a reasonable level of loss is desired, losses can be readily reduced from the present 2 to 4 W/kg (measured at 60 Hz and 1.5 T) to 1 W/kg by simply decreasing the gauge. However, the cost will increase because of the additional rolling and annealing required, plus the added manufacturing cost of punching and assembling more laminations for each machine. Other methods of reducing losses will also increase the cost. For example, losses can be reduced by making cleaner steels through the removal of aluminum and titanium, which form oxide inclusions that interact with the domain walls.

For grain-oriented electrical steels the dominant quality factor is ac magnetic loss at high operating flux levels (1.7 T). For these alloys, many approaches to decrease losses are used. Over the past 5 to 10 years the thickness has been reduced from 0.28 mm down to the presently available 0.23 mm, with 0.18 mm now produced on an experimental basis. This has reduced the losses (at 60 Hz and 1.7 T) from 1.4 W/kg at 0.28 mm to 1.3 W/kg at 0.23 mm to 1.2 W/kg at 0.18 mm. As the gauge decreases, the domain spacing increases, somewhat offsetting the gain from the thinner gauge. Thus, laser scribing of the surface to nucleate additional domains becomes more effective in reducing losses as the gauge decreases. As the gauge is reduced, the losses measured in a wound core become lower than those measured in straight strips. The origin of this difference is not clear. The Japanese steelmakers produce material with a smaller grain size than the U.S. producers. Thus, they have less to gain by using surface scribing techniques to reduce domain spacing. Even so, the laser scribing technique is now in limited production in Japan and provides a further decrease in losses of about 0.1 W/kg.

Crystal texture improvements result in increasing values of hysteresis loop squareness with resultant decreases in losses. Texture improvements have come about by improved control over the secondary recrystallization through control of impurities in the steel. With conventional texture, losses (at 60 Hz, 1.7 T, 0.23 mm) of 1.3 W/kg are obtained. With improved textures now in production, losses of about 1.2 W/kg are obtained, while in a laser-scribed sample losses of 1.1 W/kg may be obtained. The minimum loss measured experimentally for a laser-scribed sample 0.1 mm thick with a high stress coating was 0.55 W/kg. These losses are all higher than the losses found for amorphous iron-boron-silicon alloys, namely, 0.25 W/kg (at 1.4 T) for the losses measured in preproduction units of 25 kVA distribution transformers or 0.02 W/kg (at 1.4 T) for the lowest loss reported in the literature for this alloy. Note that amorphous alloys operate at lower flux density than silicon steels.

It should be noted that the Japanese steel producers have twice the number of people in development work compared to the U.S. industry; thus it is likely that they will lead in most innovations. The cost of a new plant, however, is large (\$50 to \$100 million), and the market for oriented electrical steels is relatively small. Thus investment in entirely new plants will not normally be warranted unless a dramatic improvement in properties is obtained.

Development work on nickel-iron alloys was essentially complete by about 1975. The metallurgy and magnetic behavior of these alloys are reasonably well understood. The prospects for significant improvements by additional work appear minimal.

There are several problems with the use of amorphous alloys. The domain size is large because of the absence of grain boundaries or nucleation sites. Lower losses could be achieved if the domain sizes were reduced. Perhaps laser scribing would be useful here. The present technique of producing a small percentage of fine crystalline precipitates should be improved. The instability of these alloys against crystallization or change of permeability with time (disaccommodation) is a problem in some applications. For example, in contact recording heads, deterioration has been attributed to crystallization induced by the heat generated by the friction between the head and the recording medium. Thus the development of alloys with improved stability would be highly desirable. The wear resistance is surprisingly poor. This is not understood in view of their high hardness, and it is particularly important in recording heads. In many applications it would be desirable to have thicker ribbons or bulk pieces of amorphous alloys rather than being limited to approximately 35 μm thick ribbons for most compositions. Zero magnetostriction alloys are limited to the expensive cobalt-rich compositions. Finally, there exists in the United States only one source for the amorphous alloys, Allied Corporation. This sole-source arrangement discourages a number of possible users and represents a major opportunity for additional suppliers if and when the patent situation is resolved or favorable licensing arrangements can be made.

The same processing techniques used to make amorphous ribbons can be used to make crystalline ribbons. The composition of major current interest here is the zero magnetostriction alloy of iron with 6.5 percent Silicon, which cannot be made by conventional rolling. Properties equivalent to the nonoriented FeSi alloys have been achieved, but it is not clear yet whether this will be a competitive product.

Current Research and Development

Current R&D on electrical steels is concerned with the problems of reducing the gauge to achieve lower losses and trying to achieve lower losses by, for example, scribing the surface in a controlled manner or by the use of stress coatings.

There is no current research of any significance on nickel-iron alloys.

The current R&D on amorphous alloys is very large. Since it is a relatively new field there is still considerable effort on exploring the preparation and properties of new, as well as old, amorphous alloys. The large-scale production of wide ribbons is still very much a development problem. The amorphous structure and the relation of the structure to the properties are still being explored. Many questions concerned with the stability of the permeability are under investigation. In parallel with these research efforts, General Electric has built 25-kVA transformers under a \$7 million 3-year contract from the Electric Power Research Institute (EPRI); these have been installed in utilities throughout the United States for testing. One thousand more transformers are scheduled to be built next year.

Opportunities

Electrical Steels

Incremental improvements can be made by further developments in domain size control through laser scribing, stress coatings, grain size, or perhaps other means; all these are appropriate research topics. Better steel-making practice can lower impurity and inclusion levels; these improvements would apply generally to all steels, not just electrical steels.

The control of texture in steels is almost entirely empirical. A real understanding of the origin of texture could lead to major advances in steel properties. A strong (100)[001] texture in Silicon steel or in iron sheet would lead to much-improved motors and generators. The level of understanding of grain boundaries and deformation, based on computer modeling and high-resolution microscopy, may be reaching a level where such texture control is possible.

Nickel-Iron Alloys

The prospects for significant improvements in nickel-iron alloys are slight. Current interest in these materials lies mainly in use as recording heads, probably in thin-film form (see the section on magnetic recording). Problems include the microstructure (grain size, orientation, morphology) of the films as a function of deposition parameters and its effect on such properties as magnetic hysteresis, corrosion, and the very extensive work done on thin-film nickel-iron alloys in the 1960s as computer memory materials and in the 1970s, as bubble memory overlays.

Amorphous Alloys

In amorphous alloys we see technical opportunities in casting thicker ribbons or making bulk forms by, for example, stacking and bonding ribbons or by consolidation of amorphous powder or flake. We should also explore techniques for refining the domain structure and for understanding the role of precipitate size, morphology, orientation, and magnetic properties on wall nucleation and pinning. Research in

manufacturing technology to make effective use of amorphous alloys and for rapidly solidified crystalline alloys is also needed.

Other routes to forming ribbons should be examined, such as rapid solidification by atomization and the preparation of new crystalline microstructures or alloys by rapid solidification. Radically different compositions, such as ferrites and other insulators, should be investigated by rapid solidification for possible development of high-frequency materials. Work should be done on methods of depositing and using amorphous materials in very small areas for use in integrated circuits and in microdevices made by integrated-circuit techniques.

The surfaces of amorphous alloys remain a mystery but are known to strongly affect magnetic performance. What oxides, absorbates, etc., are on the surface, and how do they affect magnetism, reactivity, wear, crystallization, and after effects?

The melange of phenomena that depend on atom motion (relaxation, disaccommodation, field annealing, reversible structural transformations, etc.) should be understood in a more unified way. When is diffusion involved and when do atoms simply rearrange or shuffle as in a shear transformation? What is the role of impurities, particularly in after effects?

It is still unclear why glasses form. It was thought to require rapid solidification, allowing nucleation and growth to be bypassed, until the recent synthesis of metallic glasses from crystalline solids below 100°C. Why are non-close-packed local structural units so important, and what does this mean for moment formation and coupling? We need to understand more about the local structure of Fe-B vs. Fe-P systems and the whole issue of why the moment and Curie temperature behave differently with variation in metalloid content in Fe-rich alloys compared to Co-rich alloys. What are the connections between chemical bonding (glass formability and stability) and magnetism?

Amorphous alloys are a new state of matter, and a large number of basic scientific questions can be addressed using the full range of modern theoretical and experimental techniques. These should be undertaken for general scientific interest, even though it is not clear what practical applications may result.

HIGH FREQUENCIES

Above a frequency greater than about 10 kHz, soft magnet alloys such as the Fe-Ni Permalloys become degraded by eddy current losses. The preferred materials in the high-frequency range are the soft ferrites, whose value of electrical resistivity is more than six orders of magnitude greater than the metals.

The term ferrite has come to mean the whole class of magnetic oxides. There are three crystal classes of commercial ferrites in use today. One class has the hexagonal structure of the magnetoplumbite type, such as $\text{BaFe}_{12}\text{O}_{19}$. It is the basis of PM ferrites. The second

class has the garnet structure, such as $Gd_3Fe_5O_{12}$, used in microwave devices and in bubble memory technology. The third class has the spinel structure, with the general formula MFe_2O_4 , where M is a divalent metal ion. The most common spinel ferrites in use are the manganese-zinc and nickel-zinc ferrites, in transformers, inductors, and recording heads. Other spinel ferrites, such as magnesium-manganese, nickel-zinc, and lithium ferrites, are used in microwave devices. In this section, the discussion is limited to spinel ferrites used in nonmicrowave applications. Permanent magnet ferrites are discussed in Chapter 3, microwave garnets later in this chapter, and bubble garnets in Chapter 5.

Spinel ferrites were first developed in Japan (Kato and Takei, 1933) and in Holland (Snoek, 1936). Commercial utilization increased rapidly after World War II as ferrites replaced the bulky laminated iron alloy cores in flyback transformers for the emerging television market. The operating frequencies of those transformers (≥ 150 KHz) were too high for the metal alloys. Similarly, in the telecommunications area, ferrite transformers and inductors replaced their metal counterparts because of the higher design frequencies.

With the exception of a few instances where single crystals are used, all ferrite components are prepared by ceramic techniques. A typical processing sequence includes (1) mixing of component oxide powders such as Fe_2O_3 , $MnCO_3$ and ZnO ; (2) grinding the powder into a ball mill to achieve homogenization and a small particle size; (3) calcining, or prefiring, the powders to achieve partial chemical reaction; (4) regrinding the calcined powder to refine the particle size and adding binders and lubricants in a sort of slurry; (5) spray-drying the slurry to agglomerates of uniform size; (6) compacting the spray-dried powders to a desired size and shape; and (7) sintering the compacts at high temperature for final conversion to ferrite, densification, and grain-size control. The control of microstructures and stoichiometry during all stages of processing is very important in terms of the magnetic behavior of the finished ferrite component.

The major producers of commercial soft ferrites include Ferroxcube, Indiana General, Magnetics Division of Spang Industries, and Stackpole in the United States, TDK and Fuji Chemical in Japan, Philips in Holland, and Siemens in Germany.

Applications and Market

The market for transformer and inductor ferrites is estimated to be about \$400 million worldwide in 1982, with one-fourth of that in the United States (R. Sundahl, private communication, 1984). There are three major segments of this market. For the United States, the breakdown is about 25 percent telecommunications, 25 percent power, and 50 percent consumer (R. Sundahl, private communication, 1984). The market for recording head ferrites is also large, currently estimated at \$37 million in the United States in digital recording systems alone (G. W. Brock, private communication, 1984).

In the telecommunications area, device functions make use of the so-called linear region of the initial magnetization curve. Hence these are also called linear ferrites. The most important devices are inductors, particularly those used in LC filters in frequency-division multiplex telecommunications transmission systems, and low-power wide-band and pulse transformers. In the design of inductors, the most useful quality index is in the $\tan \delta / \mu'$, where $\tan \delta = \mu'' / \mu'$ is the ratio of the imaginary to the real part of the complex permeability. Advances in recent years have led to the development of MnZn ferrites with value of $\tan \delta / \mu' < 10^{-6}$ at 100 kHz, making possible a several-fold reduction in the size of inductors. In addition, other important material parameters such as disaccommodation (decrease in permeability with time) and temperature coefficient of permeability have likewise been improved.

Because of the higher permeability associated with low values of magnetocrystalline anisotropy, MnZn ferrites are generally preferred over NiZn ferrites up to a frequency of about 2 MHz. Beyond this, NiZn ferrites are preferred because of lower eddy current losses associated with the greater electrical resistivity. The composition of MnZn ferrites, which has been optimized for high permeability, also contains ferrous ions, which tend to decrease the electrical resistivity because of electron hopping between Fe^{2+} and $-\text{Fe}^{3+}$.

For transformer applications, the highest value of μ over the operating frequency range is desired. Values of μ' in the 18,000 range (at 10 kHz) for MnZn ferrite are commercially available, although values up to 40,000 have been achieved in the laboratory. Again, MnZn ferrites are used up to about 1 to 2 MHz, beyond which NiZn ferrites are preferred.

Characteristics of some commercial ferrites for telecommunications use are given in Table 6.

TABLE 6 Typical Commercial Ferrites (TDK Catalogue)

Material	MnZn	MnZn	MnZn	NiZn	MnZn
Application	Deflection Yoke Coils	Transformer	Inductor	Inductor	Power Supply
Practical frequency, MHz	0.01-0.40	<0.1	0.01-0.8	<200	<0.3
Initial permeability, μ_i	850	10,000	1,300	16	2,500
Relative loss factor $\tan \delta / \mu_i \times 10^6$	20	<7.0	<1.2	<250	-
at (kHz)	(100)	(10)	(100)	(100,000)	-
Curie temperature, °C	>180	>120	>200	>500	>230
Saturation induction, G	4300	4000	4700	2700	5100
Resistivity, $\Omega\text{-cm}$	50	0.15	25	10^5	10

In the power area, ferrite cores are used in transformers that serve as the energy storage medium for a switched mode (ac to dc) or converter mode (dc to dc) power supply now widely used in microcomputers, private exchange telephone systems, and various computer peripheral equipment (Figure 3). Because of their greater electrical resistivity, ferrites are increasingly preferred over the metals as the operating frequency has continued to rise in an effort to shrink the size of power supplies. In addition, ferrites are also needed as filter elements in power supplies. Requirements for the magnetic materials used in the transformer and output filter choke are the same as for conventional dc-dc converters, namely, low core loss, moderate permeability, high B_s (up to 130°C), and low cost. These material requirements are usually met by MnZn ferrites for the transformer and output filter inductor, with laminated steel cores sometimes being used for the filter inductor.

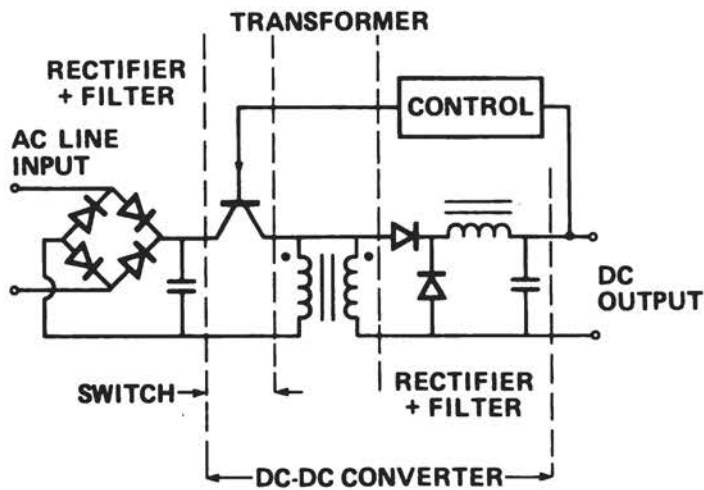

FIGURE 3 Simplified schematic diagram of typical off-line-switcher type power supply.

As a result of expansion in use in computers and related equipment, the power ferrite area is undergoing rapid growth, currently at 30 to 100 percent per annum, as compared with a few percent for telecommunications and 10 to 20 percent for consumer ferrites (R. Sundahl, private communication, 1984). The market for recording head ferrites is also growing rapidly, in keeping with the growth in recording systems.

The two most important material characteristics of power ferrites are saturation induction, which determines the storage capacity of the core, and power loss, which determines the efficiency of the core. Most power ferrites in use today are the MnZn ferrites because of the high value of saturation induction. Typical commercial power ferrite characteristics are given in Table 6.

In the consumer area, ferrites are used primarily in the form of deflecting yokes and flyback transformers for television receivers, as antenna rods in radio sets, and as elements in choke coils, transformers, and inductors. The cores need to have high saturation induction with high maximum permeability to frequencies near 100 kHz. The property demands are far less stringent than those for the telecommunications and power areas. Again MnZn and NiZn ferrites dominate. This area constitutes the largest use of ferrites. Table 6 lists the characteristics of typical commercial materials for such use.

Although the amount used is small, the property demands are severe in the case of recording heads. The primary reason for the severe property demands is the increasing trend toward high-density recording. Currently, there are three main types of materials for recording heads, depending on the type of recording. For general-purpose audio recording, the recording medium is γ -Fe₂O₃, with values of coercivity about 300 Oe. In this case, the head material is usually laminated nickel-iron (Permalloy), sometimes precipitation-hardened through the use of alloying elements to reduce head wear. For high-quality audio video recording, CrO₂ or cobalt impregnated γ -Fe₂O₃, with values of coercivity of about 600 Oe, is used as the recording medium. Here both Sendust (85 percent Fe, 9.6 percent Si, and 5.4 percent Al) and spinel ferrites are used as head materials. Compared with Permalloy, Sendust has a similar value of electrical resistivity, high saturation induction, and superior wear resistance. The last two characteristics make it attractive for use with high-coercivity media. Ferrites are characterized by extremely high values of electrical resistivity and wear resistance but low saturation induction. Both MnZn and NiZn ferrites are used, commonly in video and high-frequency recording where the eddy current effect is minimized by the high value of resistivity as compared with metals.

The newest head material is made of amorphous alloys, as discussed in the section on low-frequency soft magnetic materials. A useful composition for head applications is Co₇₀Fe₅Si₁₅B₁₀, where the near-zero value of magnetostriction helps to minimize stress-induced noise and degradation of permeability. Compositional modifications have resulted in high saturation induction (~13 kG) suitable for the new metal-particle medium, having very large values of coercivity 1150 to 1500 Oe. Most of the present activity in this area is in Japan.

Technical Issues

In the telecommunications area, the development of low-loss ferrites having low disaccommodation and temperature coefficient of permeability has already led to improved inductor designs. The level of understanding of mechanisms of loss and disaccommodation as well as temperature effects is adequate at present. No new technical issues are expected since the current trend toward digital transmission technology has largely eliminated the need for new inductors of this type. Likewise, high permeability materials for wide-band and pulse transformers have attained values of $\mu \sim 20,000$ commercially. Again, the relationship between material composition, processing, and permeability is reasonably well

established. Although the laboratory-attained values of $\mu \sim 40,000$ could perhaps be implemented commercially but at higher cost, such a higher permeability is actually of limited use because the effective permeability of the transformer core, which is often assembled from two parts, is greatly influenced by the air gap between the mating surfaces. To utilize materials with $\mu > 20,000$, the gap must be less than $1 \mu\text{m}$, posing a formidable challenge to provide the required flat, smooth surfaces.

In the power area, the trend in recent years is for increased operating frequencies beyond the present 100 kHz in switched-mode power supplies in an effort to achieve greater power density. This means lower core losses at the high frequencies and high excursion inductions. Some means of reducing hysteresis and eddy current losses through composition and microstructure control are known and can be used here. High power density also means material with greater saturation induction. Here only minor gains are expected because the intrinsic magnetic properties of oxide systems have been studied rather thoroughly. Of perhaps greater importance might be an interdisciplinary, systems approach to the design of the power supply, taking into account material and component characteristics, ease of processing and assembly, etc. For example, allowing for the steady-state operating temperature of the ferrite component, one might design a ferrite with a high value of saturation induction at the higher operating temperature rather than designing for room-temperature use.

Amorphous alloys have also been considered for power transformer use. In general, ferrites have the advantages of low cost and ease of molding into different sizes and shapes for optimum design and low-cost assembly, but they lack the high saturation induction of the amorphous alloys.

In the consumer area, no new technical issues are raised because the property demands generally lag behind material capabilities. Here low-cost processing is of primary consideration.

In the recording head area, the technical challenges are very great. It can be said that current magnetic recording system performance is limited by head material performance. The trend toward high recording density has led to the need for high-coercivity recording media and high operating frequency. Metallic recording particles with coercivity of 1500 Oe are now available, and design frequency is greater than 10 MHz. This combination demands head materials with high saturation induction, such as Sendust, and high electrical resistivity, such as NiZn ferrite. There is no single known material that has this combination of properties, nor is it likely in the future. Current head designers tend to use a composite approach, such as using Sendust pole pieces atop a ferrite yoke, or a metal-in-gap structure, where a Sendust film is sputtered onto the gap area of ferrite.

Another technical challenge is the so-called dead layer--a thin layer of high coercivity induced by mechanical contact with the tape. This dead layer effectively increases the head-to-medium separation and hence

reduces the efficiency of high-density recording systems. The problem is more severe with NiZn ferrite than with MnZn ferrite, even though the former has higher hardness.

Related to the dead-layer problem is wear and corrosion. Wear and corrosion of material in the gap area again increases the head-to-medium separation. Furthermore, in composite structures, wear of the thin pole tip material obviously limits the head life. Here again there appears to be no direct relationship between mechanical hardness and wear. Table 7 shows, for example, that the new amorphous alloys have twice the hardness of Sendust, yet the head wearing rate is three to four times faster. Other studies have shown that in single crystals the wearing rate is highly dependent on crystallographic orientation. Presumably, there are complex interactions involving friction, elastic and plastic deformation, fracture, and corrosion.

Current Research and Development

There is little R&D going on at present in the telecommunications and consumer areas. For power applications, effort is concentrated on incremental increases in saturation induction and Curie temperature in the MnZn ferrite system to permit optimization at elevated temperatures. Mechanisms of magnetic loss and stability of permeability with temperature and time are being examined, particularly at high frequencies. The projected large growth in this area is expected to result in continued materials R&D in the years ahead.

Likewise, the continued growth in magnetic recording has led to intense efforts in improving the recording head materials. Within the ferrite family, several processing techniques have been applied to improve the wear properties. Some ferrites are hot-pressed, that is, sintered under uniaxial compression, to improve the density, and hence, wear resistance. The hot-pressing may be combined with platelet-shaped particles of the optimum crystallographic orientation so that the resultant ferrite head is oriented for optimum wear resistance. Still other attempts make use of single crystals with the optimum orientation. Another intense effort takes on an integrated design approach, using composite structures to optimize the properties of various materials in the head region. The metal-in-gap structure mentioned previously is one such approach. In another approach, the eddy current losses of high-induction alloys, such as Sendust, are minimized by the use of multilayer films of insulating layers sandwiching the magnetic layers. Most of this work, however, appears to go on in Japan rather than in the United States.

As already mentioned, materials other than ferrites are being examined, including the amorphous alloys.

Finally, thin-film inductive heads, prepared by depositing copper film conductor coils around 78Ni-22Fe Permalloy film yokes, show promise in multiple-track head designs having narrow (25 μm) gaps, particularly in combination with thin-film continuous medium recording. At the moment, several problems need to be overcome. First, the reproduction

TABLE 7 Recording Head Materials

	<u>Permalloy Film</u>	<u>Permalloy Bulk</u>	<u>Sendust</u>	<u>Ferrite</u>	<u>Ferrite</u>	<u>Metallic Glass</u>
Material	78Ni, 22Fe	4Mo, 79Ni, 17Fe	85Fe, 10Si, 5Al	MnZn	NiZn	Co ₇₀ Fe ₅ Si ₁₅ B ₁₀
Saturation induction, T	1.00	0.83	1.05	0.50	0.33	0.67
Initial perme- ability at 1 kHz	5,000	10,000	10,000	5,000	3,000	10,000
Resistivity, Ω-cm	20 x 10 ⁻⁶	55 x 10 ⁻⁶	80 x 10 ⁻⁶	5	10 ⁵	134 x 10 ⁻⁶
Vickers hardness	130	500	650	700	900	1200
Wear rate (sapphire rate = 1)	-	-	~60 - 100	10	-	200 - 400

SOURCE: F. Jeffers, private communication, 1984.

yield must be improved. Second, although the cost of preparing the magnetic component of the head is reduced, the cost of packaging and testing remains high. Third, thin-film heads are easily saturated magnetically and are therefore unsuitable for use with the new high-coercivity particulate recording media.

Opportunities

For power ferrites, research opportunities include the following:

- Increase the saturation magnetization and Curie temperature and lower the core losses of MnZn ferrites.
- Improve the understanding of core loss mechanisms at high frequencies in the 200 kHz to 1 MHz range.

For head materials, the major challenges are these:

- Increase the saturation magnetization and electrical resistivity of MnZn ferrites.
- Understand the mechanisms of wear, corrosion, and dead layer formation, i.e., the tribological behavior of ferrite surfaces.
- Understand the mechanisms of wear and corrosion in amorphous alloys.
- Understand the relationships among processing, structure, and properties of thin-film head materials.

Some potential new applications for high-frequency ferrites include deflection yokes and flyback transformers for high-resolution cathode-ray tubes and electronic ballast for fluorescent lamps. The requirements are expected to be more stringent than current consumer ferrites but could possibly be met with the power ferrites. The ideal high-frequency materials, combining high saturation induction and electrical resistivity, is unlikely to be realized in bulk form prepared by conventional techniques. However, artificial layer structures, such as those prepared by molecular beam epitaxy techniques, and nonequilibrium structures, such as those produced by rapid quenching from the melt, or ion implantation, could result in new materials with unusual properties. Likewise, an improved understanding of the mechanism of wear, corrosion, and dead-layer formation should lead to materials having better properties than those currently available. Thus there is ample opportunity for tribological studies here.

MICROWAVE FREQUENCIES

Microwave ferrite materials are metal oxide insulators with nonequivalent exchange-coupled magnetic sublattices. They constitute a low-loss passive medium allowing electromagnetic energy to propagate with little attenuation and come in contact with a spatial magnetic continuum. Application of an external dc magnetic field causes

interaction between the microwave signal and the continuum to take place, giving rise to controlled device action. This effect can be nonreciprocal, thus violating the reciprocity theorem for passive circuit elements.

Catalogs of microwave ferrite manufacturers contain about 100 ferrimagnetic compositions available for device production. All are produced as dense polycrystalline ceramics. Yttrium iron garnet (YIG) is also produced in single-crystal form for use in a variety of filters and YIG tuned oscillators. Major chemical systems now in use are nickel ferrites, magnesium ferrites, lithium ferrites (all of spinel-cubic structure), and yttrium iron garnets (garnet-cubic structure).

The theoretical work giving rise to the present utilization of ferrites in microwave devices began in 1935 with the Landau and Lifshitz treatment of the theory of gyromagnetic resonance. Neel developed a theory of uncompensated antiferromagnetism that he called ferrimagnetism in 1948. Tellegen developed network theorems incorporating nonreciprocal elements, one of which he called a gyrator. Beljers, Polder, and Beljers-Snoek described and demonstrated the gyromagnetic nature of ferrites at microwave frequencies. In the Beljers-Snoek paper there was the suggestion that the gyromagnetic effect could be used for the construction of a Tellegen gyrator.

In 1952 Hogan demonstrated the use of a ferrite in a practical gyrator. The work of Hogan set in motion intensive worldwide research and development investments by government, industrial, and university laboratories. Ferrite nonreciprocal components have now become essential in microwave circuitry. The classic material discovery and development work resulting in the major ferrite systems available today was that of Snoek at Philips--spinel-type ferrites; Stuijts and co-workers, also of Philips--hexagonal-type ferrites; and Bertaut and Forrat in France and Geller and Gilleo at Bell Labs--garnet-type ferrites. References to this earlier work may be found in the reviews by Nicolas (1980) and Dionne (1975).

Applications

The development of the microwave ferrite material market is driven by electronic system use of microwave ferrite components. The current major component market segments are telecommunications, radar, electronic warfare (EW) systems, and instrumentation.

Microwave ferrite components have been classified according to the type of magnetic biasing field employed and to the gyromagnetic effect being exploited. Grouping them by function yields isolators, circulators, phase shifters, switches, filters, and tuned oscillators. The first four functions utilize polycrystalline (ceramic) ferrite, while the latter two functions usually employ single-crystal (YIG) materials.

The range of ferrite technical characteristics presently available to the component designer and the major methods used to synthesize ferrite technical characteristics to meet specific component requirements are given in Tables 8 and 9, respectively.

TABLE 8 Ferrite Characteristics Relevant for Device Design

<u>Symbol</u>	<u>Property</u>	<u>Range</u>
$4\pi M_s$	Saturation magnetization	150 - 5000 (Gauss)
T_c	Curie temperature	100 - 640 ($^{\circ}\text{C}$)
ΔH	Resonance linewidth	10 - 1000 (Oe)
ΔH_k	Spinwave linewidth	1 - 20 (Oe)
ϵ'	Dielectric Constant	12 - 18
$\tan \delta_{\epsilon}$	Dielectric loss tangent	.0001 - .002
μ'	Scalar permeability	Approaching Unity
$\tan \delta_{\mu}$	Magnetic loss tangent	.0001 - 1
B_r	Remanent flux density	50 - 4000 (Gauss)
H_c	Coercive force	0.2 - 3 (Oe)
γ_{eff}	Gyromagnetic ratio	App. 2.8 (MHz/Oe)

TABLE 9 Summary of Major Methods of Controlling Ferrite Properties

<u>Technical Characteristic</u>	<u>Major Methods of Control</u>
<ul style="list-style-type: none"> • Saturation magnetization, $4\pi M_s$ Select on basis of device operating frequency 	(1) Add Al^{3+} to decrease $4\pi M_s$ (G,S)* (2) Add Zn^{2+} to increase $4\pi M_s$ (S)
<ul style="list-style-type: none"> • Nonlinear threshold H_{CRIT} Select on basis of peak power devices must handle 	(1) Add Ho^{3+} , Dy^{3+} to increase H_{CRIT} (G) (2) Add Co^{2+} to increase H_{CRIT} (S) (3) Decrease $4\pi M_s$ to increase H_{CRIT} (G,S)
<ul style="list-style-type: none"> • Magnetostriction, λ Minimize for optimum latching phaser operation 	(1) Add Mn^{3+} to decrease λ (G,S)
<ul style="list-style-type: none"> • Temperature variation of $4\pi M_s$ Select on basis of device temperature specification 	(1) Adjust $\text{Gd}^{3+}/\text{Al}^{3+}$ ratio to minimize (G) (2) Select chemical system with higher Curie temperature (S)

* G = garnet, S = spinel

The U.S. market (Montgomery, 1983; Rodrigue, personal communication, 1984) is estimated to constitute about 75 percent of the free-world market of both materials and components. Three-fourths of the remaining 25 percent is in Japan and one-fourth in Europe.

The domestic microwave ferrite material market is estimated to be approximately \$19 million in 1984, with a growth rate of about 10 to 15 percent annually. In the United States there are seven manufacturers that produce ceramic microwave ferrites in significant quantities. Four sell on the open market and three are primarily used to meet the needs of captive markets for in-house devices. The various suppliers tend to have distinct localized capability and to specialize in particular products, although all carry a catalog of other materials. As ferrite users have freely commented, there has been little or no change in the catalog of available materials in the last 5 to 15 years.

Traditional microwave ferrite devices make up a 1984 domestic market variously estimated at \$170 to \$230 million. This market is divided among some 2 dozen companies or divisions of large corporations. A market growth in the range of 10 to 15 percent is generally foreseen over the next 5 years. Circulators and isolators account for 40 to 45 percent of the whole, and YIG tuned devices about 40 percent. Phase shifters and switches constitute the remaining 15 to 20 percent. Phase shifters are seen as the most rapidly growing area because of military phased array systems as well as space-borne arrays.

The military accounts for ≈ 85 percent of the total market, with the remainder divided between commercial communications (≈ 10 percent) and instrumentation (≈ 5 percent). In military applications, electronic warfare is the largest segment (≈ 55 percent), radar represents ≈ 40 percent, and communications and instrumentation ≈ 5 percent. YIG tuned filters and oscillators are heavily oriented toward EW applications, although a significant instrumentation market also exists.

It is notable that most of the basic crystal structures of ferrites were first explored in Europe. Device development, on the other hand, was spearheaded in the United States. Rodrigue's survey respondents commented on an apparent recent growth in overseas papers at the principle magnetic conferences and in technical journals, but few saw any perceptible erosion of the U.S. competitive position in the microwave ferrite materials area. In the materials area, overseas competition arises primarily in France (Thomson CSF), Italy (Selenia), Japan (Hitachi, TDK), and the United Kingdom (Marconi).

In the device area, those same nations and companies are seen as competitive. Survey respondents were about evenly split, with about half feeling that overseas competition was growing in strength, principally in areas of low-cost, high-volume markets like direct satellite broadcasting and cellular radios.

Electronic circulators (containing 24 components) have been synthesized for 30-MHz operations. No microwave active circulators have yet been developed. Microwave balanced MESFET amplifiers have been

constructed and the ferrite isolator eliminated, but penetration of the ferrite isolator market by active matching networks has been very small to date. Diode phase shifters compete with ferrites below ≈ 5 GHz. At high frequencies, the attainable figure of merit tends to favor the ferrite phaser. Market segments reflect system specification.

The passive stable nature of ferrites and their extremely high resistance to EMP and nuclear radiation damage make them the circuit element of choice in a number of applications.

Technical Issues

Until recently, the universe of commercially available ferrite materials has proved adequate in meeting microwave ferrite component specifications. At present there is a growing awareness of the limitations of microwave ferrite materials as a result of the renaissance in millimeter-wave (40 GHz and higher) system development. Ferrite property limitations have been spotlighted when trying to scale existing microwave ferrite components to millimeter-wave frequencies.

Microwave ferrite limitations can be grouped under two general headings: (a) microstructural imperfections and technical characteristic variations within a ferrite element that cause deterioration in device action at short wavelengths and (b) inadequacy of the range of ferrite technical characteristics required to obtain optimum device action at millimeter-wave frequencies.

Present ceramic processes used to fabricate polycrystalline microwave ferrite elements (acceptable at microwave frequencies) exhibit microstructural pores, inclusions, and grain boundary imperfections that can range to 20 or 40 μm in size. At device operating frequencies approaching 100 GHz, one-quarter wavelength within the ferrite is ≈ 200 μm . To avoid interaction with the propagating electromagnetic wave and subsequent scattering, reflection, and absorption of energy, imperfections less than 2 or 4 μm in size are highly desirable. Chemical heterogeneities and gradations within a ferrite element can also cause technical characteristic variations of ≈ 1 percent, while batch-to-batch variations in technical characteristics range up to ≈ 10 percent. Bulk-grown single crystals of multicomponent metal oxide microwave ferrites can exhibit even greater chemical heterogeneities than polycrystalline materials.

Further exacerbating the microstructural imperfection problem is the small physical size of millimeter-wave ferrite elements, which in certain dimensions can be 125 μm or less. Fabrication yields can be very low because of structural failure. In addition, ferrite elements must be machined to precise dimensional tolerances. This surface finishing gives rise to defects such as crystal pullouts and stress-induced magnetic variations.

Reduction of the ferrite dielectric constant (ϵ' is typically 12 to 18) would help relax the microstructural size (imperfections could be larger) and ferrite element physical size (dimensions could be larger) requirements for millimeter-wave application. At these frequencies, the

magnitude of ϵ' is composed of the electronic (α_e) and ionic (α_i) polarizabilities that originate from the anion and cation crystal chemistry. This chemistry is optimized to the magnetic specifications, and the dielectric constant is not independently variable. A more direct approach is to use existing sophisticated polycrystalline and single-crystal processing methods developed for nonmagnetic metal oxide synthesis to improve millimeter-wave ferrite element homogeneity.

The dc magnetic field (H_i) required to internally bias a ferrite element to resonance is proportional to the operating frequency (ω), $\omega = \gamma_{\text{eff}} H_i$. At 100 GHz, biasing fields greater than 30 kG are required. Even with the unlikely attainment of magnetizations of 20 kG, the high field requirement is not lifted. An optimized demagnetizing factor is of slight help. Only materials with large uniaxial magnetocrystalline anisotropies offer a practical solution.

Barium hexaferrite, a well-characterized magnetoplumbite-structure hexagonal ferrite, has an anisotropy field of 17 kG and exhibits a natural resonance at ≈ 50 GHz. Substitution of Al^{3+} , Co^{2+} , Ti^{4+} , and Zn^{2+} ions can be used to vary the resonant frequency from at least 40 GHz to 130 GHz. Isolators of this type are capable of high power and should see a growing requirement for the protection of millimeter-wave generators.

The majority of ferrite devices in use today do not operate at resonance. The isolator function is generally obtained by designing a three-part circulator and terminating one port in matched load. For both circulators and phase shifters, a useful criteria for optimum millimeter-wave device performance is the magnitude of the frequency-normalized magnetization, $\gamma_{\text{eff}} \cdot 4\pi M_s / \omega$. Values of ≈ 0.5 to ≈ 0.8 are generally desirable for optimum phase shifter and circulator performance. At higher values, magnetic loss increases; at lower values, device action is reduced. With $\gamma_{\text{eff}} = 2.8$ MHz/Oe, we can see the desirability of magnetization values approaching 20 kG at higher millimeter-wave frequencies. The benefit of independent control of γ_{eff} is also apparent. Large values (>10) of γ_{eff} can be obtained in several spinels near the compensation points, but the reduced magnetization yields a small $\gamma_{\text{eff}} \cdot 4\pi M_s$ product. Unfortunately, the probability of discovering in the near term, magnetic metal oxide insulators with desirable properties appears very low.

In the near term, spinel cubic ferrites with $4\pi M_s$ of ≈ 5.5 kG appears to be the upper magnetization limit available for millimeter-wave device design. Analysis by Vittoria (1979) of uniaxial hexagonal ferrites suggests that the elements of the Polder permeability tensor can be increased by the anisotropy field to improve device action at millimeter-wave frequencies. Planar hexagonal ferrite materials would be required for switchable circulators or nonreciprocal phase shifters. Research and development of the uniaxial and planar hexagonal ferrites based on in-depth analysis of their device action advantages would seem timely.

The dielectric loss of ferrites contributes to device insertion loss, increasing at least proportionately with increasing frequency. Investigations aimed toward reduction of dielectric loss would be useful in improving millimeter-wave device performance of any ferrite composition selected as a candidate for millimeter-wave optimization.

Lithium zinc ferrite is a potentially interesting candidate. It exhibits $4\pi M_s \approx 5.5$ kG and low magnetic loss. With decreased dielectric loss ($\tan \delta < .0002$) and improved microstructure or prepared in single-crystal form, it may prove useful in certain millimeter-wave applications.

Ferrites are generally employed in a low loss mode. They can, however, be used to absorb unwanted electromagnetic radiation (Naito, 1973). The ideal ferrite absorber would allow the incident electromagnetic wave to enter without reflection and then rapidly attenuate the wave to a negligible amplitude in a short distance. This requires that the material have a characteristic impedance of unity, i.e., $Z_0 = (\bar{\mu}/\bar{\epsilon})^{1/2} = 1$, where $\bar{\mu}$ is the complex magnetic permeability and $\bar{\epsilon}$ is the complex permittivity. The real and imaginary parts of $\bar{\mu}$ and $\bar{\epsilon}$ should be large to reduce thickness and achieve high absorption.

Because of the present lack of ferrites with large magnetic permeability at microwave frequencies, it appears that ferrite materials in combination with other components offer the most practical approach to obtain useful physical embodiments (Hatakeyama and Inui, 1984). A number of articles have recently been published in the literature on this subject, and research and development concerned with absorbing materials is gaining momentum internationally.

Current Research and Development

The development of the U.S. microwave ferrite industry was primarily supported by Department of Defense funding. Research and development groups were established in industrial, university, and government laboratories. The success of that funding effort has made the United States the major world producer of microwave ferrites. Lack of direct funding for microwave ferrite research and development during the past decade is possibly justified by the lack of user demand for new materials.

Current research on millimeter-wave materials appears to be gathering momentum internationally. Characterization of hexagonal materials by workers at the University of Bochum in West Germany was recently published. Four papers directed toward millimeter-wave applications were presented at the InterMag '84 Conference in Hamburg--one on device action and three on preparation and characterization of hexagonal ferrites. The authors were from Italy, France, Germany and China.

The small volume of millimeter-wave ferrite materials that are today required for millimeter-wave component design and production does not provide ferrite manufacturers with the economic incentive to invest the necessary research funds required to develop and commercialize millimeter-wave ferrite elements. However, the research and development assets in

place in industry, government, and university laboratories should minimize the difficulty in initiating government-funded research and development on millimeter-wave ferrites.

Opportunities

A number of millimeter-wave ferrite devices exhibiting useful technical properties have been synthesized employing both spinel-type and hexagonal-type materials. A survey of this development work was made by Vittoria (1979). He predicted the expanding need for millimeter-wave ferrites, particularly of the hexagonal type.

Current millimeter-wave system requirements call for ferrite material with improved microstructure. These include both spinel and hexagonal ferrites. In polycrystalline form the hexagonal ferrites must be oriented to take advantage of their uniaxial or planar anisotropy. The synthesis of thick (100 μm) films of these ferrites is also needed. The increase in dielectric attenuation loss with higher frequency calls for studies to decrease the dielectric loss.

The advancements made in the fabrication and control of nonmagnetic metal oxides during the last decade should be taken advantage of in order to improve the homogeneity of millimeter-wave ferrites. These include such processing techniques as electron beam deposition, RF sputtering, chemical vapor deposition, tape casting, arc plasma spraying, hot isostatic pressing, microwave calcining and sintering, liquid phase epitaxy, and sol gel processing.

The short-term probability of developing millimeter-wave ferrites with magnetization greater than ~ 6 kG is very low. Effective field theories have been developed that describe metal oxide insulators having magnetic sublattices coupled additively by positive super exchange. Whether physical realization of these materials can be obtained is open to question. The recent discovery of metastable compounds having unique characteristics unobservable in similar compounds produced by thermal equilibrium processes offers some hope that ion implantation and molecular beam epitaxy processes applied to magnetic metal oxide compositions may yield improved technical properties for millimeter-wave use.

REFERENCES

- Dionne, G. F. 1975. A Review of Ferrites for Microwave Applications. Proc. IEEE 63, 777-789.
- Hatakeyama, K., and T. Inui. 1984. Electromagnetic Wave Absorber Using Ferrite Absorbing Material Dispensed With Short Metal Fibers. Digest of Int. Mag. Conf., IEEE Cat. No. 84 CH1918-2, p. 491.
- Kato, Y., and T. Takei. 1933. Denki Grakki Zasshi 53:408-412.
- Montgomery, J. D. 1983. Microwave Ferrite Component Demand Forecast. Microwave Jour., March.

Naito, Y. 1973. Microwave Absorbing Wall Element. U.S. Patent No. 3,720,951.

Nicolas, J. 1980. Microwave Ferrites. Chap. 4 in Ferromagnetic Materials, Vol. 2, E. P. Wohlfarth, ed. Amsterdam: North Holland.

Snoek, J. L. 1936. Physica 3:463-483.

Vittoria, C. 1979. Feasibility Study of Ferrite Use at MM Waves. Naval Research Laboratory Report No. 3919, Jan. 26.

Chapter 5

STORAGE MEDIA

PARTICULATE COATINGS AND THIN FILMS

Magnetic recording involves encoding information into time-varying electrical signals, using the electric signals to drive a magnetic recording head, and thus creating a spatially varying pattern of magnetization on a moving storage medium. The reading process uses another (or the same) head to reconvert the pattern of magnetization into time-varying electrical signals.

The magnetic storage medium provides a reversible means of storing audio, video, and data signals and actually belongs to the class of permanent magnet materials. The signals may be encoded in either analog or digital form. Information is stored along tracks created in the storage medium by the relative motion between the medium and the recording head. The medium is usually continuous and featureless before writing; that is, the track is created by the process of writing.

Magnetic recording media are made in the form of tapes, disks (both on rigid and flexible substrates), and cards or stripes. Three methods of laying down the tracks are used on tapes:

With longitudinal recorders, single or multiple parallel tracks run parallel to the long dimension of the tape. Longitudinal recording is used for recording analog audio signals, analog instrumentation data, and digital data. The tape widths may range from 0.0625 in. to 2.7 in., but the most common widths are 0.15 in. (audio cassettes) and 0.5 in. (computer tape).

With transverse recorders, multiple tracks are written with a head rotating about an axis that is almost parallel to the long dimension of the tape. Transverse recording was widely used in professional video recording (Ampex, "Quadruplex") and less widely to store digital data (Ampex, "Terabit" memory). The tape was commonly 2 in. wide. Usually four heads were mounted on the head wheel. The machine was expensive and head life was limited to about 400 hours.

With helical recorders, multiple tracks are written with a head rotating about an axis that is at an angle of 70 to 85 degrees to the long axis of the tape. Helical recording is used in almost all modern video recorders and also in the IBM Mass Storage System. Tape widths range from 8 mm (0.315 in.) to 2.7 in. but by far the most popular width is the 0.5 in. used on the Betamax and VHS video cassette recorders. One or two heads are used on the head wheel, and their life is around 200 hours. Helical machines are much cheaper than transverse recording machines and can achieve higher track densities more cheaply than is possible with longitudinal recorders.

On disc recorders, two methods of laying down tracks are used. By far the most common arrangement is to write the tracks as concentric circles on the rotating disk with a head that is stationary while writing but is moved in steps along a radius or an arc to write other tracks. A less common arrangement, used in low-cost data disks, is to write a single spiral track by means of a head that moves continuously along a radius or an arc.

There are two modes of recording. In longitudinal recording the direction of magnetization is parallel to the plane of the recording medium; in perpendicular recording, the magnetization is normal to the plane. There are also two distinct kinds of recording media: particulate, in which the magnetic ingredient consists of submicroscopic, single-domain particles of oxides or metals immersed in a polymeric binder that serves to separate the particles from one another and bind them to the substrate, and thin films of ferromagnetic metals and alloys. The four combinations of modes and media are being used or are being developed for use in recording machines. Examples are shown in Table 10. Recent reviews of recording media include Bate (1980) and Corradi (1978).

TABLE 10 Classifications of Recording Media

<u>Type</u>	<u>Longitudinal Mode</u>	<u>Perpendicular Mode</u>
Particulate	Iron oxides	Barium ferrite
	Iron cobalt oxides	Strontium ferrite
	Chromium dioxide	Iron oxide
	Iron	
Thin film	Plated Co-P, Co-Ni-P, Co-Ni-Mn-Re-P	Plated Co, Co-Fe
	Evaporated iron, iron-cobalt	Sputtered Co-Cr
	Sputtered	

The advantages of particulate media are as follows:

- Since the magnetic properties of the coating are determined almost entirely by the magnetic properties of the particles, they are predictable.
- The mechanical properties of the coating are largely determined by the binder, and consequently in particulate media it is possible to tailor the magnetic and the mechanical properties of the coating independently.
- High coating speeds and wide rolls can be used.
- Uniform properties within a roll and from roll to roll are possible.
- Materials and processes are well understood, and thus yields are high and coating costs are low.

The advantages of thin-film media are these:

- It is easy to make coatings thinner than 0.25 μm . A thinner coating helps to achieve higher recording densities, particularly on disks, where there is no erase head and the single head must be a compromise between the requirements of writing and reading. Thin coatings also allow a greater length of tape to be packed into a reel of given diameter.
- The saturation magnetization is high because the magnetic constituent is not diluted by a binder.
- The coercivity and other magnetic properties are continuously variable, within limits, by changing the deposition conditions, and thus fine tuning of the magnetic properties is possible.

The substrates used in tapes, flexible disks, and magnetic cards are almost always of polyethylene terephthalate. The substrates used in rigid disks are presently made of an alloy of aluminum and magnesium, but other materials such as glass and titanium have been proposed.

Particulate Media

After various proposals in the 19th century, Valdemar Poulsen invented and built the first practical wire recording machine in 1898. Wire recorders were in use until the 1940s. In the later years, stainless steel wire (12 percent Ni, 12 percent Cr) was used. By drawing and annealing at 500°C, an oriented array of magnetic ferrite particles in a nonmagnetic austenite matrix was formed. The two principal problems were the difficulty in making a noiseless splice to repair broken wires and the propensity of the wire to twist.

Both of these problems were overcome by the development of tapes coated with magnetic particles in a polymeric binder. Paper substrates were used at first, then acetate, and more recently, polyethylene terephthalate.

Iron Oxide

Particles of $\gamma\text{-Fe}_2\text{O}_3$ were developed in 1934 and used in tapes by BASF in Germany. The particles were acicular, with a length-to-width ratio of about 5:1 and a length (less than $1\ \mu\text{m}$) that suggested single-domain behavior, and had coercivity greater than 200 Oe. They gave superior recording performance to that of earlier tapes made of natural magnetite (Fe_3O_4) with a coercivity of less than 100 Oe. Although $\gamma\text{-Fe}_2\text{O}_3$ is still the most widely used magnetic recording material, considerable refinements have been made over the past 50 years, with the greatest improvements occurring in the last 10 years. The standard method of preparation involves the following steps:



The saturation magnetization of $\gamma\text{-Fe}_2\text{O}_3$ in particle form is 74 emu/g. The Curie temperature is 590°C , but this is academic, since $\gamma\text{-Fe}_2\text{O}_3$ reverts to $\alpha\text{-Fe}_2\text{O}_3$ at temperatures above 250°C . Magnetocrystalline anisotropy accounts for about one-third of the coercivity of typical particles of $\gamma\text{-Fe}_2\text{O}_3$ used for recording purposes; the remaining two-thirds is due to shape anisotropy. The change in coercivity with temperature is about $0.2\ \text{Oe}/^\circ\text{C}$.

Variations on and improvements to the process arise from the need to:

- Improve the uniformity of particle shape and size (and hence narrow the distribution of fields at which the particles switch);
- Eliminate agglomerates and improve the dispersability of the particles; and
- Increase the coercivity of the particles.

Variations have included using FeCl_2 to precipitate $\gamma\text{-}(\text{FeO})\text{OH}$ instead of $\alpha\text{-}(\text{FeO})\text{OH}$ and using growth control agents to form $\alpha\text{-Fe}_2\text{O}_3$ particles directly from ferrous sulphate.

Cobalt-Modified Iron Oxides

Increasingly, however, modern applications call for higher values of coercivity than can be obtained from pure iron oxides. As the wavelength or the bit length of the recorded signals becomes shorter, demagnetizing fields become larger and must be resisted by higher coercivities. Early attempts to increase the coercivity of $\gamma\text{-Fe}_2\text{O}_3$ particles by incorporating 2 to 3 percent Co in the lattice resulted in particles

having desirably high coercivities (600 to 800 Oe) but undesirable high sensitivity of the coercivity to changes in temperature. A solution to this problem found by TDK (Japan) in 1974 consisted of impregnating only the surface of iron oxide particles with cobalt. Particles made by this method having coercivities in the range of 550 to 750 Oe are now widely used in high-performance audio and video tapes and also in high-capacity flexible disks.

Isotropic Particles

In equiaxed single-domain particles the dominant anisotropy is magnetocrystalline and the number of equivalent easy directions depends on whether the easy axes are $\langle 100 \rangle$, $\langle 111 \rangle$ or $\langle 110 \rangle$. The advantage of using equiaxed particles rather than uniaxial ones in a magnetic recording medium is that they are capable of responding to both the vertical and the longitudinal components of the field from the head. Such particles (e.g., cobalt-doped iron oxide) display excellent high-density recording performance, particularly when narrow-gapped heads (less than $0.25 \mu\text{m}$) are used. However, magnetocrystalline anisotropy is usually highly temperature-sensitive and so, therefore, is the coercivity of equiaxed particles. At room temperature, very high recording densities have been reported. Isotropic media is used to record stop-action moving pictures on tape at 80,000 flux changes per inch (fci), in the Spin Physics Motion Analysis System. This is made possible by the symbiotic effects of multiple easy axes, high coercivity, narrow-gapped head, and, perhaps most importantly, very smooth, highly loaded coatings.

Chromium Dioxide

The first successful particles having coercivity significantly higher than that of acicular particles of Fe_2O_3 were made of chromium dioxide, CrO_2 (DuPont). The compound does not occur naturally but may be made by several methods--for example, by the oxidation of Cr_2O_3 with excess CrO_3 under pressure and in the presence of water. The commercial material contains additives (commonly Sb_2O_3 and Fe_2O_3) that are used to facilitate production of the material at lower temperatures and pressures and to increase the Curie temperature above the value of 113.5°C for pure CrO_2 . The compound is ferromagnetic and has a saturation magnetization of 100 emu/g in the pure form, but this is reduced to 73 emu/g by the antimony and iron additives. Particles of CrO_2 are usually highly acicular (~20:1) and are easily aligned and difficult to randomize (for use in disk coatings). Coercivities may be obtained in the range of 450 to 650 Oe, and, since the Curie temperature is low, a substantial nonlinear decrease of coercivity with temperature occurs. However, since M_s also decreases at the same rate, the demagnetization is small.

The highly acicular particles of CrO_2 were introduced in the 1960s in the 0.5 in. computer tapes. Unfortunately, the magnetic properties of the tape had to be degraded to make the CrO_2 tapes compatible with the well-established $\gamma\text{-Fe}_2\text{O}_3$ tapes. This effectively cancelled any

margin of superiority that the CrO₂ tapes might have had. However, the new 0.5 in. tape drives recently announced by IBM are reported to use CrO₂ particles.

CrO₂ particles did find immediate acceptance in the audio field and were without competition in the high-performance cassette field until the advent of the cobalt-impregnated particles of iron oxide in the late 1970s. The particles have also been used alone (in Europe) and in combination with cobalt-impregnated iron oxide (in Japan) in 0.5 in. video tapes.

Metal Particles

Higher levels of magnetization can be obtained in particles made of the ferromagnetic elements, iron and cobalt, and their alloys than is possible with oxide particles. In particles in which the dominant anisotropy is due to shape, the coercivity is directly proportional to the magnetization and thus is also very high. Offsetting these considerable advantages are some serious disadvantages. Metal particles tend to corrode in the atmosphere and to react with binders and so must be passivated at some cost to M_s . The particles are also difficult to disperse and are much more expensive than particles of γ -Fe₂O₃. Three methods for the preparation of metal particles are employed: reduction of iron oxide particles in hydrogen, reduction in a solution of sodium borohydride, and evaporation of the metal into an argon atmosphere. Metal particles having a coercivity of 1100 Oe are used in premium audio tapes, and particles with $H_c = 1300$ to 1400 Oe are being considered for use in 8-mm video tapes. Particles of Fe₄N have been made by heating iron powder in an atmosphere of ammonia and hydrogen. The particles had a saturation magnetization value of 110 emu/g at 20°C (cf. 218 for pure Fe and 74 for γ -Fe₂O₃), a Curie temperature of 490°C, and coercivity of 670 Oe. The principal advantage of these particles is that they are much less sensitive to corrosion than are the iron particles.

Hexagonal Ferrites

Particles of barium and strontium ferrite can be synthesized in the form of small, 0.2 μ m diameter, hexagonal platelets in which the easy axis of magnetization is normal to the plane of the particle. Such particles can be used to make perpendicular-recording media. Particles of pure BaO · 6Fe₂O₃ have large particle sizes and coercivities of 2000 to 3000 Oe, which are much too high for use in recording media at present. The substitution of small amounts of Co and Ti (x between 0.6 and 0.8 in Ba Fe_{12-x}Co_xTi_xO₁₉) reduces the coercivity to usable values, below 1000 Oe, without reducing the magnetization. The saturation magnetization (50-60 emu/g) is lower than that of γ -Fe₂O₃ and the particles can be difficult to disperse, so the signal amplitudes and the signal/noise ratios leave much to be desired. However, experimental tapes and disks have shown signals at usable levels for very high densities (>100,000 fci) when narrow-gapped heads (0.25-0.5 μ m) are used.

Unlike the particles whose high magnetocrystalline anisotropy depends on cobalt, the temperature-dependence of barium ferrite particles is slightly positive.

Thin-Film Media

In addition to having a high coercivity, a high-density recording medium (in which the magnetization is in the plane of the coating) should also be thin. It is difficult to make defect-free particulate coatings thinner than about 0.25 μm and thus for at least 20 years the possibility of depositing continuous metallic films on rigid and on flexible substrates has been explored. Practical recording applications included electroplated drums in the 1960s and, more recently, vacuum-deposited tapes disks and autocatalytically plated rigid disks. Within the past 5 years a great deal of work has been devoted to study of the preparation and properties of uniaxial thin films of Co-Cr in which the direction of magnetization is perpendicular to that of the substrate, in the hope that recording densities higher than those achieved in longitudinally magnetized films might be achieved.

Electrochemical Deposition

Films of the ferromagnetic elements may be made by electroplating on metals or metallized substrates. The metallic ions in the aqueous plating solution are reduced by means of electrons from an external supply. The process can be continuous, is of low cost, and can be used to plate two metal ions simultaneously if their deposition potentials are similar. This is so for iron, cobalt, and nickel. It was found empirically that to obtain high coercivities (greater than 250 Oe), the films must contain a large proportion of cobalt (60 to 95 percent). The solution also contains a buffer to maintain pH, organic molecules forming organic-metallic complexes, and other additives (wetting agents, stress relievers, and brighteners). The deposition parameters that must be controlled to obtain films of predictable properties are bath composition, additive content (particularly hypophosphite), pH, current density, temperature, and the roughness of the substrate.

Films for recording purposes are usually of Co-Ni-P with 25 to 30 percent Ni and 2 to 3 percent P. The structure can be h.c.p. or a mixture of h.c.p. and f.c.c. Crystal structure, cobalt content, and internal stress are all involved in a complex way in determining the coercivity of the films, which may reach 1800 Oe. The values of saturation magnetization obtained are similar to those bulk alloys of the same composition.

Electroplating has been used since the 1950s to make data storage drums, predominantly for military applications. The process gives high deposition rates, and the bath conditions can be chosen so that the current density is the most important parameter.

Electroless Deposition

Films of the ferromagnetic metals, particularly cobalt and nickel, may be prepared by a deposition process in which the potential required

for the deposition of the metallic ions is provided by a reducing agent in the bath rather than by an external power supply. The newly deposited metal then catalyzes further deposition, and so the reaction proceeds autocatalytically. Stannous and palladium ions are commonly used to catalyze the reaction initially. To ensure that a balance is achieved between the metal ions and the reductant at the deposition surface, the metal ion usually exists in solution as a complex ion that dissociates at a controlled rate. Electroless films are usually of Co-P or Co-Ni-P and have compositions and magnetic properties similar to those of the electroplated films. In both cases the ratio of remanence to saturation is very high (greater than 0.9) and, unlike particulate media, the property is isotropic. The electroless process is being used commercially to make rigid disks for data storage. For example, a recently announced thin film rigid disk of 5.25 in. diameter will hold 25.52 MBytes/surface (980 tracks per inch, 14,873 fci and 22,310 bits per inch).

Although sputtering is more commonly used to prepare metal films having a perpendicular orientation, it is also possible to make perpendicular films by electroless deposition. The principal advantage of electroless plating is that the deposition rates are fast; the main disadvantage is that the chemical complexity of the plating bath makes it difficult to control.

Vacuum Deposition

Films of the ferromagnetic elements prepared by evaporation are normally continuous, highly conducting, and of low coercivity (less than 100 Oe), too low to be of interest in recording. To increase the coercivity, some way must be found to give the film a single-domain structure. In electrodeposited and electroless films of Co-Ni-P and Co-P, phosphorous-rich materials are believed to serve this purpose by isolating the crystallites. This will not work in evaporated films because of the difference in vapor pressure between the metals and phosphorous. However, if the metals are evaporated at oblique incidence, needle-shaped crystallites grow roughly along the direction of deposition and coercivities of 1000 Oe can be achieved. The saturation magnetization is close to that of the bulk material, and coercivity increases with increasing angle of deposition.

Equipment for the production of tape by evaporation has been developed that achieves deposition rates in excess of 0.4 $\mu\text{m}/\text{sec}$. Audio (voice) cassette tapes and 8-mm video tapes are produced by this method (Matasushita). Rigid disks may in the future be made by vacuum deposition. The process gives much higher deposition rates than sputtering, but evaporation at oblique incidence must be used to give high coercivity.

Sputtering

Sputtering is done in a vacuum chamber inside which are an anode, a cathode, and, between them or off to the side, the substrate on which the film is to be deposited. The chamber also contains a flowing inert gas

(usually argon) at a pressure of 10^{-1} to 10^{-3} torr. A potential difference (ac or dc) of about 1000 to 5000 V is applied between the anode and cathode under bombardment by the positive gas ions, the cathode slowly disintegrates, and its material is ejected either as free atoms or atoms combined with gas molecules, which transverse the chamber and are deposited on the substrate. The advantages of sputtering over vacuum deposition are these:

- Multicomponent alloys and compounds can be deposited controllably and reproducibly.
- Refractory materials can be deposited.
- Insulating materials can be deposited by RF sputtering.
- Adhesion of the films is good because of the high energy (10-40 eV) of deposition compared with vacuum deposition (0.1-1.0 eV).
- Reverse sputtering (sputter etching) can be used to clean the substrate.
- Epitaxial growth occurs at lower substrate temperatures.
- Targets (cathodes) can be used to give large-area films of good thickness uniformity.
- The process has good uniformity.

The principal disadvantage of sputtering is that the deposition rates are low. This can be improved by using magnetron sputtering, in which the gaseous ions are focused by means of a strong magnetic field, but specially designed (and expensive) targets are required when ferromagnetic materials are being deposited. Experimental disks for data storage are being made by using magnetron sputtering to deposit metal films both for longitudinal and perpendicular recording.

Oxide films have also been prepared by sputtering, although the usual technique is first to deposit metal (iron) and then oxidize to α - Fe_2O_3 , reduce to Fe_3O_4 , and reoxidize to γ - Fe_2O_3 . Oxide films were studied intensively in 1980 because they had recording performance similar to those of metal films without the latter's tendency to corrode. However, they were later found to exhibit a loss of signal induced by stress. Films of barium ferrite having perpendicular anisotropy have been produced by dc sputtering.

Applications

Magnetic recording is used to store video and audio information and data (in instruments, word processors, and computers). Particulate media are used today to store almost all this information. Thin films are only just beginning to take a minute fraction of this large market--so minute that any attempt to compare the two kinds of media would result in the

thin film portion being lost in the uncertainty of the actual size of market for magnetic particles. This will not always be the case, nor is it apparent from a review of the technical literature, where the emphasis is, as it should be, on the future rather than the present.

The largest market for magnetic particles until 1982 was in audio cassettes (predominantly unrecorded cassettes). Now 0.5 in. video cassettes provide the largest market, almost 50 percent higher than audio cassettes and twice as large as the combined market for data storage media (computer tape, rigid disks, flexible disks, data cassettes, and data cartridges).

Table 11 shows the consumption of particles by material in 1974, 1977, and 1984. The compound growth rate for the total amounts is 9 percent annually from 1974 to 1977 and 20 percent annually from 1977 to 1984. The table also shows the dramatic growth in the use of cobalt-impregnated iron oxide compared with pure iron oxide and shows the application distribution for each material in 1984.

TABLE 11 Consumption of Magnetic Particles by Application
(Millions of Kilograms)

Particle	1974 ^a	1977 ^a	1984 ^b	Percentage in 1984		
				Video	Audio	Data
Iron oxide	13	16	24	3	65	32
Cobalt-iron oxide	-	0.5	20	90	10	-
Chromium dioxide	1	1.5	5	81	12	7
Metal	-	-	-	-	100	-
Total	14	18	49			

a. Corradi (1978).

b. I. Lemke, private communication, 1984.

The consumption by geographic region shows that the use of particles in Japan is almost equal to the combined total for the rest of the world. This is not particularly surprising when we remember that most recording machines are designed and manufactured there. Table 12 lists the most important particle manufacturers by country and also shows the type of particle for which they are presently known. The price of particles is important but not greatly important. For example, there are about 30 mg of particles in a 5.25 in. flexible disk, while the weight of the PET substrate is about 1 g. PET costs about \$20/kg, and particles usually \$2 to \$20/kg. (Most flexible disks still use particles of $\gamma\text{-Fe}_2\text{O}_3$ for which the cost is little more than \$2/kg.)

TABLE 12 Particle Manufacturers

<u>Japan</u>	<u>United States</u>	<u>Germany</u>	<u>Italy</u>	<u>Netherlands</u>
Fuji Photo	Dupont (CrO ₂)	BASF	Montecatini-Edison (CrO ₂)	Philips-Dupont (Fe)
Kanto Denka (Fe)	Hercules (γ, Co-γ)	Bayer (iso Co-γ)	Sonorex (γ)	
Maxell (γ, Co-γ)	Spin Physics (iso Co-γ)			
Mitsubishi (Fe)	Pfizer (γ, Co-γ)			
Sakai (γ-NP, (Co-γ-NP)				
Sony (Fe)				
TDK (γ, Co-γ)				
Titan (γ)				
Toda (γ, Co-γ, Ba ferrite)				
Toshiba (Ba ferrite)				

Estimates of present market sizes are prone to errors, but predictions of future market size are often highly inaccurate. For example, four estimates of the size of the market for 5.25 in. flexible disks in 1987 were reported in December 1983. The largest estimate was 5 times the smallest. Figure 4 shows recent growth in the consumption of particles of cobalt-impregnated iron oxide and estimated growth that is likely to occur over the next 3 years. This particle is most likely to replace $\gamma\text{-Fe}_2\text{O}_3$ as the universal recording material. It is already used in audio and video tapes and in high-density flexible disks and may shortly be used in rigid disks.

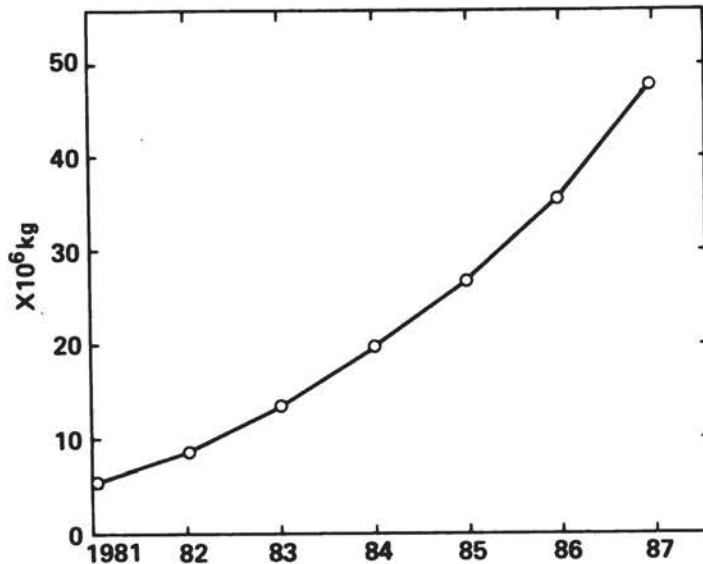

Figure 4 Consumption of magnetic particles in 1/2" video tape.
Source: Magnetic Media Information Services Report MMIS, 1983.

Technical Issues

Magnetic properties may be divided into two classes:

- Intrinsic properties, which depends only on the number and the kinds of ions present, their crystallographic arrangement, and the temperature. The intrinsic properties are

Saturation magnetization, σ_s and M_s

Curie temperature, T_c

Compensation temperature, T_{comp}

Magnetocrystalline anisotropy, K_1, K_2

Saturation magnetostriction, λ_s

- Extrinsic properties which depend on the number and kinds of ions, their structure, and the temperature but, in addition, on the size, shape and previous history of the sample. The extrinsic properties are

Remanent magnetization, σ_r and M_r

Orientation ratio, $\sigma_r / \sigma_0 M_r$

Coercivity, H_c , remanence coercivity H_r

Switching field distribution, $\Delta H / H_c$

Interaction fields

The extrinsic properties may also depend on temperature, stress, and time.

In general, the intrinsic properties of recording materials are well understood. However, the same cannot be said for the extrinsic properties. There are two broad categories of theories of the mechanism of magnetization reversal--domain-wall theories and single-domain particle theories--and the behavior of every material is fitted into one or the other theory regardless of how forced such a fit may be. The original theory of coherent magnetization reversal in fine particles was supplemented by theories of incoherent reversal by the chain of spheres, buckling, and curling modes. Low-coercivity thin films, when studied magneto-optically or by Bitter patterns, show convincing evidence of the validity of the domain-wall explanation. However, rolled foils of the same composition show superior permeability but no evidence of domain walls. High-coercivity thin films do not show domain walls but neither do they fit easily into a single-domain model. Perhaps a general theory of magnetization reversal is needed. Such a theory, to be complete, should include a description of the effects of particle, or domain, interactions in three dimensions.

We are likely to be successful in attempting to change the extrinsic properties of materials--indeed, the problem is often to prevent these properties from changing with time, temperature, and mechanical stress. Increases in the intrinsic properties M_s , T_c , K , and λ_s , are less likely to be achieved, but the effects of the changes are likely to have much greater technical significance. For example, a material of $M \sim 2000$ emu/cc combined with $T_c \sim 300$, $K_1 \sim 10$ erg/cc (and independent of temperature over the range 0 to 150°C) would offer great promise not only as a recording material but also as a permanent magnet material, particularly if it were inexpensive (less than \$1/kg).

Particulate Media

The most important problem impeding the use of very high coercivity particles in high-density disks is the absence of head materials having high values of saturation flux density ($4\pi M_s \sim 24,000$ G) combined with low coercivity (less than 1 Oe).

The most serious field problems in magnetic recording are almost always associated with nonmagnetic properties. The problems are difficult to solve mainly because a fundamental understanding is lacking of the physics and chemistry of the interaction between the particles and the binders as it affects such properties as durability, dispersion of the particles, abrasivity, friction, resistivity, and corrosion. We do not understand

- The relationship between size distribution, switching fields, and the erasure and overwrite performance of tapes and disks.
- The exact mechanism by which cobalt, impregnating the surface of iron oxide particles, enhances the coercivity almost independently of temperature.
- How the application of sodium metabisulphite to the surface of iron oxide particles can cause an increase in coercivity by a factor of 3 (the effect is not permanent and can be removed by washing the particles). Smaller changes in coercivity can occur by interaction between particles and binders.
- The properties of mixed anisotropies within a particle (e.g., uniaxial and multiaxial) or the properties of mixed assemblies of particles ($\gamma\text{-Fe}_2\text{O}_3$ and CrO_2).
- The success (and, in particular, the statistical stability) of the Preisach function in predicting the effects of particulate interactions.
- The time-dependent magnetic properties of some particles, e.g., chromium dioxide.

There are many new particles available in small samples (~100 g), but very few are available in quantities of 50 kg needed to coat long lengths.

Despite the inherent technological advantages of thin films, it is likely that particles will be steadily improved and will remain the dominant form of magnetic materials in recording applications.

Thin-Film Media

Here again, in thin-film media the most difficult problems are the nonmagnetic ones--e.g., durability, corrosion, compliance, adhesion, cohesion, uniformity, freedom from defects, reproducibility, resistivity, and transmissivity. The practical problem as with particulate coatings, is to optimize simultaneously the magnetic and the nonmagnetic properties. We do not understand

- The mechanism of magnetization reversal in thin films of high coercivity (greater than 500 Oe).
- The mechanism whereby amorphous films can develop strong, uniaxial anisotropy.

- The fundamental magnetic unit in thin films (domain? crystallite? multicrystallite?) and the interaction between them.
- How to make films with attractive magnetic properties (e.g., $M_s \sim 1700$ emu/cc, $H \sim 1000$ Oe, $M_r/M_s \sim 0.9$) that are also durable, uniform, and adhere well to a flexible substrate and can be coated inexpensively at a thickness of 0.05 to 0.5 μm at speeds of 200 m/s.
- The origin of the pressure-induced signal losses in thin oxide films.

Current Research and Development

Research on magnetic properties suitable for use in recording applications is predominantly carried out in industrial laboratories in Japan (as Table 12 would suggest).

Although it is not uncommon to find particle research in university laboratories in Japan, it is extremely rare in U.S. universities, as a survey of the proceedings of the Intermag Conference (IEEE Transactions on Magnetics) and the Conference on Magnetism and Magnetic Materials (Journal of Applied Physics) reveals. For the past decade, much of the fundamental work on magnetic particles has been done by geophysicists. Unfortunately, their work is not widely known among workers in recording materials. Perhaps the most significant research projects in magnetic particles during the past 5 years were the following:

- Knowles' work on the switching behavior of individual magnetic particles--Philips Laboratories (England).
- The development of a process for making barium ferrite particles with M_s only slightly below that of the pure material and H_c less than 1000 Oe--Toda, Toshiba Laboratories (Japan), Pfizer (United States).
- The development of a new process for making uniform, regular particles of iron oxides and cobalt-iron oxides--Sakai (Japan).
- The development of commercial processes for making iron particles of high coercivity--Philips (Netherlands), Sony (Japan), Fuji (Japan), 3M (United States).

Research activity in thin films has covered films made by electrodeposition, electroless deposition, vacuum evaporation, and sputtering, but the number of papers on Co-Cr films prepared by sputtering and having perpendicular anisotropy far exceeds the papers on any other composition or method of deposition. Many Co-Cr films have a layer of Ni-Fe beneath to provide a low-reluctance path for the flux from the magnetization stored in the Co-Cr layer (and so increase the signal level during reading). It is not clear to what extent the Ni-Fe layer is a handicap when writing is performed with a head having poles above and

below the Co-Cr, Ni-Fe films. Despite the intense laboratory activity in Co-Cr films over the past 4 years, there is at present no commercial product using these films. In contrast, films of Co-Ni-P or Co-P made by electroless deposition (and supporting longitudinal magnetization) have been manufactured for many years, first as rigid disks for television "instant replay" and at present in the form of small rigid disks for data storage. Because of the different experimental conditions used by different investigators and because complete details of their experimental conditions are frequently lacking, it has been difficult to make a direct comparison of the performance of "perpendicular" films of Co-Cr and "longitudinal" films of Co-P. A recent attempt to make such a comparison showed virtually no difference in signal amplitude and peak-shift as a function of bit-density to 100,000 bits per inch.

The existence of sawtooth boundaries between regions of opposed magnetization has been observed in longitudinally oriented films of Co-P. Such boundaries have been interpreted as providing a way of estimating the maximum recording density of these films. However, it may be that the amplitude of the "teeth" decreases as the bit density increases, thus invalidating such estimates of the maximum density.

The most significant R&D projects in high-coercivity thin films during the past 5 years were these:

- The continuing work of Iwasaki and his associates and students at Tohoku University on the properties and recording performance of perpendicularly oriented films of Co-Cr. This work stimulated an intense research effort in Japan, the United States and Europe.
- The development by Matsushita of commercial processes for making tapes by evaporating iron films at oblique incidence to make voice cassettes and 8-mm video cassettes.

Opportunities

Particulate Media

Research and development in particulate media should address the following:

- New particles having greater uniformity of shape and size and narrower switching field distributions would permit better tapes and disks to be made even with today's head materials. Particulate uniformity could be achieved either by developing new, more controllable processes for making particles or by developing commercially practical processes for classifying particles by size or, preferably, by switching field.
- Understanding of particle surface effects in general and the magnetic structure and reversal mechanisms of cobalt-impregnated particles in particular and of the interactions between particles would permit recording materials of superior performance to be produced.

- Developing new methods of making particular recording materials in which the particles are created in situ rather than being mixed with polymers and coated would lead to vastly expanded capabilities. Recall, for example, that stainless steel recording wire was made by drawing and annealing the wire so that particles of the ferritic phase are precipitated in an austenitic (nonmagnetic) matrix that acts as a combination of binder and substrate.
- We are many orders of magnitude away from the fundamental limit to recording densities in particulate media. This limit is imposed by the size of the smallest single-domain particles whose magnetic state is stable for an archival period of 30 years. We must, therefore, address the technological limits to recording densities, and these depend on the practical problems of increasing bit densities (closer head-medium spacing, higher coercivity) and track densities (stable substrates, track-following servos). The challenge is to push higher the technological limits closer and closer to the fundamental limit.

Thin-Film Media

Research and development opportunities in thin-film media include the following:

- New methods of depositing thin films (with longitudinal or perpendicular magnetization) that combine the flexibility and composition control of sputtering with the low cost of wet plating.
- New thin-film head materials having higher saturation magnetization than that of 80 Ni-20 Fe, low coercivity, corrosion resistance, and high durability. Such materials would permit thin films of higher coercivity to be used and could allow thin-film heads to work with particulate disks of coercivity greater than 300 Oe.
- Understanding the magnetic structure of thin films which may reveal their mechanism of magnetization reversal and lead to the preparation of compositions having superior properties.
- Optimizing the nonmagnetic properties (a) because of the effect that nonmagnetic properties (e.g., crysallite size and orientation, substrate) have on the magnetic properties and (b) because of their effect on the practically important properties of durability, adhesion, and corrosion resistance.
- Optimizing performance through the use of multiple-layered films: The magnetic properties of Co-Cr perpendicularly oriented films are enhanced during reading by a "keeper" layer of Ni-Fe underneath the Co-Cr. Nonmagnetic layers underneath the magnetic film are used to promote adhesion between the

magnetic layer and the substrate or to prevent electrolytic corrosion with metal substrate. Overcoats are used to provide lubrication or to prevent surface corrosion or abrasion. The challenge here is to discover an overcoat layer that is thick enough to protect the magnetic film but not so thick that the recording performance is impaired.

- Films having $M_r/M_s > 0.9$ not just in the plane of the film (as in Co-P and Co-Ni-P films) but in three dimensions. This would permit the magnetization in the film to follow more faithfully the head field lines.

MAGNETO-OPTIC MATERIALS

In magneto-optic recording, data are written thermomagnetically into moving media (disks or tapes). A laser beam modulated by an electrical signal is focused on the layer. The irradiation by the beam raises the temperature locally and changes the magnetic properties (saturation magnetization M_s , coercive force H_c , or anisotropy K_u) of the heated region. As a result, the direction of the magnetization can be changed by a weak external field. After the beam is removed and the temperature of the reversed domain returns to room temperature, the recorded pattern (recorded bits) are maintained. The recorded bits can be erased by irradiating with a laser beam and applying a bias field in the opposite direction.

For read-out, magneto-optic effects are used. In transmission, a polarized laser beam--with reduced intensity--is passed through the film, and the polarization is rotated due to the Faraday effect in a sense that depends on the direction of the magnetization of the film. The state of polarization is detected by means of an analyzer and photodetector. For read-out in reflection, the polar magneto-optic Kerr effect is used.

Materials suitable for magneto-optic storage must show a magnetization perpendicular to the film plane, strong thermomagnetic effects in the region of 100 to 200°C, and large magneto-optic effects.

The first magneto-optic materials operating at room temperature were MnBi films with large magneto-optic effects. Curie point writing was used. However, the Curie point is very high (360°C), so high laser power is needed--and the Curie temperature is near the decomposition temperature. MnCuBi films developed to overcome these drawbacks have $T_c \sim 160^\circ\text{C}$. Since films of MnBi or MnCuBi are polycrystalline, grain noise appears and degrades the signal-to-noise ratio of the read-out signal.

In 1973, thin films of amorphous rare earth-transition metal alloys (RE-TM) such as GdCo and GdFe were suggested for magneto-optical storage. GdCo or GdFe have rather high magneto-optic effects, low Curie temperature, and perpendicular magnetization. However, because H_c versus composition near T_{comp} is so steep, it is difficult to control the composition to obtain a reproducible and high H_c necessary to

achieve small domains. In TbFe or DyFe, domains as small as 1 μm in diameter have been obtained, but magneto-optic effects are too small (Kerr rotation $\theta_k \sim 0.15^\circ$).

In the past several years, ternary RE-TM alloys like GdTbFe and TbDyFe have been developed with good write sensitivity ($T_c \sim 130\text{-}200^\circ\text{C}$), high coercive force, and fairly good magneto-optic effects. In order to increase read-out efficiency, multilayer coatings to enhance the magneto-optic Kerr rotation have been developed. These coatings also prevent aging effects to a certain degree.

Applications and Market

Magneto-optic recording promises to combine the advantages of magnetic and optical recording:

- Virtually unlimited erasability ($>10^7$ write-erase cycles).
- High bit density--up to 50 Kbit/in., 15 Ktrack/in., 750 Mbit/in.² (~ 120 Mbit/cm²).
- No contact between write/read head and storage layer.
- Overcoats or sandwich construction to protect the storage layer from dust, fingerprints, chemical contamination.
- High-efficiency tracking techniques to maintain the write/read head within 0.1 μm in track by using pregrooved media.
- The tracking technique and protection of the storage layer allow exchangeable storage media.

Several applications are proposed:

- Digital erasable optical disks for storage ranging from 1 GByte on 12 in. disks for mainframes to 100 MBytes on 3-1/2 in. disks for microcomputers or even 2 in. disks with at least 10 MByte storage capacity.
- Erasable video disk for consumer application.
- Erasable video disk for editing purposes in TV stations.
- Erasable digital audio disk.
- Magneto-optic record for electronic picture cameras.

Projections (Verbatim, 1984) on the development of the optical data storage industry indicate a potential worldwide annual revenue market of \$400 million in 1990 for the sale of magneto-optic disks out of a worldwide optical read-only disk market of close to \$1 billion. In addition, magneto-optic drive revenues are expected to amount to close to

\$1 billion in 1990 out of total optical drive industry revenues of \$2.3 billion. By 1995, the worldwide magneto-optic disk revenue market is likely to be almost \$5.1 billion, and the magneto-optic drive revenue market close to \$6.2 billion. This compares respectively to total optical disk industry revenues of \$10.5 billion and total optical drive industry revenues of \$11.5 billion. Magneto-optics is seen as having the highest growth rate potential among the various types of optical technologies, with likely growth rates in excess of 60 percent per year throughout the 1990s.

Technical Issues

The feasibility of magneto-optic recording is undisputed. However, to develop successful products, several problems still have to be solved:

- Magneto-optic thin films are produced by evaporation or sputtering techniques. An improved process control is needed for high homogeneity and reproducibility of the films, which are very sensitive to changes in composition.
- The ideal substrate has not yet been found. Injection-molded Polymethylmethacrylate (PMMA) substrates are not stable; humidity diffuses through the substrate and causes corrosion problems in the storage film. Polycarbonate substrates are expensive, and their rather high birefringence causes problems with read-out. Today, glass substrates with pregrooved PMMA layer on top are used, but these are also too expensive.
- Stability and lifetime problems due to corrosion of the thin (200-800 Å) metallic layers are possible problems, but information is scanty.
- Because of the high bit density, small, μm -sized defects, pinholes, and inhomogeneities cause error rates in the range 10^{-4} to 10^{-6} . Error correction codes--with about 20 percent overhead--have to be used for reliable recording.
- For high data rates, more than 20 MW of laser power on the disk is needed. High-power semiconductor lasers, however, are expensive and have limited lifetimes.

Current Research and Development

About 50 companies are currently working on magneto-optic recording--most of them in the United States or Japan. RE-TM amorphous films are the most promising candidates to be used as the storage layer in combination with semiconductor lasers.

Several important results have been reported, including data rates up to 60 Mbit/sec., 10^7 write-erase cycles without degradation, accelerated lifetime tests of overcoated layers showing stability of about 5 years, signal-to-noise ratio greater than 50 dB (30 KHz bandwidths).

Several feasibility models have been demonstrated during the past few years:

- An experimental erasable digital audio disk by Philips (Braat and Immink, 1983).
- As potential low-cost digital recorder with 10-MByte capacity on a 2-in. disk by Philips (Sander and Urner-Willie, 1983).
- A video disk for TV editing by NHK (Togami and Kobayashi, 1983).
- An erasable video disk by Sony (Sato, 1984).
- A digital recorder by Sharp (Ohta et al., 1983).

At the present time, no products have been delivered, and no commercial disks are available.

Opportunities

Although investigations in magneto-optic recording have led to promising results, research was often done empirically. The theory of magnetic and magneto-optic properties in amorphous films--such as the origin of magnetic anisotropy, highly coercive force, and relatively high magneto-optic effects--is not well understood, especially for RE-TM alloys. In addition, the alloys show high extraordinary Hall effect and highest magnetostriction effects (TbFe).

More fundamental research could improve material parameters and find new classes of magneto-optic materials. Studies on factors affecting stability need to be carried out.

MAGNETIC BUBBLE DOMAIN MATERIALS

Magnetic bubble memories are solid-state memory devices having no moving parts (see, for example Eschenfelder, 1980). They offer nonvolatile storage of information as magnetic disks do but are in the form of chips, more like semiconductor devices. They are rugged and resistant to harsh environments (wide temperature range, vibration, corrosive atmospheres, and radiation). They currently are being sold in 1-megabit and 4-megabit packages, but materials and devices being researched in laboratories indicate potential for 1-gigabit devices in the future.

One of the key reasons bubble domain technology has been successful is that garnets--the basic materials for today's bubble devices--have proven to offer a wide range of magnetic properties in epitaxially grown thin films, which may be grown with good control. These garnet films are grown defect-free in wafers up to 100 mm in diameter with preferred axis of magnetization perpendicular to the plane of the film and very low (<1 Oe) domain wall coercivity. Figure 5 shows a diagram of the magnetic domains in such a material. With no bias field applied perpendicular to

the plane of the film, the material breaks into a stripe domain pattern, with 50 percent of the magnetization upward and 50 percent downward. Application of a bias magnetic field perpendicular to the film plane causes the stripes with magnetization antiparallel to the applied field to shrink down to right circular cylindrical domains, which are referred to as bubble domains.

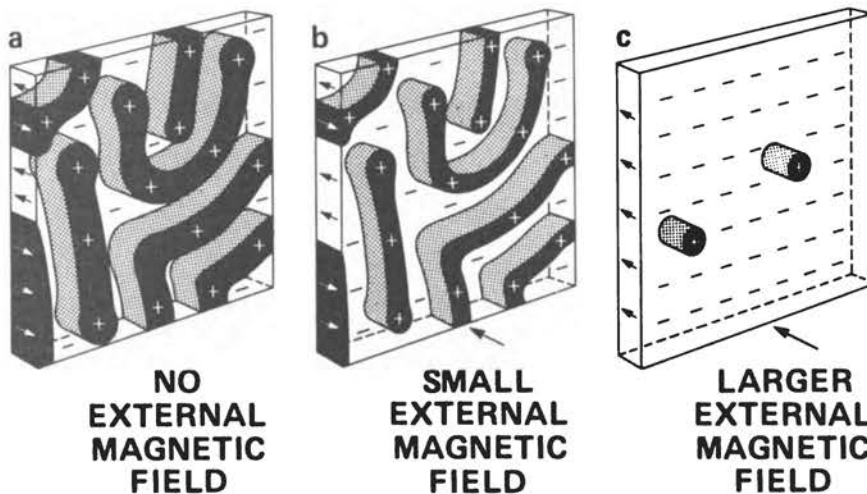

Figure 5 Illustration of magnetic bubble domains.

In bubble memory devices made today, binary information is represented by the presence "1" or absence "0" of a bubble domain. The data in the memory are manipulated by Permalloy elements deposited on the surface of the bubble material. Figure 6 shows a diagram of asymmetric chevron elements used to propagate bubble domains in today's devices. A rotating magnetic field induces magnetic poles on the elements, causing the bubble domains to propagate. Bubble generation, swap, replication, and detection are achieved on manufactured chips using similar Permalloy structures with current-accessed conductor lines. In volume production today the minimum lithographic feature w is about $1 \mu\text{m}$ and the basic bit cell is about $7 \mu\text{m} \times 9 \mu\text{m}$.

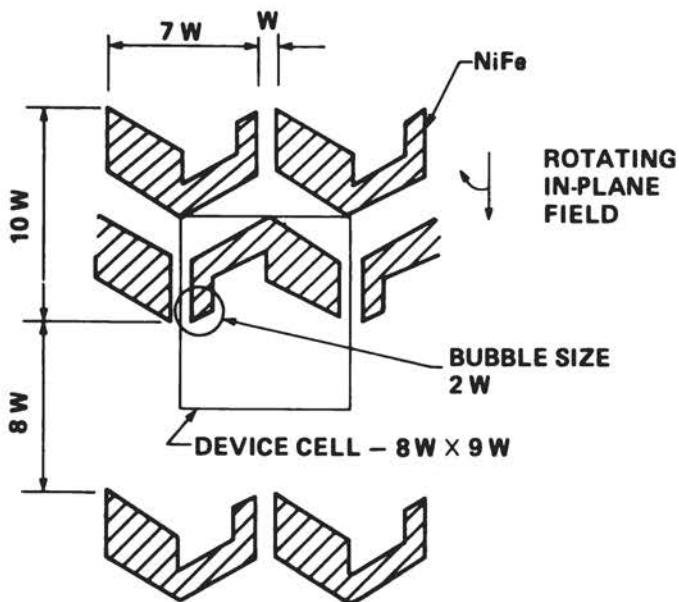

Figure 6 Bubble propagation structures showing device cell dimensions.

Bubble technology has had an exciting history since it was patented in 1967 (Bobeck, 1976). The earliest devices used bulk orthoferrite materials. The demonstration that epitaxial garnet films made by CVD and liquid phase epitaxy made possible the practical implementation of bubble memory devices as we know them today. In 1972 ion-implanted contiguous disk device structures, which are the basis for a technology with up to 16 times the bit density of presently manufactured Permalloy devices, were first reported, and in 1973 sputtered amorphous metallic thin films were shown to support bubble domains. A recent development has been the demonstration of operational current-access bubble logic devices with greater than 10 percent operating margins. Furthermore, Konishi (1983) has suggested an entirely new form of high-density memory based on bubble materials. In this memory, which he calls a Bloch line memory, information is stored in vertical Bloch lines in the domain walls of stripe domains of bubble materials. Storage densities in excess of 1 gigabit per cm^2 are possible. Although neither ion-implanted devices, amorphous bubble materials, bubble logic devices, nor Bloch line memories have yet been made into commercial products, they represent very real opportunities for improved bubble technology. They motivate many of the research opportunities in bubble materials.

Applications and Markets

Bubble technology today is used where nonvolatile storage of data is required in a harsh environment (vibration, corrosive atmosphere, extremes of temperature, radiation, etc.). One of the oldest and largest

application for bubbles has been voice reproduction (in the United States) and electronic switching (in Japan and England) in telephone network systems. Probably the largest commercial applications today are in numerical control units for computer-driven machine tools and in point-of-sale terminals. Because of their ruggedness, there are many military applications for bubbles (flight recorders, avionics, rugged nonvolatile memory for tanks, ships, etc.), and it can be expected that military application will become more significant in the future. The most active new market area for bubbles is potentially the largest one: portable computers. The Japanese have been particularly aggressive in trying to tap this market.

The bubble memory market today is estimated to be \$100 million, and it is projected to grow to over \$500 million by 1987 (Magnetic Media Information Services Report 1983-LY), with 60 percent being used in commercial and military equipment and the remainder in captive telecommunication memory devices. One of the reasons for the growth of the bubble memory market has been the decline in bubble memory prices. Figure 7 shows the prices of 1-megabit bubble memories sold by Intel. To ensure significant advances in the future, research leading to higher bit density devices must be carried out.

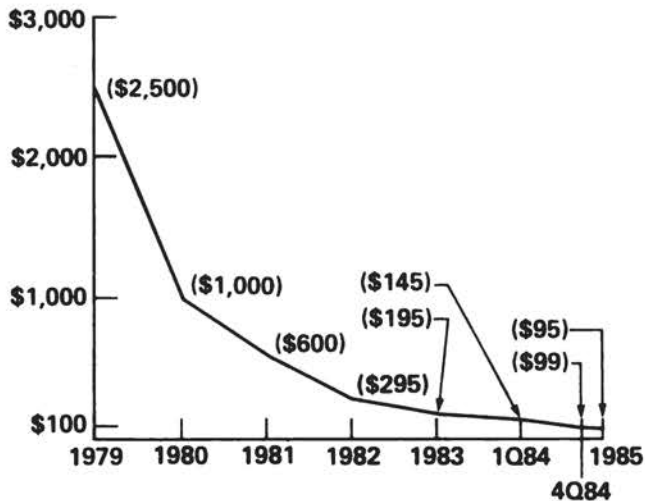

Figure 7 Prices of 1-megabit bubble memories (Source: Intel).

Technical Issues and Opportunities

There are a wide variety of technical opportunities for research in bubble materials. These include further development of garnet materials and their application in high-density ion-implant, current-access, and Bloch line memory devices and research leading to the use of amorphous or other single-crystal epitaxial materials in devices supporting submicrometer bubbles.

The problems remaining to be solved in garnet bubble materials are not predominately in demonstrating materials with smaller bubble sizes but rather in demonstrating materials with properties that provide optimum performance devices. For example, a concerted effort on the part of researchers at Bell Laboratories at developing garnets with a wide temperature range of operation has proved it possible to extend the temperature range of operation from the normal commercial specification (0° to 55°C) to a wide military specification (-54°C to $+150^{\circ}\text{C}$). Some problems still exist in growing these wide-temperature-range materials in manufacturing applications requiring micrometer and smaller bubbles, and the Air Force is continuing to support research in this area at Bell Laboratories. This effort should be continued.

However, in addition to the work on wide-temperature-range materials, work in materials that are optimized for ion-implanted contiguous-disk devices is needed. These devices offer up to 16 times the bit density of present-generation Permalloy technology, and they use stress induced by ion implantation to form device structures in the surface of the garnet. Research into the properties of the ion-implanted layer of those devices has revealed a 3-fold symmetric anisotropy, caused by anisotropic magnetostriction and magnetocrystalline anisotropy. It has been suggested that materials with isotropic magnetostriction ($\lambda_{111} = \lambda_{100}$) could be developed and that such materials would offer improved performance in ion-implanted devices.

Another opportunity for research in garnet materials is the need to develop a solid understanding of the effects of ion implantation on garnets. This knowledge is critical to the development of high-density ion-implanted devices. More work is needed to explain how and why different ion species affect the magnetic properties of garnets very differently. Whereas stress introduced by ion implantation appears to explain the planar anisotropy of neon- and oxygen-implanted films, hydrogen- or deuterium-implanted films exhibit a larger planar anisotropy for the same induced stress. For submicrometer bubbles, large changes in anisotropy must be introduced by implantation; however, too large a dose can cause damage to the films. Hydrogen and deuterium may be used to produce more strain than oxygen or neon; however, even with these lighter ions it has been found that high-dose implants produce a reduction in magnetostriction. Some of the damage introduced by high-dose implants may be annealed out, but changes in the desired planar anisotropy also frequently take place during annealing. A considerably improved understanding is required so that the annealing-induced processes can be characterized in terms of their activation energies and their effects on bubble device performance.

Current-access bubble devices could benefit from garnet materials with improved high-frequency properties. In current-access devices, as opposed to present field-access devices, more than an order of magnitude increase in data rate is possible, but bubble material properties are likely to limit their high-frequency performance. Materials offering high mobility and high saturation velocity are important; however, the materials must also be resistant to wall structure changes so that repeatable behavior is achieved in devices. Studies of the effects of

bubble dynamics on current-access device performance are needed. Based on the understanding obtained from these studies, new and improved materials offering good high-frequency characteristics could be developed.

The vertical Bloch line device proposed by Konishi (1983) will surely require considerable work on bubble domain materials. Since the domain wall structure is used to store the encoded information, studies of wall dynamics and the materials parameters that affect them are again critical. To make this highly attractive technology a reality will require the work of physicists to understand the dynamic properties of Bloch lines in bubble domain walls, the work of engineers in designing device structures to control and manipulate the Bloch lines, and the work of materials scientists to develop the optimum materials for this application. Thus both current-access bubble devices and vertical Bloch line technology will benefit from studies of bubble dynamics and the material properties that affect bubble dynamics.

Finally, although almost all bubble domain work currently being carried out is on garnet materials, other classes of materials should not be forgotten. Garnets will support bubble domains down to $0.35\ \mu\text{m}$ in diameter, but the anisotropy and magnetization available in garnets are not adequate for smaller bubble domains. Other materials such as hexaferrites and spinels offer the magnetic parameters required for smaller bubbles, but have not yet been successfully grown as defect-free epitaxial films. Research into the epitaxial growth of single crystal hexaferrites and spinels is therefore of importance.

Amorphous rare-earth transition-metal alloy films such as GdCoMo were of interest as potential bubble domain materials in the mid-1970s, but interest waned when it was shown that garnets offered less temperature-dependent magnet properties down to about $1\ \mu\text{m}$ domain size. Today, bit density of bubble domain technology has increased sufficiently that $1\ \mu\text{m}$ bubble domain sizes are of interest. Accordingly, amorphous materials are of potential interest. Amorphous films are much less expensive to manufacture than single-crystal garnets, and, in spite of their high yields, garnet wafers are still one of the most expensive portions of a bubble domain device. Furthermore, although the minimum domain size in garnets is $0.35\ \mu\text{m}$, domains as small as $0.05\ \mu\text{m}$ have been observed using electron microscopy in amorphous thin films. Hence amorphous materials offer the potential of much smaller domain size. Research on amorphous materials for bubble domain applications is thus highly desirable. This work would complement the work carried out on these materials for magneto-optic recording applications.

REFERENCES

- Braat, J., and K. A. Immink. 1983. Experiments Towards an Erasable Compact Disc Digital Audio System. AES preprint 1970 (E2), 73rd Convention.
- Bate, G. 1980. Recording Materials. Chap. 4 in Ferromagnetic Materials, Vol. 2, E. P. Wohlfarth, ed. Amsterdam: North-Holland.

- Bobeck, A. H. 1976. U.S. Patent No. 3,460,116.
- Corradi, A. R. 1978. Progress in Recording Materials: A Critical Review. IEEE Trans. Mag. MAG-14, 655-660.
- Eschenfelder, A. H. 1980. Magnetic Bubble Technology. New York: Springer-Verlag.
- Konishi, S. 1983. IEEE Trans. Mag. MAG-19, 1938.
- Ohta, K., et al. 1983. Magneto-Optical Disc With Reflecting Layer. SPIE Proceedings, Vol. 382, Topical Meeting on Optical Data Storage, Incline Village, Nevada.
- Sander, I., and M. Urner-Willie. 1983. Digital Magneto-Optical Recorder. SPIE Proceedings, Vol, 382, Topical Meeting on Optical Data Storage, Incline Village, Nevada.
- Sato, N. 1984. Magneto-Optical Recording on Tb-Fe Based Thin Films, To be published in IEEE Trans. on Magnetics.
- Togami, Y. and K. Kobayashi. 1983. Amorphous GdCo Film for Magneto-Optical Disk Storage. NKH Technical Monograph, No. 33.
- Verbatim Corporation. 1984. Business Planning Department.

Chapter 6

TRANSDUCERS

MAGNETOSTRICTION

Ferromagnetic materials in general undergo a change in dimensions when the state of magnetization is changed. This effect, called magnetostriction, is generally quite small--less than 0.01 percent strain. The effect can be used to convert a change in magnetic field to a linear displacement and has been used, for example, to generate underwater sound waves. A number of related phenomena occur, involving changes of magnetic properties and/or elastic properties with changes in magnetization or applied stress. Since about 1970, new materials have been developed in which these effects are substantially greater than in previously available materials, with resulting opportunities for new applications.

Magnetostrictive Motion Generators

The discovery that several of the rare earths have extraordinarily large values of magnetostriction (nearly 1 percent strain) reopened interest in magnetostrictive motion generators, especially at the Naval Surface Weapons Center (NSWC), where the primary interest has been in sound generators (sonar). The rare earths themselves are unsuitable, because of their very low Curie points (below room temperature) and very high anisotropies. NSWC has investigated a large number of rare-earth compounds and has developed $TbFe_2$, under the name Terfenol, as an engineering material now used in low-frequency sonar devices. Terfenol has a room-temperature magnetostrictive strain of about 0.2 percent. It is metallic and limited by eddy-current losses to operation at relatively low frequencies.

Market

Sonar devices are used almost entirely by the military, and sales figures are not easily available. We were given a figure of \$150 million for the installed value of sonar equipment in the U.S. Navy in 1979, implying annual sales today in the range of \$25 to \$50 million. Current sonar equipment is almost entirely piezoelectric, not magnetic. Magnetic

sonar is expected to be competitive only at low frequencies (below perhaps 2 kHz) and so will not take the entire sonar market. The cost of the magnetic material is, of course, only a fraction of the total cost of the sonar equipment. Sound-generating equipment is also used for oil exploration and other geophysical work; the annual sales value of this equipment may be comparable to military sales.

Technical Issues

A large number of possible new applications for magnetostrictive positioners have fairly recently been suggested, and some are beginning to be explored. Such positioners would be useful in cases where large forces are needed over small distances at relatively low frequencies (kHz). Examples are devices to produce controlled distortions of large telescope mirrors, valves to work at high pressures, cutting tool positioners for precision machining, and active vibration dampers. A magnetostrictive device with an active feedback control system could produce a mechanical member that has no deflection under load and hence infinite elastic modulus. The possible value of such applications is unknown, but is surely hundreds of millions of dollars annually. Work on such devices is beginning, primarily at the NSWC and at the precision engineering center at North Carolina State University. DARPA is funding an advanced robotics effort at NSWC and Johns Hopkins University.

Opportunities

Many materials problems remain, including hysteresis in the strain behavior, crystallographic orientation, efficiency (field required for given strain), brittleness, and, of course, cost. New compounds with large magnetostrictive strains are certainly possible and would allow new applications or smaller devices.

The United States leads the world in this area, almost entirely because of the NSWC. This advantage should not be lost.

Magnetostrictive Sensors

Most suggested magnetostrictive sensors rely on the properties of amorphous alloys, which can combine relatively high values of magnetostriction with very high permeability. This makes the permeability sensitive to applied stress. The apparent elastic modulus can also be sensitive to applied stress or to magnetic fields (the "delta E effect"). Amorphous ribbons can be efficient carriers of magnetoelastic waves, a property that can be exploited to produce length or position sensors. Magnetostrictive sensors have the advantage of small physical size and large electrical output. In their simplest form they require that a stressed amorphous ribbon be inside a drive coil, which may be inconvenient in practice.

Market

A number of sensor arrangements have been proposed in the literature, and some devices are manufactured in Japan, where applications for

amorphous alloys have been strongly encouraged. The committee was told of a noncontact torque sensor for large rotating machinery under development in the United States, with a potential market of \$10 to \$15 million per year. Use of such sensors on a very large scale seems possible, for example, in the automobile industry.

Technical Issues

The materials problems facing this application are largely the common problems of amorphous alloys: brittleness, corrosion, and long-term stability against temperature and stress variations. A special problem is the need to have linear response to stress over a wide dynamic range; this may be limited by inhomogeneities in the anisotropy of as-prepared alloys.

Opportunities

Magnetostrictive positioners and sensors represent a substantial opportunity for innovation in manufacturing technology. At present the development of these devices is limited by material properties as well as by lack of familiarity in the engineering community. Magnetostrictive positioners may become increasingly useful as very-small-scale devices increase in importance. Development work on magnetostrictive sensors can proceed in parallel with other work on amorphous alloys. Development of positioner materials is more specialized. The United States has a very strong position in this field because of the work of the NSWC; this advantage should not be permitted to evaporate. There are relatively short-term needs for improving existing materials and potential long-term benefits from the discovery of new materials and from the advancement of the theory of magnetoelastic phenomena.

MAGNETORESISTANCE

Magnetoresistance is the increase in the resistance of a metal or semiconductor when placed in a magnetic field. In the "standard" geometry, the field is transverse to the current and $\Delta\rho/\rho \sim H^2$. In a magnetic material, this magnetoresistance is anisotropic, depending upon the direction of M . The origin of this anisotropy lies in spin-dependent scattering.

Applications and Markets

Although various galvanomagnetic phenomena, particularly the Hall and magnetoresistance (MR) effects, have been known for many years, they have found practical application only in specialized instrumentation. Galvanomagnetic effects are generally quite small in metals because of their high carrier densities and low carrier mobilities. However, the ferromagnetic metals possess a large, spontaneous internal magnetization, which in the highly permeable alloys can be controlled by an external field 3 or 4 orders of magnitude smaller than the internal field. In addition, the electron mean free path in these materials is very short,

about 200 Å, so that very thin films can be efficiently utilized. It should not be surprising, therefore, that there is a class of applications where metallic ferromagnetic thin films play a key role as transducers in advanced memory and storage technologies, specifically as sensors on bubble domain memory chips and in magnetic recording read heads. They are challenged by semiconductors but appear to have advantages that are expected to ensure their ultimate viability.

Technical Issues

MR transducers measure a spatial integral of B itself. However, in all magnetic film materials useful for this purpose, B and M are identical to within experimental error, because of the high relative permeability--typically in the thousands. To understand the galvanomagnetic behavior of the devices it is necessary to understand the magnetic state of the device, which is most conveniently described in terms of the dependence of M on the applied field H.

It is possible to produce films with isotropic properties, but we have no control of their domain structure in the quiescent state. For this reason the more sensitive devices utilize uniaxial films such as Permalloy. The anisotropic magnetoresistance ratio in Permalloy films can be from 2 to 3 percent at room temperature. It is possible to reach this percentage change $\Delta R/R$ in fields of 10 gauss, giving for the ratio of the signal power to the input power

$$\frac{P_s}{P_i} = \frac{1}{4} \left(\frac{\Delta R}{R} \right)^2 = 100 \times 10^{-6}$$

This is a value 300 times that found in InSb.

Galvanomagnetic sensors are all electrically equivalent to resistors or resistive bridge networks whose elements vary with an applied magnetic field. There is no flow of energy from the magnetic field source into the electrical detector, so there is no simple limit to the output of such a device, as there is for inductive or electromechanical transducers. The signal of a galvanomagnetic sensor increases as the electrical current or voltage excitation is increased until one reaches a limit on temperature rise, current density, or total power dissipation.

The magnetoresistive recording head has several major advantages over inductive recording heads. Its output is independent of speed, its basic structure is very simple, and the signal power available is greater than that from inductive heads of comparable complexity at all practical speeds. There are some drawbacks as well, however. The foremost is a dependence of the thin film resistance on temperature and strain as well as magnetic field. This leads to the appearance of thermally induced transient signals whenever there is contact between the head and the

recording medium. Furthermore, small MR sensors, desirable for high-data-density applications, often exhibit noisy responses. This so-called Barkhausen noise originates from domain activities and must be suppressed if the sensor is to be viable. Finally, since the basic MR characteristic is nonlinear, provisions (transverse biasing) must be provided to obtain a certain level of linearity in signal responses. This is especially important for analog recording systems.

Opportunities

Obviously, a very large magnetoresistive effect would be desirable. In order to design a material with a large MR coefficient, the effect must be better understood on a microscopic level.

The biasing required of a MR sensor also offers a variety of materials challenges. There are a number of biasing techniques. All are concerned with the generation of a sufficiently strong transverse field, complicated by the fact that the MR sensor is usually sandwiched in a narrow gap between two soft-magnetic shields and that the lower edge of the MR, which is most important in signal detection, is also the hardest region to be biased properly because of geometrical constraints and local magnetization effects.

The soft-film biasing scheme may be regarded as a shunt biasing of the MR sensor in a flux-closure environment: A soft-magnetic film is placed adjacent to the MR layer and a bias current is applied along one or both of the layers. The opposite magnetization rotations of the two films cancel the shape demagnetization effects. As a result, strong biasing is produced, limited primarily by the permeabilities of the magnetic film materials. An important issue in soft-film biasing is the selection of a desirable soft-film material. It must exhibit reasonable permeabilities (≥ 500) to ensure adequate biasing with modest bias currents. In addition, high resistivity is desirable to minimize electrical shunting of the signal should the spacer layer between the MR layer and the soft-film layer be electrically conducting, and a low magnetoresistive coefficient compared with that for the MR layer is needed to avoid cancellation of biasing and signal responses.

A hard magnetic film may also be used to bias a shielded MR sensor. A basic issue in this biasing scheme is the choice of a good hard-magnet material. Most candidates studied in the past either exhibit low coercivity (e.g., oxidized NiFe) or severe degradation effect on the softness of the MR layer (e.g., NiFe film exchanged coupled to $\alpha\text{-Fe}_2\text{O}_3$). In the latter case, to avoid unstable and noisy operation, a thick spacer layer ($\approx 1100 \text{ \AA}$) between the hard magnet and the MR layer is often necessary. In such cases, the resultant biasing may be reduced because of bias flux captured by the shields. Furthermore, inclusion of the MR sensor structure in a narrow gap between the shields then becomes more difficult. With a suitable candidate for the permanent magnet, however, this scheme should exhibit superior performance compared with other uniform bias-field techniques.

Chapter 7

FINE PARTICLES FOR USES OTHER THAN RECORDING

ELECTROPHOTOGRAPHY

A large dollar volume of magnetic material is used annually copying. The toner particles that act as the "ink" in dry copy processes are most commonly picked up and distributed in the copy machine by magnetic powders, which themselves are transported by magnetic fields. In these two-component toner systems, the actual toner particles are usually about 10 μm in diameter and are a mixture of carbon black and a heat-sensitive polymer or resin. The toner particles are held electrostatically on the magnetic particles and then removed electrostatically for the printing operation. The magnetic particles are not consumed in the printing process (except incidentally); the electrostatic properties, however, in some cases depend on surface coatings and degrade with use. This requires periodic replacement of the magnetic particles, which may be recoated and reused.

Various materials in various sizes are used for the magnetic particles, but typically they are iron or nickel powder (sometimes ferrite) somewhere near 100 μm in diameter. Major suppliers are Hoganaes, Nuclear Metals, and Quebec Metals (iron); Sherritt-Gordon (nickel); and Indiana General (ferrite). The particle diameters must be held within a narrow range for proper operation, and surface condition is important. As noted above, metal powders may be oxidized or coated to control their electrostatic properties.

A relatively small fraction of copiers (less than 10 percent, mostly small Japanese machines) use monocomponent toner, in which small magnetic particles are embedded in toners particles about 25 μm in diameter. The magnetic particles are usually magnetite and may amount to half the total weight of the toner. In this case the magnetic particles are incorporated into the copied image so that the magnetic powder is consumed as copies are made.

Market

An estimate from the powder metallurgy industry (Metals Handbook, Vol. 7, 1984, Amer. Soc. for Metals) gives the 1983 U.S. production of all magnetic powder at 13,000 metric tons, of which roughly 75 percent is metallic iron and 25 percent is iron oxide. Taking an average price of \$2.60/kg, the dollar value is about \$34 million. An estimate from Nashua Corporation, a major supplier of toners and carriers, puts the current annual U.S. sales value of magnetic carrier powders at \$150 million. This is the final cost to the consumer. The difference between the \$34 million and \$150 million figures lies in the costs of coating, packaging, and shipping the particles, plus markup. A factor of 5 for two-component system magnetic powder is about right; the factor is higher for monocomponent powder.

U.S. consumption of copier supplies is about half the world consumption and is growing at about 15 percent per year.

Various alternate copying technologies have been and continue to be proposed. Electrostatic copying can be done without magnetic particles, and there are other copying systems that make no use of magnetic materials. On the other hand, magnetic printers, using magnetic rather than electrostatic forces to create the image, have been built and could take a substantial part of the copier market, with a resulting increase in consumption of magnetic particles.

Technical Issues

The available magnetic powders appear to be adequate for use in electrostatic copiers, and current development work is aimed at improved uniformity, better durability, improved electrostatic coatings, lower costs, etc., rather than at major changes in magnetic properties. Relatively little of this work is published, and the publications that do appear are not mainly in the usual magnetics literature.

Color copiers are a major challenge. If they are electrostatic and use single-component magnetic toner, the magnetic particle content must be small to keep colors clean.

Opportunities

It appears that no major research effort is required specifically in the magnetic behavior of copier materials. Market requirements should be more than adequate to drive the necessary development work.

FERROFLUIDS

Ferrofluids are liquids (water or oil) carrying a relatively dense permanent suspension of magnetic particles. The particles are usually oxides but can in principle be metals. They must be of the order of 100 Å in size to remain suspended in the liquid; furthermore, some form of stabilizing layer must be added to their surface to prevent

agglomeration. Particles are made by chemical precipitation or by prolonged mechanical grinding. They are made principally by a single U.S.-based company, Ferrofluidics Inc., founded in 1968. Ferrofluids are used in a variety of applications, mostly where it is advantageous to hold liquid in a confined space (with magnetic fields). Gas-tight bearings and seals are a major use; other uses include motion damping, heat transfer, position sensing, and visualization of recorded patterns on tapes and disks. It is characteristic of most of these uses that very small quantities of ferrofluids are required, although the operation of the entire device depends on the properties of the ferrofluid. Typically the working device also uses permanent magnets.

The only potential large-volume use of ferrofluids of which we are aware is for separation processes (ores, various waste products, etc.). These make use of the fact that the apparent density of the fluid depends on an applied field gradient and can be quite high. A solid of given density can either sink or float, depending on the applied field, and hence the common name of "sink-float" process. A related use adds a ferrofluid to the oil in an oil spill so that it can be collected magnetically. These uses will require ferrofluids that are much cheaper than those currently produced. Ferrofluidics Inc. is not developing such materials, but other companies may be doing so; the Bureau of Mines has also worked in this field. Recent publications in this area are largely from the Soviet Union and Eastern Europe.

Market

The last reported annual net sales figure for Ferrofluidics are \$7 million in 1982 and \$10.8 million in 1983, indicating fairly rapid growth. Only a small fraction of the total sales is for actual ferrofluid; most of the value is in the equipment using the fluid.

Technical Issues

An engineering staff member of Ferrofluidics reports that there are no serious limitations on the current uses of ferrofluids that are imposed by the magnetic properties of the materials. Apparent magnetizations up to 1500 G are available. A significant amount of research on ferrofluids has been published, originating in several countries, and there have been three international conferences on ferrofluids. The application of these materials is growing briskly, so that the marketplace seems to be responding to the opportunities.

There are many possible uses of ferrofluids not yet put into practice; some of these would benefit from improved ferrofluids. For example, ferrofluids with improved heat transfer characteristics would allow some applications where cooling is important. Possibly more important would be the production of very simple low-temperature heat engines based on a version of the Curie wheel. These applications could require relatively large volumes of ferrofluid. Liquid-metal ferrofluids would be best, but so far no way of stabilizing the magnetic particles in liquid metals has been found.

Ferrofluids with much higher magnetizations would be useful for many purposes; their development probably requires means of stabilizing metallic particles in appropriate liquids at high concentrations. This is another example of the need for understanding surface phenomena in magnetic materials.

Opportunities

There are opportunities in this field for important fundamental work on the behavior of small magnetic particles and on surface phenomena in magnetic materials. More directed research on ferrofluids and their applications is appropriate for a variety of reasons: to spread knowledge of the materials and their uses, to explore novel applications, and to keep the subject from being too confined by short-range development pressures.

APPENDIX

Resumes of Committee Members

R. M. White received his B.S. in physics from Massachusetts Institute of Technology in 1960, and a Ph.D. from Stanford. After a year at the University of California at Berkeley, he returned to Stanford as Assistant Professor of Physics. Dr. White spent 1970 as an NSF Senior Postdoctoral Fellow at the Cavendish Laboratory and joined Xerox PARC in 1971, where he has been Manager of solid state research and Manager of storage technology. While at PARC, he was also a Consulting Professor in Applied Physics at Stanford. He is currently Vice-President of Engineering and Technology at Control Data Corporation. Dr. White's research has focused on the theory of magnetic phenomena, in particular, the optical properties of magnetic materials and the magnetic properties of amorphous materials.

Geoffrey Bate received B.Sc. (Honors Physics) and Ph.D. in physics from the University of Sheffield, England. After serving in the Royal Naval Scientific Service, he became Research Associate and later, Assistant Professor in the Physics Department of the University of British Columbia. He worked for IBM as Manager of Recording Physics and joined Verbatim Corporation where he is presently Senior Vice-President of Engineering. His interests include all forms of digital recording, natural and man-made.

Gilbert Y. Chin received S.B. and Sc.D. degrees in metallurgy from Massachusetts Institute of Technology. After graduating, he joined AT&T Bell Laboratories where he is currently Director of the Materials Research Laboratory. His research interests include magnetic alloys and crystal plasticity.

Theodore H. Geballe is the Rosenberg Professor of Applied Physics at Stanford University and the Director of its Center for Materials Research. He received his Ph.D. in chemistry at the University of California in 1950, working in the low temperature laboratory of Professor W. F. Giaouque. He then joined the Bell Laboratories, Murray Hill, New Jersey, where he was the head of the Low Temperature Physics Department. After being appointed to the Stanford Faculty in 1968, he remained a member of staff (part time) at Bell Labs. until 1984 when he joined the newly formed Bell Communications Research Laboratories.

C. D. Graham, Jr. received the B. Met. E. degree from Cornell University, and the Ph.D. in physical metallurgy from the University of Birmingham (UK). He was employed for 15 years at the General Electric Company Research and the Development Center, and since 1969 has been Professor of Materials Science and Engineering at the University of Pennsylvania. His research interests include structure-property relationships in hard and soft magnetic materials, magnetic anisotropy, magnetic domain phenomena, and magnetic measurement techniques.

Fred E. Luborsky received the B.S. degree in chemistry from the University of Pennsylvania, and the Ph.D. degree in physical chemistry from the Illinois Institute of Technology. In 1977 he received a British Science Research Council Fellowship to study in England. He joined the General Electric Company and worked in its Instrument Department. He is currently with its Research and Development Center. His main fields of interest have been in the magnetic, metallurgical, and electrochemical aspects of soft materials, hard materials, and thin films. He has been the key technology leader in developing General Electric's Lodex^R permanent magnets, plated magnetic disks, plated wire memory and amorphous alloys. He is currently working on magneto-optic recording.

Russel G. West received the B.S.E.E. degree from the University of Maryland and did graduate work at Arizona State University. He has been employed by the U.S. Bureau of Mined, Eastern Experimental Station, and Motorola, Inc., Arizona Research and Development Laboratories. He is currently Vice President, Senior Staff Engineer at Trans-Tech, Inc. During his career, he has authored or co-authored over 25 technical papers and received two U.S. patents. His research interests have been directed toward study of ferrimagnetic oxides and dielectric material for application in microwave electronic devices.

Karl J. Strnat received Diplomingenieur and Dr. Tech. (D.Sc.) degrees from the Technische Hochschule in Vienna, Austria. Upon graduation he did research at the University for four years. After coming to the United States he worked for the U.S. Air Force Materials Laboratory at Wright-Patterson Air Force Base for ten years as a physicist and later on as Section Chief. Since 1968, he has been Tait Professor of Electrical and Materials Engineering and Director of the Magnetics Laboratory at the University of Dayton. He also owns and manages KJS Associates, a consultant and instrumentation firm.